

## CJ6205 Series

### ■ INTRODUCTION

The CJ6205 series are a group of positive voltage regulators manufactured by CMOS technologies with high ripple rejection, ultra low noise, low power consumption and low dropout voltage, which can prolong battery life in portable electronics. The CJ6205 series work with low-ESR ceramic capacitors, reducing the amount of board space necessary for power applications. The CJ6205 series consume less than 0.1uA in shutdown mode and have fast turn-on time less than 50us. The series are very suitable for the battery-powered equipments, such as RF applications and other systems requiring a quiet voltage source.

### ■ APPLICATIONS

- Cellular and Smart Phones
- Laptop, Palmtops and PDA
- Digital Still and Video Cameras

### ■ FEATURES

- Low Output Noise: 40 $\mu$ V<sub>RMS</sub> (10Hz~100kHz)
- Low Dropout Voltage: 150mV@150mA
- Low Quiescent Current: 50 $\mu$ A
- High Ripple Rejection: 75dB@1kHz
- Excellent Line and Load Transient Response
- Operating Voltage: 2.0V~6.0V
- Output Voltage: 1.2 ~ 5.0V
- High Accuracy:  $\pm 2\%$  (Typ.)
- Built-in Current Limiter, Short-Circuit Protection
- TTL- Logic-Controlled Shutdown Input

### ■ BLOCK DIAGRAM

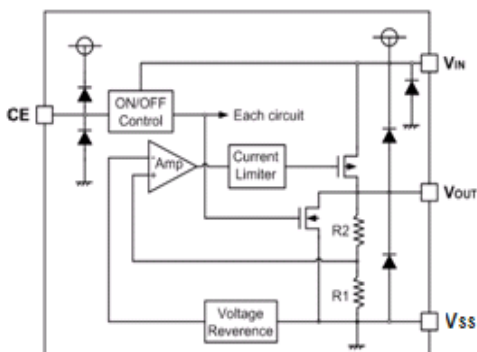

### ■ ORDER INFORMATION

CJ6205①②③④

DESIGNATOR	SYMBOL	DESCRIPTION
①	A	Standard
	B	High Active, pull-down resistor built in, with C <sub>OUT</sub> discharge resistor
	C	High Active, No pull-down resistor, No C <sub>OUT</sub> discharge resistor
②③	Integer	Output Voltage e.g. 1.8V=②:1, ③:8
④	M	Package:SOT-23-3L/5L
	U	Package:SOT-353
	P	Package:SOT-89-3L/5L
	F	Package:WFBP-04C/DFNWB1x1-4

# Pin Configuration

(Top view)

SOT-23-3L

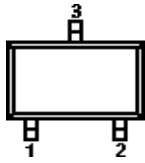

SOT-23-5L/SOT-353

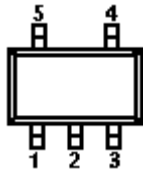

DFNWB1x1-4 WBFBP-04C

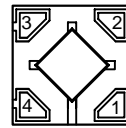
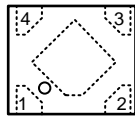

SOT-89-3L

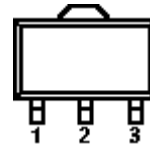

SOT-89-5L

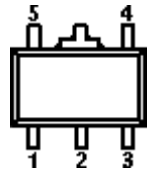

PIN NUMBER		PIN NAME	FUNCTION
SOT-23-3L	SOT-89-3L		
M	P		
1	1	$V_{SS}$	Ground
2	3	$V_{OUT}$	Output
3	2	$V_{IN}$	Power input

PIN NUMBER		SYMBOL	FUNCTION
SOT-23-5L/SOT-353	SOT-89-5L		
1	5	$V_{IN}$	Power Input Pin
2	2	$V_{SS}$	Ground
3	4	CE	Chip Enable Pin
4	3	NC	No Connection
5	1	$V_{OUT}$	Output Pin

DFNWB1x1-4/WBFBP-04C

PIN NUMBER	SYMBOL	FUNCTION
F		
1	$V_{OUT}$	Output Pin
2	$V_{SS}$	Ground
3	CE	Chip Enable Pin
4	$V_{IN}$	Power Input Pin

## ■ TYPICAL APPLICATION

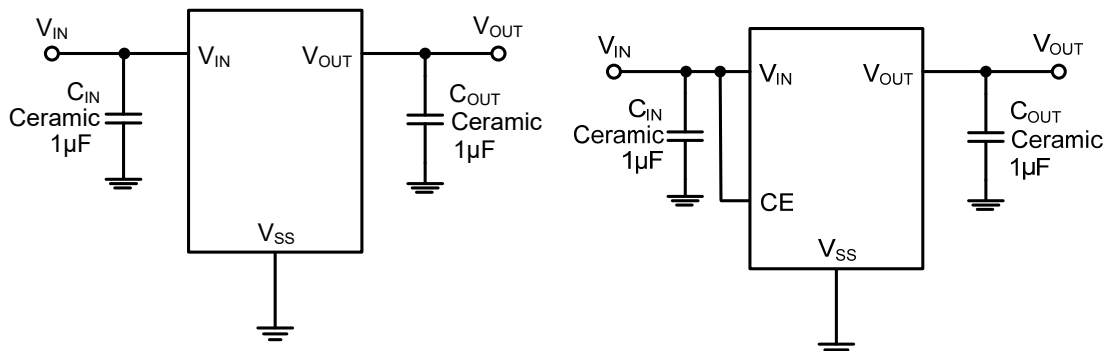

## Electrical Characteristics

### ■ ABSOLUTE MAXIMUM RATINGS

(Unless otherwise specified, Ta=25°C)

PARAMETER		SYMBOL	RATINGS	UNITS
Input Voltage		$V_{IN}$	$V_{SS} - 0.3 \sim V_{SS} + 7$	V
Output Current		$I_{OUT}$	600	mA
Output Voltage		$V_{OUT}$	$V_{SS} - 0.3 \sim V_{IN} + 0.3$	V
Power Dissipation	SOT-353	Pd	0.3	W
	SOT-23-3L/SOT-23-5L		0.4	W
	DFNWB1×1-4/WBFBP-4C		0.3	W
	SOT-89-3L/SOT-89-5L		0.6	W
Operating Temperature		$T_{opr}$	-40~+85	°C
Storage Temperature		$T_{stg}$	-40~+125	°C
Soldering Temperature & Time		$T_{solder}$	260°C, 10s	

### ■ ELECTRICAL CHARACTERISTICS

CJ6205 Series

( $V_{IN} = V_{OUT} + 1V$ ,  $C_{IN} = C_{OUT} = 1\mu F$ ,  $T_a = 25^\circ C$ , unless otherwise specified)

PARAMETER	SYMBOL	CONDITIONS	MIN.	TYP.	MAX.	UNITS
Output Voltage	$V_{OUT(E)}$ (Note 2)	$I_{OUT} = 1mA$	$V_{OUT} * 0.98$	$V_{OUT}$	$V_{OUT} * 1.02$	V
Supply Current	$I_{SS}$	$I_{OUT} = 0$		50	100	μA
Standby Current	$I_{STBY}$	$CE = V_{SS}$			0.1	μA
Output Current	$I_{OUT}$	—	500			mA
Dropout Voltage (Note 3)	$V_{dif}$	$I_{OUT} = 150mA$ $V_{OUT} \geq 2.8V$		150		mV
Load Regulation	$\Delta V_{OUT}$	$V_{IN} = V_{OUT} + 1V$ , $1mA \leq I_{OUT} \leq 100mA$		10		mV
Line Regulation	$\frac{\Delta V_{OUT}}{V_{OUT} \times \Delta V_{IN}}$	$I_{OUT} = 10mA$ $V_{OUT} + 1V \leq V_{IN} \leq 6V$		0.01	0.2	%/V
Output Voltage Temperature Characteristics	$\frac{\Delta V_{OUT}}{\Delta T \times V_{OUT}}$	$I_{OUT} = 10mA$ $-40 \leq T \leq +85$		100		ppm
Short Current	$I_{Short}$	$V_{OUT} = V_{SS}$		100		mA
Input Voltage	$V_{IN}$	—	2.0		6.0	V
Power Supply Rejection Rate	217Hz	PSRR	$I_{OUT} = 50mA$	80		dB
	1kHz			75		
	10kHz			70		
CE "High" Voltage	$V_{CE"H"}$		1.5		$V_{IN}$	V
CE "Low" Voltage	$V_{CE"L"}$				0.3	V

#### NOTE:

- $V_{OUT}$ : Specified Output Voltage.
- $V_{OUT(E)}$ : Effective Output Voltage ( i.e. The Output Voltage When  $V_{IN} = (V_{OUT} + 1.0V)$  And Maintain A Certain  $I_{OUT}$  Value).
- $V_{dif}$ : The Difference Of Output Voltage And Input Voltage When Input Voltage Is Decreased Gradually Till Output Voltage Equals To 98% Of  $V_{OUT(E)}$ .

# Typical Characteristics

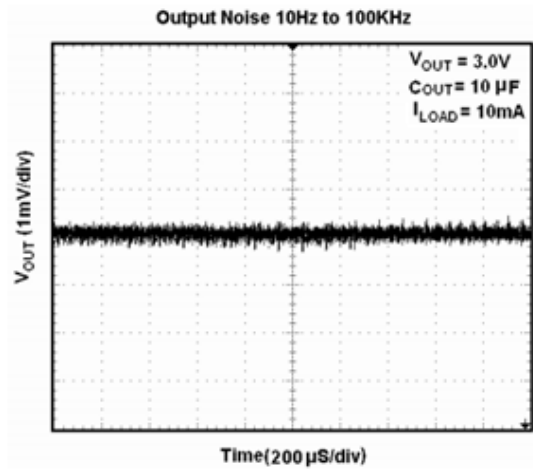
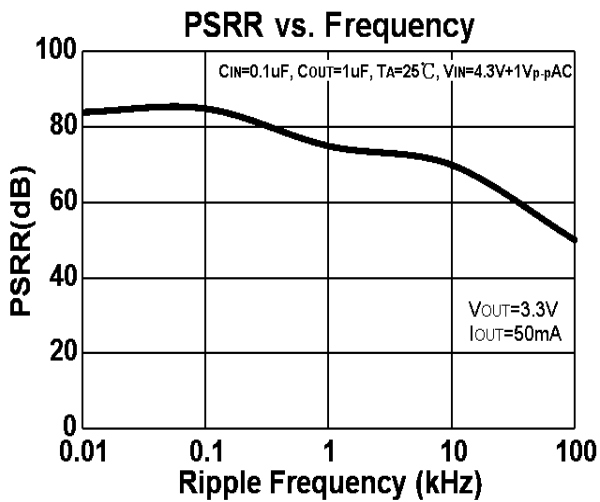
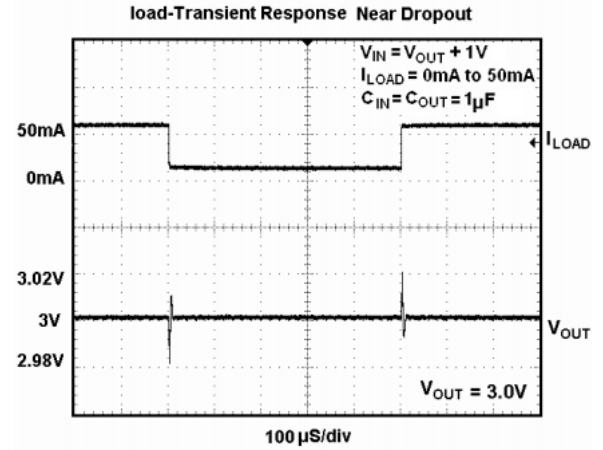
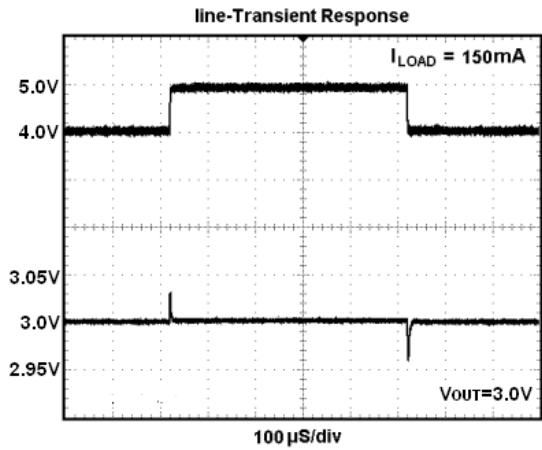
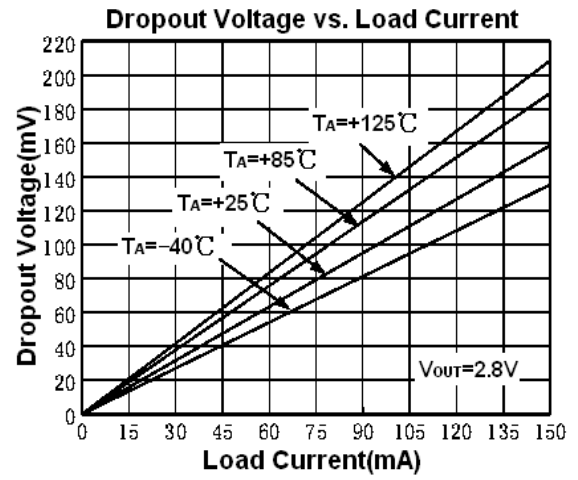
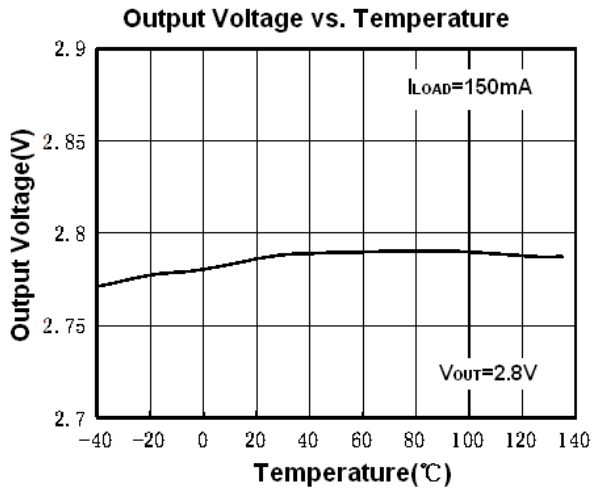

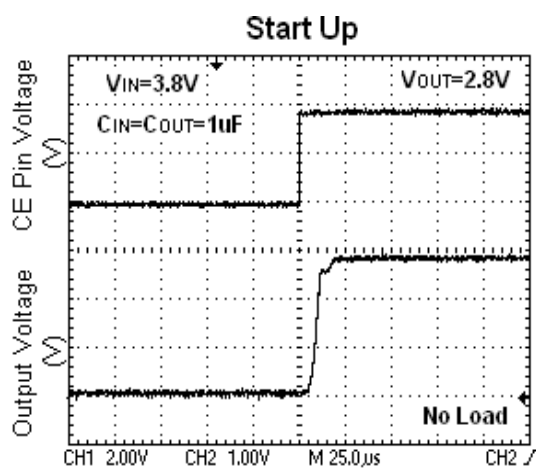
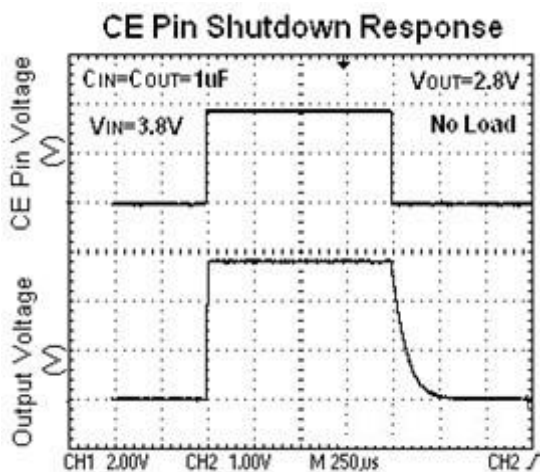

## SOT-23-3L Package Outline Dimensions

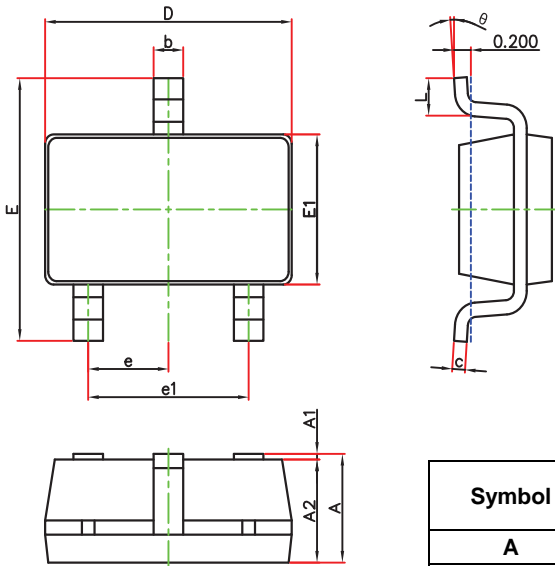

Symbol	Dimensions In Millimeters		Dimensions In Inches	
	Min.	Max.	Min.	Max.
A	1.050	1.250	0.041	0.049
A1	0.000	0.100	0.000	0.004
A2	1.050	1.150	0.041	0.045
b	0.300	0.500	0.012	0.020
c	0.100	0.200	0.004	0.008
D	2.820	3.020	0.111	0.119
E	2.650	2.950	0.104	0.116
E1	1.500	1.700	0.059	0.067
e	0.950(BSC)		0.037(BSC)	
e1	1.800	2.000	0.071	0.079
L	0.300	0.600	0.012	0.024
θ	0°	8°	0°	8°

## SOT-23-3L Suggested Pad Layout

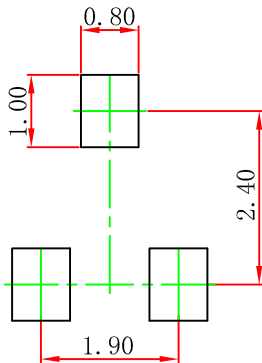

- Note:
1. Controlling dimension: in millimeters.
  2. General tolerance:  $\pm 0.05\text{mm}$ .
  3. The pad layout is for reference purposes only.

## SOT-23-5L Package Outline Dimensions

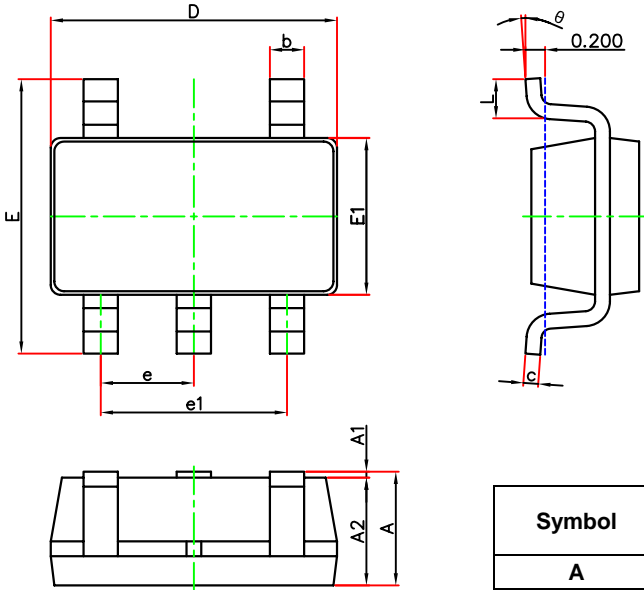

Symbol	Dimensions In Millimeters		Dimensions In Inches	
	Min.	Max.	Min.	Max.
A	1.050	1.250	0.041	0.049
A1	0.000	0.100	0.000	0.004
A2	1.050	1.150	0.041	0.045
b	0.300	0.500	0.012	0.020
c	0.100	0.200	0.004	0.008
D	2.820	3.020	0.111	0.119
E	2.650	2.950	0.104	0.116
E1	1.500	1.700	0.059	0.067
e	0.950(BSC)		0.037(BSC)	
e1	1.800	2.000	0.071	0.079
L	0.300	0.600	0.012	0.024
θ	0°	8°	0°	8°

## SOT-23-5L Suggested Pad Layout

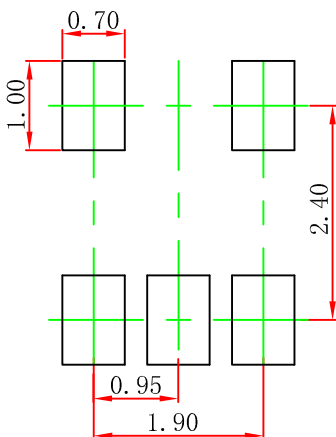

Note:

1. Controlling dimension: in millimeters.
2. General tolerance:  $\pm 0.05\text{mm}$ .
3. The pad layout is for reference purposes only.

## SOT-353 Package Outline Dimensions

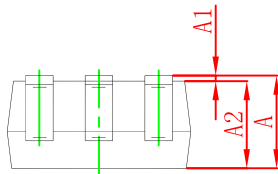
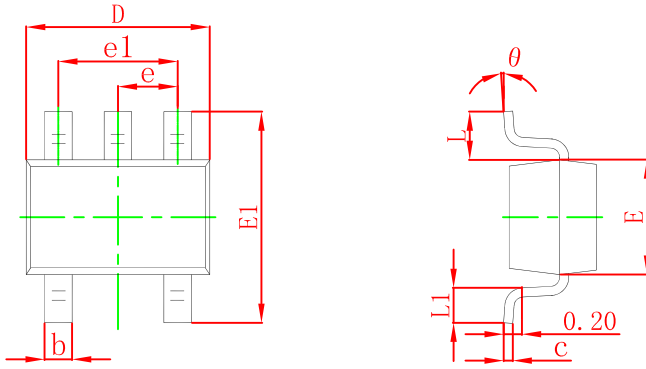

Symbol	Dimensions In Millimeters		Dimensions In Inches	
	Min.	Max.	Min.	Max.
A	0.800	1.100	0.031	0.044
A1	0.000	0.100	0.000	0.004
A2	0.800	1.100	0.031	0.044
b	0.150	0.400	0.006	0.016
c	0.080	0.150	0.003	0.006
D	2.000	2.200	0.079	0.087
E	1.150	1.350	0.045	0.054
E1	2.150	2.450	0.085	0.096
e	0.650(TYP)		0.026(TYP)	
e1	1.200	1.400	0.047	0.055
L	0.525(REF)		0.021(REF)	
L1	0.260	0.460	0.010	0.018
θ	0°	8°	0°	8°

## SOT-353 Suggested Pad Layout

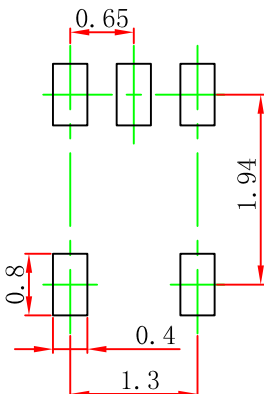

Note:

1. Controlling dimension: in millimeters.
2. General tolerance:  $\pm 0.05$  mm.
3. The pad layout is for reference purposes only.



## SOT-89-3L Package Outline Dimensions

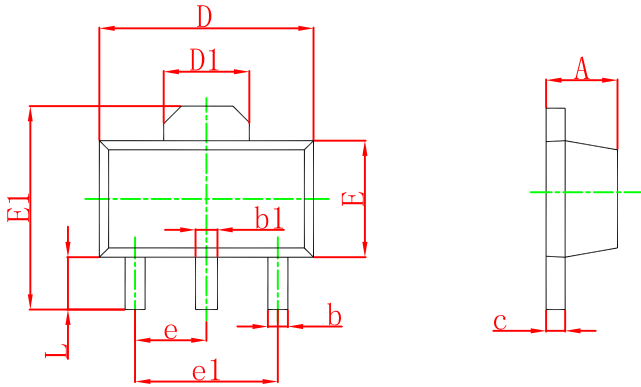

Symbol	Dimensions In Millimeters		Dimensions In Inches	
	Min.	Max.	Min.	Max.
A	1.400	1.600	0.055	0.063
b	0.320	0.520	0.013	0.197
b1	0.400	0.580	0.016	0.023
c	0.350	0.440	0.014	0.017
D	4.400	4.600	0.173	0.181
D1	1.550 REF		0.061 REF	
E	2.300	2.600	0.091	0.102
E1	3.940	4.250	0.155	0.167
e	1.500 TYP		0.060 TYP	
e1	3.000 TYP		0.118 TYP	
L	0.900	1.200	0.035	0.047

## SOT-89-3L Suggested Pad Layout

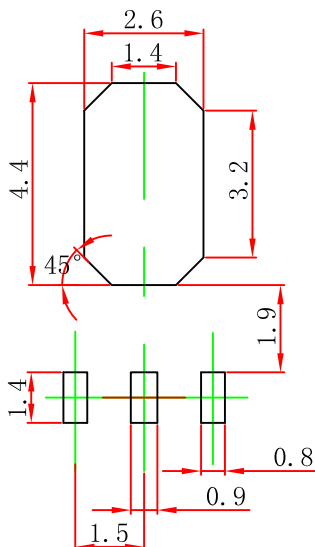

- Note:
1. Controlling dimension: in millimeters.
  2. General tolerance:  $\pm 0.05$  mm.
  3. The pad layout is for reference purposes only.

## WBFBP-04C Package Outline Dimensions

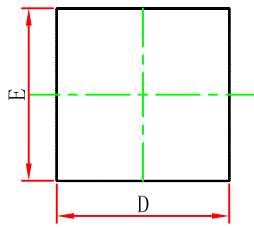

TOP VIEW

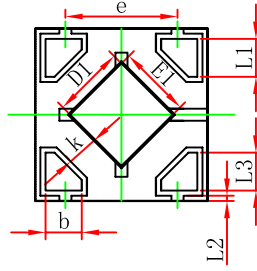

BOTTOM VIEW

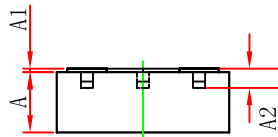

SIDE VIEW

Symbol	Dimensions In Millimeters		Dimensions In Inches	
	Min.	Max.	Min.	Max.
<b>A</b>	<b>0.335</b>	<b>0.405</b>	<b>0.013</b>	<b>0.016</b>
<b>D</b>	<b>0.950</b>	<b>1.050</b>	<b>0.037</b>	<b>0.041</b>
<b>E</b>	<b>0.950</b>	<b>1.050</b>	<b>0.037</b>	<b>0.041</b>
<b>D1</b>	<b>0.370</b>	<b>0.470</b>	<b>0.015</b>	<b>0.019</b>
<b>E1</b>	<b>0.370</b>	<b>0.470</b>	<b>0.015</b>	<b>0.019</b>
<b>k</b>	<b>0.17MIN.</b>		<b>0.007MIN.</b>	
<b>b</b>	<b>0.160</b>	<b>0.260</b>	<b>0.006</b>	<b>0.010</b>
<b>c</b>	<b>0.010</b>	<b>0.090</b>	<b>0.000</b>	<b>0.004</b>
<b>e</b>	<b>0.600</b>	<b>0.700</b>	<b>0.024</b>	<b>0.028</b>
<b>L1</b>	<b>0.185</b>	<b>0.255</b>	<b>0.007</b>	<b>0.010</b>
<b>L2</b>	<b>0.030 REF.</b>		<b>0.001 REF.</b>	
<b>L3</b>	<b>0.185</b>	<b>0.255</b>	<b>0.007</b>	<b>0.010</b>

## WBFBP-04C Suggested Pad Layout

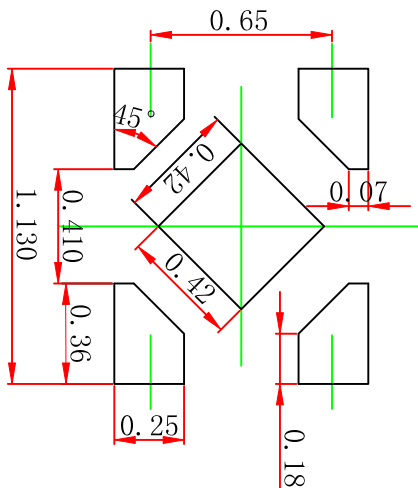

Note:

1. Controlling dimension: in millimeters.
2. General tolerance:  $\pm 0.05\text{mm}$ .
3. The pad layout is for reference purposes only.

## DFNWB1\*1-4L Package Outline Dimensions

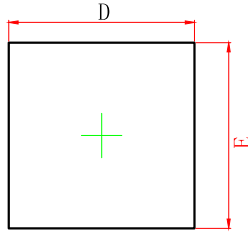

TOP VIEW

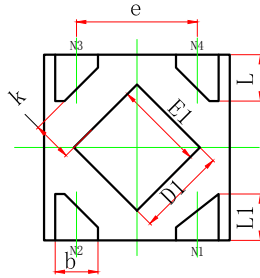

BOTTOM VIEW

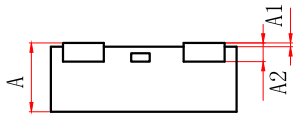

SIDE VIEW

Symbol	Dimensions In Millimeters		Dimensions In Inches	
	Min.	Max.	Min.	Max.
<b>A</b>	<b>0.320</b>	<b>0.400</b>	<b>0.013</b>	<b>0.016</b>
<b>A1</b>	<b>0.000</b>	<b>0.050</b>	<b>0.000</b>	<b>0.002</b>
<b>A2</b>	<b>0.100 REF.</b>		<b>0.004 REF.</b>	
<b>D</b>	<b>0.950</b>	<b>1.050</b>	<b>0.037</b>	<b>0.041</b>
<b>E</b>	<b>0.950</b>	<b>1.050</b>	<b>0.037</b>	<b>0.041</b>
<b>D1</b>	<b>0.430</b>	<b>0.530</b>	<b>0.017</b>	<b>0.021</b>
<b>E1</b>	<b>0.430</b>	<b>0.530</b>	<b>0.017</b>	<b>0.021</b>
<b>k</b>	<b>0.150MIN.</b>		<b>0.006MIN.</b>	
<b>b</b>	<b>0.180</b>	<b>0.280</b>	<b>0.007</b>	<b>0.011</b>
<b>e</b>	<b>0.650TYP.</b>		<b>0.026TYP.</b>	
<b>L</b>	<b>0.200</b>	<b>0.300</b>	<b>0.008</b>	<b>0.012</b>
<b>L1</b>	<b>0.200</b>	<b>0.300</b>	<b>0.008</b>	<b>0.012</b>

## DFNWB1\*1-4L Suggested Pad Layout

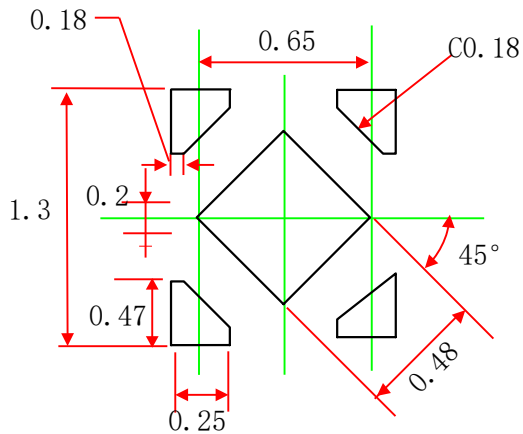

Note:

1. Controlling dimension: in millimeters.
2. General tolerance:  $\pm 0.05\text{mm}$ .
3. The pad layout is for reference purposes only.

## SOT-89-5L Package Outline Dimensions

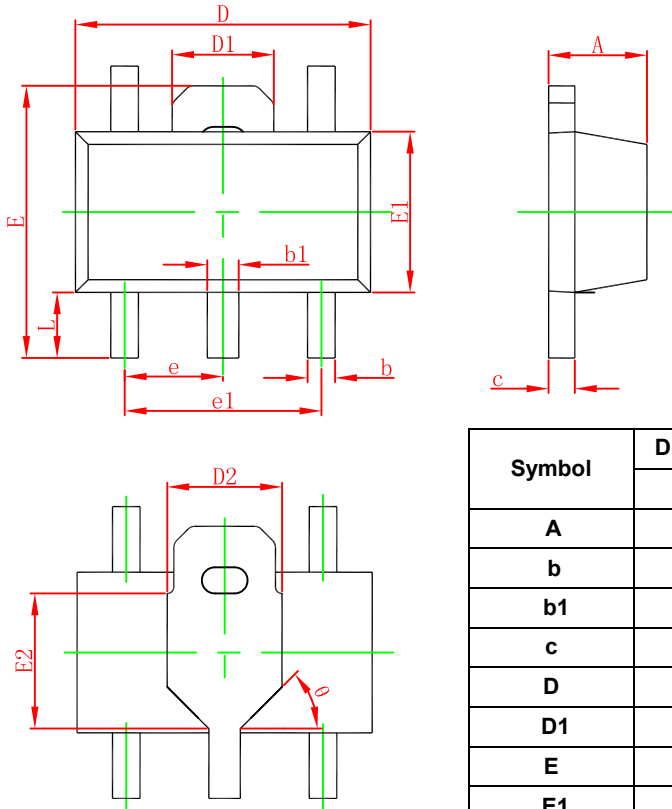

Symbol	Dimensions In Millimeters		Dimensions In Inches	
	Min.	Max.	Min.	Max.
A	1.400	1.600	0.055	0.063
b	0.320	0.520	0.013	0.020
b1	0.360	0.560	0.014	0.022
c	0.350	0.440	0.014	0.017
D	4.400	4.600	0.173	0.181
D1	1.400	1.800	0.055	0.071
E	2.300	2.600	0.091	0.102
E1	3.940	4.250	0.155	0.167
e	1.500TYP		0.060TYP	
e1	2.900	3.100	0.114	0.122
L	0.900	1.100	0.035	0.043

## SOT-89-5L Suggested Pad Layout

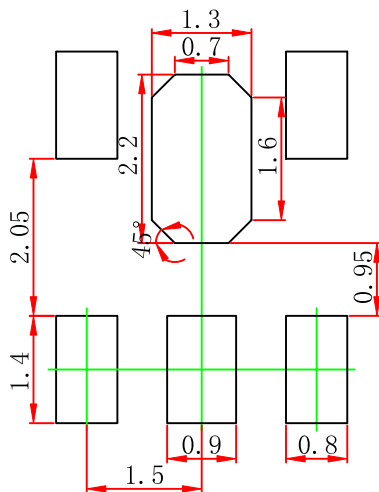

- Note:
1. Controlling dimension: in millimeters.
  2. General tolerance:  $\pm 0.05$  mm.
  3. The pad layout is for reference purposes only.

# DISCLAIMER

## **IMPORTANT NOTICE, PLEASE READ CAREFULLY**

The information in this data sheet is intended to describe the operation and characteristics of our products. JSCJ has the right to make any modification, enhancement, improvement, correction or other changes to any content in this data sheet, including but not limited to specification parameters, circuit design and application information, without prior notice.

Any person who purchases or uses JSCJ products for design shall: 1. Select products suitable for circuit application and design; 2. Design, verify and test the rationality of circuit design; 3. Procedures to ensure that the design complies with relevant laws and regulations and the requirements of such laws and regulations. JSCJ makes no warranty or representation as to the accuracy or completeness of the information contained in this data sheet and assumes no responsibility for the application or use of any of the products described in this data sheet.

Without the written consent of JSCJ, this product shall not be used in occasions requiring high quality or high reliability, including but not limited to the following occasions: medical equipment, automotive electronics, military facilities and aerospace. JSCJ shall not be responsible for casualties or property losses caused by abnormal use or application of this product.

Official Website: [www.jscj-elec.com](http://www.jscj-elec.com)

Copyright © JIANGSU CHANGJING ELECTRONICS TECHNOLOGY CO., LTD.

## X-ON Electronics

Largest Supplier of Electrical and Electronic Components

*Click to view similar products for [Linear Voltage Regulators](#) category:*

*Click to view products by [Changjing Electronics Technology](#) manufacturer:*

Other Similar products are found below :

[LV56831P-E](#) [LV5684PVD-XH](#) [MCDTSA6-2R](#) [L7815ACV-DG](#) [PQ3DZ53U](#) [LV56801P-E](#) [TLE42794G](#) [L78L05CZ/1SX](#) [L78LR05DL-MA-E](#) [636416C](#) [714954EB](#) [BA033LBSG2-TR](#) [LV5680P-E](#) [L78M15CV-DG](#) [L79M05T-E](#) [TLS202A1MBVHTSA1](#) [L78LR05D-MA-E](#) [NCV317MBTG](#) [NTE7227](#) [LV5680NPVC-XH](#) [LT1054CN8](#) [MP2018GZD-5-Z](#) [MP2018GZD-33-Z](#) [MIC5281-3.3YMM](#) [MC78L06BP-AP](#) [TA48LS05F\(TE85L,F\)](#) [TA78L12F\(TE12L,F\)](#) [TC47BR5003ECT](#) [TCR2LN12,LF\(S](#) [TCR2LN28,LF\(S](#) [TCR2LN30,LF\(S](#) [TCR3DF295,LM\(CT](#) [TCR3DF40,LM\(CT](#) [BA178M20CP-E2](#) [L78M12ABDT](#) [LM7812SX/NOPB](#) [LR645N3-G-P003](#) [LR645N3-G-P013](#) [ZXTR2005P5-13](#) [SCD7812BTG](#) [TCR3DF335,LM\(CT](#) [ZXTR2012K-13](#) [TLE42994E V33](#) [ZXTR2008K-13](#) [ZXTR2005K-13](#) [L88R05DL-E](#) [ADP3300ARTZ-2.7RL7](#) [LM120K-15/883](#) [IFX54441LDVXUMA1](#) [LM317D2T-TR](#)