

CJ6386 Series

■ INTRODUCTION

CJ6386 series is a group of positive voltage regulator made by CMOS technology. It has the characteristics of low power consumption and low voltage. Even if the difference between input voltage and output voltage is very small, it can still provide large output current. CJ6386 series can provide 250 mA output current, allowing input voltage up to 45V. Therefore, this series of products are very suitable for battery powered devices, such as RF applications and other systems requiring quiet voltage sources.

CJ6386 series provides: SOT-23-3L\5L, SOT-89-3L, SOT-223 and TO-92, which conform to the ROHS environmental protection standards.

■ APPLICATIONS

- Cordless Phones
- Radio control systems
- Laptop, Palmtops and PDAs
- Single-lens reflex DSC
- PC peripherals with memory

■ BLOCK DIAGRAM

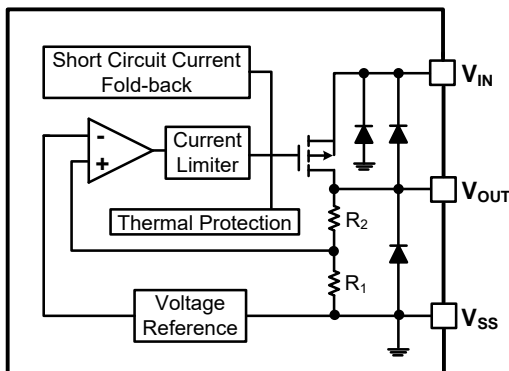

■ FEATURES

- Low Quiescent Current: 2 μ A
- Operating Voltage Range: 2.5V ~ 45V
- Output Current: 250mA
- Low Dropout Voltage:
700mV@100mA($V_{OUT} = 3.3V$)
- Output Voltage: 2.1 ~ 12V
- High Accuracy: $\pm 2\%/\pm 1\%$ (Typ.)
- High Power Supply Rejection Ratio:
70dB@1kHz
- Low Output Noise: 27 μ V_{RMS}
(10Hz ~100kHz)
- Excellent Line and Load Transient Response
- Built-in Current Limiter, Short-Circuit Protection
- Over-Temperature Protection
- Stable with Ceramic or Tantalum Capacitor

- LAN Cards
- Ultra Low Power Microcontrollers
- Wireless Communication Equipments
- Portable Audio Video Equipments
- Car Navigation Systems

■ ORDER INFORMATION

CJ6386①②③④

DESIGNATOR	SYMBOL	DESCRIPTION
①	A	Standard
②③	Integer	Output Voltage e.g.3.3V=②:3, ③:3
④	M/MC/MY	Package:SOT-23-3L
	MF/MR	Package:SOT-23-5L
	P/PT/PL	Package:SOT-89-3L
	T/TA/TB	Package:TO-92
	G/GW/GL	Package:SOT-223

Pin Configuration

SOT-23-3L

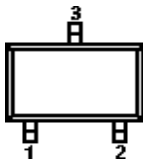

SOT-23-5L

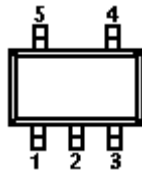

SOT-89-3L

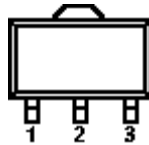

TO-92



SOT-223

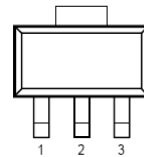

PIN NUMBER									PIN NAME	FUNCTION
CJ6386AxxM/MC/MY			CJ6386AxxP/PT/PL			CJ6386AxxT/TA/TB				
SOT-23-3L			SOT-89-3L			TO-92				
M	MC	MY	P	PT	PL	T	TA	TB		
1	3	3	1	2	2	1	2	2	V _{SS}	Ground
2	2	1	3	1	3	3	3	1	V _{OUT}	Output
3	1	2	2	3	1	2	1	3	V _{IN}	Power Input

SOT-23-5L

PIN NUMBER		PIN NAME	FUNCTION
CJ6386AxxMF/MR			
MF	MR		
1	2	V _{IN}	Power Input
2	1	V _{SS}	Ground
3/4	4/5	NC	No Connection
5	3	V _{OUT}	Output

SOT-223

PIN NUMBER			PIN NAME	FUNCTION
CJ6386AxxG/GW/GL				
G	GW	GL		
1	3	2	V _{IN}	Power input
2	1	1	V _{SS}	Ground
3	2	3	V _{OUT}	Output

Electrical Characteristics

■ ABSOLUTE MAXIMUM RATINGS⁽¹⁾

(Unless otherwise specified, $T_A=25^{\circ}\text{C}$)

PARAMETER		SYMBOL	RATINGS	UNITS
Input Voltage ⁽²⁾		V_{IN}	-0.3~50	V
Output Voltage ⁽²⁾		V_{OUT}	-0.3~12	V
Output Current		I_{OUT}	250	mA
Power Dissipation	SOT-23-3/5L	P_D	0.3	W
	SOT-89-3L		0.6	W
	TO-92		0.4	W
	SOT-223		0.8	W
Operating Junction Temperature Range ⁽³⁾		T_j	150	$^{\circ}\text{C}$
Storage Temperature		T_{stg}	-65~150	$^{\circ}\text{C}$
Lead Temperature(Soldering, 10 sec)		T_{solder}	260	$^{\circ}\text{C}$

(1) Stresses beyond those listed under *absolute maximum ratings* may cause permanent damage to the device. These are stress ratings only, and functional operation of the device at these or any other conditions beyond those indicated under *recommended operating conditions* is not implied. Exposure to absolute-maximum-rated conditions for extended periods may affect device reliability.

(2) All voltages are with respect to network ground terminal.

(3) This IC includes over temperature protection that is intended to protect the device during momentary overload. Junction temperature will exceed 125°C when over temperature protection is active. Continuous operation above the specified maximum operating junction temperature may impair device reliability.

■ RECOMMENDED OPERATING CONDITIONS

PARAMETER	MIN.	NOM.	MAX.	UNITS
Supply voltage at V_{IN}	2.5		45	V
Operating junction temperature range, T_j	-40		125	$^{\circ}\text{C}$
Operating free air temperature range, T_A	-40		85	$^{\circ}\text{C}$

Electrical Characteristics

CJ6386 Series ($V_{IN}=V_{OUT}+2V$, $C_{IN}=C_{OUT}=1\mu F$, $T_A=25^\circ C$, unless otherwise specified)

PARAMETER	SYMBOL	CONDITIONS	MIN.	TYP. ⁽⁴⁾	MAX.	UNITS	
Input Voltage	V_{IN}		2.5	—	45	V	
Output Voltage Range	V_{OUT}		2.1	—	12	V	
DC Output Accuracy		$I_{OUT}=10mA$	-2	—	2	%	
			-1	—	1	%	
Dropout Voltage	$V_{dif}^{(5)}$	$I_{OUT}=100mA, V_{OUT}=3.3V$	—	700	—	mV	
Supply Current	I_{SS}	$I_{OUT}=0A$	—	2	10	μA	
Line Regulation	$\frac{\Delta V_{OUT}}{V_{OUT} \times \Delta V_{IN}}$	$I_{OUT}=10mA$ $V_{OUT}+1V \leq V_{IN} \leq 36V$	—	0.01	0.3	%/V	
Load Regulation	ΔV_{OUT}	$V_{IN}=V_{OUT}+2V$, $1mA \leq I_{OUT} \leq 100mA$	—	8	—	mV	
Temperature Coefficient	$\frac{\Delta V_{OUT}}{V_{OUT} \times \Delta T_A}$	$I_{OUT}=40mA$, $-40^\circ C < T_A < 85^\circ C$	—	50	—	ppm	
Output Current Limit	I_{LIM}	$V_{OUT}=0.5 \times V_{OUT(Normal)}$	—	260	—	mA	
Short Current	I_{SHORT}	$V_{OUT}=V_{SS}$	—	30	—	mA	
Power Supply Rejection Ratio	PSRR	$I_{OUT}=50mA$	100Hz	—	80	—	dB
			1kHz	—	70	—	
			10kHz	—	60	—	
			100kHz	—	50	—	
Output Noise Voltage	V_{ON}	BW=10Hz to 100kHz	—	$27 \times V_{OUT}$	—	μV_{RMS}	
Thermal Shutdown Temperature	T_{SD}	$I_{LOAD}=30mA$	—	160	—	$^\circ C$	
Thermal Shutdown Hysteresis	ΔT_{SD}	—	—	20	—	$^\circ C$	

(4) Typical numbers are at 25°C and represent the most likely norm.

(5) V_{dif} : The Difference Of Output Voltage And Input Voltage When Input Voltage Is Decreased Gradually Till Output Voltage Equals To 98% Of V_{OUT} (E).

■ TYPICAL APPLICATION CIRCUIT

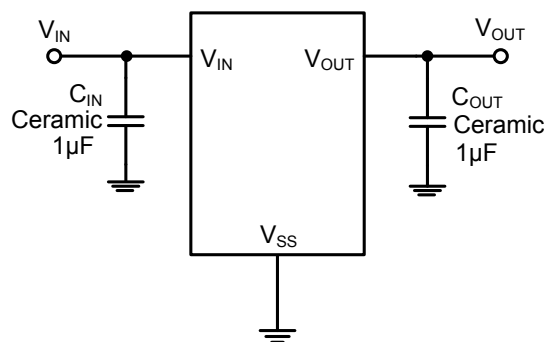

Typical Characteristics

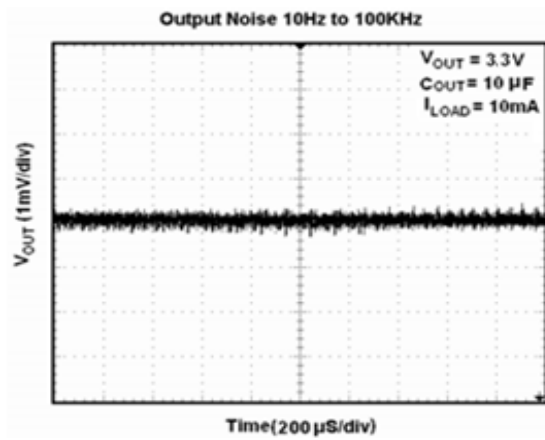
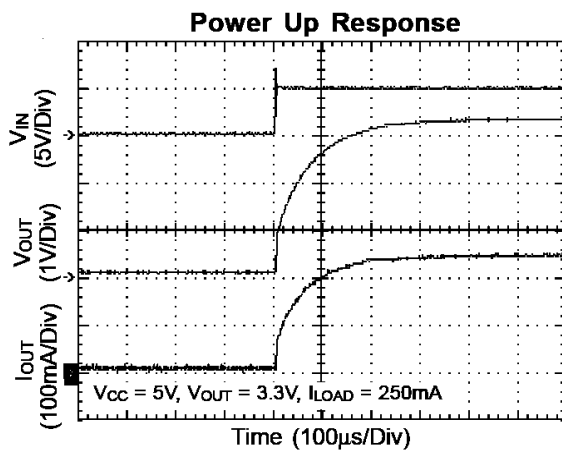
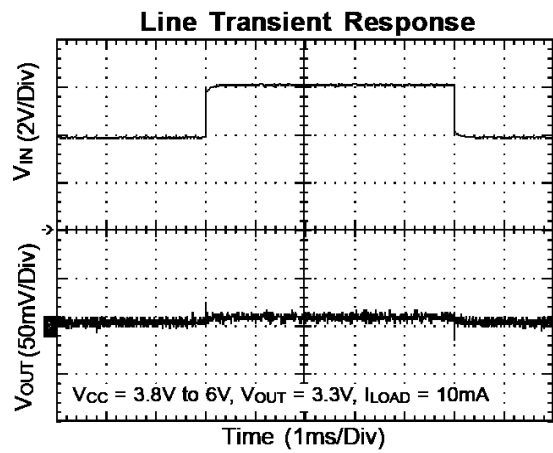
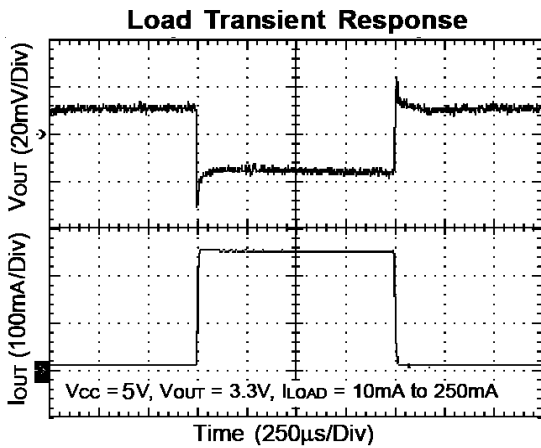
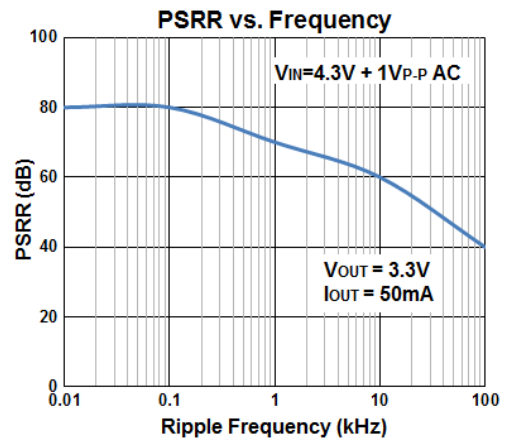
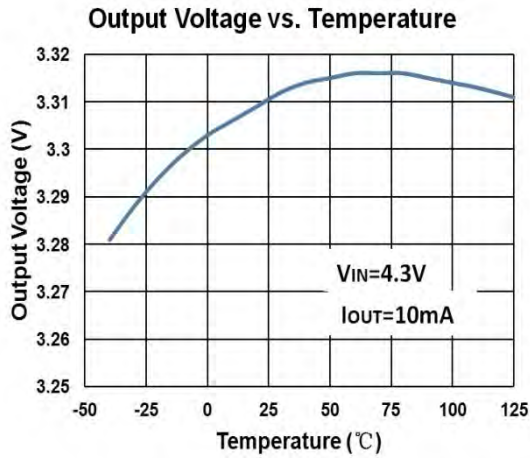

Typical Characteristics

Dropout Voltage vs. Temperature

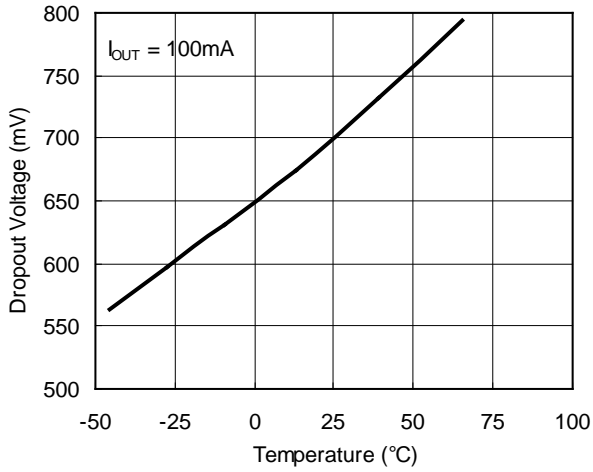

Output Voltage vs. Load Current

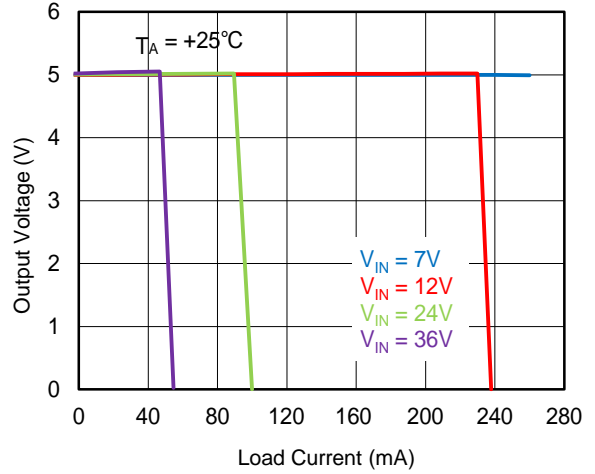

Dropout Voltage vs. Output Current

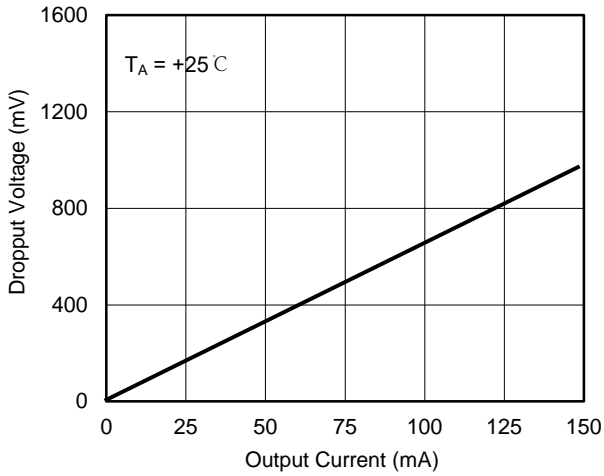

Ground Pin Current vs. Temperature

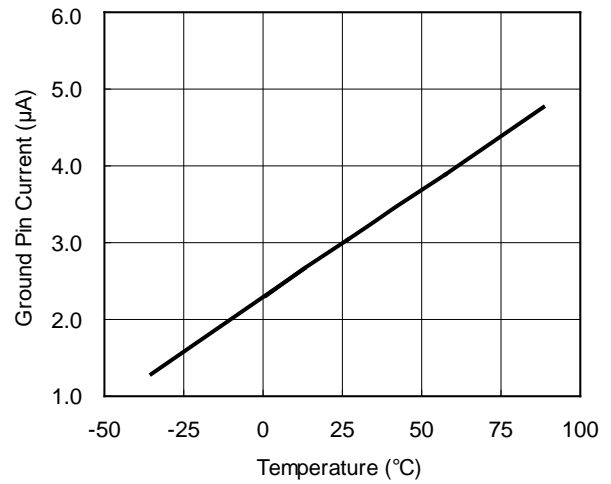

Load Current Vs. Temperature

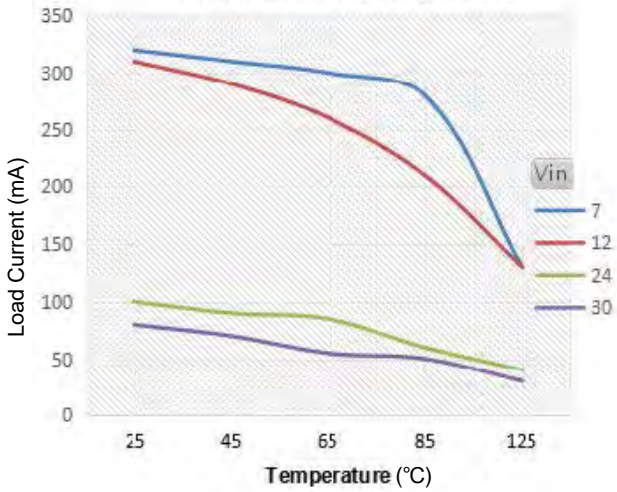

SOT-23-3L Package Outline Dimensions

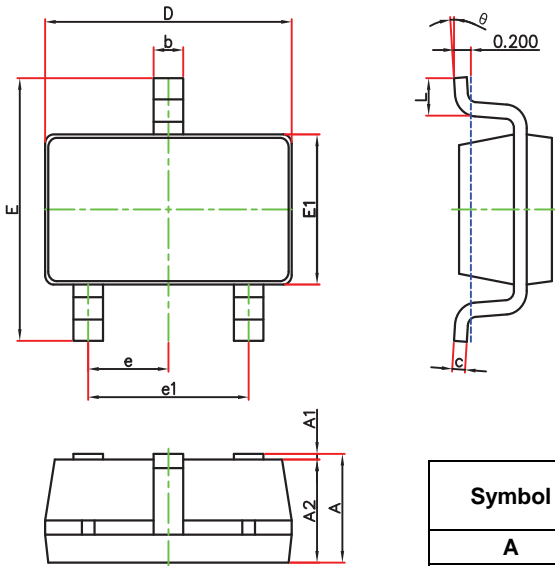

Symbol	Dimensions In Millimeters		Dimensions In Inches	
	Min.	Max.	Min.	Max.
A	1.050	1.250	0.041	0.049
A1	0.000	0.100	0.000	0.004
A2	1.050	1.150	0.041	0.045
b	0.300	0.500	0.012	0.020
c	0.100	0.200	0.004	0.008
D	2.820	3.020	0.111	0.119
E	2.650	2.950	0.104	0.116
E1	1.500	1.700	0.059	0.067
e	0.950(BSC)		0.037(BSC)	
e1	1.800	2.000	0.071	0.079
L	0.300	0.600	0.012	0.024
θ	0°	8°	0°	8°

SOT-23-3L Suggested Pad Layout

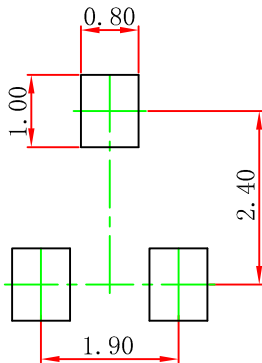

Note:

1. Controlling dimension "in" millimeters.
2. General tolerance: $\pm 0.05\text{mm}$.
3. The pad layout is for reference purpose only.

SOT-23-5L Package Outline Dimensions

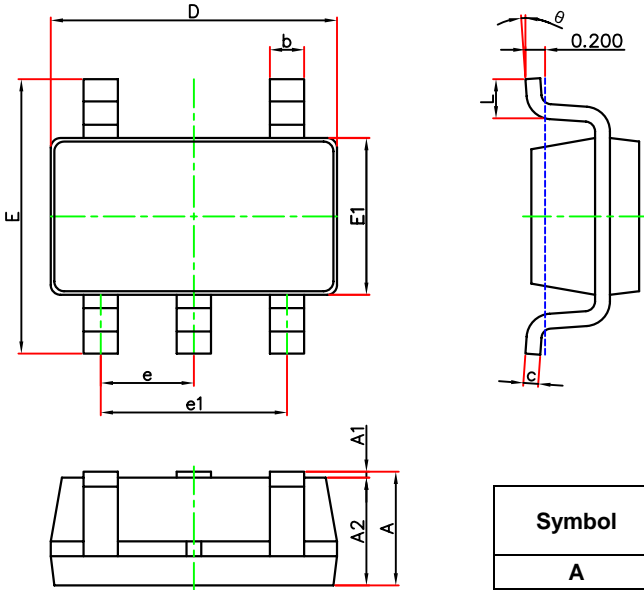

Symbol	Dimensions In Millimeters		Dimensions In Inches	
	Min.	Max.	Min.	Max.
A	1.050	1.250	0.041	0.049
A1	0.000	0.100	0.000	0.004
A2	1.050	1.150	0.041	0.045
b	0.300	0.500	0.012	0.020
c	0.100	0.200	0.004	0.008
D	2.820	3.020	0.111	0.119
E	2.650	2.950	0.104	0.116
E1	1.500	1.700	0.059	0.067
e	0.950(BSC)		0.037(BSC)	
e1	1.800	2.000	0.071	0.079
L	0.300	0.600	0.012	0.024
θ	0°	8°	0°	8°

SOT-23-5L Suggested Pad Layout

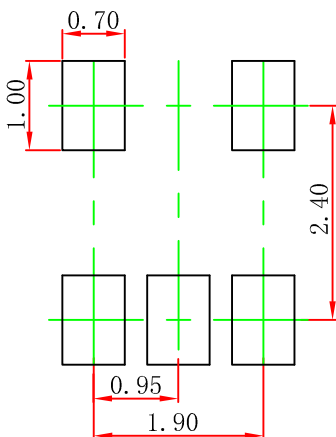

Note:

1. Controlling dimension "in" millimeters.
2. General tolerance: ± 0.05 mm.
3. The pad layout is for reference purpose only.

SOT-89-3L Package Outline Dimensions

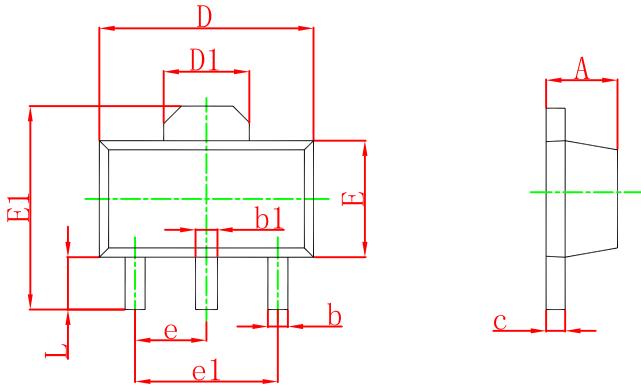

Symbol	Dimensions In Millimeters		Dimensions In Inches	
	Min.	Max.	Min.	Max.
A	1.400	1.600	0.055	0.063
b	0.320	0.520	0.013	0.197
b1	0.400	0.580	0.016	0.023
c	0.350	0.440	0.014	0.017
D	4.400	4.600	0.173	0.181
D1	1.550 REF		0.061 REF	
E	2.300	2.600	0.091	0.102
E1	3.940	4.250	0.155	0.167
e	1.500 TYP		0.060 TYP	
e1	3.000 TYP		0.118 TYP	
L	0.900	1.200	0.035	0.047

SOT-89-3L Suggested Pad Layout

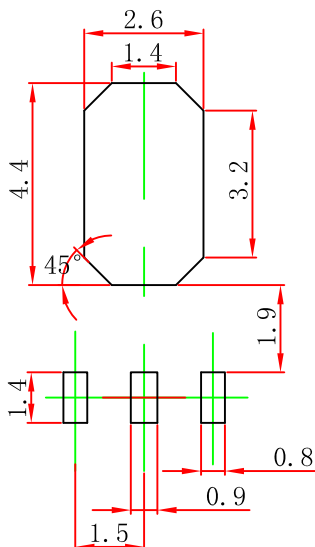

Note:

1. Controlling dimension "in" millimeters.
2. General tolerance: $\pm 0.05\text{mm}$.
3. The pad layout is for reference purpose only.

SOT-223 Package Outline Dimensions

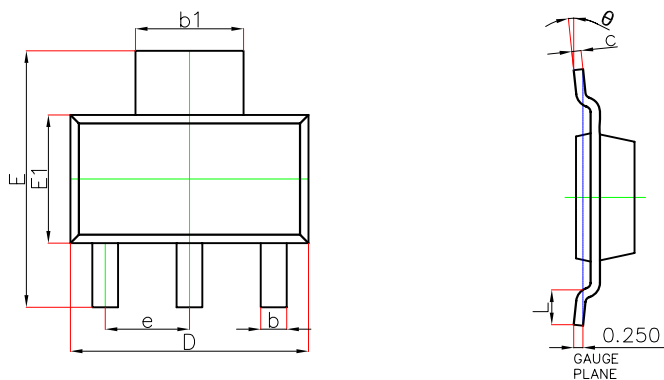

Symbol	Dimensions In Millimeters		Dimensions In Inches	
	Min.	Max.	Min.	Max.
A	—	1.800	—	0.071
A1	0.020	0.100	0.001	0.004
A2	1.500	1.700	0.059	0.067
b	0.660	0.840	0.026	0.033
b1	2.900	3.100	0.114	0.122
c	0.230	0.350	0.009	0.014
D	6.300	6.700	0.248	0.264
E	6.700	7.300	0.264	0.287
E1	3.300	3.700	0.130	0.146
e	2.300(BSC)		0.091(BSC)	
L	0.750	—	0.030	—
θ	0°	10°	0°	10°

SOT-223 Suggested Pad Layout

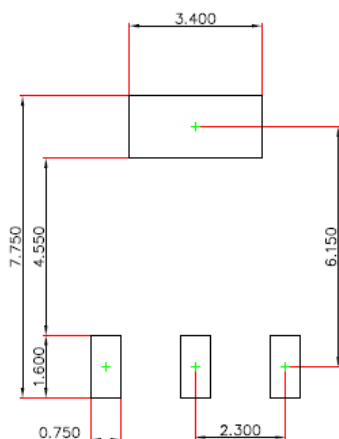

- Note:
1. Controlling dimension in millimeters.
 2. General tolerance: $\pm 0.05\text{mm}$.
 3. The pad layout is for reference purpose only.

TO-92 Package Outline Dimensions

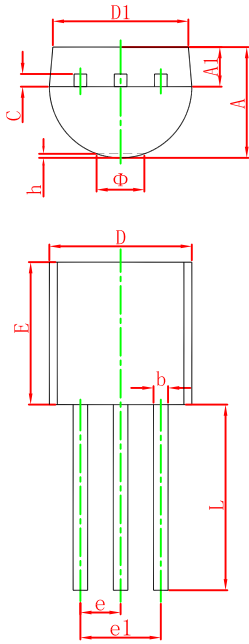

Symbol	Dimensions In Millimeters		Dimensions In Inches	
	Min.	Max.	Min.	Max.
A	3.300	3.700	0.130	0.146
A1	1.100	1.400	0.043	0.055
b	0.380	0.550	0.015	0.022
c	0.360	0.510	0.014	0.020
D	4.400	4.700	0.173	0.185
D1	3.430		0.135	
E	4.300	1.400	0.169	0.185
e	1.270 TYP		0.050 TYP	
e1	2.440	2.640	0.096	0.104
L	14.100	14.500	0.555	0.571
Φ		1.600		0.063
h	0.000	0.380	0.000	0.015

TO-92 Suggested Pad Layout

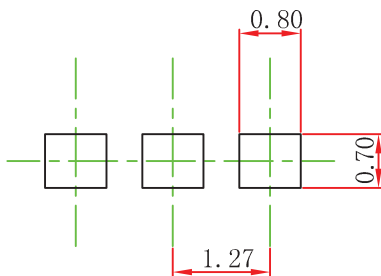

Note:

1. Controlling dimension "in" millimeters.
2. General tolerance: ± 0.05 mm.
3. The pad layout is for reference purpose only.

DISCLAIMER

IMPORTANT NOTICE, PLEASE READ CAREFULLY

The information in this data sheet is intended to describe the operation and characteristics of our products. JSCJ has the right to make any modification, enhancement, improvement, correction or other changes to any content in this data sheet, including but not limited to specification parameters, circuit design and application information, without prior notice.

Any person who purchases or uses JSCJ products for design shall: 1. Select products suitable for circuit application and design; 2. Design, verify and test the rationality of circuit design; 3. Procedures to ensure that the design complies with relevant laws and regulations and the requirements of such laws and regulations. JSCJ makes no warranty or representation as to the accuracy or completeness of the information contained in this data sheet and assumes no responsibility for the application or use of any of the products described in this data sheet.

Without the written consent of JSCJ, this product shall not be used in occasions requiring high quality or high reliability, including but not limited to the following occasions: medical equipment, automotive electronics, military facilities and aerospace. JSCJ shall not be responsible for casualties or property losses caused by abnormal use or application of this product.

Official Website: www.jscj-elec.com

Copyright © JIANGSU CHANGJING ELECTRONICS TECHNOLOGY CO., LTD.

X-ON Electronics

Largest Supplier of Electrical and Electronic Components

Click to view similar products for [Linear Voltage Regulators](#) category:

Click to view products by [Changjing Electronics Technology](#) manufacturer:

Other Similar products are found below :

[LV5684PVD-XH](#) [MCDTSA6-2R](#) [L7815ACV-DG](#) [LV56801P-E](#) [UA7805CKC](#) [714954EB](#) [ZMR500QFTA](#) [BA033LBSG2-TR](#)
[NCV78M05ABDTRKG](#) [LV5680P-E](#) [L79M05T-E](#) [L78LR05D-MA-E](#) [NCV317MBTG](#) [NTE7227](#) [MP2018GZD-33-P](#) [MP2018GZD-5-P](#)
[LV5680NPVC-XH](#) [ZTS6538SE](#) [UA78L09CLP](#) [UA78L09CLPR](#) [CAT6221-PPTD-GT3](#) [MC78M09CDTRK](#) [NCV51190MNTAG](#)
[BL1118CS8TR1833](#) [BL8563CKETR18](#) [BL8077CKETR33](#) [BL9153-33CC3TR](#) [BL9161G-15BADRN](#) [BL9161G-28BADRN](#)
[BRCO7530MMC](#) [CJ7815B-TFN-ARG](#) [LM317C](#) [GM7333K](#) [GM7350K](#) [XC6206P332MR](#) [HT7533](#) [LM7912S/TR](#) [LT1764S/TR](#) [LM7805T](#)
[LM338T](#) [LM1117IMP-3.3/TR](#) [HT1117AM-3.3](#) [HT7550S](#) [AMS1117-3.3](#) [HT7150S](#) [78L12](#) [HT7550](#) [HT7533-1](#) [HXY6206I-2.5](#) [HT7133](#)