



## CJ7800B Series Three Terminal Voltage Regulator

### 1 Introduction

The CJ7800B series is a group of three terminal positive voltage linear regulators with multiple fixed output voltages. Under the condition of good heat dissipation, it can provide output current up to 1A, and has the functions of internal current limit, short circuit protection, thermal shutdown protection and output transistor SOA protection, which make it relatively difficult to damage. Although designed as fixed voltage regulators without external components, these devices can be used with external components to obtain adjustable voltage and current. Therefore, the CJ7800B series is widely used as fixed voltage regulators, including local (on card) regulators, to eliminate noise and power distribution problems associated with single point regulation.

### 2 Available Packages

PART NUMBER	PACKAGE
CJ7800B Series	TO-220-3L
	TO-220F
	TO-252-2L
	TO-263-2L

**Note:** For all available packages, please refer to the part *Orderable Information*.

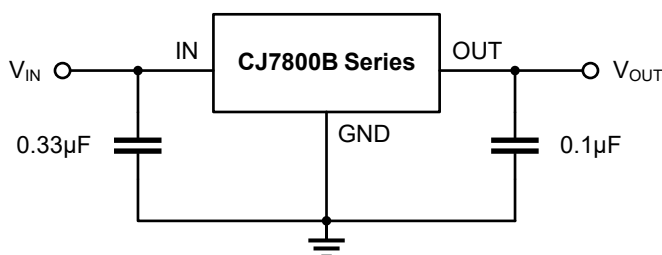

Figure 2-1. Typical Application Circuit

### 3 Features

- Available Fixed Output Voltage:
  - 5.0V: CJ7805B
  - 6.0V: CJ7806B
  - 8.0V: CJ7808B
  - 9.0V: CJ7809B
  - 12V : CJ7812B
  - 15V : CJ7815B
- Output Current:
  - up to 1A at  $T_J = 25^\circ\text{C}$
- Output Voltage Tolerance at  $T_J = 25^\circ\text{C}$ :
  - $\pm 2\%$  for Conventional Device
  - $\pm 1\%$  can be Customized
- Operating Junction Temperature:
  - $-40 \sim 125^\circ\text{C}$
- Output Voltage Tolerances of  $\pm 4\%$  over the Temperature Range
- Dropout Voltage: 2V@1A
- Power Supply Rejection Ratio:
  - 70dB@120Hz ( $V_{OUT} = 5.0\text{V}$ )
- Output Transistor SOA Protection
- Internal Current Limit
- Short Circuit Protection
- Thermal Shutdown Protection

### 4 Applications

- AC Inventors
- DC Motor Drivers
- Household Electric Appliances
- HVAC Systems
- Industrial Power Supplies
- SMPS Post Regulation
- Solar Energy String Inventors
- Test and Measurement Equipment

5 Orderable Information

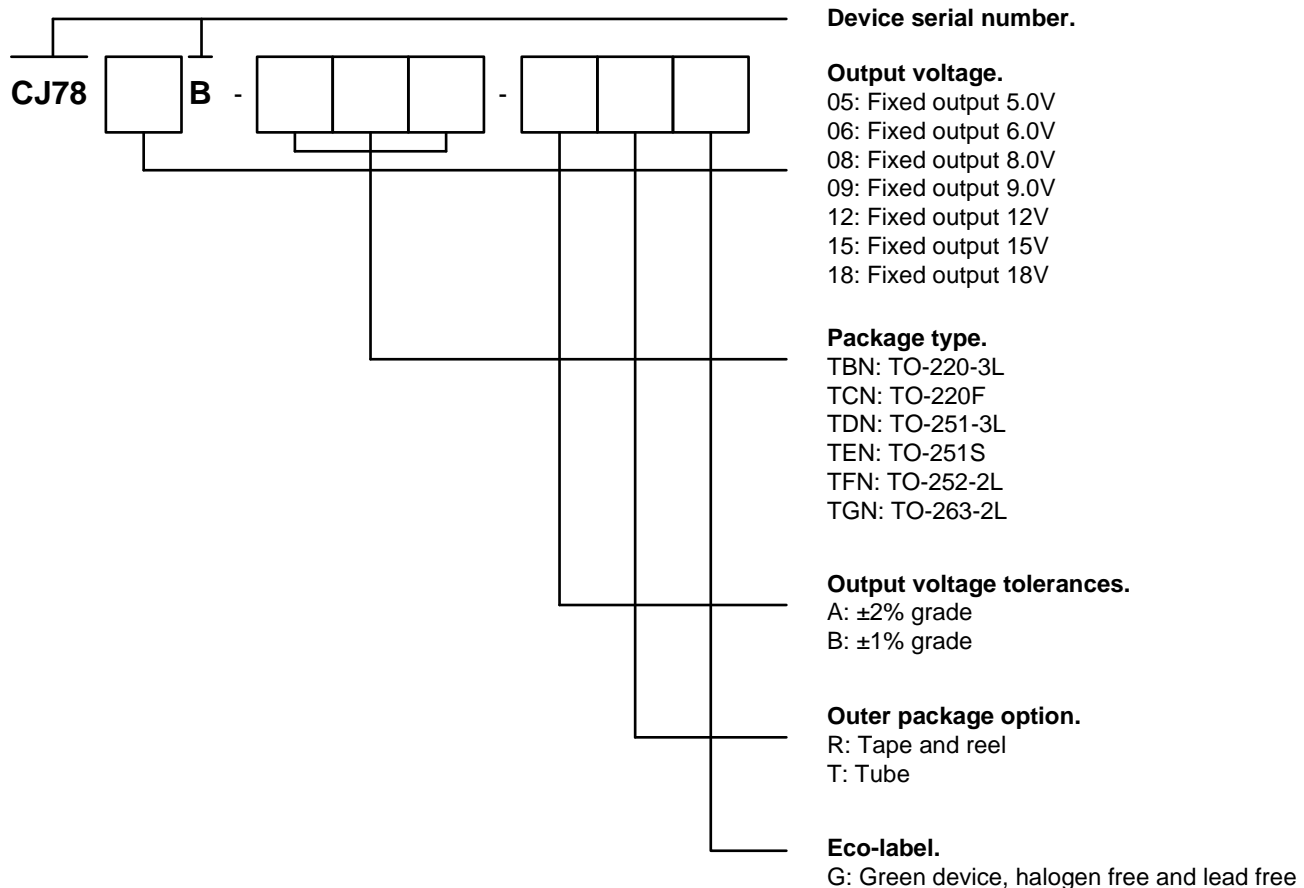

Figure 5-1. CJ7800B Series Naming Conventions

MODEL	DEVICE	PACKAGE	OP T <sub>J</sub>	ECO PLAN	MSL	PACKING OPTION	SORT
<b>Conventional Device</b>							
CJ7800B-5.0	CJ7805B-TBN-ATG	TO-220-3L	-40 ~ 125°C	RoHS & Green	Level 3 168 HR	Tube 50 Units / Rail	Active
CJ7800B-6.0	CJ7806B-TBN-ATG	TO-220-3L	-40 ~ 125°C	RoHS & Green	Level 3 168 HR	Tube 50 Units / Rail	Active
CJ7800B-8.0	CJ7808B-TBN-ATG	TO-220-3L	-40 ~ 125°C	RoHS & Green	Level 3 168 HR	Tube 50 Units / Rail	Active
CJ7800B-9.0	CJ7809B-TBN-ATG	TO-220-3L	-40 ~ 125°C	RoHS & Green	Level 3 168 HR	Tube 50 Units / Rail	Active
CJ7800B-12	CJ7812B-TBN-ATG	TO-220-3L	-40 ~ 125°C	RoHS & Green	Level 3 168 HR	Tube 50 Units / Rail	Active
CJ7800B-15	CJ7815B-TBN-ATG	TO-220-3L	-40 ~ 125°C	RoHS & Green	Level 3 168 HR	Tube 50 Units / Rail	Active

**5 Orderable Information**

MODEL	DEVICE	PACKAGE	OP T <sub>J</sub>	ECO PLAN	MSL	PACKING OPTION	SORT
<b>Conventional Device (continued)</b>							
CJ7800B-5.0	CJ7805B-TCN-ATG	TO-220F	-40 ~ 125°C	RoHS & Green	Level 3 168 HR	Tube 50 Units / Rail	Active
CJ7800B-6.0	CJ7806B-TCN-ATG	TO-220F	-40 ~ 125°C	RoHS & Green	Level 3 168 HR	Tube 50 Units / Rail	Active
CJ7800B-8.0	CJ7808B-TCN-ATG	TO-220F	-40 ~ 125°C	RoHS & Green	Level 3 168 HR	Tube 50 Units / Rail	Active
CJ7800B-9.0	CJ7809B-TCN-ATG	TO-220F	-40 ~ 125°C	RoHS & Green	Level 3 168 HR	Tube 50 Units / Rail	Active
CJ7800B-12	CJ7812B-TCN-ATG	TO-220F	-40 ~ 125°C	RoHS & Green	Level 3 168 HR	Tube 50 Units / Rail	Active
CJ7800B-15	CJ7815B-TCN-ATG	TO-220F	-40 ~ 125°C	RoHS & Green	Level 3 168 HR	Tube 50 Units / Rail	Active
CJ7800B-12	CJ7812B-TDN-ATG	TO-251-3L	-40 ~ 125°C	RoHS & Green	Level 3 168 HR	Tube 80 Units / Rail	Active
CJ7800B-5.0	CJ7805B-TFN-ARG	TO-252-2L	-40 ~ 125°C	RoHS & Green	Level 3 168 HR	Tape and Reel 2500 Units / Reel	Active
CJ7800B-6.0	CJ7806B-TFN-ARG	TO-252-2L	-40 ~ 125°C	RoHS & Green	Level 3 168 HR	Tape and Reel 2500 Units / Reel	Active
CJ7800B-8.0	CJ7808B-TFN-ARG	TO-252-2L	-40 ~ 125°C	RoHS & Green	Level 3 168 HR	Tape and Reel 2500 Units / Reel	Active
CJ7800B-9.0	CJ7809B-TFN-ARG	TO-252-2L	-40 ~ 125°C	RoHS & Green	Level 3 168 HR	Tape and Reel 2500 Units / Reel	Active
CJ7800B-12	CJ7812B-TFN-ARG	TO-252-2L	-40 ~ 125°C	RoHS & Green	Level 3 168 HR	Tape and Reel 2500 Units / Reel	Active
CJ7800B-15	CJ7815B-TFN-ARG	TO-252-2L	-40 ~ 125°C	RoHS & Green	Level 3 168 HR	Tape and Reel 2500 Units / Reel	Active

**5 Orderable Information**

MODEL	DEVICE	PACKAGE	OP T <sub>J</sub>	ECO PLAN	MSL	PACKING OPTION	SORT
<b>Conventional Device (continued)</b>							
CJ7800B-5.0	CJ7805B-TGN-ARG	TO-263-2L	-40 ~ 125°C	RoHS & Green	Level 3 168 HR	Tape and Reel 800 Units / Reel	Active
CJ7800B-6.0	CJ7806B-TGN-ARG	TO-263-2L	-40 ~ 125°C	RoHS & Green	Level 3 168 HR	Tape and Reel 800 Units / Reel	Active
CJ7800B-8.0	CJ7808B-TGN-ARG	TO-263-2L	-40 ~ 125°C	RoHS & Green	Level 3 168 HR	Tape and Reel 800 Units / Reel	Active
CJ7800B-9.0	CJ7809B-TGN-ARG	TO-263-2L	-40 ~ 125°C	RoHS & Green	Level 3 168 HR	Tape and Reel 800 Units / Reel	Active
CJ7800B-12	CJ7812B-TGN-ARG	TO-263-2L	-40 ~ 125°C	RoHS & Green	Level 3 168 HR	Tape and Reel 800 Units / Reel	Active
CJ7800B-15	CJ7815B-TGN-ARG	TO-263-2L	-40 ~ 125°C	RoHS & Green	Level 3 168 HR	Tape and Reel 800 Units / Reel	Active
<b>Customized Device</b>							
CJ7800B-18	CJ7818B-xxx-xxx	-	-40 ~ 125°C	RoHS & Green	Level 3 168 HR	-	Customized
CJ7800B-x.x	CJ78xxB-TDN-ATG	TO-251-3L	-40 ~ 125°C	RoHS & Green	Level 3 168 HR	Tube 80 Units / Rail	Customized
	CJ78xxB-TEN-ATG	TO-251S	-40 ~ 125°C	RoHS & Green	Level 3 168 HR	Tube 80 Units / Rail	Customized
CJ7800B-x.x ±1% grade	CJ78xxB-TBN-BTG	TO-220-3L	-40 ~ 125°C	RoHS & Green	Level 3 168 HR	Tube 50 Units / Rail	Customized
	CJ78xxB-TCN-BTG	TO-220F	-40 ~ 125°C	RoHS & Green	Level 3 168 HR	Tube 50 Units / Rail	Customized
	CJ78xxB-TDN-BTG	TO-251-3L	-40 ~ 125°C	RoHS & Green	Level 3 168 HR	Tube 80 Units / Rail	Customized
	CJ78xxB-TEN-BTG	TO-251S	-40 ~ 125°C	RoHS & Green	Level 3 168 HR	Tube 80 Units / Rail	Customized
	CJ78xxB-TFN-BRG	TO-252-2L	-40 ~ 125°C	RoHS & Green	Level 3 168 HR	Tape and Reel 2500 Units / Reel	Customized
	CJ78xxB-TGN-BRG	TO-263-2L	-40 ~ 125°C	RoHS & Green	Level 3 168 HR	Tape and Reel 800 Units / Reel	Customized
Others	-	-	-	-	-	-	Customized

## 5 Orderable Information

**Note:**

**ECO PLAN:** For the RoHS and Green certification standards of this product, please refer to the official report provided by JSCJ.

**MSL:** Moisture Sensitivity Level. Determined according to JEDEC industry standard classification.

**SORT:** Specifically defined as follows:

Active: Recommended for new products;

Customized: Products manufactured to meet the specific needs of customers;

Preview: The device has been released and has not been fully mass produced. The sample may or may not be available;

NoRD: It is not recommended to use the device for new design. The device is only produced for the needs of existing customers;

Obsolete: The device has been discontinued.

## 6 Pin Configuration and Marking Information

### 6.1 Pin Configuration

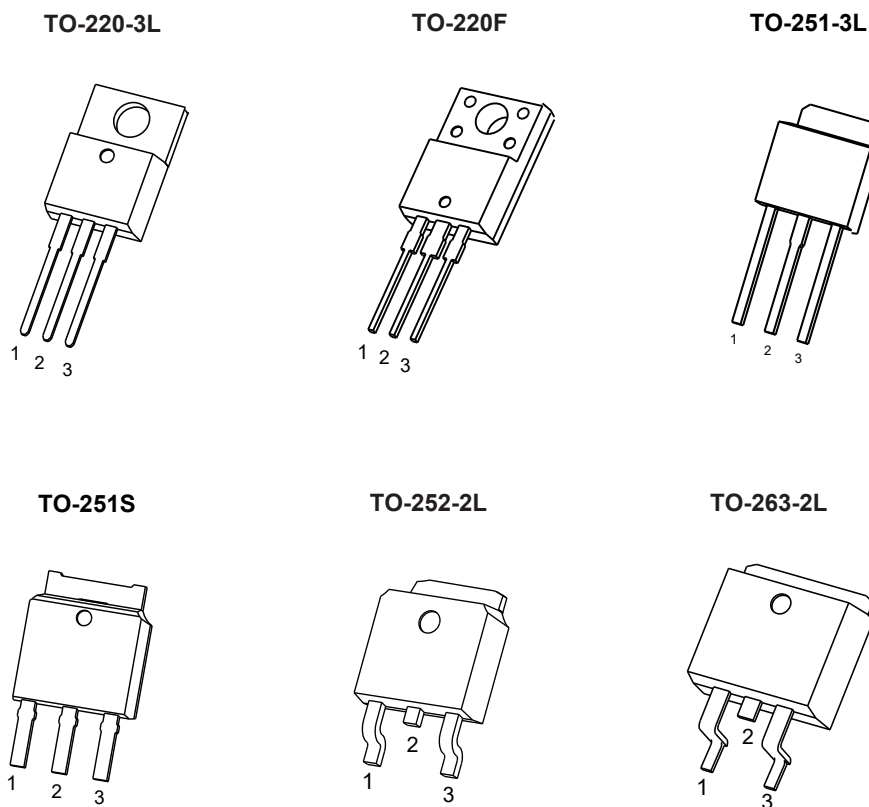

Figure 6-1. Pin Configuration

PIN NAME	CJ7800B Series Pin Configuration						DESCRIPTION
	TO-220-3L	TO-220F	TO-251-3L	TO-251S	TO-252-2L	TO-263-2L	
	(TBN)	(TCN)	(TDN)	(TEN)	(TFN)	(TGN)	
IN	1	1	1	1	1	1	Input of the device.
GND	2	2	2	2	2	2	Regulator ground.
OUT	3	3	3	3	3	3	Output of the device.

## 6 Pin Configuration and Marking Information

### 6.2 Marking Information

Figure 6-2. CJ7800B Series Marking

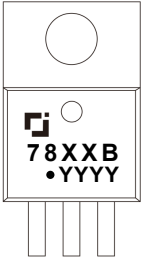
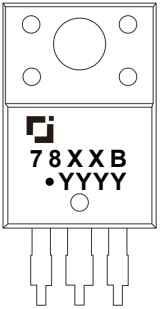
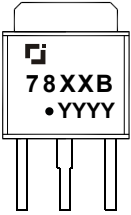
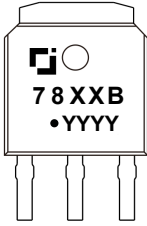
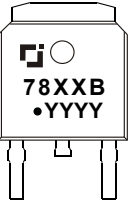
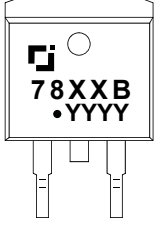
 <p>Diagram of TO-220-3L (TBN) package marking. The marking includes the JSCJ logo, a small circle, the device code "78XXB", and a solid dot followed by "YYYY".</p>	 <p>Diagram of TO-220F (TCN) package marking. The marking includes the JSCJ logo, a small circle, the device code "78XXB", and a solid dot followed by "YYYY".</p>	 <p>Diagram of TO-251-3L (TDN) package marking. The marking includes the JSCJ logo, a small circle, the device code "78XXB", and a solid dot followed by "YYYY".</p>	 <p>Diagram of TO-251S (TEN) package marking. The marking includes the JSCJ logo, a small circle, the device code "78XXB", and a solid dot followed by "YYYY".</p>
<p>TO-220-3L (TBN)</p>	<p>TO-220F (TCN)</p>	<p>TO-251-3L (TDN)</p>	<p>TO-251S (TEN)</p>
 <p>Diagram of TO-252-2L (TFN) package marking. The marking includes the JSCJ logo, a small circle, the device code "78XXB", and a solid dot followed by "YYYY".</p>	 <p>Diagram of TO-263-2L (TGN) package marking. The marking includes the JSCJ logo, a small circle, the device code "78XXB", and a solid dot followed by "YYYY".</p>		
<p>TO-252-2L (TFN)</p>	<p>TO-263-2L (TGN)</p>		

**Note:**

"78XXB": Device code, the "XX" in the "78XXB" represents the output voltage, for example, if  $V_{OUT} = 5.0V$ , the "XX" is "05".

"." Solid dot: Green molding compound device.

"YYYY": Code. Indicates weekly record information of production.

## 7 Specifications

### 7.1 Absolute Maximum Ratings

(over operating free-air temperature range, unless otherwise specified)

CHARACTERISTIC		SYMBOL	VALUE	UNIT
Maximum input voltage range <sup>(2)</sup>		V <sub>IN MAX</sub>	36	V
Maximum output current		I <sub>OUT MAX</sub>	1.0	A
Maximum power dissipation	CJ7800B Series	TO-220-3L	Internally Limited <sup>(3)</sup>	W
		TO-220F		
		TO-251-3L		
		TO-251S		
		TO-252-2L		
		TO-263-2L		
Maximum junction temperature		T <sub>J Max</sub>	150	°C
Storage temperature		T <sub>stg</sub>	-65 ~ 150	°C
Soldering temperature & time		T <sub>solder</sub>	260°C, 10s	-

(1) Stresses beyond those listed under *Absolute Maximum Ratings* may cause permanent damage to the device. These are stress ratings only, which do not imply functional operation of the device at these or any other conditions beyond those indicated under *Recommended Operating Conditions*. Exposure to absolute-maximum rated conditions for extended periods may affect device reliability.

(2) All voltages are with respect to network ground terminal.

(3) Refer to *Thermal Information* for details.

### 7.2 Recommend Operating Conditions

PARAMETER		SYMBOL	MIN.	NOM.	MAX.	UNIT
Input voltage range	CJ7805B	V <sub>IN</sub>	-	-	25	V
	CJ7806B		-	-	26	
	CJ7808B		-	-	28	
	CJ7809B		-	-	29	
	CJ7812B		-	-	32	
	CJ7815B		-	-	32	
	CJ7818B		-	-	32	
Operating junction temperature		T <sub>J</sub>	-40	-	125	°C
Operating ambient temperature		T <sub>A</sub>	-	-(4)	-	°C

(4) It is necessary to ensure that the operating junction temperature of the device does not exceed the rated value of the recommended operating conditions when using the device for design.



## 7 Specifications

### 7.3 ESD Ratings

ESD RATINGS		SYMBOL	VALUE	UNIT
Electrostatic discharge <sup>(5)</sup>	Human body model	$V_{ESD-HBM}$	6000	V
	Machine model	$V_{ESD-MM}$	500	

(5) ESD testing is conducted in accordance with the relevant specifications formulated by the Joint Electronic Equipment Engineering Commission (JEDEC). The human body model (HBM) electrostatic discharge test is based on the JESD22-114D test standard, using a 100pF capacitor and discharging to each pin of the device through a resistance of 1.5kΩ. The electrostatic discharge test in mechanical model (MM) is based on the JESD22-115-A test standard and uses a 200pF capacitor to discharge directly to each pin of the device.

### 7.4 Thermal Information

THERMAL METRIC <sup>(6)</sup>	SYMBOL	CJ7800B Series			UNIT
		TO-220-3L	TO-220F	TO-251-3L	
Junction-to-ambient thermal resistance	$R_{\theta JA}$				°C/W
		65.1	66.4	80.4	
		TO-251S	TO-252-2L	TO-263-2L	
		81.8	78.9	62.3	
Junction-to-case thermal resistance	$R_{\theta JC}$	TO-220-3L	TO-220F	TO-251-3L	°C/W
		5.4	6.2	9.1	
		TO-251S	TO-252-2L	TO-263-2L	
		9.7	5.8	5.3	
Reference maximum power dissipation for continuous operation	$P_{D Ref}$	TO-220-3L	TO-220F	TO-251-3L	W
		1.53	1.51	1.25	
		TO-251S	TO-252-2L	TO-263-2L	
		1.23	1.25	1.60	

(6)  $T_A = 25^\circ\text{C}$ , all numbers are typical, and apply for packages soldered directly onto a PCB board in still air without extra heat dissipation pads.

## 7 Specifications

### 7.5 Electrical Characteristics

**CJ7805B ( $V_{IN} = 10V$ ,  $I_{OUT} = 500mA$ ,  $C_{IN} = 0.33\mu F$ ,  $C_{OUT} = 0.1\mu F$ ,  $T_J = 25^\circ C$ , unless otherwise specified)**

CHARACTERISTIC	SYMBOL	TEST CONDITIONS <sup>(7)</sup>	MIN.	TYP.	MAX.	UNIT	
Output voltage	$V_{OUT}$	$T_J = 25^\circ C$	$\pm 2\%$ grade <sup>(8)</sup>	4.90	5.00	5.10	V
			$\pm 1\%$ grade <sup>(8)</sup>	4.95		5.05	
		$I_{OUT} = 5mA$ to 1A, $V_{IN} = 7.5$ to 20V, $T_J = -40$ to $125^\circ C$ , $P_D \leq 15W$	4.80	5.00	5.20		
Line regulation	$\Delta V_{RLINE}$	$V_{IN} = 7.5$ to 20V, $I_{OUT} = 500mA$	-	25	50	mV	
Load regulation	$\Delta V_{RLOAD}$	$V_{IN} = 10V$ , $I_{OUT} = 5mA$ to 1A	-	20	50	mV	
Quiescent current	$I_Q$	$V_{IN} = 10V$ , $T_J = -40$ to $125^\circ C$ , $I_{OUT} = 0mA$	-	3.2	6.0	mA	
Quiescent current change	$\Delta I_Q$	$V_{IN} = 10V$ , $I_{OUT} = 5mA$ to 1A	-	0.1	0.8	mA	
		$V_{IN} = 8$ to 25V, $I_{OUT} = 500mA$	-	0.3	0.8		
Output voltage temperature coefficient	$\Delta V_{OUT} / \Delta T$	-	-	0.4	-	mV/ $^\circ C$	
	$\Delta V_{OUT} / (V_{OUT} \times \Delta T)$		-	80	-	ppm/ $^\circ C$	
Output noise voltage	$V_N$	$f = 10$ to 100k Hz, $T_A = 25^\circ C$	-	10	-	$\mu V / V_o$	
Ripple rejection	RR	$f = 120Hz$ , $V_{IN} = 8$ to 18V, $I_{OUT} = 500mA$	-	70	-	dB	
Dropout voltage <sup>(9)</sup>	$V_D$	$I_{OUT} = 1A$	-	2.0	-	V	
Output resistance	$R_{OUT}$	$f = 1kHz$	-	10	-	m $\Omega$	
Short circuit current	$I_{SC}$	$V_{IN} = 35V$ , $T_A = 25^\circ C$	-	50	-	mA	
Peak current	$I_{PK}$	$V_{IN} = 10V$	-	2.2	-	A	

**Note:**

(7) Pulse test technology is used to make  $T_J$  as close to  $T_A$  as possible. Thermal effects must be considered separately.

(8)  $\pm 2\%$  for conventional device,  $\pm 1\%$  can be customized.

(9) The difference of output voltage and input voltage when input voltage is decreased gradually till output voltage equals to 95% of  $V_{OUT}$ .

## 7 Specifications

### 7.5 Electrical Characteristics (continued)

**CJ7806B ( $V_{IN} = 11V$ ,  $I_{OUT} = 500mA$ ,  $C_{IN} = 0.33\mu F$ ,  $C_{OUT} = 0.1\mu F$ ,  $T_J = 25^\circ C$ , unless otherwise specified)**

CHARACTERISTIC	SYMBOL	TEST CONDITIONS <sup>(7)</sup>	MIN.	TYP.	MAX.	UNIT	
Output voltage	$V_{OUT}$	$T_J = 25^\circ C$	$\pm 2\%$ grade <sup>(8)</sup>	5.88	6.00	6.12	V
			$\pm 1\%$ grade <sup>(8)</sup>	5.94		6.06	
		$I_{OUT} = 5mA$ to 1A, $V_{IN} = 8.6$ to 21V, $T_J = -40$ to $125^\circ C$ , $P_D \leq 15W$	5.76	6.00	6.24		
Line regulation	$\Delta V_{RLINE}$	$V_{IN} = 8.6$ to 21V, $I_{OUT} = 500mA$	-	25	60	mV	
Load regulation	$\Delta V_{RLOAD}$	$V_{IN} = 11V$ , $I_{OUT} = 5mA$ to 1A	-	20	60	mV	
Quiescent current	$I_Q$	$V_{IN} = 11V$ , $T_J = -40$ to $125^\circ C$ , $I_{OUT} = 0mA$	-	3.2	6.0	mA	
Quiescent current change	$\Delta I_Q$	$V_{IN} = 11V$ , $I_{OUT} = 5mA$ to 1A	-	0.1	0.8	mA	
		$V_{IN} = 8.6$ to 21V, $I_{OUT} = 500mA$	-	0.3	0.8		
Output voltage temperature coefficient	$\Delta V_{OUT} / \Delta T$	-	-	0.5	-	mV/ $^\circ C$	
	$\Delta V_{OUT} / (V_{OUT} \times \Delta T)$		-	80	-	ppm/ $^\circ C$	
Output noise voltage	$V_N$	$f = 10$ to 100k Hz, $T_A = 25^\circ C$	-	10	-	$\mu V / V_O$	
Ripple rejection	RR	$f = 120Hz$ , $V_{IN} = 9.5$ to 19.5V, $I_{OUT} = 500mA$	-	65	-	dB	
Dropout voltage <sup>(9)</sup>	$V_D$	$I_{OUT} = 1A$	-	2.0	-	V	
Output resistance	$R_{OUT}$	$f = 1kHz$	-	10	-	m $\Omega$	
Short circuit current	$I_{SC}$	$V_{IN} = 35V$ , $T_A = 25^\circ C$	-	200	-	mA	
Peak current	$I_{PK}$	$V_{IN} = 11V$	-	2.2	-	A	

**Note:**

(7) Pulse test technology is used to make  $T_J$  as close to  $T_A$  as possible. Thermal effects must be considered separately.

(8)  $\pm 2\%$  for conventional device,  $\pm 1\%$  can be customized.

(9) The difference of output voltage and input voltage when input voltage is decreased gradually till output voltage equals to 95% of  $V_{OUT}$ .

## 7 Specifications

### 7.5 Electrical Characteristics (continued)

CJ7808B ( $V_{IN} = 14V$ ,  $I_{OUT} = 500mA$ ,  $C_{IN} = 0.33\mu F$ ,  $C_{OUT} = 0.1\mu F$ ,  $T_J = 25^\circ C$ , unless otherwise specified)

CHARACTERISTIC	SYMBOL	TEST CONDITIONS <sup>(7)</sup>	MIN.	TYP.	MAX.	UNIT	
Output voltage	$V_{OUT}$	$T_J = 25^\circ C$	$\pm 2\%$ grade <sup>(8)</sup>	7.84	8.00	8.16	V
			$\pm 1\%$ grade <sup>(8)</sup>	7.92	8.00	8.08	
		$I_{OUT} = 5mA$ to $1A$ , $V_{IN} = 10.6V$ to $23V$ , $T_J = -40$ to $125^\circ C$ , $P_D \leq 15W$	7.70	8.00	8.30		
Line regulation	$\Delta V_{RLINE}$	$V_{IN} = 10.6$ to $23V$ , $I_{OUT} = 500mA$	-	25	75	mV	
Load regulation	$\Delta V_{RLOAD}$	$V_{IN} = 14V$ , $I_{OUT} = 5mA$ to $1A$	-	25	75	mV	
Quiescent current	$I_Q$	$V_{IN} = 14V$ , $T_J = -40$ to $125^\circ C$ , $I_{OUT} = 0mA$	-	3.2	6.0	mA	
Quiescent current change	$\Delta I_Q$	$V_{IN} = 14V$ , $I_{OUT} = 5mA$ to $1A$	-	0.1	0.8	mA	
		$V_{IN} = 10.6$ to $23V$ , $I_{OUT} = 500mA$	-	0.3	0.8		
Output voltage temperature coefficient	$\Delta V_{OUT} / \Delta T$	-	-	0.64	-	mV/ $^\circ C$	
	$\Delta V_{OUT} / (V_{OUT} \times \Delta T)$		-	80	-	ppm/ $^\circ C$	
Output noise voltage	$V_N$	$f = 10$ to $100k$ Hz, $T_A = 25^\circ C$	-	10	-	$\mu V / V_O$	
Ripple rejection	RR	$f = 120Hz$ , $V_{IN} = 11.5$ to $21.5V$ , $I_{OUT} = 500mA$	-	62	-	dB	
Dropout voltage <sup>(9)</sup>	$V_D$	$I_{OUT} = 1A$	-	2.0	-	V	
Output resistance	$R_{OUT}$	$f = 1kHz$	-	10	-	m $\Omega$	
Short circuit current	$I_{SC}$	$V_{IN} = 35V$ , $T_A = 25^\circ C$	-	200	-	mA	
Peak current	$I_{PK}$	$V_{IN} = 14V$	-	2.2	-	A	

**Note:**

(7) Pulse test technology is used to make  $T_J$  as close to  $T_A$  as possible. Thermal effects must be considered separately.

(8)  $\pm 2\%$  for conventional device,  $\pm 1\%$  can be customized.

(9) The difference of output voltage and input voltage when input voltage is decreased gradually till output voltage equals to 95% of  $V_{OUT}$ .

## 7 Specifications

### 7.5 Electrical Characteristics (continued)

CJ7809B ( $V_{IN} = 15V$ ,  $I_{OUT} = 500mA$ ,  $C_{IN} = 0.33\mu F$ ,  $C_{OUT} = 0.1\mu F$ ,  $T_J = 25^\circ C$ , unless otherwise specified)

CHARACTERISTIC	SYMBOL	TEST CONDITIONS <sup>(7)</sup>	MIN.	TYP.	MAX.	UNIT	
Output voltage	$V_{OUT}$	$T_J = 25^\circ C$	$\pm 2\%$ grade <sup>(8)</sup>	8.82	9.00	9.18	V
			$\pm 1\%$ grade <sup>(8)</sup>	8.91	9.00	9.09	
		$I_{OUT} = 5mA$ to $1A$ , $V_{IN} = 11.5$ to $23V$ , $T_J = -40$ to $125^\circ C$ , $P_D \leq 15W$	8.65	9.00	9.35		
Line regulation	$\Delta V_{RLINE}$	$V_{IN} = 11.5$ to $23V$ , $I_{OUT} = 500mA$	-	25	90	mV	
Load regulation	$\Delta V_{RLOAD}$	$V_{IN} = 15V$ , $I_{OUT} = 5mA$ to $1A$	-	25	100	mV	
Quiescent current	$I_Q$	$V_{IN} = 15V$ , $T_J = -40$ to $125^\circ C$ , $I_{OUT} = 0mA$	-	3.2	6.0	mA	
Quiescent current change	$\Delta I_Q$	$V_{IN} = 15V$ , $I_{OUT} = 5mA$ to $1A$	-	0.1	0.8	mA	
		$V_{IN} = 11.5$ to $23V$ , $I_{OUT} = 500mA$	-	0.3	0.8		
Output voltage temperature coefficient	$\Delta V_{OUT} / \Delta T$	-	-	0.72	-	mV/ $^\circ C$	
	$\Delta V_{OUT} / (V_{OUT} \times \Delta T)$		-	80	-	ppm/ $^\circ C$	
Output noise voltage	$V_N$	$f = 10$ to $100k$ Hz, $T_A = 25^\circ C$	-	10	-	$\mu V / V_O$	
Ripple rejection	RR	$f = 120Hz$ , $V_{IN} = 11.5$ to $21.5V$ , $I_{OUT} = 500mA$	-	61	-	dB	
Dropout voltage <sup>(9)</sup>	$V_D$	$I_{OUT} = 1A$	-	2.0	-	V	
Output resistance	$R_{OUT}$	$f = 1kHz$	-	10	-	m $\Omega$	
Short circuit current	$I_{SC}$	$V_{IN} = 35V$ , $T_A = 25^\circ C$	-	200	-	mA	
Peak current	$I_{PK}$	$V_{IN} = 15V$	-	2.2	-	A	

**Note:**

(7) Pulse test technology is used to make  $T_J$  as close to  $T_A$  as possible. Thermal effects must be considered separately.

(8)  $\pm 2\%$  for conventional device,  $\pm 1\%$  can be customized.

(9) The difference of output voltage and input voltage when input voltage is decreased gradually till output voltage equals to 95% of  $V_{OUT}$ .

## 7 Specifications

### 7.5 Electrical Characteristics (continued)

**CJ7812B ( $V_{IN} = 19V$ ,  $I_{OUT} = 500mA$ ,  $C_{IN} = 0.33\mu F$ ,  $C_{OUT} = 0.1\mu F$ ,  $T_J = 25^\circ C$ , unless otherwise specified)**

CHARACTERISTIC	SYMBOL	TEST CONDITIONS <sup>(7)</sup>	MIN.	TYP.	MAX.	UNIT	
Output voltage	$V_{OUT}$	$T_J = 25^\circ C$	$\pm 2\%$ grade <sup>(8)</sup>	11.75	12.00	12.25	V
			$\pm 1\%$ grade <sup>(8)</sup>	11.88	12.00	12.12	
		$I_{OUT} = 5mA$ to 1A, $V_{IN} = 14.8$ to 27V, $T_J = -40$ to $125^\circ C$ , $P_D \leq 15W$	11.50	12.00	12.50		
Line regulation	$\Delta V_{RLINE}$	$V_{IN} = 14.8$ to 27V, $I_{OUT} = 500mA$	-	25	120	mV	
Load regulation	$\Delta V_{RLOAD}$	$V_{IN} = 19V$ , $I_{OUT} = 5mA$ to 1A	-	40	120	mV	
Quiescent current	$I_Q$	$V_{IN} = 19V$ , $T_J = -40$ to $125^\circ C$ , $I_{OUT} = 0mA$	-	3.4	6.0	mA	
Quiescent current change	$\Delta I_Q$	$V_{IN} = 19V$ , $I_{OUT} = 5mA$ to 1A	-	0.1	0.8	mA	
		$V_{IN} = 14.8$ to 30V, $I_{OUT} = 500mA$	-	0.3	0.8		
Output voltage temperature coefficient	$\Delta V_{OUT} / \Delta T$	-	-	0.96	-	mV/ $^\circ C$	
	$\Delta V_{OUT} / (V_{OUT} \times \Delta T)$		-	80	-	ppm/ $^\circ C$	
Output noise voltage	$V_N$	$f = 10$ to 100k Hz, $T_A = 25^\circ C$	-	10	-	$\mu V / V_O$	
Ripple rejection	RR	$f = 120Hz$ , $V_{IN} = 15$ to 25V, $I_{OUT} = 500mA$	-	60	-	dB	
Dropout voltage <sup>(9)</sup>	$V_D$	$I_{OUT} = 1A$	-	2.0	-	V	
Output resistance	$R_{OUT}$	$f = 1kHz$	-	11	-	m $\Omega$	
Short circuit current	$I_{SC}$	$V_{IN} = 35V$ , $T_A = 25^\circ C$	-	200	-	mA	
Peak current	$I_{PK}$	$V_{IN} = 18V$	-	2.2	-	A	

**Note:**

(7) Pulse test technology is used to make  $T_J$  as close to  $T_A$  as possible. Thermal effects must be considered separately.

(8)  $\pm 2\%$  for conventional device,  $\pm 1\%$  can be customized.

(9) The difference of output voltage and input voltage when input voltage is decreased gradually till output voltage equals to 95% of  $V_{OUT}$ .

## 7 Specifications

### 7.5 Electrical Characteristics (continued)

**CJ7815B ( $V_{IN} = 23V$ ,  $I_{OUT} = 500mA$ ,  $C_{IN} = 0.33\mu F$ ,  $C_{OUT} = 0.1\mu F$ ,  $T_J = 25^\circ C$ , unless otherwise specified)**

CHARACTERISTIC	SYMBOL	TEST CONDITIONS <sup>(7)</sup>	MIN.	TYP.	MAX.	UNIT	
Output voltage	$V_{OUT}$	$T_J = 25^\circ C$	$\pm 2\%$ grade <sup>(8)</sup>	14.70	15.00	15.30	V
			$\pm 1\%$ grade <sup>(8)</sup>	14.85	15.00	15.15	
		$I_{OUT} = 5mA$ to 1A, $V_{IN} = 17.9$ to 30V, $T_J = -40$ to $125^\circ C$ , $P_D \leq 15W$	14.40	15.00	15.60		
Line regulation	$\Delta V_{RLINE}$	$V_{IN} = 17.9$ to 30V, $I_{OUT} = 500mA$	-	35	150	mV	
Load regulation	$\Delta V_{RLOAD}$	$V_{IN} = 23V$ , $I_{OUT} = 5mA$ to 1A	-	70	150	mV	
Quiescent current	$I_Q$	$V_{IN} = 23V$ , $T_J = -40$ to $125^\circ C$ , $I_{OUT} = 0mA$	-	3.4	6.0	mA	
Quiescent current change	$\Delta I_Q$	$V_{IN} = 23V$ , $I_{OUT} = 5mA$ to 1A	-	0.1	0.8	mA	
		$V_{IN} = 17.9$ to 30V, $I_{OUT} = 500mA$	-	0.3	0.8		
Output voltage temperature coefficient	$\Delta V_{OUT} / \Delta T$	-	-	1.2	-	mV/ $^\circ C$	
	$\Delta V_{OUT} / (V_{OUT} \times \Delta T)$		-	80	-	ppm/ $^\circ C$	
Output noise voltage	$V_N$	$f = 10$ to 100k Hz, $T_A = 25^\circ C$	-	10	-	$\mu V / V_O$	
Ripple rejection	RR	$f = 120Hz$ , $V_{IN} = 18.5$ to 28.5V, $I_{OUT} = 500mA$	-	58	-	dB	
Dropout voltage <sup>(9)</sup>	$V_D$	$I_{OUT} = 1A$	-	2.0	-	V	
Output resistance	$R_{OUT}$	$f = 1kHz$	-	10	-	m $\Omega$	
Short circuit current	$I_{SC}$	$V_{IN} = 35V$ , $T_A = 25^\circ C$	-	200	-	mA	
Peak current	$I_{PK}$	$V_{IN} = 21V$	-	2.2	-	A	

**Note:**

(7) Pulse test technology is used to make  $T_J$  as close to  $T_A$  as possible. Thermal effects must be considered separately.

(8)  $\pm 2\%$  for conventional device,  $\pm 1\%$  can be customized.

(9) The difference of output voltage and input voltage when input voltage is decreased gradually till output voltage equals to 95% of  $V_{OUT}$ .

## 7 Specifications

### 7.5 Electrical Characteristics (continued)

CJ7818B ( $V_{IN} = 27V$ ,  $I_{OUT} = 500mA$ ,  $C_{IN} = 0.33\mu F$ ,  $C_{OUT} = 0.1\mu F$ ,  $T_J = 25^\circ C$ , unless otherwise specified)

CHARACTERISTIC	SYMBOL	TEST CONDITIONS <sup>(7)</sup>	MIN.	TYP.	MAX.	UNIT	
Output voltage	$V_{OUT}$	$T_J = 25^\circ C$	$\pm 2\%$ grade <sup>(8)</sup>	17.64	18.00	18.36	V
			$\pm 1\%$ grade <sup>(8)</sup>	17.82	18.00	18.18	
		$I_{OUT} = 5mA$ to 1A, $V_{IN} = 21$ to 33V, $T_J = -40$ to $125^\circ C$ , $P_D \leq 15W$	17.30	18.00	18.70		
Line regulation	$\Delta V_{RLINE}$	$V_{IN} = 21$ to 33V, $I_{OUT} = 500mA$	-	45	180	mV	
Load regulation	$\Delta V_{RLOAD}$	$V_{IN} = 27V$ , $I_{OUT} = 5mA$ to 1A	-	85	180	mV	
Quiescent current	$I_Q$	$V_{IN} = 27V$ , $T_J = -40$ to $125^\circ C$ , $I_{OUT} = 0mA$	-	3.6	6.0	mA	
Quiescent current change	$\Delta I_Q$	$V_{IN} = 27V$ , $I_{OUT} = 5mA$ to 1A	-	0.1	0.8	mA	
		$V_{IN} = 21$ to 33V, $I_{OUT} = 500mA$	-	0.3	0.8		
Output voltage temperature coefficient	$\Delta V_{OUT} / \Delta T$	-	-	1.44	-	mV/ $^\circ C$	
	$\Delta V_{OUT} / (V_{OUT} \times \Delta T)$		-	80	-	ppm/ $^\circ C$	
Output noise voltage	$V_N$	$f = 10$ to 100k Hz, $T_A = 25^\circ C$	-	10	-	$\mu V / V_O$	
Ripple rejection	RR	$f = 120Hz$ , $V_{IN} = 22$ to 32V, $I_{OUT} = 500mA$	-	57	-	dB	
Dropout voltage <sup>(9)</sup>	$V_D$	$I_{OUT} = 1A$	-	2.0	-	V	
Output resistance	$R_{OUT}$	$f = 1kHz$	-	10	-	m $\Omega$	
Short circuit current	$I_{SC}$	$V_{IN} = 35V$ , $T_A = 25^\circ C$	-	200	-	mA	
Peak current	$I_{PK}$	$V_{IN} = 24V$	-	2.2	-	A	

**Note:**

(7) Pulse test technology is used to make  $T_J$  as close to  $T_A$  as possible. Thermal effects must be considered separately.

(8)  $\pm 2\%$  for conventional device,  $\pm 1\%$  can be customized.

(9) The difference of output voltage and input voltage when input voltage is decreased gradually till output voltage equals to 95% of  $V_{OUT}$ .



7 Specifications

7.6 Typical Characteristics

CJ7800B Series ( $C_{IN} = 0.33\mu F$ ,  $C_{OUT} = 0.1\mu F$ ,  $T_J = 25^\circ C$ , unless otherwise specified)

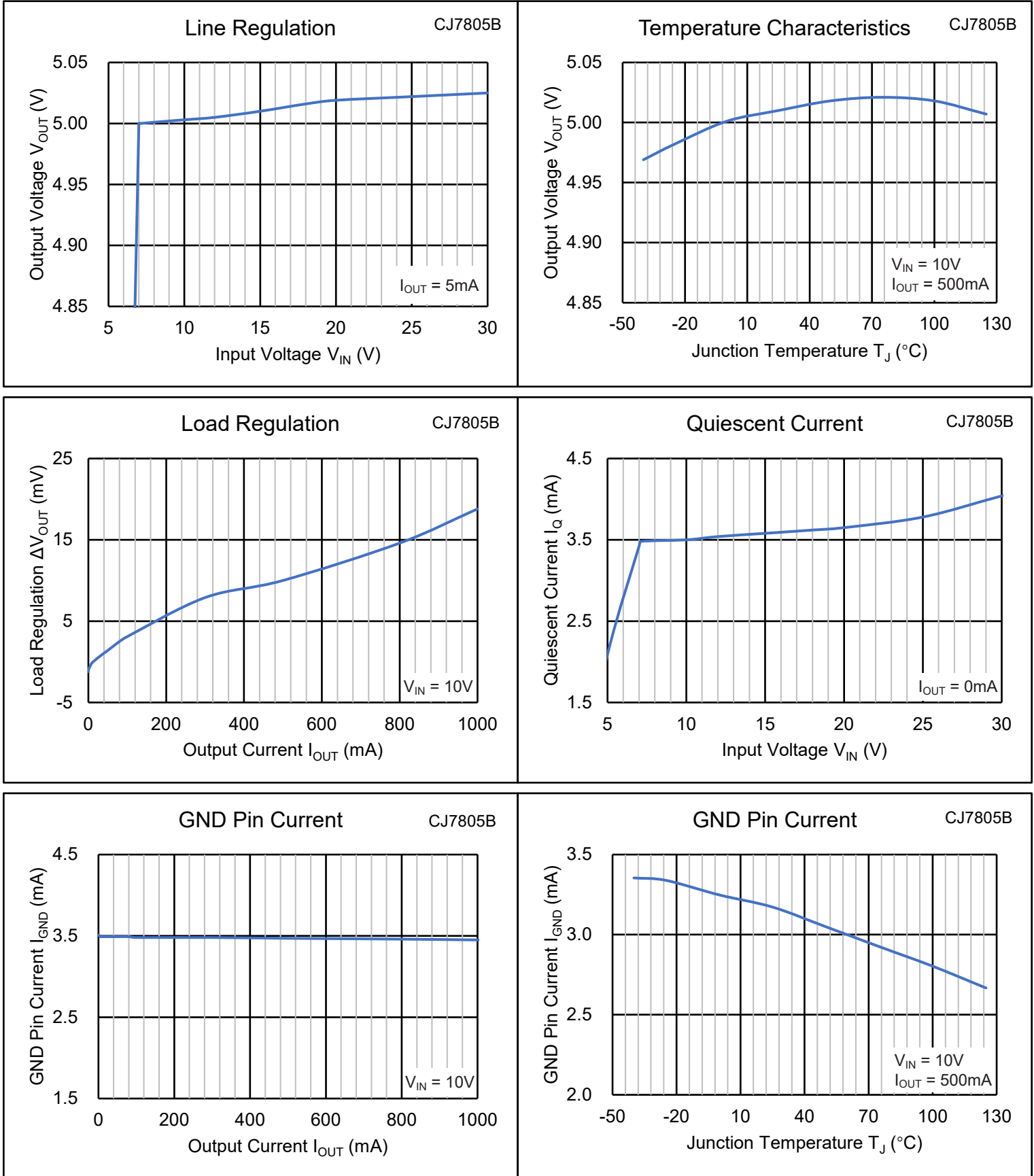

## 7 Specifications

### 7.6 Typical Characteristics (continued)

CJ7800B Series ( $C_{IN} = 0.33\mu\text{F}$ ,  $C_{OUT} = 0.1\mu\text{F}$ ,  $T_J = 25^\circ\text{C}$ , unless otherwise specified)

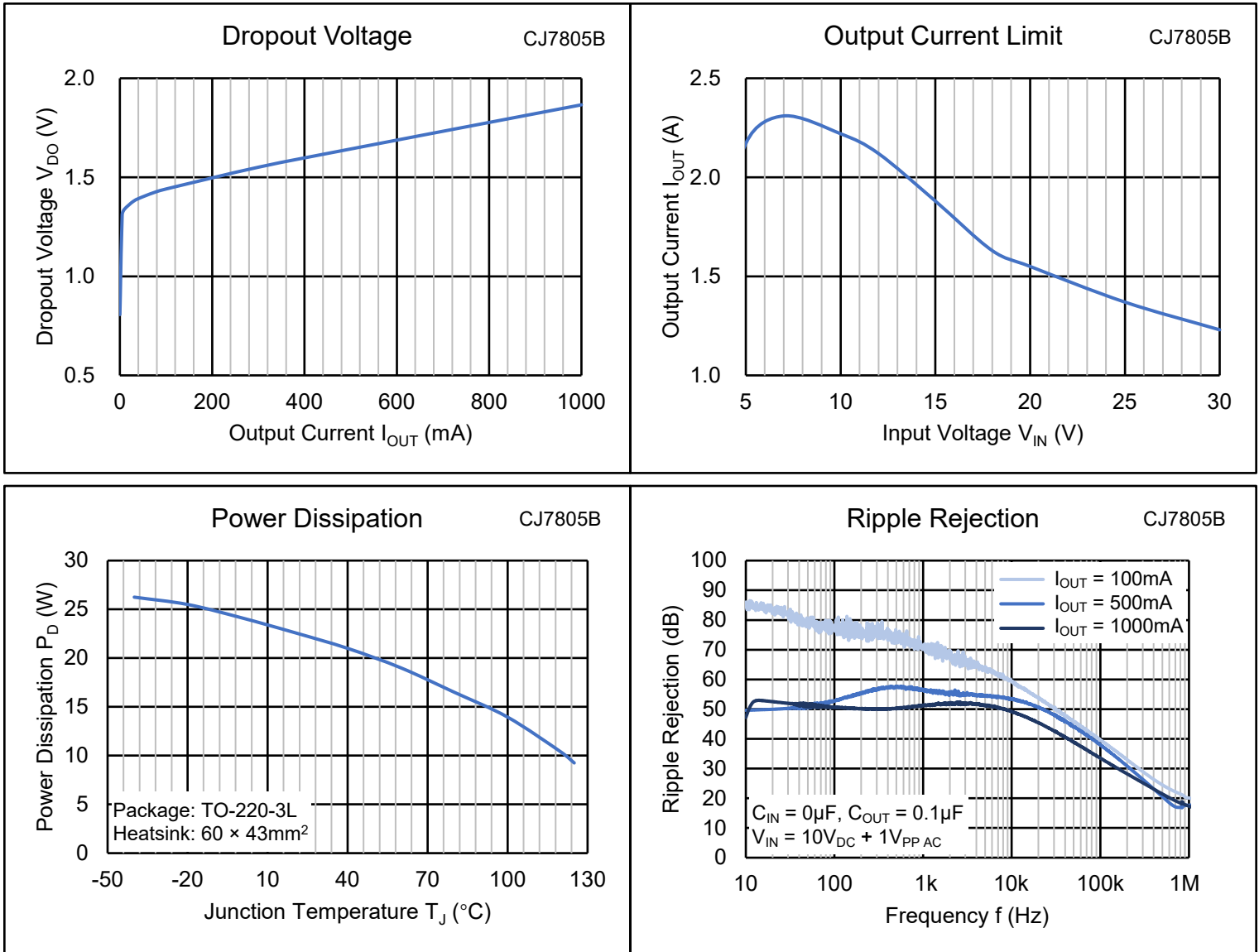

### Load Transient

CJ7805B,  $V_{IN} = 10\text{V}$ , CH<sub>2</sub>:  $V_{OUT}$ , CH<sub>4</sub>:  $I_{OUT}$

$I_{OUT} = 10$  to  $500\text{mA}$

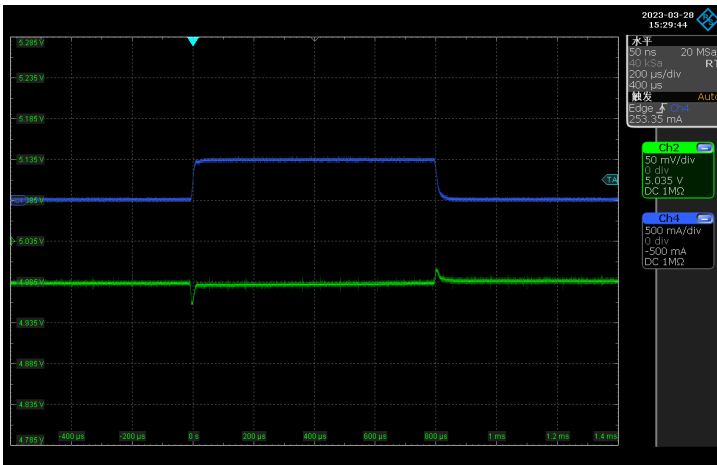

$I_{OUT} = 10$  to  $1000\text{mA}$

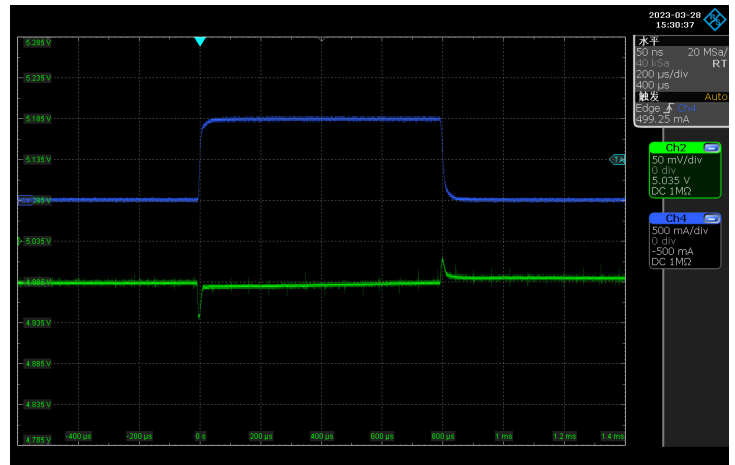

## 8 Detailed Description

### 8.1 Description

The CJ7800B series is a group of fixed output positive voltage regulators. It integrates built-in current limit, short-circuit protection, thermal overload protection and safe operating area protection of output transistor, which makes it relatively difficult to be damaged. By setting the resistance value of peripheral resistance, the CJ7800B series can also be used as adjustable voltage output regulator.

### 8.2 Representative Schematic Diagram

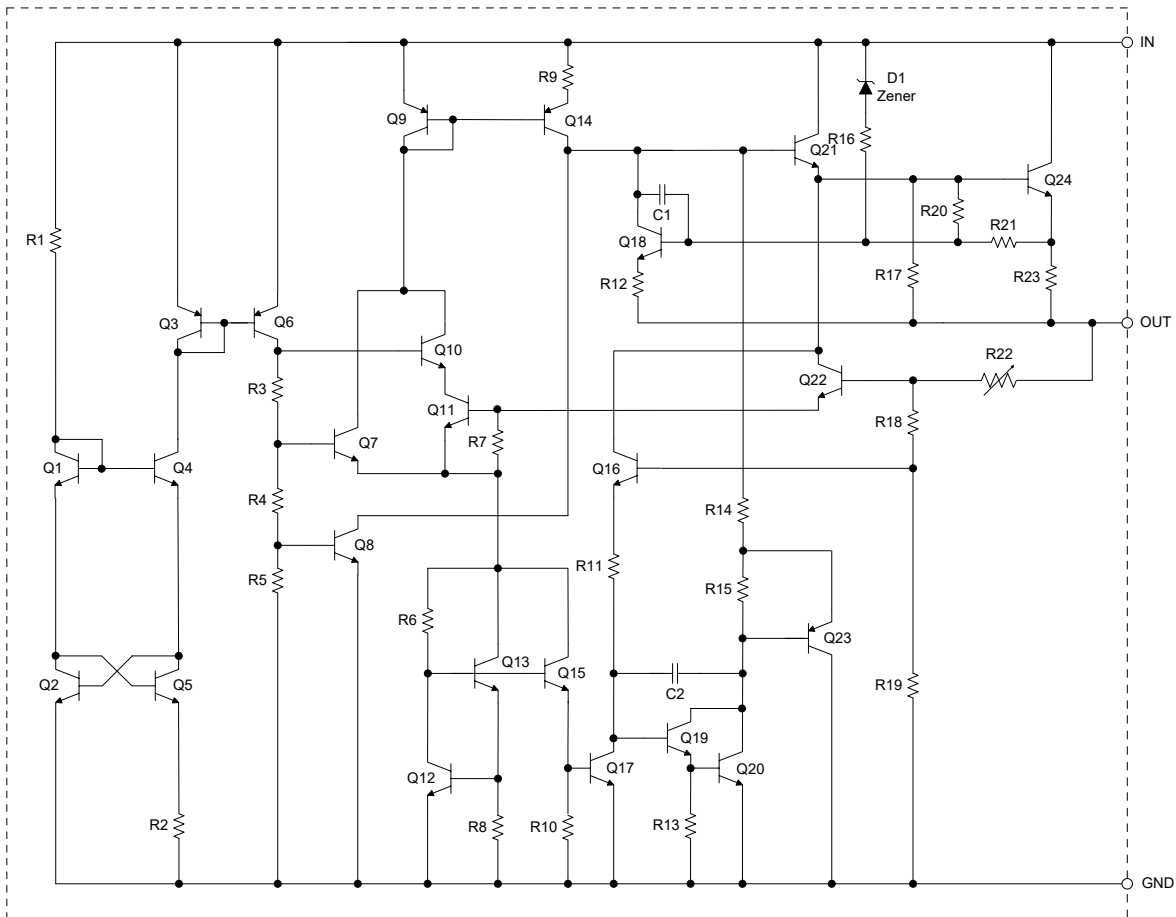

### 8.3 Feature Description

#### Input Voltage

When the input voltage is lower than the rated range of the data sheet, the device will lose the regulation function of stabilizing the output voltage, that is, it is unable to maintain the output voltage within the rated range. When the input voltage is higher than the rated range of the data sheet, the device may cause irreversible damage or failure due to exceeding the maximum rated range of electrical stress.

#### Built-in Current Limit & Short Circuit Protection

The CJ7800B series has built-in current limit and short circuit protection. When the output current of the device is too high, the output of the device will be shut down. When the output of the device is short circuited to ground, the output of the device will also be shut down and the output current will be maintained within a certain range. The typical current limits for the CJ7800B series is 2.2A.

## 8 Detailed Description

### 8.3 Feature Description (continued)

#### Thermal Shutdown Protection

The CJ7800B series has thermal shutdown protection. When the junction temperature exceeds the rated temperature range for normal operation in the data sheet, the device will enter the thermal shutdown state. At this time, the output voltage of the device will be reduced to prevent catastrophic damage to the chip due to accidental heat. When the junction temperature decreases and no longer remains too high, the device will release the thermal shutdown and output normally. To ensure reliable operation, please limit the junction temperature to the specified range of recommended operating conditions in the data sheet. Applications that exceed the recommended temperature range may cause the device to exceed its operating specifications.

Although the internal protection circuitry of the device is designed to protect against thermal overall conditions, this circuitry is not intended to replace proper heat sinking. Continuously running the device into thermal shutdown or above the maximum recommended junction temperature reduces long-term reliability.

#### Output Current

Due to the internal integration of thermal shutdown protection, in the case of large output current, the device may enter the thermal shutdown state because the junction temperature is higher than the rated value in the data sheet. Therefore, the appropriate package should be selected for circuit design according to the heat dissipation power consumption of the package and the effective connection thermal resistance with the environment, so as to make the device emit more heat energy, so as to ensure the maximum load current capacity of the device. If the circuit design is appropriate and the device has good heat dissipation conditions, the CJ7800B series can output a current of up to 1A.

## 9 Application and Implementation

### 9.1 Risk Alert and Precautions

The CJ7800B series is designed with thermal protection, output short circuit protection and output transistor SOA protection. However, like any IC regulator, precautions are necessary to reduce the possibility of accidental damage to the regulator. The following describes the possible causes of unit damage or failure:

#### Electrostatic Discharge (ESD) and Instantaneous Electrical Surge

Electrostatic discharge (ESD) is a common near-field hazard source. It comes from many sources, such as human body, mechanical equipment and electronic components themselves. ESD can cause phenomena such as high voltage and instantaneous high current in a very short time, resulting in damage or failure of the device due to electric shock.

In some applications, a short duration but high energy spike may occur in the circuit, including peak voltage and surge current. They may cause unstable operation of the regulator, accelerated aging and potential hazards, and even damage or malfunction of the regulator. These peaks are usually more likely to occur in hot-plug, switch inductance, heavy-load, and other types of circuits.

#### Precautions for ESD and Electrical Surge

In the practical application of the circuit, adopting the following suggestions can reduce the possibility of device failure due to the above reasons to a certain extent.

Using TVS:

Place a TVS between the IN and GND of the voltage regulator to absorb the peak voltage that may be generated due to ESD or other reasons. As shown in Figure 9-4;

Using Input Resistor:

Place a resistor with appropriate resistance in series before the IN of the voltage regulator, which can help the voltage regulator share part of the energy in case of surge. The resistance value of the resistance should not be too large. The specific resistance value depends on the application of the circuit. Generally, the resistance value of this resistance does not exceed  $20\Omega$ . As shown in Figure 9-5;

Using Electrolytic Capacitor:

For the application circuit using the low ESR multilayer ceramic capacitor (MLCC) type input capacitor, the LC resonant voltage spike caused by hot plugging or power transmission line inductance can be suppressed by using RC suppression circuit for parallel connection of the input capacitor. A very simple method is to parallel a suitable electrolytic capacitor to the input capacitor. As shown in Figure 9-6. For most  $100\mu\text{F}/25\text{V}$  electrolytic capacitor has an ESR of about  $0.2\Omega$  at  $100\text{kHz}$ . This can completely suppress the overshoot phenomenon of the input and minimize the possibility of IC damage due to input voltage spikes.

Figure 9-1 and Figure 9-2 show the impact of not using electrolytic capacitor [Test circuit is shown in Figure 9-3 ] and using  $100\mu\text{F}/25\text{V}$  electrolytic capacitor parallel to the input capacitor [Test circuit is shown in Figure 9-6 ] on suppressing surge voltage. As shown in Figure 9-1., when the input is powered on from 0 to 10V, a peak voltage of up to 20V (shown in the RED part) is generated in front of the input terminal of the device. When the electrolytic capacitor is used, as shown in Figure 9-2., the peak voltage generated by power on is effectively suppressed (shown in the GREEN part).

## 9 Application and Implementation

### 9.1 Risk Alert and Precautions (continued)

Test Condition: CJ7805B,  $C_{IN} = 10\mu\text{F}$  (MLCC),  $C_{OUT} = 100\mu\text{F}$ ,  $V_{IN} = 0 \sim 10\text{V}$ ,  $I_{OUT} = 100\text{mA}$ , CH<sub>1</sub>:  $V_{IN}$ , CH<sub>2</sub>:  $V_{OUT}$ .

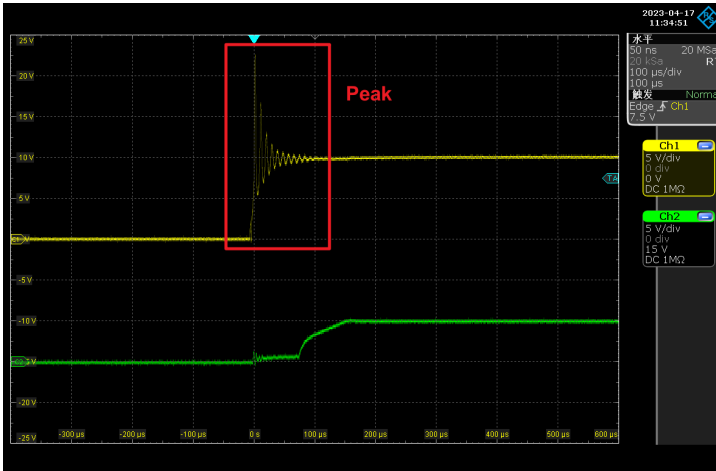

Figure 9-1. Test with the conventional circuit

[Test Circuit is shown in Figure 9-3]

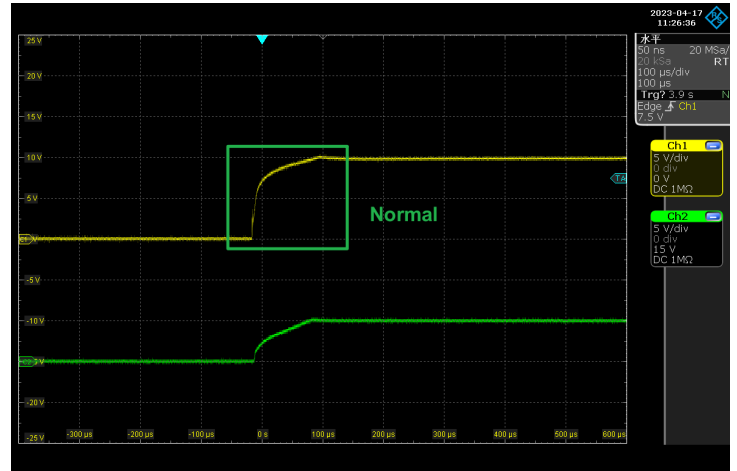

Figure 9-2. Test with the circuit that a  $100\mu\text{F}/25\text{V}$  electrolytic capacitor parallel to the  $C_{IN}$   
[Test Circuit is shown in Figure 9-6]

For the CJ7800B series, it is recommended that the input peak voltage should not exceed 36V. When the input voltage of the operating circuit may not meet the application conditions described above, it is recommended to adopt the circuit layout shown in Figure 9-5 in the circuit design.

### Large Output Capacitance

The CJ7800B series can obtain better transient response with the help of output capacitance. However, if the output capacitor is relatively large, the surge current generated by the charging of the output capacitor will also be large at the moment of power on of the regulator, and the large surge current passing through the regulator may damage the internal circuit. When the output capacitance is large, adopting the circuit design shown in Figure 9-5 will reduce the possibility of damage to the device due to large surge current to a certain extent. It is recommended that the selection of output capacitor should not exceed  $20\mu\text{F}$ . If the selection of output capacitor exceeds  $20\mu\text{F}$ , it is recommended to adopt the circuit design in Figure 9-5 to reduce the possibility of accidental failure of the device due to large surge current during power on.

### 9.2 Typical Application Circuits

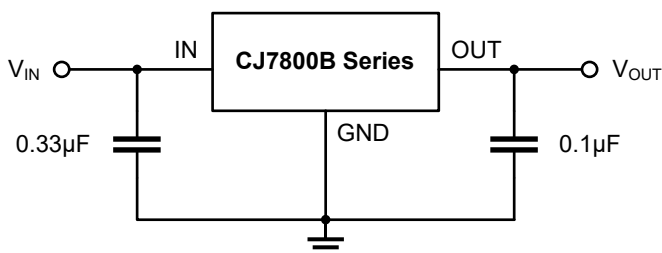

Figure 9-3. Conventional Circuit

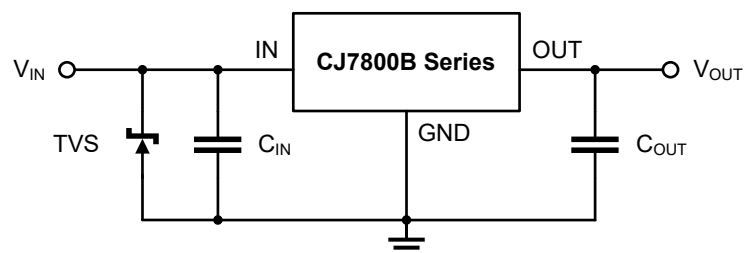

Figure 9-4. TVS is used at IN

## 9 Application and Implementation

### 9.2 Typical Application Circuits (continued)

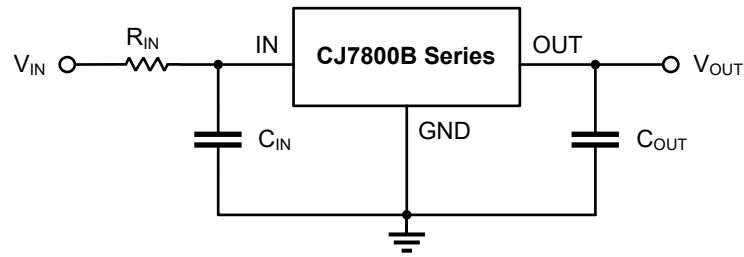

Figure 9-5. Resistance is used at IN

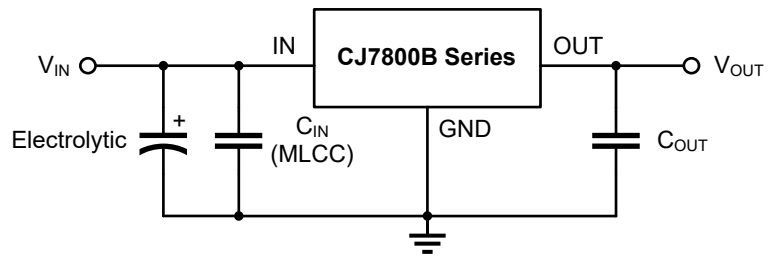

Figure 9-6. Electrolytic capacitor is used at IN

### 9.3 Bypass Capacitance Selection

A capacitance between IN and GND ( $C_{IN}$ ) is required if the regulator is located far from the power supply filter. It is recommended to use a  $0.33\mu\text{F}$  capacitor for  $C_{IN}$ , and the  $C_{IN}$  should be placed as close to the device IN pin and GND pin as possible.

It is recommended to use a  $0.1\mu\text{F}$  capacitor between OUT and GND ( $C_{OUT}$ ), and the  $C_{OUT}$  should be placed as close as possible between OUT and GND. The output capacitance can limit the high-frequency noise and help the device obtain the best stability and transient response.

The tolerance and temperature coefficient of the  $C_{IN}$  and  $C_{OUT}$  must be considered to ensure that the capacitor can work normally within the rated working ambient temperature and rated working conditions of the device.

It is recommended that the  $C_{OUT}$  should not exceed  $20\mu\text{F}$ . When the  $C_{OUT}$  exceeds  $20\mu\text{F}$ , it is recommended to use the circuit layout shown in Figure 9-2. See *Large Output Capacitance* for more details.

### 9.4 Design Requirements and Procedure

The CJ7800B series is mainly used to provide fixed output voltage regulation, the output voltage is selected based on the device variant, which is available in 5.0V, 6.0V, 8.0V, 9.0V, 12V, 15V and 18V regulator options, and it requires a very small number of device components. If the regulator is far from the power filter, the input capacitor  $C_{IN}$  is required. The bypass capacitor  $C_{OUT}$  is used at the output to obtain the best stability and transient response. These capacitors must be as close to the regulator as possible.

### 9.5 Power Supply Recommendation

The linear regulator input supply must be well regulated and kept at a voltage level to not exceed the maximum input to output voltage differential allowed by the device. The minimum dropout voltage ( $V_{DO}$ ) must be met with extra headroom when possible to keep the output well regulated.

For the best overall performance, some layout guidelines may be disregarded. Place all circuit components on the same side of the circuit board and as near as practical to the respective linear regulator pins. Traces must be kept short and wide to reduce the amount of parasitic elements in the system. The actual width and thickness of traces depends on the current carrying capability and heat dissipation required by the end system.

#### NOTE

The application information in this section is not part of the data sheet component specification, and JSCJ makes no commitment or statement to guarantee its accuracy or completeness. Customers are responsible for determining the rationality of corresponding components in their circuit design and making tests and verifications to ensure the normal realization of their circuit design.

10 Mechanical Information

10.1 TO-220-3L Mechanical Information

TO-220-3L Outline Dimensions

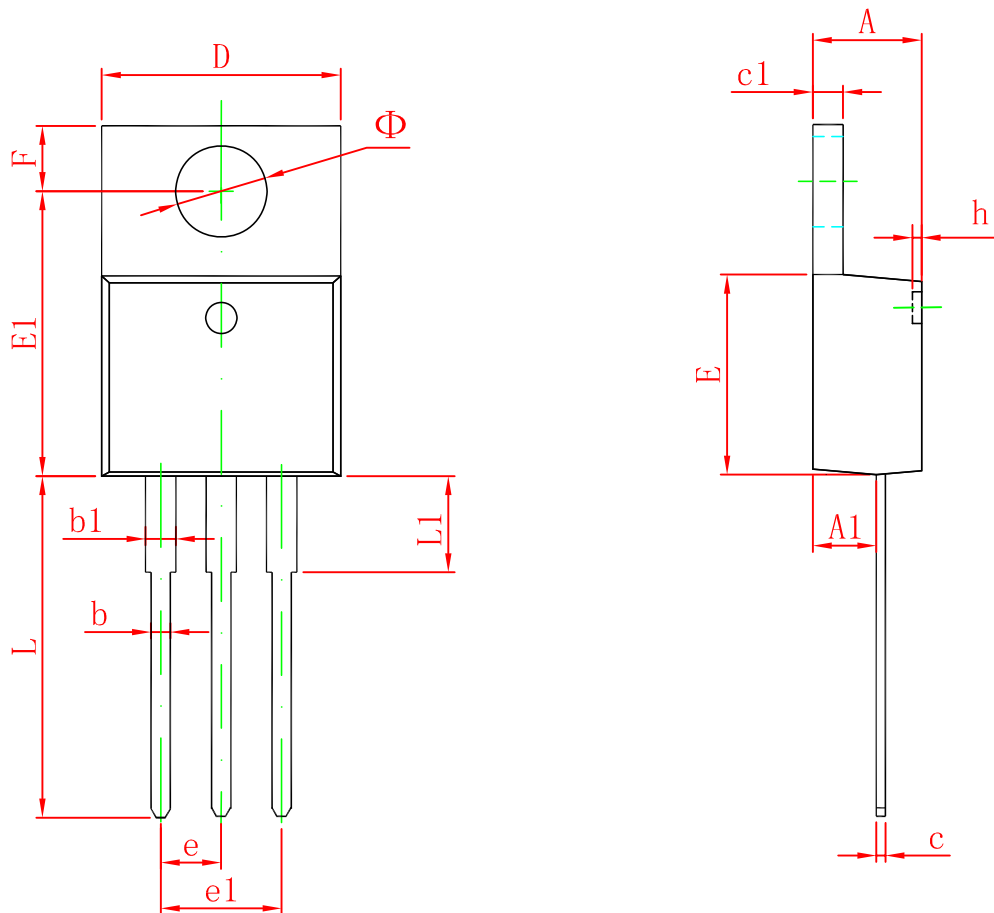

Symbol	Dimensions In Millimeters		Dimensions In Inches	
	Min	Max	Min	Max
A	4.470	4.670	0.176	0.184
A1	2.520	2.820	0.099	0.111
b	0.710	0.910	0.028	0.036
b1	1.170	1.370	0.046	0.054
c	0.310	0.530	0.012	0.021
c1	1.170	1.370	0.046	0.054
D	10.010	10.310	0.394	0.406
E	8.500	8.900	0.335	0.350
E1	12.060	12.460	0.475	0.491
e	2.540 TYP		0.100 TYP	
e1	4.980	5.180	0.196	0.204
F	2.590	2.890	0.102	0.114
h	0.000	0.300	0.000	0.012
L	13.400	13.800	0.528	0.543
L1	3.560	3.960	0.140	0.156
$\Phi$	3.735	3.935	0.147	0.155



10 Mechanical Information

10.2 TO-220F Mechanical Information

TO-220F Outline Dimensions

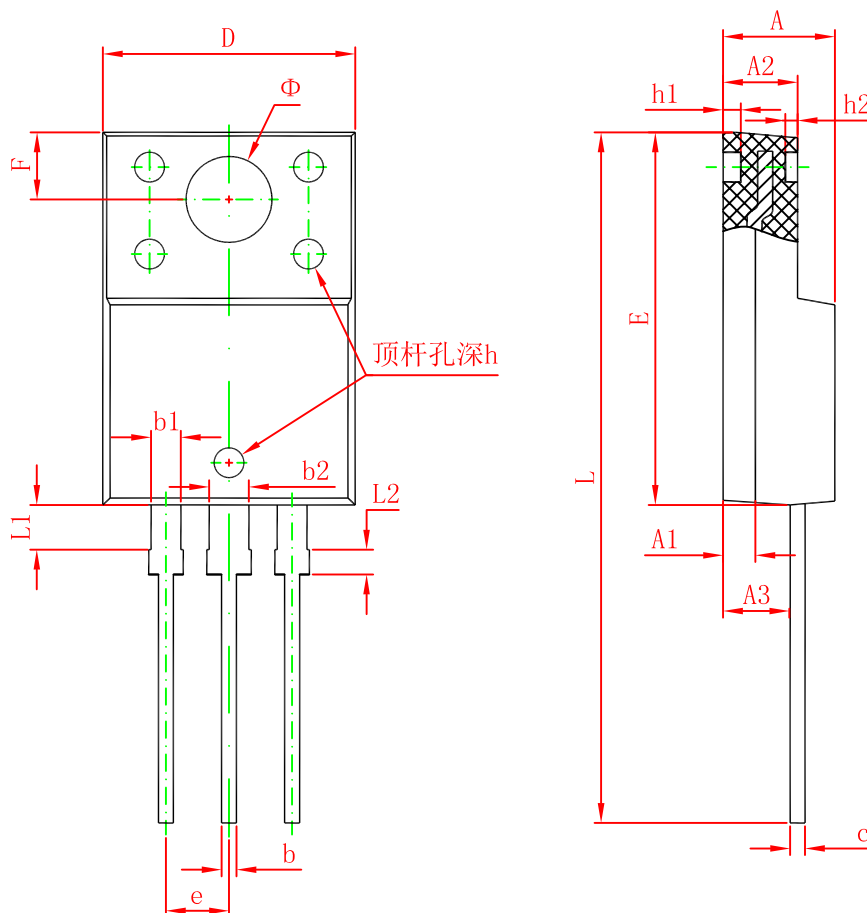

Symbol	Dimensions In Millimeters		Dimensions In Inches	
	Min.	Max.	Min.	Max.
A	4.300	4.700	0.169	0.185
A1	1.300 REF.		0.051 REF.	
A2	2.800	3.200	0.110	0.126
A3	2.500	2.900	0.098	0.114
b	0.500	0.750	0.020	0.030
b1	1.100	1.350	0.043	0.053
b2	1.500	1.750	0.059	0.069
c	0.500	0.750	0.020	0.030
D	9.960	10.360	0.392	0.408
E	14.800	15.200	0.583	0.598
e	2.540 TYP.		0.100 TYP.	
F	2.700 REF.		0.106 REF.	
$\Phi$	3.500 REF.		0.138 REF.	
h	0.000	0.300	0.000	0.012
h1	0.800 REF.		0.031 REF.	
h2	0.500 REF.		0.020 REF.	
L	28.000	28.400	1.102	1.118
L1	1.700	1.900	0.067	0.075
L2	0.900	1.100	0.035	0.043

10 Mechanical Information

10.3 TO-251-3L Mechanical Information

TO-251-3L Outline Dimensions

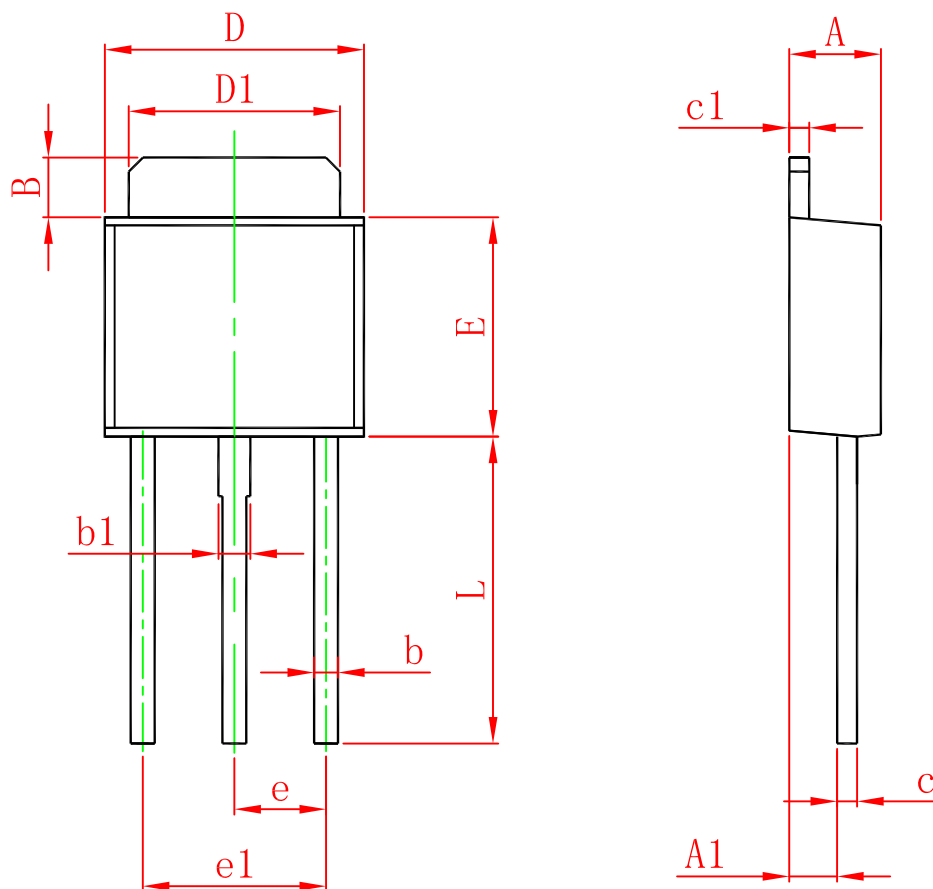

Symbol	Dimensions In Millimeters		Dimensions In Inches	
	Min.	Max.	Min.	Max.
A	2.200	2.400	0.087	0.094
A1	1.050	1.350	0.042	0.054
B	1.350	1.650	0.053	0.065
b	0.500	0.700	0.020	0.028
b1	0.700	0.900	0.028	0.035
c	0.430	0.580	0.017	0.023
c1	0.430	0.580	0.017	0.023
D	6.350	6.650	0.250	0.262
D1	5.200	5.400	0.205	0.213
E	5.400	5.700	0.213	0.224
e	2.300 TYP.		0.091 TYP.	
e1	4.500	4.700	0.177	0.185
L	7.500	7.900	0.295	0.311

10 Mechanical Information

10.4 TO-251S Mechanical Information

TO-251S Outline Dimensions

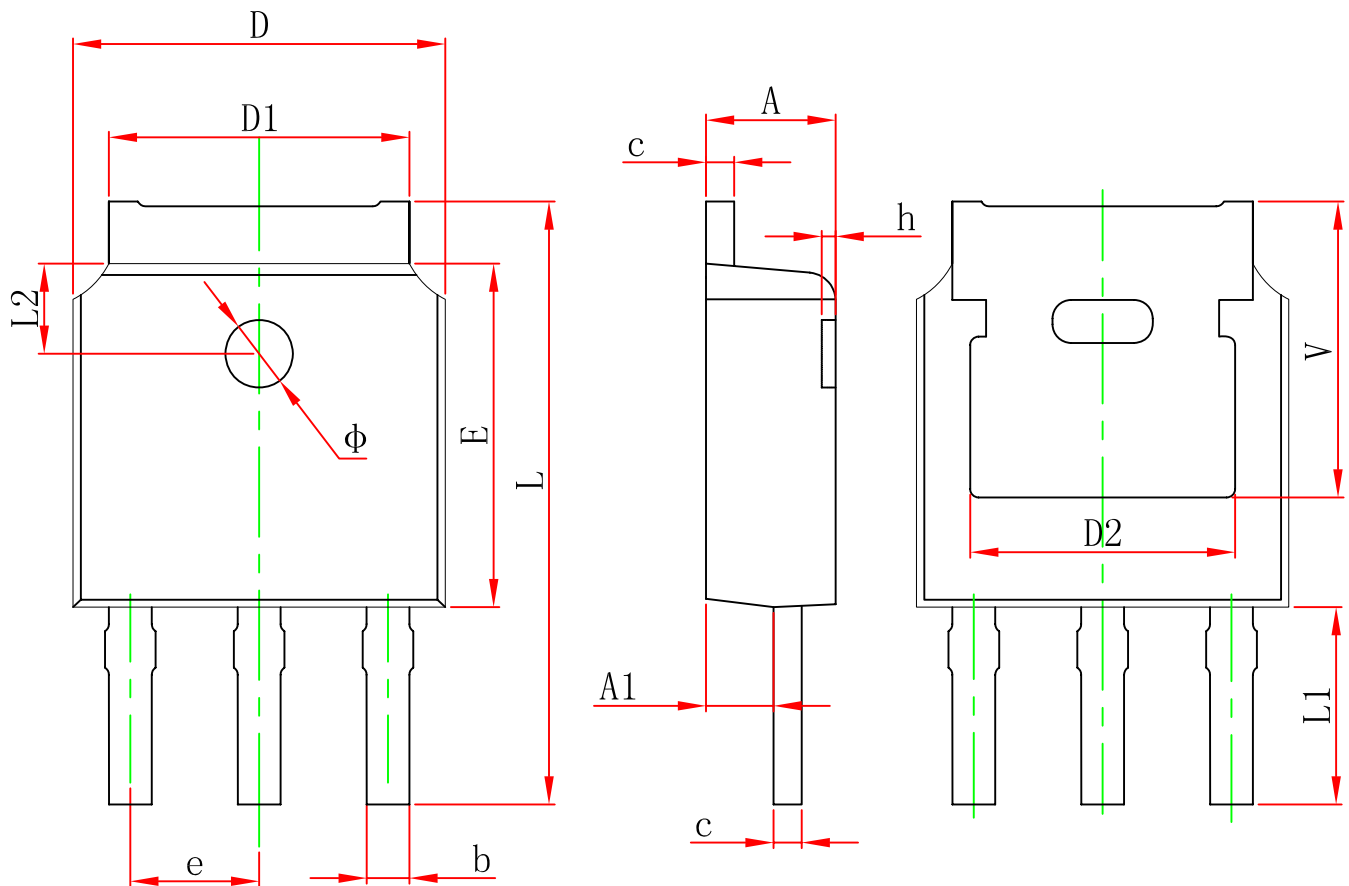

Symbol	Dimensions In Millimeters		Dimensions In Inches	
	Min.	Max.	Min.	Max.
A	2.200	2.400	0.087	0.094
A1	0.860	1.160	0.034	0.046
b	0.660	0.860	0.026	0.034
c	0.460	0.580	0.018	0.023
D	6.500	6.700	0.256	0.264
D1	5.100	5.460	0.201	0.215
D2	4.830 REF.		0.190 REF.	
E	6.000	6.200	0.236	0.244
e	2.186	2.386	0.086	0.094
L	10.400	11.000	0.409	0.433
L1	3.300	3.700	0.130	0.146
L2	1.600 REF.		0.063 REF.	
φ	1.100	1.300	0.043	0.051
h	0.000	0.300	0.000	0.012
V	5.350 REF.		0.211 REF.	

10 Mechanical Information

10.5 TO-252-2L Mechanical Information

TO-252-2L Outline Dimensions

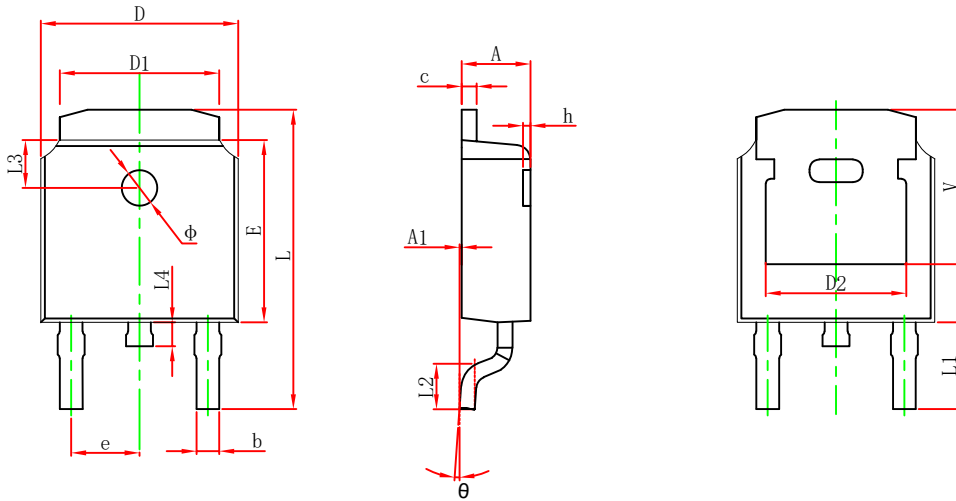

Symbol	Dimensions In Millimeters		Dimensions In Inches	
	Min.	Max.	Min.	Max.
A	2.200	2.400	0.087	0.094
A1	0.000	0.127	0.000	0.005
b	0.635	0.770	0.025	0.030
c	0.460	0.580	0.018	0.023
D	6.500	6.700	0.256	0.264
D1	5.100	5.460	0.201	0.215
D2	4.830 REF.		0.190 REF.	
E	6.000	6.200	0.236	0.244
e	2.186	2.386	0.086	0.094
L	9.712	10.312	0.382	0.406
L1	2.900 REF.		0.114 REF.	
L2	1.400	1.700	0.055	0.067
L3	1.600 REF.		0.063 REF.	
L4	0.600	1.000	0.024	0.039
phi	1.100	1.300	0.043	0.051
theta	0°	8°	0°	8°
h	0.000	0.300	0.000	0.012
V	5.250 REF.		0.207 REF.	

TO-252-2L Suggest Pad Layout

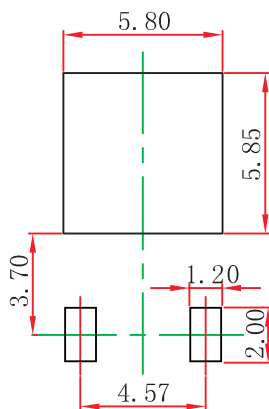

NOTE:

1. Controlling dimension: in millimeters.
2. General tolerance: ±0.05mm.
3. The pad layout is for reference purposes only.

10 Mechanical Information

10.6 TO-263-2L Mechanical Information

TO-263-2L Outline Dimensions

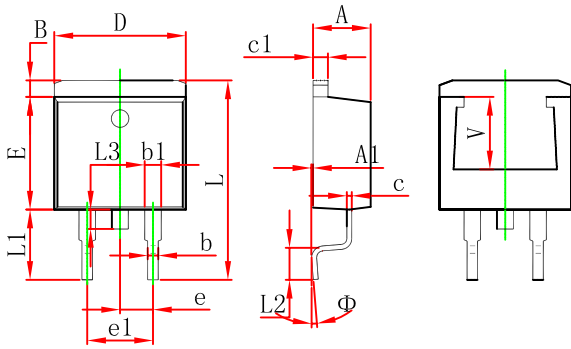

Symbol	Dimensions In Millimeters		Dimensions In Inches	
	Min.	Max.	Min.	Max.
A	4.470	4.670	0.176	0.184
A1	0.000	0.150	0.000	0.006
B	1.120	1.420	0.044	0.056
b	0.710	0.910	0.028	0.036
b1	1.170	1.370	0.046	0.054
c	0.310	0.530	0.012	0.021
c1	1.170	1.370	0.046	0.054
D	10.010	10.310	0.394	0.406
E	8.500	8.900	0.335	0.350
e	2.540 TYP.		0.100 TYP.	
e1	4.980	5.180	0.196	0.204
L	14.940	15.500	0.588	0.610
L1	4.950	5.450	0.195	0.215
L2	2.340	2.740	0.092	0.108
L3	1.300	1.700	0.051	0.067
Φ	0°	8°	0°	8°
V	5.600 REF.		0.220 REF.	

TO-263-2L Suggest Pad Layout

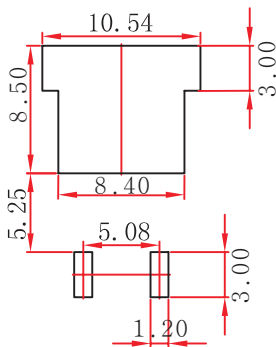

NOTE:

1. Controlling dimension: in millimeters.
2. General tolerance: ±0.05mm.
3. The pad layout is for reference purposes only.

# 11 Packaging Information

## 11.1 TO-252-2L Tape and Reel Information

### TO-252-2L Embossed Carrier Tape

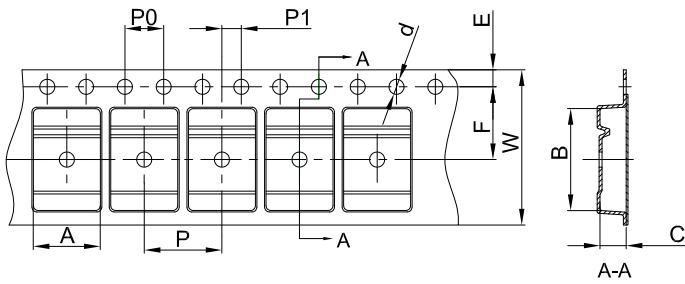

**Packaging Description:**  
 TO-252 parts are shipped in tape. The carrier tape is made from a dissipative (carbon filled) polycarbonate resin. The cover tape is a multilayer film (Heat Activated Adhesive in nature) primarily composed of polyester film, adhesive layer, sealant, and anti-static sprayed agent. These reeled parts in standard option are shipped with 25,00 units per 13" or 33.0 cm diameter reel. The reels are clear in color and is made of polystyrene plastic (anti-static coated).

Dimensions are in millimeter										
Pkg type	A	B	C	d	E	F	P0	P	P1	W
TO-252	6.90	10.50	2.70	Ø1.55	1.75	7.50	4.00	8.00	2.00	16.00

### TO-252-2L Tape Leader and Trailer

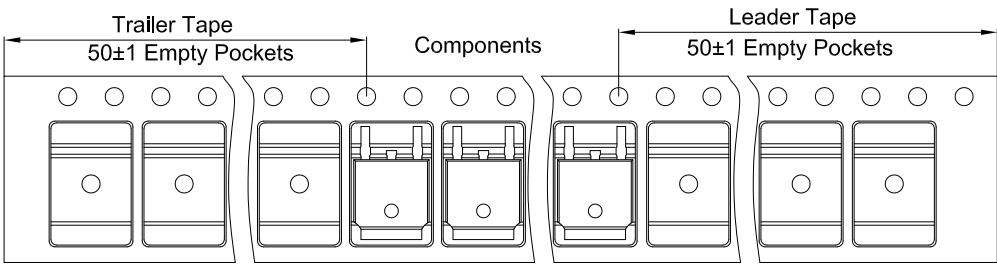

### TO-252-2L Reel

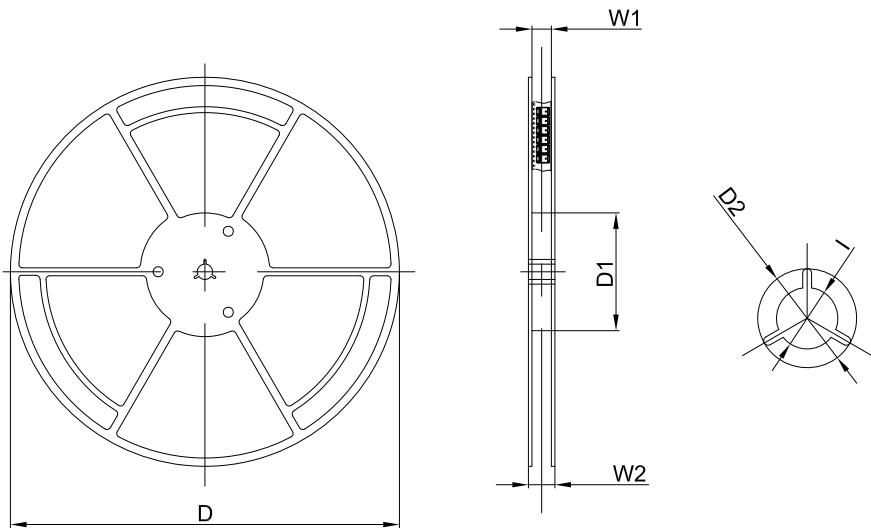

Dimensions are in millimeter						
Reel Option	D	D1	D2	W1	W2	I
13" Dia	330.00	100.00	Ø21.00	16.40	21.00	Ø13.00

REEL	Reel Size	Box	Box Size(mm)	Carton	Carton Size(mm)	G.W.(kg)
2,500 pcs	13inch	2,500 pcs	340×336×29	25,000 pcs	353×346×365	

## 11 Packaging Information

### 11.2 TO-263-2L Tape and Reel Information

#### TO-263-2L Embossed Carrier Tape

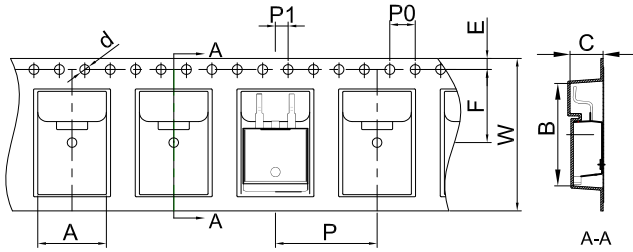

**Packaging Description:**  
 TO-263-2L parts are shipped in tape. The carrier tape is made from a dissipative (carbon filled) polycarbonate resin. The cover tape is a multilayer film (Heat Activated Adhesive in nature) primarily composed of polyester film, adhesive layer, sealant, and anti-static sprayed agent. These reeled parts in standard option are shipped with 800 units per 13" or 33.0 cm diameter reel. The reels are clear in color and is made of polystyrene plastic (anti-static coated).

Dimensions are in millimeter										
Pkg type	A	B	C	d	E	F	P0	P	P1	W
TO-263-2L	10.80	16.13	5.21	Ø1.55	1.75	11.50	4.00	16.00	2.00	24.00

#### TO-263-2L Tape Leader and Trailer

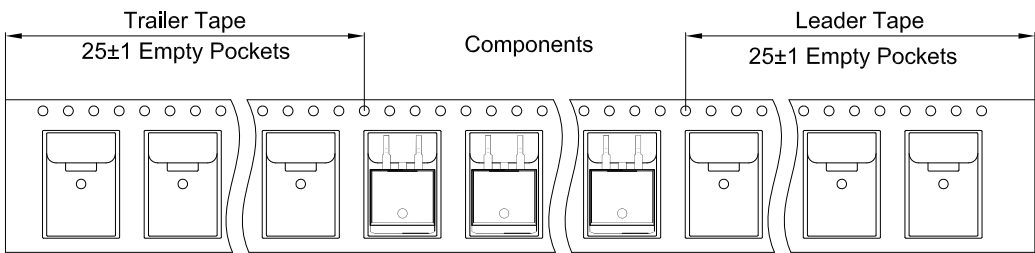

#### TO-263-2L Reel

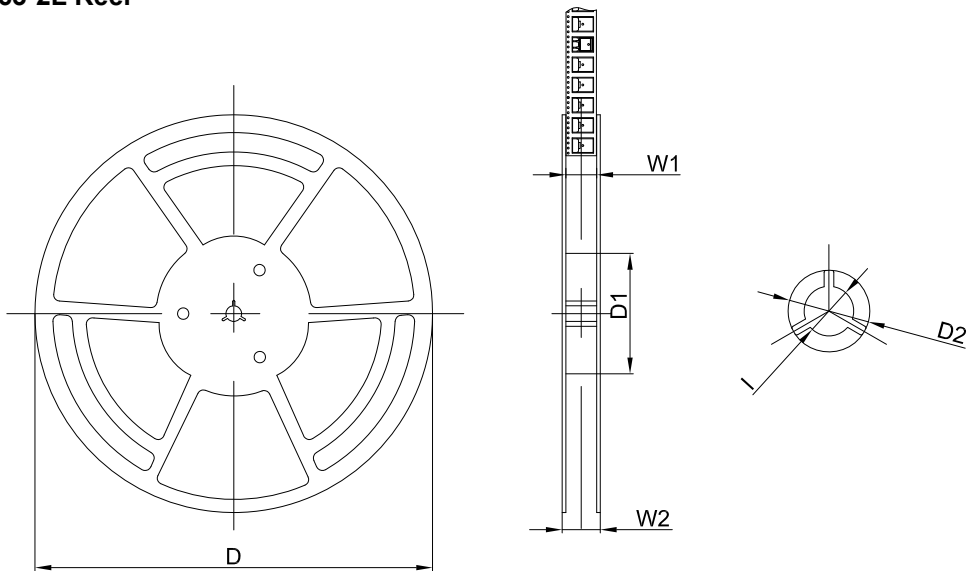

Dimensions are in millimeter						
Reel Option	D	D1	D2	W1	W2	I
13" Dia	Ø330.00	100.00	Ø21.00	24.4	30.4	Ø13.00

REEL	Reel Size	Box	Box Size(mm)	Carton	Carton Size(mm)	G.W.(kg)
800 pcs	13 inch	800 pcs	340×336×36	8,000 pcs	400×353×365	

## 12 Notes and Revision History

### 12.1 Associated Product Family and Others

To view other products of the same type or IC products of other types, please click the official website of JSCJ -- <https://www.jscj-elec.com> for more details.

### 12.2 Notes

#### Electrostatic Discharge Caution



This IC may be damaged by ESD. Relevant personnel shall comply with correct installation and use specifications to avoid ESD damage to the IC. If appropriate measures are not taken to prevent ESD damage, the hazards caused by ESD include but are not limited to degradation of integrated circuit performance or complete damage of integrated circuit. For some precision integrated circuits, a very small parameter change may cause the whole device to be inconsistent with its published specifications.

### 12.3 Revision History

#### November, 2023: changed from rev -1.2 to rev - 1.3:

- Page 2 ~ 5, Orderable Information, added more available products;
- Page 7, Marking Information, added information about solid points.

#### October, 2023: changed from rev - 1.1 to rev - 1.2:

- Page 9 ~ 15, Electrical Characteristics, normal test condition changed from " $I_{OUT} = 1A$ " to " $I_{OUT} = 500mA$ ";
- Page 10 ~ 14, Electrical Characteristics, the test condition of load regulation changed from "5mA to 1.5A" to "5mA to 1A".

#### June, 2023: changed from CJ7805B rev - 1.0 to CJ7800B series rev - 1.1:

- Added new device: CJ7806B, CJ7808B, CJ7809B, CJ7812B, CJ7815B and CJ7818B;
- Orderable Information, adopted new product naming conventions;
- Page 5, Recommend Operation Conditions, removed notes on recommended working conditions;
- Page 24, Notes, removed notes on thermal metirc.

#### May, 2023: released CJ7805B rev - 1.0.



# DISCLAIMER

## **IMPORTANT NOTICE, PLEASE READ CAREFULLY**

The information in this data sheet is intended to describe the operation and characteristics of our products. JSCJ has the right to make any modification, enhancement, improvement, correction or other changes to any content in this data sheet, including but not limited to specification parameters, circuit design and application information, without prior notice.

Any person who purchases or uses JSCJ products for design shall: 1. Select products suitable for circuit application and design; 2. Design, verify and test the rationality of circuit design; 3. Procedures to ensure that the design complies with relevant laws and regulations and the requirements of such laws and regulations. JSCJ makes no warranty or representation as to the accuracy or completeness of the information contained in this data sheet and assumes no responsibility for the application or use of any of the products described in this data sheet.

Without the written consent of JSCJ, this product shall not be used in occasions requiring high quality or high reliability, including but not limited to the following occasions: medical equipment, military facilities and aerospace. JSCJ shall not be responsible for casualties or property losses caused by abnormal use or application of this product.

Official Website: [www.jscj-elec.com](http://www.jscj-elec.com)

Copyright © JIANGSU CHANGJING ELECTRONICS TECHNOLOGY CO., LTD.

## X-ON Electronics

Largest Supplier of Electrical and Electronic Components

*Click to view similar products for [Linear Voltage Regulators](#) category:*

*Click to view products by [Changjing Electronics Technology](#) manufacturer:*

Other Similar products are found below :

[LV5684PVD-XH](#) [MCDTSA6-2R](#) [L7815ACV-DG](#) [714954EB](#) [ZMR500QFTA](#) [BA033LBSG2-TR](#) [LV5680P-E](#) [L79M05T-E](#) [L78LR05D-MA-E](#) [NCV317MBTG](#) [NTE7227](#) [MP2018GZD-33-P](#) [MP2018GZD-5-P](#) [LV5680NPVC-XH](#) [LT1054CN8](#) [ZTS6538SE](#) [UA78L09CLP](#) [UA78L09CLPR](#) [CAT6221-PPTD-GT3](#) [MC78M09CDTRK](#) [NCV51190MNTAG](#) [78M05](#) [HT7150-1](#) [UM1540DB-18](#) [XC6234H281VR-G](#) [WL2834CA-6/TR](#) [TPL730F33-5TR](#) [TLS850F1TA](#) [V50](#) [TPS549B22RVFR](#) [UM1540DB-33](#) [WL9200P3-50B](#) [WL9100P3-33B](#) [WL9005D4-33](#) [XC6219B152MR](#) [WL2855K33-3/TR](#) [PJ54BM33SE](#) [PJ9500M25SA](#) [MD7218E33PC1](#) [H7533-2PR](#) [SK7812AU](#) [SD1A30](#) [78L33](#) [TP78L33T3](#) [L78L33ACUTR](#) [SK6513ST3A-50](#) [SK6054D4-09](#) [SK6054D4-18](#) [SK6054D4-11](#) [SK6054D4-10](#) [LM79L12F](#)