

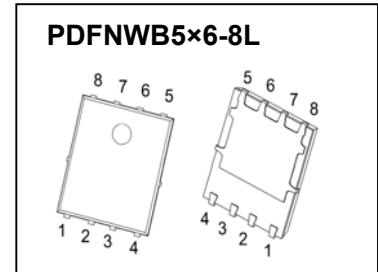

JIANGSU CHANGJING ELECTRONICS TECHNOLOGY CO., LTD
PDFNWB5×6-8L Plastic-Encapsulate MOSFET

CJAC1R5SN04C N-Channel Power MOSFET

$V_{(BR)DSS}$	$R_{DS(on)TYP}$	I_D
40V	1.2mΩ@10V	180A
	1.8mΩ@4.5V	



DESCRIPTION

The N-Channel enhancement mode power field effect transistors is using SGT technology. This advanced technology has been especially tailored to minimize on-state resistance, provide superior switching performance, and withstand high energy pulse in the avalanche and commutation mode. These devices are well suited for high efficiency fast switching applications.

FEATURES

- Battery switch
- Load switch
- High density cell design for ultra low $R_{DS(ON)}$
- Fully characterized avalanche voltage and current
- Good stability and uniformity with high E_{AS}
- Excellent package for good heat dissipation

APPLICATIONS

- SMPS and general purpose applications
- Hard switched and high frequency circuits
- Uninterruptible Power Supply

MARKING

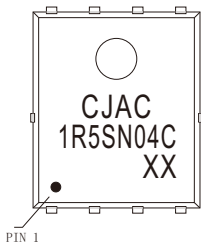

CJAC1R5SN04C = Part No.
 Solid dot = Pin1 indicator.
 XX = Code.

EQUIVALENT CIRCUIT

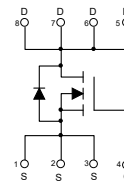

MAXIMUM RATINGS ($T_J=25^{\circ}C$ unless otherwise noted)

Parameter	Symbol	Limit	Unit
Drain-Source Voltage	V_{DS}	40	V
Gate-Source Voltage	V_{GS}	±20	V
Continuous Drain Current	I_D ①	180	A
Pulsed Drain Current	I_{DM} ①②	720	A
Single Pulsed Avalanche Energy	E_{AS} ③	520	mJ
Power Dissipation	P_D ①	96	W
Thermal Resistance from Junction to Ambient	$R_{\theta JA}$ ⑤	62.5	°C/W
Thermal Resistance from Junction to Case	$R_{\theta JC}$ ①	1.3	°C/W
Operating Junction and Storage Temperature Range	T_J, T_{STG}	-55~+150	°C

MOSFET ELECTRICAL CHARACTERISTICS

$T_J=25^\circ\text{C}$ unless otherwise specified

Parameter	Symbol	Test Condition	Min	Typ	Max	Unit	
Off characteristics							
Drain-source breakdown voltage	$V_{(BR)DSS}$	$V_{GS} = 0V, I_D = 1mA$	40	-	-	V	
Zero gate voltage drain current	I_{DSS}	$V_{DS} = 32V, V_{GS} = 0V$	$T_J = 25^\circ\text{C}$	-	-	1.0	μA
			$T_J = 125^\circ\text{C}$	-	-	100	
Gate-body leakage current	I_{GSS}	$V_{DS} = 0V, V_{GS} = \pm 20V$	-	-	± 100	nA	
On characteristics ^④							
Gate-threshold voltage	$V_{GS(th)}$	$V_{DS} = V_{GS}, I_D = 250\mu\text{A}$	1.0	1.7	2.5	V	
Static drain-source on-state resistance	$R_{DS(on)}$	$V_{GS} = 10V, I_D = 30A$	-	1.2	1.5	m Ω	
		$V_{GS} = 4.5V, I_D = 30A$	-	1.8	2.8	m Ω	
Dynamic characteristics							
Input capacitance	C_{iss}	$V_{DS} = 20V, V_{GS} = 0V, f = 100kHz$	-	3900	-	μF	
Output capacitance	C_{oss}		-	1390	-		
Reverse transfer capacitance	C_{rss}		-	58	-		
Gate resistance	R_g	$f = 1MHz$	-	5.2	-	Ω	
Switching characteristics							
Total gate charge	Q_g	$V_{GS} = 4.5V, V_{DS} = 20V, I_D = 75A$	-	26	-	nC	
Total gate charge	Q_g	$V_{GS} = 10V, V_{DS} = 20V, I_D = 75A$	-	57.8	-		
Gate-source charge	Q_{gs}		-	9.9	-		
Gate-drain charge	Q_{gd}		-	11.7	-		
Turn-on delay time	$t_{d(on)}$	$V_{DS} = 20V, V_{GS} = 10V, R_L = 0.8\Omega, R_g = 4.8\Omega$	-	4.7	-	ns	
Turn-on rise time	t_r		-	9.8	-		
Turn-off delay time	$t_{d(off)}$		-	85	-		
Turn-off fall time	t_f		-	45	-		
Drain-Source Diode Characteristics							
Drain-source diode forward voltage	V_{SD} ^④	$V_{GS} = 0V, I_S = 30A$	-	-	1.3	V	
Continuous drain-source diode forward current	I_S ^①		-	-	180	A	
Pulsed drain-source diode forward current	I_{SM} ^{①②}		-	-	720	A	
Reverse recovery time	t_{rr}	$di_S/dt = 100A/\mu\text{s}, I_S = 30A, V_{DD} = 30V$	-	78	-	ns	
Reverse recovery charge	Q_{rr}		-	138	-	nC	

Notes:

- $T_C = 25^\circ\text{C}$.
- Limited only by maximum temperature allowed.
- $V_{DD} = 20V, V_{GS} = 10V, L = 0.5mH, R_g = 25\Omega$ Starting $T_J = 25^\circ\text{C}$.
- Pulse Test : Pulse Width $\leq 380\mu\text{s}$, duty cycle $\leq 2\%$.
- Device mounted on 1 in² FR-4 board with 2oz. single-sided Copper, in a still air environment with $T_A = 25^\circ\text{C}$.

Typical Characteristics ($T_J = 25^\circ\text{C}$, unless otherwise specified)

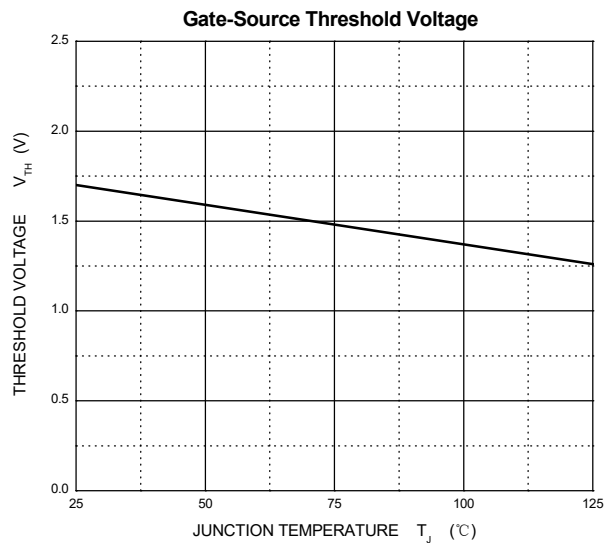
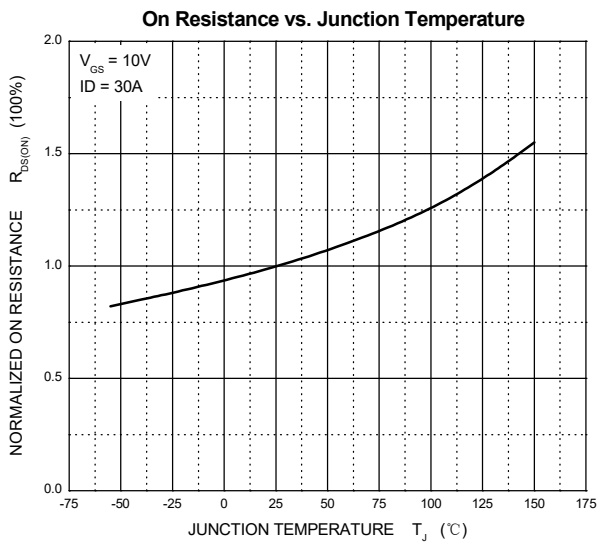
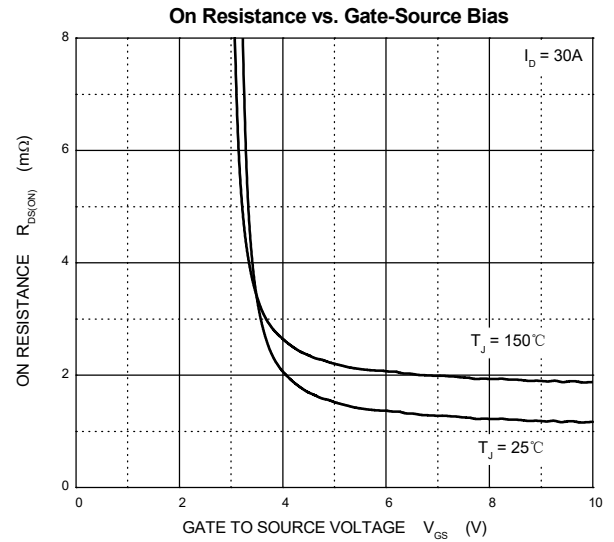
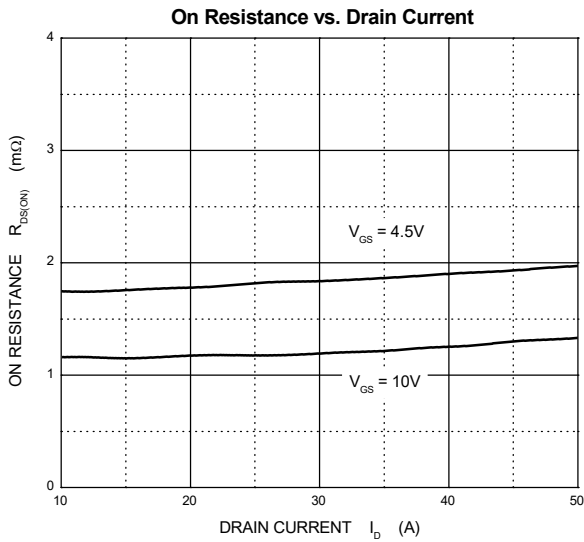
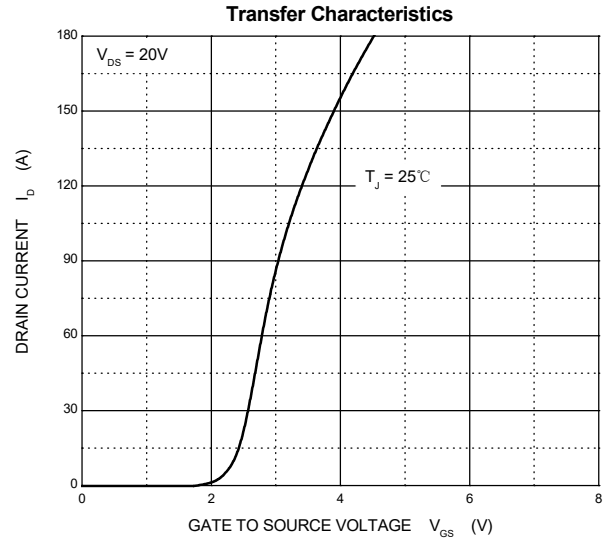
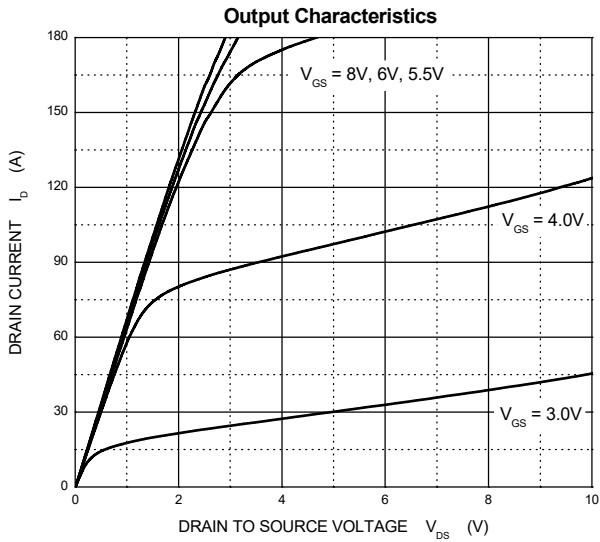

Typical Characteristics ($T_J = 25^\circ\text{C}$, unless otherwise specified)

Typical Capacitances

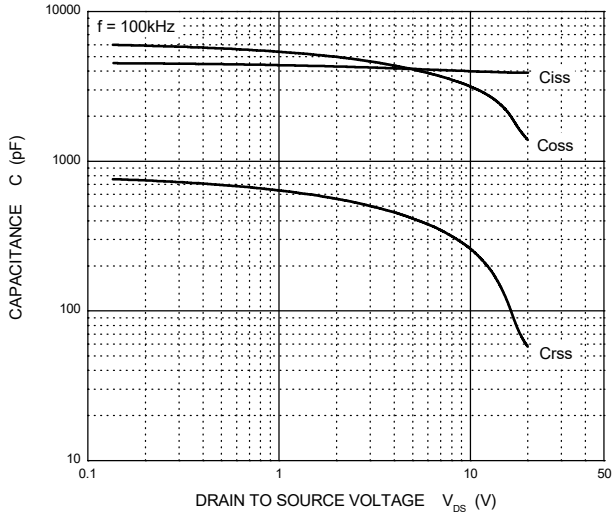

Gate Charge

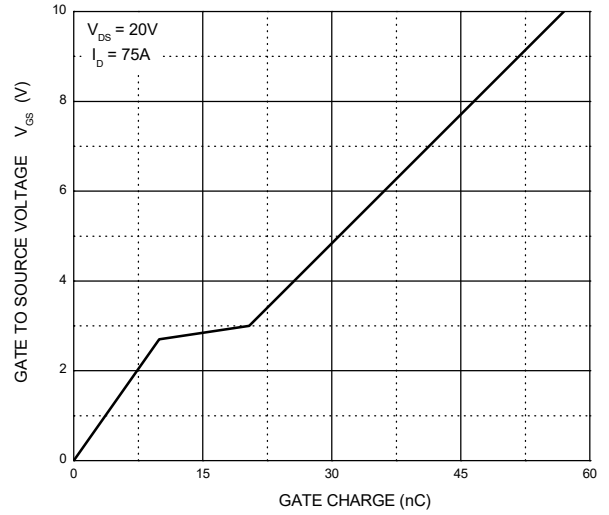

Source-Drain Diode Forward Characteristics

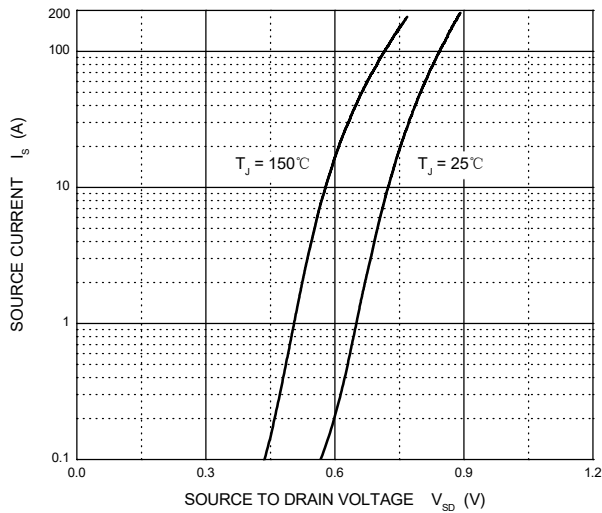

Maximum Safe Operating Area

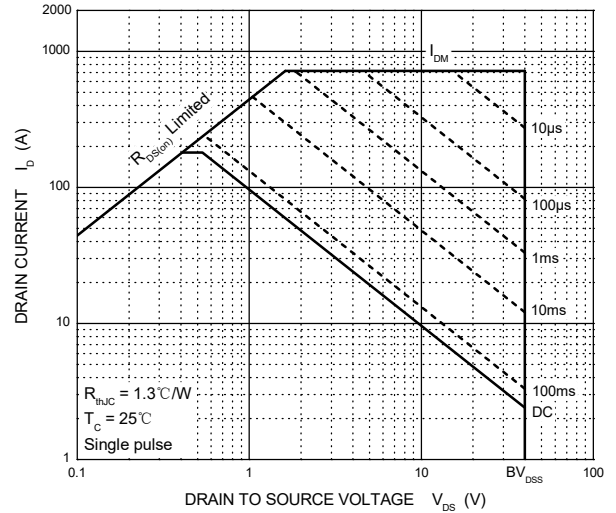

Transient Thermal Impedance, Junction-Case

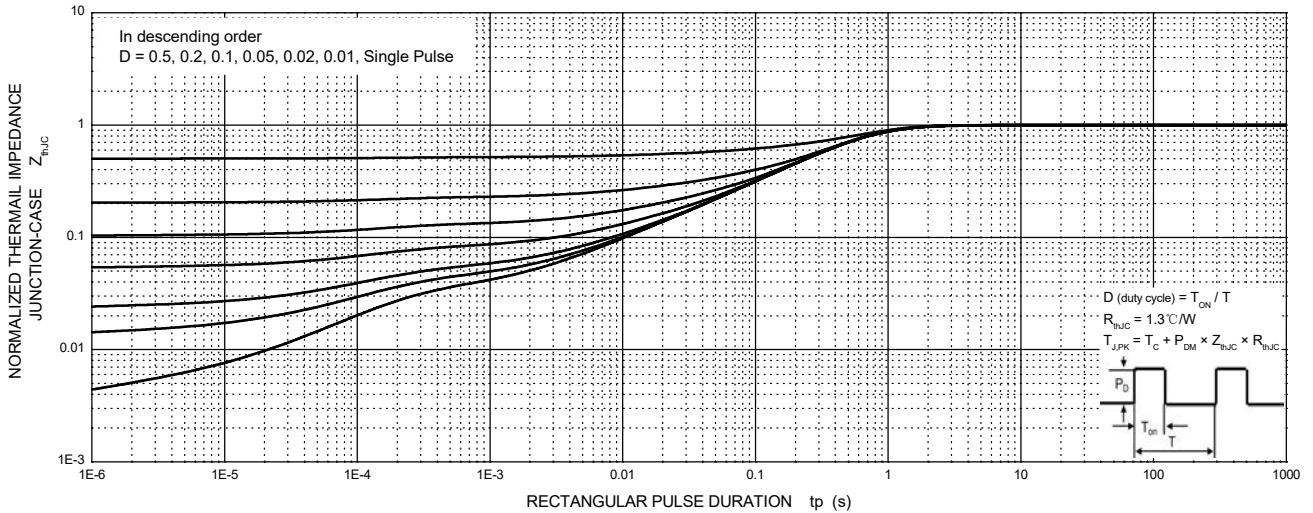

TEST CIRCUIT AND WAVEFORMS

Gate Charge

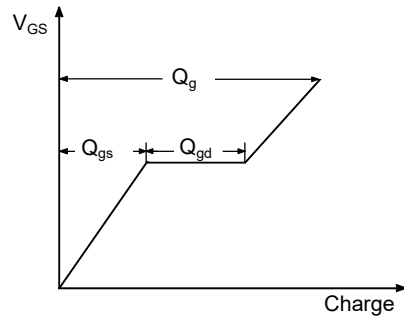
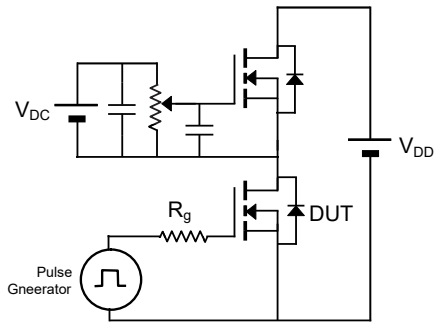

Resistive Load Switching Time

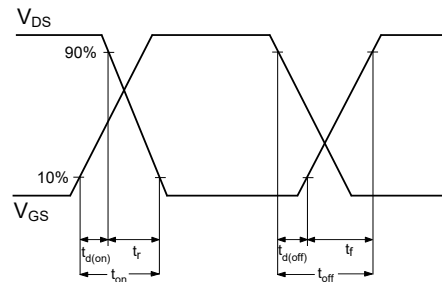
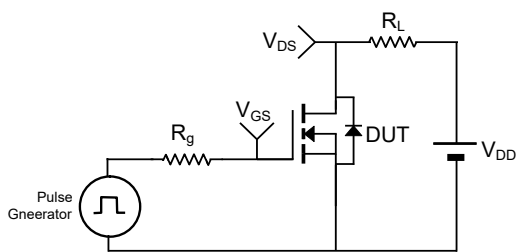

Un-clamped Inductive Load Switching

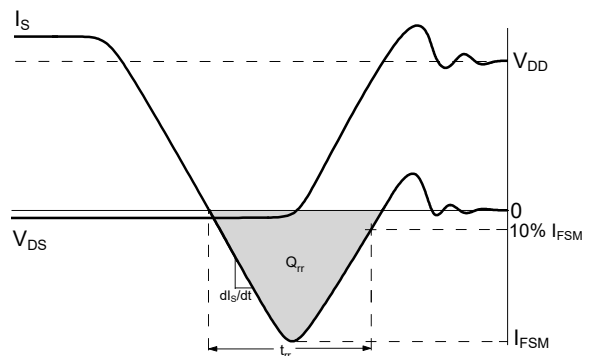
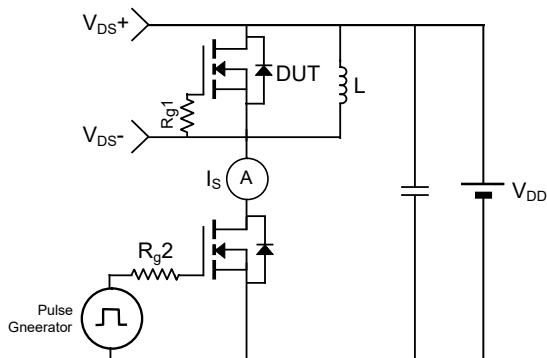
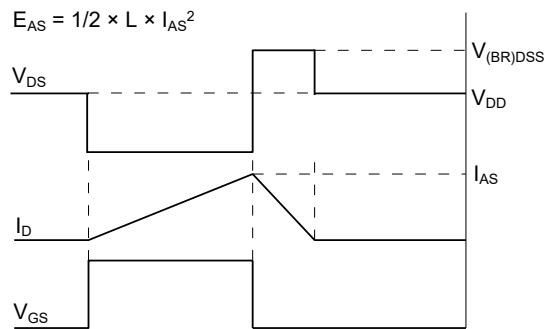
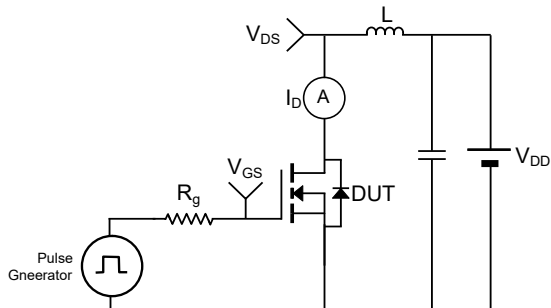

PDFNWB5x6-8L-B Package Outline Dimensions

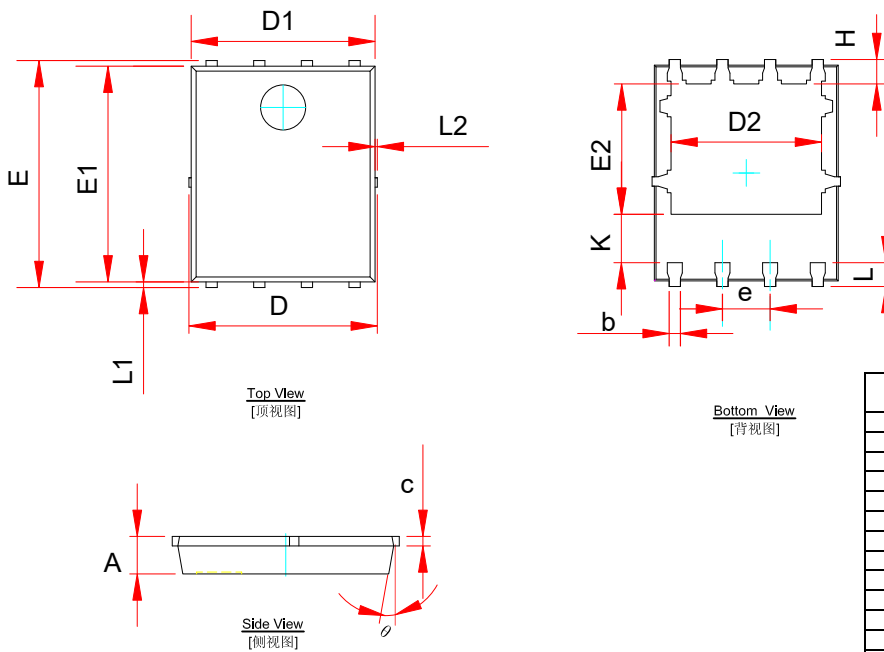

Symbol	Dimensions In Millimeters		Dimensions In Inches	
	Min.	Max.	Min.	Max.
A	0.900	1.100	0.035	0.043
b	0.200	0.400	0.008	0.016
c	0.210	0.340	0.008	0.013
D		5.100		0.201
D1	4.800	5.000	0.189	0.197
D2	3.910	4.110	0.154	0.162
e	1.27 BSC		0.050 BSC	
E	5.900	6.100	0.232	0.240
E1	5.650	5.850	0.222	0.230
E2	3.375	3.575	0.133	0.141
H	0.550	0.750	0.022	0.030
K	1.200		0.047	
L	0.550	0.750	0.022	0.030
L1	0.050	0.250	0.002	0.010
L2		0.120		0.005
θ	8°	12°	8°	12°

PDFNWB5x6-8L Suggested Pad Layout

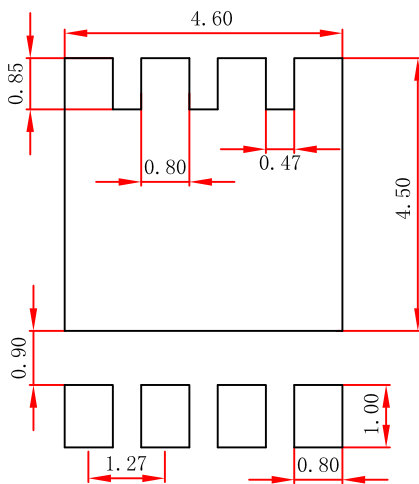

Note:

1. Controlling dimension: in millimeters.
2. General tolerance: $\pm 0.05\text{mm}$.
3. The pad layout is for reference purposes only.

NOTICE

JSCJ reserves the right to make modifications, enhancements, improvements, corrections or other changes without further notice to any product herein. JSCJ does not assume any liability arising out of the application or use of any product described herein.

PDFNWB5×6 Tape and Reel

PDFNWB5×6-8L Embossed Carrier Tape

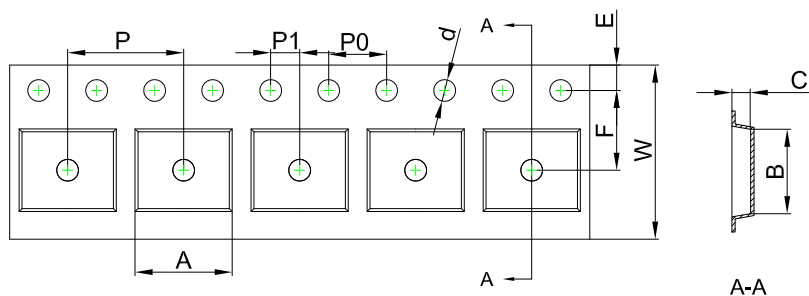

Packaging Description:
PDFNWB5×6-8L parts are shipped in tape. The carrier tape is made from a dissipative (carbon filled) polycarbonate resin. The cover tape is a multilayer film (Heat Activated Adhesive in nature) primarily composed of polyester film, adhesive layer, sealant, and anti-static sprayed agent. These reeled parts in standard option are shipped with 5,000 units per 13" or 33.0 cm diameter reel. The reels are clear in color and is made of polystyrene plastic (anti-static coated).

Dimensions are in millimeter										
Pkg type	A	B	C	d	E	F	P0	P	P1	W
PDFNWB5×6-8L	6.30	5.30	1.10	Ø1.50	1.75	5.50	4.00	8.00	2.00	12.00

PDFNWB5×6-8L Tape Leader and Trailer

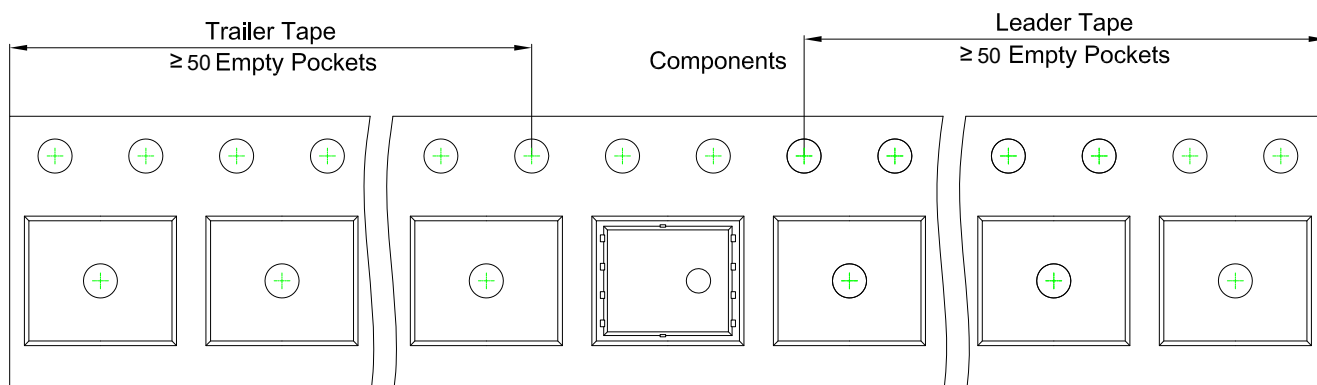

PDFNWB5×6-8L Reel

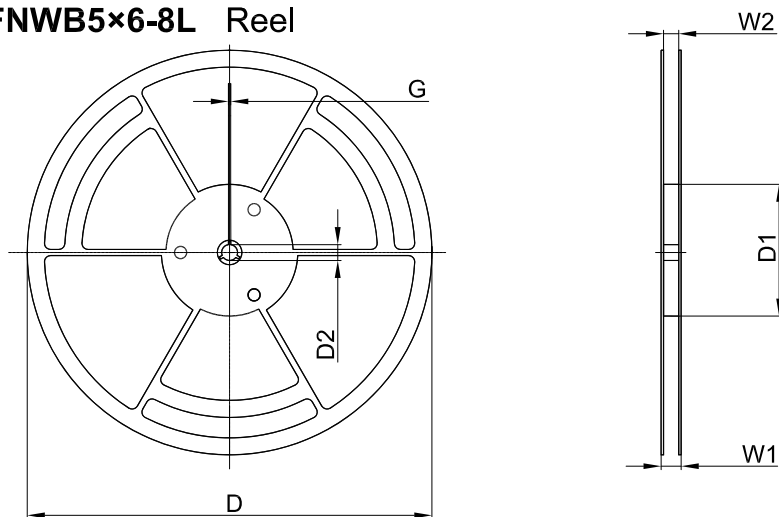

Dimensions are in millimeter						
Reel Option	D	D1	D2	G	W1	W2
13"Dia	Ø330.00	100.00	13.00	1.90	17.60	12.40

REEL	Reel Size	Box	Box Size(mm)	Carton	Carton Size(mm)
5,000 pcs	13 inch	5,000 pcs	340×336×29	50,000 pcs	353×346×365

X-ON Electronics

Largest Supplier of Electrical and Electronic Components

Click to view similar products for [MOSFET](#) category:

Click to view products by [Changjing Electronics Technology](#) manufacturer:

Other Similar products are found below :

[IRFD120](#) [JANTX2N5237](#) [2SK2267\(Q\)](#) [BUK455-60A/B](#) [TK100A10N1,S4X\(S](#) [MIC4420CM-TR](#) [VN1206L](#) [NDP4060](#) [SI4482DY](#)
[IRS2092STRPBF-EL](#) [IPS70R2K0CEAKMA1](#) [TK31J60W5,S1VQ\(O](#) [TK31J60W,S1VQ\(O](#) [TK16J60W,S1VQ\(O](#) [2SK2614\(TE16L1,Q\)](#)
[DMN1017UCP3-7](#) [EFC2J004NUZTDG](#) [P85W28HP2F-7071](#) [DMN1053UCP4-7](#) [NTE2384](#) [DMC2700UDMQ-7](#) [DMN2080UCB4-7](#)
[DMN61D9UWQ-13](#) [US6M2GTR](#) [DMN31D5UDJ-7](#) [DMP22D4UFO-7B](#) [IPS60R3K4CEAKMA1](#) [DMN1006UCA6-7](#) [DMN16M9UCA6-7](#)
[STF5N65M6](#) [IRF40H233XTMA1](#) [STU5N65M6](#) [DMN6022SSD-13](#) [DMN13M9UCA6-7](#) [DMTH10H4M6SPS-13](#) [IPS60R360PFD7SAKMA1](#)
[DMN2990UFB-7B](#) [SSM3K35CT,L3F](#) [IPLK60R1K0PFD7ATMA1](#) [2N7002W-G](#) [MCAC30N06Y-TP](#) [IPWS65R035CFD7AXKSA1](#)
[MCQ7328-TP](#) [SSM3J143TU,LXHF](#) [DMN12M3UCA6-7](#) [PJMF280N65E1_T0_00201](#) [PJMF380N65E1_T0_00201](#)
[PJMF280N60E1_T0_00201](#) [PJMF600N65E1_T0_00201](#) [PJMF900N65E1_T0_00201](#)