

DFNWB2X2-6L-J Plastic-Encapsulate MOSFETS

CJMN2012 N-Channel MOSFET

$V_{(BR)DSS}$	$R_{DS(on)MAX}$	I_D
20V	15mΩ@4.5V	12A
	18mΩ@2.5V	
	30mΩ@1.8V	

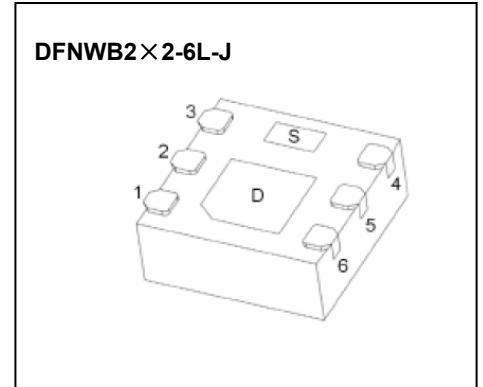

FEATURES

- TrenchFET Power MOSFET
- Small package DFNWB2×2-6L-J

APPLICATION

- Load Switch for Portable Applications

MARKING:

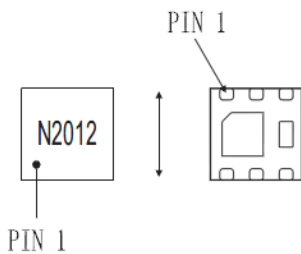

Equivalent Circuit

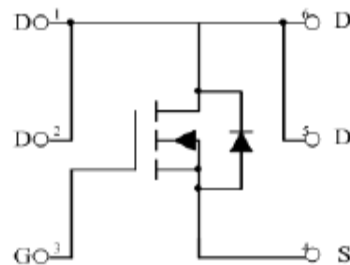

ABSOLUTE MAXIMUM RATINGS ($T_a=25^{\circ}C$ unless otherwise noted)

Symbol Para	meter	Value	Unit
V_{DS}	Drain-Source Voltage	20	V
V_{GS}	Gate-Source Voltage	±10	V
I_D	Continuous Drain Current (note 1)	12	A
I_{DM}	Collector Current-Pulse(Note3)	40	A
$R_{\theta JA}$	Thermal Resistance from Junction to Ambient (note 2)	167	$^{\circ}C/W$
T_j	Junction Temperature	150	$^{\circ}C$
T_{stg}	Storage Temperature	-55~+150	$^{\circ}C$
T_L	Lead Temperature for Soldering Purposes(1/8" from case for 10 s)	260	$^{\circ}C$

MOSFET ELECTRICAL CHARACTERISTICS

$T_a=25\text{ }^\circ\text{C}$ unless otherwise specified

Parameter	Symbol	Test Condition	Min	Typ	Max	Unit
STATIC PARAMETERS						
Drain-source breakdown voltage	$V_{(BR)DSS}$	$V_{GS} = 0V, I_D = 250\mu A$	20			V
Zero gate voltage drain current	I_{DSS}	$V_{DS} = 20V, V_{GS} = 0V$			1	μA
Gate-body leakage current	I_{GSS}	$V_{GS} = \pm 10V, V_{DS} = 0V$			± 100	nA
Gate threshold voltage (note 3)	$V_{GS(th)}$	$V_{DS} = V_{GS}, I_D = 250\mu A$	0.35	0.7	1	V
Drain-source on-resistance(note 3)	$R_{DS(on)}$	$V_{GS} = 4.5V, I_D = 5A$		10	15	m Ω
		$V_{GS} = 2.5V, I_D = 5A$		13	18	m Ω
		$V_{GS} = 1.8V, I_D = 5A$		18	30	m Ω
Forward tranconductance(note 3)	g_{FS}	$V_{DS} = 4V, I_D = 9.7A$	20			S
Diode forward voltage (note 3)	V_{SD}	$I_S = 10A, V_{GS} = 0V$			1.2	V
DYNAMIC PARAMETERS (note 4)						
Input Capacitance	C_{iss}	$V_{DS} = 4V, V_{GS} = 0V, f = 1MHz$		1800		pF
Output Capacitance	C_{oss}			650		pF
Reverse Transfer Capacitance	C_{rss}			450		pF
Gate Resistance	R_g	$f = 1MHz$		2.5		Ω
SWITCHING PARAMETERS (note 4)						
Turn-on delay time	$t_{d(on)}$	$V_{GEN} = 4.5V, V_{DD} = 4V,$ $I_D = 10A, R_g = 1\Omega$ $R_L = 0.4\ \Omega$		12	20	ns
Turn-on rise time	t_r			10	15	ns
Turn-off delay time	$t_{d(off)}$			65	100	ns
Turn-off fall time	t_f			20	30	ns
Total Gate Charge	Q_g					32
Gate-Source Chage	Q_{gs}	$V_{DS} = 4V, V_{GS} = 5V$ $I_D = 10A$		2.5		nC
Gage-Drain Charge	Q_{gd}			6.5		nC

Notes :

- 1.Surface mounted on FR4 board using 1 square inch pad size,1oz copper.
- 2.Surface mounted on FR4 board using the minimum pad size,1oz copper.
3. Pulse test : Pulse width=300 μs , duty cycle $\leq 2\%$.
4. These parameters have no way to verify.

Typical Characteristics

Output Characteristics

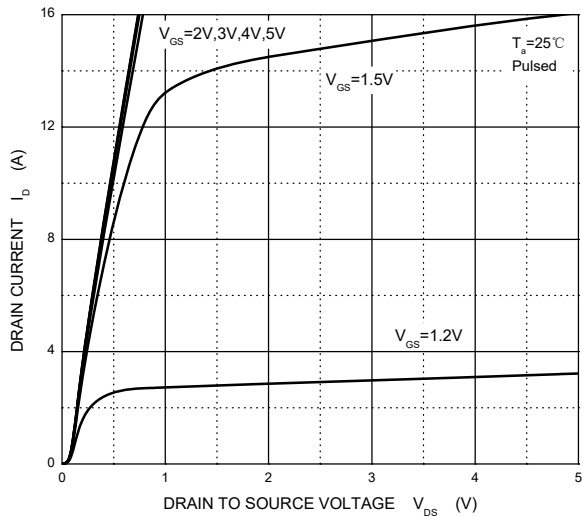

Transfer Characteristics

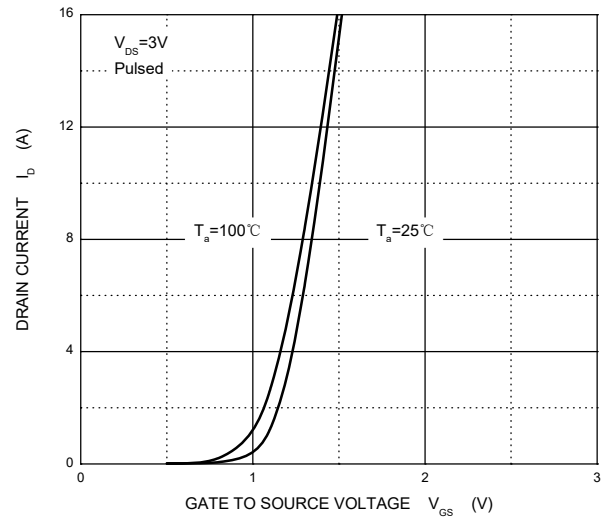

$R_{DS(ON)}$ — I_D

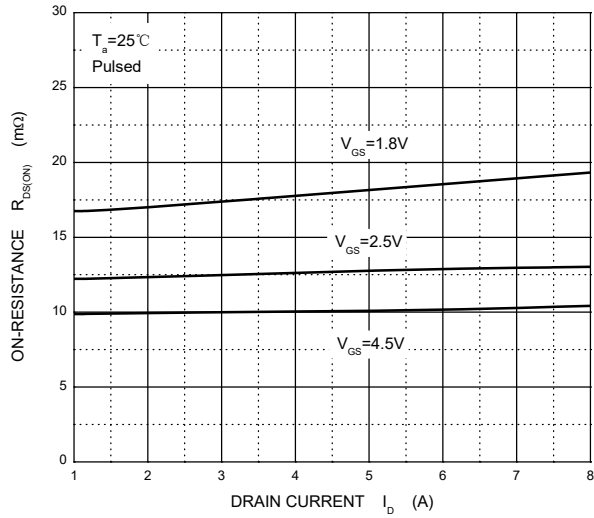

$R_{DS(ON)}$ — V_{GS}

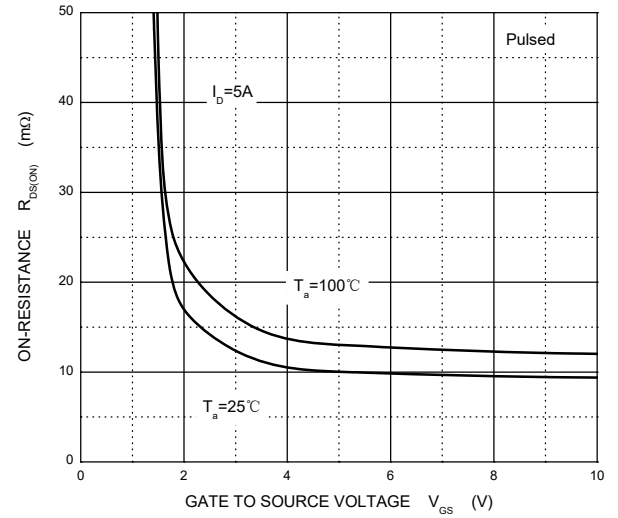

I_S — V_{SD}

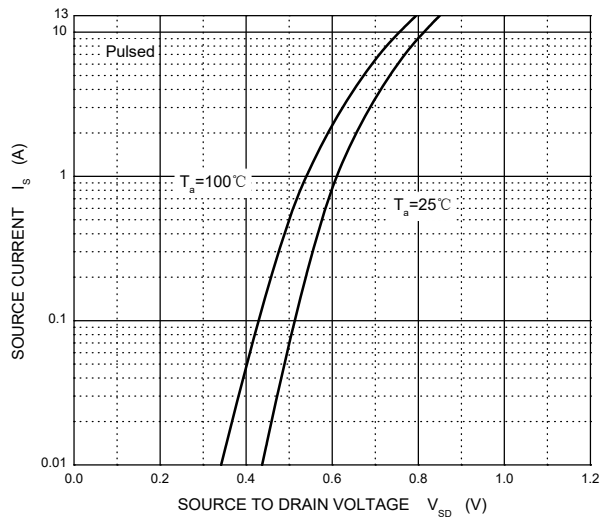

Threshold Voltage

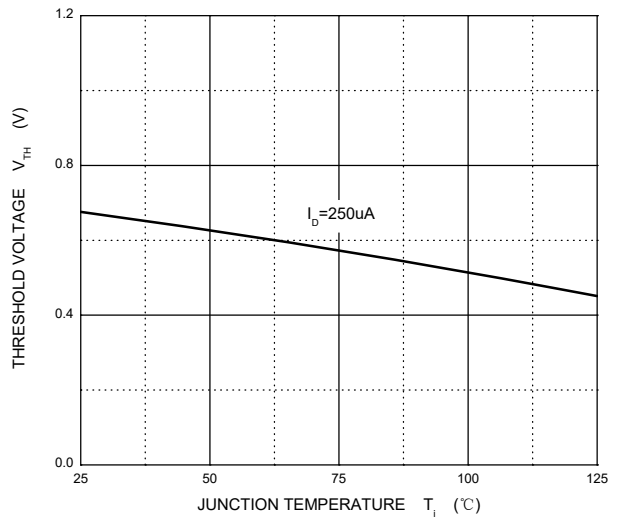

DFNWB2X2-6L-J Package Outline Dimensions

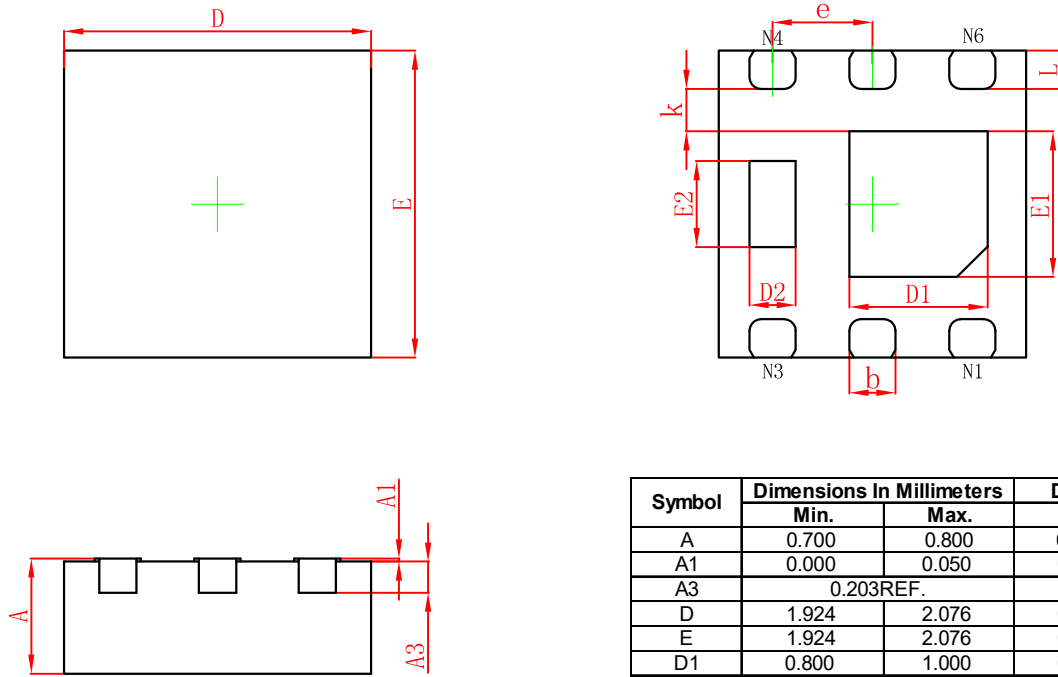

Symbol	Dimensions In Millimeters		Dimensions In Inches	
	Min.	Max.	Min.	Max.
A	0.700	0.800	0.028	0.032
A1	0.000	0.050	0.000	0.002
A3	0.203REF.		0.008REF.	
D	1.924	2.076	0.076	0.082
E	1.924	2.076	0.076	0.082
D1	0.800	1.000	0.031	0.039
E1	0.850	1.050	0.033	0.041
D2	0.200	0.400	0.008	0.016
E2	0.460	0.660	0.018	0.026
k	0.200MIN.		0.008MIN.	
b	0.250	0.350	0.010	0.014
e	0.650TYP.		0.026TYP.	
L	0.174	0.326	0.007	0.013

DFNWB2X2-6L-J Suggested Pad Layout

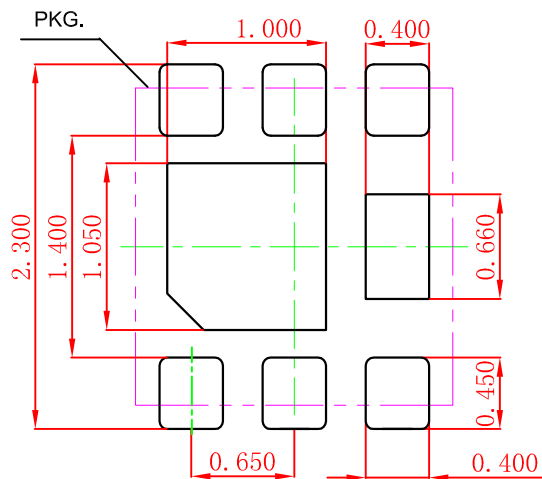

Note:

1. Controlling dimension: in millimeters.
2. General tolerance: $\pm 0.050\text{mm}$.
3. The pad layout is for reference purposes only.

NOTICE

JSCJ reserves the right to make modifications, enhancements, improvements, corrections or other changes without further notice to any product herein. JSCJ does not assume any liability arising out of the application or use of any product described herein.

DFNWB2X2-6L Tape and Reel

DFNWB2×2-6L Embossed Carrier Tape

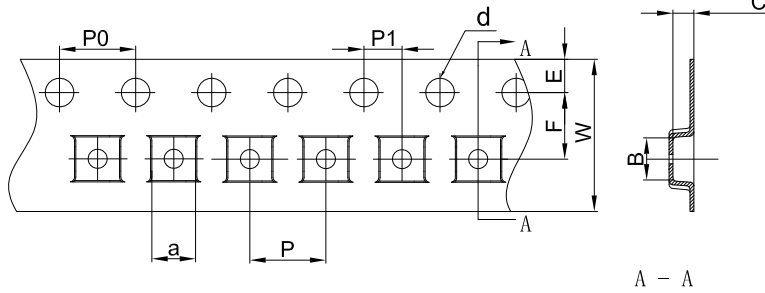

Packaging Description:

DFNWB2×2-6L parts are shipped in tape. The carrier tape is made from a dissipative (carbon filled) polycarbonate resin. The cover tape is a multilayer film (Heat Activated Adhesive in nature) primarily composed of polyester film, adhesive layer, sealant, and anti-static sprayed agent. These reeled parts in standard option are shipped with 3,000 units per 7" or 18.0cm diameter reel. The reels are clear in color and is made of polystyrene plastic (anti-static coated).

Dimensions are in millimeter

Pkg type	a	B	C	d	E	F	P0	P	P1	W
DFNWB2×2-6L	2.30	2.30	1.10	Ø1.50	1.75	3.50	4.00	4.00	2.00	8.00

DFNWB2×2-6L Tape Leader and Trailer

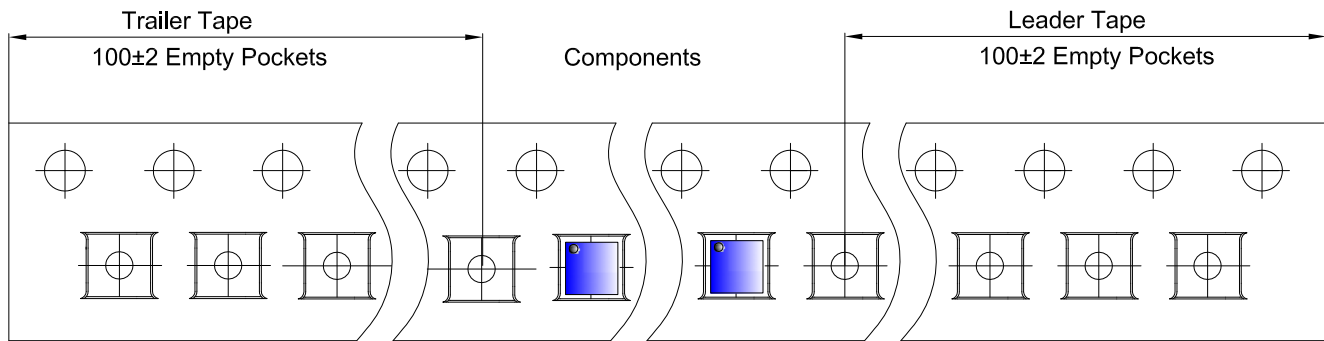

DFNWB2×2-6L Reel

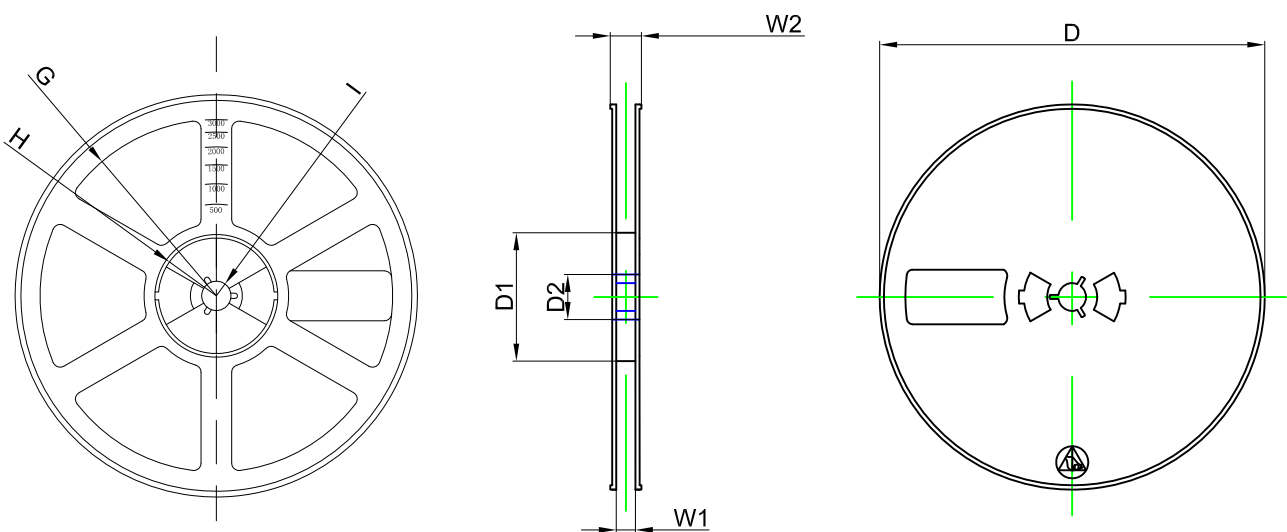

Dimensions are in millimeter

Reel Option	D	D1	D2	G	H	I	W1	W2
7" Dia	Ø180.00	60.00	13.00	R78.00	R25.60	R6.50	9.50	13.10

REEL	Reel Size	Box	Box Size(mm)	Carton	Carton Size(mm)	G.W.(kg)
3000 pcs	7 inch	30,000 pcs	203×203×195	120,000 pcs	438×438×220	

X-ON Electronics

Largest Supplier of Electrical and Electronic Components

Click to view similar products for [MOSFET](#) category:

Click to view products by [Changjing Electronics Technology](#) manufacturer:

Other Similar products are found below :

[614233C](#) [648584F](#) [IRFD120](#) [IRFF430](#) [JANTX2N5237](#) [2N7000](#) [FCA20N60_F109](#) [FDZ595PZ](#) [AOD464](#) [2SK2267\(Q\)](#) [2SK2545\(Q,T\)](#)
[405094E](#) [423220D](#) [MIC4420CM-TR](#) [VN1206L](#) [614234A](#) [715780A](#) [SSM6J414TU,LF\(T](#) [751625C](#) [PSMN4R2-30MLD](#)
[TK31J60W5,S1VQ\(O](#) [2SK2614\(TE16L1,Q\)](#) [DMN1017UCP3-7](#) [EFC2J004NUZTDG](#) [FCAB21350L1](#) [P85W28HP2F-7071](#) [DMN1053UCP4-7](#)
[NTE2384](#) [NTE2969](#) [NTE6400A](#) [DMN2080UCB4-7](#) [DMN61D9UWQ-13](#) [US6M2GTR](#) [DMN31D5UDJ-7](#) [SSM6P54TU,LF](#) [DMP22D4UFO-](#)
[7B](#) [IPS60R3K4CEAKMA1](#) [DMN1006UCA6-7](#) [DMN16M9UCA6-7](#) [STF5N65M6](#) [STU5N65M6](#) [C3M0021120D](#) [DMN13M9UCA6-7](#)
[BSS340NWH6327XTSA1](#) [MCM3400A-TP](#) [DMTH10H4M6SPS-13](#) [IRF40SC240ARMA1](#) [IPS60R1K0PFD7SAKMA1](#)
[IPS60R360PFD7SAKMA1](#) [IPS60R600PFD7SAKMA1](#)