



>5 B; GI '7 <5 B; >B; '9 @7 HFCB=7 G'H97 <BC @; M7 C'Z @H'

HC!&) &!&@D`UghW9 bWUdgi `UH`A CG: 9 HG`

**7 >I 20B\$6A`** ÁB!7\ UbbY`Dck Yf`ACG: 9H.

J <sub>16</sub> F18 GG`	F <sub>8</sub> Gftbt HMD	≈`
î €X	Gí { O F€X	20A
	35mΩ@4.5V	

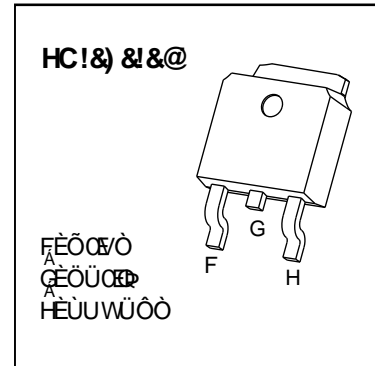

**8 9 G7 F=DHCB`**

V@Á ÔRWGPÉÍ OÁ`~••Á aãçã &áÁ d^}&@ l&@ [[ `^Á aã áÁÁ•ã } Áç Á } [ çã^Á ç&||^} óÜöüüüüü, á@Á, Á\* æ^Á&@ã\*^ÉÁ QÁ &ã Á^Á•^áÁ Áã Áã^çãã c Á-Áã } |ããã } •Á

**: 95 HI F9`**

- Ôç&||^} óã æ^Áç |Á [[ á@ããã•ããã }
- Wçãã, Á æ^Á&@ã
- Š [ , Á^ç^!•^Á!ã } •^!Áããããã &^
- Öæ ó, á&@ã \* Áãããããã
- Öçãã &@Á } ^!^^Á } ^ãããã

**5 DD@7 5HCBÁ**

- Ú [ , ^!Á, á&@ã \* Áã } |ããã }

**MARKING**

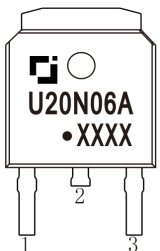

WGEPÉÍ OÁMÖ^çã^Áç á^.  
 Ú [ |ããã [ óMÖ!^^} Á [ |ãã \* Áç { [ ] ^} á^Áçã^Á.  
 áã [ ] ^Éã@Á [ { çã^çã^Á.  
 ÝÝÝÝMÖ [ á^.

**EQUIVALENT CIRCUIT**

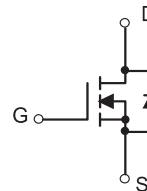

**A5L=AI A`F5HB; G`fIH,1&) °C`i b`Ygg`cH Yfk JgY`bch`X`L`**

DUFa YHf`	Gna Vc`	@a Jh	I bJh
Ö:ãã EÜ [ ^!&Áç [  ãã^Á	XóuÁ	î €Á	XÁ
Öæ EÜ [ ^!&Áç [  ãã^Á	XóuÁ	† GEÁ	XÁ
Ô [ } çã [ ^•ÁÖ:ãã ÁÖ`!!^} óÁ	QÁ <sup>1</sup>	GEÁ	OÁ
Ú` ^áÁÖ:ãã ÁÖ`!!^} óÁ	Q <sub>T</sub> Á <sup>2</sup>	î €Á	OÁ
Üã * ^ÁÚ` ^áÁÖçãã &@ÁÖ!^^Á	Ööüü <sup>3</sup>	49	{ RÁ
Ú [ , ^!ÁÖã•ããã } Á	ÚóÁ <sup>4</sup>	40	Y Á
V@!{ çãÁ^•ããã &Áç [ { ÁR` } &çã } Áç ÁÖæ áã } óÁ	Ü <sub>RO</sub> Á <sup>5</sup>	F€€	°CBY Á
V@!{ çãÁ^•ããã &Áç [ { ÁR` } &çã } Áç ÁÖæ^Á	Ü <sub>RO</sub> Á <sup>6</sup>	3.12	°CBY Á
U [ ] ^ããã * ÁR` } &çã } Áãã áÁÜç  ãã^Á^ [ ] ^!æ` ^ÁÜã } *^Á	T <sub>J</sub> , T <sub>stg</sub>	-55~+150	°C

# MOSFET ELECTRICAL CHARACTERISTICS

$T_a=25^\circ\text{C}$  unless otherwise specified

Parameter	Symbol	Test Condition	Min	Typ	Max	Unit
<b>Off characteristics</b>						
Drain-source breakdown voltage	$V_{(BR)DSS}$	$V_{GS} = 0V, I_D = 250\mu A$	60			V
Zero gate voltage drain current	$I_{DSS}$	$V_{DS} = 48V, V_{GS} = 0V$	$T_J = 25^\circ\text{C}$		1.0	$\mu A$
			$T_J = 125^\circ\text{C}$		100	
Gate-body leakage current	$I_{GSS}$	$V_{DS} = 0V, V_{GS} = \pm 20V$			$\pm 100$	nA
<b>On characteristics</b> <sup>④</sup>						
Gate-threshold voltage	$V_{GS(th)}$	$V_{DS} = V_{GS}, I_D = 250\mu A$	1.0	1.7	2.5	V
Static drain-source on-state resistance	$R_{DS(on)}$	$V_{GS} = 10V, I_D = 10A$		26	35	$m\Omega$
		$V_{GS} = 4.5V, I_D = 10A$		35	50	$m\Omega$
<b>Dynamic characteristics</b> <sup>④ ⑤</sup>						
Input capacitance	$C_{iss}$	$V_{DS} = 25V, V_{GS} = 0V, f = 1MHz$		850	1700	$pF$
Output capacitance	$C_{oss}$			60	120	
Reverse transfer capacitance	$C_{rss}$			55	110	
Gate resistance	$R_g$	$f = 1MHz$		2.0		$\Omega$
<b>Switching characteristics</b> <sup>④ ⑤</sup>						
Total gate charge	$Q_g$	$V_{GS} = 10V, V_{DS} = 30V, I_D = 10A$		18	36	$nC$
Gate-source charge	$Q_{gs}$			2.0	4.0	
Gate-drain charge	$Q_{gd}$			4.4	8.8	
Turn-on delay time	$t_{d(on)}$	$V_{DS} = 30V, R_L = 2.5\Omega, V_{GS} = 10V, R_G = 3\Omega$		4.2		$ns$
Turn-on rise time	$t_r$			3.4		
Turn-off delay time	$t_{d(off)}$			16		
Turn-off fall time	$t_f$			2		
<b>Drain-Source Diode Characteristics</b>						
Drain-source diode forward voltage	$V_{SD}$ <sup>④</sup>	$V_{GS} = 0V, I_S = 10A$			1.2	V
Continuous drain-source diode forward current	$I_S$ <sup>①</sup>				20	A
Pulsed drain-source diode forward current	$I_{SM}$ <sup>②</sup>				80	A

Notes:

1.  $T_c = 25^\circ\text{C}$  Limited only by maximum temperature allowed.

2.  $P_w \leq 10\mu s$ , Duty cycle  $\leq 1\%$ .

3. EAS condition:  $V_{DD} = 30V, V_{GS} = 10V, L = 0.5mH, R_g = 25\Omega$  Starting  $T_J = 25^\circ\text{C}$ .

4. Pulse Test : Pulse Width  $\leq 300\mu s$ , duty cycle  $\leq 2\%$ .

5. Guaranteed by design, not subject to production.

6. The value of  $R_{\theta JA}$  is measured with the device mounted on 1 in 2 FR-4 board with 2oz. Copper, in a still air environment with  $T_a = 25^\circ\text{C}$ .

# Typical Characteristics

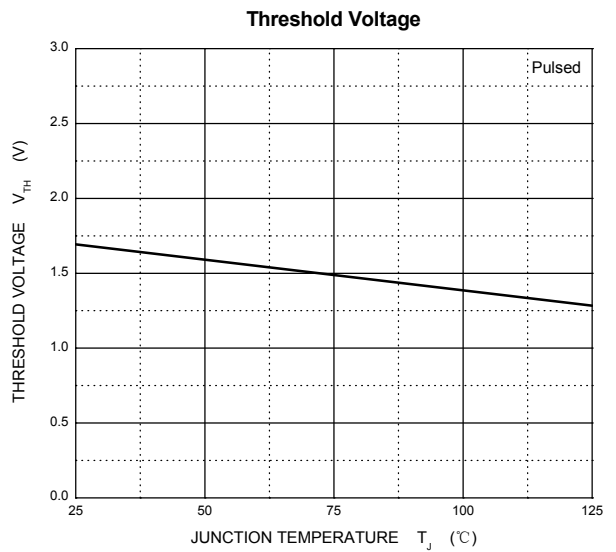
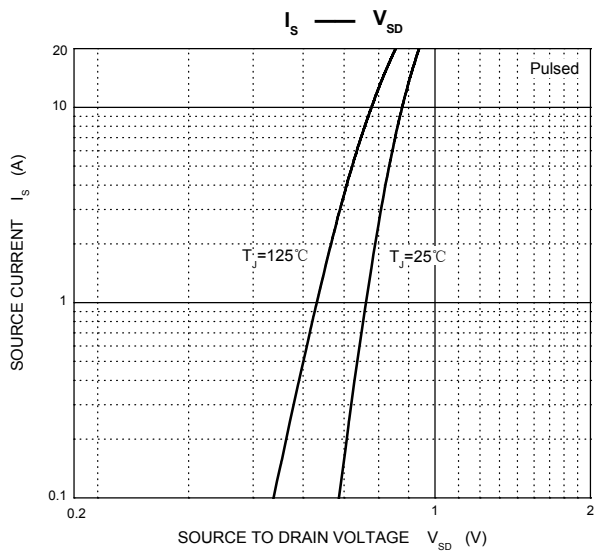
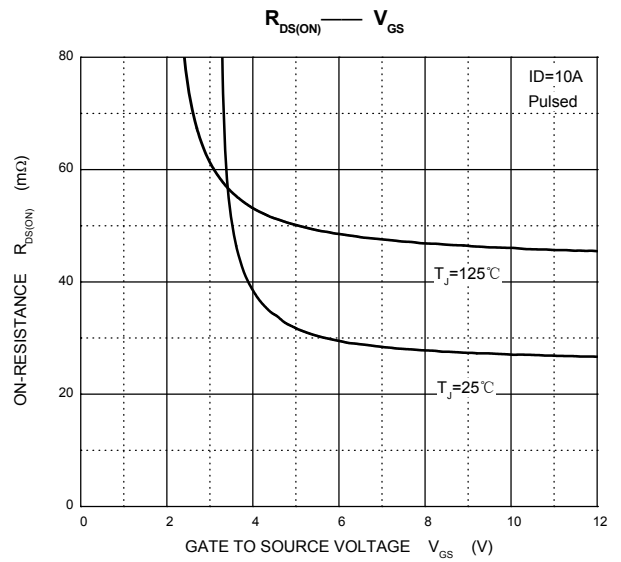
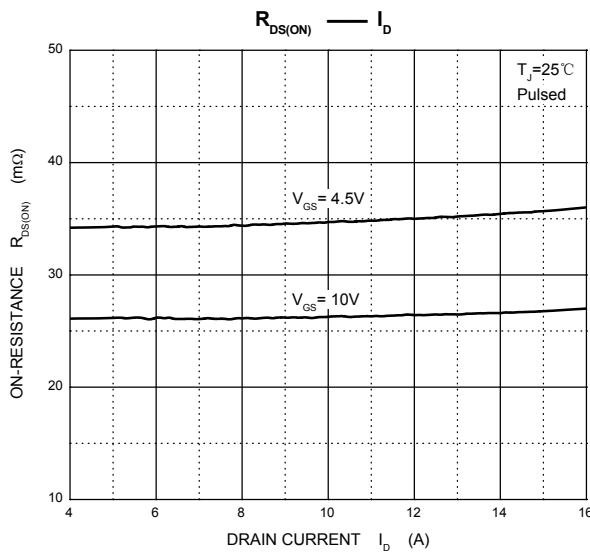
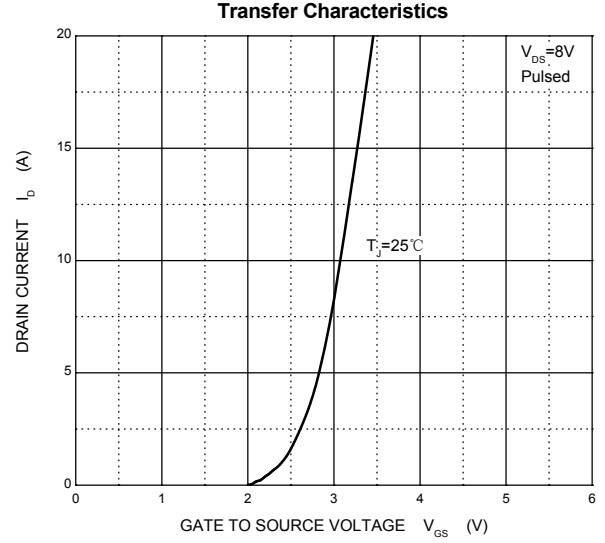
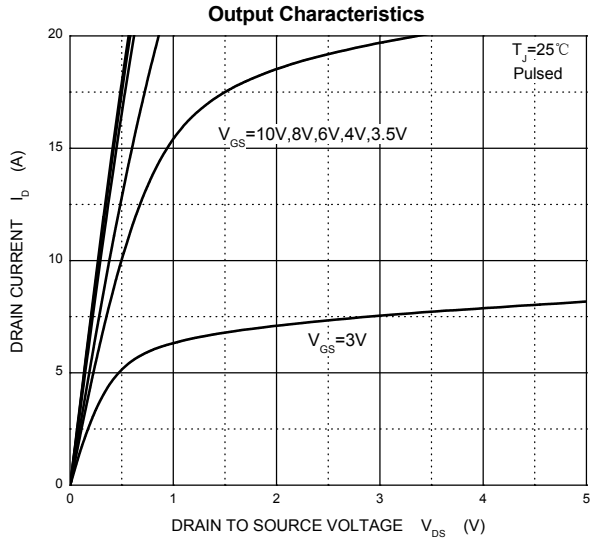

# Typical Characteristics

### Capacitances

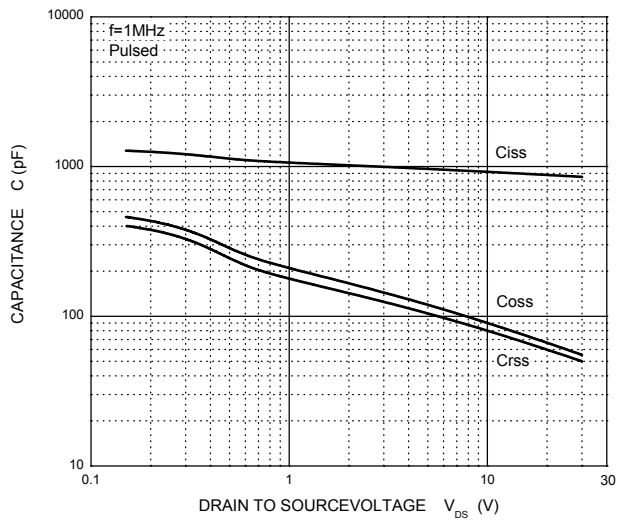

### Gate Charge

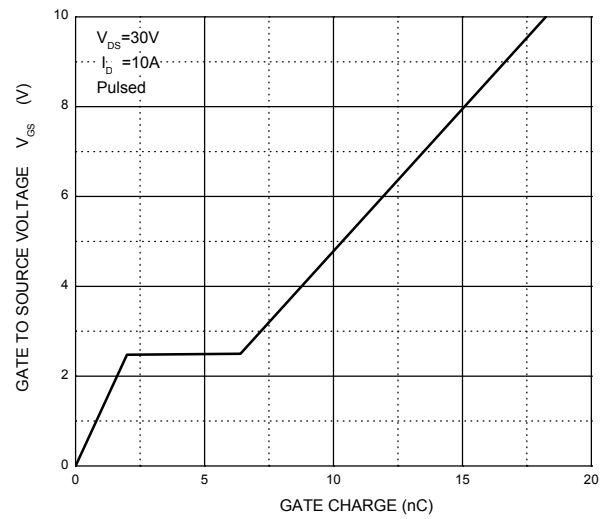

## TO-252-2L Package Outline Dimensions

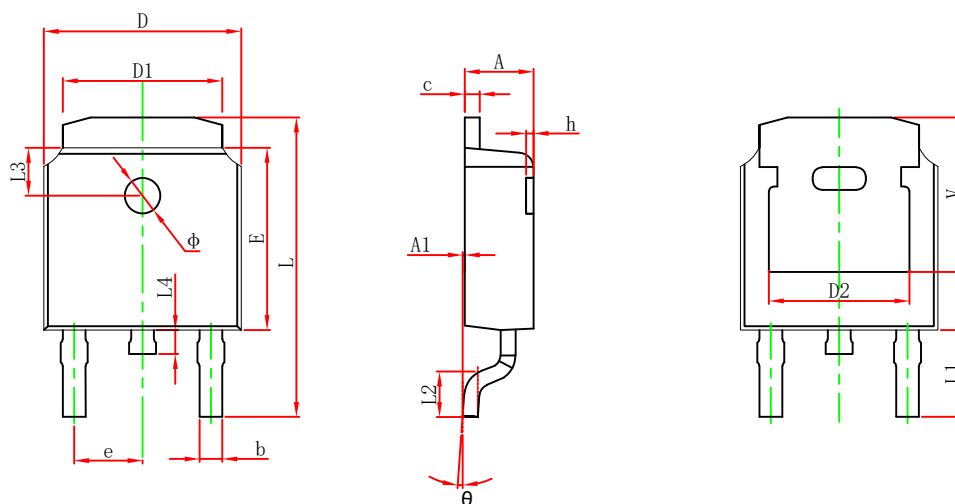

Symbol	Dimensions In Millimeters		Dimensions In Inches	
	Min.	Max.	Min.	Max.
A	2.200	2.400	0.087	0.094
A1	0.000	0.127	0.000	0.005
b	0.635	0.770	0.025	0.030
c	0.460	0.580	0.018	0.023
D	6.500	6.700	0.256	0.264
D1	5.100	5.460	0.201	0.215
D2	4.830 REF.		0.190 REF.	
E	6.000	6.200	0.236	0.244
e	2.186	2.386	0.086	0.094
L	9.712	10.312	0.382	0.406
L1	2.900 REF.		0.114 REF.	
L2	1.400	1.700	0.055	0.067
L3	1.600 REF.		0.063 REF.	
L4	0.600	1.000	0.024	0.039
$\Phi$	1.100	1.300	0.043	0.051
$\theta$	0°	8°	0°	8°
h	0.000	0.300	0.000	0.012
V	5.250 REF.		0.207 REF.	

## TO-252-2L Suggested Pad Layout

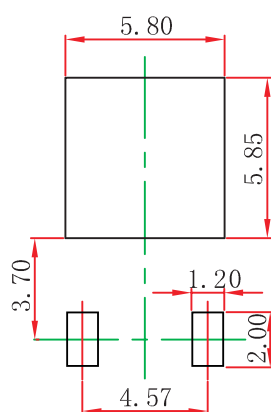

**Note:**

1. Controlling dimension: in millimeters.
2. General tolerance:  $\pm 0.05$  mm.
3. The pad layout is for reference purposes only.

**NOTICE**

JSCJ reserves the right to make modifications, enhancements, improvements, corrections or other changes without further notice to any product herein. JSCJ does not assume any liability arising out of the application or use of any product described herein.

# TO-252-2L Tape and Reel

## TO-252 Embossed Carrier Tape

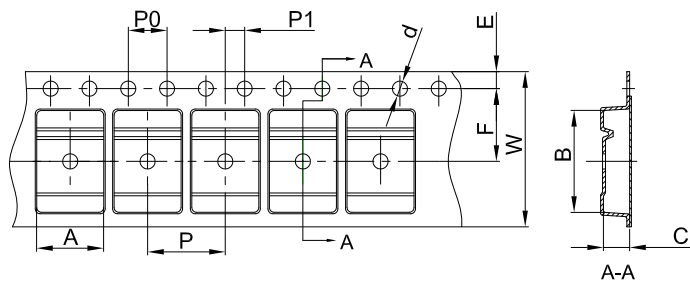

### Packaging Description:

TO-252 parts are shipped in tape. The carrier tape is made from a dissipative (carbon filled) polycarbonate resin. The cover tape is a multilayer film (Heat Activated Adhesive in nature) primarily composed of polyester film, adhesive layer, sealant, and anti-static sprayed agent. These reeled parts in standard option are shipped with 25,00 units per 13" or 33.0 cm diameter reel. The reels are clear in color and is made of polystyrene plastic (anti-static coated).

Dimensions are in millimeter										
Pkg type	A	B	C	d	E	F	P0	P	P1	W
TO-252	6.90	10.50	2.70	Ø1.55	1.75	7.50	4.00	8.00	2.00	16.00

## TO-252 Tape Leader and Trailer

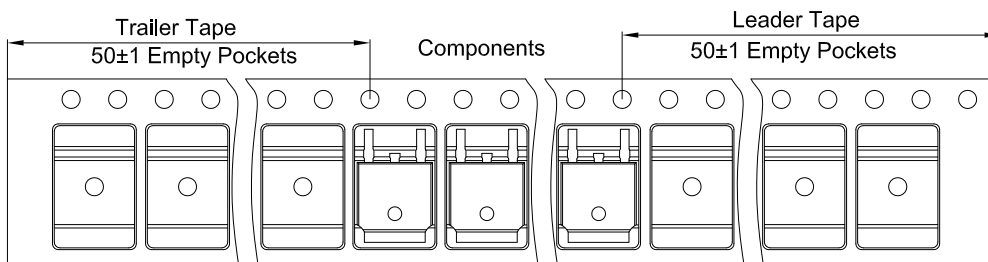

## TO-252 Reel

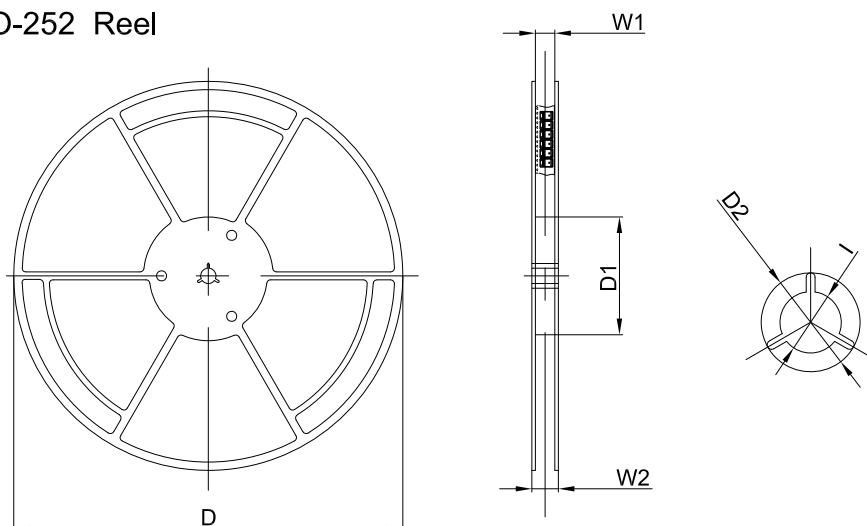

Dimensions are in millimeter						
Reel Option	D	D1	D2	W1	W2	I
13" Dia	330.00	100.00	Ø21.00	16.40	21.00	Ø13.00

REEL	Reel Size	Box	Box Size(mm)	Carton	Carton Size(mm)	G.W.(kg)
2,500 pcs	13inch	2,500 pcs	340×336×29	25,000 pcs	353×346×365	

## X-ON Electronics

Largest Supplier of Electrical and Electronic Components

*Click to view similar products for [MOSFET](#) category:*

*Click to view products by [Changjing Electronics Technology](#) manufacturer:*

Other Similar products are found below :

[614233C](#) [648584F](#) [IRFD120](#) [IRFF430](#) [JANTX2N5237](#) [2N7000](#) [FCA20N60\\_F109](#) [FDZ595PZ](#) [AOD464](#) [2SK2267\(Q\)](#) [2SK2545\(Q,T\)](#)  
[405094E](#) [423220D](#) [MIC4420CM-TR](#) [VN1206L](#) [614234A](#) [715780A](#) [SSM6J414TU,LF\(T](#) [751625C](#) [PSMN4R2-30MLD](#)  
[TK31J60W5,S1VQ\(O](#) [2SK2614\(TE16L1,Q\)](#) [DMN1017UCP3-7](#) [EFC2J004NUZTDG](#) [FCAB21350L1](#) [P85W28HP2F-7071](#) [DMN1053UCP4-7](#)  
[NTE2384](#) [NTE2969](#) [NTE6400A](#) [DMN2080UCB4-7](#) [DMN61D9UWQ-13](#) [US6M2GTR](#) [DMN31D5UDJ-7](#) [SSM6P54TU,LF](#) [DMP22D4UFO-](#)  
[7B](#) [IPS60R3K4CEAKMA1](#) [DMN1006UCA6-7](#) [DMN16M9UCA6-7](#) [STF5N65M6](#) [STU5N65M6](#) [C3M0021120D](#) [DMN13M9UCA6-7](#)  
[BSS340NWH6327XTSA1](#) [MCM3400A-TP](#) [DMTH10H4M6SPS-13](#) [IRF40SC240ARMA1](#) [IPS60R1K0PFD7SAKMA1](#)  
[IPS60R360PFD7SAKMA1](#) [IPS60R600PFD7SAKMA1](#)