

**TO-252-2L Plastic-Encapsulate MOSFETS**

**CJU40N10 N-Channel Power MOSFET**

<b>V<sub>(BR)DSS</sub></b>	<b>R<sub>DS(on)TYP</sub></b>	<b>I<sub>D</sub></b>
100V	14mΩ@10V	40A

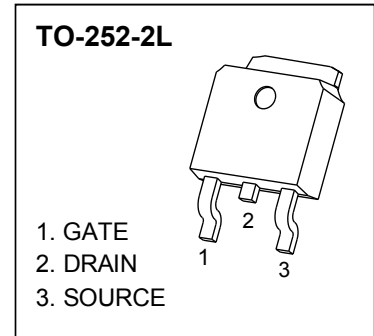

**DESCRIPTION**

This advanced high voltage MOSFET is designed to stand high energy in the avalanche mode and switch efficiently. This new high energy device also offers a drain-to-source diode fast recovery time. Designed for high voltage, high speed switching applications such as power supplies, converters, power motor controls and bridge circuits.

**FEATURES**

- High density cell design for ultra low R<sub>DS(on)</sub>
- Fully characterized avalanche voltage and current
- Good stability and uniformity with high E<sub>AS</sub>
- Special process technology for high ESD capability
- Excellent package for good heat dissipation

**APPLICATIONS**

- Hard switched and high frequency circuits
- Uninterruptible power supply
- Power switching application

**MARKING**

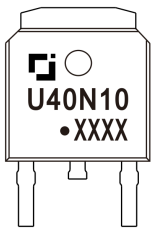

U40N10 = Device code.  
 Solid dot = Green molding compound device if none, the normal device.  
 XXXX = Code.

**EQUIVALENT CIRCUIT**

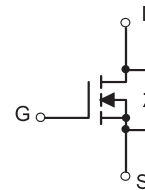

**ABSOLUTE MAXIMUM RATINGS (T<sub>a</sub>=25°C unless otherwise noted)**

Parameter	Symbol	Value	Unit
Drain-Source Voltage (V <sub>DS</sub> )	V <sub>DS</sub>	100	V
Drain-Source Voltage (V <sub>DS</sub> )	V <sub>DS</sub>	100	V
Drain Current (I <sub>D</sub> )	I <sub>D</sub>	40	A
Drain Current (I <sub>D</sub> )	I <sub>D</sub>	160	A
Drain Current (I <sub>D</sub> )	I <sub>D</sub>	320	A
Drain-Source Voltage (V <sub>DS</sub> )	V <sub>DS</sub>	140	V
Drain-Source Voltage (V <sub>DS</sub> )	V <sub>DS</sub>	100	V
Thermal Resistance from Junction to Case	R <sub>θJC</sub>	0.89	°C/W
Operating Junction and Storage Temperature Range	T <sub>J</sub> , T <sub>stg</sub>	-55~+150	°C

# MOSFET ELECTRICAL CHARACTERISTICS

$T_a=25\text{ }^\circ\text{C}$  unless otherwise specified

Parameter	Symbol	Test Condition	Min	Typ	Max	Unit
<b>Off characteristics</b>						
Drain-source breakdown voltage	$V_{(BR)DSS}$	$V_{GS} = 0V, I_D = 250\mu A$	100			V
Zero gate voltage drain current	$I_{DSS}$	$V_{DS} = 80V,$ $V_{GS} = 0V$	$T_J = 25\text{ }^\circ\text{C}$		1	$\mu A$
			$T_J = 125\text{ }^\circ\text{C}$		100	
Gate-body leakage current	$I_{GSS}$	$V_{DS} = 0V, V_{GS} = \pm 20V$			$\pm 100$	nA
<b>On characteristics</b> <sup>④</sup>						
Gate-threshold voltage	$V_{GS(th)}$	$V_{DS} = V_{GS}, I_D = 250\mu A$	2.0	2.7	4.0	V
Static drain-source on-state resistance	$R_{DS(on)}$	$V_{GS} = 10V, I_D = 28A$		14	17	m $\Omega$
Forward transconductance	$g_{FS}$	$V_{DS} = 25V, I_D = 28A$	32			S
<b>Dynamic characteristics</b> <sup>④ ⑤</sup>						
Input capacitance	$C_{iss}$	$V_{DS} = 30V, V_{GS} = 0V,$ $f = 1MHz$		3400	6800	pF
Output capacitance	$C_{oss}$			290	580	
Reverse transfer capacitance	$C_{rss}$			221	390	
<b>Switching characteristics</b> <sup>④ ⑤</sup>						
Total gate charge	$Q_g$	$V_{DS} = 30V, V_{GS} = 10V,$ $I_D = 30A$		94	180	nC
Gate-source charge	$Q_{gs}$			16	34	
Gate-drain charge	$Q_{gd}$			24	45	
Turn-on delay time	$t_{d(on)}$	$V_{DS} = 30V,$ $V_{GS} = 10V, I_D = 2A,$ $R_G = 2.5\Omega, R_L = 15\Omega$		15		ns
Turn-on rise time	$t_r$			11		
Turn-off delay time	$t_{d(off)}$			52		
Turn-off fall time	$t_f$			13		
<b>Drain-Source Diode Characteristics</b>						
Drain-source diode forward voltage	$V_{SD}$ <sup>④</sup>	$V_{GS} = 0V, I_S = 28A$			1.2	V
Continuous drain-source diode forward current	$I_S$ <sup>①</sup>				40	A
Pulsed drain-source diode forward current	$I_{SM}$ <sup>②</sup>				160	A

Notes:

- $T_c = 25\text{ }^\circ\text{C}$  Limited only by maximum temperature allowed.
- $P_{VM} \leq 10\mu s$ , Duty cycle  $\leq 1\%$ .
- EAS condition:  $V_{DD} = 50V, V_{GS} = 10V, L = 0.5mH, R_g = 25\Omega$  Starting  $T_J = 25\text{ }^\circ\text{C}$ .
- Pulse Test : Pulse Width  $\leq 300\mu s$ , duty cycle  $\leq 2\%$ .
- Guaranteed by design, not subject to production.
- The value of  $R_{\theta JA}$  is measured with the device mounted on 1 in 2 FR-4 board with 2oz. Copper, in a still air environment with  $T_a = 25\text{ }^\circ\text{C}$ .

# Typical Characteristics

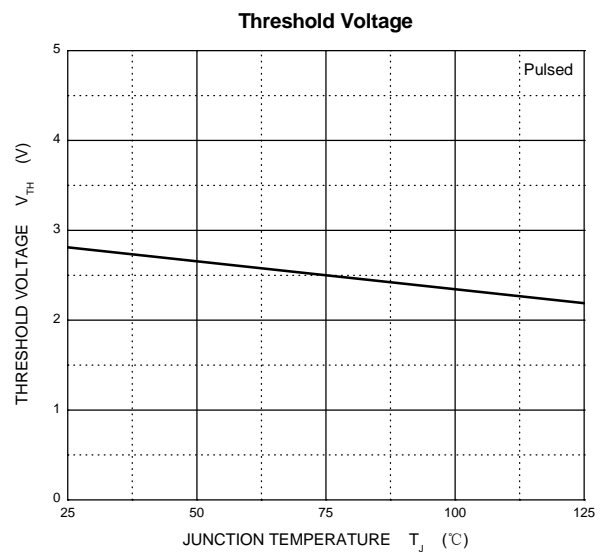
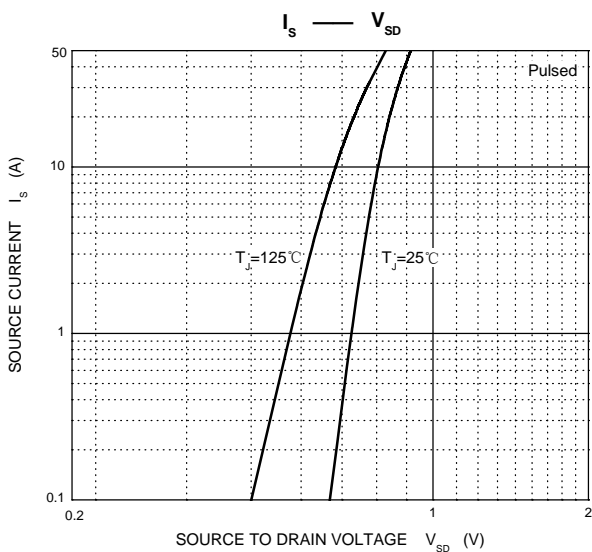
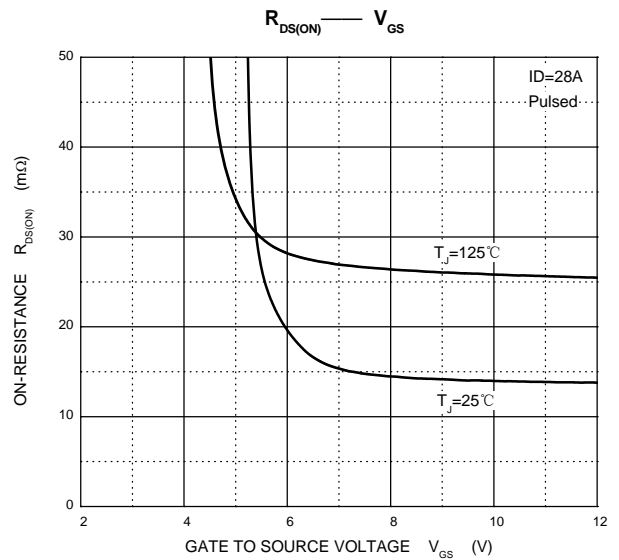
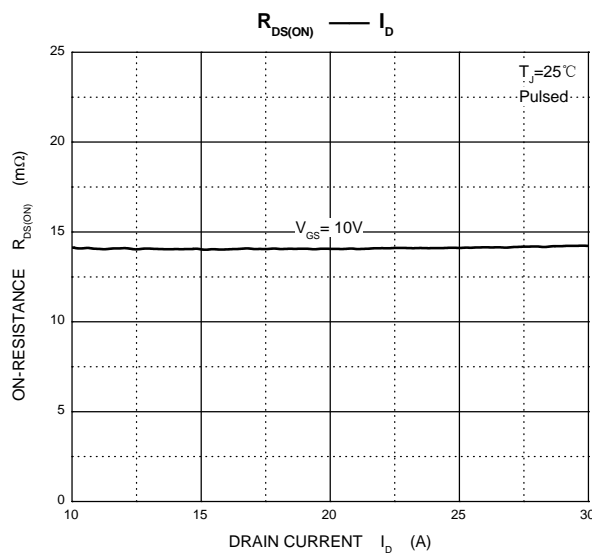
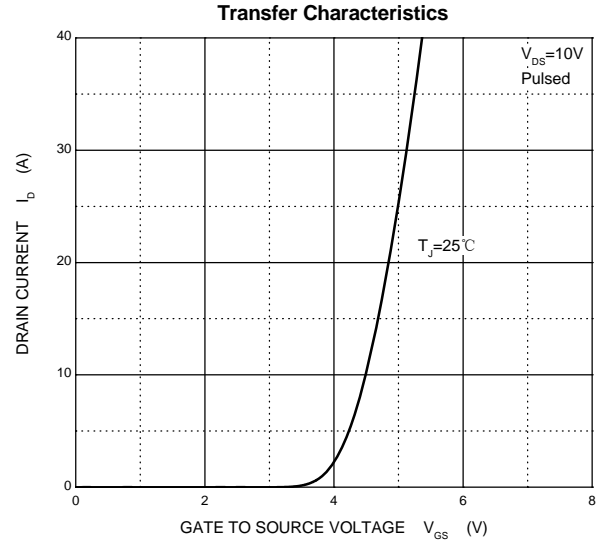
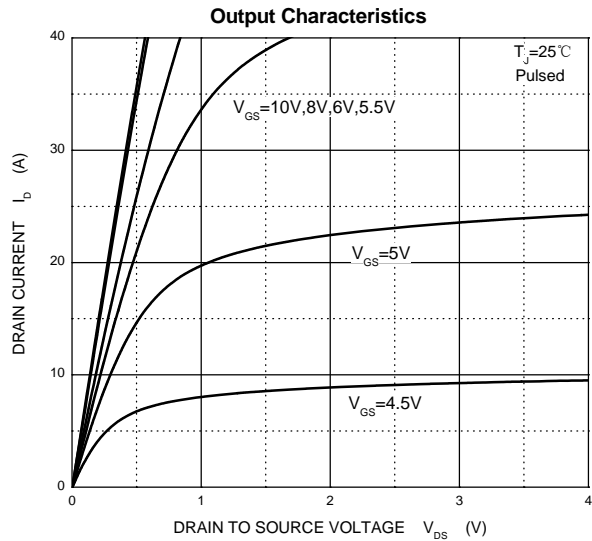

# Typical Characteristics

Capacitances

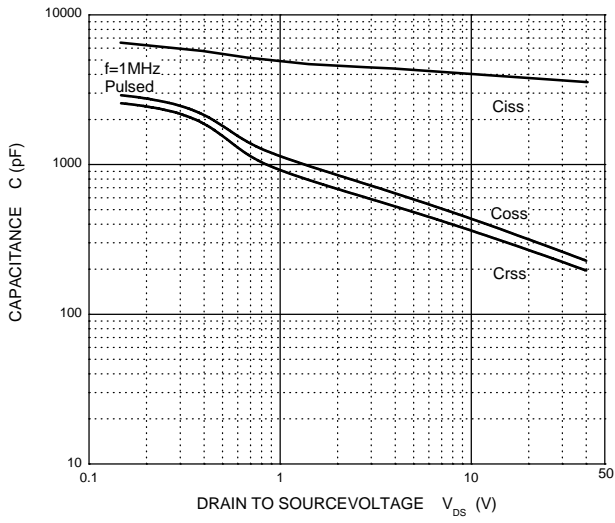

Gate Charge

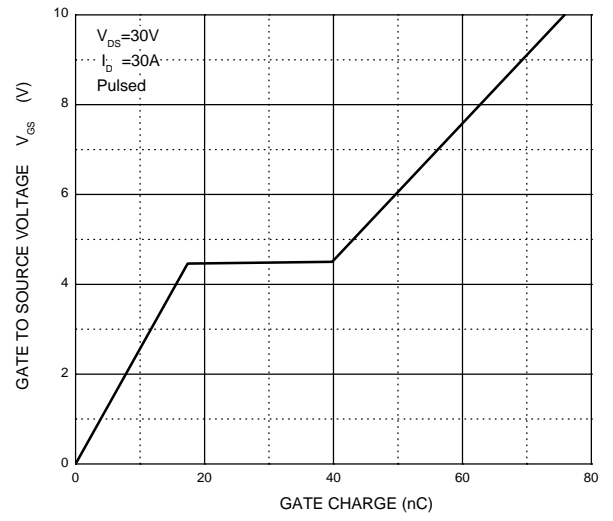

## TO-252-2L Package Outline Dimensions

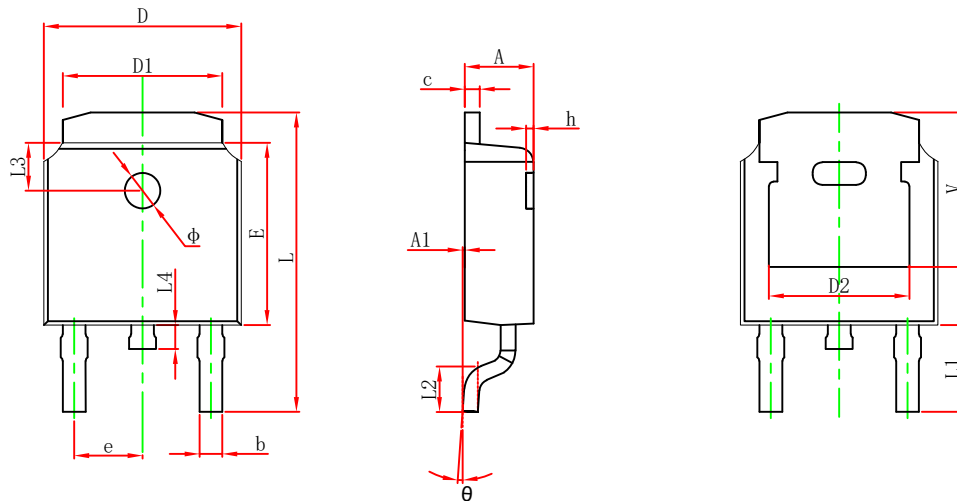

Symbol	Dimensions In Millimeters		Dimensions In Inches	
	Min.	Max.	Min.	Max.
A	2.200	2.400	0.087	0.094
A1	0.000	0.127	0.000	0.005
b	0.635	0.770	0.025	0.030
c	0.460	0.580	0.018	0.023
D	6.500	6.700	0.256	0.264
D1	5.100	5.460	0.201	0.215
D2	4.830 REF.		0.190 REF.	
E	6.000	6.200	0.236	0.244
e	2.186	2.386	0.086	0.094
L	9.712	10.312	0.382	0.406
L1	2.900 REF.		0.114 REF.	
L2	1.400	1.700	0.055	0.067
L3	1.600 REF.		0.063 REF.	
L4	0.600	1.000	0.024	0.039
$\Phi$	1.100	1.300	0.043	0.051
$\theta$	0°	8°	0°	8°
h	0.000	0.300	0.000	0.012
V	5.250 REF.		0.207 REF.	

## TO-252-2L Suggested Pad Layout

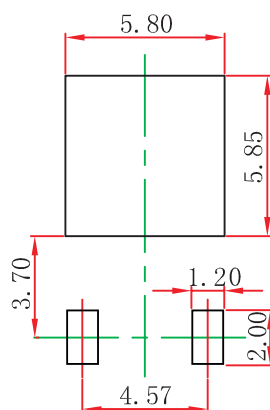

### Note:

1. Controlling dimension: in millimeters.
2. General tolerance:  $\pm 0.05$  mm.
3. The pad layout is for reference purposes only.

### NOTICE

JSCJ reserves the right to make modifications, enhancements, improvements, corrections or other changes without further notice to any product herein. JSCJ does not assume any liability arising out of the application or use of any product described herein.

# TO-252-2L Tape and Reel

## TO-252 Embossed Carrier Tape

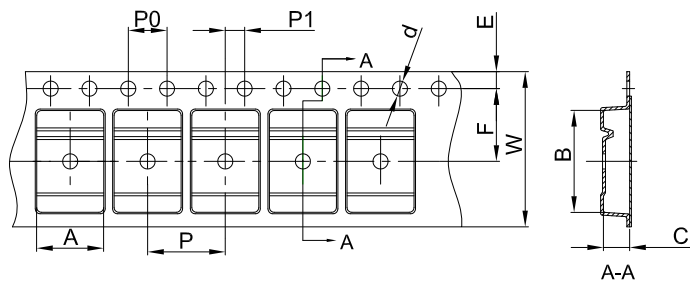

### Packaging Description:

TO-252 parts are shipped in tape. The carrier tape is made from a dissipative (carbon filled) polycarbonate resin. The cover tape is a multilayer film (Heat Activated Adhesive in nature) primarily composed of polyester film, adhesive layer, sealant, and anti-static sprayed agent. These reeled parts in standard option are shipped with 25,00 units per 13" or 33.0 cm diameter reel. The reels are clear in color and is made of polystyrene plastic (anti-static coated).

Dimensions are in millimeter										
Pkg type	A	B	C	d	E	F	P0	P	P1	W
TO-252	6.90	10.50	2.70	Ø1.55	1.75	7.50	4.00	8.00	2.00	16.00

## TO-252 Tape Leader and Trailer

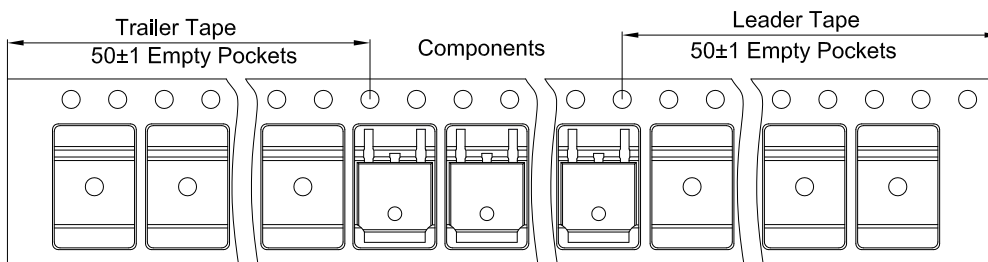

## TO-252 Reel

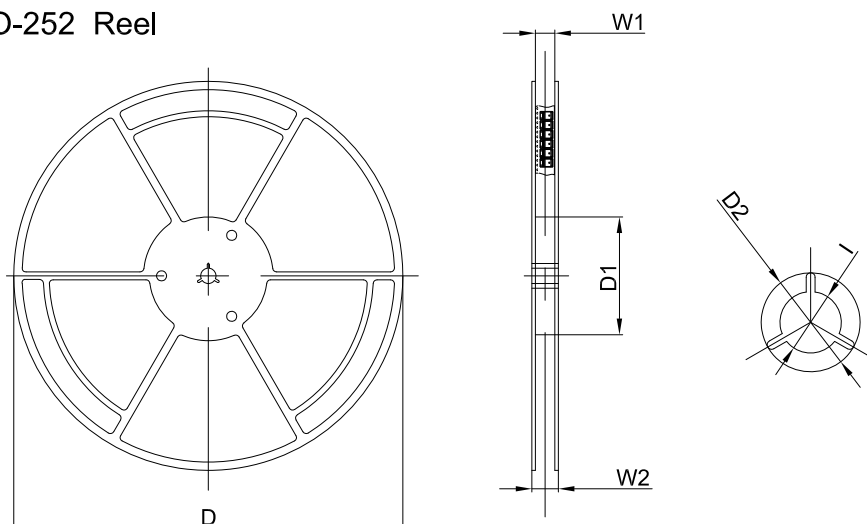

Dimensions are in millimeter						
Reel Option	D	D1	D2	W1	W2	I
13" Dia	330.00	100.00	Ø21.00	16.40	21.00	Ø13.00

REEL	Reel Size	Box	Box Size(mm)	Carton	Carton Size(mm)	G.W.(kg)
2,500 pcs	13inch	2,500 pcs	340×336×29	25,000 pcs	353×346×365	

## X-ON Electronics

Largest Supplier of Electrical and Electronic Components

*Click to view similar products for [MOSFET](#) category:*

*Click to view products by [Changjing Electronics Technology](#) manufacturer:*

Other Similar products are found below :

[614233C](#) [648584F](#) [IRFD120](#) [IRFF430](#) [JANTX2N5237](#) [2N7000](#) [FCA20N60\\_F109](#) [FDZ595PZ](#) [AOD464](#) [2SK2267\(Q\)](#) [2SK2545\(Q,T\)](#)  
[405094E](#) [423220D](#) [MIC4420CM-TR](#) [VN1206L](#) [614234A](#) [715780A](#) [SSM6J414TU,LF\(T](#) [751625C](#) [PSMN4R2-30MLD](#)  
[TK31J60W5,S1VQ\(O](#) [2SK2614\(TE16L1,Q\)](#) [DMN1017UCP3-7](#) [EFC2J004NUZTDG](#) [FCAB21350L1](#) [P85W28HP2F-7071](#) [DMN1053UCP4-7](#)  
[NTE2384](#) [NTE2969](#) [NTE6400A](#) [DMN2080UCB4-7](#) [DMN61D9UWQ-13](#) [US6M2GTR](#) [DMN31D5UDJ-7](#) [SSM6P54TU,LF](#) [DMP22D4UFO-](#)  
[7B](#) [IPS60R3K4CEAKMA1](#) [DMN1006UCA6-7](#) [DMN16M9UCA6-7](#) [STF5N65M6](#) [STU5N65M6](#) [C3M0021120D](#) [DMN13M9UCA6-7](#)  
[BSS340NWH6327XTSA1](#) [MCM3400A-TP](#) [DMTH10H4M6SPS-13](#) [IRF40SC240ARMA1](#) [IPS60R1K0PFD7SAKMA1](#)  
[IPS60R360PFD7SAKMA1](#) [IPS60R600PFD7SAKMA1](#)