

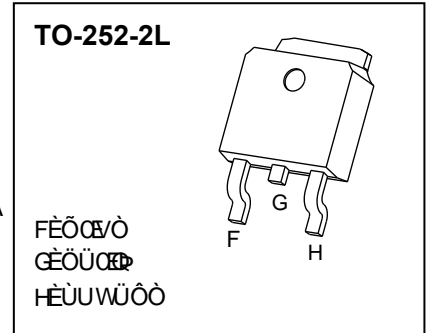

TO-252-2L Plastic-Encapsulate MOSFETS

CJU40P03 **ÁP-Channel Power MOSFET**

$V_{(BR)DSS}$	$R_{DS(on)TYP}$	I_D
Ë€X	F€ O Ë€X	Ë €E
	FI { O Ë ËX	



GENERAL DESCRIPTION

V@ÁÖRM €Ú€Á••Áœœœ &^áÁ^} &@€&@ [|| *^ Áœ áÁÁ•ã } ÁŒ Á [çã^Áœ&^} ó Úöüç) á äö [, Á œ Áœ *^ÉÖœ ÁÁÁ•^áÁ Áœ ä^Áœáœ ç Á Áœ] |äœ } •É

FEATURE

- Çãœœ &^áÁ^} &@€&@ [|| *^
- Ü^|äœ|^Áœ áÁ•**^á
- Pã Çã^} • œ Áœ|^ÁÁ•ã } ÁŒ |Á |dœ [, ÁŒ] ËÜ^•ã œœ &

APPLICATION

- Ú [, ^Á Á œ œ ^{ ^ } ó Á [çã [\ ÁŒ {] ~ ç]
- Ú [çã |^Á ~ ç { ^ } ó á Áœ çã Á [, ^Á áÁ • ç { •

MARKING

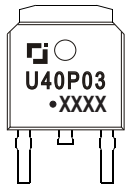

W €Ú€HMÖ^çã^ÁŒ á^ÉÁ
 Ú [ä Á [çã Ö^Á } Á [|á ç * ÁŒ {] [~ } á Áœ çã Á Á
 ä Á [] ^Éö ç Á [| { çã^çã^É
 YYY Y MÖ [á^É

EQUIVALENT CIRCUIT

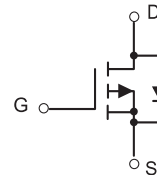

MAXIMUM RATINGS (T_a=25°C unless otherwise noted)

Parameter	Symbol	Limit	Unit
Ö: äœ ËÜ [~ &^ÁŒ çœ ^Á	X _{óÚ} Á	Ë€	XÁ
Ö œ ^ÉÜ [~ &^ÁŒ çœ ^Á	X _{óÚ} Á	† GEÁ	XÁ
Ö [} çã ~ [~ •ÁÖ: äœ ÁÖ^ ^ } ó	Q _Á ^①	Ë €	çÁ
Ú ~ •^áÁÖ: äœ ÁÖ^ ^ } ó	Q _T ^①	Ë† €	çÁ
Ú çã * ^ÁŒ ~ •^áÁÖ: çãœ &@ÁÖ) ^ ^ Á	Ö _{œÁ} ^①	G€€	{ RÁ
Ú [, ^Á ÁÖ • ç äœ } Á	Ú _{óÁ} ^①	75	Y Á
V@ { çãÜ^•ã œœ &^ÁŒ [{ ÁŒ } &ç } ÁŒ Áœ äã } ó	Ü _{ROÁ} ^①	100	°ÇY Á
V@ { çãÜ^•ã œœ &^ÁŒ [{ ÁŒ } &ç } ÁŒ Áœ^Á	Ü _{ROÁ} ^①	1.67	°ÇY Á
U ^ äœ * ÁŒ } &ç } Áœ äÁŒ çœ ^ÁŒ [] ^ œ ^ÁŒ çã *^Á	T _J , T _{stg}	-55~+150	°C

MOSFET ELECTRICAL CHARACTERISTICS

$T_a=25\text{ }^\circ\text{C}$ unless otherwise specified

Parameter	Symbol	Test Condition	Min	Typ	Max	Unit
Off characteristics						
Drain-source breakdown voltage	$V_{(BR)DSS}$	$V_{GS} = 0V, I_D = -250\mu A$	-30			V
Zero gate voltage drain current	I_{DSS}	$V_{DS} = -24V, V_{GS} = 0V$	$T_J = 25\text{ }^\circ\text{C}$		1	μA
			$T_J = 125\text{ }^\circ\text{C}$		100	
Gate-body leakage current	I_{GSS}	$V_{DS} = 0V, V_{GS} = \pm 20V$			± 100	nA
On characteristics ④						
Gate-threshold voltage	$V_{GS(th)}$	$V_{DS} = V_{GS}, I_D = -250\mu A$	-1	-1.53	-2.5	V
Static drain-source on-state resistance	$R_{DS(on)}$	$V_{GS} = -10V, I_D = -20A$		10	15	$m\Omega$
	$R_{DS(on)}$	$V_{GS} = -4.5V, I_D = -15A$		14	25	$m\Omega$
Dynamic characteristics ④ ⑤						
Input capacitance	C_{iss}	$V_{DS} = -15V, V_{GS} = 0V, f = 1MHz$		2380	4760	pF
Output capacitance	C_{oss}			385	770	
Reverse transfer capacitance	C_{rss}			288	576	
Switching characteristics ④ ⑤						
Total gate charge	Q_g	$V_{DS} = -15V, V_{GS} = -10V, I_D = -12A$		40	80	nC
Gate-source charge	Q_{gs}			7.5	15	
Gate-drain charge	Q_{gd}			10	20	
Turn-on delay time	$t_{d(on)}$	$V_{DD} = -15V, V_{GS} = -10V, R_G = 15\Omega, R_L = 2.5\Omega$		11		ns
Turn-on rise time	t_r			24		
Turn-off delay time	$t_{d(off)}$			35		
Turn-off fall time	t_f			10		
Drain-Source Diode Characteristics						
Drain-source diode forward voltage	V_{SD} ④	$V_{GS} = 0V, I_S = -10A$			-1.2	V
Continuous drain-source diode forward current	I_S ①				-40	A
Pulsed drain-source diode forward current	I_{SM} ②				-160	A

Notes:

- $T_C = 25\text{ }^\circ\text{C}$ Limited only by maximum temperature allowed.
- $P_W \leq 10\mu s$, Duty cycle $\leq 1\%$.
- EAS condition: $V_{DD} = -15V, V_{GS} = -10V, L = 0.5mH, R_g = 25\Omega$ Starting $T_J = 25\text{ }^\circ\text{C}$.
- Pulse Test : Pulse Width $\leq 300\mu s$, duty cycle $\leq 2\%$.
- Guaranteed by design, not subject to production.
- The value of $R_{\theta JA}$ is measured with the device mounted on 1 in 2 FR-4 board with 2oz. Copper, in a still air environment with $T_a = 25\text{ }^\circ\text{C}$.

Typical Characteristics

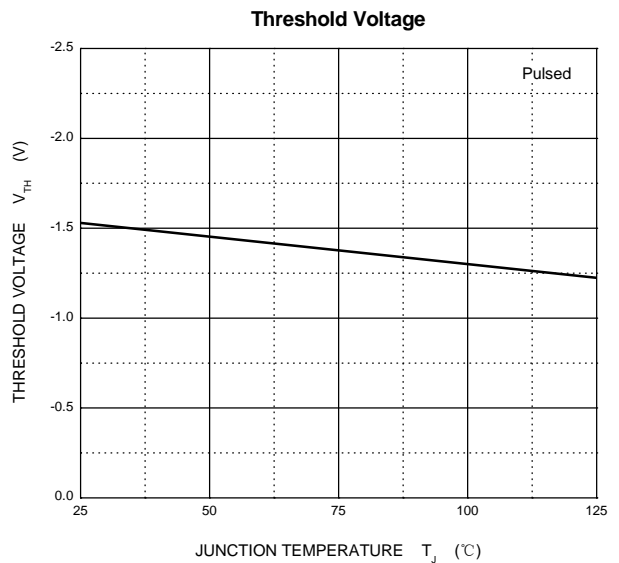
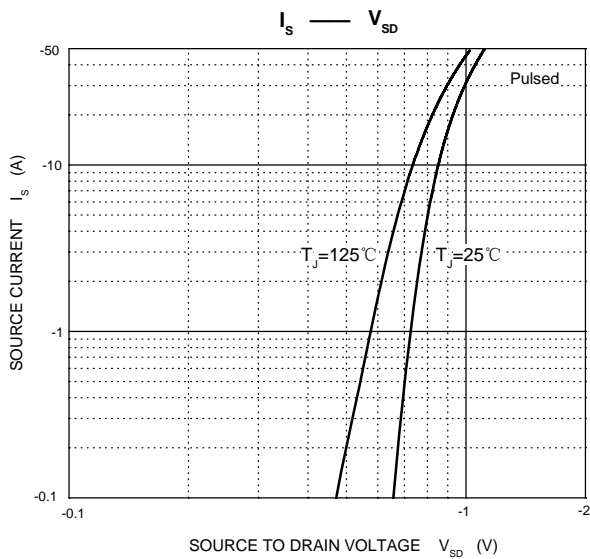
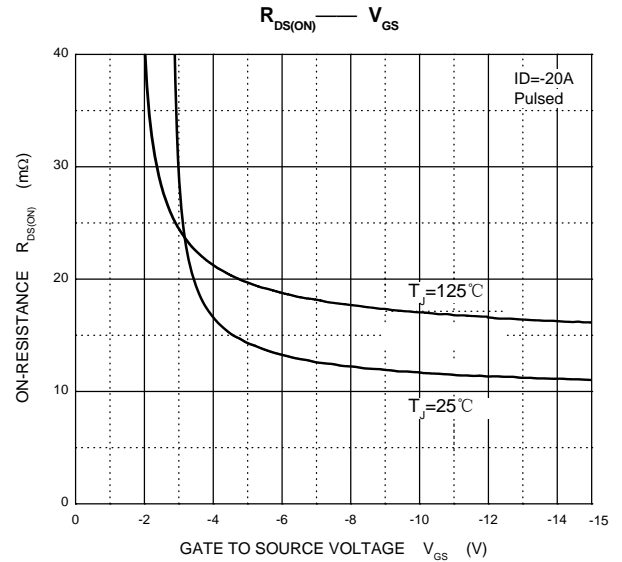
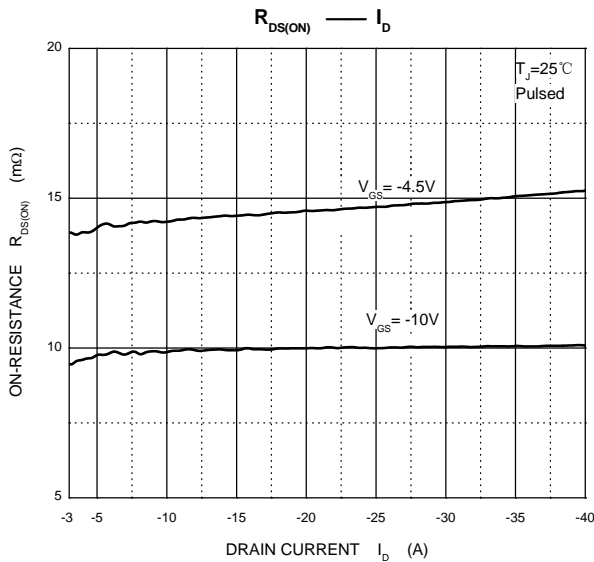
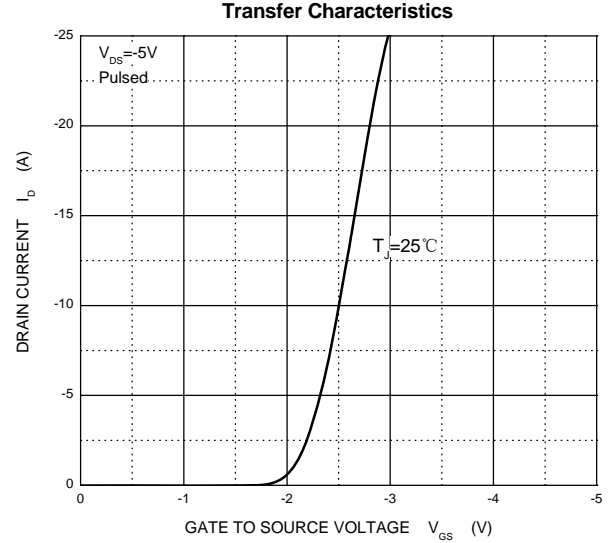
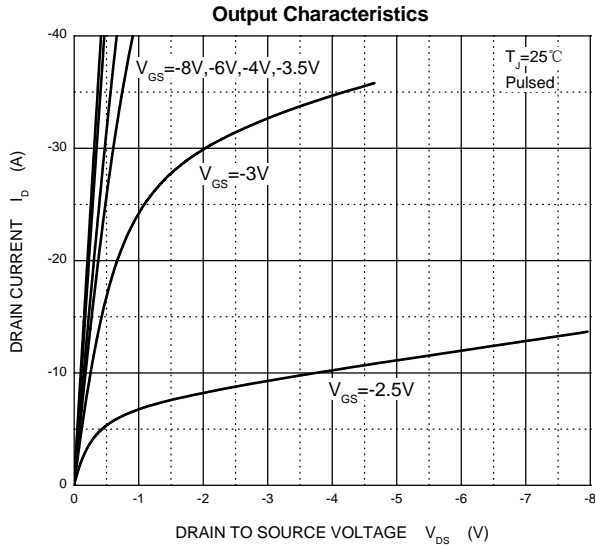

TO-252-2L Package Outline Dimensions

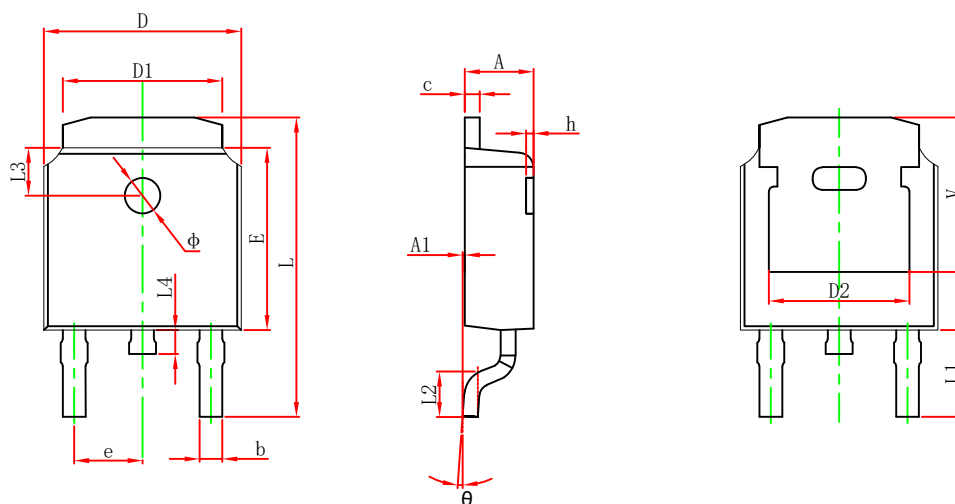

Symbol	Dimensions In Millimeters		Dimensions In Inches	
	Min.	Max.	Min.	Max.
A	2.200	2.400	0.087	0.094
A1	0.000	0.127	0.000	0.005
b	0.635	0.770	0.025	0.030
c	0.460	0.580	0.018	0.023
D	6.500	6.700	0.256	0.264
D1	5.100	5.460	0.201	0.215
D2	4.830 REF.		0.190 REF.	
E	6.000	6.200	0.236	0.244
e	2.186	2.386	0.086	0.094
L	9.712	10.312	0.382	0.406
L1	2.900 REF.		0.114 REF.	
L2	1.400	1.700	0.055	0.067
L3	1.600 REF.		0.063 REF.	
L4	0.600	1.000	0.024	0.039
Φ	1.100	1.300	0.043	0.051
θ	0°	8°	0°	8°
h	0.000	0.300	0.000	0.012
V	5.250 REF.		0.207 REF.	

TO-252-2L Suggested Pad Layout

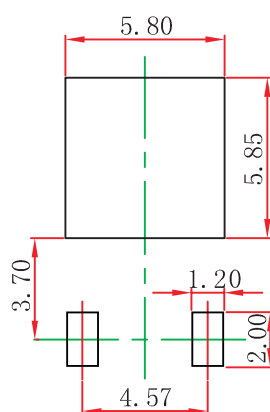

- Note:
1. Controlling dimension: in millimeters.
 2. General tolerance: ± 0.05 mm.
 3. The pad layout is for reference purposes only.

NOTICE

JSCJ reserves the right to make modifications, enhancements, improvements, corrections or other changes without further notice to any product herein. JSCJ does not assume any liability arising out of the application or use of any product described herein.

TO-252-2L Tape and Reel

TO-252 Embossed Carrier Tape

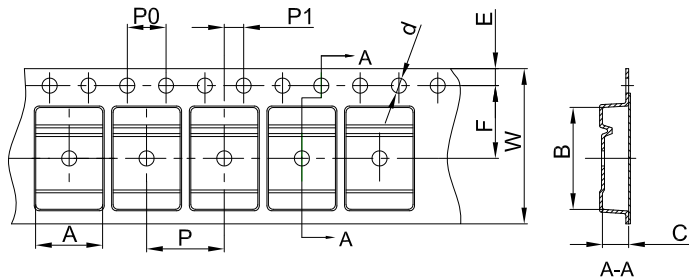

Packaging Description:

TO-252 parts are shipped in tape. The carrier tape is made from a dissipative (carbon filled) polycarbonate resin. The cover tape is a multilayer film (Heat Activated Adhesive in nature) primarily composed of polyester film, adhesive layer, sealant, and anti-static sprayed agent. These reeled parts in standard option are shipped with 25,00 units per 13" or 33.0 cm diameter reel. The reels are clear in color and is made of polystyrene plastic (anti-static coated).

Dimensions are in millimeter										
Pkg type	A	B	C	d	E	F	P0	P	P1	W
TO-252	6.90	10.50	2.70	Ø1.55	1.75	7.50	4.00	8.00	2.00	16.00

TO-252 Tape Leader and Trailer

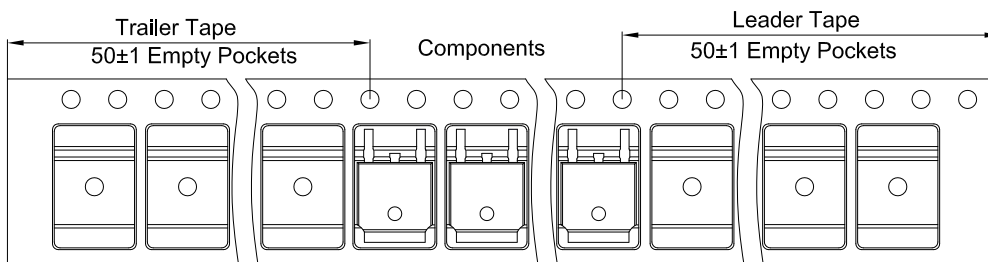

TO-252 Reel

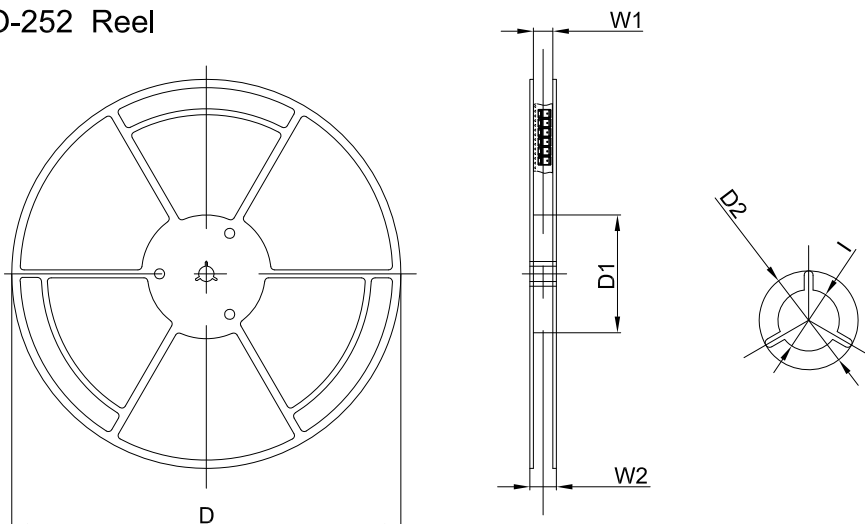

Dimensions are in millimeter						
Reel Option	D	D1	D2	W1	W2	I
13" Dia	330.00	100.00	Ø21.00	16.40	21.00	Ø13.00

REEL	Reel Size	Box	Box Size(mm)	Carton	Carton Size(mm)	G.W.(kg)
2,500 pcs	13inch	2,500 pcs	340×336×29	25,000 pcs	353×346×365	

X-ON Electronics

Largest Supplier of Electrical and Electronic Components

Click to view similar products for [MOSFET](#) category:

Click to view products by [Changjing Electronics Technology](#) manufacturer:

Other Similar products are found below :

[IRFD120](#) [JANTX2N5237](#) [2SK2267\(Q\)](#) [BUK455-60A/B](#) [TK100A10N1,S4X\(S](#) [MIC4420CM-TR](#) [VN1206L](#) [NDP4060](#) [SI4482DY](#)
[IRS2092STRPBF-EL](#) [IPS70R2K0CEAKMA1](#) [TK31J60W5,S1VQ\(O](#) [TK31J60W,S1VQ\(O](#) [TK16J60W,S1VQ\(O](#) [2SK2614\(TE16L1,Q\)](#)
[DMN1017UCP3-7](#) [EFC2J004NUZTDG](#) [P85W28HP2F-7071](#) [DMN1053UCP4-7](#) [NTE2384](#) [DMC2700UDMQ-7](#) [DMN2080UCB4-7](#)
[DMN61D9UWQ-13](#) [US6M2GTR](#) [DMN31D5UDJ-7](#) [DMP22D4UFO-7B](#) [IPS60R3K4CEAKMA1](#) [DMN1006UCA6-7](#) [DMN16M9UCA6-7](#)
[STF5N65M6](#) [IRF40H233XTMA1](#) [STU5N65M6](#) [DMN6022SSD-13](#) [DMN13M9UCA6-7](#) [DMTH10H4M6SPS-13](#) [IPS60R360PFD7SAKMA1](#)
[DMN2990UFB-7B](#) [SSM3K35CT,L3F](#) [IPLK60R1K0PFD7ATMA1](#) [2N7002W-G](#) [MCAC30N06Y-TP](#) [IPWS65R035CFD7AXKSA1](#)
[MCQ7328-TP](#) [SSM3J143TU,LXHF](#) [DMN12M3UCA6-7](#) [PJMF280N65E1_T0_00201](#) [PJMF380N65E1_T0_00201](#)
[PJMF280N60E1_T0_00201](#) [PJMF600N65E1_T0_00201](#) [PJMF900N65E1_T0_00201](#)