



## SOT-143 Plastic-Encapsulate Diodes

### ESDU5V0G3 Uni-direction ESD Protection Diode

#### DESCRIPTION

Designed to protect voltage sensitive electronic components from ESD and other transients. Excellent clamping capability, low leakage, low capacitance, and fast response time provide best in class protection on designs that are exposed to ESD.

The combination of small size, low capacitance, and high level of ESD protection makes them a flexible solution for applications such as HDMI, Display Port TM, and MDDI interfaces. It is designed to replace multiplayer varistors (MLV) in consumer equipments applications such as mobile phone, notebook, PAD, STB, LCD TV etc.

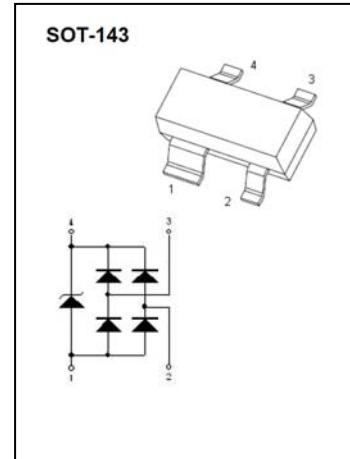

#### FEATURES

- Uni-directional ESD protection of two lines
- Low capacitance: 0.8pF(Max)
- Low reverse stand-off voltage: 5V
- Low reverse clamping voltage
- Low leakage current
- Excellent package: 2.9mm×1.3mm×1.0mm
- Fast response time
- JESD22-A114-B ESD Rating of class 3B per human body model
- IEC 61000-4-2 Level 4 ESD protection

#### APPLICATIONS

- USB2.0 power & data line protection
- WLAN/LAN equipment
- Mobile phone
- Video line protection
- Microcontroller input Protection
- ISDN S/T Interface
- Other electronics equipments
- Communication systems

#### MARKING



Front side

U5V0 = Device code  
Solid dot = Green molding compound device

**MAXIMUM RATINGS (  $T_a=25^{\circ}\text{C}$  unless otherwise noted )**

Parameter	Symbol	Limit	Unit
IEC 61000-4-2 ESD Voltage	Air Model	$\pm 25$	kV
	Contact Model	$\pm 25$	
	Per Human Body Model	$\pm 16$	
	Machine Model	$\pm 0.4$	
JESD22-A114-B ESD Voltage	$V_{\text{ESD}}^{(1)}$		
ESD Voltage			
Peak Pulse Power	$P_{\text{PP}}^{(2)}$	90	W
Peak Pulse Current	$I_{\text{PP}}^{(2)}$	3.5	A
Lead Solder Temperature – Maximum (10 Second Duration)	$T_L$	260	$^{\circ}\text{C}$
Storage Temperature Range	$T_J, T_{\text{stg}}$	-55 ~ +150	$^{\circ}\text{C}$

(1).Device stressed with ten non-repetitive ESD pulses.

(2).Non-repetitive current pulse 8/20 $\mu\text{s}$  exponential decay waveform according to IEC61000-4-5.

**ESD standards compliance**

**IEC61000-4-2 Standard**

Contact Discharge		Air Discharge	
Level	Test Voltage kV	Level	Test Voltage kV
1	2	1	2
2	4	2	4
3	6	3	8
4	8	4	15

**JESD22-A114-B Standard**

ESD Class	Human Body Discharge V
0	0~249
1A	250~499
1B	500~999
1C	1000~1999
2	2000~3999
3A	4000~7999
3B	8000~15999

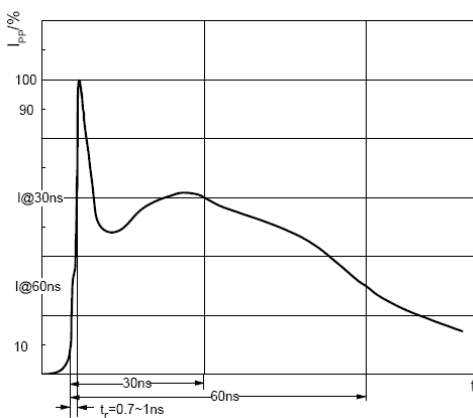

ESD pulse waveform according to IEC61000-4-2

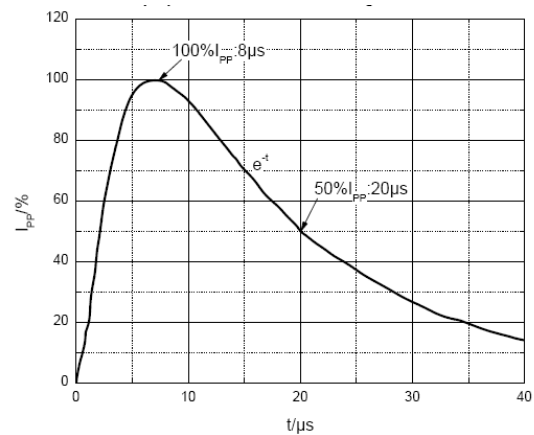

8/20 $\mu\text{s}$  pulse waveform according to IEC 61000-4-5

**ELECTRICAL PARAMETER**

Symbol	Parameter
V <sub>C</sub>	Clamping Voltage @ I <sub>PP</sub>
I <sub>PP</sub>	Peak Pulse Current
V <sub>BR</sub>	Breakdown Voltage @ I <sub>T</sub>
I <sub>T</sub>	Test Current
I <sub>R</sub>	Reverse Leakage Current @ V <sub>RWM</sub>
V <sub>RWM</sub>	Reverse Standoff Voltage
V <sub>F</sub>	Forward Voltage@ I <sub>F</sub>
I <sub>F</sub>	Forward Current



V-I characteristics for a uni-directional TVS

**ELECTRICAL CHARACTERISTICS(T<sub>a</sub>=25°C unless otherwise specified)**

Parameter	Symbol	Test conditions	Min	Typ	Max	Unit
Per channel(I/O to GND unless otherwise specified)						
Reverse stand off voltage	V <sub>RWM</sub> <sup>(1)</sup>				5	V
Breakdown voltage	V <sub>(BR)</sub>	I <sub>T</sub> =1mA	6		10	V
		I <sub>T</sub> =1mA V <sub>CC</sub> to GND	5		12	V
Reverse leakage current	I <sub>R</sub>	V <sub>RWM</sub> =5V (I/O to GND & V <sub>CC</sub> to GND)			1	μA
Forward voltage	V <sub>F</sub>	I <sub>F</sub> =10mA (GND to I/O & GND to V <sub>CC</sub> )	0.4		1.5	V
Clamping voltage	V <sub>C</sub> <sup>(2)</sup>	I <sub>PP</sub> =1A (I/O to GND & V <sub>CC</sub> to GND)			13	V
		I <sub>PP</sub> =3.5A (I/O to GND & V <sub>CC</sub> to GND)			25	V
Junction capacitance	C <sub>J</sub>	V <sub>R</sub> =0V,f=1MHz			0.8	pF
		V <sub>R</sub> =0V,f=1MHz, I/O to I/O			0.4	pF

(1).Other voltages available upon request.

(2).Non-repetitive current pulse 8/20μs exponential decay waveform according to IEC61000-4-5

TYPICAL CHARACTERISTICS

Forward Characteristics

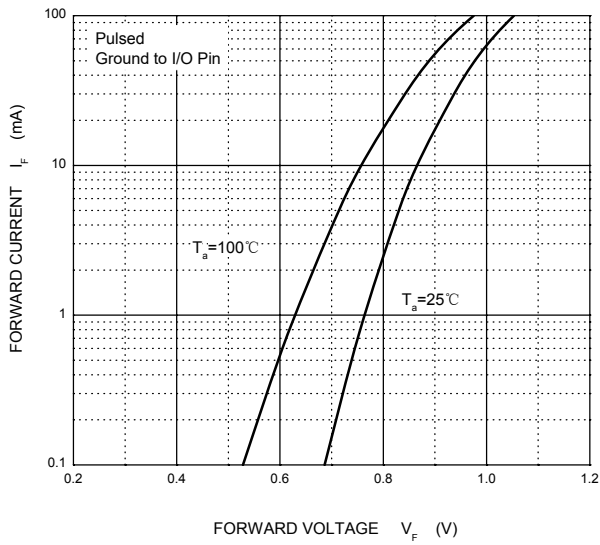

Forward Characteristics

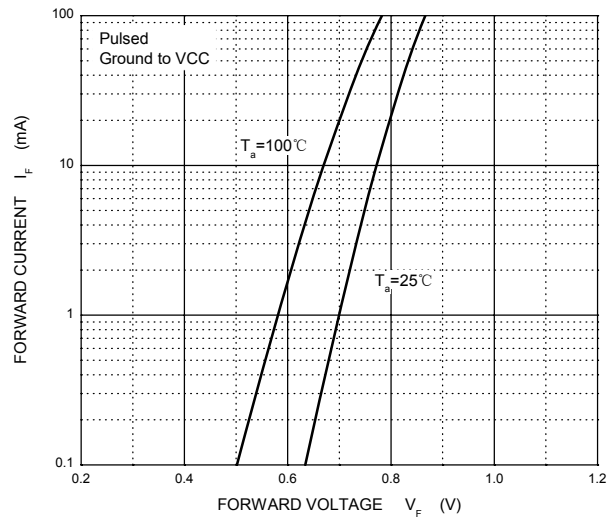

Reverse Characteristics

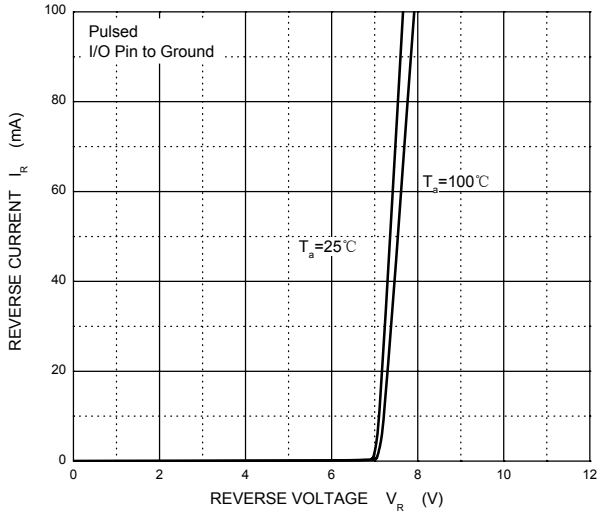

Reverse Characteristics

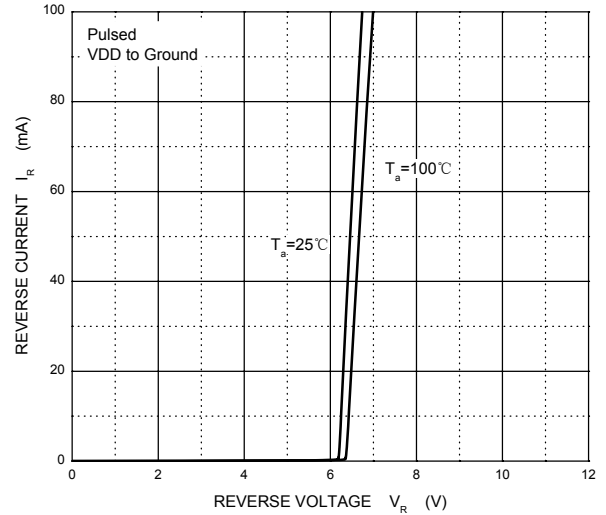

$V_C$  —  $I_{PP}$

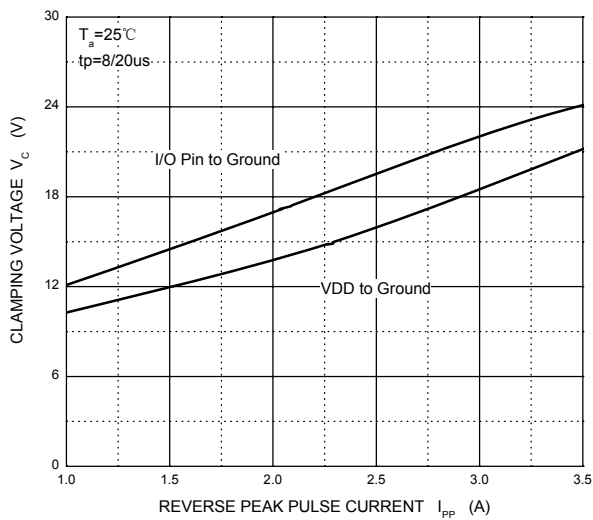

Capacitance Characteristics

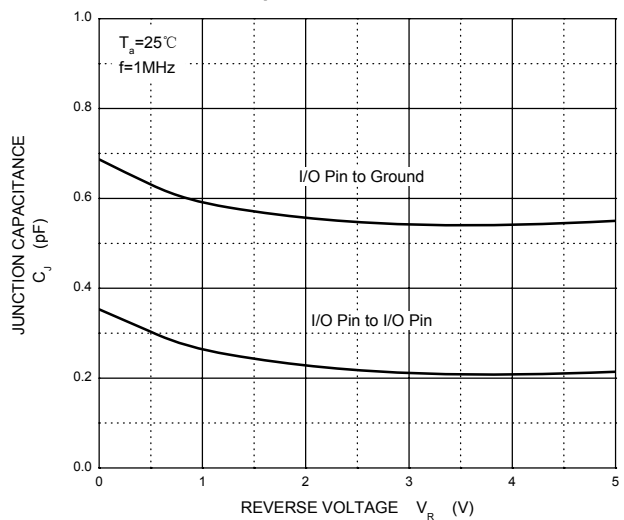

PACKAGE OUTLINE AND PAD LAYOUT INFORMATION

SOT-143 Package Outline Dimensions

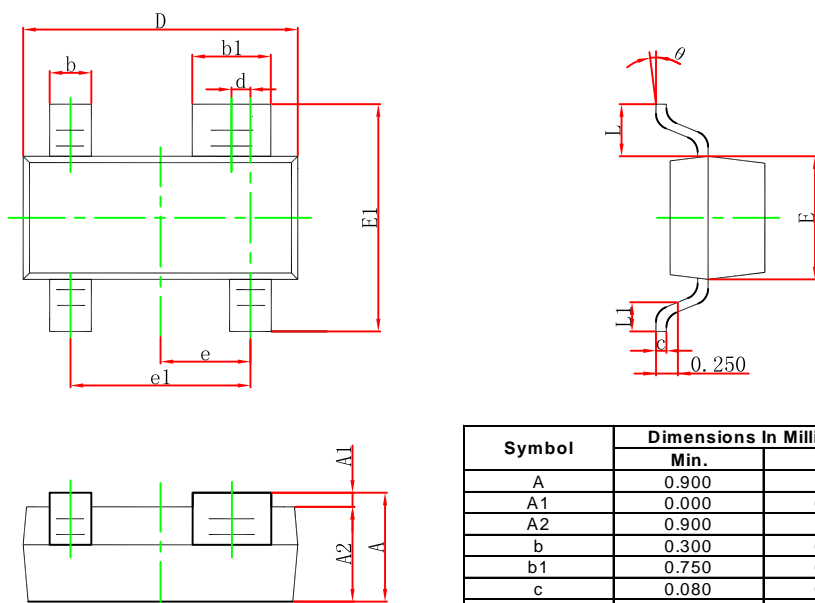

Symbol	Dimensions In Millimeters		Dimensions In Inches	
	Min.	Max.	Min.	Max.
A	0.900	1.150	0.035	0.045
A1	0.000	0.100	0.000	0.004
A2	0.900	1.050	0.035	0.041
b	0.300	0.500	0.012	0.020
b1	0.750	0.900	0.030	0.035
c	0.080	0.150	0.003	0.006
D	2.800	3.000	0.110	0.118
d	0.200 TYP.		0.008 TYP.	
E	1.200	1.400	0.047	0.055
E1	2.250	2.550	0.089	0.100
e	0.950 TYP.		0.037 TYP.	
e1	1.800	2.000	0.071	0.079
L	0.550 REF.		0.022 REF.	
L1	0.300	0.500	0.012	0.020
θ	0°	8°	0°	8°

SOT-143 Suggested Pad Layout

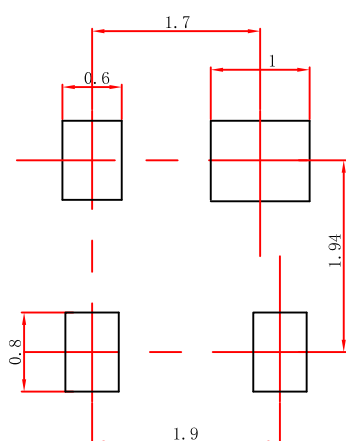

Note:

- 1.Controlling dimension:in millimeters.
- 2.General tolerance:± 0.05mm.
- 3.The pad layout is for reference purposes only.

NOTICE

JSCJ reserves the right to make modifications,enhancements,improvements,corrections or other changes without further notice to any product herein. JSCJ does not assume any liability arising out of the application or use of any product described herein.

TAPE AND REEL INFORMATION

SOT-143 Embossed Carrier Tape

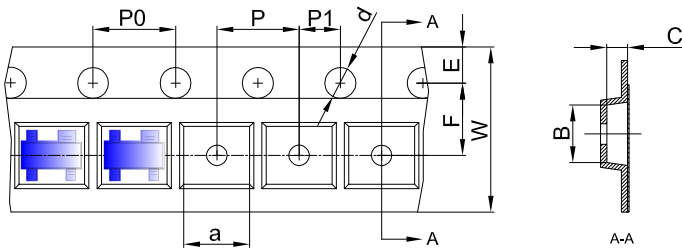

Packaging Description:

SOT-143 parts are shipped in tape. The carrier tape is made from a dissipative (carbon filled) polycarbonate resin. The cover tape is a multilayer film (Heat Activated Adhesive in nature) primarily composed of polyester film, adhesive layer, sealant, and anti-static sprayed agent. These reeled parts in standard option are shipped with 3,000 units per 7" or 17.8cm diameter reel. The reels are clear in color and is made of polystyrene plastic (anti-static coated).

Dimensions are in millimeter										
Pkg type	a	B	C	d	E	F	P0	P	P1	W
SOT-143	3.19	2.80	1.31	Ø1.50	1.75	3.50	4.00	4.00	2.00	8.00

SOT-143 Tape Leader and Trailer

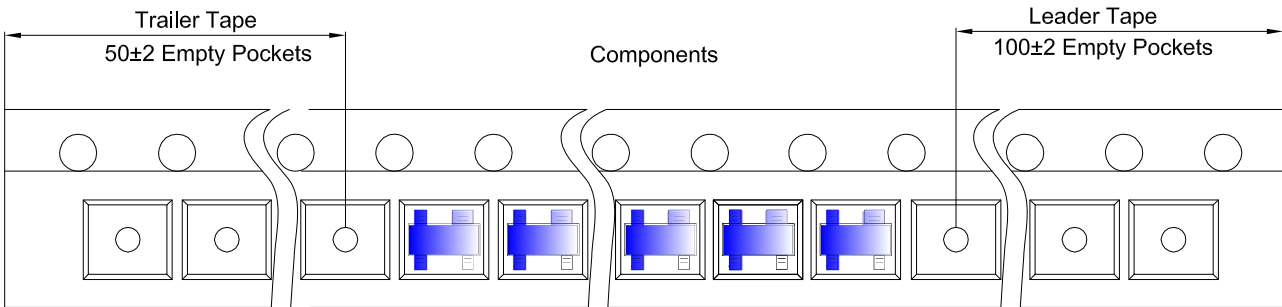

SOT-143 Reel

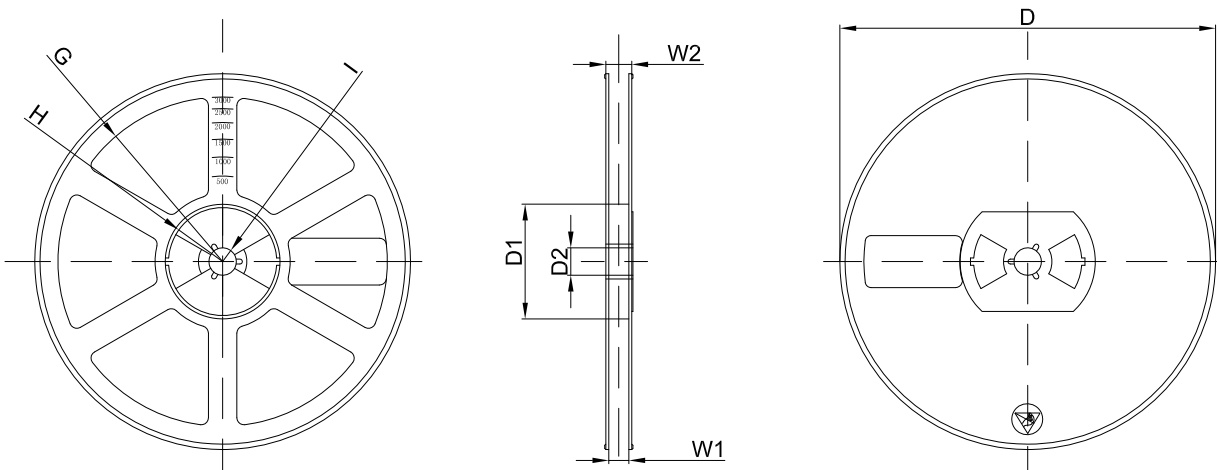

Dimensions are in millimeter								
Reel Option	D	D1	D2	G	H	I	W1	W2
7"Dia	Ø178.00	54.40	13.00	R78.00	R25.60	R6.50	9.50	12.30

REEL	Reel Size	Box	Box Size(mm)	Carton	Carton Size(mm)	G.W.(kg)
3000 pcs	7 inch	45,000 pcs	203×203×195	180,000 pcs	438×438×220	

## X-ON Electronics

Largest Supplier of Electrical and Electronic Components

*Click to view similar products for* [ESD Suppressors / TVS Diodes](#) *category:*

*Click to view products by* [Changjing Electronics Technology](#) *manufacturer:*

Other Similar products are found below :

[60KS200C](#) [D18V0L1B2LP-7B](#) [D5V0F4U5P5-7](#) [NTE4902](#) [P4KE27CA](#) [P6KE11CA](#) [P6KE8.2A](#) [SA60CA](#) [SA64CA](#) [SMBJ12CATR](#)  
[SMBJ33CATR](#) [SMBJ6.5A](#) [SMBJ8.0A](#) [ESD101-B1-02ELS](#) [E6327](#) [ESD112-B1-02EL](#) [E6327](#) [ESD7451N2T5G](#) [19180-510](#) [CPDT-5V0USP-](#)  
[HF](#) [3.0SMCJ33CA-F](#) [3.0SMCJ36A-F](#) [HSPC16701B02TP](#) [JANTX1N6126A](#) [D3V3Q1B2DLP3-7](#) [D55V0M1B2WS-7](#) [SCM1293A-04SO](#)  
[ESD200-B1-CSP0201](#) [E6327](#) [SM12-7](#) [CEN955](#) [W/DATA](#) [VESD12A1A-HD1-GS08](#) [CPDQC5V0-HF](#) [D1213A-01LP4-7B](#) [ESD101-B1-02EL](#)  
[E6327](#) [AOZ8808DI-03](#) [5KP15A](#) [5KP48A](#) [5KP90A](#) [ESD3V3D7-TP](#) [15KPA36A-LF](#) [P4KE56CA](#) [P4KE68A](#) [P4KE91CATR](#) [P6KE120A](#)  
[P6KE13CA](#) [P6KE43CA](#) [P6KE6.8CA](#) [P6KE8.2](#) [P6SMBJ20CA](#) [JANTX1N6072A](#) [SR2835ESKG](#) [SA90CA](#)