



## SOD-123FL Plastic-Encapsulate Diodes

### FFM101- M THRU FFM107- M Fast Recovery Rectifier Diodes

#### Features

- $I_{F(AV)}$  1A
- $V_{RRM}$  50V-1000V
- High surge current capability
- Polarity: Color band denotes cathode

#### Applications

- Rectifier

#### Marking

- FX  
X : From 1 To 7

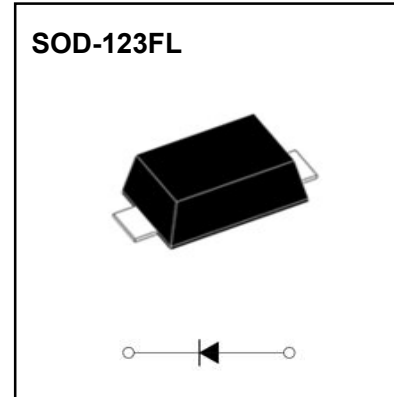

#### Limiting Values(Absolute Maximum Rating)

Item	Symbol	Unit	Test Conditions	FFM10						
				1-M	2-M	3-M	4-M	5-M	6-M	7-M
Repetitive Peak Reverse Voltage	$V_{RRM}$	V		50	100	200	400	600	800	1000
Maximum RMS Voltage	$V_{RMS}$	V		35	70	140	280	420	560	700
Average Forward Current	$I_{F(AV)}$	A	60Hz Half-sine wave, Resistance load, $T_a=90^\circ\text{C}$	1.0						
Surge(Non-repetitive)Forward Current	$I_{FSM}$	A	60Hz Half-sine wave, 1 cycle, $T_a=25^\circ\text{C}$	30						
Junction Temperature	$T_J$	$^\circ\text{C}$		-55 ~ +150						
Storage Temperature	$T_{STG}$	$^\circ\text{C}$		-55 ~ +150						

#### Electrical Characteristics ( $T=25^\circ\text{C}$ Unless otherwise specified)

Item	Symbol	Unit	Test Condition	FFM10						
				1-M	2-M	3-M	4-M	5-M	6-M	7-M
Peak Forward Voltage	$V_F$	V	$I_F=1.0\text{A}$	1.3						
Maximum reverse recovery time	$t_{rr}$	ns	$I_F=0.5\text{A}, I_R=1.0\text{A}, I_{rr}=0.25\text{A}$	150			250		500	
Peak Reverse Current	$I_{RRM1}$	$\mu\text{A}$	$V_{RM}=V_{RRM}$	$T_a=25^\circ\text{C}$						
	$I_{RRM2}$			$T_a=125^\circ\text{C}$						
Thermal Resistance(Typical)	$R_{\theta J-A}$	$^\circ\text{C}/\text{W}$	Between junction and ambient				70			
	$R_{\theta J-L}$		Between junction and terminal				25			

#### Notes:

Thermal resistance from junction to ambient and from junction to lead mounted on P.C.B. with 0.2" x 0.2" (5.0 mm x 5.0 mm) copper pad areas

# Typical Characteristics

FIG.1: FORWARD CURRENT DERATING CURVE

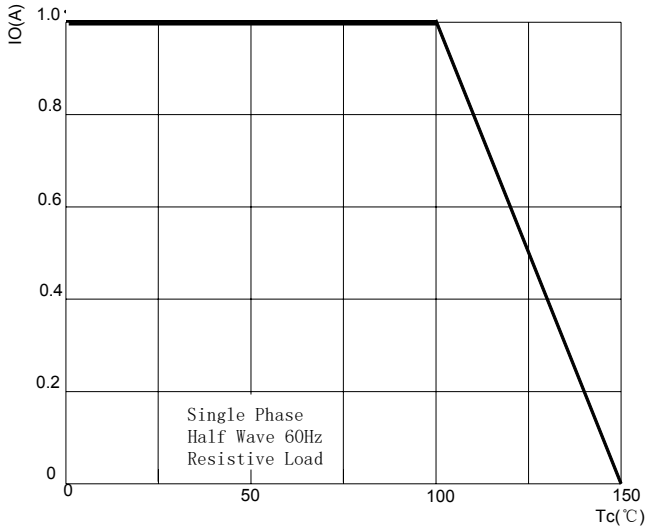

FIG.2: MAXIMUM NON-REPETITIVE FORWARD URGE CURRENT

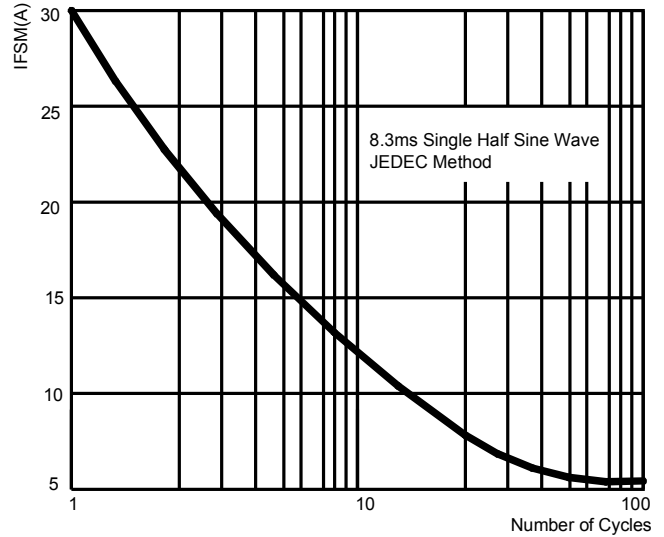

FIG.3: TYPICAL FORWARD CHARACTERISTICS

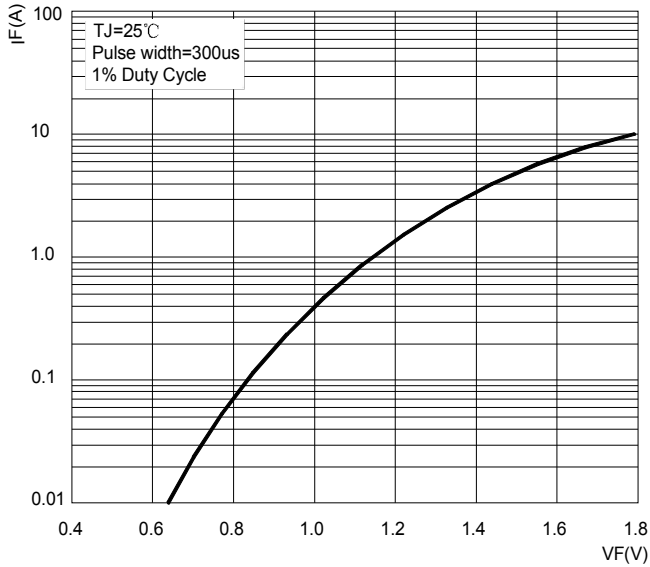

FIG.4: TYPICAL REVERSE CHARACTERISTICS

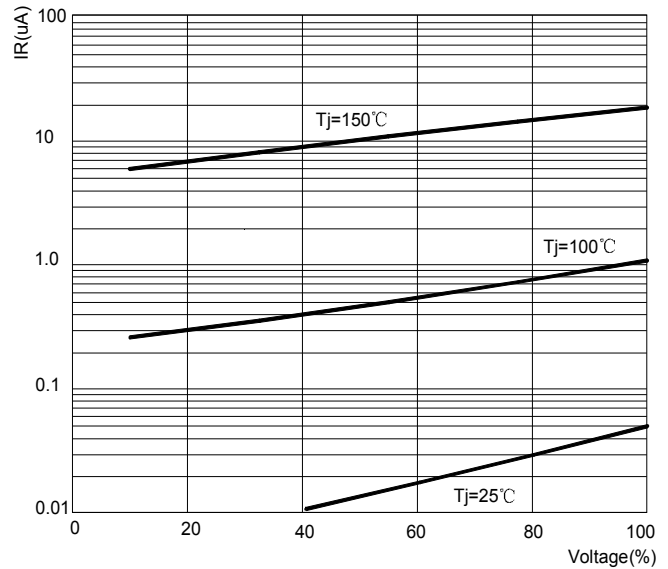
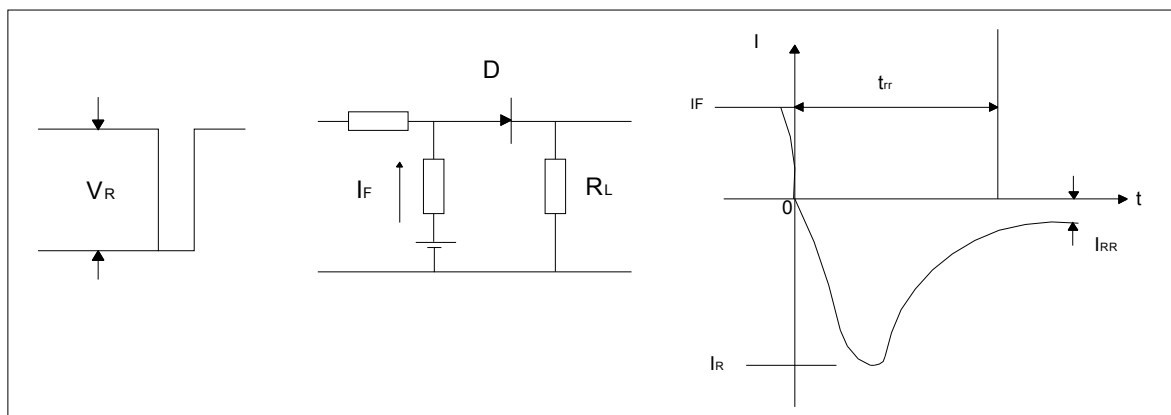
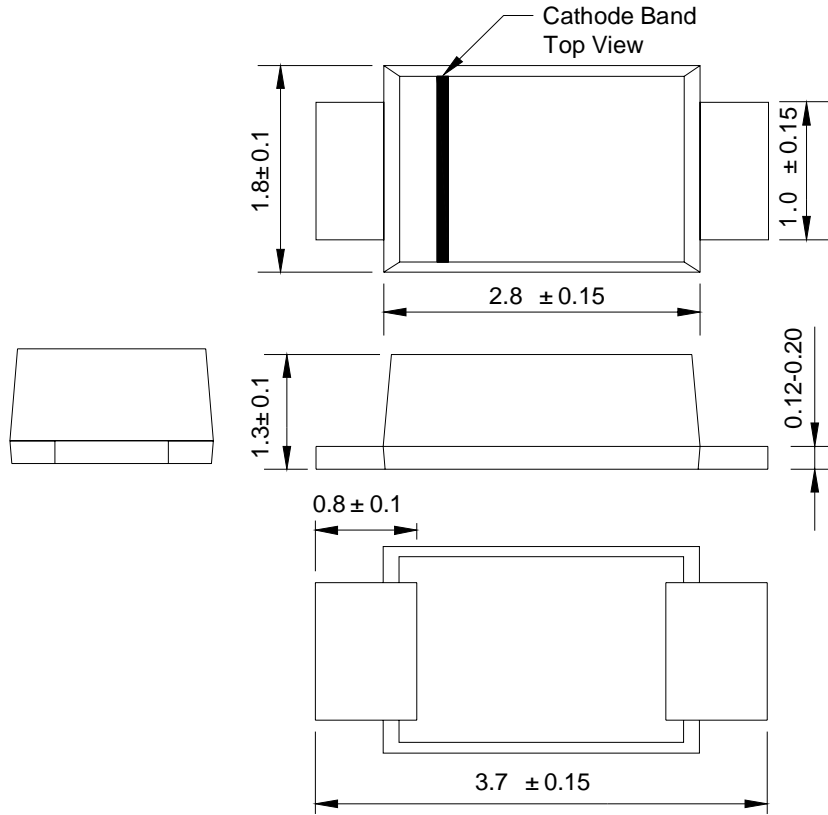

FIG.5: Diagram of circuit and Testing wave form of reverse recovery time



## SOD-123FL Package Outline Dimensions



Dimensions in millimeters

## SOD-123FL Suggested Pad Layout

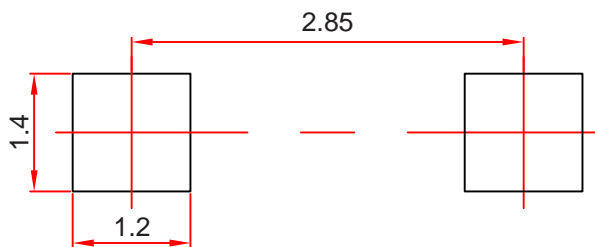

### Note:

1. Controlling dimension: in millimeters.
2. General tolerance:  $\pm 0.05$  mm.
3. The pad layout is for reference purposes only.

### NOTICE

JSCJ reserves the right to make modifications, enhancements, improvements, corrections or other changes without further notice to any product herein. JSCJ does not assume any liability arising out of the application or use of any product described herein.

# Reel Taping Specifications For Surface Mount Devices-SOD-123FL



**FIG: CONFIGURATION OF SURFACE MOUNTED DEVICES TAPING**

ITEM	SYMBOL	SOD-123FLmm(inch)
Carrier width	A	2.05±0.1(0.081±0.004)
Carrier length	B	3.95±0.1(0.156±0.004)
Carrier depth	C	1.45±0.1(0.057±0.004)
Sprocket hole	d	1.55±0.05(0.061±0.002)
Reel outside diameter	D	178±2.0(7.0±0.079)
Reel inner diameter	D1	54±1.0(2.13±0.039)
Feed hole diameter	D2	13±0.5(0.512±0.020)
Sprocket hole position	E	1.75±0.1(0.069±0.004)
Punch hole position	F	3.50±0.1(0.138±0.002)
Punch hole pitch	P	4.0±0.1(0.157±0.004)
Sprocket hole pitch	P0	4.0±0.1(0.157±0.004)
Embossment center	P1	2.0±0.1(0.079±0.004)
Total tape thickness	T	0.21±0.25(0.008±0.010)
Tape width	W	8.0±0.2(0.315±0.008)
Reel width	W1	10.0±2.0(0.394±0.079)

NOTE: Devices are packed in accordance with EIA standard RS-481-A and specification given above.

## X-ON Electronics

Largest Supplier of Electrical and Electronic Components

*Click to view similar products for [Rectifiers](#) category:*

*Click to view products by [Changjing Electronics Technology](#) manufacturer:*

Other Similar products are found below :

[70HFR40](#) [FR105 R0](#) [RL252-TP](#) [1N5397](#) [1N4005-TR](#) [1N4007-BP](#) [UFS120Je3/TR13](#) [20ETS12S](#) [RRE02VS6SGTR](#) [MS306](#) [A1N5404G-G](#)  
[CRF02\(T5L,TEMQ\)](#) [ACGRB207-HF](#) [CLH07\(TE16L,Q\)](#) [CLH03\(TE16L,Q\)](#) [1N5395-TP](#) [UES1302](#) [ACGRC307-HF](#) [ACEFC304-HF](#) [DZ-](#)  
[1380](#) [85HFR60](#) [40HFR60](#) [70HF120](#) [85HFR80](#) [SCF7500](#) [SM100](#) [ACGRA4001-HF](#) [SKN70/08](#) [NTE5819](#) [NTE5827](#) [NTE5828](#) [NTE5911](#)  
[NTE5915](#) [NTE6104](#) [NTE6163](#) [NTE6164](#) [NTE6165](#) [NTE6364](#) [TSD3G](#) [SET130312](#) [NRVUS110VT3G](#) [UES1106](#) [UES1306](#)  
[NRVUS240VT3G](#) [D5FE60-5063](#) [R4000GPS-TP](#) [D4015L56TP](#) [UES1306HR2](#) [FX20K120](#) [D20XB60-7101](#)