



GBU Plastic-Encapsulate Bridge Rectifier

GBU20005 THRU GBU2010

General Purpose Bridge Rectifier

Features

- I_o 20A
- V_{RRM} 50V-1000V
- High surge current capability
- Glass passivated chip

Applications

- General purpose 1 phase Bridge rectifier applications

Marking

- GBU20XX
- XX : From 005 To 10

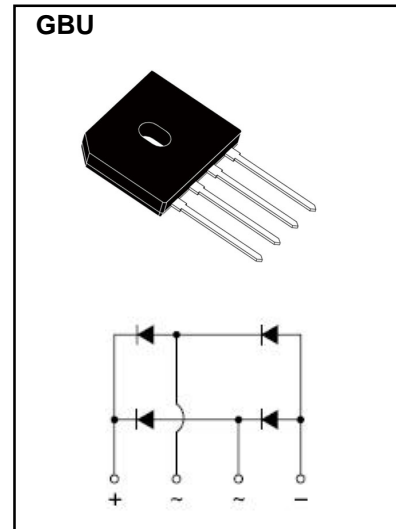

Limiting Values (Absolute Maximum Rating)

Item	Symbol	Unit	Conditions	GBU20						
				005	01	02	04	06	08	10
Repetitive Peak Reverse Voltage	V_{RRM}	V		50	100	200	400	600	800	1000
Maximum RMS Voltage	V_{RMS}	V		35	70	140	280	420	560	700
Average Rectified Output Current	I_o	A	60Hz sine wave, R-load	With heatsink $T_c = 98^\circ C$		20				
				Without heatsink $T_a = 25^\circ C$		3.6				
Surge(Non-repetitive)Forward Current	I_{FSM}	A	60Hz sine wave, 1 cycle, $T_j = 25^\circ C$	260						
Current Squared Time	I^2t	A^2S	$1ms \leq t < 8.3ms$ $T_j = 25^\circ C$, Rating of per diode	280						
Storage Temperature	T_{stg}	$^\circ C$		-55 ~ +150						
Junction Temperature	T_j	$^\circ C$		-55 ~ +150						
Dielectric Strength	V_{dis}	KV	Terminals to case, AC 1 minute	2.5						
Mounting Torque	Tor	$kg \cdot cm$	Recommend torque: $5kg \cdot cm$	8						

Electrical Characteristics ($T_a = 25^\circ C$ Unless otherwise specified)

Item	Symbol	Unit	Test Condition	Max
Peak Forward Voltage	V_{FM}	V	$I_{FM} = 10.0A$, Pulse measurement, Rating of per diode	1.1
Peak Reverse Current	I_{RRM}	μA	$V_{RM} = V_{RRM}$, Pulse measurement, Rating of per diode	10
Thermal Resistance	$R_{\theta J-A}$	$^\circ C/W$	Between junction and ambient, Without heatsink	22
	$R_{\theta J-C}$		Between junction and case, With heatsink	1.0

Typical Characteristics

FIG.1-MAXIMUM FORWARD SURGE CURRENT

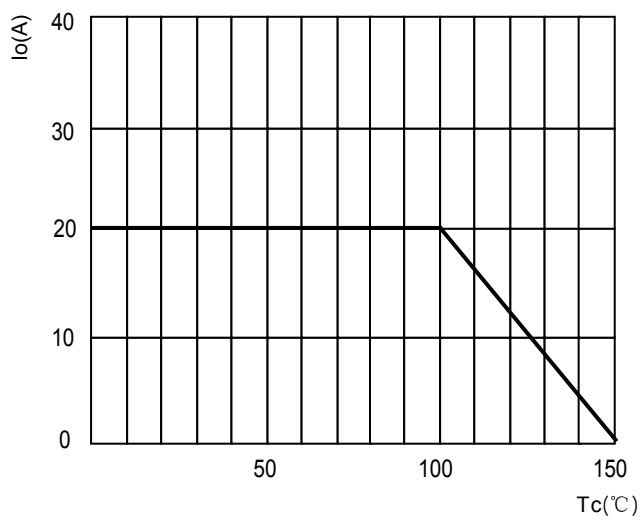

FIG.2-MAXIMUM NON-REPETITIVE SURGE CURRENT

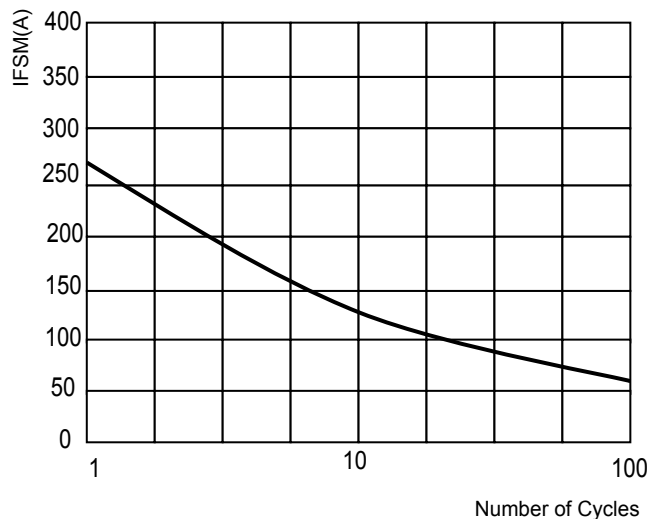

FIG.3-TYPICAL FORWARD CHARACTERISTICS

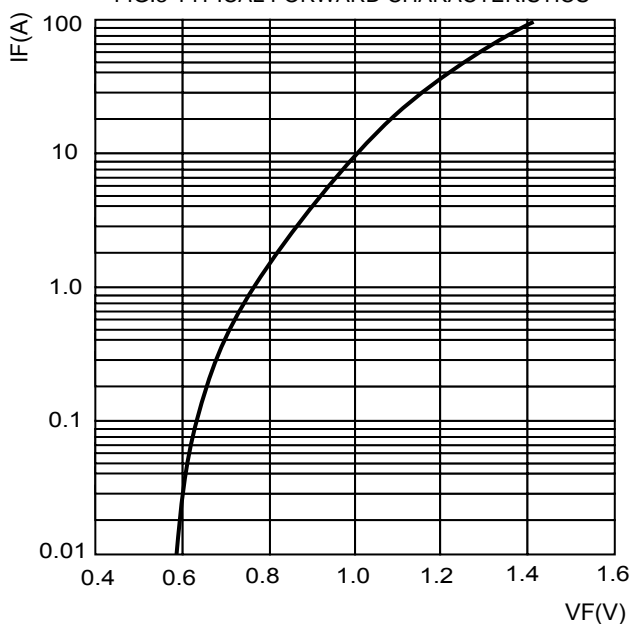

FIG.4-TYPICAL REVERSE CHARACTERISTICS

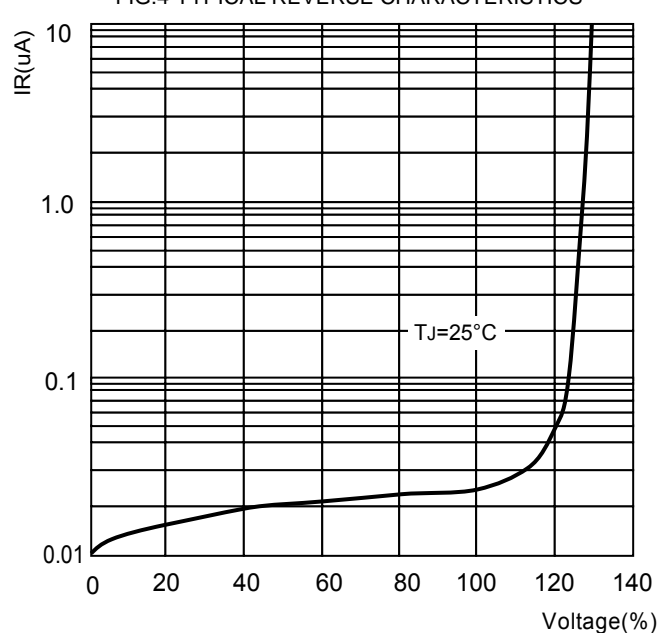
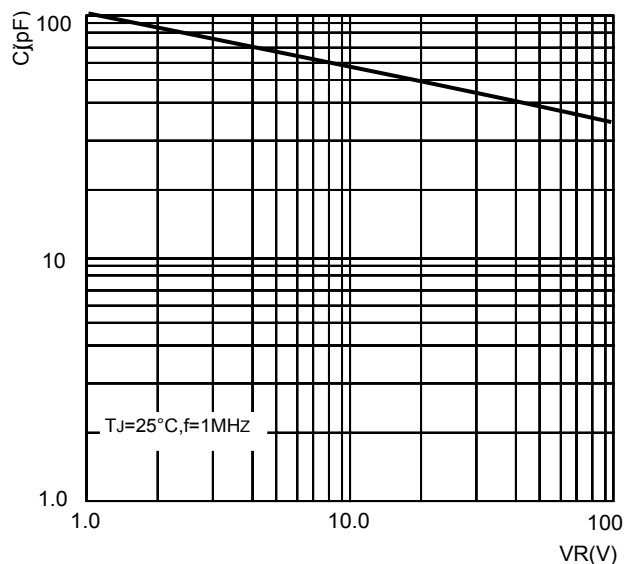
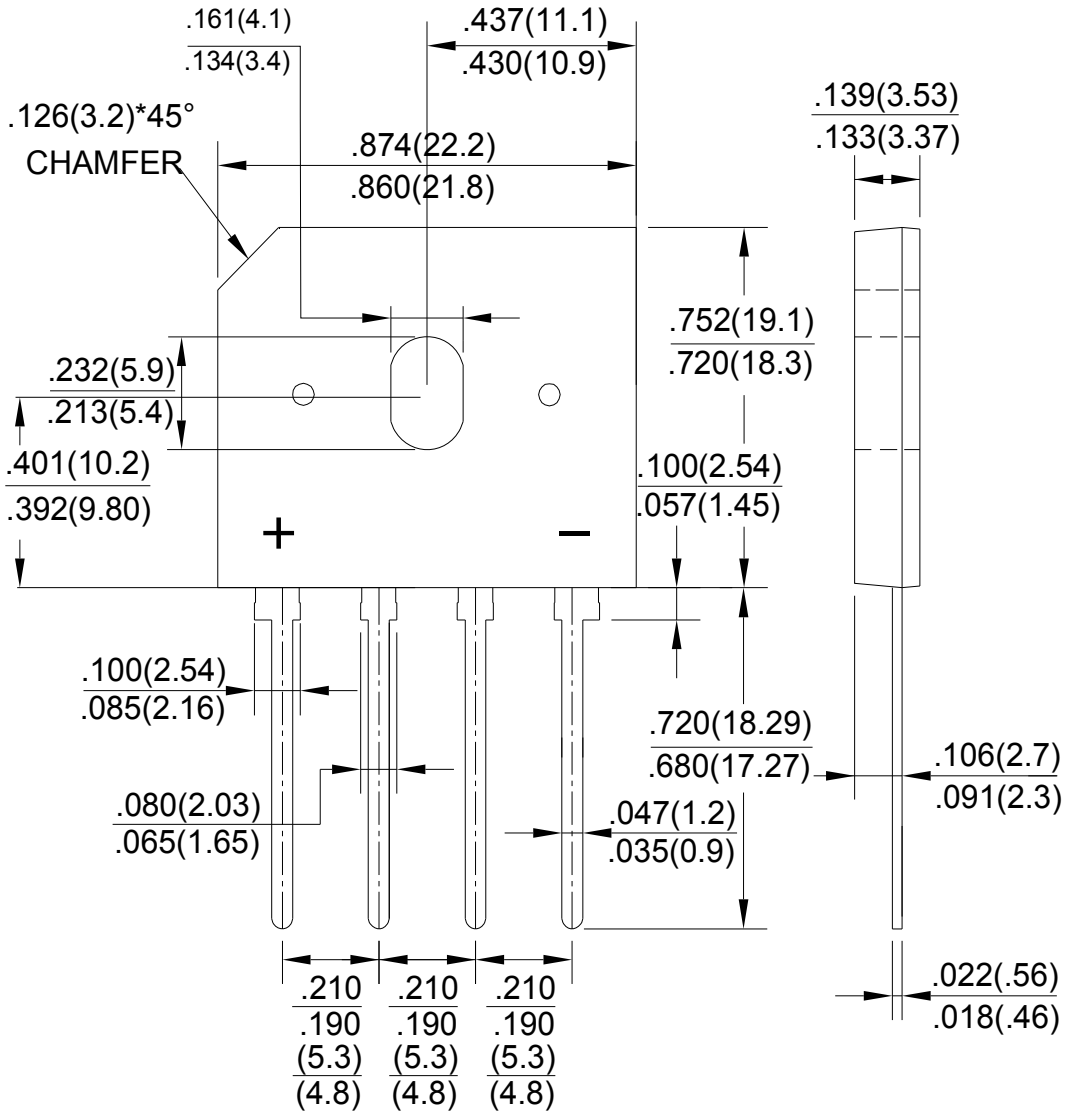

FIG.5-TYPICAL JUNCTION CAPACITANCE



GBU Package Outline Dimensions



Unit: in inches (millimeters)

NOTICE

JSCJ reserves the right to make modifications, enhancements, improvements, corrections or other changes without further notice to any product herein. JSCJ does not assume any liability arising out of the application or use of any product described herein.

X-ON Electronics

Largest Supplier of Electrical and Electronic Components

Click to view similar products for [Bridge Rectifiers](#) category:

Click to view products by [Changjing Electronics Technology](#) manufacturer:

Other Similar products are found below :

[MB252](#) [MB356G](#) [MB358G](#) [GBJ1504-BP](#) [GBU10B-BP](#) [GBU15K-BP](#) [GBU4A-BP](#) [GBU4D-BP](#) [DB101-BP](#) [DF01](#) [DF10SA-E345](#) [KBPC50-10S](#) [RS405GL-BP](#) [GBJ1502-BP](#) [GBU6M](#) [TB102M](#) [MB1510](#) [MB86](#) [TL401G](#) [MDA920A2](#) [TU602](#) [TU810](#) [MP5010W-BP](#) [MP501W-BP](#) [MP502-BP](#) [KBPC25-02](#) [VBO160-12NO7](#) [VS-110MT120KPBF](#) [VS-60MT80KPBF](#) [DB105-BP](#) [DF1510S](#) [VS-40MT160PAPBF](#) [GBU4G-BP](#) [GSIB15A80-E3/45](#) [DB104-BP](#) [D3SB60](#) [TB354](#) [GBJ2504-BP](#) [26MB100A](#) [B1S-G](#) [VS-40MT160KPBF](#) [VUO162-16NO7](#) [ABS10-G](#) [GBU6B-BP](#) [GBJ1508-BP](#) [BR5010-G](#) [ABS6-G](#) [B125C800G-E4/51](#) [MSB15MH-13](#) [LBS10-13](#)