



# KBU Plastic-Encapsulate Bridge Rectifier

## KBU8005 THRU KBU810

General Purpose Bridge Rectifier

### Features

- $I_O$  8A
- $V_{RRM}$  50V-1000V
- High surge current capability
- Glass passivated chip

### Applications

- General purpose 1 phase Bridge rectifier applications

### Marking

- KBU8XX
- XX : From 005 To 10

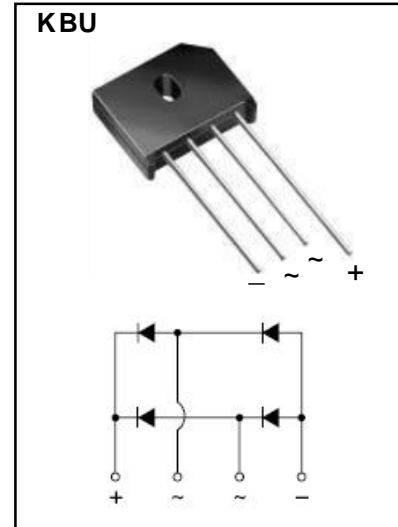

### Limiting Values (Absolute Maximum Rating)

| Item                                 | Symbol    | Unit                 | Conditions  | KBU8                      |           |     |     |     |     |      |
|--------------------------------------|-----------|----------------------|---|---------------------------|-----------|-----|-----|-----|-----|------|
|                                      |           |                      |   | 005                       | 01        | 02  | 04  | 06  | 08  | 10   |
| Repetitive Peak Reverse Voltage      | $V_{RRM}$ | V                    |   | 50                        | 100       | 200 | 400 | 600 | 800 | 1000 |
| Average Rectified Output Current     | $I_O$     | A                    | 60Hz sine wave, R-load  | $T_c = 100^\circ\text{C}$ |           | 8   |     |     |     |      |
| Surge(Non-repetitive)Forward Current | $I_{FSM}$ | A                    | 60Hz sine wave, 1 cycle, $T_j = 25^\circ\text{C}$                                 |                           | 200       |     |     |     |     |      |
| Current Squared Time                 | $I^2t$    | $\text{A}^2\text{S}$ | $1\text{ms} \leq t < 8.3\text{ms}$ $T_j = 25^\circ\text{C}$ , Rating of per diode |                           | 93        |     |     |     |     |      |
| Storage Temperature                  | $T_{stg}$ | $^\circ\text{C}$     |   |                           | -55 ~+150 |     |     |     |     |      |
| Junction Temperature                 | $T_j$     | $^\circ\text{C}$     |   |                           | -55 ~+150 |     |     |     |     |      |

### Electrical Characteristics ( $T_a = 25^\circ\text{C}$ Unless otherwise specified)

| Item                 | Symbol           | Unit                      | Test Condition  | Max         |
|----------------------|------------------|---------------------------|---|-------------|
| Peak Forward Voltage | $V_{FM}$         | V                         | $I_{FM} = 4.0\text{A}$ , Pulse measurement, Rating of per diode | 1.0         |
| Peak Reverse Current | $I_{RRM}$        | $\mu\text{A}$             | $V_{RM} = V_{RRM}$ , Pulse measurement, Rating of per diode     | 10          |
| Thermal Resistance   | $R_{\theta J-A}$ | $^\circ\text{C}/\text{W}$ | Between junction and ambient                                    | $g^{(1)}$   |
|                      | $R_{\theta J-C}$ |                           | Between junction and case                                       | $3.7^{(2)}$ |

# Typical Characteristics

FIG.1-MAXIMUM FORWARD SURGE CURRENT

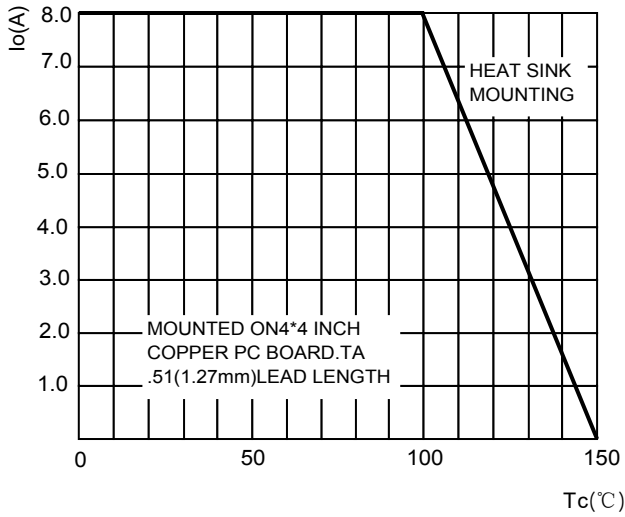

FIG.2-MAXIMUM NON-REPETITIVE SURGE CURRENT

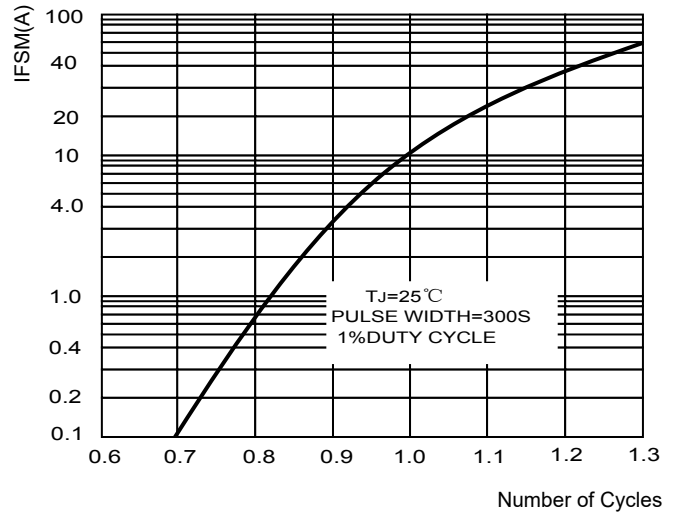

FIG.3-TYPICAL FORWARD CHARACTERISTICS

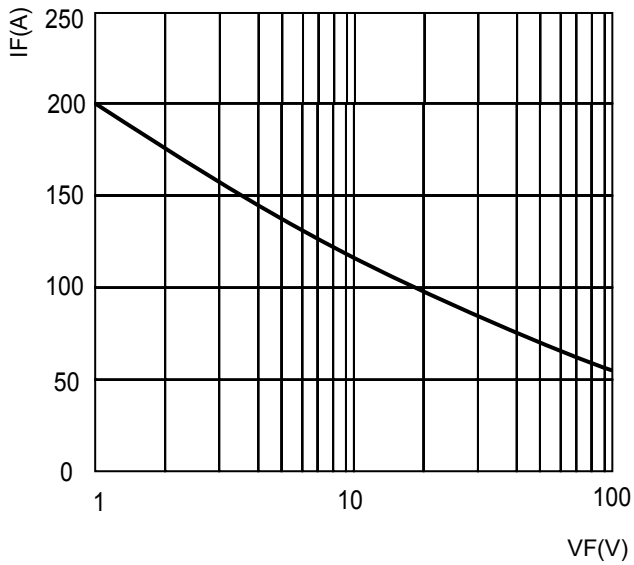

FIG.4-TYPICAL REVERSE CHARACTERISTICS

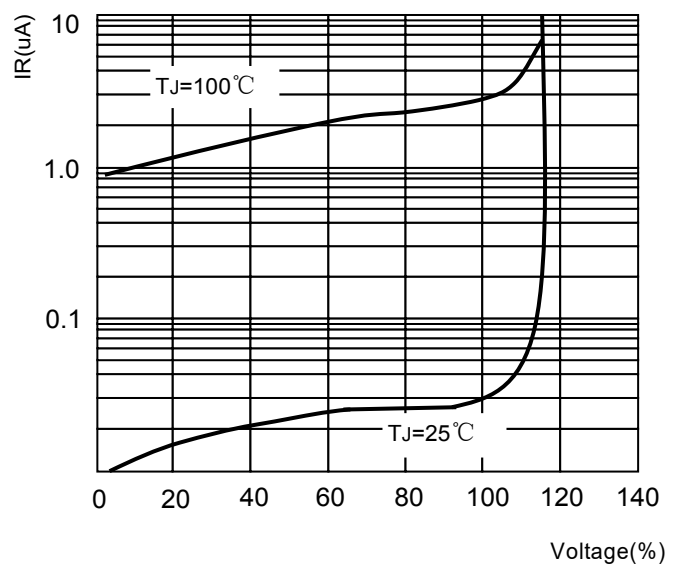
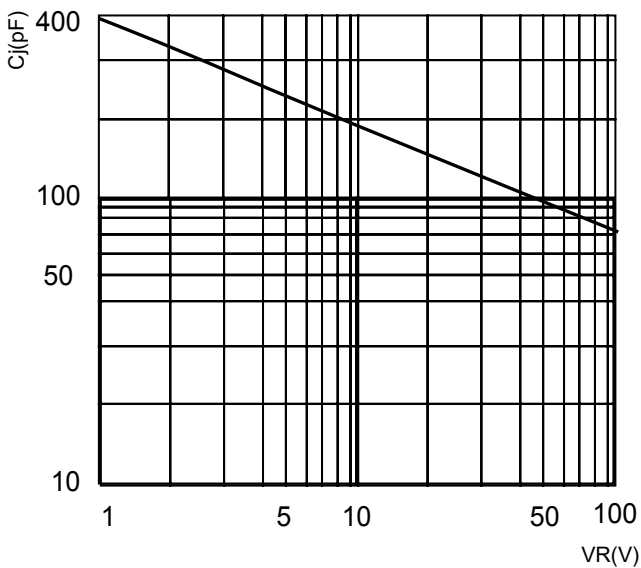
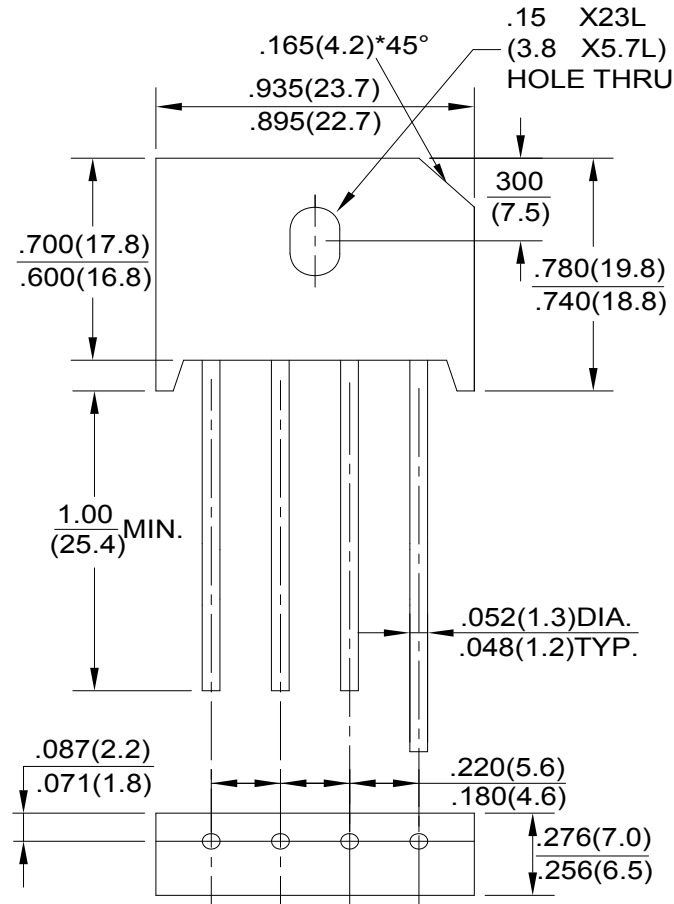

FIG.5-TYPICAL JUNCTION CAPACITANCE



# KBU Package Outline Dimensions



Dimensions in inches and (millimeters)

## NOTICE

JSCJ reserves the right to make modifications, enhancements, improvements, corrections or other changes without further notice to any product herein. JSCJ does not assume any liability arising out of the application or use of any product described herein.

## X-ON Electronics

Largest Supplier of Electrical and Electronic Components

*Click to view similar products for [Bridge Rectifiers](#) category:*

*Click to view products by [Changjing Electronics Technology](#) manufacturer:*

Other Similar products are found below :

[MB252](#) [MB356G](#) [MB358G](#) [GBJ1504-BP](#) [GBU10B-BP](#) [GBU15K-BP](#) [GBU4A-BP](#) [GBU4D-BP](#) [DB101-BP](#) [DF01](#) [DF10SA-E345](#) [KBPC50-10S](#) [RS405GL-BP](#) [GBJ1502-BP](#) [GBU6M](#) [TB102M](#) [MB1510](#) [MB86](#) [TL401G](#) [MDA920A2](#) [TU602](#) [TU810](#) [MP5010W-BP](#) [MP501W-BP](#) [MP502-BP](#) [KBPC25-02](#) [VBO160-12NO7](#) [VS-110MT120KPBF](#) [VS-60MT80KPBF](#) [DB105-BP](#) [DF1510S](#) [VS-40MT160PAPBF](#) [GBU4G-BP](#) [GSIB15A80-E3/45](#) [DB104-BP](#) [D3SB60](#) [TB354](#) [GBJ2504-BP](#) [26MB100A](#) [B1S-G](#) [VS-40MT160KPBF](#) [VUO162-16NO7](#) [ABS10-G](#) [GBU6B-BP](#) [GBJ1508-BP](#) [BR5010-G](#) [ABS6-G](#) [B125C800G-E4/51](#) [MSB15MH-13](#) [LBS10-13](#)