



## SOD-123 Plastic-Encapsulate Diodes

### MMSZ5221B-MMSZ5259B ZENER DIODE

#### FEATURES

- Planar Die Construction
- Ultra-Small Surface Mount Package
- General purpose, Medium Current
- Ideally Suited for Automated Assembly Processes

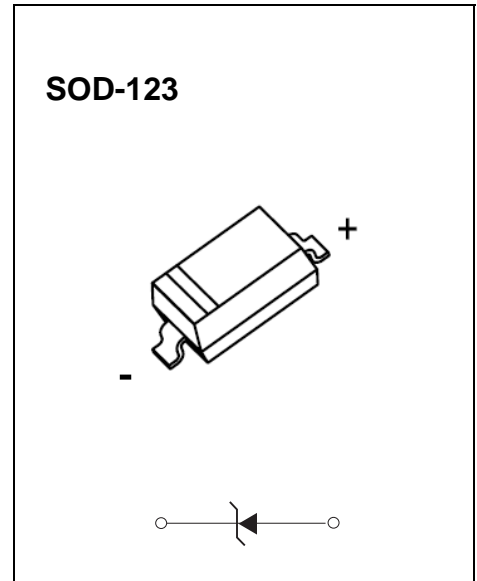

#### Maximum Ratings( $T_a=25^{\circ}\text{C}$ unless otherwise specified)

| Characteristic                                   | Symbol          | Value    | Unit                 |
|--|-----------------|----------|----------------------|
| Forward Voltage (Note 2) @ $I_F = 10\text{mA}$   | $V_F$           | 0.9      | V                    |
| Power Dissipation(Note 1)                        | $P_d$           | 350      | mW                   |
| Thermal Resistance, Junction to Ambient Air      | $R_{\theta JA}$ | 357      | $^{\circ}\text{C/W}$ |
| Operation Junction and Storage Temperature Range | $T_J, T_{stg}$  | -55~+150 |                      |

- Notes:1. Device mounted on ceramic PCB; 7.6 mm x 9.4 mm x 0.87 mm with pad areas 25 mm<sup>2</sup>.  
2. Tested with pulses,  $T_p \leq 1.0\text{ms}$ .

# ELECTRICAL CHARACTERISTICS

T<sub>a</sub>=25°C unless otherwise specified

| Type Number | Code | Zener Voltage Range (Note 2)    |        |        |                 | Maximum Zener Impedance (Note 4) |                                  |                 | Maximum Reverse Current |                |
|-------------|------|---------------------------------|--------|--------|-----------------|----------------------------------|----------------------------------|-----------------|-------------------------|----------------|
|             |      | V <sub>Z</sub> @I <sub>ZT</sub> |        |        | I <sub>ZT</sub> | Z <sub>ZT</sub> @I <sub>ZT</sub> | Z <sub>ZK</sub> @I <sub>ZK</sub> | I <sub>ZK</sub> | I <sub>R</sub>          | V <sub>R</sub> |
|             |      | Nom(V)                          | Min(V) | Max(V) | mA              | Ω                                |                                  | mA              | uA                      | V              |
| MMSZ5221B   | C1   | 2.4                             | 2.28   | 2.52   | 20              | 30                               | 1200                             | 0.25            | 100                     | 1.0            |
| MMSZ5223B   | C3   | 2.7                             | 2.57   | 2.84   | 20              | 30                               | 1300                             | 0.25            | 75                      | 1.0            |
| MMSZ5225B   | C5   | 3.0                             | 2.85   | 3.15   | 20              | 30                               | 1600                             | 0.25            | 50                      | 1.0            |
| MMSZ5226B   | G1   | 3.3                             | 3.14   | 3.47   | 20              | 28                               | 1600                             | 0.25            | 25                      | 1.0            |
| MMSZ5227B   | G2   | 3.6                             | 3.42   | 3.78   | 20              | 24                               | 1700                             | 0.25            | 15                      | 1.0            |
| MMSZ5228B   | G3   | 3.9                             | 3.71   | 4.10   | 20              | 23                               | 1900                             | 0.25            | 10                      | 1.0            |
| MMSZ5229B   | G4   | 4.3                             | 4.09   | 4.52   | 20              | 22                               | 2000                             | 0.25            | 5                       | 1.0            |
| MMSZ5230B   | G5   | 4.7                             | 4.47   | 4.94   | 20              | 19                               | 1900                             | 0.25            | 5                       | 2.0            |
| MMSZ5231B   | E1   | 5.1                             | 4.85   | 5.36   | 20              | 17                               | 1600                             | 0.25            | 5                       | 2.0            |
| MMSZ5232B   | E2   | 5.6                             | 5.32   | 5.88   | 20              | 11                               | 1600                             | 0.25            | 5                       | 3.0            |
| MMSZ5233B   | E3   | 6.0                             | 5.70   | 6.30   | 20              | 7                                | 1600                             | 0.25            | 5                       | 3.5            |
| MMSZ5234B   | E4   | 6.2                             | 5.89   | 6.51   | 20              | 7                                | 1000                             | 0.25            | 5                       | 4.0            |
| MMSZ5235B   | E5   | 6.8                             | 6.46   | 7.14   | 20              | 5                                | 750                              | 0.25            | 3                       | 5.0            |
| MMSZ5236B   | F1   | 7.5                             | 7.13   | 7.88   | 20              | 6                                | 500                              | 0.25            | 3                       | 6.0            |
| MMSZ5237B   | F2   | 8.2                             | 7.79   | 8.61   | 20              | 8                                | 500                              | 0.25            | 3                       | 6.5            |
| MMSZ5238B   | F3   | 8.7                             | 8.27   | 9.14   | 20              | 8                                | 600                              | 0.25            | 3                       | 6.5            |
| MMSZ5239B   | F4   | 9.1                             | 8.65   | 9.56   | 20              | 10                               | 600                              | 0.25            | 3                       | 7.0            |
| MMSZ5240B   | F5   | 10                              | 9.50   | 10.50  | 20              | 17                               | 600                              | 0.25            | 3                       | 8.0            |
| MMSZ5241B   | H1   | 11                              | 10.45  | 11.55  | 20              | 22                               | 600                              | 0.25            | 2.0                     | 8.4            |
| MMSZ5242B   | H2   | 12                              | 11.40  | 12.60  | 20              | 30                               | 600                              | 0.25            | 1.0                     | 9.1            |
| MMSZ5243B   | H3   | 13                              | 12.35  | 13.65  | 9.5             | 13                               | 600                              | 0.25            | 0.5                     | 9.9            |
| MMSZ5244B   | H4   | 14                              | 13.30  | 14.70  | 9.0             | 15                               | 600                              | 0.25            | 0.1                     | 10             |
| MMSZ5245B   | H5   | 15                              | 14.25  | 15.75  | 8.5             | 16                               | 600                              | 0.25            | 0.1                     | 11             |
| MMSZ5246B   | J1   | 16                              | 15.20  | 16.80  | 7.8             | 17                               | 600                              | 0.25            | 0.1                     | 12             |
| MMSZ5247B   | J2   | 17                              | 16.15  | 17.85  | 7.4             | 19                               | 600                              | 0.25            | 0.1                     | 13             |
| MMSZ5248B   | J3   | 18                              | 17.10  | 18.90  | 7.0             | 21                               | 600                              | 0.25            | 0.1                     | 14             |
| MMSZ5250B   | J5   | 20                              | 19.00  | 21.00  | 6.2             | 25                               | 600                              | 0.25            | 0.1                     | 15             |
| MMSZ5251B   | K1   | 22                              | 20.90  | 23.10  | 5.6             | 29                               | 600                              | 0.25            | 0.1                     | 17             |
| MMSZ5252B   | K2   | 24                              | 22.80  | 25.20  | 5.2             | 33                               | 600                              | 0.25            | 0.1                     | 18             |
| MMSZ5253B   | K3   | 25                              | 23.75  | 26.25  | 5.0             | 35                               | 600                              | 0.25            | 0.1                     | 19             |
| MMSZ5254B   | K4   | 27                              | 25.65  | 28.35  | 5.0             | 41                               | 600                              | 0.25            | 0.1                     | 21             |
| MMSZ5255B   | K5   | 28                              | 26.60  | 29.40  | 4.5             | 44                               | 600                              | 0.25            | 0.1                     | 21             |
| MMSZ5256B   | M1   | 30                              | 28.50  | 31.50  | 4.2             | 49                               | 600                              | 0.25            | 0.1                     | 23             |
| MMSZ5257B   | M2   | 33                              | 31.35  | 34.65  | 3.8             | 58                               | 700                              | 0.25            | 0.1                     | 25             |
| MMSZ5258B   | M3   | 36                              | 34.20  | 37.80  | 3.4             | 70                               | 700                              | 0.25            | 0.1                     | 27             |
| MMSZ5259B   | M4   | 39                              | 37.05  | 40.95  | 3.2             | 80                               | 800                              | 0.25            | 0.1                     | 30             |

# Typical Characteristics

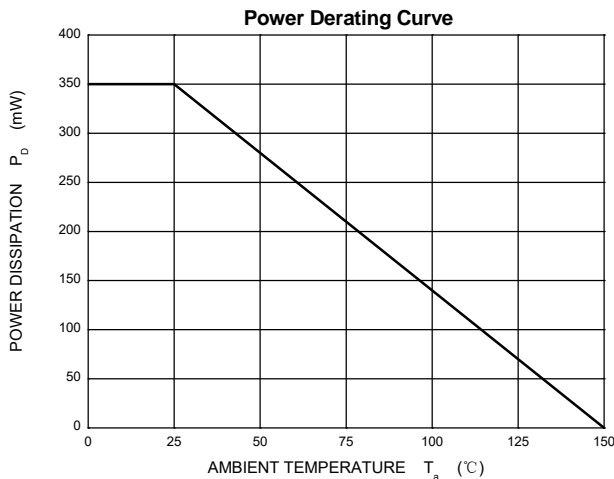
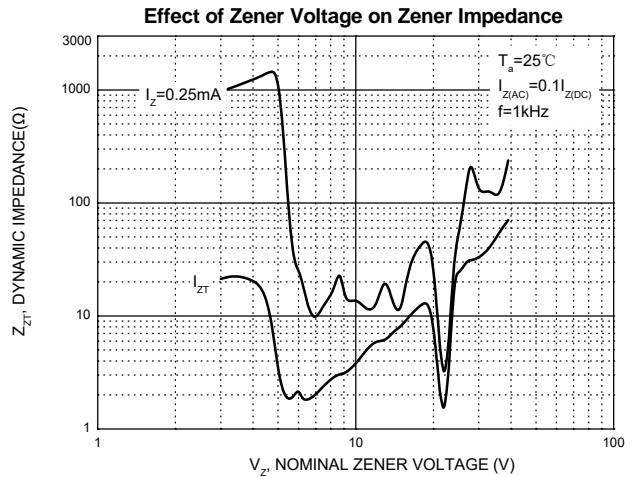
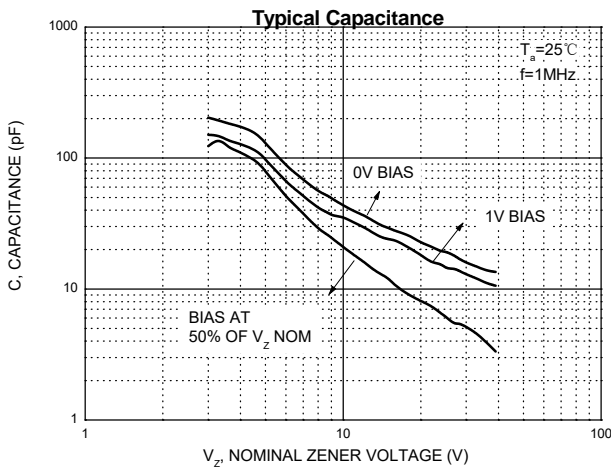
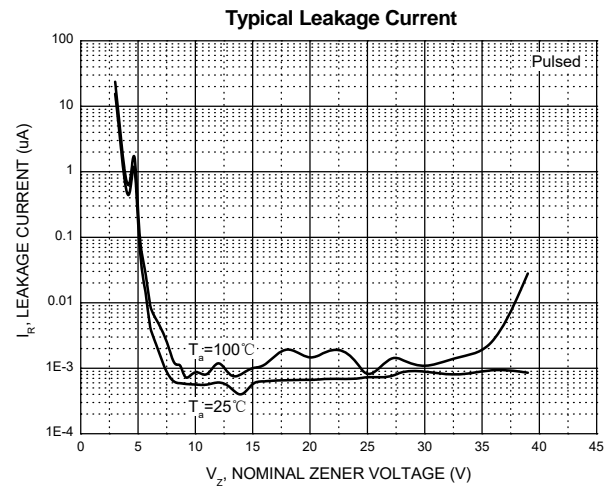
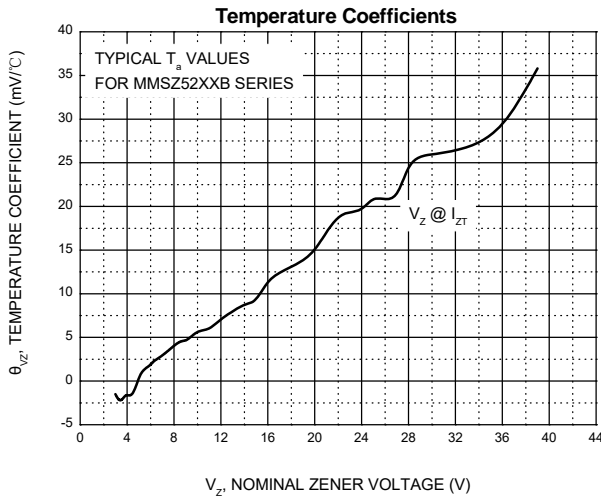
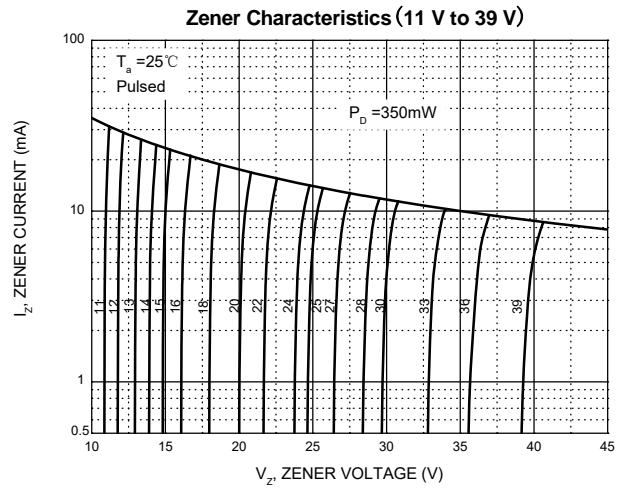
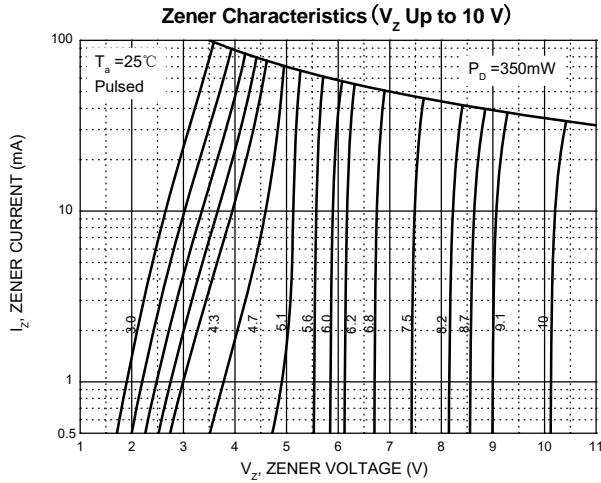

## SOD-123 Package Outline Dimensions

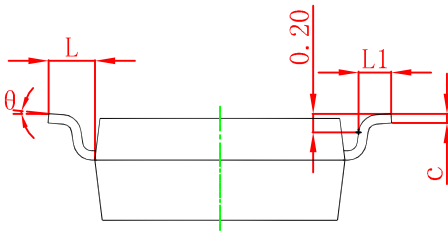
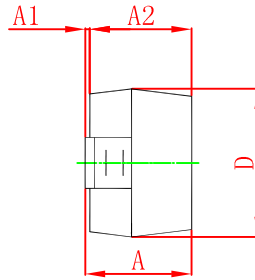
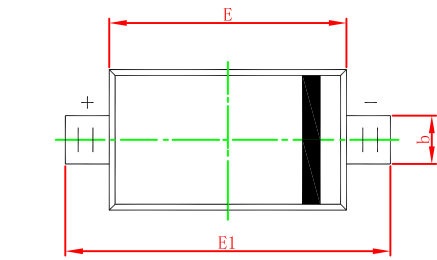

| Symbol | Dimensions In Millimeters |       | Dimensions In Inches |       |
|--------|---------------------------|-------|----------------------|-------|
|        | Min                       | Max   | Min                  | Max   |
| A      | 1.050                     | 1.250 | 0.041                | 0.049 |
| A1     | 0.000                     | 0.100 | 0.000                | 0.004 |
| A2     | 1.050                     | 1.150 | 0.041                | 0.045 |
| b      | 0.450                     | 0.650 | 0.018                | 0.026 |
| c      | 0.080                     | 0.150 | 0.003                | 0.006 |
| D      | 1.500                     | 1.700 | 0.059                | 0.067 |
| E      | 2.600                     | 2.800 | 0.102                | 0.110 |
| E1     | 3.550                     | 3.850 | 0.140                | 0.152 |
| L      | 0.500 REF                 |       | 0.020 REF            |       |
| L1     | 0.250                     | 0.450 | 0.010                | 0.018 |
| θ      | 0°                        | 8°    | 0°                   | 8°    |

## SOD-123 Suggested Pad Layout

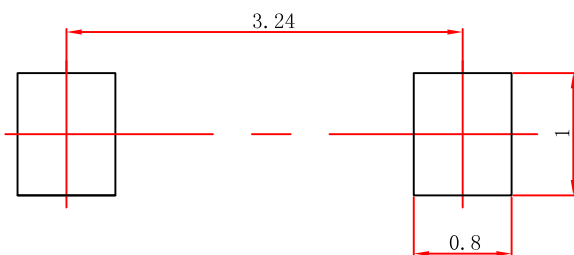

### Note:

1. Controlling dimension: in millimeters.
2. General tolerance:  $\pm 0.05\text{mm}$ .
3. The pad layout is for reference purposes only.

### NOTICE

JSCJ reserves the right to make modifications, enhancements, improvements, corrections or other changes without further notice to any product herein. JSCJ does not assume any liability arising out of the application or use of any product described herein.

# SOD-123 Tape and Reel

## SOD-123 Embossed Carrier Tape

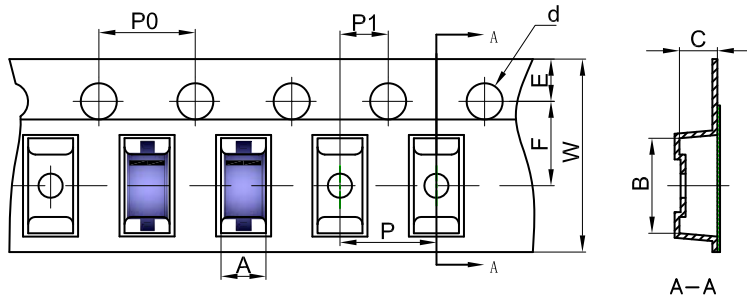

### Packaging Description:

SOD-123 parts are shipped in tape. The carrier tape is made from a dissipative (carbon filled) polycarbonate resin. The cover tape is a multilayer film (Heat Activated Adhesive in nature) primarily composed of polyester film, adhesive layer, sealant, and anti-static sprayed agent. These reeled parts in standard option are shipped with 3,000 units per 7" or 17.8cm diameter reel. The reels are clear in color and is made of polystyrene plastic (anti-static coated).

| Dimensions are in millimeter |      |      |      |       |      |      |      |      |      |      |  |
|------------------------------|------|------|------|-------|------|------|------|------|------|------|--|
| Pkg type                     | A    | B    | C    | d     | E    | F    | P0   | P    | P1   | W    |  |
| SOD-123                      | 1.85 | 3.95 | 1.57 | Ø1.55 | 1.75 | 3.50 | 4.00 | 4.00 | 2.00 | 8.00 |  |

## SOD-123 Tape Leader and Trailer

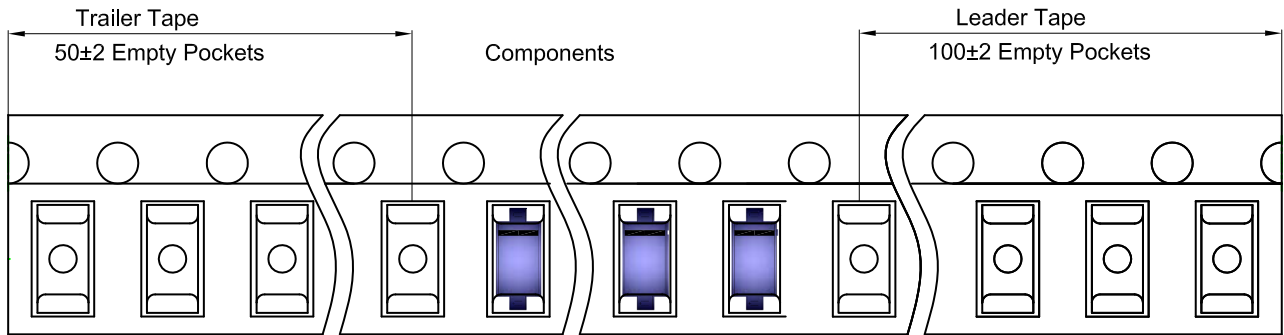

## SOD-123 Reel

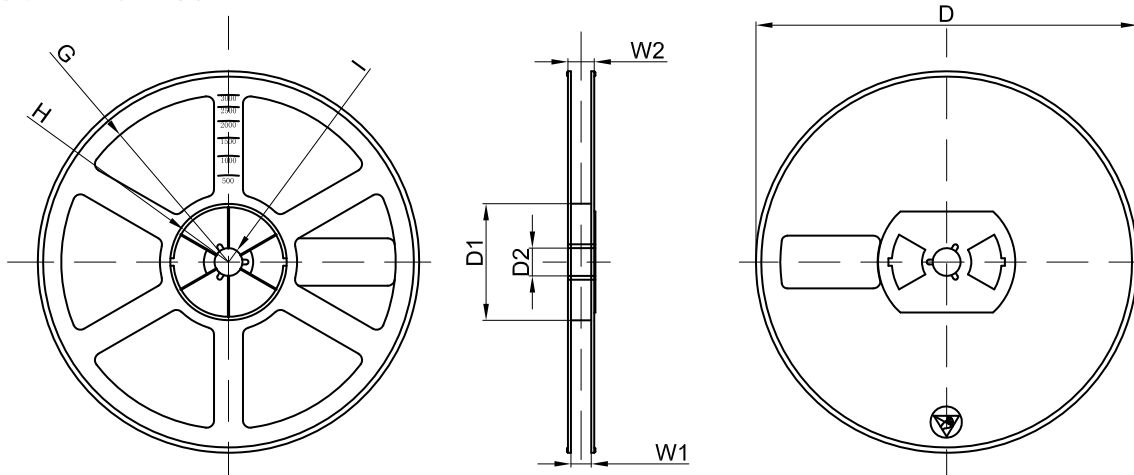

| Dimensions are in millimeter |         |       |       |        |        |       |      |       |
|------------------------------|---------|-------|-------|--------|--------|-------|------|-------|
| Reel Option                  | D       | D1    | D2    | G      | H      | I     | W1   | W2    |
| 7" Dia                       | Ø178.00 | 54.40 | 13.00 | R78.00 | R25.60 | R6.50 | 9.50 | 12.30 |

| REEL     | Reel Size | Box        | Box Size(mm) | Carton      | Carton Size(mm) | G.W.(kg) |
|----------|-----------|------------|--------------|-------------|-----------------|----------|
| 3000 pcs | 7 inch    | 45,000 pcs | 203×203×195  | 180,000 pcs | 438×438×220     |          |

## X-ON Electronics

Largest Supplier of Electrical and Electronic Components

*Click to view similar products for [Zener Diodes](#) category:*

*Click to view products by [Changjing Electronics Technology](#) manufacturer:*

Other Similar products are found below :

[RKZ13B2KG#P1](#) [DL5234B](#) [EDZTE6113B](#) [1N4682](#) [1N4693](#) [1N4732A](#) [1N4736A](#) [1N4750A](#) [1N4759ARL](#) [1N5241B](#) [1N5365B](#) [1N5369B](#)  
[1N747A](#) [1N964B](#) [1N966B](#) [1N968B](#) [1N972B](#) [JANS1N4974US](#) [JANTX1N5907](#) [1N4692](#) [1N4700](#) [1N4702](#) [1N4704](#) [1N4711](#) [1N4714](#)  
[1N4745ARL](#) [1N4752ARL](#) [1N4760ARL](#) [1N5221B](#) [1N5242BTR](#) [1N5350B](#) [1N5352B](#) [1N961BRR1](#) [1N964BRL](#) [RKZ5.1BKU#P6](#)  
[3SMAJ5946B-TP](#) [3SMAJ5950B-TP](#) [3SMBJ5925B-TP](#) [MMSZ5230BQ-13-F](#) [MMSZ5232BQ-13-F](#) [BZX84C7V5](#) [3SMAJ5945B-TP](#)  
[3SMAJ5947B-TP](#) [3SMBJ5941B-TP](#) [DL4732A-T3](#) [DZ2S240M0L](#) [SMAZ27-TP](#) [ZMM5224B-7](#) [RD16UM-T1-A](#) [RD39S-T1-A](#)