



TO-92 Plastic-Encapsulate Transistors

MPS2907A TRANSISTOR (PNP)

FEATURES

- Complementary NPN Type available (MPS2222A)

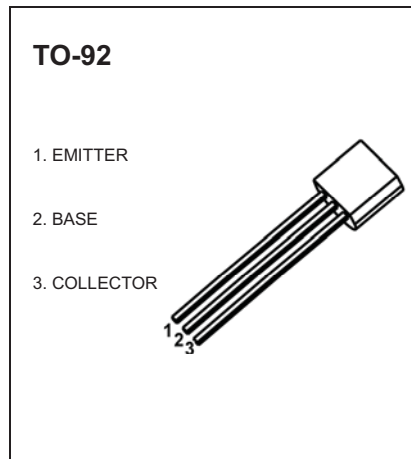

MARKING

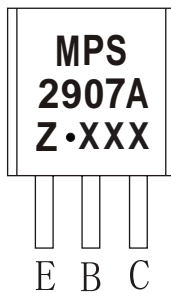

MPS2907A=Device code
 Solid dot=Green molding compound device,
 if none,the normal device
 Z=Rank of h_{FE} ,
 XXX=Code

Equivalent Circuit

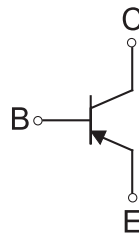

ORDERING INFORMATION

| Part Number | Package | Packing Method | Pack Quantity |
|-------------|---------|----------------|---------------|
| MPS2907A | TO-92 | Bulk | 1000pcs/Bag |
| MPS2907A-TA | TO-92 | Tape | 2000pcs/Box |

MAXIMUM RATINGS ($T_a=25^{\circ}\text{C}$ unless otherwise noted)

| Symbol | Parameter | Value | Unit |
|-----------------|--|----------|-------------------------------|
| V_{CBO} | Collector-Base Voltage | -60 | V |
| V_{CEO} | Collector-Emitter Voltage | -60 | V |
| V_{EBO} | Emitter-Base Voltage | -5 | V |
| I_c | Collector Current -Continuous | -600 | mA |
| P_D | Collector Power Dissipation | 625 | mW |
| $R_{\theta JA}$ | Thermal Resistance from Junction to Ambient | 200 | $^{\circ}\text{C} / \text{W}$ |
| T_J, T_{stg} | Operation Junction and Storage Temperature Range | -55~+150 | $^{\circ}\text{C}$ |

ELECTRICAL CHARACTERISTICS

$T_a=25\text{ }^\circ\text{C}$ unless otherwise specified

| Parameter | Symbol | Test conditions | Min | Typ | Max | Unit |
|--------------------------------------|---------------|---|-----|-----|-------|------|
| Collector-base breakdown voltage | $V_{(BR)CBO}$ | $I_C=-10\mu\text{A}, I_E=0$ | -60 | | | V |
| Collector-emitter breakdown voltage | $V_{(BR)CEO}$ | $I_C=-10\text{mA}, I_B=0$ | -60 | | | V |
| Emitter-base breakdown voltage | $V_{(BR)EBO}$ | $I_E=-10\mu\text{A}, I_C=0$ | -5 | | | V |
| Collector cut-off current | I_{CBO} | $V_{CB}=-50\text{V}, I_E=0$ | | | -10 | nA |
| Collector cut-off current | I_{CEX} | $V_{CE}=-30\text{V}, V_{EB(off)}=-0.5\text{V}$ | | | -50 | nA |
| Emitter cut-off current | I_{EBO} | $V_{EB}=-3\text{V}, I_C=0$ | | | -10 | nA |
| DC current gain | $h_{FE(1)}$ | $V_{CE}=-10\text{V}, I_C=-0.1\text{mA}$ | 78 | | | |
| | $h_{FE(2)}$ | $V_{CE}=-10\text{V}, I_C=-150\text{mA}$ | 100 | | 300 | |
| | $h_{FE(3)}$ | $V_{CE}=-10\text{V}, I_C=-500\text{mA}$ | 52 | | | |
| Collector-emitter saturation voltage | $V_{CE(sat)}$ | $I_C=-150\text{mA}, I_B=-15\text{mA}$ | | | -0.4 | V |
| | $V_{CE(sat)}$ | $I_C=-500\text{mA}, I_B=-50\text{mA}$ | | | -0.67 | V |
| Base-emitter saturation voltage | $V_{BE(sat)}$ | $I_C=-150\text{mA}, I_B=-15\text{mA}$ | | | -1 | V |
| | $V_{BE(sat)}$ | $I_C=-500\text{mA}, I_B=-50\text{mA}$ | | | -1.2 | V |
| Transition frequency | f_T | $V_{CE}=-20\text{V}, I_C=-50\text{mA}, f=100\text{MHz}$ | 200 | | | MHz |
| Delay time | t_d | $V_{CC}=-30\text{V}, I_C=-150\text{mA},$ | | | 10 | ns |
| Rise time | t_r | $I_{B1}=-I_{B2}=-15\text{mA}$ | | | 25 | ns |
| Storage time | t_S | $V_{CC}=-6\text{V}, I_C=-150\text{mA},$ | | | 225 | ns |
| Fall time | t_f | $I_{B1}=-I_{B2}=-15\text{mA}$ | | | 60 | ns |

CLASSIFICATION OF $h_{FE(2)}$

| Rank | L | H |
|-------|---------|---------|
| Range | 100-200 | 200-300 |

Typical Characteristics

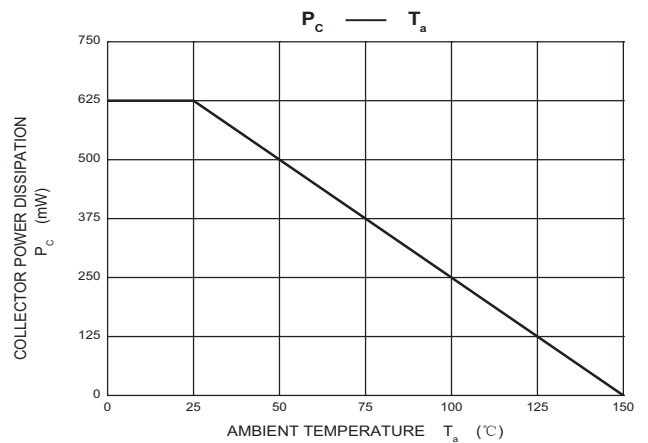
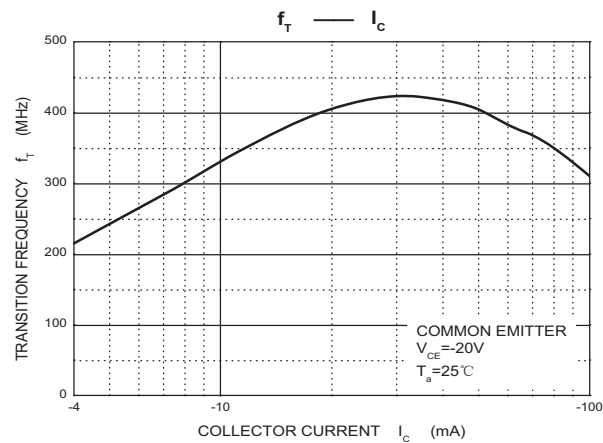
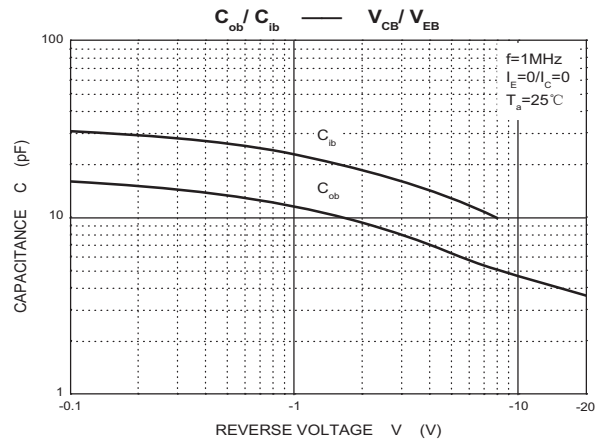
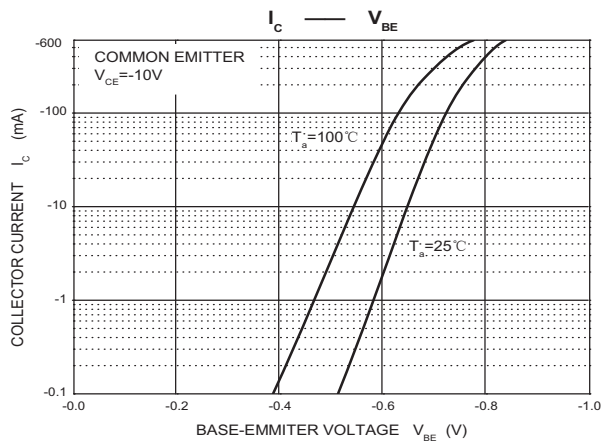
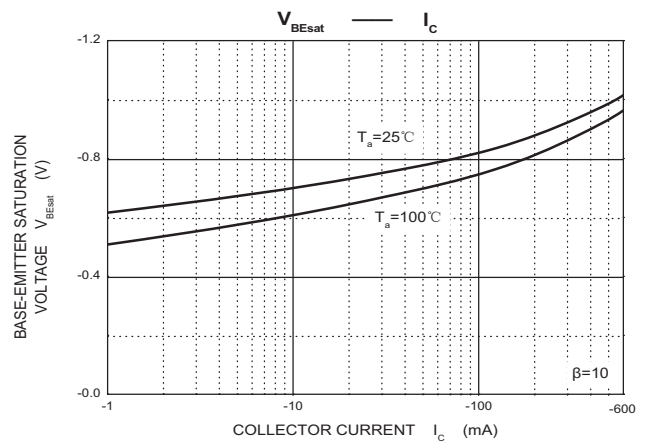
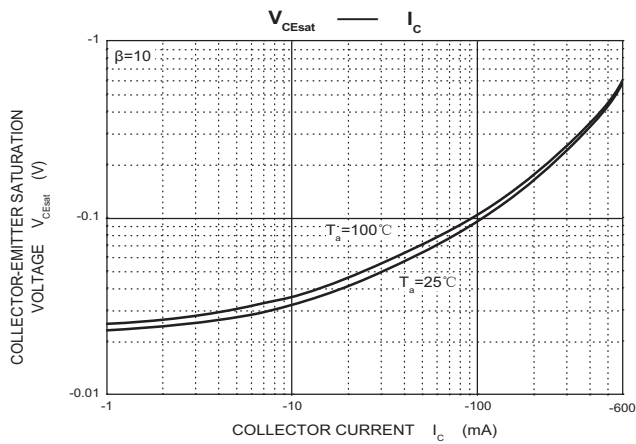
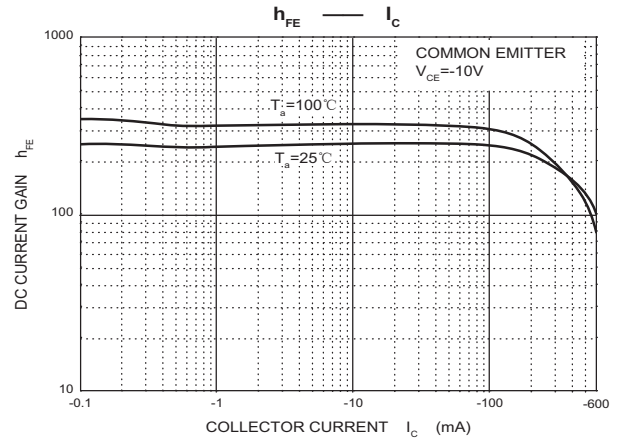
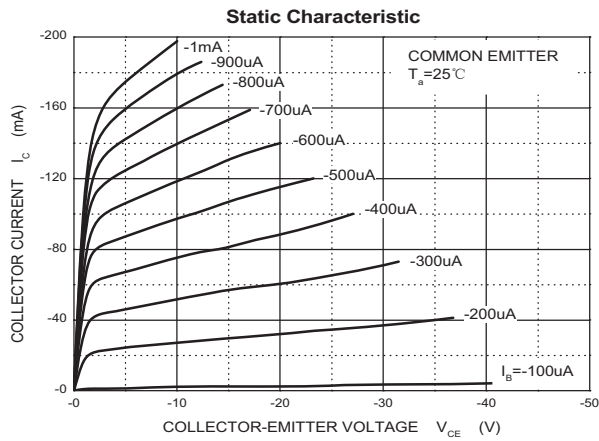

TO-92 Package Outline Dimensions

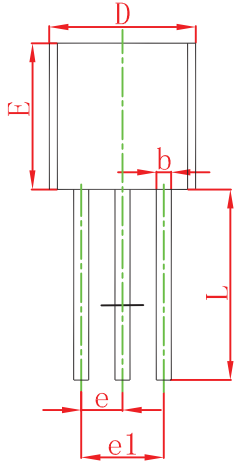
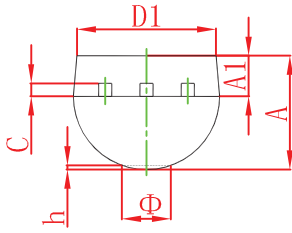

| Symbol | Dimensions In Millimeters | | Dimensions In Inches | |
|--------|---------------------------|--------|----------------------|-------|
| | Min | Max | Min | Max |
| A | 3.300 | 3.700 | 0.130 | 0.146 |
| A1 | 1.100 | 1.400 | 0.043 | 0.055 |
| b | 0.380 | 0.550 | 0.015 | 0.022 |
| c | 0.360 | 0.510 | 0.014 | 0.020 |
| D | 4.300 | 4.700 | 0.169 | 0.185 |
| D1 | 3.430 | | 0.135 | |
| E | 4.300 | 4.700 | 0.169 | 0.185 |
| e | 1.270 TYP | | 0.050 TYP | |
| e1 | 2.440 | 2.640 | 0.096 | 0.104 |
| L | 14.100 | 14.500 | 0.555 | 0.571 |
| Φ | | 1.600 | | 0.063 |
| h | 0.000 | 0.380 | 0.000 | 0.015 |

TO-92 Suggested Pad Layout

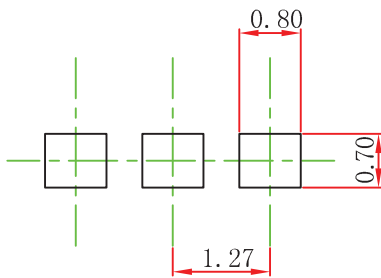

Note:

1. Controlling dimension: in millimeters.
2. General tolerance: $\pm 0.05\text{mm}$.
3. The pad layout is for reference purposes only.

NOTICE

JSCJ reserves the right to make modifications, enhancements, improvements, corrections or other changes without further notice to any product herein. JSCJ does not assume any liability arising out of the application or use of any product described herein.

TO-92 Tape and Reel

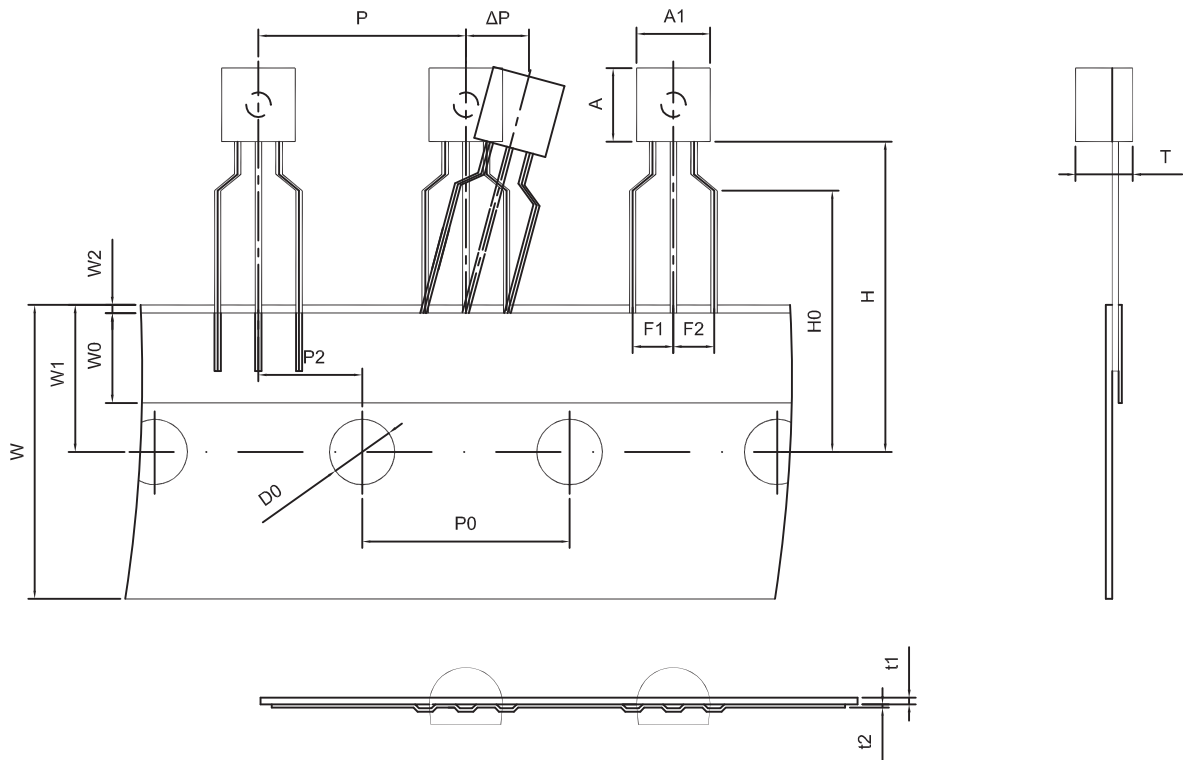

Dimensions are in millimeter

| A1 | A | T | P | P0 | P2 | F1 | F2 | W |
|-----|-----|----------|------|------|------|-----|-----|------------|
| 4.5 | 4.5 | 3.5 | 12.7 | 12.7 | 6.35 | 2.5 | 2.5 | 18.0 |
| W0 | W1 | W2 | H | H0 | D0 | t1 | t2 | ΔP |
| 6.0 | 9.0 | 1.0 MAX. | 19.0 | 16.0 | 4.0 | 0.4 | 0.2 | 0 |

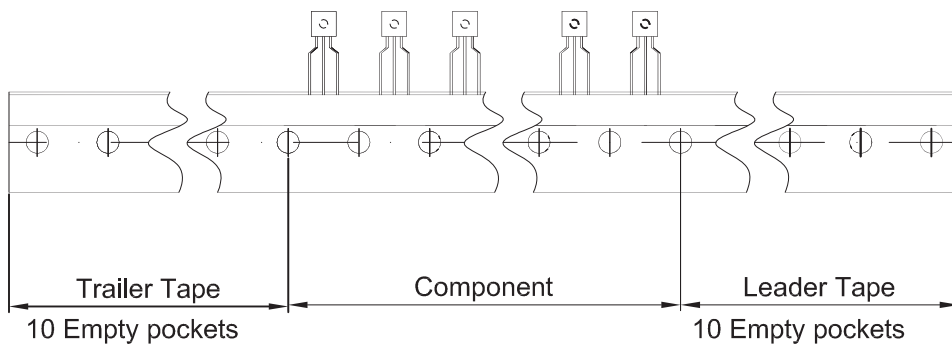

| Package | Box | Box Size(mm) | Carton | Carton Size(mm) |
|---------|----------|--------------|------------|-----------------|
| TO-92 | 2000 pcs | 333×162×43 | 20,000 pcs | 350×340×250 |

X-ON Electronics

Largest Supplier of Electrical and Electronic Components

Click to view similar products for [Bipolar Transistors - BJT category](#):

Click to view products by [Changjing Electronics Technology manufacturer](#):

Other Similar products are found below :

[619691C](#) [MCH4017-TL-H](#) [MMBT-2369-TR](#) [BC546/116](#) [BC557/116](#) [BSW67A](#) [NJVMJD148T4G](#) [NTE123AP-10](#) [NTE153MCP](#) [NTE16](#)
[NTE195A](#) [NTE92](#) [C4460](#) [2N4401-A](#) [2N6728](#) [2SA1419T-TD-H](#) [2SA2126-E](#) [2SB1204S-TL-E](#) [2SC2712S-GR,LF](#) [2SC5488A-TL-H](#)
[2SD2150T100R](#) [SP000011176](#) [2N2907A](#) [2N3904-NS](#) [2N5769](#) [2SC2412KT146S](#) [2SD1816S-TL-E](#) [CPH6501-TL-E](#) [MCH4021-TL-E](#)
[MJE340](#) [US6T6TR](#) [NJL0281DG](#) [732314D](#) [CPH3121-TL-E](#) [CPH6021-TL-H](#) [873787E](#) [IMZ2AT108](#) [UMX21NTR](#) [MCH6102-TL-E](#)
[NJL0302DG](#) [2N3583](#) [30A02MH-TL-E](#) [TN6717A](#) [NSV40301MZ4T1G](#) [NTE13](#) [NTE26](#) [NTE282](#) [NTE323](#) [NTE350](#) [NTE81](#)