

# TO-220-3L/TO-220F Plastic-Encapsulate Diodes

## MUR1040CT、MURF1040CT SUPER FAST RECOVER RECTIFIER

### MAIN CHARACTERISTICS

$I_o$	10A
$V_{RRM}$	400 V
$T_j$	150 °C
$V_{F(typ)}$	1.1V (@ $T_j=125^{\circ}C$ )

### FEATURES

- Ultrafast 35ns Recovery Times
- High Voltage Capability to 400V
- Low Reverse Leakage Current

### MARKING

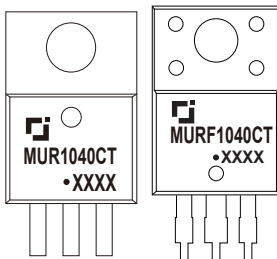

MUR(F)1040CT = Device code  
 Solid dot = Green molding compound device  
 if none, the normal device  
 XXXX = Code

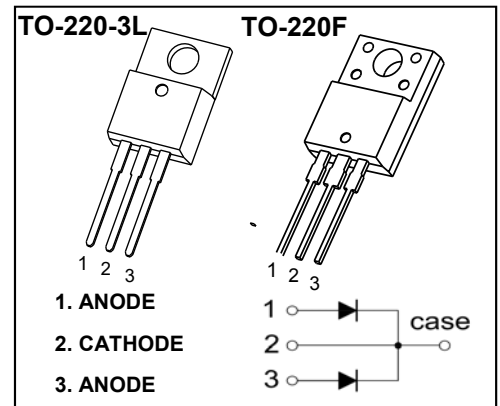

### MAXIMUM RATINGS ( $T_a=25^{\circ}C$ unless otherwise noted )

Symbol	Parameter	MUR		Unit
		1040CT	F1040CT	
$V_{RRM}$	Peak repetitive reverse voltage	400		V
$V_{RWM}$	Working peak reverse voltage			
$V_R$	DC blocking voltage			
$V_{R(RMS)}$	RMS reverse voltage	280		V
$I_o$	Average rectified output current@ Per leg	5		A
	Average rectified output current@ Total device	10		A
$I_{FSM}$	Non-Repetitive peak forward surge current 8.3ms half sine wave	70		A
$P_D$	Power dissipation	2		W
$R_{\theta JA}$	Thermal resistance from junction to ambient	62.5		°C/W
$T_j$	Operating Junction Temperature Range	-55 ~ +150		°C
$T_{stg}$	Storage Temperature Range	-55 ~ +150		°C

### ELECTRICAL CHARACTERISTICS ( $T_a=25^{\circ}C$ unless otherwise specified )

Parameter	Symbol	Test conditions	Min	Typ	Max	Unit
Reverse voltage	$V_{(BR)}$	$I_R=100\mu A$	400			V
Reverse current	$I_R$	$V_R=400V$	$T_j = 25^{\circ}C$	0.2	1	$\mu A$
			$T_j = 125^{\circ}C$	1.0		$\mu A$
Forward voltage	$V_F$	$I_F=5.0A$	$T_j = 25^{\circ}C$	1.25	1.4	V
			$T_j = 125^{\circ}C$	1.1		V
Typical total capacitance	$C_{tot}$	$V_R=4.0V, f=1MHz$		16		pF
Reverse recovery time	$t_{rr}$	$I_F=0.5A, I_R=1A, I_{tr}=0.25A$			35	ns

# Typical Characteristics

Forward Characteristics

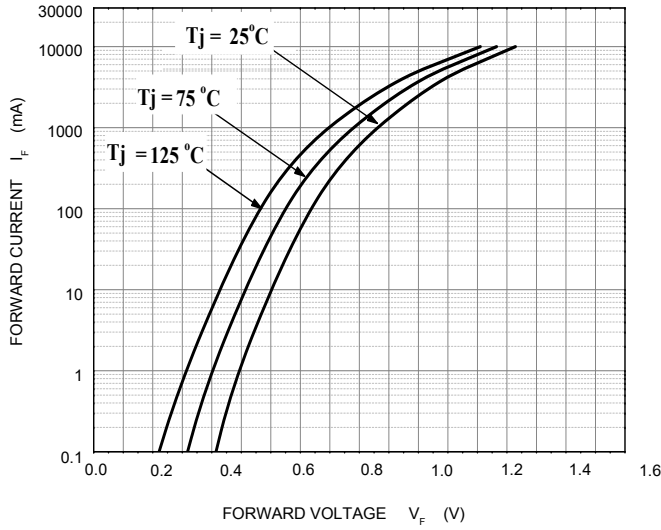

Reverse Characteristics

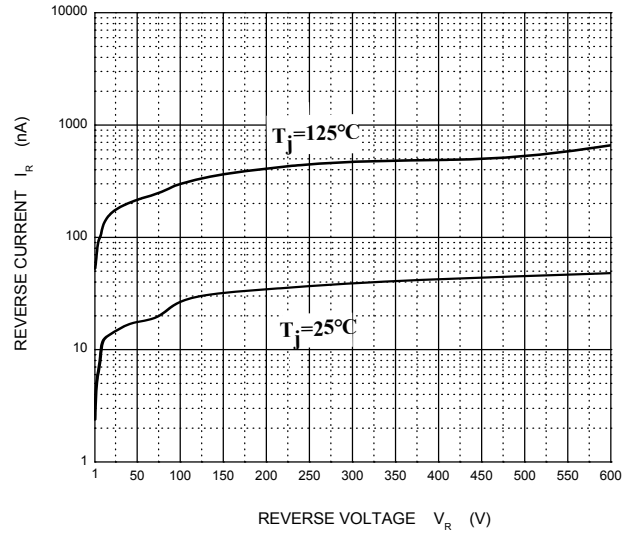

Capacitance Characteristics

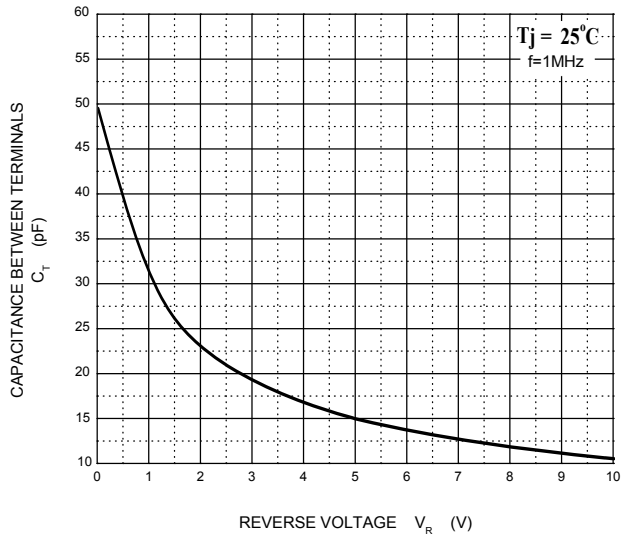

Power Derating Curve

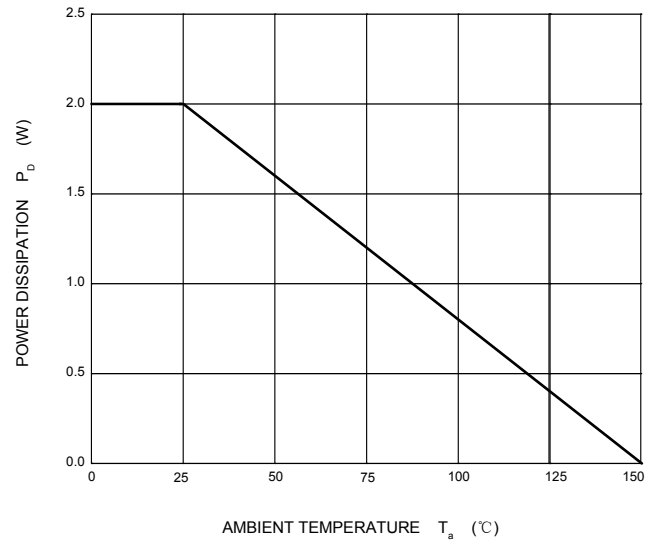
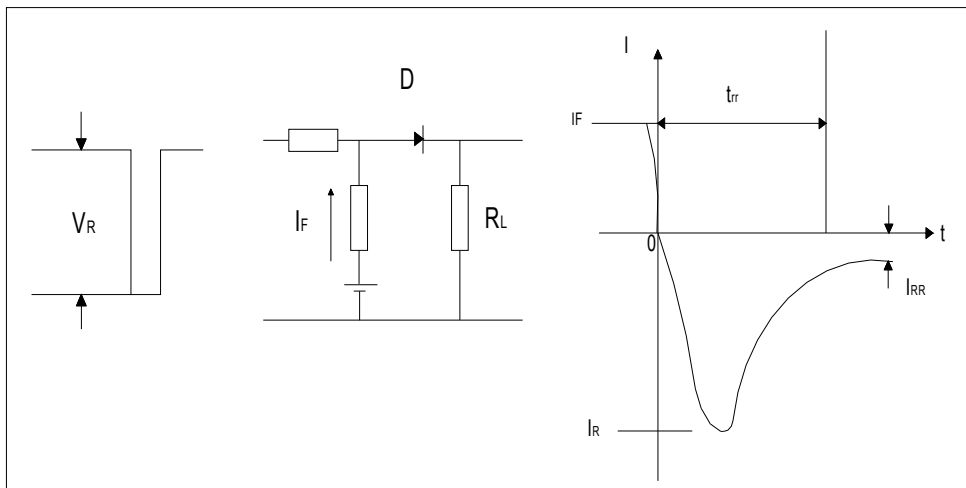

Diagram of circuit and Testing wave form of reverse recovery time



# TO-220-3L Package Outline Dimensions



Symbol	Dimensions In Millimeters		Dimensions In Inches	
	Min	Max	Min	Max
A	4.450	4.750	0.175	0.187
A1	2.520	2.820	0.099	0.111
b	0.710	0.910	0.028	0.036
b1	1.170	1.370	0.046	0.054
c	0.300	0.500	0.012	0.020
c1	1.170	1.370	0.046	0.054
D	9.830	10.330	0.387	0.407
E	8.500	8.900	0.335	0.350
E1	12.050	12.650	0.474	0.498
e	2.540 TYP		0.100 TYP	
e1	4.900	5.200	0.192	0.205
F	2.540	2.940	0.100	0.116
h	0.100 TYP		0.004 TYP	
L	13.300	13.800	0.523	0.543
L1	3.540	3.940	0.139	0.155
$\Phi$	3.735	3.935	0.147	0.155

# TO-220F Package Outline Dimensions



Symbol	Dimensions In Millimeters		Dimensions In Inches	
	Min.	Max.	Min.	Max.
A	4.300	4.700	0.169	0.185
A1	1.300 REF.		0.051 REF.	
A2	2.800	3.200	0.110	0.126
A3	2.500	2.900	0.098	0.114
b	0.500	0.750	0.020	0.030
b1	1.100	1.350	0.043	0.053
b2	1.500	1.750	0.059	0.069
c	0.500	0.750	0.020	0.030
D	9.960	10.360	0.392	0.408
E	14.800	15.200	0.583	0.598
e	2.540 TYP.		0.100 TYP.	
F	2.700 REF.		0.106 REF.	
Φ	3.500 REF.		0.138 REF.	
h	0.000	0.300	0.000	0.012
h1	0.800 REF.		0.031 REF.	
h2	0.500 REF.		0.020 REF.	
L	28.000	28.400	1.102	1.118
L1	1.700	1.900	0.067	0.075
L2	1.900	2.100	0.075	0.083

## X-ON Electronics

Largest Supplier of Electrical and Electronic Components

*Click to view similar products for [Rectifiers](#) category:*

*Click to view products by [Changjing Electronics Technology](#) manufacturer:*

Other Similar products are found below :

[70HFR40](#) [FR105 R0](#) [RL252-TP](#) [1N5397](#) [1N4005-TR](#) [1N4007-BP](#) [UFS120Je3/TR13](#) [20ETS12S](#) [RRE02VS6SGTR](#) [MS306](#) [A1N5404G-G](#)  
[CRF02\(T5L,TEMQ\)](#) [ACGRB207-HF](#) [CLH07\(TE16L,Q\)](#) [CLH03\(TE16L,Q\)](#) [1N5395-TP](#) [UES1302](#) [ACGRC307-HF](#) [ACEFC304-HF](#) [DZ-](#)  
[1380](#) [85HFR60](#) [40HFR60](#) [70HF120](#) [85HFR80](#) [SCF7500](#) [SM100](#) [ACGRA4001-HF](#) [SKN70/08](#) [NTE5819](#) [NTE5827](#) [NTE5828](#) [NTE5911](#)  
[NTE5915](#) [NTE6104](#) [NTE6163](#) [NTE6164](#) [NTE6165](#) [NTE6364](#) [TSD3G](#) [SET130312](#) [NRVUS110VT3G](#) [UES1106](#) [UES1306](#)  
[NRVUS240VT3G](#) [D5FE60-5063](#) [R4000GPS-TP](#) [D4015L56TP](#) [UES1306HR2](#) [FX20K120](#) [D20XB60-7101](#)