

TO-220F-2L Plastic-Encapsulate Diode

MURF20H60 HYPERFAST RECTIFIER, FRED

MAIN CHARACTERISTICS

I_o	20A
V_{RRM}	600V
T_{rr}	19ns
T_j	175°C
$V_{F(typ)}$	1.3V(@ $T_j=150^\circ\text{C}$)

FEATURES

- Ultrafast Recovery Times and Low Recovery Loss
- Low Forward Voltage
- Low Reverse Leakage Current

APPLICATIONS

Specifically designed to improve efficiency of PFC and output rectification stages of EV / HEV battery charging stations, booster stage of solar inverters and UPS applications, these devices are perfectly matched to operate with MOSFETs or high speed IGBTs.

MARKING

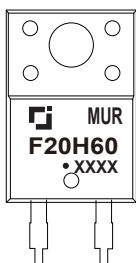

MURF20H60 = Device code
 Solid dot = Green molding compound device
 if none, the normal device
 XXXX = Code

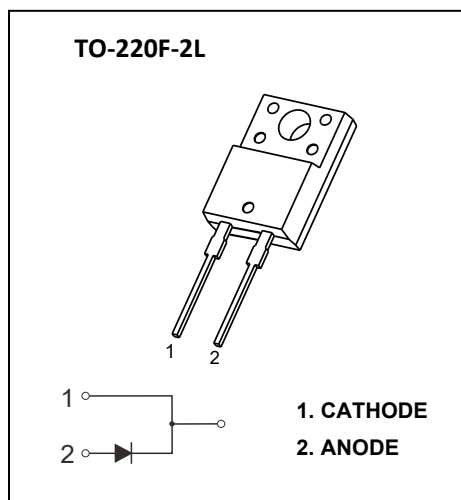

MAXIMUM RATINGS ($T_c=25^\circ\text{C}$ unless otherwise noted)

Symbol	Parameter	MURF20H60	Unit
V_{RRM}	Peak Repetitive Reverse Voltage	600	V
V_R	DC Blocking Voltage		
$I_{F(AV)}$	Average Forward Current($T_c=55^\circ\text{C}$)	20	A
$I_{F(RMS)}$	RMS Forward Current($T_c=55^\circ\text{C}$)	28	A
I_{FSM}	Non-Repetitive Surge Forward Current (8.3ms)	240	A
P_D	Power dissipation	54	W
$R_{\theta JC}$	Thermal Resistance From Junction to Case	2.8	$^\circ\text{C}/\text{W}$
T_j	Operating Junction Temperature Range	-55 ~ +175	$^\circ\text{C}$
T_{stg}	Storage Temperature Range	-55 ~ +175	$^\circ\text{C}$

Typical Characteristics

ELECTRICAL CHARACTERISTICS ($T_c=25^\circ\text{C}$ unless otherwise specified)

Symbol	Parameter	Test Conditions	Min.	Typ.	Max.	Unit
$V_{(BR)}$	Reverse Voltage	$I_R=100\mu\text{A}$	600			V
I_R	Reverse Current	$V_R=600\text{V}$	$T_j=25^\circ\text{C}$		10	μA
			$T_j=150^\circ\text{C}$		500	μA
V_F	Forward Voltage	$I_F=20\text{A}$	$T_j=25^\circ\text{C}$	2.15	2.5	V
			$T_j=150^\circ\text{C}$	1.3		V
C_{tot}	Total Capacitance	$V_R=200\text{V}, f=1\text{MHz}$		30		pF
trr	Reverse Recovery time	$I_F=0.5\text{A}, I_R=1\text{A}, I_{rr}=0.25\text{A}$		31		ns
		$I_F=1\text{A}, V_R=30\text{V}, di_F/dt=200\text{A}/\mu\text{s}$		19		ns

ELECTRICAL CHARACTERISTICS ($T_c=25^\circ\text{C}$ unless otherwise specified)

Symbol	Parameter	Test Conditions	Min.	Typ.	Max.	Unit
trr	Reverse Recovery Time	$I_F=20\text{A}, V_R=400\text{V}, di_F/dt=200\text{A}/\mu\text{s}$		29		ns
I_{RRM}	Max. Reverse Recovery Current			2.3		A
Qrr	Reverse Recovery Charge			38		nC
trr	Reverse Recovery Time	$I_F=20\text{A}, V_R=400\text{V}, di_F/dt=200\text{A}/\mu\text{s}, T_j=125^\circ\text{C}$		71		ns
I_{RRM}	Max. Reverse Recovery Current			6		A
Qrr	Reverse Recovery Charge			236		nC
trr	Reverse Recovery Time	$I_F=20\text{A}, V_R=400\text{V}, di_F/dt=600\text{A}/\mu\text{s}, T_j=125^\circ\text{C}$		40		ns
I_{RRM}	Max. Reverse Recovery Current			17		A
Qrr	Reverse Recovery Charge			367		nC

Typical Characteristics

Forward Characteristics

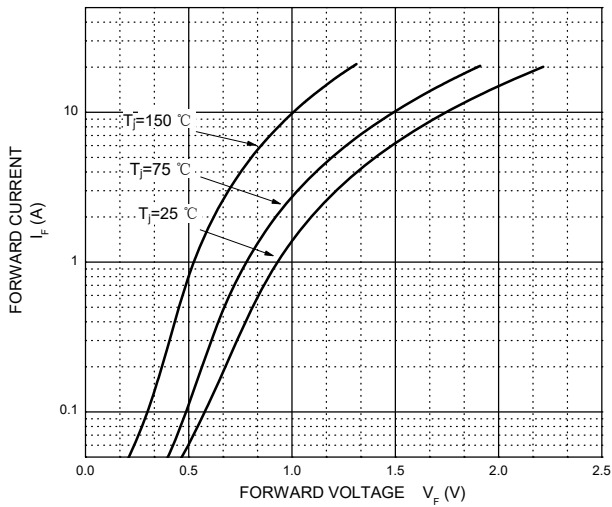

Reverse Characteristics

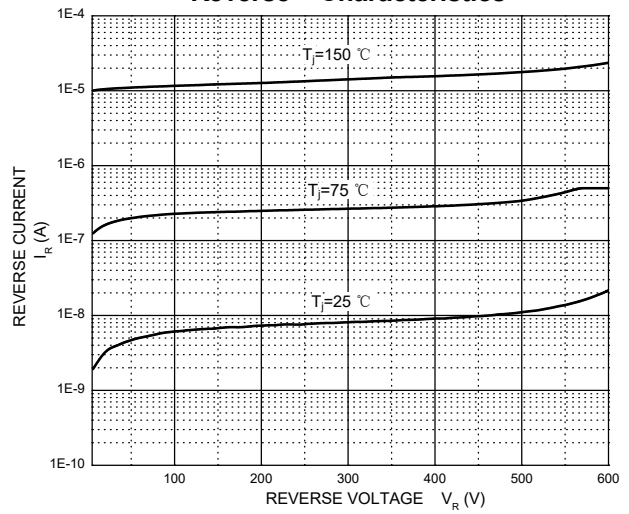

Capacitance Characteristics Per Diode

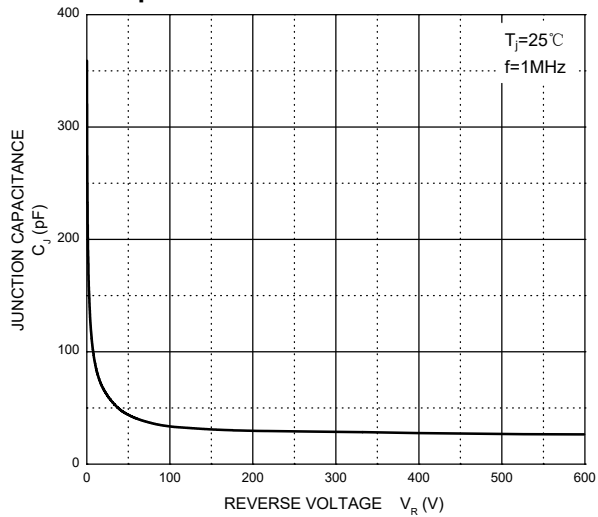

Reverse Recovery Time vs. di_F/dt

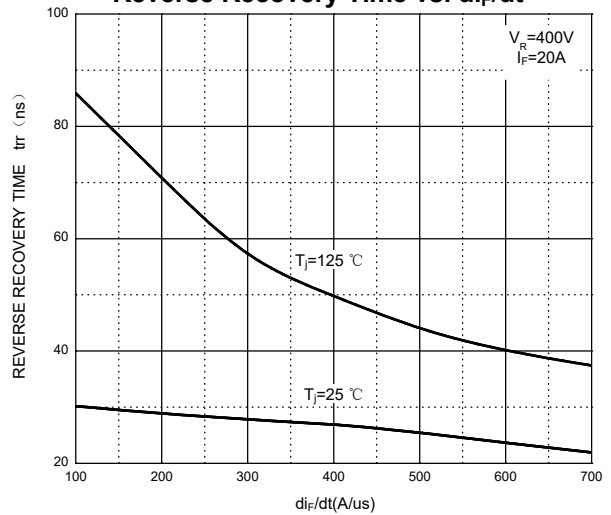

Stored Charge vs. di_F/dt

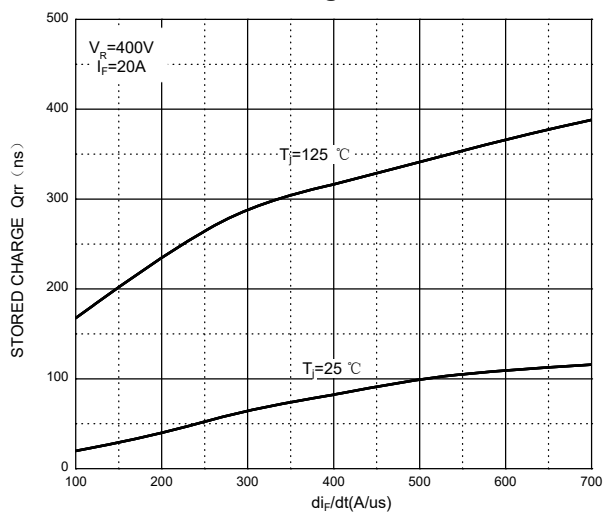

Recovery Current vs. di_F/dt

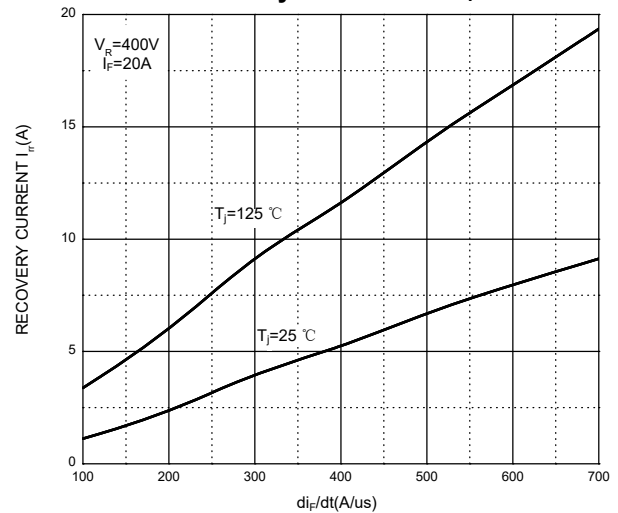

Typical Characteristics

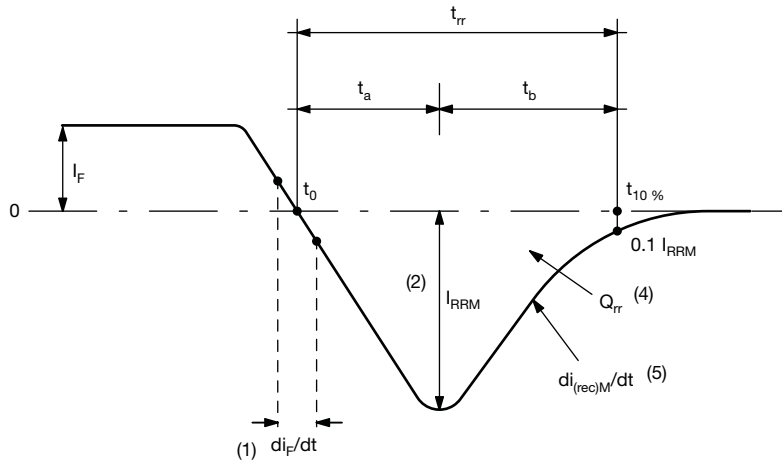

Reverse Recovery Waveform and Definitions

MURF20H60 Transient Thermal Impedance, Junction-Case

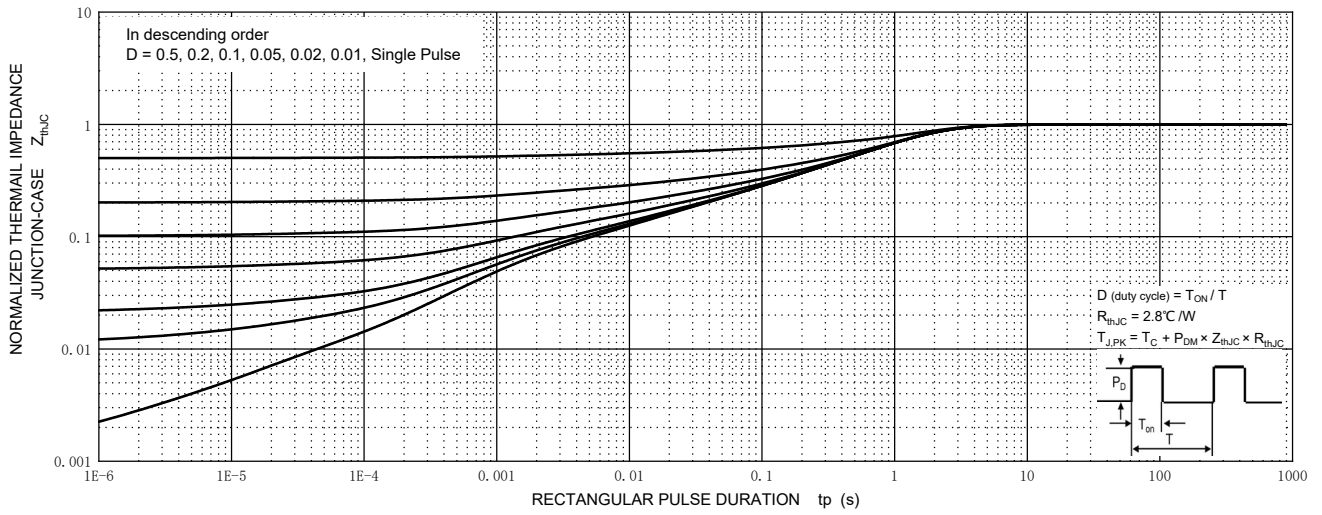

TO-220F-2L Package Outline Dimensions

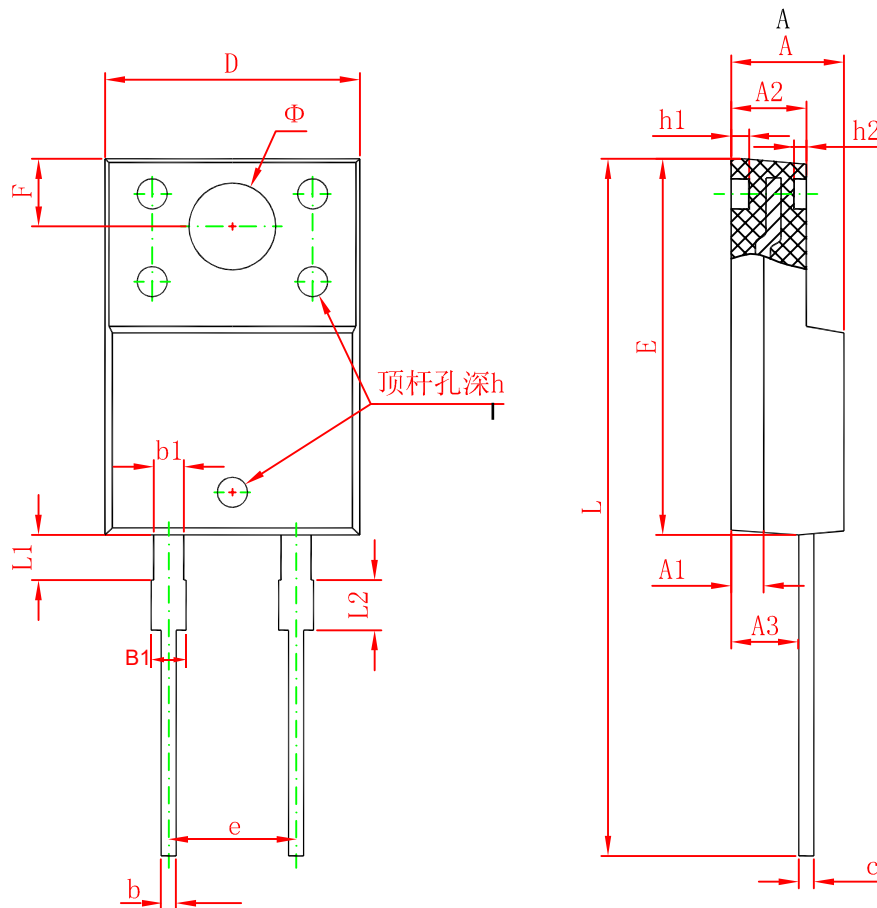

Symbol	Dimensions In Millimeters		Dimensions In Inches	
	Min.	Max.	Min.	Max.
A	4.300	4.700	0.169	0.185
A1	1.200 REF.		0.047 REF.	
A2	2.800	3.200	0.110	0.126
A3	2.500	2.900	0.098	0.114
b	0.710	0.910	0.028	0.036
b1	1.100	1.350	0.043	0.053
B1	1.150	1.400	0.045	0.055
c	0.500	0.750	0.020	0.030
D	9.960	10.360	0.392	0.408
E	14.800	15.200	0.583	0.598
e	5.080 TYP.		0.200 TYP.	
F	2.700 REF.		0.106 REF.	
Φ	3.300 REF.		0.130 REF.	
h	0.000	0.300	0.000	0.012
h1	0.800 REF.		0.031 REF.	
h2	0.500 REF.		0.020 REF.	
L	28.000	28.400	1.102	1.118
L1	2.100	2.400	0.082	0.094
L2	1.300	1.700	0.051	0.066

X-ON Electronics

Largest Supplier of Electrical and Electronic Components

Click to view similar products for [Rectifiers](#) category:

Click to view products by [Changjing Electronics Technology](#) manufacturer:

Other Similar products are found below :

[70HFR40](#) [FR105 R0](#) [RL252-TP](#) [1N5397](#) [1N4005-TR](#) [1N4007-BP](#) [UFS120Je3/TR13](#) [20ETS12S](#) [RRE02VS6SGTR](#) [MS306](#) [A1N5404G-G](#)
[CRF02\(T5L,TEMQ\)](#) [ACGRB207-HF](#) [CLH07\(TE16L,Q\)](#) [CLH03\(TE16L,Q\)](#) [1N5395-TP](#) [UES1302](#) [ACGRC307-HF](#) [ACEFC304-HF](#) [DZ-](#)
[1380](#) [85HFR60](#) [40HFR60](#) [70HF120](#) [85HFR80](#) [SCF7500](#) [SM100](#) [ACGRA4001-HF](#) [SKN70/08](#) [NTE5819](#) [NTE5827](#) [NTE5828](#) [NTE5911](#)
[NTE5915](#) [NTE6104](#) [NTE6163](#) [NTE6164](#) [NTE6165](#) [NTE6364](#) [TSD3G](#) [SET130312](#) [NRVUS110VT3G](#) [UES1106](#) [UES1306](#)
[NRVUS240VT3G](#) [D5FE60-5063](#) [R4000GPS-TP](#) [D4015L56TP](#) [UES1306HR2](#) [FX20K120](#) [D20XB60-7101](#)