



**TO-263-2L Plastic-Encapsulate Diode**

**SBDB2045TCTB** SCHOTTKY BARRIER RECTIFIER

**MAIN CHARACTERISTICS**

|              |                          |
|--------------|--------------------------|
| $I_o$        | <b>20 (2×10) A</b>       |
| $V_{RRM}$    | <b>45 V</b>              |
| $T_j$        | <b>150 °C</b>            |
| $V_{F(typ)}$ | <b>0.38V (@Ta=125°C)</b> |

**FEATURES**

- Low Power Loss,High Efficiency
- Guard Ring Die Construction for Transient Protection
- High Current Capability and Low Forward Voltage Drop

**MARKING**

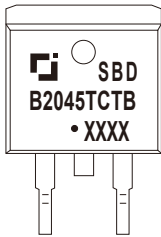

SBDB2045TCTB = Device code  
 Solid dot = Green molding compound device  
 if none, the normal device  
 XXXX = Code

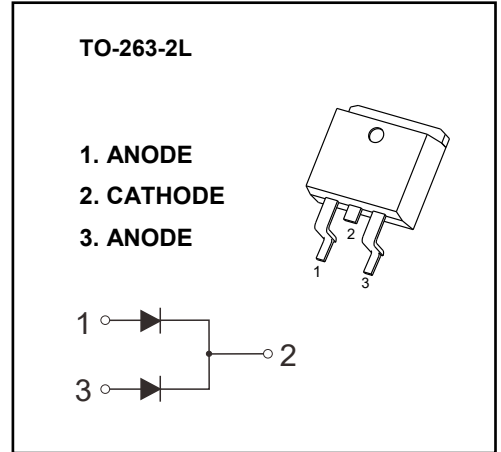

**MAXIMUM RATINGS (  $T_a=25^\circ\text{C}$  unless otherwise noted )**

| Symbol          | Parameter   | Value    | Unit                      |
|-----------------|---|----------|---------------------------|
| $V_{RRM}$       | Peak repetitive reverse voltage                                   | 45       | V                         |
| $V_{RWM}$       | Working peak reverse voltage                                      |          |                           |
| $V_R$           | DC blocking voltage   |          |                           |
| $V_{R(RMS)}$    | RMS reverse voltage   | 31.5     | V                         |
| $I_o$           | Average rectified output current                                  | 20       | A                         |
| $I_{FSM}$       | Non-Repetitive peak forward surge current (8.3ms half sine wave)  | 200      | A                         |
| $R_{\theta JC}$ | Thermal resistance from junction to case , $T_c=25^\circ\text{C}$ | 2.0      | $^\circ\text{C}/\text{W}$ |
| $R_{\theta JA}$ | Thermal resistance from junction to ambient                       | 62.5     | $^\circ\text{C}/\text{W}$ |
| $T_j$           | Junction temperature  | 150      | $^\circ\text{C}$          |
| $T_{stg}$       | Storage temperature   | -55~+150 | $^\circ\text{C}$          |

**ELECTRICAL CHARACTERISTICS (  $T_a=25^\circ\text{C}$  unless otherwise specified)**

| Parameter       | Symbol     | Test conditions    | Min                     | Typ  | Max  | Unit          |
|-----------------|------------|--------------------|-------------------------|------|------|---------------|
| Reverse voltage | $V_{(BR)}$ | $I_R=1.0\text{mA}$ | 45                      |      |      | V             |
| Reverse current | $I_R$      | $V_R=45\text{V}$   | $T_j=25^\circ\text{C}$  | 50   | 100  | $\mu\text{A}$ |
|                 |            |                    | $T_j=125^\circ\text{C}$ | 20   |      | mA            |
| Forward voltage | $V_F$      | $I_F=5\text{A}$    | $T_j=25^\circ\text{C}$  | 0.40 |      | V             |
|                 |            |                    | $T_j=125^\circ\text{C}$ | 0.30 |      | V             |
|                 |            | $I_F=10\text{A}$   | $T_j=25^\circ\text{C}$  | 0.46 | 0.55 | V             |
|                 |            |                    | $T_j=125^\circ\text{C}$ | 0.38 |      | V             |

\*Pulse test: pulse width  $\leq 300\mu\text{s}$ , duty cycles  $\leq 2.0\%$ .

# Typical Characteristics

FIG.1: FORWARD CURRENT DERATING CURVE

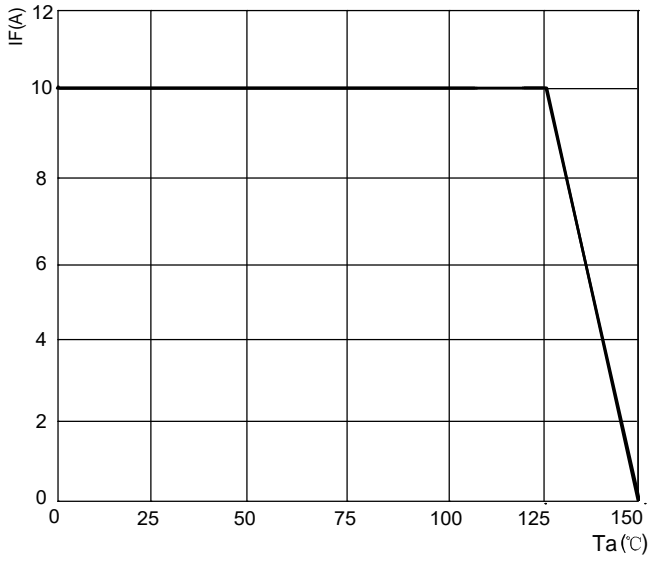

FIG.2: TYPICAL FORWARD CHARACTERISTICS

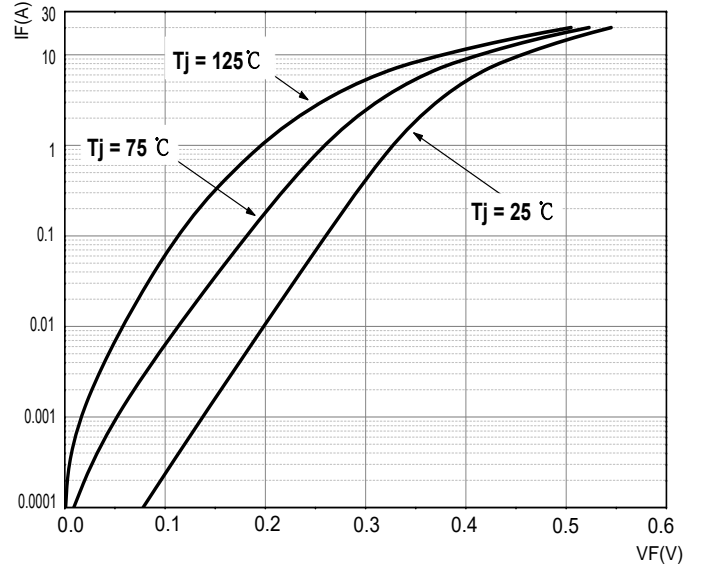

FIG.3: TOTAL CAPACITANCE DERATING CURVE

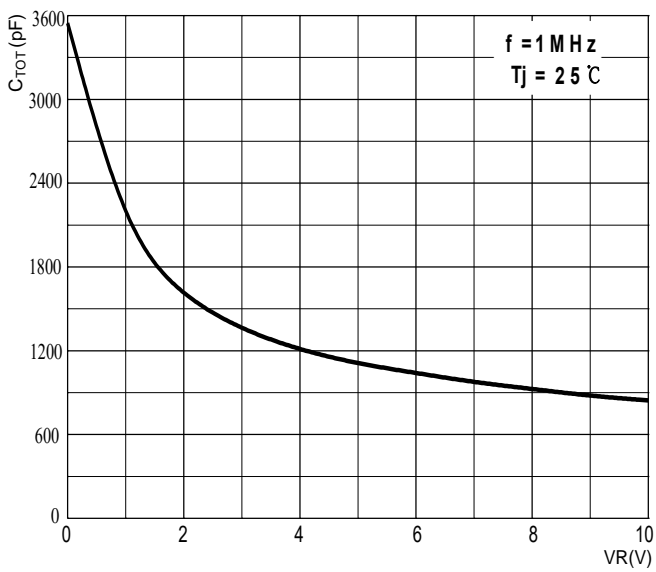
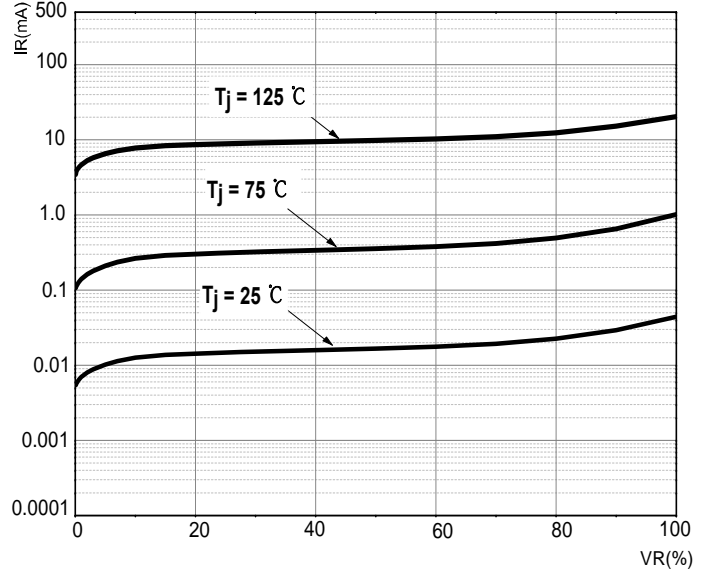
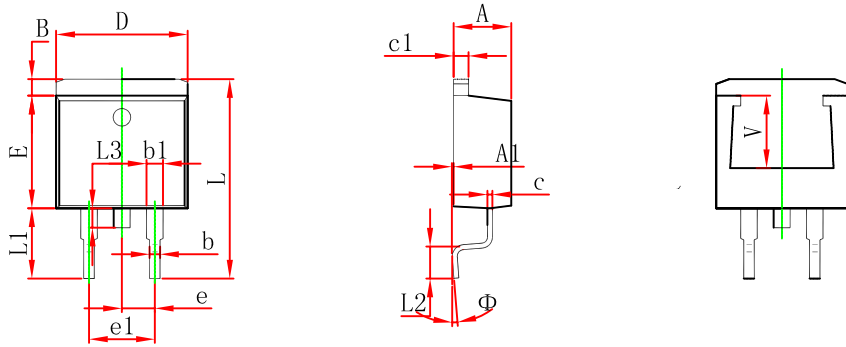

FIG.4: TYPICAL REVERSE CHARACTERISTICS



## TO-263-2L Package Outline Dimensions



| Symbol | Dimensions In Millimeters |        | Dimensions In Inches |       |
|--------|---------------------------|--------|----------------------|-------|
|        | Min.                      | Max.   | Min.                 | Max.  |
| A      | 4.470                     | 4.670  | 0.176                | 0.184 |
| A1     | 0.000                     | 0.150  | 0.000                | 0.006 |
| B      | 1.120                     | 1.420  | 0.044                | 0.056 |
| b      | 0.710                     | 0.910  | 0.028                | 0.036 |
| b1     | 1.170                     | 1.370  | 0.046                | 0.054 |
| c      | 0.310                     | 0.530  | 0.012                | 0.021 |
| c1     | 1.170                     | 1.370  | 0.046                | 0.054 |
| D      | 10.010                    | 10.310 | 0.394                | 0.406 |
| E      | 8.500                     | 8.900  | 0.335                | 0.350 |
| e      | 2.540 TYP.                |        | 0.100 TYP.           |       |
| e1     | 4.980                     | 5.180  | 0.196                | 0.204 |
| L      | 14.940                    | 15.500 | 0.588                | 0.610 |
| L1     | 4.950                     | 5.450  | 0.195                | 0.215 |
| L2     | 2.340                     | 2.740  | 0.092                | 0.108 |
| L3     | 1.300                     | 1.700  | 0.051                | 0.067 |
| Φ      | 0° 8°                     |        | 0° 8°                |       |
| V      | 5.600 REF.                |        | 0.220 REF.           |       |

## TO-263-2L Suggested Pad Layout

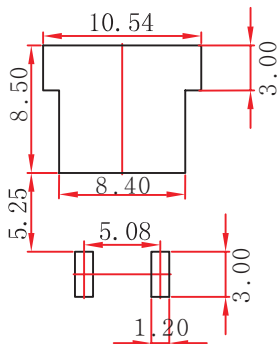

**Note:**

1. Controlling dimension: in millimeters.
2. General tolerance:  $\pm 0.05\text{mm}$ .
3. The pad layout is for reference purposes only.

**NOTICE**

JSCJ reserves the right to make modifications, enhancements, improvements, corrections or other changes without further notice to any product herein. JSCJ does not assume any liability arising out of the application or use of any product described herein.

# TO-263-2L Tape and Reel

## TO-263-2L Embossed Carrier Tape

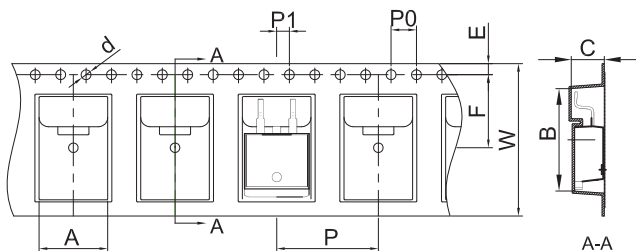

### Packaging Description:

TO-263-2L parts are shipped in tape. The carrier tape is made from a dissipative (carbon filled) polycarbonate resin. The cover tape is a multilayer film (Heat Activated Adhesive in nature) primarily composed of polyester film, adhesive layer, sealant, and anti-static sprayed agent. These reeled parts in standard option are shipped with 800 units per 13" or 33.0 cm diameter reel. The reels are clear in color and is made of polystyrene plastic (anti-static coated).

| Dimensions are in millimeter |       |       |      |       |      |       |      |       |      |       |
|------------------------------|-------|-------|------|-------|------|-------|------|-------|------|-------|
| Pkg type                     | A     | B     | C    | d     | E    | F     | P0   | P     | P1   | W     |
| TO-263-2L                    | 10.80 | 16.13 | 5.21 | Ø1.55 | 1.75 | 11.50 | 4.00 | 16.00 | 2.00 | 24.00 |

## TO-263-2L Tape Leader and Trailer

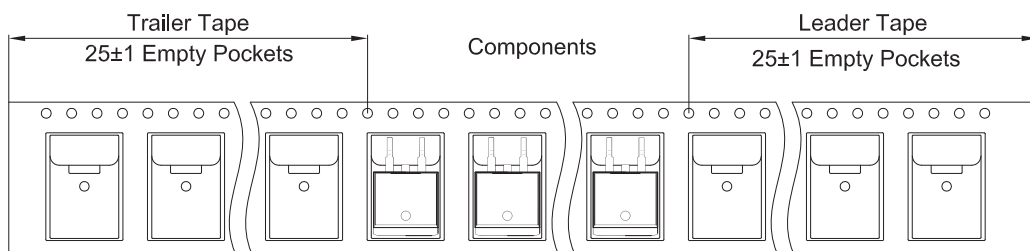

## TO-263-2L Reel

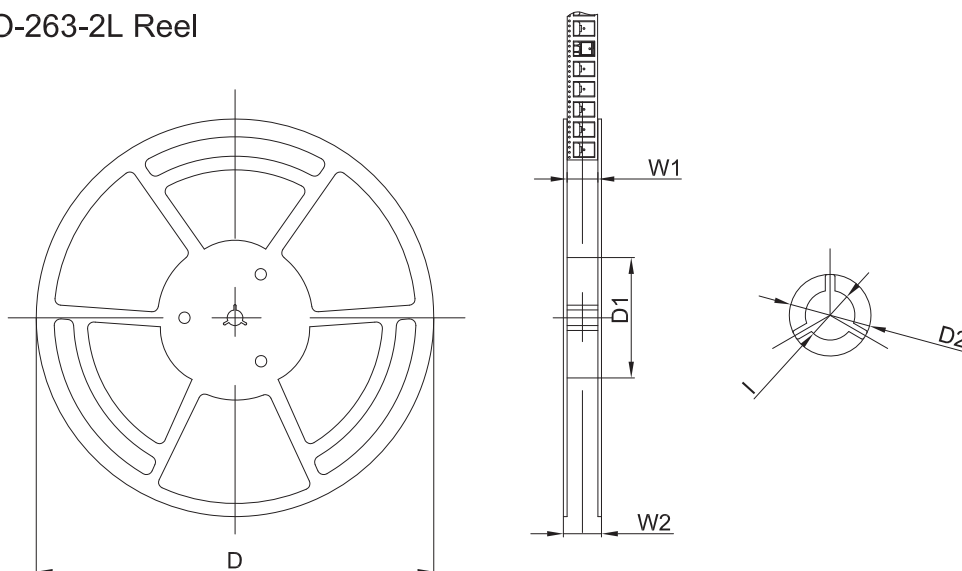

| Dimensions are in millimeter |         |        |        |      |      |        |
|------------------------------|---------|--------|--------|------|------|--------|
| Reel Option                  | D       | D1     | D2     | W1   | W2   | I      |
| 13"Dia                       | Ø330.00 | 100.00 | Ø21.00 | 24.4 | 30.4 | Ø13.00 |

| REEL    | Reel Size | Box     | Box Size(mm) | Carton    | Carton Size(mm) | G.W.(kg) |
|---------|-----------|---------|--------------|-----------|-----------------|----------|
| 800 pcs | 13 inch   | 800 pcs | 340×336×36   | 8,000 pcs | 400×353×365     |          |

## X-ON Electronics

Largest Supplier of Electrical and Electronic Components

*Click to view similar products for [Schottky Diodes & Rectifiers](#) category:*

*Click to view products by [Changjing Electronics Technology](#) manufacturer:*

Other Similar products are found below :

[MA4E2039](#) [MMBD301M3T5G](#) [RB160M-50TR](#) [D83C](#) [BAS16E6433HTMA1](#) [BAS 3010S-02LRH E6327](#) [BAT 54-02LRH E6327](#)  
[NRVBAF360T3G](#) [NSR05F40QNXT5G](#) [NTE555](#) [JANS1N6640](#) [SS3003CH-TL-E](#) [GA01SHT18](#) [CRS10I30A\(TE85L,QM](#) [MBRA140TRPBF](#)  
[MBRB30H30CT-1G](#) [BAT 15-04R E6152](#) [JANTX1N5712-1](#) [DMJ3940-000](#) [SB007-03C-TB-E](#) [NRVBB20100CTT4G](#) [NRVBM120LT1G](#)  
[NTSB30U100CT-1G](#) [CRG04\(T5L,TEMQ\)](#) [ACDBA1100LR-HF](#) [ACDBA1200-HF](#) [ACDBA240-HF](#) [ACDBA3100-HF](#) [CDBQC0530L-HF](#)  
[ACDBA260LR-HF](#) [ACDBA1100-HF](#) [10BQ015-M3/5BT](#) [NRVBM120ET1G](#) [VSSB410S-M3/5BT](#) [1N5819T-G](#) [PDS1040Q-13](#) [B160BQ-13-F](#)  
[SDM05U20CSP-7](#) [BAS 70-07 E6433](#) [B140S1F-7](#) [HSM560Je3/TR13](#) [DDB2265-000](#) [ZHCS506QTA](#) [HSM190Je3/TR13](#) [B330AF-13](#)  
[ACDBUC0230-HF](#) [SDM1U100S1F-7](#) [MBR10200CTF-G1](#) [CDLL5712](#) [DMF2822-000](#)