

TO-277 Plastic-Encapsulate Diodes

SP5300L Schottky Rectifier Diode

Features

- $I_{F(AV)}$ 5A
- V_{RRM} 300V
- High surge current capability
- Low peak forward voltage

Applications

- Rectifier

Marking

- SP5300L:SP5300L

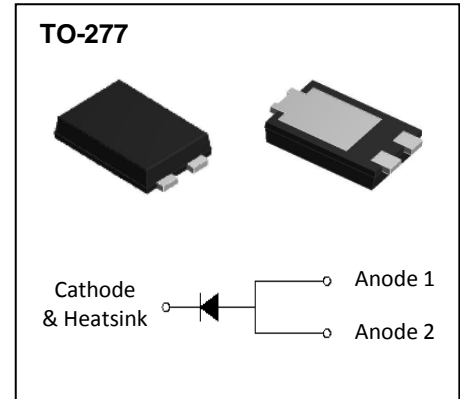

Limiting Values(Absolute Maximum Rating)

Item	Symbol	Unit	Test Conditions	SP5300L
Repetitive Peak Reverse Voltage	V_{RRM}	V		300
Maximum RMS Voltage	V_{RMS}	V		210
Maximum DC blocking Voltage	V_{DC}	V		300
Average Forward Current	$I_{F(AV)}$	A	60Hz Half-sine wave, Resistance load, TL(Fig.1)	5
Surge(Non-repetitive)Forward Current	I_{FSM}	A	60Hz Half-sine wave, 1 cycle, $T_a=25^\circ\text{C}$	100
Junction Temperature	T_J	$^\circ\text{C}$		-55 ~ +150
Storage Temperature	T_{STG}	$^\circ\text{C}$		-55 ~ +150

Electrical Characteristics ($T=25^\circ\text{C}$ Unless otherwise specified)

Item	Symbol	Unit	Test Condition	SP5300L	
Peak Forward Voltage	V_F	V	$I_F = 5.0\text{A}$	$T_a = 25^\circ\text{C}$	0.94(TYP) 0.96(MAX)
				$T_a = 125^\circ\text{C}$	0.75(TYP) 0.78(MAX)
Peak Reverse Current	I_{RRM1}	mA	$V_{RM} = V_{RRM}$	$T_a = 25^\circ\text{C}$	0.01(TYP) 0.03(MAX)
	I_{RRM2}			$T_a = 125^\circ\text{C}$	5(TYP) 10(MAX)
Thermal Resistance(Typical)	$R_{\theta J-L}$	$^\circ\text{C/W}$	Between junction and terminal	15	
Typical junction capacitance	C_J	pF	$V_R = 4.0\text{V}$, $f = 1\text{MHz}$	160	

Notes:

Thermal resistance from junction to ambient and from junction to lead mounted on P.C.B. with 0.3" x 0.3" (8.0 mm x 8.0 mm) copper pad areas

Typical Characteristics

FIG. 1: Forward Output Current Derating Curve

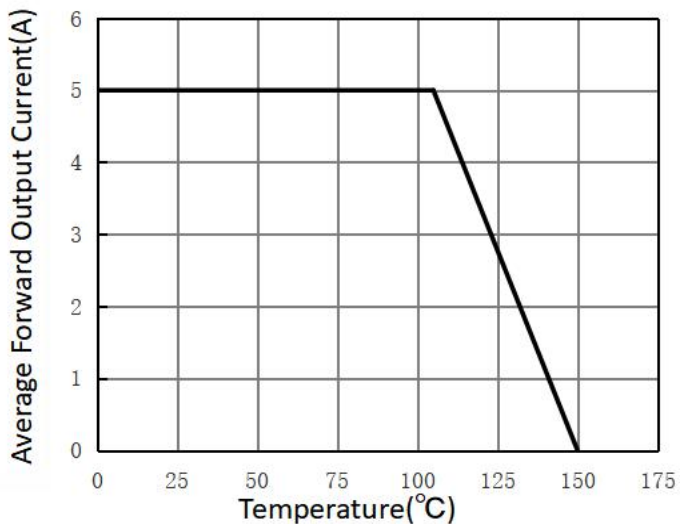

FIG.2: Maximum Non-Repetitive Peak Forward Surge Current

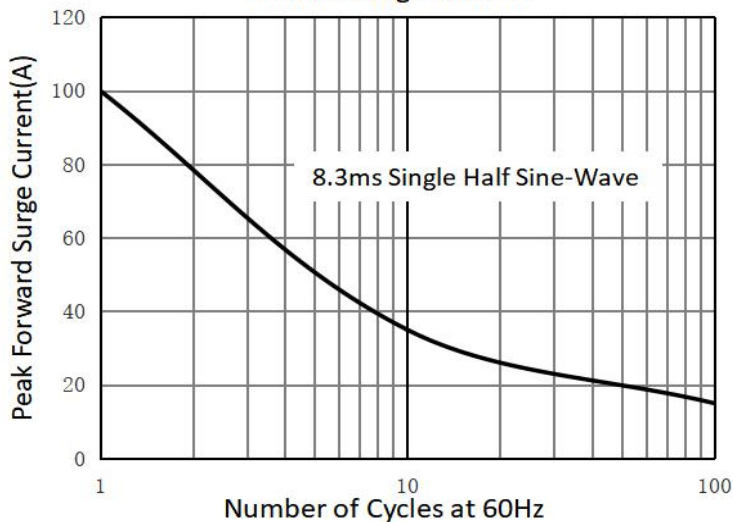

FIG.3: Typical Instantaneous Forward Characteristics

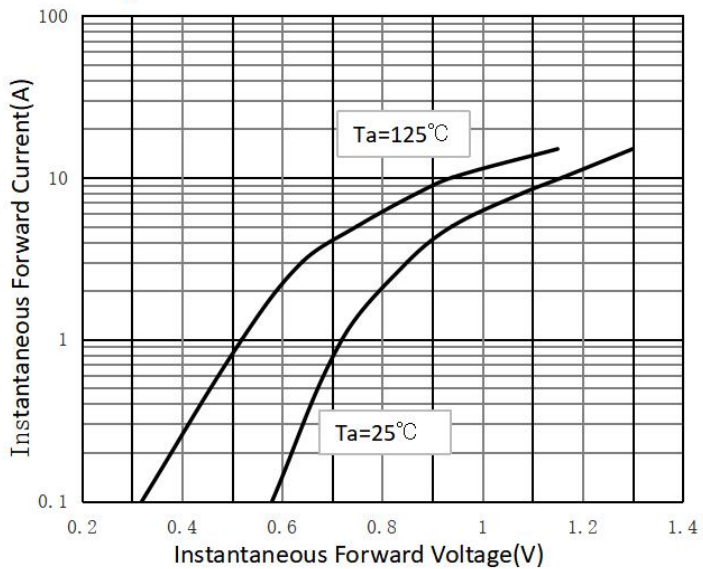
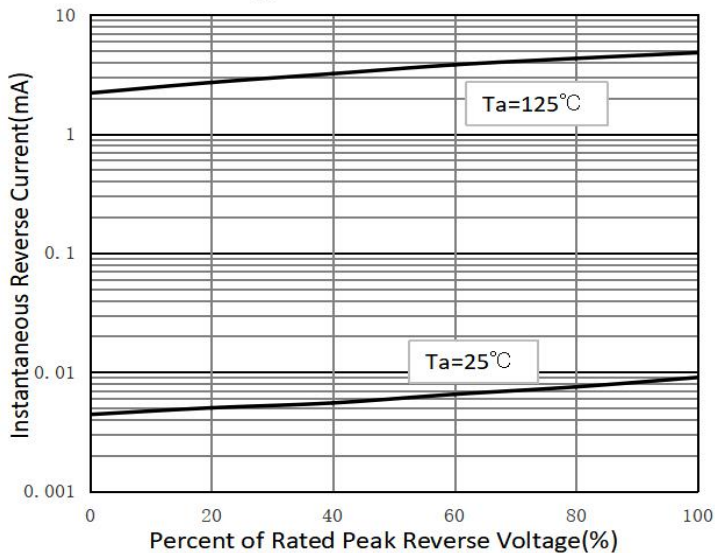
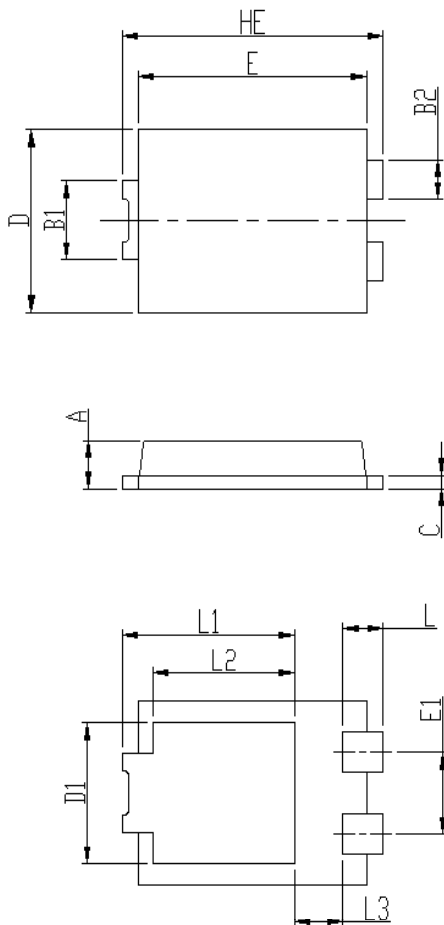

FIG.4: Typical Reverse Characteristics



TO- 277 Package Outline Dimensions



DIM	Unit: mm		Unit: inch	
	MIN	MAX	MIN	MAX
HE	6.4	6.6	0.252	0.260
E	5.6	5.8	0.220	0.228
D	4.1	4.3	0.161	0.169
B1	1.7	1.9	0.067	0.075
B2	0.8	1	0.031	0.039
A	1.05	1.2	0.041	0.047
C	0.3	0.4	0.012	0.016
L	0.85	1.1	0.033	0.043
L1	4.2	4.4	0.165	0.173
L2	3.52 Typ.		0.139 Typ.	
L3	1.1	1.4	0.043	0.055
D1	3	3.3	0.118	0.130
E1	1.86 Typ.		0.073 Typ.	

TO- 277 Suggested Pad Layout

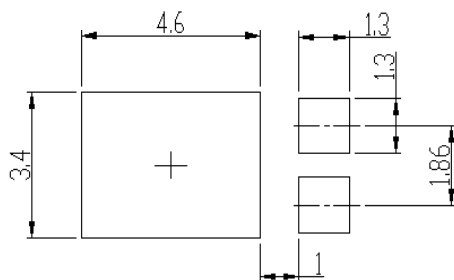

Note:

1. Controlling dimension: in millimeters.
2. General tolerance: ± 0.05 mm.
3. The pad layout is for reference purposes only.

NOTICE

JSCJ reserves the right to make modifications, enhancements, improvements, corrections or other changes without further notice to any product herein. JSCJ does not assume any liability arising out of the application or use of any product described herein.

X-ON Electronics

Largest Supplier of Electrical and Electronic Components

Click to view similar products for [Schottky Diodes & Rectifiers](#) category:

Click to view products by [Changjing Electronics Technology](#) manufacturer:

Other Similar products are found below :

[MA4E2039](#) [MMBD301M3T5G](#) [RB160M-50TR](#) [D83C](#) [BAS16E6433HTMA1](#) [BAS 3010S-02LRH E6327](#) [BAT 54-02LRH E6327](#)
[NRVBAF360T3G](#) [NSR05F40QNXT5G](#) [NTE555](#) [JANS1N6640](#) [SS3003CH-TL-E](#) [GA01SHT18](#) [CRS10I30A\(TE85L,QM](#) [MBRA140TRPBF](#)
[MBRB30H30CT-1G](#) [BAT 15-04R E6152](#) [JANTX1N5712-1](#) [DMJ3940-000](#) [SB007-03C-TB-E](#) [NRVBB20100CTT4G](#) [NRVBM120LT1G](#)
[NTSB30U100CT-1G](#) [CRG04\(T5L,TEMQ\)](#) [ACDBA1100LR-HF](#) [ACDBA1200-HF](#) [ACDBA240-HF](#) [ACDBA3100-HF](#) [CDBQC0530L-HF](#)
[ACDBA260LR-HF](#) [ACDBA1100-HF](#) [10BQ015-M3/5BT](#) [NRVBM120ET1G](#) [VSSB410S-M3/5BT](#) [1N5819T-G](#) [PDS1040Q-13](#) [B160BQ-13-F](#)
[SDM05U20CSP-7](#) [BAS 70-07 E6433](#) [B140S1F-7](#) [HSM560Je3/TR13](#) [DDB2265-000](#) [ZHCS506QTA](#) [HSM190Je3/TR13](#) [B330AF-13](#)
[ACDBUC0230-HF](#) [SDM1U100S1F-7](#) [MBR10200CTF-G1](#) [CDLL5712](#) [DMF2822-000](#)