



ZIR053C-35

Technical Data Sheet

5mm Infrared LED



Descriptions

The ZIR053C-35 is a high intensity diode, molded in a blue plastic package. The device is spectrally matched with phototransistor, photodiode and infrared receiver module.

Features

- High reliability
- High radiant intensity
- Peak wavelength $\lambda_p=940\text{nm}$
- Low forward voltage
- Pb.Free
- This product itself will remain within RoHS compliant version.

Applications

- Mouse
- Optoelectronic switch
- Copiers
- Scanners
- Amusement machines



Package Dimension

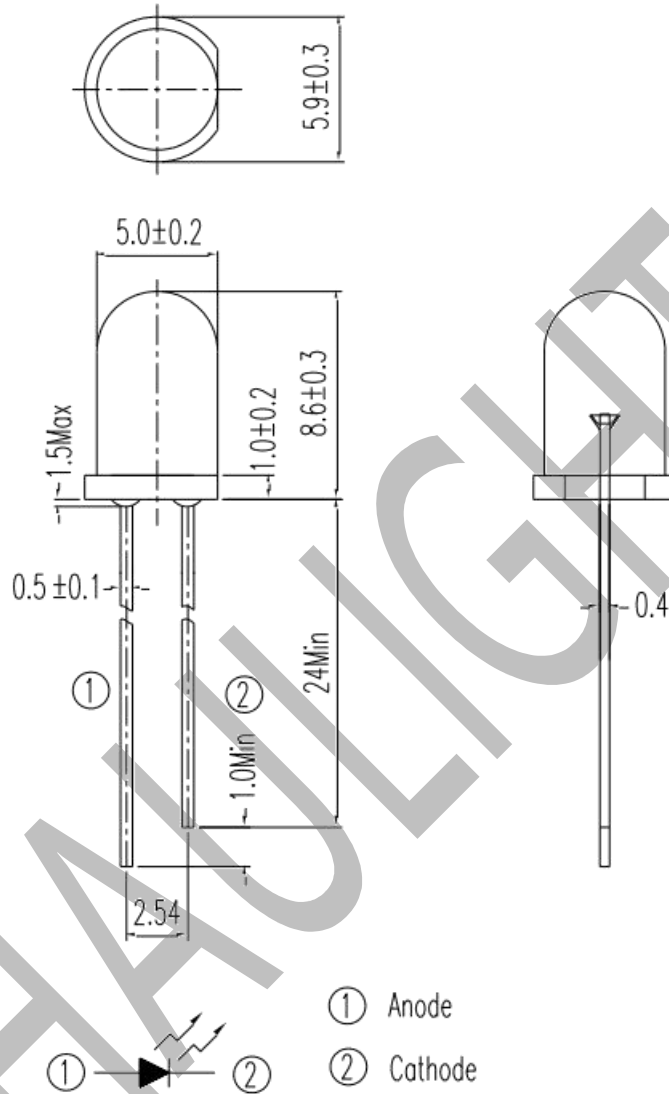

Notes:

- 1.All dimensions are in millimeters
- 2.Tolerances unless dimensions $\pm 0.3 \text{ mm}$
- 3.Lead spacing is measured where the lead emerge from the package



Absolute Maximum Ratings

Parameter (Ta=25°C)	Symbol	Ratings	Unit
Power Dissipation at(or below) 25 Free Air Temperature	Pd	150	mW
Reverse Voltage	V _R	5	V
Forward Current	I _F	100	mA
Peak Forward Current Pulse width ≤ 100μs,Duty cycle= 1%	I _{FP}	1	A
Operating Temperature	Topr	-40~+85	°C
Storage Temperature	Tstg	-40~+100	°C
Lead Soldering Temperature (2mm form body for 5 seconds)	Tsol	260	°C

Electro-Optical Characteristics

Parameter (Ta=25°C)	Symbol	Condition	Min.	Typ.	Max.	Units
Radiant Intensity	E _e	I _F =20mA	11.0	12.0	--	mW/sr
Radiant Intensity	E _e	I _F =100mA Pulse Width ≤ 100μs ,Duty cycle ≤ 1%	--	60	--	mW/sr
Radiant Intensity	E _e	I _F =1A Pulse Width ≤ 100μs ,Duty cycle ≤ 1%.	--	600	--	mW/sr
Peak Wavelength	λ _p	I _F =20mA	--	940	--	nm
Spectral Bandwidth	Δλ	I _F =20mA	--	45	--	nm
Forward Voltage	V _F	I _F =20mA	--	1.2	1.5	V
Reverse Current	I _R	V _R =5V	--	--	10	μA
View Angle	2θ1/2	I _F =20mA	--	40	--	deg



Rank

Parameter	Symbol	Condition	Min.	Max.	Unit
M	Ee	$I_F=20\text{mA}$	7.8	12.5	mW/sr
N	Ee	$I_F=20\text{mA}$	11.0	17.6	mW/sr

Note:

*Measurement Uncertainty of Forward Voltage: $\pm 0.1\text{V}$

*Measurement Uncertainty of Luminous Intensity: $\pm 10\%$

*Measurement Uncertainty of Dominant Wavelength $\pm 1.0\text{nm}$

CHAU LIGHT



Typical Electrical/Optical/Characteristics Curves

Fig.1 Forward Current vs. Ambient Temperature

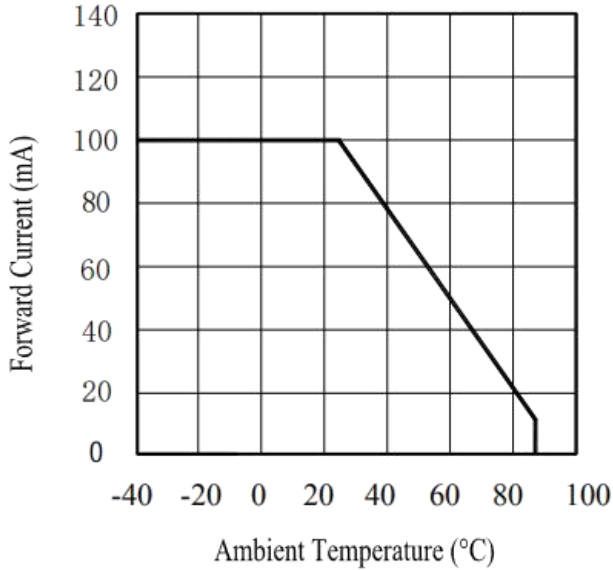

Fig.2 Spectral Distribution

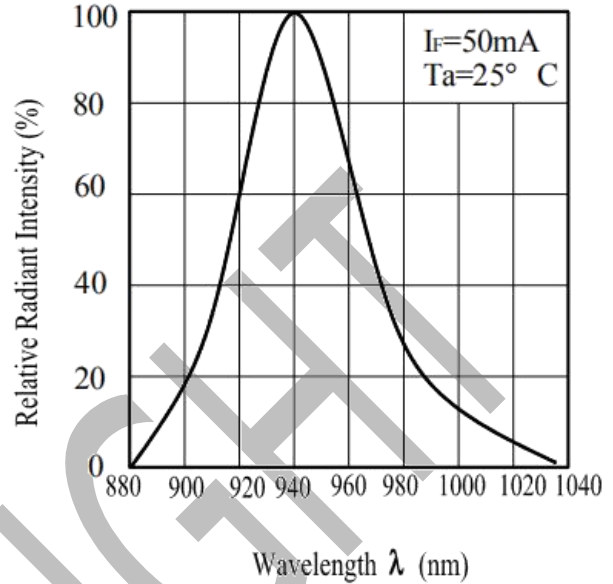

Fig.3 Peak Emission Wavelength vs. Ambient Temperature

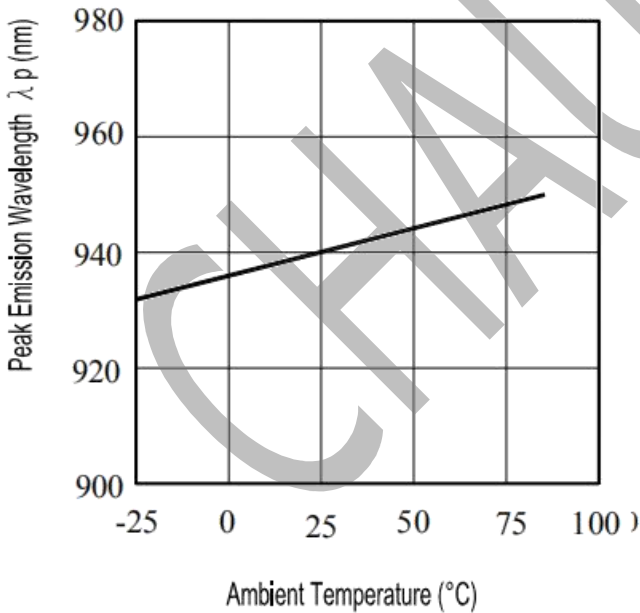

Fig.4 Forward Current vs. Forward Voltage

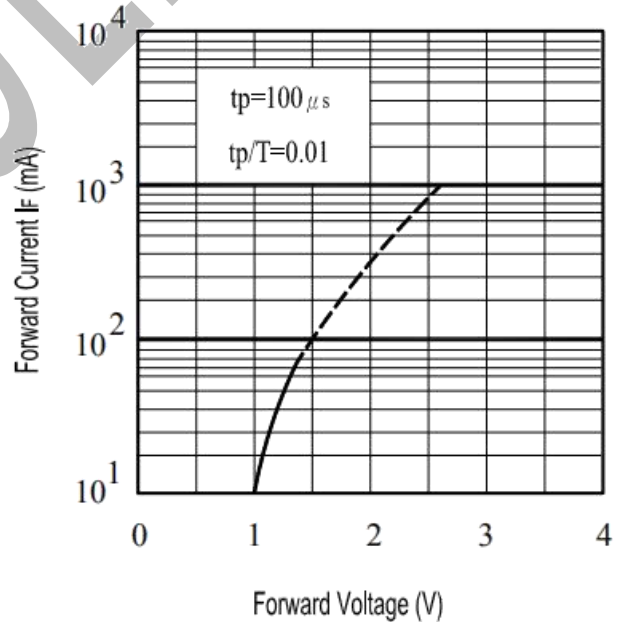



Fig.5 Radiant Intensity vs. Forward Current

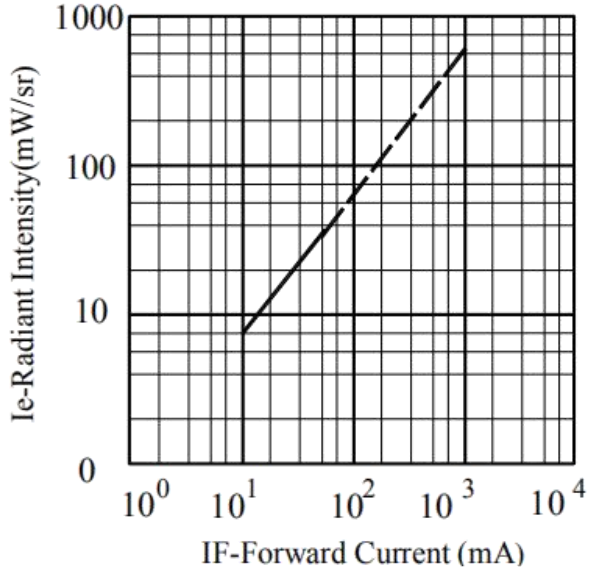
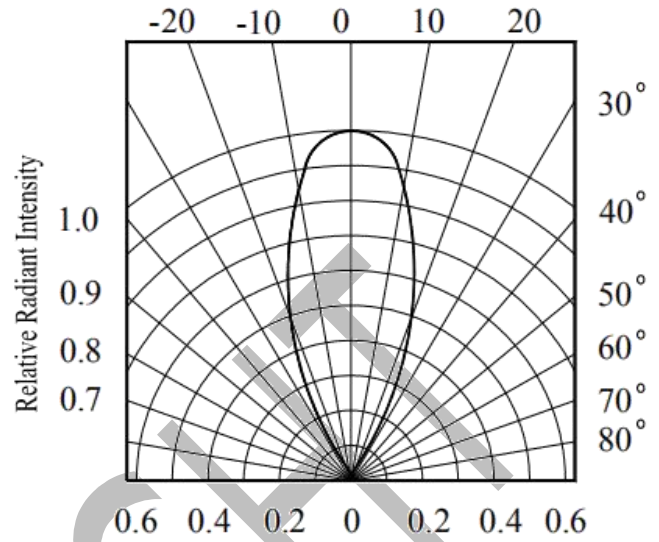

Fig.6 Relative Radiant Intensity vs. Angular Displacement





Packing Quantity Specification

- 1.500PCS/1bag, 4bags/1 Box
2. 10BOXES/1 Carton

Notes

1. Above specification may be changed without notice. CHAU LIGHT will reserve authority on material change for above specification.
2. When using this product, please observe the absolute maximum ratings and the instruction for using outlined in these specification sheets. CHAU LIGHT assumes no responsibility for any damage resulting from use of the product which does not comply with the absolute maximum ratings and the instructions included in these specification sheets.
3. These specification sheets include materials protected under copyright of CHAU LIGHT corporation. Please don't reproduce or cause anyone to reproduce them without CHAU LIGHT's consent.

CHAU LIGHT

X-ON Electronics

Largest Supplier of Electrical and Electronic Components

Click to view similar products for [Infrared Emitters](#) category:

Click to view products by [Chau Light](#) manufacturer:

Other Similar products are found below :

[LTE-309](#) [LTE-3279K](#) [LTE-4206C](#) [LTE-4208C](#) [EE-L105-X](#) [K3N](#) [QED123UL](#) [LTE-2871C](#) [LTE-2872U](#) [LTE-4238](#) [ASDL-4264-C22](#)
[TSHA6201](#) [TSHA6202](#) [HSDL-4400031](#) [EAIPL3528Z0](#) [OED-EL305F4C50-HT](#) [TSUS6202](#) [OP216-004](#) [VSMY98145DS](#) [VSMY99445DS](#)
[HL-PST-1608IR1C-L4](#) [IN-S126ETIR](#) [IN-S126DSHIR](#) [IN-S126ETHIR](#) [IN-P32ZTHIR](#) [IN-S126BTHIR](#) [IN-S63DTHIR](#) [IN-S85BTHIR](#) [IN-S63FTHIR](#) [E6C0805IRAC1UDA940nm](#) [HIR204C/H0](#) [HIR204/H0](#) [HIR323C](#) [LTE-209](#) [TSML1030](#) [IR12-21C/TR8](#) [IR17-21C/TR8](#) [IR383](#)
[IR91-21C/TR10](#) [WP7113F3BT](#) [SFH 4949](#) [LTE-4208](#) [OP235W](#) [OP297FAB](#) [TSHA5201](#) [TSHA5500](#) [TSTS7500](#) [TSUS5201](#) [TSUS5401](#)
[TSUS6402](#)