



ZPT054C

Technical Data Sheet

5mm Silicon Phototransistor



Descriptions

ZPT054C is a high speed and high sensitive NPN silicon phototransistor molded in a standard 5mm package.

Due to its water clear epoxy the device is sensitive to visible and near infrared radiation.

Features

- Fast response times
- High photo sensitivity
- Copliance with EU REACH
- Pb.Free
- The product itself will remain within RoHS compliant version.
- Compliance Halogen Free. (Br<900 ppm, Cl<900ppm, Br+Cl<1500ppm)

Applications

- Camera
- Infrared applied system



Package Dimension

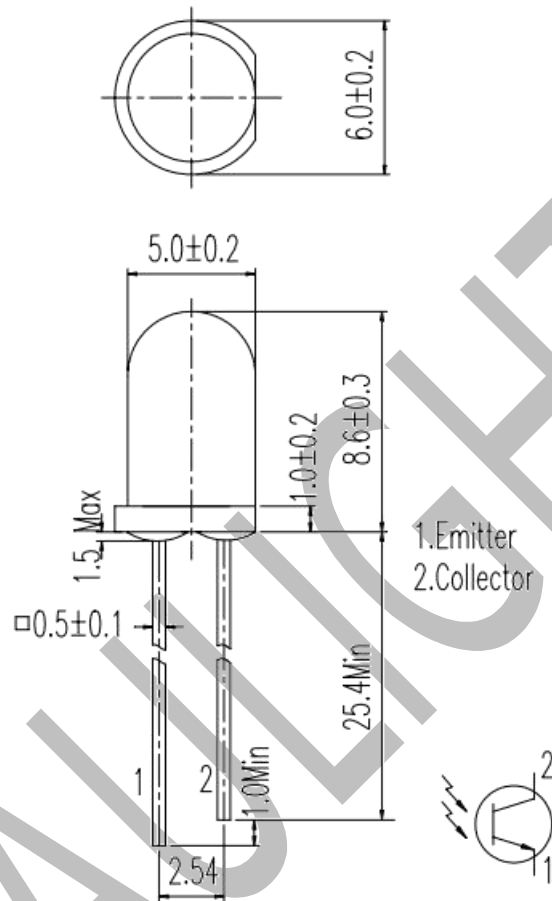

Notes:

1. All dimensions are in millimeters
2. Tolerances unless dimensions ± 0.3 mm
3. Lead spacing is measured where the lead emerge from the package



Absolute Maximum Ratings (Ta=25°C)

Parameter (Ta=25°C)	Symbol	Ratings	Unit
Collector-Emitter Voltage	V _{CEO}	30	V
Emitter-Collector-Voltage	V _{ECO}	5	V
Collector Current	I _C	20	mA
Operating Temperature	T _{opr}	-40 ~ +85	°C
Storage Temperature	T _{stg}	-40 ~ +100	°C
Lead Soldering Temperature*1	T _{sol}	260	°C
Power Dissipation at (or below)25°C Free Air Temperature	P _c	75	mW

Notes: *1: Soldering time \leq 5 seconds.



Electro-Optical Characteristics

Parameter (Ta=25°C)	Symbol	Condition	Min.	Typ.	Max.	Unit
Collector – Emitter Breakdown Voltage	BV_{CEO}	$I_C=100\ \mu A$ $E_e=0mW/cm^2$	30	--	--	V
Emitter-Collector Breakdown Voltage	BV_{ECO}	$I_E=100\ \mu A$ $E_e=0mW/cm^2$	5	--	--	V
Collector-Emitter Saturation Voltage	$V_{CE}(sat)$	$I_C=2mA$ $E_e=1mW/cm^2$	--	--	0.4	V
Rise Time	t_r	$V_{CE}=5V$	--	15	--	μS
Fall Time	t_f	$I_C=1mA$ $R_L=1000\Omega$	--	15	--	
Collector Dark Current	I_{CEO}	$E_e=0mW/cm^2$ $V_{CE}=20V$	--	--	100	nA
On State Collector Current	$I_C(on)$	$E_e=1mW/cm^2$ $V_{CE}=5V$	1.77	3.15	5.07	mA
Wavelength of Peak Sensitivity	λ_p	--	--	940	--	nm
Rang of Spectral Bandwidth	$\lambda_{0.5}$	--	400	--	1100	nm

Note:

Tolerance of Luminous Intensity: $\pm 10\%$

Tolerance of Dominant Wavelength: $\pm 1nm$

Tolerance of Forward Voltage: $\pm 0.1V$



Rank

Parameter	Symbol	Condition	Min.	Max.	Unit
J	$I_{C(ON)}$	VCE=5V Ee=1mW/c m ²	1.77	3.61	mA
K	$I_{C(ON)}$	VCE=5V Ee=1mW/c m ²	2.67	5.07	mA

CHAU LIGHT



Typical Electro-Optical Characteristics Curves

Fig.1 Collector Power Dissipation vs. Ambient Temperature

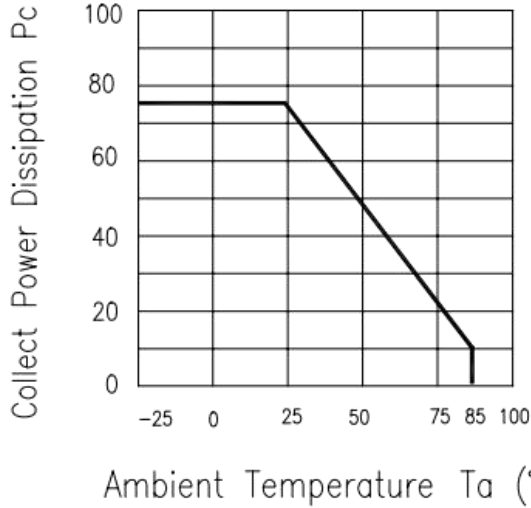

Fig.2 Collector Dark Current vs. Ambient Temperature

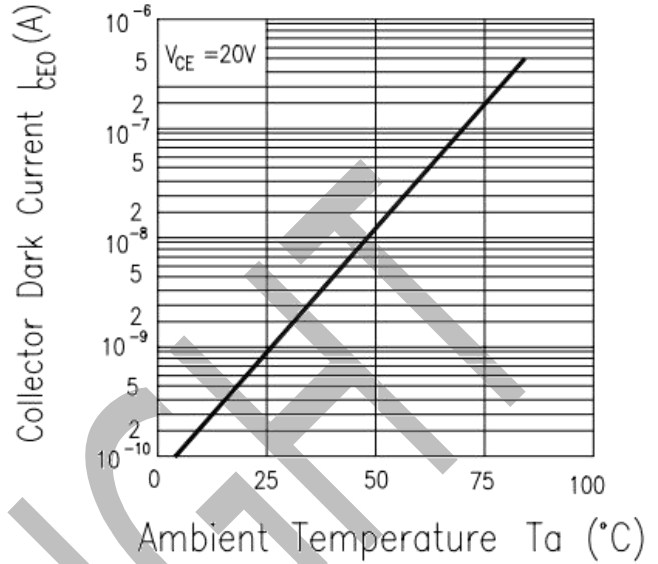

Fig. 3 Relative Collector Current vs. Ambient Temperature

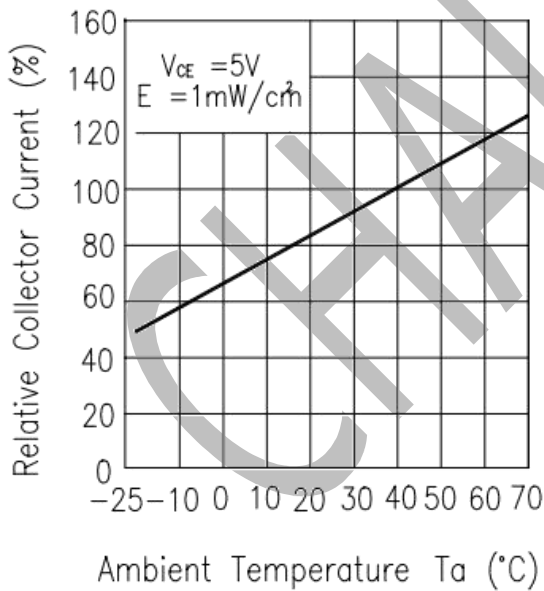

Fig.4 Collector Current vs. Irradiance

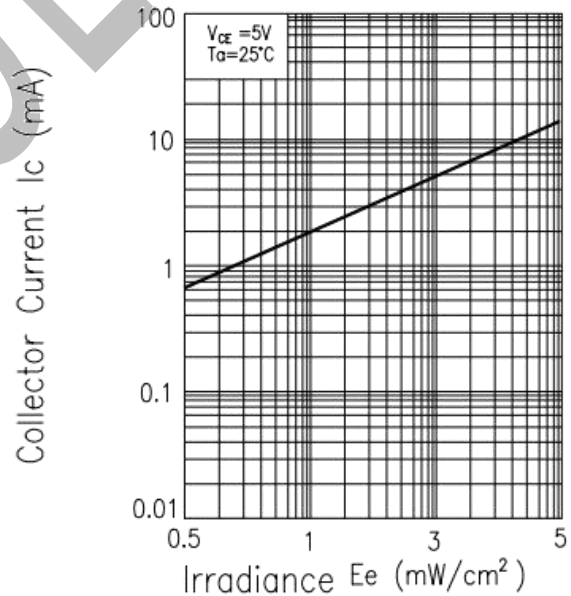



Fig.5 Spectral Sensitivity

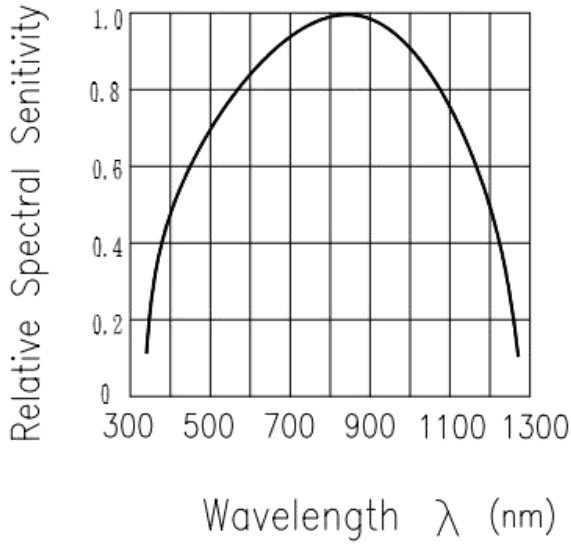
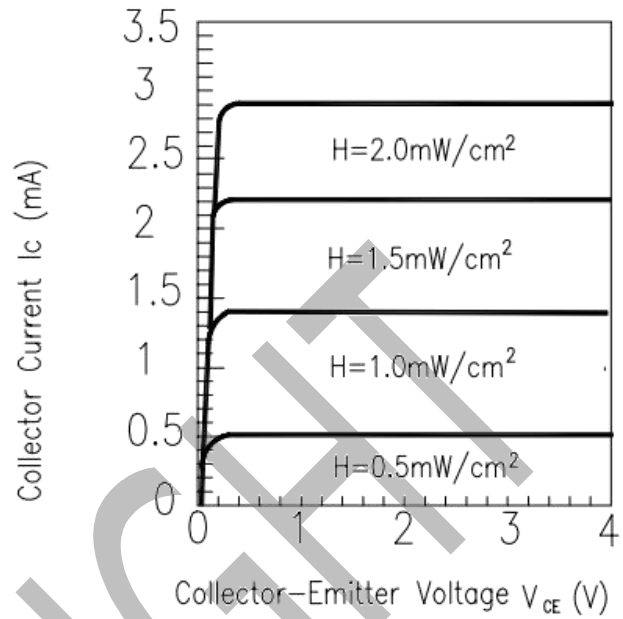

Fig.6 Collector Current vs. Collector-Emitter Voltage





Packing Quantity Specification

- 1.1000PCS/1bag, 4bags/1 Box
2. 10BOXES/1 Carton

Notes

1. Above specification may be changed without notice. CHAU LIGHT will reserve authority on material change for above specification.
2. When using this product, please observe the absolute maximum ratings and the instruction for using outlined in these specification sheets. CHAU LIGHT assumes no responsibility for any damage resulting from use of the product which does not comply with the absolute maximum ratings and the instructions included in these specification sheets.
3. These specification sheets include materials protected under copyright of CHAU LIGHT corporation. Please don't reproduce or cause anyone to reproduce them without CHAU LIGHT 's consent.

CHAU LIGHT

X-ON Electronics

Largest Supplier of Electrical and Electronic Components

Click to view similar products for [Infrared Receivers](#) category:

Click to view products by [Chau Light](#) manufacturer:

Other Similar products are found below :

[TSOP38436](#) [TSOP6136TR](#) [TSOP2456](#) [TSOP31456](#) [TSOP34356](#) [TSOP34456](#) [TSOP38336](#) [TSOP6130TT](#) [TSOP6940TT](#) [TSOP34438SS1V](#)
[GP1UX511QS](#) [TSOP34336SS1F](#) [TSSP57038ETT1](#) [TSOP57438ETT1](#) [TSOP37438HTT1](#) [TSOP6140TR](#) [TSOP53356](#) [TSOP53238](#)
[TSOP33238](#) [TSOP33256](#) [TSOP53256](#) [TSOP33138](#) [TSOP6133TT](#) [HL-PST-1608PT1F](#) [PT2424-6B](#) [TSOP37540QHTT1](#)
[E6C0805PRAC1UDA](#) [TSOP31136](#) [TSOP31140](#) [TSOP75238WTT](#) [RPM5537-H14E2A](#) [RPM6937-V4](#) [RPM7136-H4R](#) [RPM7238-H5R](#)
[TSOP4156](#) [TSOP6156TR](#) [TSOP75336WTT](#) [TSOP75338TR](#) [TSSP77038TT](#) [PD70-01C/TR7](#) [TSSP57P38TT1](#) [GP1UE292QKVF](#)
[GP1UM281XKVF](#) [GP1UM287RKVF](#) [GP1UM287XK](#) [TSOP59438](#) [TSOP58336](#) [TSOP38156](#) [PT19-21B/L41/TR8](#) [TSOP37236HTT1](#)