



2024

ALUMINUM ELECTROLYTIC CAPACITORS

CAT.NO.E1001Y



Aluminum Electrolytic Capacitors

Product Guide

- Group Chart
- Series Table
- Part Numbering System
- Environmental Consideration
- Taping Specifications
- Cut / Formed Lead Type
- Minimum Order Quantity
- Available Terminals For Snap-in And Screw-Mount Type
- Standardization
- World-Wide Manufacturing Locations

Conductive Polymer Aluminum Solid Capacitors

- Precautions and Guidelines
- Recommended Soldering Conditions
- Lifetime Estimation
- Part Numbering System
- Product List
- Chip Type
- Radial Lead Type

Conductive Polymer Hybrid Aluminum Electrolytic Capacitors

- Precautions and Guidelines
- Recommended Soldering Conditions
- Lifetime Estimation
- Part Numbering System
- Chip Type
- Radial Lead Type

Aluminum Electrolytic Capacitors

- Precautions and Guidelines
- Recommended Soldering Conditions
- Chip Type
- Radial Lead Type
- Snap-in Type
- Screw Terminal Type
- For Audio

Technical Note

Appendix

CHEMI-CON GROUP CHART

☆: Recommendation products
AEC-Q200: AEC-Q200 compliant. Please contact your local Chemi-Con office for more details, test data, information and also non indicated products.

CONDUCTIVE POLYMER ALUMINUM SOLID CAPACITORS

Digitalization
Super Low ESR

SURFACE MOUNT TYPE

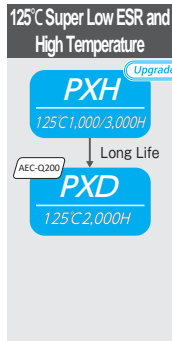
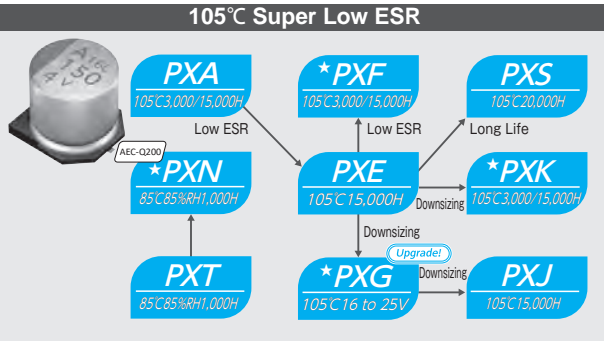

RADIAL LEAD TYPE

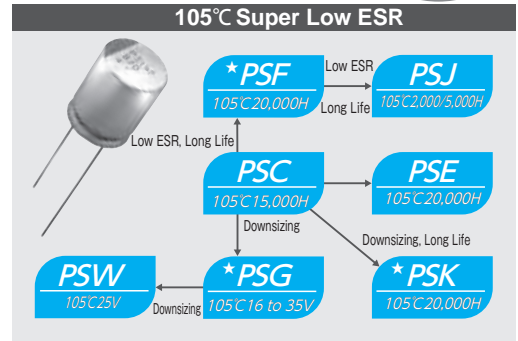

CONDUCTIVE POLYMER HYBRID ALUMINUM ELECTROLYTIC CAPACITORS

Digitalization
Super Low ESR
Automotive
Application

SURFACE MOUNT TYPE

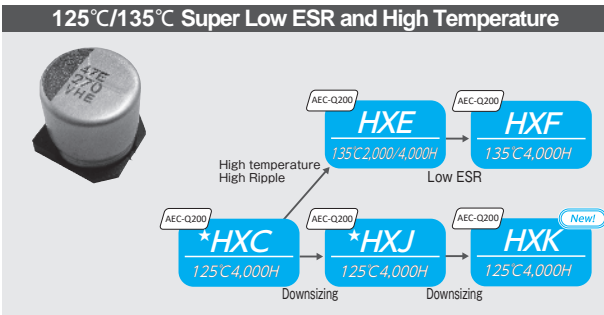

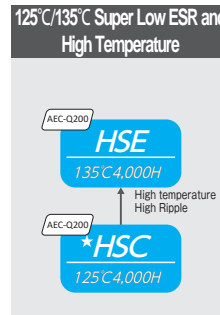

RADIAL LEAD TYPE

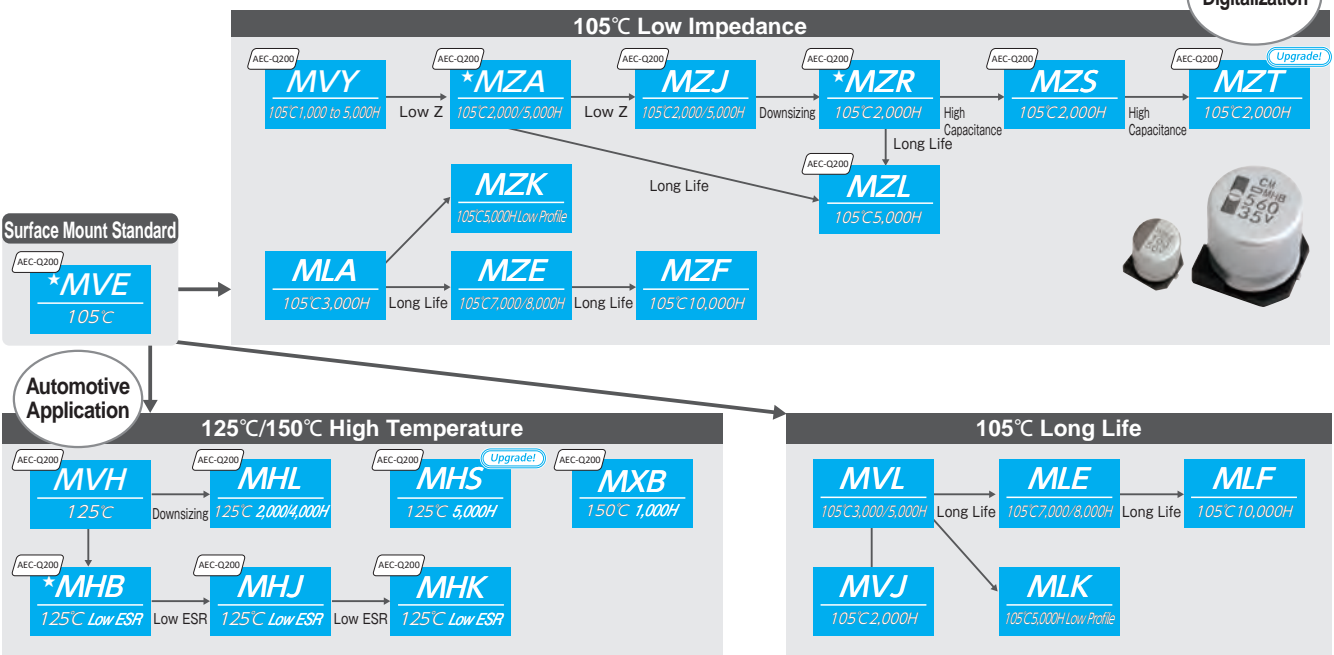

ALUMINUM ELECTROLYTIC CAPACITORS

SURFACE MOUNT TYPE



 : AEC-Q200 compliant. Please contact your local Chemi-Con office for more details, test data, information and also non indicated products. ☆: Recommendation products

ALUMINUM ELECTROLYTIC CAPACITORS

RADIAL LEAD TYPE

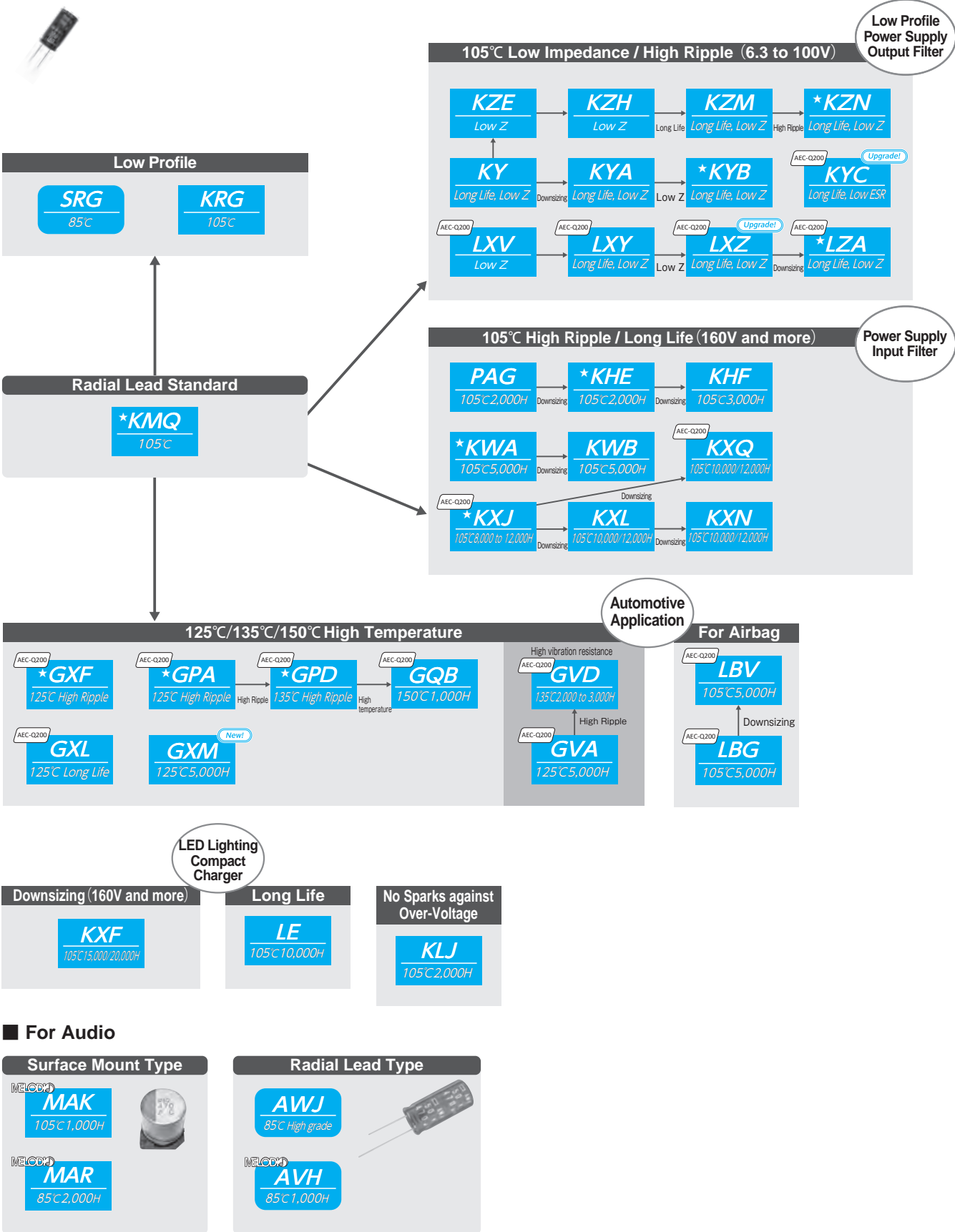

Product specifications in this catalog are subject to change without notice. Request our product specifications before purchase and/or use. Please use our products based on the information contained in this catalog and product specifications.



GROUP CHART

☆: Recommendation products
AEC-Q200 : AEC-Q200 compliant. Please contact your local Chemi-Con office for more details, test data, information and also non indicated products.

ALUMINUM ELECTROLYTIC CAPACITORS

SNAP-IN TYPE

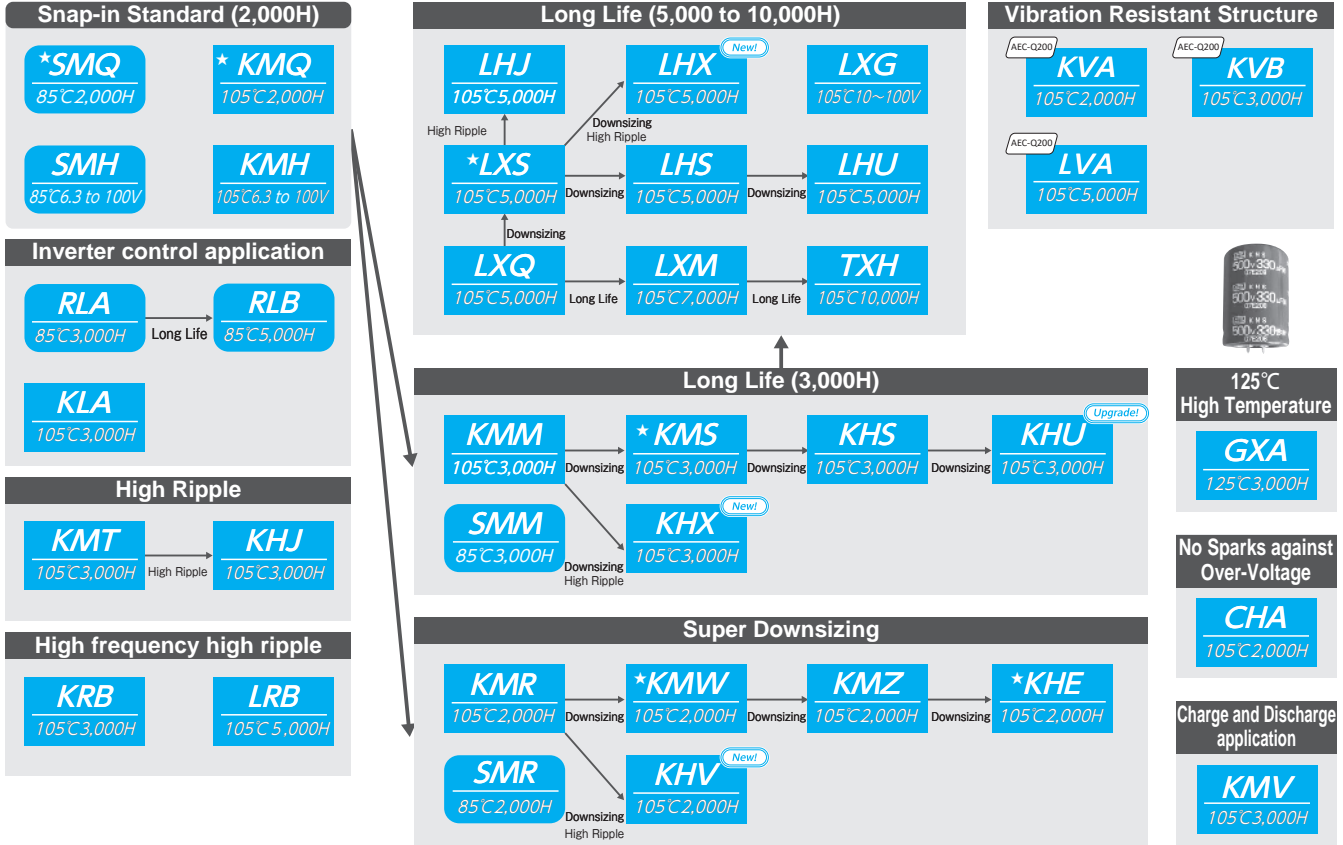

SCREW-MOUNT TYPE

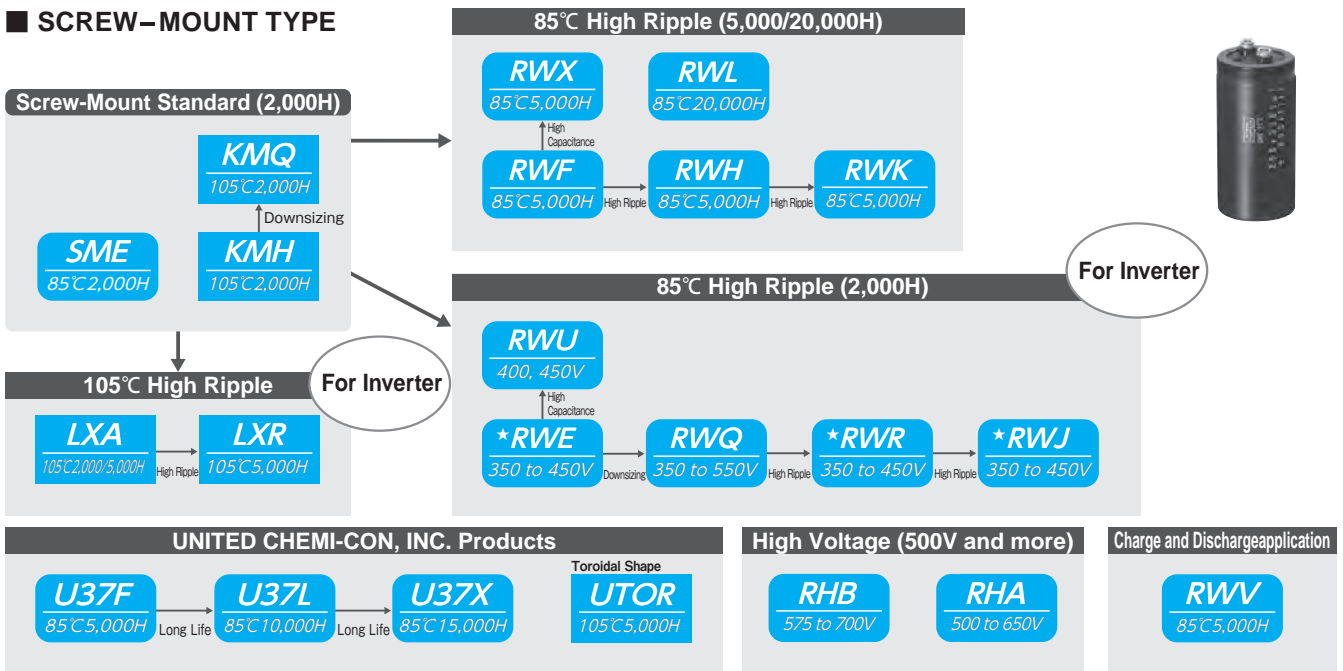

Product specifications in this catalog are subject to change without notice. Request our product specifications before purchase and/or use. Please use our products based on the information contained in this catalog and product specifications.



CAPACITOR SERIES TABLE, CONTENTS

CONDUCTIVE POLYMER ALUMINUM SOLID CAPACITORS

Series		Features	Standard Type	Miniaturization Low profile type	Low Z	Long life	High temperature	AEC-Q200	Terminal type	Endurance (+R=With ripple)	Rated voltage range (Vdc)
Surface Mount Type	PXN	Super low ESR, high ripple current, high moisture resistance		●	●	●		●	SMD	105°C 5,000 hours	2.5 to 16
	PXT	Super low ESR, high ripple current, high moisture resistance		●	●	●			SMD	105°C 15,000 hours	2.5 to 16
	PXJ	Super low ESR, high ripple current, downsizing		●	●	●			SMD	105°C 15,000 hours	2.5 to 25
	PXG (Upgrade!)	Super low ESR, high ripple current, downsizing	●	●	●	●			SMD	105°C 3,000 to 15,000 hours	16 to 25
	PXK	Super low ESR, high ripple current, downsizing	●	●	●	●			SMD	105°C 3,000 to 15,000 hours	2.5 to 16
	PXS	Super low ESR, high ripple current		●	●	●			SMD	105°C 20,000 hours	4 to 16
	PXF	Super low ESR, high ripple current	●	●	●	●			SMD	105°C 3,000 to 15,000 hours	2 to 10
	PXE	Super low ESR, high ripple current		●	●	●			SMD	105°C 15,000 hours	2.5 to 16
	PXA	Super low ESR, high ripple current		●	●	●			SMD	105°C 3,000 to 15,000 hours	2.5 to 25
	PXD	125°C, super low ESR, high ripple current		●	●	●	●	●	SMD	125°C 2,000 hours	2.5 to 10
PXH (Upgrade!)	125°C, super low ESR, high ripple current		●	●	●	●	●	SMD	125°C 1,000 to 3,000 hours	2.5 to 20	
Radial Lead Type	PSW	Super low ESR, high ripple current, downsizing		●	●				Radial	105°C 5,000 hours	25
	PSJ	Super low ESR, high ripple current, downsizing		●	●				Radial	105°C 2,000 to 5,000 hours	2.5
	PSG	Super low ESR, high ripple current	●	●	●	●			Radial	105°C 15,000 to 20,000 hours	16 to 35
	PSK	Super low ESR, high ripple current	●	●	●	●			Radial	105°C 20,000 hours	2.5 to 6.3
	PSF	Super low ESR, high ripple current	●	●	●	●			Radial	105°C 20,000 hours	2 to 16
	PSE	Super low ESR, high ripple current		●	●	●			Radial	105°C 20,000 hours	2.5 to 6.3
	PSC	Super low ESR, high ripple current		●	●	●			Radial	105°C 15,000 hours	2.5 to 16

CONDUCTIVE POLYMER HYBRID ALUMINUM ELECTROLYTIC CAPACITORS

Series		Features	Standard Type	Miniaturization Low profile type	Low Z	Long life	High temperature	AEC-Q200	Terminal type	Endurance (+R=With ripple)	Rated voltage range (Vdc)
Surface Mount Type	HXF	135°C, super low ESR, high ripple current			●	●	●	●	SMD	135°C 4,000 hours +R	25 to 63
	HXE	135°C, super low ESR, high ripple current			●	●	●	●	SMD	135°C 2,000 to 4,000 hours +R	16 to 63
	HXK (New)	125°C, super low ESR, high ripple current			●	●	●	●	SMD	125°C 4,000 hours +R	16 to 35
	HXJ	125°C, super low ESR, high ripple current			●	●	●	●	SMD	125°C 4,000 hours +R	16 to 63
	HXC	125°C, super low ESR, high ripple current	●		●	●	●	●	SMD	125°C 4,000 hours +R	16 to 80
	HXD	105°C, super low ESR, standard	●		●			●	SMD	105°C 5,000 to 10,000 hours +R	16 to 80
Radial Lead Type	HSE	135°C, super low ESR, high ripple current			●	●	●	●	Radial	135°C 4,000 hours +R	25 to 63
	HSC	125°C, super low ESR, high ripple current	●		●	●	●	●	Radial	125°C 4,000 hours +R	25 to 80
	HSD	105°C, super low ESR, standard	●		●			●	Radial	105°C 10,000 hours +R	25 to 80

ALUMINUM ELECTROLYTIC CAPACITORS

Series		Features	Standard Type	Miniaturization Low profile type	Low Z	Long life	High temperature	AEC-Q200	Terminal type	Endurance (+R=With ripple)	Rated voltage range (Vdc)	
Surface Mount Type	General Purpose	MVE	105°C, standard	●	●			●	SMD	105°C 1,000 to 2,000 hours	6.3 to 100	
	Low Impedance	MZT (Upgrade!)	Super low ESR, downsizing		●	●			●	SMD	105°C 2,000 hours	16 to 35
		MZS	Super low ESR, downsizing		●	●			●	SMD	105°C 2,000 hours	25 & 35
		MZL	5,000 hours, long life, low ESR		●	●	●		●	SMD	105°C 5,000 hours	6.3 to 50
		MZR	Super low ESR, downsizing	●	●	●			●	SMD	105°C 2,000 hours	6.3 to 50
		MZJ	Super low ESR		●	●			●	SMD	105°C 2,000 to 5,000 hours	6.3 to 50
		MZA	Super low impedance, case size 4 to 18mm	●	●	●	●		●	SMD	105°C 2,000 to 5,000 hours	6.3 to 100
		MVY	Low impedance, standard, case size 4 to 18mm			●			●	SMD	105°C 1,000 to 5,000 hours	6.3 to 100
		MZF	10,000 hours, long life, low impedance			●	●			SMD	105°C 10,000 hours	6.3 to 50
		MZE	7,000/8,000 hours, long life, low impedance			●	●			SMD	105°C 7,000 to 8,000 hours	6.3 to 50
		MZK	5,000 hours, long life, low impedance		●	●	●			SMD	105°C 5,000 hours	6.3 to 35
	MLA	3,000 hours, long life, low impedance			●				SMD	105°C 3,000 hours	6.3 to 50	
	Long Life	MLF	10,000 hours, long life				●			SMD	105°C 10,000 hours	6.3 to 50
		MLE	7,000/8,000 hours, long life				●			SMD	105°C 7,000 to 8,000 hours	6.3 to 50
		MLK	5,000 hours, long life		●		●			SMD	105°C 5,000 hours	6.3 to 35
		MVL	3,000/5,000 hours, long life				●			SMD	105°C 3,000 to 5,000 hours	6.3 to 50
		MVJ	2,000 hours, long life				●			SMD	105°C 2,000 hours	6.3 to 50
	Special Application	MHS (Upgrade!)	125°C, high temperature reflow soldering		●	●	●	●	●	SMD	125°C 2,000 to 5,000 hours	16 to 100
		MVH	125°C, case size 6.3 to 18mm		●	●	●	●	●	SMD	125°C 1,000 to 5,000 hours	10 to 100
		MHL	125°C, downsizing			●	●	●	●	SMD	125°C 2,000 to 4,000 hours	10 to 35
MHB		125°C, specified ESR after endurance Case size 8 to 18mm	●		●		●	●	SMD	125°C 1,500 to 3,000 hours	10 to 100	
MHJ		125°C, specified ESR after endurance			●		●	●	SMD	125°C 2,000 to 3,000 hours	10 to 35	
MHK		125°C, specified ESR after endurance			●		●	●	SMD	125°C 2,000 hours	35	
MXB	150°C, case size 12.5 to 18mm			●	●	●	●	SMD	150°C 1,000 hours	25 & 35		

● : Recommendation products

AEC-Q200 : AEC-Q200 compliant. Please contact your local Chemi-Con office for more details, test data, information and also non indicated products.



CAPACITOR SERIES TABLE, CONTENTS

ALUMINUM ELECTROLYTIC CAPACITORS

Series		Features	Standard Type	Miniaturization Low profile type	Low Z	Long life	High temperature	AEC-Q200	Terminal type	Endurance (+R=With ripple)	Rated voltage range (Vdc)	
Radial Lead Type	Low Profile	SRG	φ 10×12.5 to φ 18×25mm, low profile	●					Radial	85°C 2,000 hours	6.3 to 50	
		KRG	φ 10×12.5 to φ 18×25mm, low profile	●					Radial	105°C 1,000 hours	6.3 to 50	
	General Purpose	KMQ	105°C, downsizing	●					Radial	105°C 1,000 to 2,000 hours +R	6.3 to 450	
	Power Supply Output, Low Impedance	KZN	Long life, low impedance	●	●	●				Radial	105°C 6,000 to 10,000 hours +R	6.3 to 100
		KZM	Long life, super low impedance	●	●	●				Radial	105°C 6,000 to 10,000 hours +R	6.3 to 50
		KZH	Super low impedance, downsizing	●	●	●				Radial	105°C 5,000 to 6,000 hours +R	6.3 to 35
		KZE	Low impedance, downsizing	●	●	●				Radial	105°C 2,000 to 5,000 hours +R	6.3 to 100
		KYC <small>(Upgrade!)</small>	Low ESR, downsizing	●	●	●		●		Radial	105°C 3,000 to 5,000 hours +R	16 to 100
		KYB	Low impedance, downsizing	●	●	●				Radial	105°C 4,000 to 10,000 hours +R	6.3 to 100
		KYA	Low impedance, downsizing	●	●	●				Radial	105°C 4,000 to 10,000 hours +R	6.3 to 100
		KY	Low impedance, standard	●		●	●			Radial	105°C 6,000 to 10,000 hours +R	6.3 to 100
		LZA	Low impedance, downsizing	●	●	●		●		Radial	105°C 4,000 to 7,000 hours +R	6.3 to 35
		LXZ <small>(Upgrade!)</small>	Low impedance, downsizing	●	●	●		●	●	Radial	105°C 2,000 to 8,000 hours +R	6.3 to 63
		LXY	Low impedance			●	●		●	Radial	105°C 2,000 to 8,000 hours +R	10 to 63
	LXV	Low impedance			●	●		●	Radial	105°C 2,000 to 5,000 hours +R	6.3 to 100	
	Power Supply Input	KXQ	Long life, downsizing, for input filtering	●		●		●		Radial	105°C 10,000 to 12,000 hours +R	400 to 450
		KXN	Long life, downsizing, for input filtering	●		●				Radial	105°C 10,000 to 12,000 hours +R	350 to 450
		KXL	Long life, downsizing, for input filtering	●		●				Radial	105°C 10,000 to 12,000 hours +R	400 to 450
		KXJ	Long life, downsizing, for input filtering	●	●	●		●		Radial	105°C 8,000 to 12,000 hours +R	160 to 500
		KWB	Low profile, long life for input filtering	●		●				Radial	105°C 5,000 hours +R	400 to 450
		KWA	Low profile, long life for input filtering	●		●				Radial	105°C 5,000 hours +R	400 to 450
		KHF	Low profile, high ripple for input filtering	●						Radial	105°C 3,000 hours +R	400 to 450
		KHE	Low profile, high ripple for input filtering	●						Radial	105°C 2,000 hours +R	400 to 450
		PAG	Low profile, for input filtering	●						Radial	105°C 2,000 hours +R	200 to 450
		KLJ	No sparks with DC overvoltage, for input filtering	●						Radial	105°C 2,000 hours +R	200 to 450
	KXF	Long life, downsizing, for input filtering	●		●				Radial	105°C 15,000/20,000 hours +R	160 to 450	
	Power Supply Output	LE	Long life, downsizing	●		●				Radial	105°C 10,000 hours +R	10 to 100
	High Temperature	GPA	125/150°C, downsizing (Guaranteed short time at 150°C)	●	●	●	●	●	●	Radial	125°C 3,000 to 5,000 hours +R	25 to 100
		GVA	125°C, high vibration resistance	●	●	●	●	●	●	Radial	125°C 5,000 hours +R	25 to 100
		GXM <small>(New!)</small>	125°C, high ripple	●		●	●			Radial	125°C 5,000 hours +R	400 to 450
GXF		125°C, high ripple	●	●		●	●		Radial	125°C 3,000 hours +R	25 to 400	
GXL		125°C			●	●	●	●	Radial	125°C 5,000 hours +R	10 to 50	
GPD		135/150°C, high ripple (Guaranteed short time at 150°C)	●	●	●	●	●	●	Radial	135°C 2,000 to 3,000 hours +R	25 to 100	
GVD		135°C, high vibration resistance	●	●	●	●	●	●	Radial	135°C 2,000 to 3,000 hours +R	25 to 100	
GQB	150°C, high ripple			●	●	●	●	Radial	150°C 1,000 hours +R	25 & 35		
Special Application	LBV	For airbag, downsizing	●	●	●		●		Radial	105°C 5,000 hours +R	25 & 35	
	LBG	For airbag	●	●	●		●		Radial	105°C 5,000 hours +R	25 & 35	

 : Recommendation products

AEC-Q200 : AEC-Q200 compliant. Please contact your local Chemi-Con office for more details, test data, information and also non indicated products.



CAPACITOR SERIES TABLE, CONTENTS

ALUMINUM ELECTROLYTIC CAPACITORS

Series		Features	Standard Type	Miniaturization Low profile type	High ripple	Long life	AEC-Q200	Terminal type	Endurance (+R=With ripple)	Rated voltage range (V _{dc})	
Snap-in Type	General Purpose	SMR	85°C, high ripple, downsizing	●	●			Pin	85°C 2,000 hours +R	400 to 450	
		SMQ	85°C, standard	●	●			Pin	85°C 2,000 hours +R	160 to 450	
		KHV (New)	105°C, high ripple, downsizing		●	●			Pin	105°C 2,000 hours +R	350 to 400
		KHE	105°C, super downsizing		●				Pin	105°C 2,000 hours +R	400 to 450
		KMZ	105°C, super downsizing		●				Pin	105°C 2,000 hours +R	420 & 450
		KMW	105°C, super downsizing		●				Pin	105°C 2,000 hours +R	400 to 450
		KMR	105°C, downsizing		●	●			Pin	105°C 2,000 hours +R	160 to 450
		KMQ	105°C, standard	●	●				Pin	105°C 2,000 hours +R	35, 50, 160 to 450
		RLB	85°C, 5,000 hours, high ripple		●	●			Pin	85°C 5,000 hours +R	180 to 250
		RLA	85°C, high ripple		●	●			Pin	85°C 3,000 hours +R	180 to 250
		KLA	105°C, high ripple		●	●			Pin	105°C 3,000 hours +R	180 to 250
		SMM	85°C, 3,000 hours	●	●				Pin	85°C 3,000 hours +R	160 to 450
		KRB	High frequency high ripple		●	●			Pin	105°C 3,000 hours +R	400 to 450
		KHJ	105°C, high ripple		●	●			Pin	105°C 3,000 hours +R	400 to 450
		KMT	105°C, high ripple		●	●			Pin	105°C 3,000 hours +R	420 & 450
		KHX (New)	105°C, high ripple, downsizing		●	●			Pin	105°C 3,000 hours +R	350 to 400
		KHU (Upgrade)	Long life, downsizing		●	●			Pin	105°C 3,000 hours +R	400 to 500
		KHS	105°C, downsizing		●	●			Pin	105°C 3,000 hours +R	450 to 500
		KMS	105°C, downsizing	●	●	●			Pin	105°C 3,000 hours +R	160 to 600
		KMM	105°C, 3,000 hours		●	●			Pin	105°C 3,000 hours +R	160 to 450
	SMH	85°C, standard				●		Pin	85°C 2,000 hours +R	6.3 to 100	
	KMH	105°C, standard						Pin	105°C 2,000 hours +R	6.3 to 100	
	High Temperature	TXH	Long life				●		Pin	105°C 10,000 hours +R	200 to 450
		LXM	Long life, downsizing		●		●		Pin	105°C 7,000 hours +R	160 to 450
		LRB	High frequency high ripple, long life		●	●	●		Pin	105°C 5,000 hours +R	400 to 450
		LHX (New)	105°C, high ripple, downsizing		●	●	●		Pin	105°C 5,000 hours +R	350 to 400
		LHJ	Long life, high ripple		●	●	●		Pin	105°C 5,000 hours +R	400 to 450
		LHU (Upgrade)	High ripple, long life, downsizing		●	●	●		Pin	105°C 5,000 hours +R	400 to 500
		LHS	Long life, downsizing		●	●	●		Pin	105°C 5,000 hours +R	450 to 500
		LXS	Long life, downsizing	●	●	●			Pin	105°C 5,000 hours +R	160 to 600
	Vibration resistance	LXQ	Long life, downsizing		●		●		Pin	105°C 5,000 hours +R	160 to 450
		LXG	Long life				●		Pin	105°C 5,000 hours +R	10 to 100
		LVA	Long life, vibration resistance		●		●	●	Pin	105°C 5,000 hours +R	450
	Special Application	KVB	Vibration resistance		●			●	Pin	105°C 3,000 hours +R	450
		KVA	Vibration resistance		●			●	Pin	105°C 2,000 hours +R	450
GXA		125°C, high temperature					●	Pin	125°C 3,000 hours +R	400 & 450	
General Purpose	CHA	No sparks with DC overvoltage			●			Pin	105°C 2,000 hours +R	200 to 450	
	KMV	For charge and discharge application						Pin	105°C 3,000 hours +R	350 to 450	
	SME	85°C, standard	●					Screw	85°C 2,000 hours +R	10 to 100	
Screw-Mount Type	General Purpose	KMQ	105°C, downsizing		●			Screw	105°C 2,000 hours +R	315 to 450	
		KMH	105°C, standard	●				Screw	105°C 2,000 hours +R	10 to 400	
		RWX	High capacitance		●		●		Screw	85°C 5,000 hours +R	400 & 450
	For Inverter	RWK	High ripple, long life, downsizing		●	●	●		Screw	85°C 5,000 hours +R	350 to 450
		RWH	High ripple, downsizing		●	●	●		Screw	85°C 5,000 hours +R	350 to 450
		RWF	Long life, high ripple		●	●	●		Screw	85°C 5,000 hours +R	350 to 450
		RWU	High capacitance		●				Screw	85°C 2,000 hours +R	400 & 450
		RWJ	High ripple, downsizing		●	●			Screw	85°C 2,000 hours +R	350 to 450
		RWR	High ripple, downsizing		●	●			Screw	85°C 2,000 hours +R	350 to 450
		RWQ	High ripple, downsizing	●	●	●			Screw	85°C 2,000 hours +R	350 to 550
		RWE	High ripple	●	●	●			Screw	85°C 2,000 hours +R	350 to 450
		RWL	Long life, high ripple				●	●	Screw	85°C 20,000 hours +R	350 to 450
		RHB	85°C, high voltage						Screw	85°C 2,000 hours +R	575 to 700
		RHA	High voltage, high ripple		●	●	●		Screw	85°C 5,000 hours +R	500 to 650
		LXA	105°C, long life		●	●			Screw	105°C 2,000/5,000 hours +R	10 to 525
		LXR	105°C, long life, high ripple				●	●	Screw	105°C 5,000 hours +R	350 to 450
		RWV	For charge and discharge application						Screw	85°C 5,000 hours +R	350 to 450

ALUMINUM ELECTROLYTIC CAPACITORS (UNITED CHEMI-CON, INC. Products)

Series		Features	Standard Type	Miniaturization Low profile type	High ripple	Long life	Terminal type	Endurance (+R=With ripple)	Rated voltage range (V _{dc})
Screw-Mount Type	For Inverter	U37F	Long life, high ripple		●	●	Screw	85°C 5,000 hours +R	350 to 500
		U37L	Long life, high ripple		●	●	Screw	85°C 10,000 hours +R	350 to 500
		U37X	Long life, high ripple		●	●	Screw	85°C 15,000 hours +R	350 to 500
		UTOR	Toroidal shape, long life, high ripple		●	●	Screw	105°C 5,000 hours +R	350 to 500

ALUMINUM ELECTROLYTIC CAPACITORS FOR AUDIO

Series		Features	Standard Type	Miniaturization Low profile type	Terminal type	Endurance (+R=With ripple)	Rated voltage range (V _{dc})
For Audio	MAR <i>MELODIO</i>	Surface mount type	●	●	SMD	85°C 2,000 hours	6.3 to 50
	MAK <i>MELODIO</i>	105°C, surface mount type			SMD	105°C 1,000 hours	6.3 to 50
	AVH <i>MELODIO</i>	Standard			Radial	85°C 1,000 hours	6.3 to 100
	AWJ	High grade			Radial	85°C 1,000 hours	16 to 100

● : Recommendation products

AEC-Q200 : AEC-Q200 compliant. Please contact your local Chemi-Con office for more details, test data, information and also non indicated products.



PART NUMBERING SYSTEM

Part numbering system

Our part numbering system is common to all of Nippon Chemi-Con's subsidiaries worldwide, and has been switching the conventional part numbering system. The part number uses 18-digit codes to express information of principal product specifications such as product category, series name, rated voltage, capacitance, case size and RoHS compliance.

●Categories

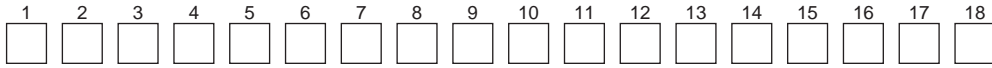

Code	Details
A	Conductive Polymer Aluminum Solid Capacitors (Polar)
H	Conductive Polymer Hybrid Aluminum Electrolytic Capacitors (Polar)
E	Aluminum Electrolytic Capacitors (Polar)
K	Multilayer Ceramic Capacitors
F	Film Capacitors
D	Electric Double Layer Capacitors
T	Metal Oxide Varistors
L	Amorphous Choke Coils

* For digits 2 to 18, please see "Product code guide".

●Example

Product type	Part number (Example)	Conventional part number (Ref.)
Surface mount type	EMVE160ADA100MD55G	MVE16VC10MD55E0
Radial lead type	EKMQ6R3ETC102MHB5D	TC04RKM6.3VB1000MF50E0
Snap-in type	EKMQ201VSN471MP30S	KMQ200VSSN470M22BE0
Screw mount terminal type	ERWE551LGC821MCD0U	RWE550LGSN820MCC13EA

Environment friendly capacitors

Nippon Chemi-Con has been taking proactive approaches toward developing and marketing less environmentally-load products in response to the international efforts for reducing hazardous substances and to the regulations. Nippon Chemi-Con had already abolished 4 additional substances, which will be prohibited from July 2019 in accordance with revised RoHS directive (2011/65/EU), by innovating alternative materials of the outer tube.

RoHS2 Compliant : Compliant to the 2011/65/EU and the revisions (2015/863/EU)

ELV Compliant : Compliant to the 2000/53/EC and the revisions (2016/774/EU)

Please contact us for more information about "Halogen-free specification".

◆Pb-free and Non-PVC Products

1. Lead wire (Plating)

Category		Plating material on lead wires
Conductive Polymer Aluminum Solid Capacitors	Chip	Sn-Bi
	Radial	Sn
Conductive Polymer Hybrid Aluminum Electrolytic Capacitors	Chip	Sn-Bi
	Radial	Sn
Aluminum Electrolytic Capacitors	Chip	case code : D55 to JA0
		case code : KE0 to MN0
	Radial	case dia : to ϕ 8
		case dia : ϕ 10 to
	Snap-in	Sn
	Screw-Mount	Originally lead-free

*Please consult with us when you need "Pb-free parts" other than the above mentioned terminal plating materials.

(Note) **Sn** : Tin, **Bi** : Bismuth

2. Sleeve

Category		Sleeve material
Conductive Polymer Aluminum Solid Capacitors	Chip	Sleeveless (Coating case)
	Radial	Sleeveless (Coating case)
Conductive Polymer Hybrid Aluminum Electrolytic Capacitors	Chip	Sleeveless (Coating case)
	Radial	Sleeveless (Coating case)
Aluminum Electrolytic Capacitors	Chip	Sleeveless (Coating case)
	Radial	PET
	Snap-in	PET
	Screw-Mount	PVC

*Please consult with us when you need "Non-PVC parts" other than the above mentioned outer sleeve materials.

The colors of a PET sleeve are "Black", "Brown", and "Dark blue".

Standard designs of "Pb-free" Snap-in type are not equipped with a plastic disc.

Please consult with us when you need nonflammable grade for outer sleeve material.

Identification of friendly parts is given by a supplement code (18th digit) of the part number.

For details, please refer to "Product code guide" for each type.

TAPING SPECIFICATIONS (Applicable standard JIS C 0806-3)
SURFACE MOUNT TYPE (TAPING)



◆CARRIER TAPE [mm]

Fig.1

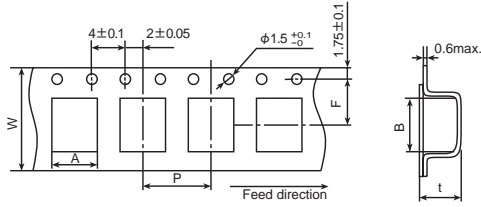

Fig.3

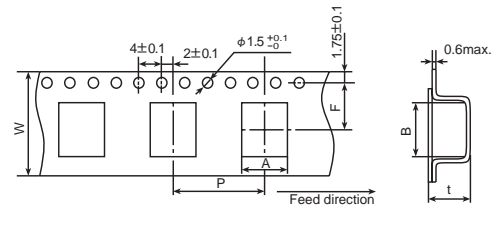

Fig.2

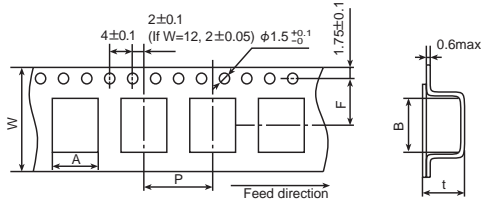
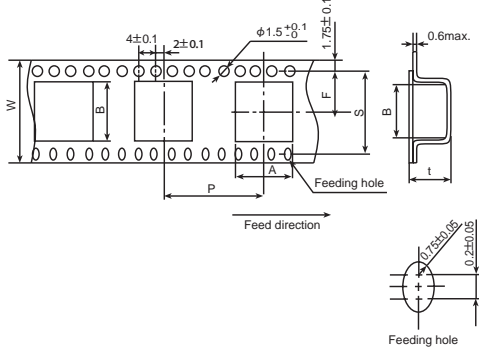

Fig.4



[mm]

Series	Items	W	A	B	F	P	t	S	Fig.		
		±0.3	±0.2	±0.2	±0.1	±0.1	±0.2	±0.1			
Alchip™	D55	12.0	4.7	4.7	5.5	8.0	5.7	—	1		
	D60,D61	12.0	4.7	4.7	5.5	8.0	6.3	—	1		
	D73	12.0	4.6	4.6	5.5	8.0	7.5	—	1		
	E40	12.0	5.7	5.7	5.5	12.0	4.4	—	2		
	E46	12.0	5.7	5.7	5.5	12.0	4.9	—	2		
	E55	12.0	5.7	5.7	5.5	12.0	5.7	—	2		
	E60,E61	12.0	5.7	5.7	5.5	12.0	6.3	—	2		
	E73	16.0	5.7	5.7	7.5	12.0	7.5	—	2		
	F46	16.0	7.0	7.0	7.5	12.0	4.9	—	2		
	F55	16.0	7.0	7.0	7.5	12.0	5.7	—	2		
	F60,F61	16.0	7.0	7.0	7.5	12.0	6.3	—	2		
	MLF/MLE	F73	16.0	7.0	7.0	7.5	12.0	7.5	—	2	
	MLK/MVL	F80	16.0	7.0	7.0	7.5	12.0	8.2	—	2	
	MVJ/MXB	F90	16.0	7.0	7.0	7.5	12.0	9.2	—	2	
	MHS/MVH	FA0	16.0	7.0	7.0	7.5	12.0	10.3	—	2	
	MHL/MHB	H63	16.0	8.7	8.7	7.5	12.0	6.8	—	2	
	MHJ/MHK	H70	24.0	8.7	8.7	11.5	12.0	7.3	—	2	
	NPCAP™	H80	24.0	8.7	8.7	11.5	12.0	8.3	—	2	
		PXN/PXT	HA0	24.0	8.7	8.7	11.5	16.0	11.0	—	3
PXJ/PXG		HC0	24.0	8.7	8.7	11.5	16.0	12.7	—	3	
PXK/PXS		J80	24.0	10.7	10.7	11.5	16.0	8.3	—	3	
PXF/PXE		JA0	24.0	10.7	10.7	11.5	16.0	11.0	—	3	
PXA/PXD		JC0	24.0	10.7	10.7	11.5	16.0	12.8	—	3	
PXH		JC5	24.0	10.7	10.7	11.5	16.0	12.8	—	3	
Hybrid		HXF/HXE	JH0	32.0	10.7	10.7	14.2	24.0	17.1	28.4	4
		HXK/HXJ	KE0	32.0	13.4	13.4	14.2	24.0	14.0	28.4	4
		HXC/HXD	KG5	32.0	13.4	13.4	14.2	24.0	16.5	28.4	4
		KN0	32.0	13.4	13.4	14.2	24.0	22.1	28.4	4	
		LH0	44.0	17.5	17.5	20.2	28.0	16.8	40.4	4	
		LN0	44.0	17.5	17.5	20.2	28.0	22.1	40.4	4	
		MH0	44.0	19.5	19.5	20.2	32.0	17.1	40.4	4	
	MN0	44.0	19.5	19.5	20.2	32.0	22.1	40.4	4		

◆ REEL DIMENSIONS [mm]

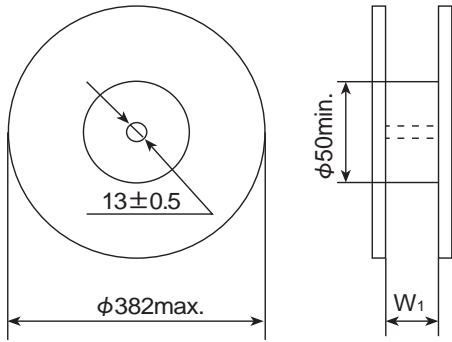

◆ QUANTITY PER REEL/BOX

Series	Size code	Quantity (pcs/reel)	Quantity (pcs/box)	W ₁ (mm)
Alchip™	D55,D60,D61	2,000	10,000	14
	D73	1,500	7,500	14
	MVE/MZT	1,000	5,000	14
	MZS/MZL	1,000	5,000	18
	MZR/MZJ	1,000	5,000	18
	MZA/MVY	1,000	5,000	18
	MZF/MZE	900	4,500	18
	MZK/MLA	800	4,000	18
	MLF/MLE	1,000	5,000	18
	MLK/MVL	500	1,500	26
	MVJ/MXB	500	1,500	26
	MHS/MVH	400	1,200	26
	MHL/MHB	200	600	34
	MHJ/MHK	250 ^{*1}	750 ^{*1}	34
	KE0	200 ^{*1}	600 ^{*1}	34
	Hybrid	KN0	150	450
HXF/HXE		175 ^{*1}	350 ^{*1}	46
HXK/HXJ		125 ^{*1}	250 ^{*1}	46
MHO		150 ^{*1}	300 ^{*1}	46
MNO		100 ^{*1}	200 ^{*1}	46
NPCAP™		E40,E46,E61	1,000	10,000
	F46,F61	1,000	7,000	18
	F80	900	6,300	18
	FA0	750	5,250	18
	H70	1,000	6,000	26
	H80	900	5,400	26
	HA0	500	3,000	26
	HCO	400	1,200	26
	J80	500	3,000	26
	JA0	500	3,000	26
	JCO	400	1,200	26

◆ POLARITY

- Alchip™ -MVE/MZT/MZS
MZL/MZR/MZJ
MZA/MVY/MZF
MZE/MZK/MLA
MLF/MLE/MLK
MVL/MVJ/MXB
MHS/MVH/MHL
MHB/MHJ/MHK
- NP CAP™ -PXN/PXT/PXJ/PXG
PXK/PXS/PXF/PXE
PXA/PXD/PXH
- Hybrid -HXF/HXE/HXK
HXJ/HXC/HXD

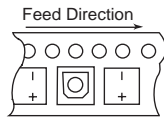

*1 : Changed the packing quantity. (Size Code : KE0 to MNO)

SURFACE MOUNT TYPE (TRAY)

◆ DIMENSIONS [mm]

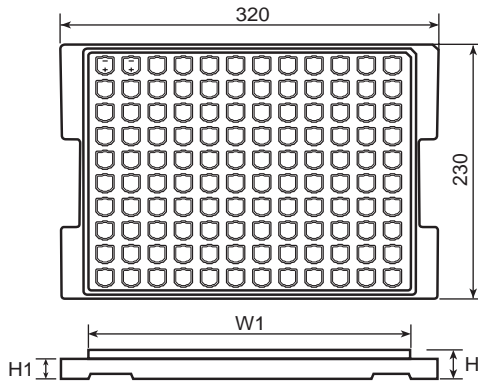

● TRAY CODE : TR

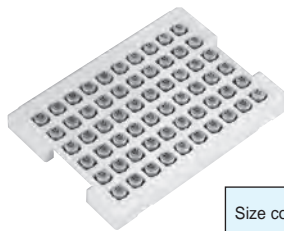

Size code	H [mm]	W ₁ [mm]	H ₁ [mm]	Quantity [pcs/tray]	Quantity [pcs/box]
KE0 & KG5	21.0	284	18.5	120	600
LH0 & LN0	28.0	284	24.0	80	400
MHO & MNO	28.0	284	24.0	60	300

VIBRATION RESISTANT STRUCTURE (Terminal code : G)

◆ DIMENSIONS [mm]

- Terminal code : G
- Size code : F61 to JH0

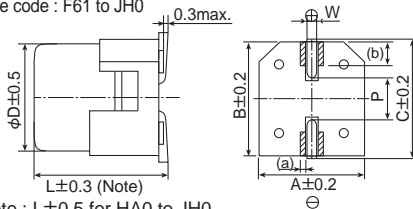

Note : L±0.5 for HA0 to JH0

⊗ : Dummy terminals

- Size code : KE0 to MNO

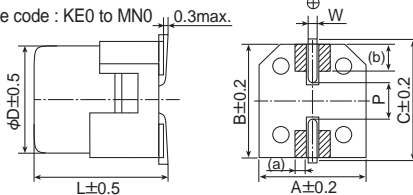

⊗ : Dummy terminals

◆ RECOMMENDED SOLDER LAND

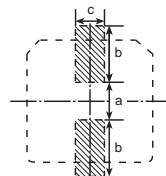

⊗ Solder land on PC board

The vibration resistant model supports the vibration condition of 30G. Since vibration is affected by solder thickness and other characteristics and conditions, please contact us for details.

Size code	Dimensions of products (mm)								Solder land (mm)			
	D	L	A	B	C	W	P	(a)	(b)	a	b	c
F61	6.3	5.8	6.6	6.6	7.2	0.5 to 0.8	1.9	(0.7)	(1.4)	1.9	3.5	3.3
F80	6.3	7.7	6.6	6.6	7.2	0.5 to 0.8	1.9	(0.7)	(1.4)	1.9	3.5	3.3
HA0	8.0	10.0	8.3	8.3	9.0	0.7 to 1.1	3.1	(0.5)	(1.8)	3.1	4.2	3.5
JA0	10.0	10.0	10.3	10.3	11.0	0.7 to 1.1	4.5	(0.5)	(2.1)	4.5	4.4	3.5
JC5	10.0	12.5	10.3	10.3	11.0	0.7 to 1.1	4.5	(0.5)	(2.1)	4.5	4.4	3.5
JH0	10.0	16.5	10.3	10.3	11.0	1.0 to 1.3	4.2	(0.5)	(2.1)	4.0	4.7	3.8
KE0	12.5	13.5	13.0	13.0	13.7	1.0 to 1.3	4.2	(1.3)	(3.0)	3.4	6.3	9.3
KG5	12.5	16.0	13.0	13.0	13.7	1.0 to 1.3	4.2	(1.3)	(3.0)	3.4	6.3	9.3
KN0	12.5	21.5	13.0	13.0	13.7	1.0 to 1.3	4.2	(1.3)	(3.0)	3.4	6.3	9.3
LH0	16.0	16.5	17.0	17.0	18.0	1.0 to 1.3	6.5	(2.0)	(3.0)	4.7	7.8	9.6
LN0	16.0	21.5	17.0	17.0	18.0	1.0 to 1.3	6.5	(2.0)	(3.0)	4.7	7.8	9.6
MHO	18.0	16.5	19.0	19.0	20.0	1.0 to 1.3	6.5	(2.0)	(4.0)	4.7	8.8	9.6
MNO	18.0	21.5	19.0	19.0	20.0	1.0 to 1.3	6.5	(2.0)	(4.0)	4.7	8.8	9.6

(); Ref.

RADIAL LEAD TYPE TAPING SPECIFICATIONS (Applicable standard JIS C 0806-2)

Conductive Polymer Aluminum Solid Capacitors
 Conductive Polymer Hybrid Aluminum Electrolytic Capacitors

◆ DIMENSION [mm]

Fig.1

Taping Code : TX
 $\phi D = \phi 5$

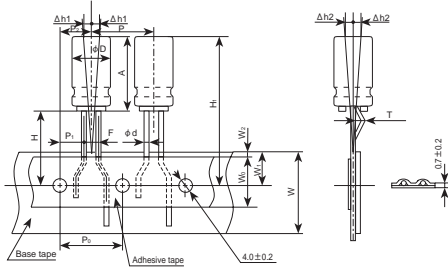
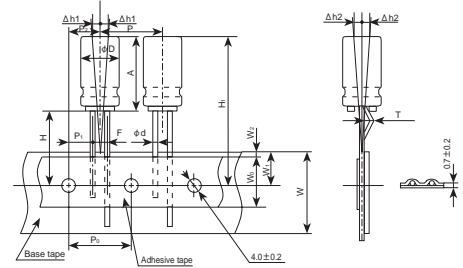

Fig.2

Taping Code : TD
 $\phi D = \phi 6.3$ to 10



Code	Taping Code	Case size		ϕd	P	P_0	P_1	P_2	F	W	W_0	W_1	W_2	H	H_1	ϕD_0	Δh_1	Δh_2	t	T	Fig
		ϕD	A																		
tol.	---	---	---	± 0.05	± 1.0	± 0.2	± 0.7	± 1.0	$^{+0.2}_{-0.2}$	± 0.5	min.	± 0.5	max.	± 0.75	max.	± 0.2	± 2.0	± 2.0	± 0.3	± 1.0	
Nominal	TX	5	8	0.5	12.7	12.7	5.35	6.35	2.0 ⁺²	18	10	9.0	2.5	18.5	28.25	4.0	0	0	0.7	0	1
		6.3	5	0.45	12.7	12.7	5.1	6.35	2.5	18	10	9.0	2.5	18.5	28.25	4.0	0	0	0.7	0	2
		6.3	8	0.6	12.7	12.7	5.1	6.35	2.5	18	10	9.0	2.5	18.5	28.75 ⁺¹	4.0	0	0	0.7	0	2
		8	8	0.6	12.7	12.7	4.6	6.35	3.5	18	10	9.0	2.5	20.0	29.75	4.0	0	0	0.7	0	2
		8	11.5	0.6 ⁺¹	12.7	12.7	4.6	6.35	3.5	18	10	9.0	2.5	20.0	33.75	4.0	0	0	0.7	0	2
		8	16	0.6	12.7	12.7	4.6	6.35	3.5	18	10	9.0	2.5	20.0	38.25	4.0	0	0	0.7	0	2
		8	20	0.6	12.7	12.7	4.6	6.35	3.5	18	10	9.0	2.5	20.0	42.25	4.0	0	0	0.7	0	2
		10	10.5	0.6	12.7	12.7	3.85	6.35	5.0	18	10	9.0	2.5	18.5	30.75	4.0	0	0	0.7	0	2
		10	11.5	0.6 ⁺¹	12.7	12.7	3.85	6.35	5.0	18	10	9.0	2.5	18.5	32.25	4.0	0	0	0.7	0	2
		10	12.5	0.6	12.7	12.7	3.85	6.35	5.0	18	10	9.0	2.5	18.5	33.25	4.0	0	0	0.7	0	2
		10	16	0.6	12.7	12.7	3.85	6.35	5.0	18	10	9.0	2.5	18.5	36.75	4.0	0	0	0.7	0	2
10	20	0.6	12.7	12.7	3.85	6.35	5.0	18	10	9.0	2.5	18.5	40.75	4.0	0	0	0.7	0	2		

* 1 : Each product family has different value. Please refer to each page.
 * 2 : For case size $\phi 5 \times 8$ (Taping code : TX), H dimension shall be $2.0^{+0.5/-0.2}$.

TAPING CODE

Example

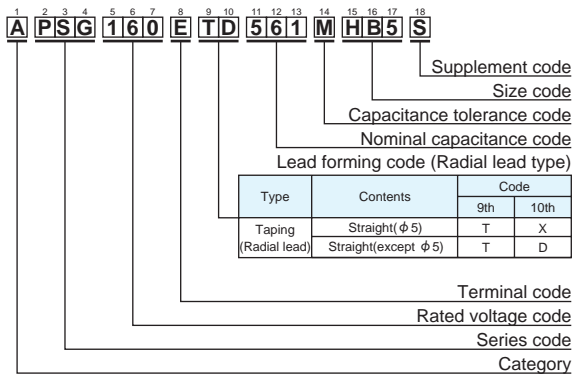

QUANTITY PER AMMO PACK

Ammo pack box

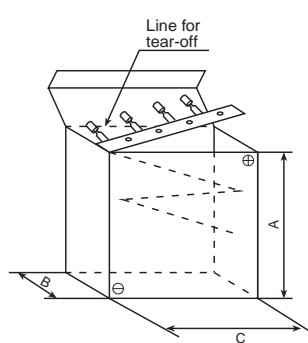

Typical example

Case size $\phi D \times L$ (mm)	A (mm)	B (mm)	C (mm)	Quantity (pcs.)
$\phi 5$ L=8mm	240	51	336	2,000
$\phi 6.3$ L=5 & 8mm	285	51	336	2,000
$\phi 8$ L=8 to 11.5mm	240	51	336	1,000
L=16mm	240	56	336	
L=20mm	240	62	336	500
$\phi 10$ L=10.5 to 12.5mm	190	51	337	
L=16mm	308	56	337	
L=20mm	308	62	337	800

RADIAL LEAD TYPE TAPING SPECIFICATIONS (Applicable standard JIS C 0806-2)

Aluminum Electrolytic Capacitors

◆ DIMENSION [mm]

Fig.1

Taping Code : TC
 $\phi D = \phi 5$ to 8

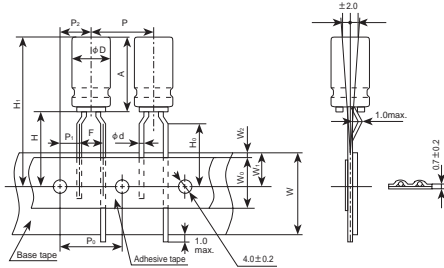

Fig.2

Taping Code : TD
 $\phi D = \phi 5$

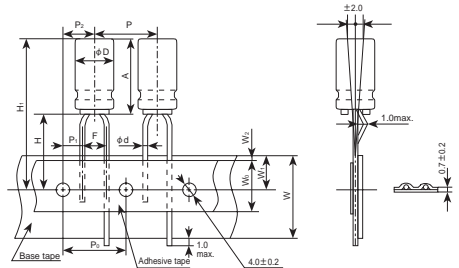

Fig.3

Taping Code : TD
 $\phi D = \phi 6.3$ to 12.5

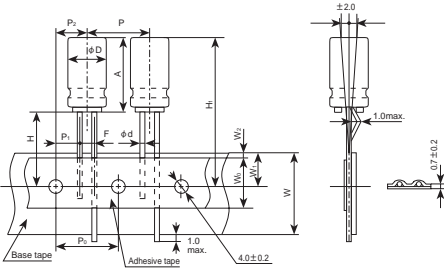
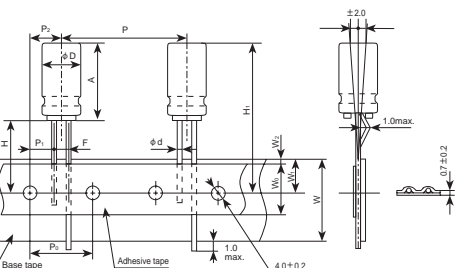

Fig.4

Taping Code : TE
 $\phi D = \phi 12.5$



Code	Taping Code	Case size		ϕd	P	P_0	P_1	P_2	F	W	W_0	W_1	W_2	H	H_0	H_1	Fig	
		ϕD	A															
tol.				± 0.05	± 1.0	± 0.2	± 0.7	± 1.0	± 0.2	± 0.5	min.	± 0.5	max.	± 0.75	± 0.5			
Nominal	TD	5	11 to 15	0.5^{*1}	12.7	12.7	5.1	6.35	2.5	18.0	10.0	9.0	1.5	18.5	16.0			2
	TC						3.85	5	1									
	TD	6.3	11 to 15	0.5	12.7	12.7	5.1	6.35	2.5	18.0	10.0	9.0	1.5	18.5	16.0			3
	TC						3.85	5	1									
	TD	8	11.5 to 20	0.6	12.7	12.7	4.6	6.35	3.5	18.0	10.0	9.0	1.5	20.0	16.0			3
	TC						3.85	5	1									
Nominal	TD	± 0.5	max.	± 0.05	± 1.0	± 0.3	± 0.7	± 1.3	± 0.2	± 0.5	min.	± 0.5	max.	± 0.0				3
	TD			0.6^{*1}	12.7	12.7	3.85	6.35	5	18.0	12.5	9.0	1.5	18.0				3
	TE	12.5	26	0.6^{*1}	25.4	12.7	3.85	6.35	5	18.0	12.5	9.0	1.5	18.0				4

* 1 : Each product family has different value. Please refer to each page.

* 2 : The taping for size $\phi 16$ and $\phi 18$ is available as a custom design.

* 3 : For the Taping code TD products with case diameter ≥ 12.5 mm, you can also select an option (Taping code: TS) that enhanced taping packaging.

TAPING CODE

Example

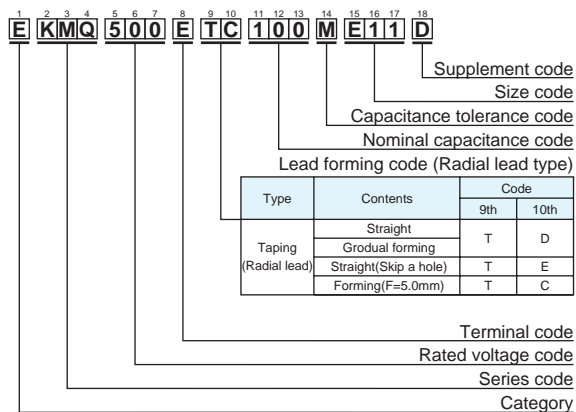

QUANTITY PER AMMO PACK

Ammo pack box

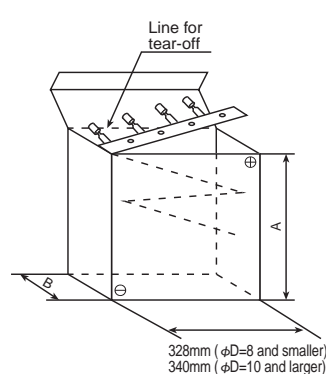

Typical example

Case size $\phi D \times L$ (mm)	A (mm)	B (mm)	Quantity (pcs.)
$\phi 5$	L=11 to 15mm	232	51
	L=17mm	235	60
$\phi 6.3$	L=11 to 15mm	284	51
	L=17mm	284	55
$\phi 8$	L=11.5 to 15mm	232	51
	L=17 & 20mm	235	60
$\phi 10$	L ≤ 16 mm	308	56
	L=17 to 20mm	308	62
	L=21 to 25mm	308	67
	L=26 to 30mm	308	71
$\phi 12.5$	L ≤ 16 mm	308	62
	L=17 to 25mm	308	67

RADIAL LEAD TYPE (CUT/FORMED LEAD)

The following lead configurations are available. When ordering, please indicate the type of lead configurations by using the appropriate supplement code, such as C3, FC, MC or RC in the product part number.

Terminal type	Size	Terminal type	Size												
<p>●Lead code : FC (Forming Cut type)</p>	φD=5 to 8	<p>●Lead code : C3 (Cutting type)</p> <p>Dimension (C)</p> <ul style="list-style-type: none"> • φD= 5 to 8: C3: 3.5±0.5(Second standard C5: 5.0±0.5) • φD=10 to 18: C3: 3.5±0.5(Second standard C5: 5.0±0.5) 	φD=5 to 18												
<p>●Lead code : FM (Snap-in type)</p>	φD=5 to 8	<p>●Lead code : MC (Snap-in type)</p>	φD=10 to 18												
<p>●Lead code : BC (Horizontal type)*3</p> <p>Dimension (P)</p> <ul style="list-style-type: none"> • φ10, φ12.5 : P=5.0±0.5 • φ14.5, φ16, φ18 : P=7.5±0.5 	φD=10 to 18	<p>●Lead code : BD (Horizontal type)*3</p> <p>Dimension (P)</p> <ul style="list-style-type: none"> • φ10, φ12.5 : P=5.0±0.5 • φ14.5, φ16, φ18 : P=7.5±0.5 	φD=10 to 18												
<p>●Lead code : IJ (Forming Cut type)</p> <p>Dimension</p> <table border="1"> <thead> <tr> <th>φD</th> <th>A · B</th> <th>φd</th> <th>P</th> </tr> </thead> <tbody> <tr> <td>10 to 12.5</td> <td>3.2±0.5</td> <td>0.6</td> <td>5.0±0.5</td> </tr> <tr> <td>14.5 to 18</td> <td>3.2±0.5</td> <td>0.8</td> <td>7.5±0.5</td> </tr> </tbody> </table>	φD	A · B	φd	P	10 to 12.5	3.2±0.5	0.6	5.0±0.5	14.5 to 18	3.2±0.5	0.8	7.5±0.5	φD=10 to 18	<p>*1 Please consult with us about other terminal forming.</p> <p>*2 Please refer to dimensions of each series for gas escape end seal style.</p> <p>*3 Conventionally, lead forming code is used in common by (BC) for two type of the lead bent directions. We added lead forming code (BD) newly and clarified the lead bent directions. Please place an order after the choice for an appropriate lead forming code depending on condition of use.</p>	
φD	A · B	φd	P												
10 to 12.5	3.2±0.5	0.6	5.0±0.5												
14.5 to 18	3.2±0.5	0.8	7.5±0.5												

◆DIMENSION (P) [mm]

Size	Lead forming	Cutting type		Snap-in type	
		FC	C3(C5)	FM	MC
φ5		5.0	2.0	5.0	—
φ6.3		5.0	2.5	5.0	—
φ8		5.0	3.5	5.0	—
φ10		—	5.0	—	5.0
φ12.5		—	5.0	—	5.0
φ14.5		—	7.5	—	7.5
φ16		—	7.5	—	7.5
φ18		—	7.5	—	7.5

*4 Please refer to dimensions of each series for lead-wire diameter (φd).

MINIMUM ORDER QUANTITY

Please order by units of minimum order quantity.

◆SURFACE MOUNT

●Vertical



Series	Size code	Quantity (pcs)	
		Taping	Tray (pcs/box)
Alchip™ MVE/MZT/MZS MZL/MZR/MZJ MZA/MVY/MZF MZE/MZK/MLA MLF/MLE/MLK MVL/MVJ/MXB MHS/MVH/MHL MHB/MHJ/MHK	D55, D60, D61	2,000	—
	D73	1,500	—
	E40, E46, E55, E60, E61, E73	1,000	—
	F46, F55, F60, F61, F73	1,000	—
	F80, H80	900	—
	F90	800	—
	FA0	750	—
	H63, H70	1,000	—
	HA0	500	—
	HCO	400	—
	J80, JA0	500	—
	JC0, JC5	400	—
	JH0	200	—
	KE0	250	600
NPCAP™ PXN/PXT/PXJ PXG/PXK/PXS PXF/PXE/PXA PXD/PXH	KG5	200	600
	KN0	150	—
	LH0	175	400
	LN0	125	400
Hybrid HXF/HXE/HXK HXJ/HXC/HXD	MH0	150	300
	MNO	100	300

◆RADIAL



Size	Bagged *1		Taping (pcs)	Tray (pcs)	
	Long lead type (pcs/box)	Formed lead type *2 (pcs/box)		Cut type (C3, C5)	
φ 5	8L	1,000	2,000	—	
	11 to 11.5L	3,000	2,000	—	
φ 6.3	5L	1,000	2,000	—	
	8L	1,000	2,000	—	
	10.5 to 15L	2,000 (1,000) *3	2,000	—	
φ 8	20L max.	1,000	1,000	—	
	11.5L	500	500	—	
φ 10	12.5L	2,000 (500) *3	800 (500) *3	1,500 (—) *3	
	16 to 20L	2,000	800	1,500	
	25L	1,000	800	1,500	
	30 to 45L	1,000	—	750	
	50L	500	—	—	
φ 12.5	16L max.	1,000	500	1,500	
	20 to 25L	1,000	500	1,500	
	30L	1,000	—	750	
	35 to 45L	500	—	750	
	50L	500	—	—	
φ 14.5	20L max.	500	250	500	
	25L	500	250	500	
	30 to 45L	500	—	500	
	50L	250	—	—	
φ 16	15L, 16L	500	250	500	
	20 to 25L	500	250	500	
	30 to 35.5L	500	—	500	
	40L	250	—	500	
	45L	250	—	—	
	50L	250	—	—	
φ 18	25L max.	500	250	500	
	30 to 50L	250	—	500	

*1 The GVA, GPD, GVD and GQB series are not compatible with bagging. They are packaged in a box.

*2 The standard bagged quantity may differ depending on the terminal type or packing style. Please contact us for details.

*3 Minimum order quantity for conductive polymer aluminum solid capacitors and conductive polymer hybrid aluminum electrolytic capacitors.

Series	Case size		Boxed (pcs)	Case size		Boxed (pcs)
	φ D	L	Long lead type	φ D	L	Long lead type
Aluminum Electrolytic Capacitors GVA/GPD/GVD GQB	12.5	20 to 31.5	500	16	20 to 31.5	250
		35 to 40			35 to 40	
	14.5	20 to 31.5	300	18	20 to 31.5	200
		35 to 40			35 to 40	

◆SNAP-IN

200 pieces



◆SCREW-MOUNT TYPE

Size	Minimum order quantity (pcs)
φ 76.2 max.	20
φ 89	10
φ 100	4

AVAILABLE TERMINALS FOR SNAP-IN AND SCREW-MOUNT TYPE

- We can make the following terminal type on custom design.
- There is a restriction for specification of product, please consult with us when the product is required.
- Please consult with us about terminal type other than those following listed.

Snap-in type

[mm]

<p>Terminal, Dummy code : VNN</p> <p>D=φ22 to φ35</p>	<p>Terminal, Dummy code : LIN</p> <p>D=φ30 to φ40</p>
<p>Terminal, Dummy code : VEN</p> <p>D=φ30, φ35</p>	<p>Terminal, Dummy code : VRD</p> <p>D=φ35, φ40</p> <p>B : Positive, A, C : Dummy</p>
<p>Terminal, Dummy code : VND</p> <p>D=φ35, φ40</p> <p>B : Positive, A, C : Dummy</p>	<p>Terminal, Dummy code : LIS</p> <p>D=φ50</p> <p>A : Dummy</p>
<p>Horizontal mounting</p> <p>Terminal, Dummy code : LCN</p> <p>D=φ22×30 to 50L</p>	

*1 Negative terminal : Mesh marking

*2 Use the dummy terminals for mechanical support only.

The dummy terminals must not be connected to any circuit trace on PC board, be sure to electrically isolate from the negative and the positive terminals.

Screw-mount type

[mm]

<p>Stud mounting type</p> <p>D=φ63.5 to φ89</p>
--

Please consult with us about other size.

The series in the following table has been deleted from this catalog. Since they will be discontinued, please use the recommended replacement series when designing new products.

◆REPLACEMENTS

Classification	Terminal shape	Discontinued series	Characteristics	Replacements	
Conductive Polymer Hybrid Aluminum Electrolytic Capacitors	Chip Type	HXA	125°C, Low ESR, high ripple current	HXC	
		HXB	105°C, Low ESR	HXD	
Conductive Polymer Aluminum Solid Capacitors	Radial lead type	PSA	Super low ESR, high ripple current	PSE/PSF/PSG	
		PS	Super low ESR, high ripple current		
Aluminum Electrolytic Capacitors	Surface mount type	MV	85°C, standard	MVE	
		MVA	85°C, standard		
		MVK	105°C, standard		
		MKB	105°C, high voltage		
		MV-BP	85°C Bi-polar		
		MVK-BP	105°C Bi-polar		
	Radial lead type	SRM	85°C 5mm height	—	
		SRE	85°C 5mm height		
		KRE	105°C 5mm height		
		SRA	85°C 7mm height		
		KMA	105°C 7mm height		
		SRE-BP	85°C Bi-polar, 5mm height		
		SRA-BP	85°C Bi-polar, 7mm height		
		KRE-BP	105°C Bi-polar, 5mm height		
		KMA-BP	105°C Bi-polar, 7mm height		
		SME-BP	85°C Bi-polar, downsizing		
		KME-BP	105°C Bi-polar, downsizing		
		SNX-BP	For Audio, 85°C Bi-polar		
		SMQ	85°C, standard		KMQ
		SMG	85°C, standard		
		KMG	105°C, standard		
		KXG	105°C, long life		
		KXE	105°C, long life		
		GXE	125°C, high temperature		
		KMY	Low impedance, Long life		KYB
		KLJ	No sparks with DC overvoltage		KLJ
		LBK	For airbag, downsizing		LBG/LBV
		FL	105°C Low Profile, Long life		—
		PH	For photo flash		
		ARI	For Audio, 5/7mm height		
	Snap-in type	KLM	15mm height, low profile	CHA	
		LXH	No sparks with DC overvoltage		
	Screw-mount type	RWG	85°C, high ripple current, downsizing	RWH	
		RWY	85°C, high ripple current		
		FTP	Ovalized can shape, high ripple current	—	

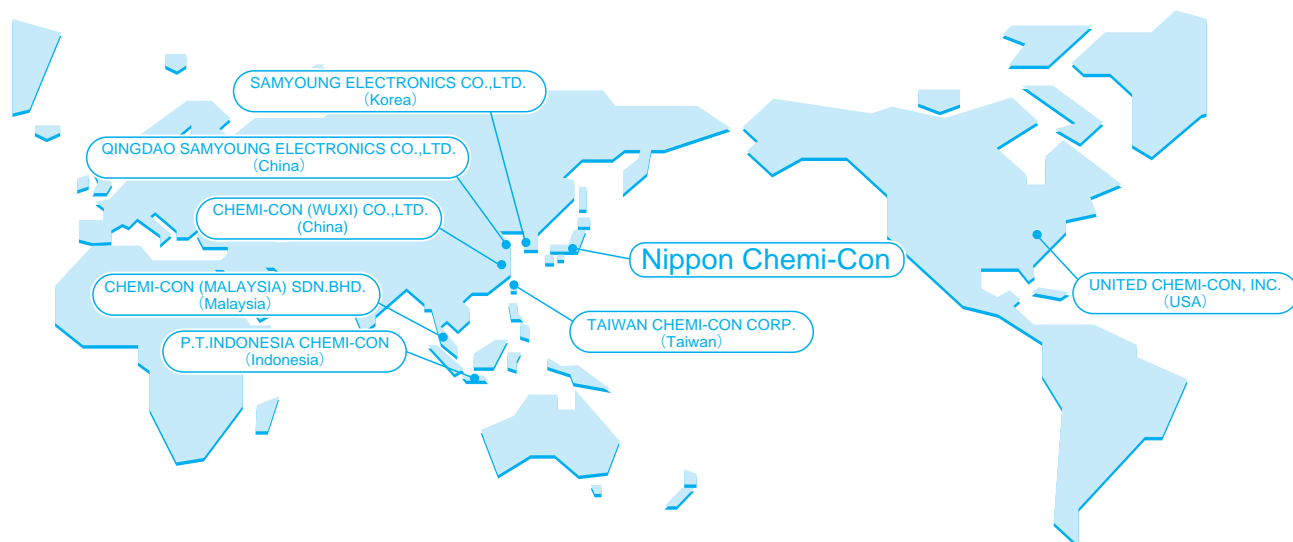

● AVAILABLE ITEMS BY MANUFACTURING LOCATIONS (Production in Japan is excluded)

Classification	Series	SAMYOUNG ELECTRONICS (Korea)	QINGDAO SAMYOUNG ELECTRONICS (China)	CHEMI-CON WUXI (China)	P.T.INDONESIA CHEMI-CON (Indonesia)	TAIWAN CHEMI-CON (Taiwan)	CHEMI-CON MALAYSIA (Malaysia)	UNITED CHEMI-CON (USA)
Conductive Polymer Al-Solid Type (SMD)	PXG / PXJ					●		
	PXF / PXE					●		
Conductive Polymer Al-Solid Type (Radial lead)	PSG / PSC					●		
	PSF / PSE					●		
Conductive Polymer Hybrid (SMD)	HXC / HXD					●		
Aluminum Electrolytic (SMD)	MVE			●	●			
	MZS / MZR / MZJ / MZL				●			
	MVY / MZA			●	●			
	MLA / MZE / MZF / MZK				●			
	MVJ / MLE / MLF				●			
	MVH / MHB			●	●			
	MHJ / MHK / MHL				●			
MAR				●				
Aluminum Electrolytic (Radial lead) Low Profile	SRG			●	●			
	KRG			●	●			
Aluminum Electrolytic (Radial lead) General purpose	KMQ		●	●	●			
Aluminum Electrolytic (Radial lead) Low impedance, High ripple current	KZN / KZM / KZH			●	●			
	KYB			●	●			
	KYA / KY / KZE		●	●	●			
	KYC				●			
	LXZ / LXV			●	●			
	LZA			●				
	KXL			●				
	KXJ			●	●			
	PAG			●	●			
Aluminum Electrolytic (Radial lead) High temperature Long life	KWA			●				
	KHE			●				
	KXF			●				
	GPA			●	●			
Aluminum Electrolytic (Radial lead) Special Application	GXL			●	●			
	GXF/GPD			●				
	LE				●			
Aluminum Electrolytic (Radial lead) No Sparks against Over-Voltage	LBG			●				
Aluminum Electrolytic (Snap-in)	KLJ 450V			●				
	SMR						●	
	SMQ / KMQ / KMR	●	●				●	
	SMM / KMM	●					●	
	KMW / KMZ						●	
	KMS	●					●	
	LXM						●	
	LXS / LXQ	●	●				●	
Aluminum Electrolytic (Screw-mount terminal)	CHA						●	
	KMV						●	
	KMH			●				●
	RWF / RWE / RWL			●				●
	LXA							●
	RWQ			●				
	RWV			●				
RWR / RWH			●					
Aluminum Electrolytic (Screw-mount terminal)	U37F / U37L / U37X							●
	UTOR							●

*1 Please be sure to contact us before ordering as our product range is continuously improved and the product you require may have been superseded.
 *2 Refer to our web site for factory address.

Conductive Polymer Aluminum Solid Capacitors





PRECAUTIONS AND GUIDELINES (Conductive Polymer)

The NPCAP™ is a Conductive Polymer Solid Aluminum Capacitor that uses highly conductive polymer electrolytic material. Please read the following in order to get the most out of your NPCAP™ capacitor.

The circuits described as examples in this catalog and the "delivery specifications" are featured in order to show the operations and usage of our products, however, this fact does not guarantee that the circuits are available to function in your equipment systems.

We are not in any case responsible for any failures or damage caused by the use of information contained herein.

You should examine our products, of which the characteristics are described in the "delivery specifications" and other documents, and determine whether or not our products suit your requirements according to the specifications of your equipment systems. Therefore, you bear final responsibility regarding the use of our products.

Please make sure that you take appropriate safety measures such as use of redundant design and malfunction prevention measures in order to prevent fatal accidents and/or fires in the event any of our products malfunction.

For Conductive Polymer Hybrid Aluminum Electrolytic Capacitors, see Precautions and Guidelines (Conductive Polymer Hybrid). For Aluminum Electrolytic Capacitors, see Precautions and Guidelines (Aluminum Electrolytic Capacitors).

1 Designing Device Circuits

1) Types of Circuits Where NPCAP™ Capacitors are Not to be Used

The leakage current in conductive polymer solid aluminum capacitors (hereafter called capacitors) may vary depending on thermal stresses during soldering. Avoid the use of capacitors in the following types of circuits:

- ① High-impedance circuits that are to sustain voltages.
- ② Coupling circuits
- ③ Time constant circuits
Because the capacitance varies depending on the environment the capacitors are used in, there is a possibility that the capacitor can affect a time constant circuit where sensitivity to variation in capacitance is required.
- ④ Other circuits that are significantly affected by leakage current

2) Circuit Design

Verify the following before designing the circuit:

- ① The electrical characteristics of the capacitor will vary depending on differences in temperature and frequency. You had better design after verifying the scope of these factors.
- ② When connecting two or more capacitors in parallel, ensure that the design takes current balancing into account.
- ③ When two or more capacitors are connected in series, variability in applied voltage may cause over-voltage conditions. Contact Nippon Chemi-Con before using capacitors connected in series.
- ④ Avoid putting heat generating parts either around the capacitor or on the reverse of the circuit board.

3) Use in High Reliable and Critical Applications

Consult with us in advance of usage of our products in the following listed applications. ① Aerospace equipment ② Power generation equipment such as thermal power, nuclear power etc. ③ Medical equipment ④ Transport equipment (automobiles, trains, ships, etc.) ⑤ Transportation control equipment ⑥ Disaster prevention / crime prevention equipment ⑦ Highly publicized information processing equipment ⑧ Submarine equipment ⑨ Other applications that are not considered general-purpose applications.

4) Polarity

The NPCAP™ is a polarized solid aluminum electrolytic capacitor. Do not apply either reverse voltages or AC voltages to the polarized capacitors, using reversed polarity may cause a short circuit. Refer to the catalog, product specifications or capacitor body to confirm the polarity prior to use.

5) Operating Voltage

Do not apply a greater than rated voltage, if a voltage greater than the rated voltage is suddenly applied the leakage current increases causing shorting. The peak voltage of superimposed AC voltages (ripple voltages) on DC voltages must not exceed

the full rated voltage. Capacitors do not require voltage derating within the category temperature. While there are specifications for surge voltages exceeding the rated voltage, usage conditions apply, and continued operation for extended periods of time under such conditions cannot be guaranteed.

6) Ripple Current

Do not apply currents in excess of the rated ripple current. The superimposition of a large ripple current increases the rate of heating within the capacitor. When excessive ripple current is imposed the internal temperature increases which can shorten life and shorting may occur.

7) Operating Temperature

Use within the stated category temperature range, if used outside this range, characteristics can deteriorate potentially leading to problems.

8) Charging and Discharging the Capacitor

Do not use the NPCAP™ capacitor in circuits where the capacitor is repetitively charged and discharged rapidly. Repetitively charging and discharging the capacitor rapidly may reduce the capacitance or may cause damage due to internal heating. Use of a protective circuit to ensure reliability is recommended when rush currents exceed 20A.

9) Leakage current

The leakage current may increase. After that, however, the leakage current will gradually decrease by self-healing action of the dielectric oxide layer when the capacitors are applied with a voltage less than the rated voltage within the Category Temperature range. As the voltage is closer to the rated voltage and the temperature is closer to the upper limit of Category Temperature range, the leakage current decreases faster.

The leakage current will increase by the following factors,

- ① Soldering
- ② Testing of high temperature exposure with no voltage applied, high temperature/humidity storage, temperature cycles, etc.

10) Failures and Service Life

The failure rate at the rated voltage application of NPCAP™ and the upper limit of the category temperature is based on 0.5%/1,000 hours (reliability level 60%) compliant with JIS C 5003. The possibility of failures is not zero, however, the actual failure mode is as follows.

(1) Failure Modes

- ① The principal failure mode is wear-out failure caused by a decrease in capacitance as a result of an increase in temperature in the product, and an increase in ESR, both of which eventually cause the capacitors to experience open circuit failure. In addition, a short circuit failure may occur due to excessive voltage, excessive current, excessive heat stress, or excessive physical stress applied to the capacitors.
 - ② The failure rate would be reduced by reducing ambient temperatures, ripple current and applying voltage.
 - ③ If the short-circuited capacitor, which may be caused by over-voltages higher than the rated voltage or other conditions, has a large amount of current passed through, the aluminum can of the capacitor bulges and might be expelled with odor gas emitted.
 - ④ The product contains flammable materials. If the short causes a spark it may ignite.
Please be careful when installing the product, its position and the layout design.
 - Increase safety by using in conjunction with a protective circuit or protective equipment.
 - Install measures such as redundant circuits so that the failure of a part of the equipment will not cause unstable operation.
- Failure modes depend on the application conditions that lead to fail.

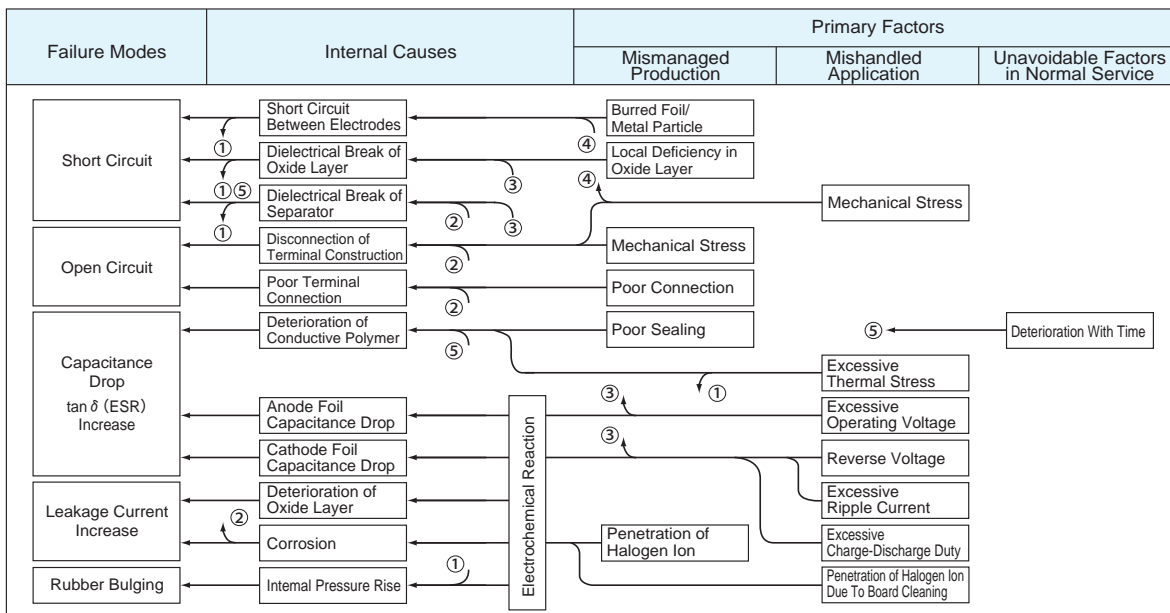

(2) Service Life

SMD (Chip type) and radial lead type use rubber as the sealing material, so the service life depends on the thermal integrity of this rubber.
When long life performance is required in actual use, please use the capacitor at lower temperature within the category temperature.

- ④ Do not pass any via holes underneath a capacitor on double-sided PC board
- ⑤ In designing double-sided PC boards, do not locate any copper trace under the seal side of a capacitor

11) Capacitor Insulation

Insulation of the capacitor's case is not guaranteed. Ensure electrical insulation between the capacitor case, negative electrode, positive electrode and circuit pattern.

12) Capacitor Usage Environment

- Do not use/expose capacitors to the following conditions.
- ① Oil, water, salty water, take care to avoid storage in damp locations.
 - ② Direct sunlight
 - ③ Toxic gases such as hydrogen, sulfide, sulfuric acids, nitrous acids, chlorine and chlorine compounds, bromine and bromine compounds, ammonia, etc.
 - ④ Ozone, ultraviolet rays and radiation.
 - ⑤ Severe vibration or mechanical shock conditions beyond the limits advised in the product specification section of the catalog. The standard vibration condition is applicable to JIS C 5101-4.

13) Capacitor mounting

- ① For the surface mount capacitor, design the solder land on the PC board in accordance with the catalog or the product specification.
- ② For radial capacitors, design the terminal holes on the PC board to fit the terminal dimension of the capacitor.
- ③ Do not pass any circuit traces beneath the seal side of a

2) Installing Capacitors

1) Installing

- ① Do not reuse capacitors already assembled in equipment that have been exposed to power.
- ② The capacitor may have self charge. If this happens, discharge the capacitor through a resistor of approximately 1kΩ before use.
- ③ If capacitors are stored at a temperature of 35°C or more and more than 75%RH, the leakage current may increase. This may also occur if the capacitors are stored for a longer period than the period which is specified in the catalog or the product specification. In this case, they can be reformed by the voltage treatment through a resistor of approximately 1kΩ.
- ④ Verify the rated capacitance and voltage of the capacitors when installing.
- ⑤ Verify the polarity of the capacitors.
- ⑥ Do not use the capacitors if they have been dropped on the floor.
- ⑦ Do not deform the case of the capacitors.
- ⑧ Verify that the lead spacing of the capacitor fits the hole spacing in the PC board before installing the capacitors.
- ⑨ Do not apply any mechanical force in excess of the limits prescribed in the catalog or the product specification of the capacitors. Avoid subjecting the capacitor to strong forces,



PRECAUTIONS AND GUIDELINES (Conductive Polymer)

as this may break the electrode terminals, bend or deform the capacitor, or damage the packaging, and may also cause short/open circuits, increased leakage current, or damage the appearance. Also, note the capacitors may be damaged by mechanical shocks caused by cut the lead wire, the vacuum/insertion head, component checker or centering operation of an automatic mounting or insertion machine.

2) Heat Resistance during Soldering

Ensure that the soldering conditions meet the specifications recommended by Nippon Chemi-Con. Note that the leakage current may increase or capacitance may decrease due to thermal stresses that occur during soldering, etc. Furthermore, the leakage current which rose gradually decreases, when voltage is applied at below the category upper limit temperature. Additionally the self repairing action is faster when voltage near the rated voltage rather than at a higher voltage is applied at below the category's upper temperature limit.

- ① Verify the following before using a soldering iron:
 - That the soldering conditions (temperature and time) are within the ranges specified in the catalog or product specifications.
 - That the tip of the soldering iron does not come into contact with the capacitor itself.
- ② Verify the following when flow soldering:
 - Do not dip the body of a capacitor into the solder bath only dip the terminals in. The soldering must be done on the reverse side of PC board.
 - Soldering conditions (preheat, solder temperature and dipping time) should be within the limits prescribed in the catalog or the product specifications.
 - Do not apply flux to any part of capacitors other than their terminals.
 - Make sure the capacitors do not come into contact with any other components while soldering.
 - Flow soldering must not be used for the SMD(Chip type) capacitors.
- ③ Verify the following when reflow soldering:
 - Soldering conditions (preheat, solder temperature and soldering time) should be within the limits prescribed in the catalogs or the product specification.
 - The heat level should be appropriate. (Note that the thermal stress on the capacitor varies depending on the type and position of the heater in the reflow oven, and the color and material of the capacitor.)
 - Please consult us about Vapor phase soldering (VPS).
 - Except for the surface mount type, reflow soldering must not be used for the capacitors.
- ④ Do not reuse a capacitor that has already been soldered to PC board and then removed. When using a new capacitor in the same location, remove the flux, etc. first, and then use a soldering iron to solder on the new capacitor in accordance with the specifications.

3) Handling After Soldering

Do not apply any mechanical stress to the capacitor after soldering onto the PC board.

- ① Do not lean or twist the body of the capacitor after soldering the capacitors onto the PC board.
- ② Do not use the capacitors for lifting or carrying the assembly board.
- ③ Do not hit or poke the capacitor after soldering to PC board. When stacking the assembly board, be careful that other components do not touch the aluminum electrolytic capacitors.
- ④ Do not drop the assembled board.

4) Cleaning PC boards

- ① Do not wash capacitors by using the following cleaning agents. Solvent resistant capacitors are only suitable for washing using the cleaning conditions prescribed in the

catalog or the product specification. In particular, ultrasonic cleaning will accelerate damage to capacitors.

- Halogenated solvents; cause capacitors to fail due to corrosion.
 - Alkali system solvents; corrode (dissolve) an aluminum case.
 - Petroleum system solvents; cause the rubber seal material to deteriorate.
 - Xylene and toluene; causes the rubber seal material to deteriorate.
 - Acetone; erases the markings.
- CFC alternatives or the other cleaners above; please consult with us.
- ② Verify the following points when washing capacitors.
 - Monitor conductivity, pH, specific gravity and the water content of cleaning agents. Contamination adversely affects these characteristics.
 - Be sure not to expose the capacitors under solvent rich conditions or keep capacitors inside a closed container. In addition, please dry the solvent sufficiently on the PC board and the capacitor with an air knife (temperature should be less than the maximum rated category temperature of the capacitor) for 10 minutes. Aluminum electrolytic capacitors can be characteristically and catastrophically damaged by halogen ions, particularly by chlorine ions, though the degree of the damage mainly depends upon the characteristics of the electrolyte and rubber seal material. When halogen ions come into contact with the capacitors, the foil corrodes when a voltage is applied. This corrosion causes an extremely high leakage current which results venting and an open circuit.
- If the new types of cleaning agents mentioned below are used, the following are recommended as cleaning conditions for some of new cleaning agents.

-Higher alcohol cleaning agents

Pine Alpha ST-100S (Arakawa Chemical)
Clean Through 750H, 750HS and 750J (Kao)
Cleaning Conditions:

Using these cleaning agents, capacitors are capable of withstanding immersion or ultrasonic cleaning for 10 minutes at a maximum liquid temperature of 60°C. Find optimum condition for washing, rinsing, and drying. Be sure not to rub the marking off the capacitor which can be caused by contact with other components or the PC board. Note that shower cleaning adversely affects the markings on the sleeve.

-Non-Halogenated Solvent Cleaning

AK225AES (Asahi Glass)
Cleaning Conditions:
Immersion, ultrasonic or vapor cleaning for 5 minutes. However, from an environmental point of view, these types of solvent will be banned in near future. We would recommend not using them if at all possible.

-Isopropyl Alcohol (IPA)

IPA (Isopropyl Alcohol) is one of the most acceptable cleaning agents; it is necessary to maintain a flux content in the cleaning liquid at a maximum limit of 2 Wt.%.

5) Precautions for using adhesives and coating materials

- ① Do not use any adhesive and coating materials containing halogenated solvent.
- ② Verify the following before using adhesive and coating material.
 - Remove flux and dust left over between the rubber seal and the PC board before applying adhesive or coating materials to the capacitor.
 - Dry and remove any residual cleaning agents before applying adhesive and coating materials to the capacitors. Do not cover over the whole surface of the rubber seal with the

adhesive or coating materials.

- For permissible heat conditions for curing adhesives or coating materials, please consult with us.
- Covering over the whole surface of the capacitor rubber seal with resin may result in a hazardous condition because the inside pressure cannot be completely released. Also, a large amount of halogen ions in resins will cause the capacitors to fail because the halogen ions penetrate into the rubber seal and the inside of the capacitor.
- Some coating materials, it cannot be implemented to the capacitor.

Please note change on the surface might be caused according to the kind of solvents used for mounting adhesives and coating agents.

6) Fumigation

In exporting or importing electronic devices, they may be exposed to fumigation with halide such as methyl bromide. Where aluminum electrolytic capacitors are exposed to halide such as methyl bromide, the capacitors will be damaged with the corrosion reaction with halogen ions in the same way as cleaning agents. For the export and import, Nippon Chemi-Con considers using some packaging method and so forth so that fumigation is not required. For customers to export or import electronic devices, semi-assembly products or capacitor components, confirm if they will be exposed to fumigation and also consider final condition of packaging. (Note that either cardboard or vinyl package has a risk of fumigation gas penetration.)

3) The Operation of Devices

- 1) Do not touch the capacitor terminals directly.
- 2) Do not short-circuit the terminal of a capacitor by letting it come into contact with any conductive object. Also, do not spill electric-conductive liquid such as acid or alkaline solution over the capacitor.
- 3) Do not use capacitors in circumstances where they would be subject to exposure to the following materials
 - Oil, water, salty water or damp location.
 - Direct sunlight.
 - Ozone, ultraviolet rays or radiation.
 - Toxic gases such as hydrogen sulfide, sulfurous acid, nitrous acid, chlorine or its compounds, and ammonium.
 - Severe vibration or mechanical shock conditions beyond the limits prescribed in the catalog or product specification. The standard vibration condition is applicable to JIS C 5101-4.

4) Maintenance Inspection

- 1) Make periodic inspections of capacitors that have been used in industrial applications. Before inspection, turn off the power supply and carefully discharge the electricity in the capacitors. Verify the polarity when measuring the capacitors with a volt-ohm meter. Do not apply any mechanical stress to the terminals of the capacitors.
- 2) The following items should be checked during the periodic inspections.
 - ① Significant damage in appearance
 - ② Electrical characteristics: Leakage current, capacitance, $\tan \delta$ and other characteristics prescribed in the catalog or product specification.

We recommend replacing the capacitors if the parts are out of specification.

5) Contingencies

- 1) If gas has vented from the capacitor during use, there is a short circuit and burning, or the capacitor discharges an odor or smoke, turn off the main power supply to the equipment or unplug the power cord.
- 2) If there is a problem with the capacitor or a fire breaks out, the capacitor may produce a burning gas or reactive gas

from the outer resin, etc. If this happens, keep your hands and face away from the gas. If vented gas is inhaled or comes into contact with your eyes, flush your eyes immediately with water and/or gargle. If vented gas comes into contact with the skin, wash the affected area thoroughly with soap and water.

6) Storage

We recommend the following conditions for storage.

- 1) Store capacitors in a cool, dry place. Store at a temperature between 5 and 35°C, with a humidity of 75% or less. (table-1 Maximum storage term)

	Before the bag is opened	After the bag is opened
SMD (Chip type)	Within 3 years after manufacturing	Within 6 months after the bag is opened
Radial	Within 3 years after manufacturing	—

SMD products are sealed in a special laminated aluminum bag. Use all capacitors once the bag is opened. Return unused capacitors to the bag, and seal it with a zipper. Please refer to (Table -1 maximum storage term) for storage conditions. Be sure to follow our recommendations for reflow soldering.

- 2) Store the capacitors in a location free from direct contact with water, salt water, and oil.
- 3) Store in a location where the capacitor is not exposed to toxic gas, such as hydrogen sulfide, sulfurous acid, nitrous acid, chlorine or chlorine compounds, bromine or other halogen gases, methyl bromide or other halogen compounds, ammonia, or similar.
- 4) Store in a location where the capacitor is not exposed to ozone, ultraviolet radiation, or other radiation.
- 5) It is recommended to store capacitors in their original packaging wherever possible.
- 6) The JEDEC J-STD-020 standard does not apply.

7) Disposal

Please consult with a local industrial waste disposal specialist when disposing of aluminum electrolytic capacitors.

8) About AEC-Q200

The Automotive Electronics Council (AEC) was originally established by major American automotive related manufactures. Today, the committees are composed of representatives from the sustaining Members of manufacturing companies in automotive electrical components. It has standardized the criteria for "stress test qualification" and "reliability tests" for electronic components.

AEC-Q200 is the reliability test standard for approval of passive components in Automotive applications. It specifies the test type, parameters and quantity, etc. for each component. The criteria of the reliability tests such as for our main products, "Aluminum Electrolytic Capacitors" are described in this standard.

Pursuant to the customer's specific testing requirements, Chemi-Con submits the test results according to AEC-Q200 for Aluminum Electrolytic Capacitors used in automotive applications on request.

An electronic component manufacturer cannot simply claim that their product is "AEC-Q200 Qualified". It can be claimed "Compliant", "Capable", "Available", etc., however each component must be tested per each users "Qualification Test Plan" in order to claim AEC-Q200 status.

Please contact us for more information.

9) Response to the Substances of Concern

- 1) Nippon Chemi-Con aims for developing products that meet laws and regulations concerning substances of concern. (Some products may contain regulated substances for ex-



PRECAUTIONS AND GUIDELINES (Conductive Polymer)

empted application)

Please contact us for more information about law-compliance status.

- 2) According to the content of REACH handbook (Guidance on requirements for substances in articles which is published on May 2008), our electronic components are “articles without any intended release”. Therefore they are not applicable for “Registration” for EU REACH Regulation Article 7 (1).

Reference: Electrolytic Condenser Investigation Society

“Study of REACH Regulation in EU about Electrolytic Capacitor”

(publicized on 13 March 2008)

10 Catalogs

Specifications in the catalogs are subject to change without notice. Test data shown in the catalogs are not assured as the whole performance values, but typical values.

For more details, refer to JEITA RCR-2367D (March 2019) with the title of “Safety Application Guide for fixed aluminum electrolytic capacitors for use in electronic equipment”.

RECOMMENDED SOLDERING CONDITIONS FOR NPCAP™

◆ SURFACE MOUNT TYPE

The following conditions are recommended for air or infrared reflow soldering PXN/PXT/PXJ/PXG/PXK/PXS/PXF/PXE/PXA/PXD/PXH series onto a glass epoxy circuit board of 90x50x0.8mm (with resist) by cream solder. The temperatures shown are the surface temperature values on the top of the can and temperature of capacitor terminal.

Reflow should be performed twice or less.

Please ensure that the capacitor became cold enough to the room temperature (5 to 35°C) before the second reflow.

● Recommended soldering heat conditions

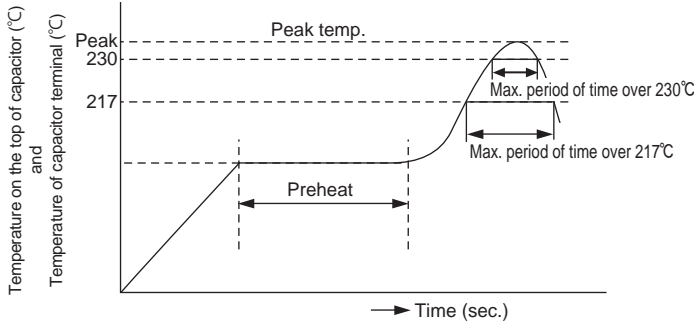

Series	Voltage range (Vdc)	Preheat	Time maintained above 217°C	Time maintained above 230°C	Peak temp.	Reflow number
PXN/PXT PXJ/PXG PXK/PXS PF/PXE PXA/PXD PXH	2.5 to 16V	150 to 180°C	50 sec. max.	40 sec. max.	260°C max.	1-cycle only
		120 sec. max.	50 sec. max.	40 sec. max.	250°C max.	2-cycles allowed
	20 to 25V		40 sec. max.	30 sec. max.	250°C max.	2-cycles allowed

● Recommended Solder Land on PC Board

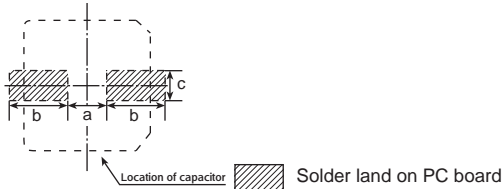

Size code	[mm]		
	a	b	c
E40, E46, E61	1.4	3.0	1.6
F46, F61, F80, FA0	1.9	3.5	1.6
H70, H80, HA0, HCO	3.1	4.2	2.2
J80, JA0, JC0	4.5	4.4	2.2

◆ RADIAL LEAD TYPE

● Recommended soldering heat conditions

Preheat : 150°C 120 seconds max.

Flow soldering : 260±5°C max. 10+1 seconds max. (Or 380±10°C max. 3±0.5 seconds max.: hand soldering)

◆ PRECAUTIONS FOR USERS

Soldering method

SMD (Chip type) have no capability to withstand such dip or flow soldering as totally immersing components into a solder bath.

Reflow soldering

Reflow the capacitors within Recommended Reflow Soldering Conditions. Verify there is no temperature stress to the capacitors because the following differences might degrade capacitors electrically and mechanically. Please consult with us if other reflow conditions are employed.

1. Location of components : Temperature increases at the edge of PC board more than the center.
2. Population of PC board : The lower the component population is, the more temperature rises.
3. Material of PC board : A ceramic-made board needs more heat than a glass epoxy-made board. The heat increase may cause damage to the capacitors.
4. Thickness of PC board : A thicker board needs more heat than a thinner board. The heat may damage the capacitors.
5. Size of PC board : A larger board needs more heat than a smaller board. The heat may damage the capacitors.
6. Solder thickness
If very thin cream solder paste is to be used for SMD types, please consult with us.
7. Location of infrared ray lamps : IR reflow as well as hot plate reflow heats only on the reverse side of the PC board to lessen heat stress to the capacitors.
8. Case leakage current will increase (~mA) after the reflow process, the leakage current which rose gradually decreases when voltage is applied.
9. Please consult us about vapor phase soldering (VPS).

Rework of soldering

Use a soldering iron for rework. Do not exceed an iron tip temperature of 380±10°C and an exposure time of 3±0.5 seconds.

Mechanical stress

Do not grab the capacitors to lift the PC board and give stress to the capacitor. Avoid bending the PC board. This may damage the capacitors.

Cleaning assembly board

Immediately after solvent cleaning, remove residual solvent with an air knife for at least 10 minutes. If the solvent is insufficiently dry, the capacitors may corrode.

Coating on assembly board

1. Before curing coating material, remove the cleaning solvents from the assembly board.
2. Before conformal coating, a chloride free pre-coat material is recommended to decrease the stress on the capacitors.

Molding with resin

Internal chemical reaction gradually produces gas in the capacitor; increasing internal pressure. If the end seal of the capacitor is completely covered by resin the gas will be unable to escape causing a potentially dangerous situation. The chlorine in resin will penetrate the end seal, reach the element, and damage of the capacitor.

Glue

The followings are requirements for glue.

1. A low curing temperature over a short period of time
2. Strong adhesion and heat resistance after curing
3. Long shelf life
4. No corrosion

Others

Refer to PRECAUTIONS AND GUIDELINES (Conductive Polymer).



Lifetime Estimation of Conductive Polymer Aluminum Solid Capacitors

Subject series : PXN, PXT, PXJ, PXG, PKX, PXS, PXF, PXE, PXA, PXD, PXH, PSW, PSJ, PSG, PSK, PSF, PSE, PSC

Conductive polymer aluminum solid capacitors are finite life electronic components like aluminum electrolytic capacitors.

The lifetime is affected by ambient temperature, humidity, ripple current and surge voltage.

The lifetime of aluminum electrolytic capacitors is affected mainly by the loss of electrolyte as the result of the liquid electrolyte evaporating through the rubber seal materials, resulting in capacitance drop and tan δ rise.

On the other hand, the lifetime of conductive polymer aluminum solid capacitors is affected mainly by oxidation degradation of the conductive polymer caused by osmose of oxygen or the thermal degradation of the conductive polymer by ambient temperature or self-heating, resulting in ESR rise and tan δ rise.

The infiltration rate of the oxygen is depend on the temperature as the liquid electrolyte evaporation and the relationship follows the Arrhenius's Law, too. Similarly, thermal degradation of the conductive polymer by self-heating follows the Arrhenius's Law, too.

Therefore, the lifetime estimation has been using the theory of lifetime reducing by half at every 10°C rise of the ambient temperature.

1. Lifetime Estimation

Equation (1) can be used for estimating the lifetime of the conductive polymer aluminum solid capacitors based on the ambient temperature and the rise of internal temperature due to ripple current.

$$L_x = L_o \times 2^{\frac{T_o - T_x}{10}} \times 2^{\frac{-\Delta T}{10}} \dots\dots\dots(1)$$

- Lx : Estimation of actual lifetime (hour)
- Lo : Specified lifetime with the rated voltage at the upper limit of the category temperature (hour)
- To : Maximum category temperature (°C)
- Tx : Actual ambient temperature of the capacitor (°C)
Use 40°C if the actual ambient temperature is below it.
- ΔT : Rise of internal temperature due to the rated ripple current (°C)

Longer lifetime is expected by lowering the ripple current and the ambient temperature.

An approximate value of ripple current-caused ΔT can be calculated using Equation (2)

$$\Delta T = \Delta T_o \times \left(\frac{I_x}{I_o} \right)^2 \dots\dots\dots(2)$$

ΔTo : Rise in internal temperature due to the rated ripple current

Maximum category temperature	ΔT _o	
	T _x ≤ 105°C	105°C < T _x ≤ 125°C
105°C	20°C	-
125°C	20°C	3°C

*Please consult us about Δ To for F80 size of PXH series.

- Ix : Operating ripple current (Arms) actually flowing in the capacitor
- Io : Rated ripple current (Arms), frequency compensated, at the upper limit of the category temperature range

To determine more accurate values of ΔT, they can be actually measured using a thermocouple.

2. Rated Ripple Current Frequency Multipliers

Self-heat rise is generated by the ripple current even though the conductive polymer aluminum solid capacitors have low ESR compared to liquid based electrolyte aluminum electrolytic capacitor. The ESR value differs depending on the frequency, thus the degree of self-heat rise differs depending on the ripple current frequency. Therefore, if the actual ripple current frequency differs from the specifications stated in the standard ratings, use the value obtained by multiplying the rated ripple current multiplier to convert the rated current.

Conductive polymer aluminum solid capacitors have super low ESR characteristic in high-frequency range. On the whole, ESR in low-frequency range relatively rises. Therefore, they can use only small ripple current in low-frequency range.

Please ensure that excessive ripple current is not applied to the capacitors in all frequency range.

3. Restriction of estimated lifetime calculation

The result calculated by the estimated lifetime formula, it is not guaranteed lifetime by Nippon Chemi-Con Corporation.

When designer calculate the lifetime of apparatus, please include an ample margin in consideration to the estimated lifetime of a capacitor.

When calculated lifetime result are over 15 years by using the estimated lifetime formula, please consider 15 years to be a maximum in considering that the sealing rubber characteristics vary during the lifetime.

If 15 years or more may be required as an expected lifetime, please consult us.

Product code guide (Conductive polymer Surface mount type)

(Example : PXJ series, 6.3V-390µF, φ6.3×5.8L)



Please refer to the following table

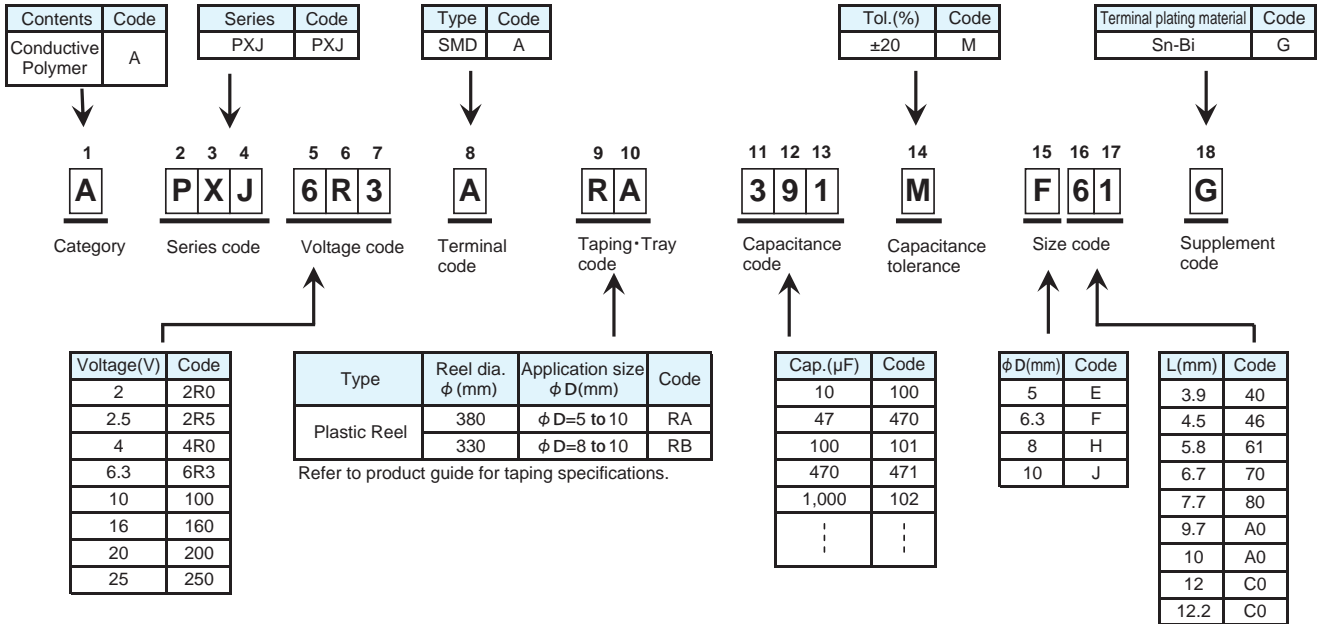

*Refer to the appendix (Part number) for codes not listed here.

Product code guide (Conductive polymer Radial lead type)

(Example : PSK series, 6.3V-330µF, φ5×8L, Long Lead with bulk)

Please refer to the following table

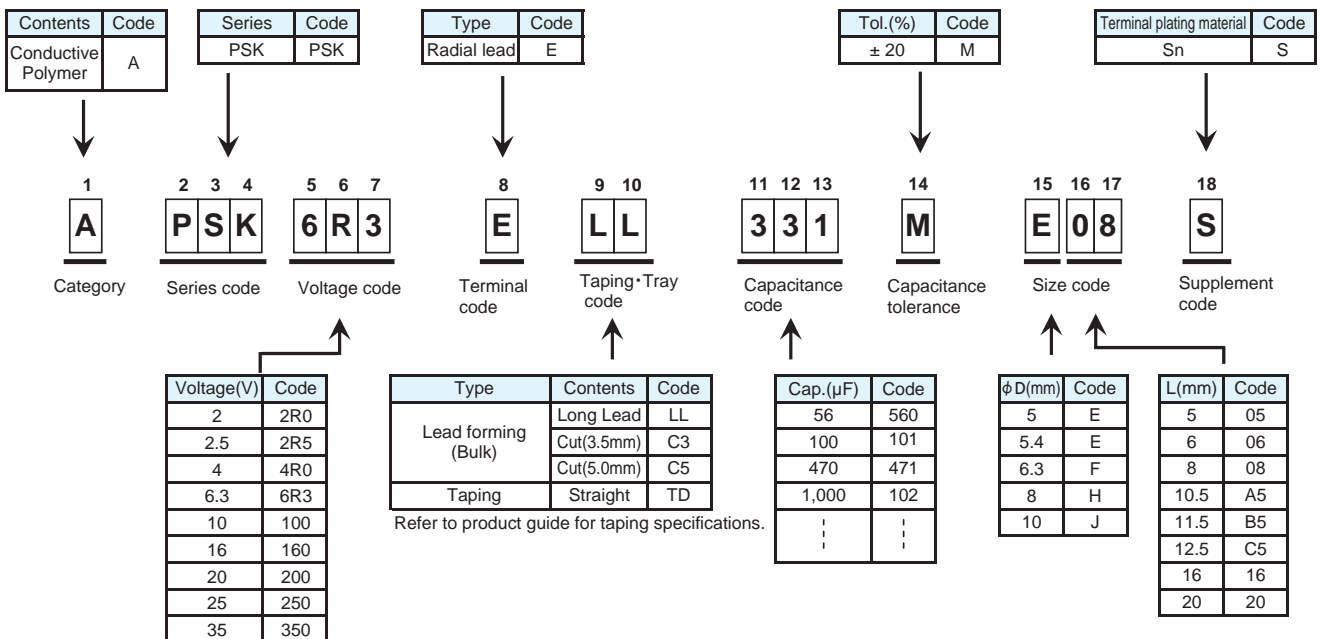

*Refer to the appendix (Part number) for codes not listed here.



CONDUCTIVE POLYMER ALUMINUM SOLID CAPACITORS

Product List

◆SURFACE MOUNT (CHIP) TYPE (2.5 to 6.3V_{dc})

*1 ESR(mΩ max.)20°C, 100k to 300kHz *2 Rated ripple current(mArms)105°C, 100kHz

Cap (μF)	2.5V _{dc}				4V _{dc}				6.3V _{dc}			
	Series	Nominal Case size (φD×L)	ESR*1	Ripple current*2	Series	Nominal Case size (φD×L)	ESR*1	Ripple current*2	Series	Nominal Case size (φD×L)	ESR*1	Ripple current*2
820	PXT	6.3×7.7	22	2850	PXA	10×12.2	10	5500	PXE	8×10	12	4770
	PXJ	6.3×5.8	10	4900					PXE	8×12	10	5150
	PXH	6.3×7.7	7	5000					PXE	10×7.7	14	4300
	PXJ	6.3×7.7	7	5000					PXA	10×12.2	10	5500
	PXJ	6.3×9.7	10	4300								
	PXE	8×7.7	12	4260								
	PXE	8×12	9	5400								
1000	PXJ	6.3×9.7	10	4300	PXE	8×10	10	5220				
	PXF	8×7.7	9	4500	PXE	10×7.7	14	4300				
	PXE	8×7.7	12	4260								
	PXA	10×7.7	19	4240								
	PXH	10×7.7	25	3700								
1200	PXJ	6.3×9.7	10	4300	PXE	8×12	9	5400	PXN	10×7.7	20	3500
	PXJ	8×6.7	10	4500	PXE	10×10	10	5500	PXE	10×10	12	5025
	PXE	10×7.7	13	4450	PXA	10×12.2	10	5500				
	PXE	10×7.7	13	4450								
1500	PXE	8×10	10	5220	PXE	10×10	10	5500	PXE	10×10	12	5025
	PXE	8×12	9	5400					PXE	10×12.2	10	5500
	PXA	10×12.2	10	5500								
1800					PXE	10×10	10	5500				
					PXE	10×12.2	9	5600				
2200	PXE	10×10	10	5500								
2700	PXE	10×12.2	9	5600								

◆SURFACE MOUNT (CHIP) TYPE (16 to 25V_{dc})

Cap (μF)	16V _{dc}				20V _{dc}				23V _{dc}				25V _{dc}							
	Series	Nominal Case size (φD×L)	ESR*1	Ripple current*2	Series	Nominal Case size (φD×L)	ESR*1	Ripple current*2	Series	Nominal Case size (φD×L)	ESR*1	Ripple current*2	Series	Nominal Case size (φD×L)	ESR*1	Ripple current*2				
10													PXG	5×4.5	60	1700				
													PXA	6.3×5.8	65	1500				
15					PXA	6.3×4.5	57	1300	PXA	6.3×4.5	57	1300								
22	PXA	5×5.8	45	1210	PXA	6.3×5.8	50	1650					PXG	5×5.8	40	2450				
	PXA	6.3×4.5	45	1490	PXH	6.3×5.8	60	1650					PXG	6.3×4.5	45	2350				
27													PXA	8×6.7	50	1800				
					PXG	5×4.5	55	1770					PXG	5×5.8	40	2450				
33	PXE	5×5.8	35	2070									PXG	6.3×4.5	45	2350				
	PXA	6.3×5.8	37	2050																
39	PXG	5×4.5	50	1860	PXA	8×6.7	45	2000					PXG	6.3×5.8	30	2800				
	PXS	6.3×5.8	37	2050									PXA	10×7.7	45	2100				
	PXE	5×5.8	35	2070																
	PXA	6.3×5.8	37	2050																
	PXH	6.3×5.8	50	2050																
47					PXG	5×5.8	30	2800					PXG	6.3×5.8	30	2800				
					PXG	6.3×4.5	42	2400												
					PXA	8×6.7	45	2000												
					PXH	8×6.7	45	2000												
56	PXN	5×5.8	35	2000	PXG	5×5.8	30	2800					PXJ	6.3×5.8	28	3000				
68													PXG	6.3×5.8	30	2800				
	PXG	6.3×4.5	40	2450									PXG	6.3×7.7	28	2800				
	PXS	6.3×5.8	30	2200									PXG	6.3×5.8	30	2800				
82	PXE	6.3×5.8	28	2390									PXG	8×6.7	28	3000				
	PXS	8×6.7	30	2760	PXA	10×7.7	40	2500					PXJ	6.3×7.7	28	3040				
PXE	6.3×7.7	24	2700	PXH					10×7.7	45	2400				PXJ	6.3×9.7	28	3000		
PXA	8×6.7	30	2700												PXG	8×7.7	26	3100		
PXH	8×6.7	40	2700																	
100	PXN	6.3×5.8	30	2500									PXG	8×10	24	3300				
	PXT	5×5.8	45	2000																
	PXG	5×5.8	27	3000																
	PXK	6.3×5.8	24	2490																
	PXE	6.3×7.7	24	2700																
	PXE	8×6.7	24	3010																
120	PXS	8×6.7	27	2900	PXG	6.3×5.8	25	3200					PXG	6.3×7.7	28	2800				
	PXE	8×6.7	24	3010									PXJ	8×6.7	38	3200				
													PXG	8×10	22	3500				
150	PXN	8×6.7	25	3300	PXJ	6.3×5.8	23	3300					PXG	8×7.7	28	3000				
	PXE	8×7.7	22	3150	PXJ	6.3×7.7	18	3790					PXG	10×7.7	25	3400				
	PXA	10×7.7	26	3430	PXJ	6.3×9.7	18	3200												
	PXH	10×7.7	35	3020	PXG	6.3×7.7	25	3200												
					PXA	10×12.2	20	4320												
180	PXT	6.3×5.8	40	2200	PXG	8×6.7	25	3200												
	PXG	6.3×5.8	22	3300																
	PXE	8×10	18	3890																
	PXA	8×12	16	4360																
	PXA	10×7.7	26	3430																
	PXH	10×7.7	35	3020																
220	PXJ	6.3×5.8	20	3500	PXJ	8×6.7	28	3300												
	PXG	6.3×7.7	22	3300	PXG	8×7.7	23	3300												
	PXE	8×10	18	3890	PXG	8×10	23	3400												
	PXE	10×7.7	22	3450																
	PXA	10×12.2	14	5050																
270	PXH	6.3×7.7	13	4460																
	PXT	6.3×7.7	22	2850																
	PXJ	6.3×7.7	10	5080																
	PXJ	6.3×7.7	13	4460																
	PXJ	6.3×9.7	16	3500																
	PXG	8×6.7	22	3300																
330	PXN	10×7.7	25	3400																
	PXG	8×6.7	22	3300																
	PXG	8×7.7	21	3400																
	PXG	8×10	21	3400																
	PXE	10×10	16	4350																
	PXA	10×12.2	14	5050																
390	PXJ	8×6.7	25	3600	PXG	8×10	20	3700												
					PXG	10×7.7	22	3650												
560	PXG	8×10	18	3900	PXG	10×10	18	4100												
	PXG	10×7.7	20	3800																
820	PXG	10×10	16	4200																
	PXG	10×12.2	12	5400																
1000	PXG	10×10	18	4100																
	PXG	10×12.2	12	5400																

Product specifications in this catalog are subject to change without notice. Request our product specifications before purchase and/or use. Please use our products based on the information contained in this catalog and product specifications.



CONDUCTIVE POLYMER ALUMINUM SOLID CAPACITORS

Product List

◆RADIAL LEAD TYPE (2 to 10V_{dc})

*1 ESR(mΩ max.)20°C, 100k to 300kHz(PSJ series : 300kHz) *2 Rated ripple current(mArms)105°C, 100kHz

Cap (μF)	2V _{dc}				2.5V _{dc}				4V _{dc}				6.3V _{dc}				10V _{dc}				
	Series	Nominal Case size (φD×L)	ESR* ¹	Ripple current* ²	Series	Nominal Case size (φD×L)	ESR* ¹	Ripple current* ²	Series	Nominal Case size (φD×L)	ESR* ¹	Ripple current* ²	Series	Nominal Case size (φD×L)	ESR* ¹	Ripple current* ²	Series	Nominal Case size (φD×L)	ESR* ¹	Ripple current* ²	
220					PSK	5×8	7	4350													
270													PSK	5×8	10	3700					
330					PSK	5×8	7	4350	PSK	5×8	8	4050	PSK	5×8	8	4050					
					PSF	6.3×8	5	5900													
390					PSJ	5.4×8	4	5600									PSC	8×11.5	9	5650	
470					PSJ	5.4×8	4.5	5200	PSF	6.3×8	5	5900	PSE	6.3×8	8	4700					
					PSK	5×8	7	4350					PSC	8×8	8	5700					
					PSF	6.3×8	5	5900													
560					PSJ	6.3×8	4	6500	PSF	6.3×8	5	5900	PSE	6.3×8	8	4700					
					PSJ	6.3×8	4.5	6200	PSE	6.3×8	7	5000	PSC	8×8	8	5700					
					PSK	5×8	7	4350	PSC	8×8	7	6100									
					PSF	6.3×8	5	5900													
					PSC	8×8	7	6100													
680									PSC	8×11.5	7	6100					PSC	10×11.5	7	6100	
820					PSF	6.3×8	5	5900					PSF	6.3×8	8	4700					
					PSE	6.3×8	7	5000					PSC	10×11.5	7	6640					
					PSC	8×8	5	6100													
					PSC	8×8	7	6100													
1000	PSF	6.3×8	5	5900	PSC	8×8	7	6100	PSC	10×11.5	6	6640									
					PSC	8×11.5	7	6100													
1200					PSF	6.3×8	5	5900													
1500					PSC	8×11.5	7	6100					PSC	10×11.5	10	5560					
1600					PSF	8×8	5	6100													
2700					PSC	10×11.5	8	5560													

◆RADIAL LEAD TYPE (16 to 35V_{dc})

Cap (μF)	16V _{dc}				20V _{dc}				25V _{dc}				35V _{dc}			
	Series	Nominal Case size (φD×L)	ESR* ¹	Ripple current* ²	Series	Nominal Case size (φD×L)	ESR* ¹	Ripple current* ²	Series	Nominal Case size (φD×L)	ESR* ¹	Ripple current* ²	Series	Nominal Case size (φD×L)	ESR* ¹	Ripple current* ²
56									PSG	6.3×5	30	2600				
68													PSG	8×11.5	18	4380
82									PSG	6.3×8	28	2780				
100	PSF	6.3×5	24	2490					PSG	6.3×8	28	2780				
120					PSG	6.3×5	20	3200	PSG	6.3×8	28	2780	PSG	10×11.5	16	4670
150	PSG	6.3×5	20	3200					PSG	6.3×8	28	2780				
180					PSG	6.3×8	18	3460	PSW	6.3×8	28	2780				
									PSG	8×8	18	3770				
									PSG	8×11.5	16	4650				
220									PSG	8×8	18	3770				
									PSG	8×11.5	16	4650				
270	PSG	6.3×8	10	5080					PSG	8×8	18	3770				
	PSG	6.3×8	15	3800					PSG	8×11.5	16	4650				
	PSF	8×8	10	5000												
	PSF	8×11.5	11	5080												
	PSC	8×11.5	11	5080												
330	PSG	6.3×8	10	5080	PSG	8×8	17	3880	PSW	8×8	18	3770				
	PSG	6.3×8	15	3800					PSG	8×11.5	16	4650				
	PSF	8×8	13	4700					PSG	10×11.5	14	5000				
	PSC	10×11.5	10	6100												
	PSC	10×12.5	10	6100												
390					PSG	8×11.5	14	4970	PSG	8×11.5	16	4650				
									PSG	10×11.5	14	5000				
470	PSG	8×8	8	5400					PSW	8×11.5	16	4650				
	PSG	8×8	16	4000					PSG	10×11.5	14	5000				
	PSF	8×11.5	11	5400												
	PSF	10×11.5	10	6100												
	PSC	10×11.5	10	6100												
560	PSG	8×8	8	5400					PSG	8×16	14	5400				
	PSG	8×8	16	4000					PSG	10×11.5	14	5000				
	PSG	8×11.5	8	6100												
	PSG	8×11.5	14	4970												
680	PSG	8×11.5	8	6100	PSG	8×16	10	6260	PSG	10×11.5	14	5000				
	PSG	8×11.5	14	4970	PSG	10×11.5	12	5400								
820	PSG	8×16	8	7000					PSW	10×11.5	14	5000				
	PSG	10×11.5	12	5400												
1000	PSG	8×16	8	7000												
	PSG	8×20	8	7500												
	PSG	10×11.5	12	5400												
1200	PSG	8×20	8	7500												
	PSG	10×11.5	12	5400												
1500	PSG	8×20	8	7500												
	PSG	10×16	8	7700												
1800	PSG	10×16	8	7700												
	PSG	10×20	8	8100												
2200	PSG	10×20	8	8100												
2700	PSG	10×20	8	8100												

Product specifications in this catalog are subject to change without notice. Request our product specifications before purchase and/or use. Please use our products based on the information contained in this catalog and product specifications.

NPCAP™-PXN Series

- Super low ESR, impedance and high heat resistance have been obtained by using conductive polymer as electrolyte.
- High moisture resistance, Bias Humidity: 1,000 hours at 85°C, 85%RH
- Rated voltage range: 2.5 to 16V_{dc}, Capacitance range: 56~1,200μF
- Suitable for DC-DC converters, voltage regulators and decoupling applications used on computer motherboards etc.
- Solvent resistant type (see PRECAUTIONS AND GUIDELINES)
- RoHS2 Compliant
- Halogen Free
- AEC-Q200 compliant : Please contact Chemi-Con for more details, test data, information.

PXN

Higher ripple

PXT



SPECIFICATIONS

Items	Characteristics																				
Category Temperature Range	-55 to +105°C																				
Rated Voltage Range	2.5 to 16V _{dc}																				
Capacitance Tolerance	±20% (M) (at 20°C, 120Hz)																				
Leakage Current *Note	Shall not exceed values shown in STANDARD RATINGS. (at 20°C after 2 minutes)																				
Dissipation Factor (tan δ)	0.12 max. (at 20°C, 120Hz)																				
Low Temperature Characteristics (Max. Impedance Ratio)	Z(-25°C)/Z(+20°C) ≤ 1.15 Z(-55°C)/Z(+20°C) ≤ 1.25 (at 100kHz)																				
Endurance	The following specifications shall be satisfied when the capacitors are restored to 20°C after the rated voltage is applied for 5,000 hours at 105°C. <table border="1"> <tr><td>Appearance</td><td>No significant damage</td></tr> <tr><td>Capacitance change</td><td>≤ ±20% of the initial value</td></tr> <tr><td>D.F. (tan δ)</td><td>≤ 150% of the initial specified value</td></tr> <tr><td>ESR</td><td>≤ 150% of the initial specified value</td></tr> <tr><td>Leakage current</td><td>≤ The initial specified value</td></tr> </table>	Appearance	No significant damage	Capacitance change	≤ ±20% of the initial value	D.F. (tan δ)	≤ 150% of the initial specified value	ESR	≤ 150% of the initial specified value	Leakage current	≤ The initial specified value										
Appearance	No significant damage																				
Capacitance change	≤ ±20% of the initial value																				
D.F. (tan δ)	≤ 150% of the initial specified value																				
ESR	≤ 150% of the initial specified value																				
Leakage current	≤ The initial specified value																				
Bias Humidity	The following specifications shall be satisfied when the capacitors are restored to 20°C after subjecting them to the DC rated voltage at 85°C85% RH for 1,000 hours. <table border="1"> <tr><td>Appearance</td><td>No significant damage</td></tr> <tr><td>Capacitance change</td><td>≤ ±30% of the initial value</td></tr> <tr><td>D.F. (tan δ)</td><td>≤ 200% of the initial specified value</td></tr> <tr><td>ESR</td><td>≤ 200% of the initial specified value</td></tr> <tr><td>Leakage current</td><td>≤ The initial specified value</td></tr> </table>	Appearance	No significant damage	Capacitance change	≤ ±30% of the initial value	D.F. (tan δ)	≤ 200% of the initial specified value	ESR	≤ 200% of the initial specified value	Leakage current	≤ The initial specified value										
Appearance	No significant damage																				
Capacitance change	≤ ±30% of the initial value																				
D.F. (tan δ)	≤ 200% of the initial specified value																				
ESR	≤ 200% of the initial specified value																				
Leakage current	≤ The initial specified value																				
Surge Voltage	The capacitors shall be subjected to 1,000 cycles each consisting of charge with the surge voltage specified at 105°C for 30 seconds through a protective resistor(R=1kΩ) and discharge for 5 minutes 30 seconds. <table border="1"> <tr><td>Rated voltage (V_{dc})</td><td>2.5</td><td>6.3</td><td>10</td><td>16</td></tr> <tr><td>Surge voltage (V_{dc})</td><td>2.9</td><td>7.2</td><td>12</td><td>18</td></tr> </table> <table border="1"> <tr><td>Appearance</td><td>No significant damage</td></tr> <tr><td>Capacitance change</td><td>≤ ±20% of the initial value</td></tr> <tr><td>D.F. (tan δ)</td><td>≤ 150% of the initial specified value</td></tr> <tr><td>ESR</td><td>≤ 150% of the initial specified value</td></tr> <tr><td>Leakage current</td><td>≤ The initial specified value</td></tr> </table>	Rated voltage (V _{dc})	2.5	6.3	10	16	Surge voltage (V _{dc})	2.9	7.2	12	18	Appearance	No significant damage	Capacitance change	≤ ±20% of the initial value	D.F. (tan δ)	≤ 150% of the initial specified value	ESR	≤ 150% of the initial specified value	Leakage current	≤ The initial specified value
Rated voltage (V _{dc})	2.5	6.3	10	16																	
Surge voltage (V _{dc})	2.9	7.2	12	18																	
Appearance	No significant damage																				
Capacitance change	≤ ±20% of the initial value																				
D.F. (tan δ)	≤ 150% of the initial specified value																				
ESR	≤ 150% of the initial specified value																				
Leakage current	≤ The initial specified value																				
Soldering Heat	The following specifications shall be satisfied when the solder temperature is reduced back to 20°C after soldering has been performed under the recommended soldering conditions. <table border="1"> <tr><td>Appearance</td><td>No significant damage</td></tr> <tr><td>Capacitance value</td><td>Within the specified tolerance range</td></tr> <tr><td>D.F. (tan δ)</td><td>≤ The initial specified value</td></tr> <tr><td>ESR</td><td>≤ The initial specified value</td></tr> <tr><td>Leakage current</td><td>≤ The initial specified value (Voltage treatment)</td></tr> </table>	Appearance	No significant damage	Capacitance value	Within the specified tolerance range	D.F. (tan δ)	≤ The initial specified value	ESR	≤ The initial specified value	Leakage current	≤ The initial specified value (Voltage treatment)										
Appearance	No significant damage																				
Capacitance value	Within the specified tolerance range																				
D.F. (tan δ)	≤ The initial specified value																				
ESR	≤ The initial specified value																				
Leakage current	≤ The initial specified value (Voltage treatment)																				

*Note : If any doubt arises, measure the leakage current after the following voltage treatment.
Voltage treatment : DC rated voltage is applied to the capacitors for 120 minutes at 105°C.

DIMENSIONS [mm]

Terminal Code : A

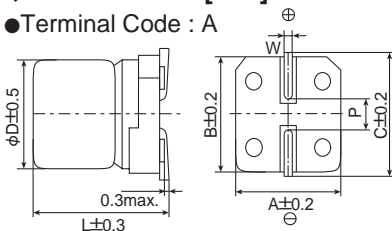

Size Code	φD	L	A	B	C	W	P
E61	5	5.8	5.3	5.3	5.9	0.5 to 0.8	1.4
F61	6.3	5.8	6.6	6.6	7.2	0.5 to 0.8	1.9
H70	8	6.7	8.3	8.3	9.0	0.7 to 1.1	3.1
J80	10	7.7	10.3	10.3	11.0	0.7 to 1.1	4.5

MARKING

EX) 6.3V220μF



PXN series is a conductive polymer aluminum solid capacitor. All conductive polymer aluminum solid capacitors, including the PXN series may temporarily exhibit increased leakage current due to heat stress during the reflow soldering process. However, applying stepped voltage under the category temperature range gradually decreases the increased leakage current to normal levels. The speed or recovery time that leakage current decreases by self-healing depends on the temperature and voltage: (The closer to category upper limit temperature and rated voltage, the more rapid the leakage current decrease). Conductive polymer aluminum solid capacitors do not utilize liquid electrolyte. Therefore it takes a longer period of time to accomplish self-healing than aluminum electrolytic capacitors that have liquid electrolyte impregnation.



NPCAP™-PXN Series

◆PART NUMBERING SYSTEM

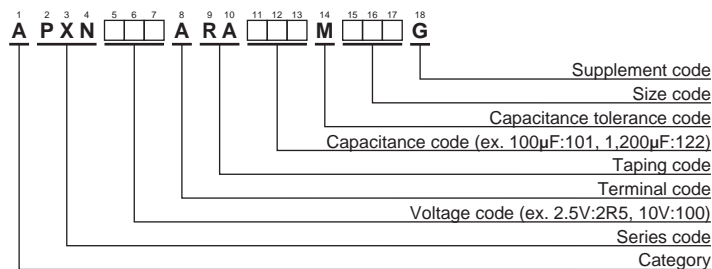

Please refer to "Product code guide (conductive polymer type)"

◆STANDARD RATINGS

WV (V _{dc})	Cap (μF)	Size code	Leakage current (μA max./after 2min.)	ESR (mΩ max./20°C, 100k to 300kHz)	Rated ripple current (mArms/105°C, 100kHz)	Part No.
2.5	330	E61	700	30	2,500	APXN2R5ARA331ME61G
	560	F61	700	25	2,800	APXN2R5ARA561MF61G
6.3	220	E61	700	30	2,500	APXN6R3ARA221ME61G
	330	F61	700	25	2,800	APXN6R3ARA331MF61G
	560	H70	705	20	3,500	APXN6R3ARA561MH70G
	1,200	J80	1,510	20	3,500	APXN6R3ARA122MJ80G
10	120	E61	700	35	2,000	APXN100ARA121ME61G
	180	F61	700	30	2,500	APXN100ARA181MF61G
	270	H70	700	25	3,300	APXN100ARA271MH70G
	560	J80	1,120	25	3,400	APXN100ARA561MJ80G
16	56	E61	700	35	2,000	APXN160ARA560ME61G
	100	F61	700	30	2,500	APXN160ARA101MF61G
	150	H70	700	25	3,300	APXN160ARA151MH70G
	330	J80	1,050	25	3,400	APXN160ARA331MJ80G

◆RATED RIPPLE CURRENT MULTIPLIERS

● Frequency Multipliers

Frequency(Hz)	120	1k	10k	50k	100k to 500k
SMD type	0.05	0.30	0.55	0.70	1.00

PXN series is a conductive polymer aluminum solid capacitor. All conductive polymer aluminum solid capacitors, including the PXN series may temporarily exhibit increased leakage current due to heat stress during the reflow soldering process. However, applying stepped voltage under the category temperature range gradually decreases the increased leakage current to normal levels. The speed or recovery time that leakage current decreases by self-healing depends on the temperature and voltage: (The closer to category upper limit temperature and rated voltage, the more rapid the leakage current decrease). Conductive polymer aluminum solid capacitors do not utilize liquid electrolyte. Therefore it takes a longer period of time to accomplish self-healing than aluminum electrolytic capacitors that have liquid electrolyte impregnation.

NPCAP™-PXT Series

- Super low ESR, impedance and high heat resistance have been obtained by using conductive polymer as electrolyte.
- High moisture resistance, Bias Humidity: 1,000 hours at 85°C, 85%RH
- Rated voltage range: 2.5 to 16V_{dc}, Capacitance range: 100 to 820μF
- Case size range : φ 5x5.8L to φ 6.3x7.7L
- Suitable for DC-DC converters, voltage regulators and decoupling applications used on computer motherboards etc.
- Solvent resistant type (see PRECAUTIONS AND GUIDELINES)
- RoHS2 Compliant
- Halogen Free

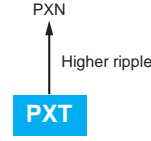

◆ SPECIFICATIONS

Items	Characteristics
Category	-55 to +105°C
Temperature Range	-55 to +105°C
Rated Voltage Range	2.5 to 16V _{dc}
Capacitance Tolerance	±20% (M) (at 20°C, 120Hz)
Leakage Current *Note	Shall not exceed values shown in STANDARD RATINGS. (at 20°C after 2 minutes)
Dissipation Factor (tan δ)	0.12 max. (at 20°C, 120Hz)
Low Temperature Characteristics (Max. Impedance Ratio)	Z(-25°C)/Z(+20°C) ≤ 1.15 Z(-55°C)/Z(+20°C) ≤ 1.25 (at 100kHz)
Endurance	The following specifications shall be satisfied when the capacitors are restored to 20°C after the rated voltage is applied for 15,000 hours at 105°C.
Appearance	No significant damage
Capacitance change	≤ ±20% of the initial value
D.F. (tan δ)	≤ 150% of the initial specified value
ESR	≤ 150% of the initial specified value
Leakage current	≤ The initial specified value
Bias Humidity	The following specifications shall be satisfied when the capacitors are restored to 20°C after subjecting them to the DC rated voltage at 85°C 85% RH for 1,000 hours.
Appearance	No significant damage
Capacitance change	≤ ±30% of the initial value
D.F. (tan δ)	≤ 200% of the initial specified value
ESR	≤ 200% of the initial specified value
Leakage current	≤ The initial specified value
Surge Voltage	The capacitors shall be subjected to 1,000 cycles each consisting of charge with the surge voltage specified at 105°C for 30 seconds through a protective resistor(R=1kΩ) and discharge for 5 minutes 30 seconds.
Rated voltage (V _{dc})	2.5 4.0 6.3 10 16
Surge voltage (V _{dc})	2.9 4.6 7.2 12 18
Appearance	No significant damage
Capacitance change	≤ ±20% of the initial value
D.F. (tan δ)	≤ 150% of the initial specified value
ESR	≤ 150% of the initial specified value
Leakage current	≤ The initial specified value
Soldering Heat	The following specifications shall be satisfied when the solder temperature is reduced back to 20°C after soldering has been performed under the recommended soldering conditions.
Appearance	No significant damage
Capacitance value	Within the specified tolerance range
D.F. (tan δ)	≤ The initial specified value
ESR	≤ The initial specified value
Leakage current	≤ The initial specified value (Voltage treatment)

*Note : If any doubt arises, measure the leakage current after the following voltage treatment.
Voltage treatment : DC rated voltage is applied to the capacitors for 120 minutes at 105°C.

◆ DIMENSIONS [mm]

- Terminal Code : A

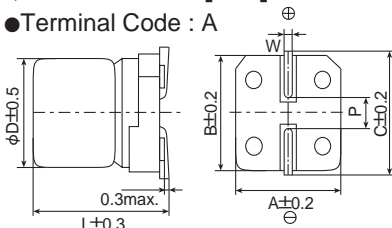

Size Code	φD	L	A	B	C	W	P
E61	5	5.8	5.3	5.3	5.9	0.5 to 0.8	1.4
F61	6.3	5.8	6.6	6.6	7.2	0.5 to 0.8	1.9
F80	6.3	7.7	6.6	6.6	7.2	0.5 to 0.8	1.9

◆ MARKING

EX) 2.5V390μF





NPCAP™-PXT Series

◆PART NUMBERING SYSTEM

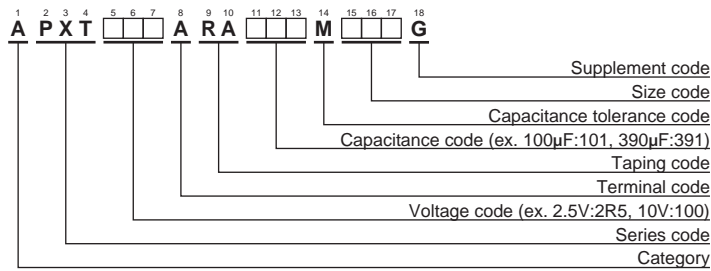

Please refer to "Product code guide (conductive polymer type)"

◆STANDARD RATINGS

WV (V _{dc})	Cap (µF)	Size code	Leakage current (µA max./after 2min.)	ESR (mΩ max./20°C, 100k to 300kHz)	Rated ripple current (µArms/105°C, 100kHz)	Part No.
2.5	330	E61	700	26	2,350	APXT2R5ARA331ME61G
	390	E61	700	26	2,350	APXT2R5ARA391ME61G
	390	F61	700	26	2,600	APXT2R5ARA391MF61G
	560	F61	700	26	2,600	APXT2R5ARA561MF61G
	820	F80	1,020	22	2,850	APXT2R5ARA821MF80G
4	270	E61	700	26	2,350	APXT4R0ARA271ME61G
	330	F61	700	26	2,600	APXT4R0ARA331MF61G
	390	F61	780	26	2,600	APXT4R0ARA391MF61G
	680	F80	1,360	22	2,850	APXT4R0ARA681MF80G
6.3	150	E61	700	26	2,350	APXT6R3ARA151ME61G
	220	E61	700	26	2,350	APXT6R3ARA221ME61G
	220	F61	700	26	2,600	APXT6R3ARA221MF61G
	330	F61	1,030	26	2,600	APXT6R3ARA331MF61G
	560	F80	1,760	22	2,850	APXT6R3ARA561MF80G
10	120	E61	700	45	2,000	APXT100ARA121ME61G
	220	F61	1,100	40	2,200	APXT100ARA221MF61G
	390	F80	1,950	22	2,850	APXT100ARA391MF80G
16	100	E61	800	45	2,000	APXT160ARA101ME61G
	180	F61	1,440	40	2,200	APXT160ARA181MF61G
	270	F80	2,160	22	2,850	APXT160ARA271MF80G

◆RATED RIPPLE CURRENT MULTIPLIERS

● Frequency Multipliers

Frequency(Hz)	120	1k	10k	50k	100k to 500k
SMD type	0.05	0.30	0.55	0.70	1.00



NPCAP™-PXJ Series

- Super low ESR, impedance and high heat resistance have been obtained by using conductive polymer as electrolyte.
- Rated voltage range : 2.5 to 25V_{dc}, Capacitance range : 56 to 1,200μF
- Case size range : φ 6.3×5.8L to φ 8×6.7L
- Suitable for DC-DC converters, voltage regulators and decoupling applications used on computer motherboards etc.
- Solvent resistant type (see PRECAUTIONS AND GUIDELINES)
- RoHS2 Compliant
- Halogen Free

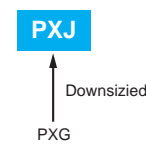

◆ SPECIFICATIONS

Items	Characteristics														
Category	-55 to +105°C														
Temperature Range															
Rated Voltage Range	2.5 to 25V _{dc}														
Capacitance Tolerance	±20% (M) (at 20°C, 120Hz)														
Leakage Current *Note	Shall not exceed values shown in STANDARD RATINGS. (at 20°C after 2 minutes)														
Dissipation Factor (tan δ)	0.12 max. (at 20°C, 120Hz)														
Low Temperature Characteristics (Max. Impedance Ratio)	Z(-25°C)/Z(+20°C) ≤ 1.15 Z(-55°C)/Z(+20°C) ≤ 1.25 (at 100kHz)														
Endurance	The following specifications shall be satisfied when the capacitors are restored to 20°C after the rated voltage is applied for 15,000 hours at 105°C.														
	<table border="1"> <tr><td>Appearance</td><td>No significant damage</td></tr> <tr><td>Capacitance change</td><td>≤ ±20% of the initial value</td></tr> <tr><td>D.F. (tan δ)</td><td>≤ 150% of the initial specified value</td></tr> <tr><td>ESR</td><td>≤ 150% of the initial specified value</td></tr> <tr><td>Leakage current</td><td>≤ The initial specified value</td></tr> </table>	Appearance	No significant damage	Capacitance change	≤ ±20% of the initial value	D.F. (tan δ)	≤ 150% of the initial specified value	ESR	≤ 150% of the initial specified value	Leakage current	≤ The initial specified value				
Appearance	No significant damage														
Capacitance change	≤ ±20% of the initial value														
D.F. (tan δ)	≤ 150% of the initial specified value														
ESR	≤ 150% of the initial specified value														
Leakage current	≤ The initial specified value														
Bias Humidity	The following specifications shall be satisfied when the capacitors are restored to 20°C after subjecting them to the DC rated voltage at 60°C, 90 to 95% RH for 1,000 hours.														
	<table border="1"> <tr><td>Appearance</td><td>No significant damage</td></tr> <tr><td>Capacitance change</td><td>≤ ±20% of the initial value</td></tr> <tr><td>D.F. (tan δ)</td><td>≤ 150% of the initial specified value</td></tr> <tr><td>ESR</td><td>≤ 150% of the initial specified value</td></tr> <tr><td>Leakage current</td><td>≤ The initial specified value</td></tr> </table>	Appearance	No significant damage	Capacitance change	≤ ±20% of the initial value	D.F. (tan δ)	≤ 150% of the initial specified value	ESR	≤ 150% of the initial specified value	Leakage current	≤ The initial specified value				
Appearance	No significant damage														
Capacitance change	≤ ±20% of the initial value														
D.F. (tan δ)	≤ 150% of the initial specified value														
ESR	≤ 150% of the initial specified value														
Leakage current	≤ The initial specified value														
Surge Voltage	The capacitors shall be subjected to 1,000 cycles each consisting of charge with the surge voltage specified at 105°C for 30 seconds through a protective resistor(R=1kΩ) and discharge for 5 minutes 30 seconds.														
	<table border="1"> <tr> <td>Rated voltage (V_{dc})</td> <td>2.5</td> <td>6.3</td> <td>10</td> <td>16</td> <td>20</td> <td>25</td> </tr> <tr> <td>Surge voltage (V_{dc})</td> <td>2.9</td> <td>7.2</td> <td>12</td> <td>18</td> <td>23</td> <td>29</td> </tr> </table>	Rated voltage (V _{dc})	2.5	6.3	10	16	20	25	Surge voltage (V _{dc})	2.9	7.2	12	18	23	29
Rated voltage (V _{dc})	2.5	6.3	10	16	20	25									
Surge voltage (V _{dc})	2.9	7.2	12	18	23	29									
	<table border="1"> <tr><td>Appearance</td><td>No significant damage</td></tr> <tr><td>Capacitance change</td><td>≤ ±20% of the initial value</td></tr> <tr><td>D.F. (tan δ)</td><td>≤ 150% of the initial specified value</td></tr> <tr><td>ESR</td><td>≤ 150% of the initial specified value</td></tr> <tr><td>Leakage current</td><td>≤ The initial specified value</td></tr> </table>	Appearance	No significant damage	Capacitance change	≤ ±20% of the initial value	D.F. (tan δ)	≤ 150% of the initial specified value	ESR	≤ 150% of the initial specified value	Leakage current	≤ The initial specified value				
Appearance	No significant damage														
Capacitance change	≤ ±20% of the initial value														
D.F. (tan δ)	≤ 150% of the initial specified value														
ESR	≤ 150% of the initial specified value														
Leakage current	≤ The initial specified value														
Soldering Heat	The following specifications shall be satisfied when the solder temperature is reduced back to 20°C after soldering has been performed under the recommended soldering conditions.														
	<table border="1"> <tr><td>Appearance</td><td>No significant damage</td></tr> <tr><td>Capacitance value</td><td>Within the specified tolerance range</td></tr> <tr><td>D.F. (tan δ)</td><td>≤ The initial specified value</td></tr> <tr><td>ESR</td><td>≤ The initial specified value</td></tr> <tr><td>Leakage current</td><td>≤ The initial specified value (Voltage treatment)</td></tr> </table>	Appearance	No significant damage	Capacitance value	Within the specified tolerance range	D.F. (tan δ)	≤ The initial specified value	ESR	≤ The initial specified value	Leakage current	≤ The initial specified value (Voltage treatment)				
Appearance	No significant damage														
Capacitance value	Within the specified tolerance range														
D.F. (tan δ)	≤ The initial specified value														
ESR	≤ The initial specified value														
Leakage current	≤ The initial specified value (Voltage treatment)														

*Note : If any doubt arises, measure the leakage current after the following voltage treatment.
Voltage treatment : DC rated voltage is applied to the capacitors for 120 minutes at 105°C.

◆ DIMENSIONS [mm]

● Terminal Code : A

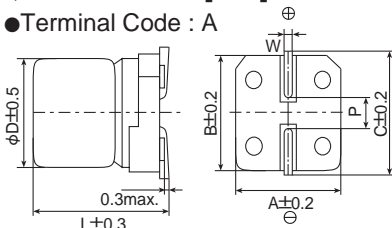

Size Code	φD	L	A	B	C	W	P
F61	6.3	5.8	6.6	6.6	7.2	0.5 to 0.8	1.9
F80	6.3	7.7	6.6	6.6	7.2	0.5 to 0.8	1.9
FA0	6.3	9.7	6.6	6.6	7.2	0.5 to 0.8	1.9
H70	8	6.7	8.3	8.3	9.0	0.7 to 1.1	3.1

◆ MARKING

EX) 2.5V820μF

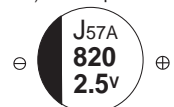

NPCAP™-PXJ Series

◆PART NUMBERING SYSTEM

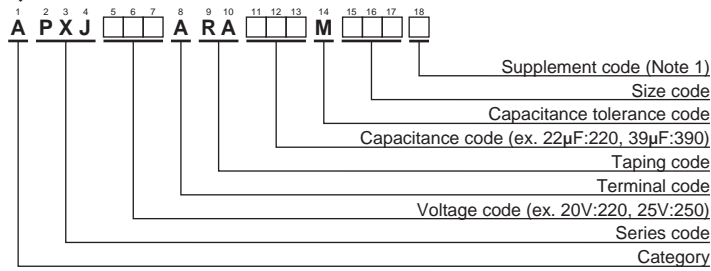

Please refer to "Product code guide (conductive polymer type)"

(Note1) :PXJ series, 16V270 μ F (Rated ripple current 5,080mArms) have supplement code "J". Terminal and terminal plating are the same as all other in PXJ series.

◆STANDARD RATINGS

WV (V _{dc})	Cap (μ F)	Size code	Leakage current (μ A max./after 2min.)	ESR (m Ω max./20°C, 100k to 300kHz)	Rated ripple current (mArms/105°C, 100kHz)	Part No.
2.5	820	F61	1,020	10	4,900	APXJ2R5ARA821MF61G
	820	F80	1,020	7	5,000	APXJ2R5ARA821MF80G
	820	FA0	1,020	10	4,300	APXJ2R5ARA821MFA0G
	1,000	FA0	1,250	10	4,300	APXJ2R5ARA102MFA0G
	1,200	FA0	1,500	10	4,300	APXJ2R5ARA122MFA0G
	1,200	H70	1,500	10	4,500	APXJ2R5ARA122MH70G
6.3	390	F61	1,220	10	4,900	APXJ6R3ARA391MF61G
	560	F80	1,760	8	5,000	APXJ6R3ARA561MF80G
	560	FA0	1,760	10	4,300	APXJ6R3ARA561MFA0G
	680	H70	2,140	10	4,500	APXJ6R3ARA681MH70G
10	270	F61	1,350	15	4,000	APXJ100ARA271MF61G
	390	F80	1,950	13	4,460	APXJ100ARA391MF80G
	390	FA0	1,950	13	4,000	APXJ100ARA391MFA0G
	470	H70	2,350	15	4,000	APXJ100ARA471MH70G
16	220	F61	704	20	3,500	APXJ160ARA221MF61G
	270	F80	864	10	5,080	APXJ160ARA271MF80J
	270	F80	864	13	4,460	APXJ160ARA271MF80G
	270	FA0	864	16	3,500	APXJ160ARA271MFA0G
	390	H70	1,240	25	3,600	APXJ160ARA391MH70G
20	150	F61	600	23	3,300	APXJ200ARA151MF61G
	150	F80	600	18	3,790	APXJ200ARA151MF80G
	150	FA0	600	18	3,200	APXJ200ARA151MFA0G
	220	H70	880	28	3,300	APXJ200ARA221MH70G
25	56	F61	280	28	3,000	APXJ250ARA560MF61G
	82	F80	410	28	3,040	APXJ250ARA820MF80G
	82	FA0	410	28	3,000	APXJ250ARA820MFA0G
	120	H70	600	38	3,200	APXJ250ARA121MH70G

Production of the products shown in is scheduled to be discontinued.

◆RATED RIPPLE CURRENT MULTIPLIERS

● Frequency Multipliers

Frequency(Hz)	120	1k	10k	50k	100k to 500k
SMD type	0.05	0.30	0.55	0.70	1.00

NPCAP™-PXG Series *Upgrade!*

- Super low ESR, high ripple current capability
- Rated voltage range : 16 to 25V_{dc}, Capacitance range : 10 to 1,000μF
- Case size : φ 5×4.5L to φ 10×12.2L
- Solvent resistant type (see PRECAUTIONS AND GUIDELINES)
- RoHS2 Compliant
- Halogen Free

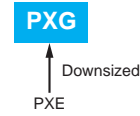

◆ SPECIFICATIONS

Items	Characteristics																		
Category																			
Temperature Range	-55 to +105°C																		
Rated Voltage Range	16 to 25V _{dc}																		
Capacitance Tolerance	±20% (M) (at 20°C, 120Hz)																		
Leakage Current <small>*Note</small>	Shall not exceed values shown in STANDARD RATINGS. (at 20°C after 2 minutes)																		
Dissipation Factor (tan δ)	0.12 max. (at 20°C, 120Hz)																		
Low Temperature Characteristics (Max. Impedance Ratio)	Z(-25°C)/Z(+20°C) ≤ 1.15 Z(-55°C)/Z(+20°C) ≤ 1.25 (at 100kHz)																		
Endurance	The following specifications shall be satisfied when the capacitors are restored to 20°C after the rated voltage is applied for 15,000 hours (E46,F46 : 3,000 hours) at 105°C. <table border="1" style="width:100%"> <tr><td>Appearance</td><td>No significant damage</td></tr> <tr><td>Capacitance change</td><td>≤ ±20% of the initial value</td></tr> <tr><td>D.F. (tan δ)</td><td>≤ 150% of the initial specified value</td></tr> <tr><td>ESR</td><td>≤ 150% of the initial specified value</td></tr> <tr><td>Leakage current</td><td>≤ The initial specified value</td></tr> </table>	Appearance	No significant damage	Capacitance change	≤ ±20% of the initial value	D.F. (tan δ)	≤ 150% of the initial specified value	ESR	≤ 150% of the initial specified value	Leakage current	≤ The initial specified value								
Appearance	No significant damage																		
Capacitance change	≤ ±20% of the initial value																		
D.F. (tan δ)	≤ 150% of the initial specified value																		
ESR	≤ 150% of the initial specified value																		
Leakage current	≤ The initial specified value																		
Bias Humidity	The following specifications shall be satisfied when the capacitors are restored to 20°C after subjecting them to the DC rated voltage at 60°C, 90 to 95% RH for 1,000 hours (E46,F46 : 500 hours). <table border="1" style="width:100%"> <tr><td>Appearance</td><td>No significant damage</td></tr> <tr><td>Capacitance change</td><td>≤ ±20% of the initial value</td></tr> <tr><td>D.F. (tan δ)</td><td>≤ 150% of the initial specified value</td></tr> <tr><td>ESR</td><td>≤ 150% of the initial specified value</td></tr> <tr><td>Leakage current</td><td>≤ The initial specified value</td></tr> </table>	Appearance	No significant damage	Capacitance change	≤ ±20% of the initial value	D.F. (tan δ)	≤ 150% of the initial specified value	ESR	≤ 150% of the initial specified value	Leakage current	≤ The initial specified value								
Appearance	No significant damage																		
Capacitance change	≤ ±20% of the initial value																		
D.F. (tan δ)	≤ 150% of the initial specified value																		
ESR	≤ 150% of the initial specified value																		
Leakage current	≤ The initial specified value																		
Surge Voltage	The capacitors shall be subjected to 1,000 cycles each consisting of charge with the surge voltage specified at 105°C for 30 seconds through a protective resistor(R=1kΩ) and discharge for 5 minutes 30 seconds. <table border="1" style="width:100%"> <tr><td>Rated voltage (V_{dc})</td><td>16</td><td>20</td><td>25</td></tr> <tr><td>Surge voltage (V_{dc})</td><td>18</td><td>23</td><td>29</td></tr> </table> <table border="1" style="width:100%"> <tr><td>Appearance</td><td>No significant damage</td></tr> <tr><td>Capacitance change</td><td>≤ ±20% of the initial value</td></tr> <tr><td>D.F. (tan δ)</td><td>≤ 150% of the initial specified value</td></tr> <tr><td>ESR</td><td>≤ 150% of the initial specified value</td></tr> <tr><td>Leakage current</td><td>≤ The initial specified value</td></tr> </table>	Rated voltage (V _{dc})	16	20	25	Surge voltage (V _{dc})	18	23	29	Appearance	No significant damage	Capacitance change	≤ ±20% of the initial value	D.F. (tan δ)	≤ 150% of the initial specified value	ESR	≤ 150% of the initial specified value	Leakage current	≤ The initial specified value
Rated voltage (V _{dc})	16	20	25																
Surge voltage (V _{dc})	18	23	29																
Appearance	No significant damage																		
Capacitance change	≤ ±20% of the initial value																		
D.F. (tan δ)	≤ 150% of the initial specified value																		
ESR	≤ 150% of the initial specified value																		
Leakage current	≤ The initial specified value																		
Soldering Heat	The following specifications shall be satisfied when the solder temperature is reduced back to 20°C after soldering has been performed under the recommended soldering conditions. <table border="1" style="width:100%"> <tr><td>Appearance</td><td>No significant damage</td></tr> <tr><td>Capacitance value</td><td>Within the specified tolerance range</td></tr> <tr><td>D.F. (tan δ)</td><td>≤ The initial specified value</td></tr> <tr><td>ESR</td><td>≤ The initial specified value</td></tr> <tr><td>Leakage current</td><td>≤ The initial specified value (Voltage treatment)</td></tr> </table>	Appearance	No significant damage	Capacitance value	Within the specified tolerance range	D.F. (tan δ)	≤ The initial specified value	ESR	≤ The initial specified value	Leakage current	≤ The initial specified value (Voltage treatment)								
Appearance	No significant damage																		
Capacitance value	Within the specified tolerance range																		
D.F. (tan δ)	≤ The initial specified value																		
ESR	≤ The initial specified value																		
Leakage current	≤ The initial specified value (Voltage treatment)																		

*Note : If any doubt arises, measure the leakage current after the following voltage treatment.
Voltage treatment : DC rated voltage is applied to the capacitors for 120 minutes at 105°C.

◆ DIMENSIONS [mm]

● Terminal Code : A

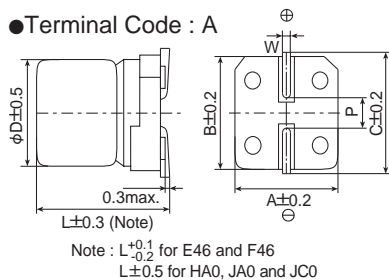

Size Code	φD	L	A	B	C	W	P
E46	5	4.5	5.3	5.3	5.9	0.5 to 0.8	1.4
E61	5	5.8	5.3	5.3	5.9	0.5 to 0.8	1.4
F46	6.3	4.5	6.6	6.6	7.2	0.5 to 0.8	1.9
F61	6.3	5.8	6.6	6.6	7.2	0.5 to 0.8	1.9
F80	6.3	7.7	6.6	6.6	7.2	0.5 to 0.8	1.9
H70	8	6.7	8.3	8.3	9.0	0.7 to 1.1	3.1
H80	8	7.7	8.3	8.3	9.0	0.7 to 1.1	3.1
HA0	8	10.0	8.3	8.3	9.0	0.7 to 1.1	3.1
J80	10	7.7	10.3	10.3	11.0	0.7 to 1.1	4.5
JA0	10	10.0	10.3	10.3	11.0	0.7 to 1.1	4.5
JC0	10	12.2	10.3	10.3	11.0	0.7 to 1.1	4.5

◆ MARKING

EX) 25V47μF





NPCAP™-PXG Series Upgrade!

◆PART NUMBERING SYSTEM

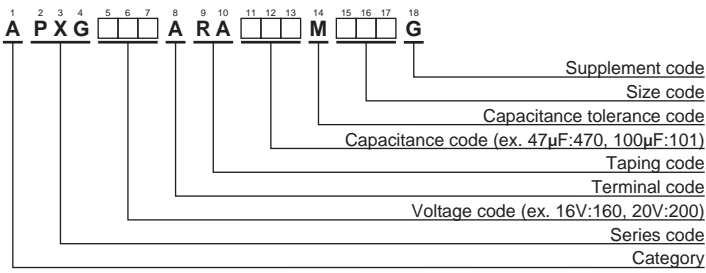

Please refer to "Product code guide (conductive polymer type)"

◆STANDARD RATINGS

WV (V _{dc})	Cap (µF)	Size code	Leakage current (µA max./after 2min.)	ESR (mΩ max./20°C, 100k to 300kHz)	Rated ripple current (mA rms/105°C, 100kHz)	Part No.
16	39	E46	312	50	1,860	APXG160ARA390ME46G
	68	F46	544	40	2,450	APXG160ARA680MF46G
	100	E61	320	27	3,000	APXG160ARA101ME61G
	180	F61	576	22	3,300	APXG160ARA181MF61G
	220	F80	704	22	3,300	APXG160ARA221MF80G
	270	H70	864	22	3,300	APXG160ARA271MH70G
	330	H70	1,050	22	3,300	APXG160ARA331MH70G
	330	H80	1,050	21	3,400	APXG160ARA331MH80G
	330	HA0	1,050	21	3,400	APXG160ARA331MHA0G
	560	HA0	1,790	18	3,900	APXG160ARA561MHA0G
	560	J80	1,790	20	3,800	APXG160ARA561MJ80G
	820	JA0	2,620	16	4,200	APXG160ARA821MJA0G
	820	JC0	2,620	12	5,400	APXG160ARA821MJC0G
1,000	JA0	3,200	18	4,100	APXG160ARA102MJA0G	
1,000	JC0	3,200	12	5,400	APXG160ARA102MJC0G	
20	27	E46	270	55	1,770	APXG200ARA270ME46G
	47	E61	188	30	2,800	APXG200ARA470ME61G
	47	F46	470	42	2,400	APXG200ARA470MF46G
	56	E61	224	30	2,800	APXG200ARA560ME61G
	120	F61	480	25	3,200	APXG200ARA121MF61G
	150	F80	600	25	3,200	APXG200ARA151MF80G
	180	H70	720	25	3,200	APXG200ARA181MH70G
	220	H80	880	23	3,300	APXG200ARA221MH80G
	220	HA0	880	23	3,400	APXG200ARA221MHA0G
	390	HA0	1,560	20	3,700	APXG200ARA391MHA0G
	390	J80	1,560	22	3,650	APXG200ARA391MJ80G
	560	JA0	2,240	18	4,100	APXG200ARA561MJA0G
	25	10	E46	125	60	1,700
22		E61	110	40	2,450	APXG250ARA220ME61G
22		F46	275	45	2,350	APXG250ARA220MF46G
27		E61	135	40	2,450	APXG250ARA270ME61G
27		F46	337	45	2,350	APXG250ARA270MF46G
39		F61	195	30	2,800	APXG250ARA390MF61G
47		F61	235	30	2,800	APXG250ARA470MF61G
56		F61	280	30	2,800	APXG250ARA560MF61G
56		F80	280	28	2,800	APXG250ARA560MF80G
68		F61	340	30	2,800	APXG250ARA680MF61G
68		H70	340	28	3,000	APXG250ARA680MH70G
82		H80	410	26	3,100	APXG250ARA820MH80G
100		HA0	500	24	3,300	APXG250ARA101MHA0G
120		F80	600	28	2,800	APXG250ARA121MF80G
120		HA0	600	22	3,500	APXG250ARA121MHA0G
150		H70	750	28	3,000	APXG250ARA151MH70G
150		J80	750	25	3,400	APXG250ARA151MJ80G
180	J80	900	25	3,400	APXG250ARA181MJ80G	
220	JA0	1,100	20	3,800	APXG250ARA221MJA0G	

Production of the products shown in is scheduled to be discontinued.

◆RATED RIPPLE CURRENT MULTIPLIERS

● Frequency Multipliers

Frequency (Hz)	120	1k	10k	50k	100k to 500k
SMD type	0.05	0.30	0.55	0.70	1.00



NPCAP™-P XK Series

- Super low ESR, impedance and high heat resistance have been obtained by using conductive polymer as electrolyte.
- Rated voltage range : 2.5 to 16V_{dc}, Capacitance range : 100 to 560μF
- Suitable for DC-DC converters, voltage regulators and decoupling applications used to computer motherboards etc.
- Solvent resistant type (see PRECAUTIONS AND GUIDELINES)
- RoHS2 Compliant
- Halogen Free

PXK

↑ Downsized
PXE



◆ SPECIFICATIONS

Items	Characteristics										
Category											
Temperature Range	-55 to +105°C										
Rated Voltage Range	2.5 to 16V _{dc}										
Capacitance Tolerance	±20% (M) (at 20°C, 120Hz)										
Leakage Current *Note	Shall not exceed values shown in STANDARD RATINGS. (at 20°C after 2 minutes)										
Dissipation Factor (tan δ)	0.12 max. (at 20°C, 120Hz)										
Low Temperature Characteristics (Max. Impedance Ratio)	Z(-25°C)/Z(+20°C) ≤ 1.15 Z(-55°C)/Z(+20°C) ≤ 1.25 (at 100kHz)										
Endurance	The following specifications shall be satisfied when the capacitors are restored to 20°C after the rated voltage is applied for 15,000 hours (F46 : 3,000 hours) at 105°C.										
	<table border="1"> <tr><td>Appearance</td><td>No significant damage</td></tr> <tr><td>Capacitance change</td><td>≤ ±20% of the initial value</td></tr> <tr><td>D.F. (tan δ)</td><td>≤ 150% of the initial specified value</td></tr> <tr><td>ESR</td><td>≤ 150% of the initial specified value</td></tr> <tr><td>Leakage current</td><td>≤ The initial specified value</td></tr> </table>	Appearance	No significant damage	Capacitance change	≤ ±20% of the initial value	D.F. (tan δ)	≤ 150% of the initial specified value	ESR	≤ 150% of the initial specified value	Leakage current	≤ The initial specified value
Appearance	No significant damage										
Capacitance change	≤ ±20% of the initial value										
D.F. (tan δ)	≤ 150% of the initial specified value										
ESR	≤ 150% of the initial specified value										
Leakage current	≤ The initial specified value										
Bias Humidity	The following specifications shall be satisfied when the capacitors are restored to 20°C after subjecting them to the DC rated voltage at 60°C, 90 to 95% RH for 1,000 hours (F46 : 500hours).										
	<table border="1"> <tr><td>Appearance</td><td>No significant damage</td></tr> <tr><td>Capacitance change</td><td>≤ ±20% of the initial value</td></tr> <tr><td>D.F. (tan δ)</td><td>≤ 150% of the initial specified value</td></tr> <tr><td>ESR</td><td>≤ 150% of the initial specified value</td></tr> <tr><td>Leakage current</td><td>≤ The initial specified value</td></tr> </table>	Appearance	No significant damage	Capacitance change	≤ ±20% of the initial value	D.F. (tan δ)	≤ 150% of the initial specified value	ESR	≤ 150% of the initial specified value	Leakage current	≤ The initial specified value
Appearance	No significant damage										
Capacitance change	≤ ±20% of the initial value										
D.F. (tan δ)	≤ 150% of the initial specified value										
ESR	≤ 150% of the initial specified value										
Leakage current	≤ The initial specified value										
Surge Voltage	The capacitors shall be subjected to 1,000 cycles each consisting of charge with the surge voltage specified at 105°C for 30 seconds through a protective resistor(R=1kΩ) and discharge for 5 minutes 30 seconds.										
	<table border="1"> <tr><td>Rated voltage (V_{dc})</td><td>2.5</td><td>4.0</td><td>6.3</td><td>16</td></tr> <tr><td>Surge voltage (V_{dc})</td><td>2.9</td><td>4.6</td><td>7.2</td><td>18</td></tr> </table>	Rated voltage (V _{dc})	2.5	4.0	6.3	16	Surge voltage (V _{dc})	2.9	4.6	7.2	18
Rated voltage (V _{dc})	2.5	4.0	6.3	16							
Surge voltage (V _{dc})	2.9	4.6	7.2	18							
	<table border="1"> <tr><td>Appearance</td><td>No significant damage</td></tr> <tr><td>Capacitance change</td><td>≤ ±20% of the initial value</td></tr> <tr><td>D.F. (tan δ)</td><td>≤ 150% of the initial specified value</td></tr> <tr><td>ESR</td><td>≤ 150% of the initial specified value</td></tr> <tr><td>Leakage current</td><td>≤ The initial specified value</td></tr> </table>	Appearance	No significant damage	Capacitance change	≤ ±20% of the initial value	D.F. (tan δ)	≤ 150% of the initial specified value	ESR	≤ 150% of the initial specified value	Leakage current	≤ The initial specified value
Appearance	No significant damage										
Capacitance change	≤ ±20% of the initial value										
D.F. (tan δ)	≤ 150% of the initial specified value										
ESR	≤ 150% of the initial specified value										
Leakage current	≤ The initial specified value										
Soldering Heat	The following specifications shall be satisfied when the solder temperature is reduced back to 20°C after soldering has been performed under the recommended soldering conditions.										
	<table border="1"> <tr><td>Appearance</td><td>No significant damage</td></tr> <tr><td>Capacitance value</td><td>Within the specified tolerance range</td></tr> <tr><td>D.F. (tan δ)</td><td>≤ The initial specified value</td></tr> <tr><td>ESR</td><td>≤ The initial specified value</td></tr> <tr><td>Leakage current</td><td>≤ The initial specified value (Voltage treatment)</td></tr> </table>	Appearance	No significant damage	Capacitance value	Within the specified tolerance range	D.F. (tan δ)	≤ The initial specified value	ESR	≤ The initial specified value	Leakage current	≤ The initial specified value (Voltage treatment)
Appearance	No significant damage										
Capacitance value	Within the specified tolerance range										
D.F. (tan δ)	≤ The initial specified value										
ESR	≤ The initial specified value										
Leakage current	≤ The initial specified value (Voltage treatment)										

*Note : If any doubt arises, measure the leakage current after following voltage treatment.
Voltage treatment : DC rated voltage are applied to the capacitors for 120 minutes at 105°C.

◆ DIMENSIONS [mm]

● Terminal Code : A

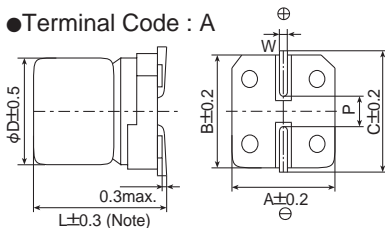

Note : L^{+0.1}_{-0.2} for F46

Size Code	φD	L	A	B	C	W	P
E61	5	5.8	5.3	5.3	5.9	0.5 to 0.8	1.4
F46	6.3	4.5	6.6	6.6	7.2	0.5 to 0.8	1.9
F61	6.3	5.8	6.6	6.6	7.2	0.5 to 0.8	1.9

◆ MARKING

EX) 2.5V330μF

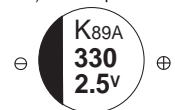



NPCAP™-PXX Series

◆PART NUMBERING SYSTEM

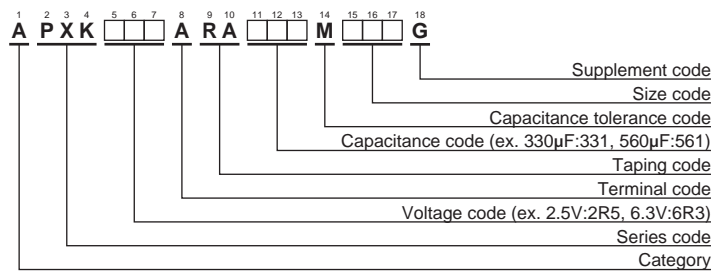

Please refer to "Product code guide (conductive polymer type)"

◆STANDARD RATINGS

WV (V _{dc})	Cap (μF)	Size code	Leakage current (μA max./after 2min.)	ESR (mΩ max./20°C, 100k to 300kHz)	Rated ripple current (mA _{rms} /105°C, 100kHz)	Part No.
2.5	220	F46	300	19	2,780	APXK2R5ARA221MF46G
	330	E61	412	16	3,500	APXK2R5ARA331ME61G
	330	F46	700	16	3,500	APXK2R5ARA331MF46G
	560	F61	700	16	3,500	APXK2R5ARA561MF61G
4	180	F46	360	19	2,780	APXK4R0ARA181MF46G
	220	E61	440	17	3,390	APXK4R0ARA221ME61G
	390	F61	780	17	3,390	APXK4R0ARA391MF61G
6.3	150	F46	472	19	2,780	APXK6R3ARA151MF46G
	180	E61	567	17	3,390	APXK6R3ARA181ME61G
	220	F46	700	18	3,200	APXK6R3ARA221MF46G
	330	F61	1,040	17	3,390	APXK6R3ARA331MF61G
16	100	F61	320	24	2,490	APXK160ARA101MF61G

◆RATED RIPPLE CURRENT MULTIPLIERS

● Frequency Multipliers

Frequency (Hz)	120	1k	10k	50k	100k to 500k
SMD type	0.05	0.30	0.55	0.70	1.00



NPCAP™-PXS Series



- Super low ESR, high ripple current capability
- Longer life (20,000 hours at 105°C)
- Rated voltage range : 4 to 16V_{dc}, Capacitance range : 39 to 560μF
- Suitable for DC-DC converters, voltage regulators and decoupling applications for computer motherboards etc.
- Solvent resistant type (see PRECAUTIONS AND GUIDELINES)
- RoHS2 Compliant
- Halogen Free

◆ SPECIFICATIONS

Items	Characteristics																				
Category	-55 to +105°C																				
Temperature Range																					
Rated Voltage Range	4 to 16V _{dc}																				
Capacitance Tolerance	±20% (M) (at 20°C, 120Hz)																				
Leakage Current <small>*Note</small>	I=0.2CV Where, I : Max. leakage current (μA), C : Nominal capacitance (μF), V : Rated voltage (V _{dc}) (at 20°C after 2 minutes)																				
Dissipation Factor (tan δ)	0.12 max. (at 20°C, 120Hz)																				
Low Temperature Characteristics (Max. Impedance Ratio)	Z(-25°C)/Z(+20°C) ≤ 1.15 Z(-55°C)/Z(+20°C) ≤ 1.25 (at 100kHz)																				
Endurance	The following specifications shall be satisfied when the capacitors are restored to 20°C after the rated voltage is applied for 20,000 hours at 105°C. <table border="1"> <tr><td>Appearance</td><td>No significant damage</td></tr> <tr><td>Capacitance change</td><td>≤ ±20% of the initial value</td></tr> <tr><td>D.F. (tan δ)</td><td>≤ 150% of the initial specified value</td></tr> <tr><td>ESR</td><td>≤ 150% of the initial specified value</td></tr> <tr><td>Leakage current</td><td>≤ The initial specified value</td></tr> </table>	Appearance	No significant damage	Capacitance change	≤ ±20% of the initial value	D.F. (tan δ)	≤ 150% of the initial specified value	ESR	≤ 150% of the initial specified value	Leakage current	≤ The initial specified value										
Appearance	No significant damage																				
Capacitance change	≤ ±20% of the initial value																				
D.F. (tan δ)	≤ 150% of the initial specified value																				
ESR	≤ 150% of the initial specified value																				
Leakage current	≤ The initial specified value																				
Bias Humidity	The following specifications shall be satisfied when the capacitors are restored to 20°C after subjecting them to the DC rated voltage at 60°C, 90 to 95% RH for 1,000 hours. <table border="1"> <tr><td>Appearance</td><td>No significant damage</td></tr> <tr><td>Capacitance change</td><td>≤ ±20% of the initial value</td></tr> <tr><td>D.F. (tan δ)</td><td>≤ 150% of the initial specified value</td></tr> <tr><td>ESR</td><td>≤ 150% of the initial specified value</td></tr> <tr><td>Leakage current</td><td>≤ The initial specified value</td></tr> </table>	Appearance	No significant damage	Capacitance change	≤ ±20% of the initial value	D.F. (tan δ)	≤ 150% of the initial specified value	ESR	≤ 150% of the initial specified value	Leakage current	≤ The initial specified value										
Appearance	No significant damage																				
Capacitance change	≤ ±20% of the initial value																				
D.F. (tan δ)	≤ 150% of the initial specified value																				
ESR	≤ 150% of the initial specified value																				
Leakage current	≤ The initial specified value																				
Surge Voltage	The capacitors shall be subjected to 1,000 cycles each consisting of charge with the surge voltage specified at 105°C for 30 seconds through a protective resistor(R=1kΩ) and discharge for 5 minutes 30 seconds. <table border="1"> <tr><td>Rated voltage (V_{dc})</td><td>4.0</td><td>6.3</td><td>10</td><td>16</td></tr> <tr><td>Surge voltage (V_{dc})</td><td>4.6</td><td>7.2</td><td>12</td><td>18</td></tr> </table> <table border="1"> <tr><td>Appearance</td><td>No significant damage</td></tr> <tr><td>Capacitance change</td><td>≤ ±20% of the initial value</td></tr> <tr><td>D.F. (tan δ)</td><td>≤ 150% of the initial specified value</td></tr> <tr><td>ESR</td><td>≤ 150% of the initial specified value</td></tr> <tr><td>Leakage current</td><td>≤ The initial specified value</td></tr> </table>	Rated voltage (V _{dc})	4.0	6.3	10	16	Surge voltage (V _{dc})	4.6	7.2	12	18	Appearance	No significant damage	Capacitance change	≤ ±20% of the initial value	D.F. (tan δ)	≤ 150% of the initial specified value	ESR	≤ 150% of the initial specified value	Leakage current	≤ The initial specified value
Rated voltage (V _{dc})	4.0	6.3	10	16																	
Surge voltage (V _{dc})	4.6	7.2	12	18																	
Appearance	No significant damage																				
Capacitance change	≤ ±20% of the initial value																				
D.F. (tan δ)	≤ 150% of the initial specified value																				
ESR	≤ 150% of the initial specified value																				
Leakage current	≤ The initial specified value																				
Soldering Heat	The following specifications shall be satisfied when the solder temperature is reduced back to 20°C after soldering has been performed under the recommended soldering conditions. <table border="1"> <tr><td>Appearance</td><td>No significant damage</td></tr> <tr><td>Capacitance value</td><td>Within the specified tolerance range</td></tr> <tr><td>D.F. (tan δ)</td><td>≤ The initial specified value</td></tr> <tr><td>ESR</td><td>≤ The initial specified value</td></tr> <tr><td>Leakage current</td><td>≤ The initial specified value (Voltage treatment)</td></tr> </table>	Appearance	No significant damage	Capacitance value	Within the specified tolerance range	D.F. (tan δ)	≤ The initial specified value	ESR	≤ The initial specified value	Leakage current	≤ The initial specified value (Voltage treatment)										
Appearance	No significant damage																				
Capacitance value	Within the specified tolerance range																				
D.F. (tan δ)	≤ The initial specified value																				
ESR	≤ The initial specified value																				
Leakage current	≤ The initial specified value (Voltage treatment)																				

*Note : If any doubt arises, measure the leakage current after the following voltage treatment.
Voltage treatment : DC rated voltage is applied to the capacitors for 120 minutes at 105°C.

◆ DIMENSIONS [mm]°

● Terminal Code : A

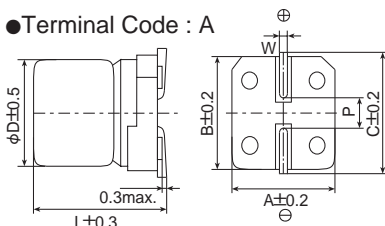

Size Code	φD	L	A	B	C	W	P
F61	6.3	5.8	6.6	6.6	7.2	0.5 to 0.8	1.9
H70	8.0	6.7	8.3	8.3	9.0	0.7 to 1.1	3.1

◆ MARKING

EX) 6.3V390μF





NPCAP™-PXS Series

◆PART NUMBERING SYSTEM

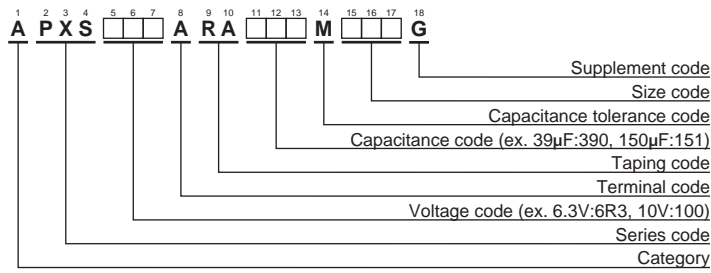

Please refer to "Product code guide (conductive polymer type)"

◆STANDARD RATINGS

WV (V _{dc})	Cap (μF)	Size code	ESR (mΩ max./20°C, 100k to 300kHz)	Rated ripple current (mArms/105°C, 100kHz)	Part No.
4	560	H70	22	3,220	APXS4R0ARA561MH70G
	120	F61	22	2,570	APXS6R3ARA121MF61G
6.3	220	F61	22	2,570	APXS6R3ARA221MF61G
	390	H70	22	3,220	APXS6R3ARA391MH70G
10	120	F61	27	2,320	APXS100ARA121MF61G
	150	H70	30	2,760	APXS100ARA151MH70G
16	39	F61	37	2,050	APXS160ARA390MF61G
	68	F61	30	2,200	APXS160ARA680MF61G
	82	H70	30	2,760	APXS160ARA820MH70G
	120	H70	27	2,900	APXS160ARA121MH70G

◆RATED RIPPLE CURRENT MULTIPLIERS

● Frequency Multipliers

Frequency (Hz)	120	1k	10k	50k	100k to 500k
SMD type	0.05	0.30	0.55	0.70	1.00

NPCAP™-PXF Series

- Super low ESR, impedance and high heat resistance have been obtained by using conductive polymer as electrolyte.
- Rated voltage range : 2 to 10V_{dc}, Capacitance range : 120 to 1,000μF
- Case size range : φ 5x3.9L to φ 8x7.7L
- Suitable for DC-DC converters, voltage regulators and decoupling applications used on computer motherboards etc.
- Solvent resistant type (see PRECAUTIONS AND GUIDELINES)
- RoHS2 Compliant
- Halogen Free

PXF

Lower ESR
↑
PXE



◆ SPECIFICATIONS

Items	Characteristics												
Category	-55 to +105°C												
Temperature Range													
Rated Voltage Range	2 to 10V _{dc}												
Capacitance Tolerance	±20% (M) (at 20°C, 120Hz)												
Leakage Current <small>*Note</small>	Shall not exceed values shown in STANDARD RATINGS. (at 20°C after 2 minutes)												
Dissipation Factor (tan δ)	0.12 max. (at 20°C, 120Hz)												
Low Temperature Characteristics (Max. Impedance Ratio)	Z(-25°C)/Z(+20°C) ≤ 1.15 Z(-55°C)/Z(+20°C) ≤ 1.25 (at 100kHz)												
Endurance	The following specifications shall be satisfied when the capacitors are restored to 20°C after the rated voltage is applied for 15,000 hours (E40, E46, F46 : 3,000 hours) at 105°C.												
	<table border="1"> <tr><td>Appearance</td><td>No significant damage</td></tr> <tr><td>Capacitance change</td><td>≤ ±20% of the initial value</td></tr> <tr><td>D.F. (tan δ)</td><td>≤ 150% of the initial specified value</td></tr> <tr><td>ESR</td><td>≤ 150% of the initial specified value</td></tr> <tr><td>Leakage current</td><td>≤ The initial specified value</td></tr> </table>	Appearance	No significant damage	Capacitance change	≤ ±20% of the initial value	D.F. (tan δ)	≤ 150% of the initial specified value	ESR	≤ 150% of the initial specified value	Leakage current	≤ The initial specified value		
Appearance	No significant damage												
Capacitance change	≤ ±20% of the initial value												
D.F. (tan δ)	≤ 150% of the initial specified value												
ESR	≤ 150% of the initial specified value												
Leakage current	≤ The initial specified value												
Bias Humidity	The following specifications shall be satisfied when the capacitors are restored to 20°C after subjecting them to the DC rated voltage at 60°C, 90 to 95% RH for 1,000 hours (E40, E46, F46 : 500 hours).												
	<table border="1"> <tr><td>Appearance</td><td>No significant damage</td></tr> <tr><td>Capacitance change</td><td>≤ ±20% of the initial value</td></tr> <tr><td>D.F. (tan δ)</td><td>≤ 150% of the initial specified value</td></tr> <tr><td>ESR</td><td>≤ 150% of the initial specified value</td></tr> <tr><td>Leakage current</td><td>≤ The initial specified value</td></tr> </table>	Appearance	No significant damage	Capacitance change	≤ ±20% of the initial value	D.F. (tan δ)	≤ 150% of the initial specified value	ESR	≤ 150% of the initial specified value	Leakage current	≤ The initial specified value		
Appearance	No significant damage												
Capacitance change	≤ ±20% of the initial value												
D.F. (tan δ)	≤ 150% of the initial specified value												
ESR	≤ 150% of the initial specified value												
Leakage current	≤ The initial specified value												
Surge Voltage	The capacitors shall be subjected to 1,000 cycles each consisting of charge with the surge voltage specified at 105°C for 30 seconds through a protective resistor(R=1kΩ) and discharge for 5 minutes 30 seconds.												
	<table border="1"> <tr> <td>Rated voltage (V_{dc})</td> <td>2.0</td> <td>2.5</td> <td>4.0</td> <td>6.3</td> <td>10</td> </tr> <tr> <td>Surge voltage (V_{dc})</td> <td>2.3</td> <td>2.9</td> <td>4.6</td> <td>7.2</td> <td>12</td> </tr> </table>	Rated voltage (V _{dc})	2.0	2.5	4.0	6.3	10	Surge voltage (V _{dc})	2.3	2.9	4.6	7.2	12
Rated voltage (V _{dc})	2.0	2.5	4.0	6.3	10								
Surge voltage (V _{dc})	2.3	2.9	4.6	7.2	12								
	<table border="1"> <tr><td>Appearance</td><td>No significant damage</td></tr> <tr><td>Capacitance change</td><td>≤ ±20% of the initial value</td></tr> <tr><td>D.F. (tan δ)</td><td>≤ 150% of the initial specified value</td></tr> <tr><td>ESR</td><td>≤ 150% of the initial specified value</td></tr> <tr><td>Leakage current</td><td>≤ The initial specified value</td></tr> </table>	Appearance	No significant damage	Capacitance change	≤ ±20% of the initial value	D.F. (tan δ)	≤ 150% of the initial specified value	ESR	≤ 150% of the initial specified value	Leakage current	≤ The initial specified value		
Appearance	No significant damage												
Capacitance change	≤ ±20% of the initial value												
D.F. (tan δ)	≤ 150% of the initial specified value												
ESR	≤ 150% of the initial specified value												
Leakage current	≤ The initial specified value												
Soldering Heat	The following specifications shall be satisfied when the solder temperature is reduced back to 20°C after soldering has been performed under the recommended soldering conditions.												
	<table border="1"> <tr><td>Appearance</td><td>No significant damage</td></tr> <tr><td>Capacitance value</td><td>Within the specified tolerance range</td></tr> <tr><td>D.F. (tan δ)</td><td>≤ The initial specified value</td></tr> <tr><td>ESR</td><td>≤ The initial specified value</td></tr> <tr><td>Leakage current</td><td>≤ The initial specified value (Voltage treatment)</td></tr> </table>	Appearance	No significant damage	Capacitance value	Within the specified tolerance range	D.F. (tan δ)	≤ The initial specified value	ESR	≤ The initial specified value	Leakage current	≤ The initial specified value (Voltage treatment)		
Appearance	No significant damage												
Capacitance value	Within the specified tolerance range												
D.F. (tan δ)	≤ The initial specified value												
ESR	≤ The initial specified value												
Leakage current	≤ The initial specified value (Voltage treatment)												

*Note : If any doubt arises, measure the leakage current after the following voltage treatment.
Voltage treatment : DC rated voltage is applied to the capacitors for 120 minutes at 105°C.

◆ DIMENSIONS [mm]

- Terminal Code : A

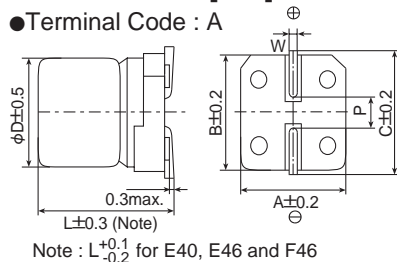

Size Code	φD	L	A	B	C	W	P
E40	5	3.9	5.3	5.3	5.9	0.5 to 0.8	1.4
E46	5	4.5	5.3	5.3	5.9	0.5 to 0.8	1.4
E61	5	5.8	5.3	5.3	5.9	0.5 to 0.8	1.4
F46	6.3	4.5	6.6	6.6	7.2	0.5 to 0.8	1.9
F61	6.3	5.8	6.6	6.6	7.2	0.5 to 0.8	1.9
F80	6.3	7.7	6.6	6.6	7.2	0.5 to 0.8	1.9
H70	8	6.7	8.3	8.3	9.0	0.7 to 1.1	3.1
H80	8	7.7	8.3	8.3	9.0	0.7 to 1.1	3.1

◆ MARKING

EX) 2.5V390μF





NPCAP™-PXF Series

◆PART NUMBERING SYSTEM

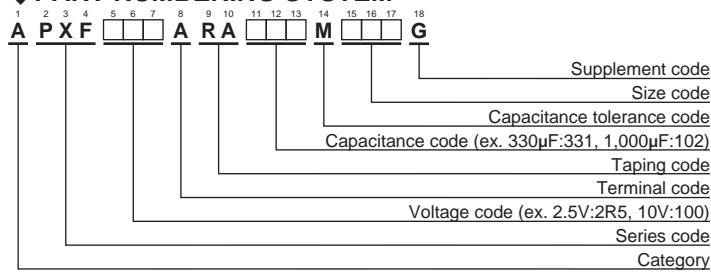

Please refer to "Product code guide (conductive polymer type)"

◆STANDARD RATINGS

WV (V _{dc})	Cap (μF)	Size code	Leakage current (μA max./after 2min.)	ESR (mΩ max./20°C, 100k to 300kHz)	Rated ripple current (mArms/105°C, 100kHz)	Part No.
2	680	F61	700	12	3,500	APXF2R0ARA681MF61G
	220	E40	700	12	3,300	APXF2R5ARA221ME40G
2.5	220	E46	700	25	2,100	APXF2R5ARA221ME46G
	330	E61	700	10	3,900	APXF2R5ARA331ME61G
	330	F46	700	12	3,500	APXF2R5ARA331MF46G
	390	E61	700	10	3,900	APXF2R5ARA391ME61G
	390	F61	292	10	3,900	APXF2R5ARA391MF61G
	470	F80	352	9	4,200	APXF2R5ARA471MF80G
	560	F61	700	10	3,900	APXF2R5ARA561MF61G
	560	F80	420	9	4,200	APXF2R5ARA561MF80G
	560	H70	420	10	4,500	APXF2R5ARA561MH70G
	680	H70	510	10	4,500	APXF2R5ARA681MH70G
	1,000	H80	750	9	4,500	APXF2R5ARA102MH80G
4	330	F61	396	10	3,900	APXF4R0ARA331MF61G
	390	F80	468	9	4,200	APXF4R0ARA391MF80G
	470	H70	564	10	4,500	APXF4R0ARA471MH70G
	560	H70	672	10	4,500	APXF4R0ARA561MH70G
	680	H80	816	9	4,500	APXF4R0ARA681MH80G
6.3	150	E40	700	20	2,700	APXF6R3ARA151ME40G
	150	E46	700	25	2,100	APXF6R3ARA151ME46G
	150	E61	700	12	3,500	APXF6R3ARA151ME61G
	220	E61	700	12	3,500	APXF6R3ARA221ME61G
	220	F61	415	10	3,900	APXF6R3ARA221MF61G
	270	F80	510	9	4,200	APXF6R3ARA271MF80G
	330	F61	700	10	3,900	APXF6R3ARA331MF61G
	330	F80	623	9	4,200	APXF6R3ARA331MF80G
	330	H70	623	10	4,500	APXF6R3ARA331MH70G
	390	H70	737	10	4,500	APXF6R3ARA391MH70G
	470	H80	888	9	4,500	APXF6R3ARA471MH80G
560	H80	1,050	9	4,500	APXF6R3ARA561MH80G	
10	120	E61	240	22	2,600	APXF100ARA121ME61G
	270	F61	540	20	2,800	APXF100ARA271MF61G

Production of the products shown in is scheduled to be discontinued.

◆RATED RIPPLE CURRENT MULTIPLIERS

● Frequency Multipliers

Frequency (Hz)	120	1k	10k	50k	100k to 500k
SMD type	0.05	0.30	0.55	0.70	1.00

NPCAP™-PXE Series

- Super low ESR, impedance and high heat resistance have been obtained by using conductive polymer as electrolyte.
(ESR and rated ripple current values are improved from PXA series.)
- Rated voltage range : 2.5 to 16V_{dc}, Capacitance range : 33 to 2,700μF
- Suitable for DC-DC converters, voltage regulators and decoupling applications used on computer motherboards etc.
- Solvent resistant type (see PRECAUTIONS AND GUIDELINES)
- RoHS2 Compliant
- Halogen Free

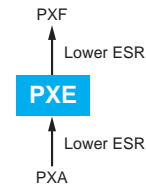

◆ SPECIFICATIONS

Items	Characteristics												
Category													
Temperature Range	-55 to +105°C												
Rated Voltage Range	2.5 to 16V _{dc}												
Capacitance Tolerance	±20% (M) (at 20°C, 120Hz)												
Leakage Current *Note	Shall not exceed values shown in STANDARD RATINGS. (at 20°C after 2 minutes)												
Dissipation Factor (tan δ)	0.12 max. (at 20°C, 120Hz)												
Low Temperature Characteristics (Max. Impedance Ratio)	Z(-25°C)/Z(+20°C) ≤ 1.15 Z(-55°C)/Z(+20°C) ≤ 1.25 (at 100kHz)												
Endurance	The following specifications shall be satisfied when the capacitors are restored to 20°C after the rated voltage is applied for 15,000 hours at 105°C.												
	<table border="1"> <tr><td>Appearance</td><td>No significant damage</td></tr> <tr><td>Capacitance change</td><td>≤ ±20% of the initial value</td></tr> <tr><td>D.F. (tan δ)</td><td>≤ 150% of the initial specified value</td></tr> <tr><td>ESR</td><td>≤ 150% of the initial specified value</td></tr> <tr><td>Leakage current</td><td>≤ The initial specified value</td></tr> </table>	Appearance	No significant damage	Capacitance change	≤ ±20% of the initial value	D.F. (tan δ)	≤ 150% of the initial specified value	ESR	≤ 150% of the initial specified value	Leakage current	≤ The initial specified value		
Appearance	No significant damage												
Capacitance change	≤ ±20% of the initial value												
D.F. (tan δ)	≤ 150% of the initial specified value												
ESR	≤ 150% of the initial specified value												
Leakage current	≤ The initial specified value												
Bias Humidity	The following specifications shall be satisfied when the capacitors are restored to 20°C after subjecting them to the DC rated voltage at 60°C, 90 to 95% RH for 1,000 hours.												
	<table border="1"> <tr><td>Appearance</td><td>No significant damage</td></tr> <tr><td>Capacitance change</td><td>≤ ±20% of the initial value</td></tr> <tr><td>D.F. (tan δ)</td><td>≤ 150% of the initial specified value</td></tr> <tr><td>ESR</td><td>≤ 150% of the initial specified value</td></tr> <tr><td>Leakage current</td><td>≤ The initial specified value</td></tr> </table>	Appearance	No significant damage	Capacitance change	≤ ±20% of the initial value	D.F. (tan δ)	≤ 150% of the initial specified value	ESR	≤ 150% of the initial specified value	Leakage current	≤ The initial specified value		
Appearance	No significant damage												
Capacitance change	≤ ±20% of the initial value												
D.F. (tan δ)	≤ 150% of the initial specified value												
ESR	≤ 150% of the initial specified value												
Leakage current	≤ The initial specified value												
Surge Voltage	The capacitors shall be subjected to 1,000 cycles each consisting of charge with the surge voltage specified at 105°C for 30 seconds through a protective resistor(R=1kΩ) and discharge for 5 minutes 30 seconds.												
	<table border="1"> <tr> <td>Rated voltage (V_{dc})</td> <td>2.5</td> <td>4.0</td> <td>6.3</td> <td>10</td> <td>16</td> </tr> <tr> <td>Surge voltage (V_{dc})</td> <td>2.9</td> <td>4.6</td> <td>7.2</td> <td>12</td> <td>18</td> </tr> </table>	Rated voltage (V _{dc})	2.5	4.0	6.3	10	16	Surge voltage (V _{dc})	2.9	4.6	7.2	12	18
Rated voltage (V _{dc})	2.5	4.0	6.3	10	16								
Surge voltage (V _{dc})	2.9	4.6	7.2	12	18								
	<table border="1"> <tr><td>Appearance</td><td>No significant damage</td></tr> <tr><td>Capacitance change</td><td>≤ ±20% of the initial value</td></tr> <tr><td>D.F. (tan δ)</td><td>≤ 150% of the initial specified value</td></tr> <tr><td>ESR</td><td>≤ 150% of the initial specified value</td></tr> <tr><td>Leakage current</td><td>≤ The initial specified value</td></tr> </table>	Appearance	No significant damage	Capacitance change	≤ ±20% of the initial value	D.F. (tan δ)	≤ 150% of the initial specified value	ESR	≤ 150% of the initial specified value	Leakage current	≤ The initial specified value		
Appearance	No significant damage												
Capacitance change	≤ ±20% of the initial value												
D.F. (tan δ)	≤ 150% of the initial specified value												
ESR	≤ 150% of the initial specified value												
Leakage current	≤ The initial specified value												
Soldering Heat	The following specifications shall be satisfied when the solder temperature is reduced back to 20°C after soldering has been performed under the recommended soldering conditions.												
	<table border="1"> <tr><td>Appearance</td><td>No significant damage</td></tr> <tr><td>Capacitance value</td><td>Within the specified tolerance range</td></tr> <tr><td>D.F. (tan δ)</td><td>≤ The initial specified value</td></tr> <tr><td>ESR</td><td>≤ The initial specified value</td></tr> <tr><td>Leakage current</td><td>≤ The initial specified value (Voltage treatment)</td></tr> </table>	Appearance	No significant damage	Capacitance value	Within the specified tolerance range	D.F. (tan δ)	≤ The initial specified value	ESR	≤ The initial specified value	Leakage current	≤ The initial specified value (Voltage treatment)		
Appearance	No significant damage												
Capacitance value	Within the specified tolerance range												
D.F. (tan δ)	≤ The initial specified value												
ESR	≤ The initial specified value												
Leakage current	≤ The initial specified value (Voltage treatment)												

*Note : If any doubt arises, measure the leakage current after the following voltage treatment.
Voltage treatment : DC rated voltage is applied to the capacitors for 120 minutes at 105°C.

◆ DIMENSIONS [mm]

- Terminal Code : A

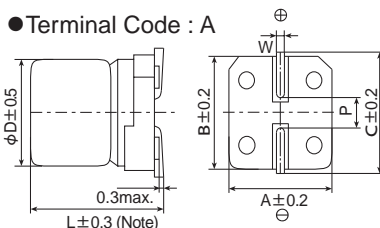

(Note) L±0.5 for HA0, HC0, JA0, JC0

Size Code	φD	L	A	B	C	W	P
E61	5	5.8	5.3	5.3	5.9	0.5 to 0.8	1.4
F61	6.3	5.8	6.6	6.6	7.2	0.5 to 0.8	1.9
F80	6.3	7.7	6.6	6.6	7.2	0.5 to 0.8	1.9
H70	8	6.7	8.3	8.3	9.0	0.7 to 1.1	3.1
H80	8	7.7	8.3	8.3	9.0	0.7 to 1.1	3.1
HA0	8	10.0	8.3	8.3	9.0	0.7 to 1.1	3.1
HC0	8	12.0	8.3	8.3	9.0	0.7 to 1.1	3.1
J80	10	7.7	10.3	10.3	11.0	0.7 to 1.1	4.5
JA0	10	10.0	10.3	10.3	11.0	0.7 to 1.1	4.5
JC0	10	12.2	10.3	10.3	11.0	0.7 to 1.1	4.5

◆ MARKING

EX) 2.5V390μF





NPCAP™-PXE Series

◆PART NUMBERING SYSTEM

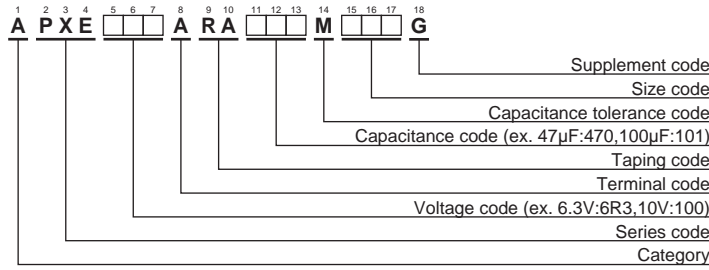

Please refer to "Product code guide (conductive polymer type)"

◆STANDARD RATINGS

WV (V _{dc})	Cap (µF)	Size code	Leakage current (µA max./after 2min.)	ESR (mΩ max./20°C, 100k to 300kHz)	Rated ripple current (mArms/105°C, 100kHz)	Part No.
2.5	180	E61	90.0	21	2,670	APXE2R5ARA181ME61G
	390	F61	195	15	3,160	APXE2R5ARA391MF61G
	470	F80	235	13	3,600	APXE2R5ARA471MF80G
	560	F80	280	13	3,600	APXE2R5ARA561MF80G
	560	H70	280	13	4,100	APXE2R5ARA561MH70G
	680	H70	340	13	4,100	APXE2R5ARA681MH70G
	820	H80	410	12	4,260	APXE2R5ARA821MH80G
	820	HC0	410	9	5,400	APXE2R5ARA821MHC0G
	1,000	H80	500	12	4,260	APXE2R5ARA102MH80G
	1,200	J80	600	13	4,450	APXE2R5ARA122MJ80G
	1,500	HA0	750	10	5,220	APXE2R5ARA152MHA0G
	1,500	HC0	750	9	5,400	APXE2R5ARA152MHC0G
2,200	JA0	1,100	10	5,500	APXE2R5ARA222MJA0G	
2,700	JC0	1,350	9	5,600	APXE2R5ARA272MJC0G	
4	100	E61	80.0	22	2,610	APXE4R0ARA101ME61G
	150	E61	120	22	2,610	APXE4R0ARA151ME61G
	270	F61	216	15	3,160	APXE4R0ARA271MF61G
	330	F61	264	15	3,160	APXE4R0ARA331MF61G
	390	F80	312	14	3,470	APXE4R0ARA391MF80G
	470	H70	376	14	3,950	APXE4R0ARA471MH70G
	560	H70	448	14	3,950	APXE4R0ARA561MH70G
	680	H80	544	13	3,950	APXE4R0ARA681MH80G
	1,000	HA0	800	10	5,220	APXE4R0ARA102MHA0G
	1,000	J80	800	14	4,300	APXE4R0ARA102MJ80G
	1,200	HC0	960	9	5,400	APXE4R0ARA122MHC0G
	1,200	JA0	960	10	5,500	APXE4R0ARA122MJA0G
	1,500	JA0	1,200	10	5,500	APXE4R0ARA152MJA0G
	1,800	JA0	1,440	10	5,500	APXE4R0ARA182MJA0G
1,800	JC0	1,440	9	5,600	APXE4R0ARA182MJC0G	
6.3	100	E61	126	24	2,500	APXE6R3ARA101ME61G
	120	E61	151	24	2,500	APXE6R3ARA121ME61G
	220	F61	277	15	3,160	APXE6R3ARA221MF61G
	270	F80	340	14	3,470	APXE6R3ARA271MF80G
	330	F80	415	14	3,470	APXE6R3ARA331MF80G
	330	H70	415	14	3,950	APXE6R3ARA331MH70G
	390	H70	491	14	3,950	APXE6R3ARA391MH70G
	470	H80	592	13	3,950	APXE6R3ARA471MH80G
	820	HA0	1,030	12	4,770	APXE6R3ARA821MHA0G
	820	HC0	1,030	10	5,150	APXE6R3ARA821MHC0G
	820	J80	1,030	14	4,300	APXE6R3ARA821MJ80G
	1,200	JA0	1,510	12	5,025	APXE6R3ARA122MJA0G
	1,500	JA0	1,890	12	5,025	APXE6R3ARA152MJA0G
	1,500	JC0	1,890	10	5,500	APXE6R3ARA152MJC0G

Production of the products shown in [] is scheduled to be discontinued.

◆ **STANDARD RATINGS**

WV (V _{dc})	Cap (µF)	Size code	Leakage current (µA max./after 2min.)	ESR (mΩ max./20°C, 100k to 300kHz)	Rated ripple current (mA _{rms} /105°C, 100kHz)	Part No.
10	47	E61	94.0	28	2,310	APXE100ARA470ME61G
	56	E61	112	28	2,310	APXE100ARA560ME61G
	68	E61	136	28	2,310	APXE100ARA680ME61G
	120	F61	240	25	2,530	APXE100ARA121MF61G
	150	F80	300	21	2,880	APXE100ARA151MF80G
	220	H70	440	21	3,220	APXE100ARA221MH70G
	270	H70	540	21	3,220	APXE100ARA271MH70G
	330	H80	660	19	3,390	APXE100ARA331MH80G
	390	HA0	780	17	4,000	APXE100ARA391MHA0G
	470	J80	940	19	3,800	APXE100ARA471MJ80G
680	JA0	1,360	13	4,820	APXE100ARA681MJA0G	
16	33	E61	105	35	2,070	APXE160ARA330ME61G
	39	E61	124	35	2,070	APXE160ARA390ME61G
	68	F61	217	28	2,390	APXE160ARA680MF61G
	82	F80	262	24	2,700	APXE160ARA820MF80G
	100	F80	320	24	2,700	APXE160ARA101MF80G
	100	H70	320	24	3,010	APXE160ARA101MH70G
	120	H70	384	24	3,010	APXE160ARA121MH70G
	150	H80	480	22	3,150	APXE160ARA151MH80G
	180	HA0	576	18	3,890	APXE160ARA181MHA0G
	220	HA0	704	18	3,890	APXE160ARA221MHA0G
	220	J80	704	22	3,450	APXE160ARA221MJ80G
	330	JA0	1,050	16	4,350	APXE160ARA331MJA0G

Production of the products shown in is scheduled to be discontinued.

◆ **RATED RIPPLE CURRENT MULTIPLIERS**

● Frequency Multipliers

Frequency (Hz)	120	1k	10k	50k	100k to 500k
SMD type	0.05	0.30	0.55	0.70	1.00

NPCAP™-PXA Series

- Super low ESR, impedance and high heat resistance have been obtained by using conductive polymer as electrolyte
- Rated voltage range : 2.5 to 25V_{dc}, case size range : φ5×5.8L to φ10×12.2L
- Suitable for DC-DC converters, voltage regulators and decoupling applications used on computer motherboards etc.
- Solvent resistant type (see PRECAUTIONS AND GUIDELINES)
- RoHS2 Compliant
- Halogen Free



◆ SPECIFICATIONS

Items	Characteristics																												
Category Temperature Range	-55 to +105°C																												
Rated Voltage Range	2.5 to 25V _{dc}																												
Capacitance Tolerance	±20% (M) (at 20°C, 120Hz)																												
Leakage Current *Note	Shall not exceed values shown in STANDARD RATINGS. (at 20°C after 2 minutes)																												
Dissipation Factor (tan δ)	0.12 max. (at 20°C, 120Hz)																												
Low Temperature Characteristics (Max. Impedance Ratio)	Z(-25°C)/Z(+20°C) ≤ 1.15 Z(-55°C)/Z(+20°C) ≤ 1.25 (at 100kHz)																												
Endurance	The following specifications shall be satisfied when the capacitors are restored to 20°C after the rated voltage is applied for 15,000 hours (F46 : 3,000 hours) at 105°C. <table border="1"> <tr><td>Appearance</td><td>No significant damage</td></tr> <tr><td>Capacitance change</td><td>≤ ±20% of the initial value</td></tr> <tr><td>D.F. (tan δ)</td><td>≤ 150% of the initial specified value</td></tr> <tr><td>ESR</td><td>≤ 150% of the initial specified value</td></tr> <tr><td>Leakage current</td><td>≤ The initial specified value</td></tr> </table>	Appearance	No significant damage	Capacitance change	≤ ±20% of the initial value	D.F. (tan δ)	≤ 150% of the initial specified value	ESR	≤ 150% of the initial specified value	Leakage current	≤ The initial specified value																		
Appearance	No significant damage																												
Capacitance change	≤ ±20% of the initial value																												
D.F. (tan δ)	≤ 150% of the initial specified value																												
ESR	≤ 150% of the initial specified value																												
Leakage current	≤ The initial specified value																												
Bias Humidity	The following specifications shall be satisfied when the capacitors are restored to 20°C after subjecting them to the DC rated voltage at 60°C, 90 to 95% RH for 1,000 hours(F46 : 500 hours). <table border="1"> <tr><td>Appearance</td><td>No significant damage</td></tr> <tr><td>Capacitance change</td><td>≤ ±20% of the initial value</td></tr> <tr><td>D.F. (tan δ)</td><td>≤ 150% of the initial specified value</td></tr> <tr><td>ESR</td><td>≤ 150% of the initial specified value</td></tr> <tr><td>Leakage current</td><td>≤ The initial specified value</td></tr> </table>	Appearance	No significant damage	Capacitance change	≤ ±20% of the initial value	D.F. (tan δ)	≤ 150% of the initial specified value	ESR	≤ 150% of the initial specified value	Leakage current	≤ The initial specified value																		
Appearance	No significant damage																												
Capacitance change	≤ ±20% of the initial value																												
D.F. (tan δ)	≤ 150% of the initial specified value																												
ESR	≤ 150% of the initial specified value																												
Leakage current	≤ The initial specified value																												
Surge Voltage	The capacitors shall be subjected to 1,000 cycles each consisting of charge with the surge voltage specified at 105°C for 30 seconds through a protective resistor(R=1kΩ) and discharge for 5 minutes 30 seconds. <table border="1"> <tr><td>Rated voltage (V_{dc})</td><td>2.5</td><td>4.0</td><td>6.3</td><td>10</td><td>16</td><td>20</td><td>23</td><td>25</td></tr> <tr><td>Surge voltage (V_{dc})</td><td>2.9</td><td>4.6</td><td>7.2</td><td>12</td><td>18</td><td>23</td><td>23</td><td>29</td></tr> </table> <table border="1"> <tr><td>Appearance</td><td>No significant damage</td></tr> <tr><td>Capacitance change</td><td>≤ ±20% of the initial value</td></tr> <tr><td>D.F. (tan δ)</td><td>≤ 150% of the initial specified value</td></tr> <tr><td>ESR</td><td>≤ 150% of the initial specified value</td></tr> <tr><td>Leakage current</td><td>≤ The initial specified value</td></tr> </table>	Rated voltage (V _{dc})	2.5	4.0	6.3	10	16	20	23	25	Surge voltage (V _{dc})	2.9	4.6	7.2	12	18	23	23	29	Appearance	No significant damage	Capacitance change	≤ ±20% of the initial value	D.F. (tan δ)	≤ 150% of the initial specified value	ESR	≤ 150% of the initial specified value	Leakage current	≤ The initial specified value
Rated voltage (V _{dc})	2.5	4.0	6.3	10	16	20	23	25																					
Surge voltage (V _{dc})	2.9	4.6	7.2	12	18	23	23	29																					
Appearance	No significant damage																												
Capacitance change	≤ ±20% of the initial value																												
D.F. (tan δ)	≤ 150% of the initial specified value																												
ESR	≤ 150% of the initial specified value																												
Leakage current	≤ The initial specified value																												
Soldering Heat	The following specifications shall be satisfied when the solder temperature is reduced back to 20°C after soldering has been performed under the recommended soldering conditions. <table border="1"> <tr><td>Appearance</td><td>No significant damage</td></tr> <tr><td>Capacitance value</td><td>Within the specified tolerance range</td></tr> <tr><td>D.F. (tan δ)</td><td>≤ The initial specified value</td></tr> <tr><td>ESR</td><td>≤ The initial specified value</td></tr> <tr><td>Leakage current</td><td>≤ The initial specified value (Voltage treatment)</td></tr> </table>	Appearance	No significant damage	Capacitance value	Within the specified tolerance range	D.F. (tan δ)	≤ The initial specified value	ESR	≤ The initial specified value	Leakage current	≤ The initial specified value (Voltage treatment)																		
Appearance	No significant damage																												
Capacitance value	Within the specified tolerance range																												
D.F. (tan δ)	≤ The initial specified value																												
ESR	≤ The initial specified value																												
Leakage current	≤ The initial specified value (Voltage treatment)																												

*Note : If any doubt arises, measure the leakage current after the following voltage treatment.
Voltage treatment : DC rated voltage is applied to the capacitors for 120 minutes at 105°C.

◆ DIMENSIONS [mm]

● Terminal Code : A

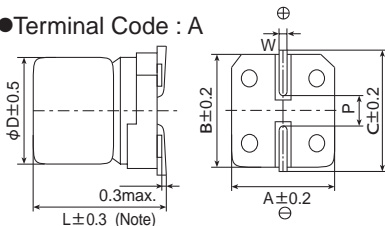

Note : L^{+0.1}_{-0.2} for F46
L±0.5 for HC0 and JC0

Size code	φD	L	A	B	C	W	P
E61	5	5.8	5.3	5.3	5.9	0.5 to 0.8	1.4
F46	6.3	4.5	6.6	6.6	7.2	0.5 to 0.8	1.9
F61	6.3	5.8	6.6	6.6	7.2	0.5 to 0.8	1.9
H70	8	6.7	8.3	8.3	9.0	0.7 to 1.1	3.1
HC0	8	12.0	8.3	8.3	9.0	0.7 to 1.1	3.1
J80	10	7.7	10.3	10.3	11.0	0.7 to 1.1	4.5
JC0	10	12.2	10.3	10.3	11.0	0.7 to 1.1	4.5

◆ MARKING

EX) 16V39μF





NPCAP™-PXA Series

◆PART NUMBERING SYSTEM

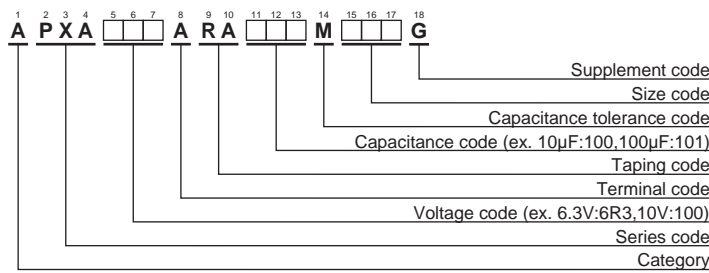

Please refer to "Product code guide (conductive polymer type)"

◆STANDARD RATINGS

WV (V _{ac})	Cap (µF)	Size code	Leakage current (µA max./ after 2 min.)	ESR (mΩ max./ 20°C, 100k to 300kHz)	Rated ripple current (mA rms/105°C, 100kHz)	Part No.	WV (V _{ac})	Cap (µF)	Size code	Leakage current (µA max./ after 2 min.)	ESR (mΩ max./ 20°C, 100k to 300kHz)	Rated ripple current (mA rms/105°C, 100kHz)	Part No.	
2.5	220	F61	110	25	2,500	APXA2R5ARA221MF61G	10	33	E61	66.0	40	1,270	APXA100ARA330ME61G	
	560	H70	280	23	3,100	APXA2R5ARA561MH70G		47	E61	94.0	40	1,270	APXA100ARA470ME61G	
	680	HCO	340	12	4,770	APXA2R5ARA681MHC0G		47	F46	235	41	1,560	APXA100ARA470MF46G	
	1,000	J80	500	19	4,240	APXA2R5ARA102MJ80G		47	F61	94.0	31	2,250	APXA100ARA470MF61G	
	1,500	JCO	750	10	5,500	APXA2R5ARA152MJCOG		56	F61	112	31	2,250	APXA100ARA560MF61G	
4	100	F61	80.0	26	2,450	APXA4R0ARA101MF61G		120	H70	240	27	2,800	APXA100ARA121MH70G	
	120	F46	240	38	1,710	APXA4R0ARA121MF46G		150	H70	300	27	2,800	APXA100ARA151MH70G	
	150	E61	120	30	1,490	APXA4R0ARA151ME61G		270	HCO	540	14	4,420	APXA100ARA271MHC0G	
	150	F61	120	26	2,450	APXA4R0ARA151MF61G		270	J80	540	24	3,770	APXA100ARA271MJ80G	
	220	H70	176	25	3,020	APXA4R0ARA221MH70G		330	HCO	660	14	4,420	APXA100ARA331MHC0G	
	330	H70	264	25	3,020	APXA4R0ARA331MH70G		330	J80	660	24	3,770	APXA100ARA331MJ80G	
	470	J80	376	20	4,130	APXA4R0ARA471MJ80G		470	JCO	940	12	5,300	APXA100ARA471MJCOG	
	560	HCO	448	12	4,770	APXA4R0ARA561MHC0G		560	JCO	1,120	12	5,300	APXA100ARA561MJCOG	
	680	J80	544	20	4,130	APXA4R0ARA681MJ80G		16	22	E61	70.4	45	1,210	APXA160ARA220ME61G
	820	JCO	656	10	5,500	APXA4R0ARA821MJCOG			22	F46	176	45	1,490	APXA160ARA220MF46G
1,200	JCO	960	10	5,500	APXA4R0ARA122MJCOG	33	F61		105	37	2,050	APXA160ARA330MF61G		
6.3	47	E61	59.2	35	1,380	APXA6R3ARA470ME61G	39		F61	124	37	2,050	APXA160ARA390MF61G	
	68	F61	85.6	27	2,400	APXA6R3ARA680MF61G	82		H70	262	30	2,700	APXA160ARA820MH70G	
	82	F46	258	40	1,670	APXA6R3ARA820MF46G	150		J80	480	26	3,430	APXA160ARA151MJ80G	
	82	F61	103	27	2,400	APXA6R3ARA820MF61G	180		HCO	576	16	4,360	APXA160ARA181MHC0G	
	100	E61	126	35	1,380	APXA6R3ARA101ME61G	180		J80	576	26	3,430	APXA160ARA181MJ80G	
	100	F46	315	40	1,670	APXA6R3ARA101MF46G	220		JCO	704	14	5,050	APXA160ARA221MJCOG	
	100	F61	126	27	2,400	APXA6R3ARA101MF61G	330		JCO	1,050	14	5,050	APXA160ARA331MJCOG	
	120	F61	151	27	2,400	APXA6R3ARA121MF61G	20	15	F46	150	57	1,300	APXA200ARA150MF46G	
	150	H70	189	25	3,020	APXA6R3ARA151MH70G		22	F61	88.0	50	1,650	APXA200ARA220MF61G	
	220	H70	277	25	3,020	APXA6R3ARA221MH70G		39	H70	156	45	2,000	APXA200ARA390MH70G	
330	J80	415	20	4,130	APXA6R3ARA331MJ80G	47		H70	188	45	2,000	APXA200ARA470MH70G		
390	HCO	491	12	4,770	APXA6R3ARA391MHC0G	82		J80	328	40	2,500	APXA200ARA820MJ80G		
470	HCO	592	12	4,770	APXA6R3ARA471MHC0G	150		JCO	600	20	4,320	APXA200ARA151MJCOG		
470	J80	592	20	4,130	APXA6R3ARA471MJ80G	23		15	F46	172	57	1,300	APXA230ARA150MF46G	
680	JCO	856	10	5,500	APXA6R3ARA681MJCOG		10	F61	125	65	1,500	APXA250ARA100MF61G		
820	JCO	1,030	10	5,500	APXA6R3ARA821MJCOG		25	22	H70	275	50	1,800	APXA250ARA220MH70G	
						39		J80	487	45	2,100	APXA250ARA390MJ80G		

◆RATED RIPPLE CURRENT MULTIPLIERS

● Frequency Multipliers

Frequency (Hz)	120	1k	10k	50k	100k to 500k
SMD type	0.05	0.30	0.55	0.70	1.00

NPCAP™-PXD Series

- Super low ESR, impedance and high heat resistance have been obtained by using conductive polymer as electrolyte.
- For automobile modules and other high temperature applications
- Endurance : 125°C 2,000 hours
- Rated voltage range : 2.5 to 10V_{dc}, Capacitance range : 47 to 470μF
- Solvent resistant type (see PRECAUTIONS AND GUIDELINES)
- RoHS2 Compliant
- Halogen Free
- AEC-Q200 compliant : Please contact Chemi-Con for more details, test data, information.

PXD

Longer life

PXH



◆ SPECIFICATIONS

Items	Characteristics			
Category	-55 to +125°C			
Temperature Range	-55 to +125°C			
Rated Voltage Range	2.5 to 10V _{dc}			
Capacitance Tolerance	±20% (M) (at 20°C, 120Hz)			
Leakage Current *Note	Shall not exceed values shown in STANDARD RATINGS. (at 20°C after 2 minutes)			
Dissipation Factor (tan δ)	0.12 max. (at 20°C, 120Hz)			
Low Temperature Characteristics (Max. Impedance Ratio)	$Z(-25^{\circ}\text{C})/Z(+20^{\circ}\text{C}) \leq 1.15$ $Z(-55^{\circ}\text{C})/Z(+20^{\circ}\text{C}) \leq 1.25$ (at 100kHz)			
Endurance	The following specifications shall be satisfied when the capacitors are restored to 20°C after the rated voltage is applied for 2,000 hours at 125°C.			
	Appearance	No significant damage		
	Capacitance change	$\leq \pm 20\%$ of the initial value		
	D.F. (tan δ)	$\leq 200\%$ of the initial specified value		
	ESR	$\leq 200\%$ of the initial specified value		
	Leakage current	\leq The initial specified value		
Bias Humidity	The following specifications shall be satisfied when the capacitors are restored to 20°C after subjecting them to the DC rated voltage at 60°C, 90 to 95% RH for 1,000 hours.			
	Appearance	No significant damage		
	Capacitance change	$\leq \pm 20\%$ of the initial value		
	D.F. (tan δ)	$\leq 150\%$ of the initial specified value		
	ESR	$\leq 150\%$ of the initial specified value		
	Leakage current	\leq The initial specified value		
Surge Voltage	The capacitors shall be subjected to 1,000 cycles each consisting of charge with the surge voltage specified at 125°C for 30 seconds through a protective resistor(R=1kΩ) and discharge for 5 minutes 30 seconds.			
	Rated voltage (V _{dc})	2.5	6.3	10
	Surge voltage (V _{dc})	2.9	7.2	12
	Appearance	No significant damage		
	Capacitance change	$\leq \pm 20\%$ of the initial value		
	D.F. (tan δ)	$\leq 150\%$ of the initial specified value		
	ESR	$\leq 150\%$ of the initial specified value		
	Leakage current	\leq The initial specified value		
Soldering Heat	The following specifications shall be satisfied when the solder temperature is reduced back to 20°C after soldering has been performed under the recommended soldering conditions.			
	Appearance	No significant damage		
	Capacitance value	Within the specified tolerance range		
	D.F. (tan δ)	\leq The initial specified value		
	ESR	\leq The initial specified value		
	Leakage current	\leq The initial specified value (Voltage treatment)		

*Note : If any doubt arises, measure the leakage current after the following voltage treatment.
Voltage treatment : DC rated voltage is applied to the capacitors for 120 minutes at 125°C.

◆ DIMENSIONS [mm]

- Terminal Code : A

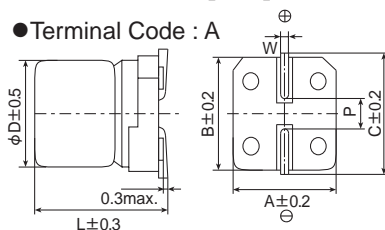

Size code	φD	L	A	B	C	W	P
E61	5	5.8	5.3	5.3	5.9	0.5 to 0.8	1.4
F61	6.3	5.8	6.6	6.6	7.2	0.5 to 0.8	1.9
H70	8	6.7	8.3	8.3	9.0	0.7 to 1.1	3.1
J80	10	7.7	10.3	10.3	11.0	0.7 to 1.1	4.5

◆ MARKING

EX) 10V330μF



NPCAP™-PXD Series

◆PART NUMBERING SYSTEM

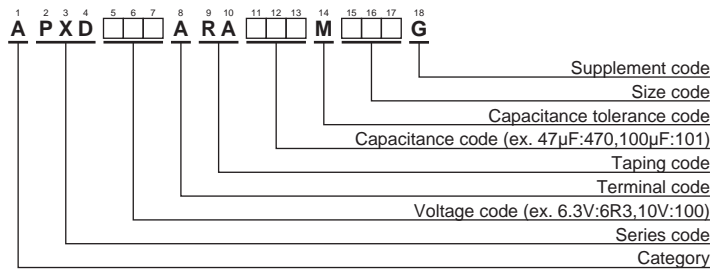

Please refer to "Product code guide (conductive polymer type)"

◆STANDARD RATINGS

WV (V _{dc})	Cap (μF)	Size code	Leakage current (μA max./after 2min.)	ESR (mΩ max./20°C, 100k to 300kHz)	Rated ripple current (mArms/100kHz)		Part No.
					-55°C ≤ Tx ≤ +105°C ^{*1}	+105°C < Tx ≤ +125°C ^{*1}	
2.5	120	E61	60.0	40	1,450	650	APXD2R5ARA121ME61G
	220	F61	110	30	2,500	770	APXD2R5ARA221MF61G
6.3	56	E61	70.5	45	1,380	600	APXD6R3ARA560ME61G
	100	F61	126	35	2,400	720	APXD6R3ARA101MF61G
	220	H70	277	30	3,020	960	APXD6R3ARA221MH70G
	470	J80	592	25	3,500	1,100	APXD6R3ARA471MJ80G
10	47	E61	94.0	50	1,270	550	APXD100ARA470ME61G
	56	F61	112	40	2,250	680	APXD100ARA560MF61G
	150	H70	300	35	2,800	880	APXD100ARA151MH70G
	330	J80	660	25	3,500	1,100	APXD100ARA331MJ80G

*1 Tx : Ambient temperature (°C)

◆RATED RIPPLE CURRENT MULTIPLIERS

● Frequency Multipliers

Frequency (Hz)	120	1k	10k	50k	100k to 500k
SMD type	0.05	0.30	0.55	0.70	1.00

NPCAP™-PXH Series Upgrade!

- Super low ESR, impedance and high heat resistance have been obtained by using conductive polymer as electrolyte.
- For AI servers, GPU computing, and other high temperature applications.
- Suitable for DC-DC converters, voltage regulators and decoupling applications.
- Endurance : 125°C 1,000 to 3,000 hours
- Rated voltage range : 2.5 to 20V_{dc}, Capacitance range : 22 to 1,000μF
- Case size range : φ 6.3x5.8L to φ 10x7.7L
- Solvent resistant type (see PRECAUTIONS AND GUIDELINES)
- RoHS2 Compliant
- Halogen Free



◆ SPECIFICATIONS

Items	Characteristics														
Category	-55 to +125°C														
Temperature Range															
Rated Voltage Range	2.5 to 20V _{dc}														
Capacitance Tolerance	±20% (M) (at 20°C, 120Hz)														
Leakage Current	Shall not exceed values shown in STANDARD RATINGS. (at 20°C after 2 minutes)														
*Note															
Dissipation Factor (tan δ)	0.12 max. (at 20°C, 120Hz)														
Low Temperature Characteristics (Max. Impedance Ratio)	Z(-25°C)/Z(+20°C) ≤ 1.15 Z(-55°C)/Z(+20°C) ≤ 1.25 (at 100kHz)														
Endurance	The following specifications shall be satisfied when the capacitors are restored to 20°C after the rated voltage is applied for 1,000 hours (F80 : 3,000 hours) at 125°C.														
	<table border="1"> <tr> <td>Appearance</td> <td>No significant damage</td> </tr> <tr> <td>Capacitance change</td> <td>≤ ±20% of the initial value</td> </tr> <tr> <td>D.F. (tan δ)</td> <td>≤ 200% of the initial specified value</td> </tr> <tr> <td>ESR</td> <td>≤ 200% of the initial specified value</td> </tr> <tr> <td>Leakage current</td> <td>≤ The initial specified value</td> </tr> </table>	Appearance	No significant damage	Capacitance change	≤ ±20% of the initial value	D.F. (tan δ)	≤ 200% of the initial specified value	ESR	≤ 200% of the initial specified value	Leakage current	≤ The initial specified value				
Appearance	No significant damage														
Capacitance change	≤ ±20% of the initial value														
D.F. (tan δ)	≤ 200% of the initial specified value														
ESR	≤ 200% of the initial specified value														
Leakage current	≤ The initial specified value														
Bias Humidity	The following specifications shall be satisfied when the capacitors are restored to 20°C after subjecting them to the DC rated voltage at 60°C, 90 to 95% RH for 1,000 hours.														
	<table border="1"> <tr> <td>Appearance</td> <td>No significant damage</td> </tr> <tr> <td>Capacitance change</td> <td>≤ ±20% of the initial value</td> </tr> <tr> <td>D.F. (tan δ)</td> <td>≤ 150% of the initial specified value</td> </tr> <tr> <td>ESR</td> <td>≤ 150% of the initial specified value</td> </tr> <tr> <td>Leakage current</td> <td>≤ The initial specified value</td> </tr> </table>	Appearance	No significant damage	Capacitance change	≤ ±20% of the initial value	D.F. (tan δ)	≤ 150% of the initial specified value	ESR	≤ 150% of the initial specified value	Leakage current	≤ The initial specified value				
Appearance	No significant damage														
Capacitance change	≤ ±20% of the initial value														
D.F. (tan δ)	≤ 150% of the initial specified value														
ESR	≤ 150% of the initial specified value														
Leakage current	≤ The initial specified value														
Surge Voltage	The capacitors shall be subjected to 1,000 cycles each consisting of charge with the surge voltage specified at 125°C (F80 : 105°C) for 30 seconds through a protective resistor (R=1kΩ) and discharge for 5 minutes and 30 seconds.														
	<table border="1"> <tr> <td>Rated voltage (V_{dc})</td> <td>2.5</td> <td>4.0</td> <td>6.3</td> <td>10</td> <td>16</td> <td>20</td> </tr> <tr> <td>Surge voltage (V_{dc})</td> <td>2.9</td> <td>4.6</td> <td>7.2</td> <td>12</td> <td>18</td> <td>23</td> </tr> </table>	Rated voltage (V _{dc})	2.5	4.0	6.3	10	16	20	Surge voltage (V _{dc})	2.9	4.6	7.2	12	18	23
Rated voltage (V _{dc})	2.5	4.0	6.3	10	16	20									
Surge voltage (V _{dc})	2.9	4.6	7.2	12	18	23									
	<table border="1"> <tr> <td>Appearance</td> <td>No significant damage</td> </tr> <tr> <td>Capacitance change</td> <td>≤ ±20% of the initial value</td> </tr> <tr> <td>D.F. (tan δ)</td> <td>≤ 150% of the initial specified value</td> </tr> <tr> <td>ESR</td> <td>≤ 150% of the initial specified value</td> </tr> <tr> <td>Leakage current</td> <td>≤ The initial specified value</td> </tr> </table>	Appearance	No significant damage	Capacitance change	≤ ±20% of the initial value	D.F. (tan δ)	≤ 150% of the initial specified value	ESR	≤ 150% of the initial specified value	Leakage current	≤ The initial specified value				
Appearance	No significant damage														
Capacitance change	≤ ±20% of the initial value														
D.F. (tan δ)	≤ 150% of the initial specified value														
ESR	≤ 150% of the initial specified value														
Leakage current	≤ The initial specified value														
Soldering Heat	The following specifications shall be satisfied when the solder temperature is reduced back to 20°C after soldering has been performed under the recommended soldering conditions.														
	<table border="1"> <tr> <td>Appearance</td> <td>No significant damage</td> </tr> <tr> <td>Capacitance value</td> <td>Within the specified tolerance range</td> </tr> <tr> <td>D.F. (tan δ)</td> <td>≤ The initial specified value</td> </tr> <tr> <td>ESR</td> <td>≤ The initial specified value</td> </tr> <tr> <td>Leakage current</td> <td>≤ The initial specified value (Voltage treatment)</td> </tr> </table>	Appearance	No significant damage	Capacitance value	Within the specified tolerance range	D.F. (tan δ)	≤ The initial specified value	ESR	≤ The initial specified value	Leakage current	≤ The initial specified value (Voltage treatment)				
Appearance	No significant damage														
Capacitance value	Within the specified tolerance range														
D.F. (tan δ)	≤ The initial specified value														
ESR	≤ The initial specified value														
Leakage current	≤ The initial specified value (Voltage treatment)														

*Note : If any doubt arises, measure the leakage current after the following voltage treatment.
Voltage treatment : DC rated voltage is applied to the capacitors for 120 minutes at 125°C.

◆ DIMENSIONS [mm]

● Terminal Code : A

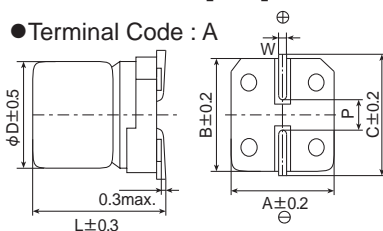

Size code	φD	L	A	B	C	W	P
F61	6.3	5.8	6.6	6.6	7.2	0.5 to 0.8	1.9
F80	6.3	7.7	6.6	6.6	7.2	0.5 to 0.8	1.9
H70	8	6.7	8.3	8.3	9.0	0.7 to 1.1	3.1
J80	10	7.7	10.3	10.3	11.0	0.7 to 1.1	4.5

* Please inquire about the vibration resistant structure.

◆ MARKING

EX) 20V22μF





NPCAP™-PXH Series Upgrade!

◆PART NUMBERING SYSTEM

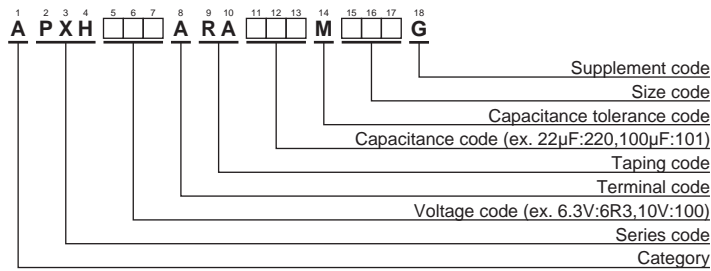

Please refer to "Product code guide (conductive polymer type)"

◆STANDARD RATINGS

WV (V _{dc})	Cap (μF)	Size code	Leakage current (μA max./after 2min.)	ESR (mΩ max./20°C, 100k to 300kHz)	Rated ripple current (mArms/100kHz)		Part No.
					-55°C ≤ Tx ≤ +105°C ^{*1}	+105°C < Tx ≤ +125°C ^{*1}	
2.5	220	F61	110	35	2,500	770	APXH2R5ARA221MF61G
	560	H70	280	30	3,100	960	APXH2R5ARA561MH70G
	820	F80	1,020	7	5,000	2,400	APXH2R5ARA821MF80G
	1,000	J80	500	25	3,700	1,100	APXH2R5ARA102MJ80G
4	150	F61	120	35	2,450	770	APXH4R0ARA151MF61G
	220	H70	176	30	3,020	960	APXH4R0ARA221MH70G
	680	J80	544	25	3,700	1,100	APXH4R0ARA681MJ80G
6.3	82	F61	103	40	2,400	720	APXH6R3ARA820MF61G
	100	F61	126	40	2,400	720	APXH6R3ARA101MF61G
	150	H70	189	30	3,020	960	APXH6R3ARA151MH70G
	220	H70	277	30	3,020	960	APXH6R3ARA221MH70G
	470	J80	592	25	3,700	1,100	APXH6R3ARA471MJ80G
10	56	F61	112	45	2,250	680	APXH100ARA560MF61G
	120	H70	240	35	2,800	880	APXH100ARA121MH70G
	150	H70	300	35	2,800	880	APXH100ARA151MH70G
	330	J80	660	30	3,700	1,010	APXH100ARA331MJ80G
16	39	F61	124	50	2,050	650	APXH160ARA390MF61G
	82	H70	262	40	2,700	830	APXH160ARA820MH70G
	150	J80	480	35	3,020	930	APXH160ARA151MJ80G
	180	J80	576	35	3,020	930	APXH160ARA181MJ80G
	270	F80	864	13	4,460	2,200	APXH160ARA271MF80G
20	22	F61	88.0	60	1,650	590	APXH200ARA220MF61G
	47	H70	188	45	2,000	780	APXH200ARA470MH70G
	82	J80	328	45	2,400	820	APXH200ARA820MJ80G

*1 Tx : Ambient temperature (°C)

New products are indicated in red text.

◆RATED RIPPLE CURRENT MULTIPLIERS

● Frequency Multipliers

Frequency (Hz)	120	1k	10k	50k	100k to 500k
2.5 to 6.3V _{dc}	0.05	0.30	0.55	0.70	1.00
10 to 20V _{dc}	0.05	0.25	0.55	0.55	1.00

NPCAP™-PSW Series

- Super low ESR, high ripple current capability
- Endurance: 5,000 hours at 105°C
- Rated voltage : 25V_{dc}, Capacitance range : 180 to 820μF
- RoHS2 Compliant
- Halogen Free

PSW

↑
Downsized
PSG



◆ SPECIFICATIONS

Items	Characteristics										
Category											
Temperature Range	-55 to +105°C										
Rated Voltage	25V _{dc}										
Capacitance Tolerance	±20% (M) (at 20°C, 120Hz)										
Leakage Current	I=0.2CV (at 20°C after 2 minutes)										
*Note	Where, I : Max. leakage current (μA), C : Nominal capacitance (μF), V : Rated voltage (V)										
Dissipation Factor (tan δ)	0.12 max. (at 20°C, 120Hz)										
Low Temperature Characteristics (Max.Impedance Ratio)	Z(-25°C)/Z(+20°C) ≤ 1.15 Z(-55°C)/Z(+20°C) ≤ 1.25 (at 100kHz)										
Endurance	The following specifications shall be satisfied when the capacitors are restored to 20°C after the rated voltage is applied for 5,000 hours at 105°C.										
	<table border="1"> <tr> <td>Appearance</td> <td>No significant damage</td> </tr> <tr> <td>Capacitance change</td> <td>≤ ±20% of the initial value</td> </tr> <tr> <td>D.F. (tan δ)</td> <td>≤ 150% of the initial specified value</td> </tr> <tr> <td>ESR</td> <td>≤ 150% of the initial specified value</td> </tr> <tr> <td>Leakage current</td> <td>≤ The initial specified value</td> </tr> </table>	Appearance	No significant damage	Capacitance change	≤ ±20% of the initial value	D.F. (tan δ)	≤ 150% of the initial specified value	ESR	≤ 150% of the initial specified value	Leakage current	≤ The initial specified value
Appearance	No significant damage										
Capacitance change	≤ ±20% of the initial value										
D.F. (tan δ)	≤ 150% of the initial specified value										
ESR	≤ 150% of the initial specified value										
Leakage current	≤ The initial specified value										
Bias Humidity Test	The following specifications shall be satisfied when the capacitors are restored to 20°C after subjecting them to DC voltage at 60°C, 90 to 95% RH for 1,000 hours.										
	<table border="1"> <tr> <td>Appearance</td> <td>No significant damage</td> </tr> <tr> <td>Capacitance change</td> <td>≤ ±20% of the initial value</td> </tr> <tr> <td>D.F. (tan δ)</td> <td>≤ The initial specified value</td> </tr> <tr> <td>ESR</td> <td>≤ 150% of the initial specified value</td> </tr> <tr> <td>Leakage current</td> <td>≤ The initial specified value</td> </tr> </table>	Appearance	No significant damage	Capacitance change	≤ ±20% of the initial value	D.F. (tan δ)	≤ The initial specified value	ESR	≤ 150% of the initial specified value	Leakage current	≤ The initial specified value
Appearance	No significant damage										
Capacitance change	≤ ±20% of the initial value										
D.F. (tan δ)	≤ The initial specified value										
ESR	≤ 150% of the initial specified value										
Leakage current	≤ The initial specified value										
Surge Voltage Test	The capacitors shall be subjected to 1,000 cycles each consisting of charge with the surge voltage specified at 105°C for 30 seconds through a protective resistor(R=1kΩ) and discharge for 5 minutes 30 seconds.										
	<table border="1"> <tr> <td>Rated voltage (V_{dc})</td> <td>25</td> </tr> <tr> <td>Surge voltage (V_{dc})</td> <td>29</td> </tr> </table>	Rated voltage (V _{dc})	25	Surge voltage (V _{dc})	29						
Rated voltage (V _{dc})	25										
Surge voltage (V _{dc})	29										
	<table border="1"> <tr> <td>Appearance</td> <td>No significant damage</td> </tr> <tr> <td>Capacitance change</td> <td>≤ ±20% of the initial value</td> </tr> <tr> <td>D.F. (tan δ)</td> <td>≤ The initial specified value</td> </tr> <tr> <td>ESR</td> <td>≤ 150% of the initial specified value</td> </tr> <tr> <td>Leakage current</td> <td>≤ The initial specified value</td> </tr> </table>	Appearance	No significant damage	Capacitance change	≤ ±20% of the initial value	D.F. (tan δ)	≤ The initial specified value	ESR	≤ 150% of the initial specified value	Leakage current	≤ The initial specified value
Appearance	No significant damage										
Capacitance change	≤ ±20% of the initial value										
D.F. (tan δ)	≤ The initial specified value										
ESR	≤ 150% of the initial specified value										
Leakage current	≤ The initial specified value										

*Note : If any doubt arises, measure the leakage current after the following voltage treatment.
Voltage treatment : DC rated voltage is applied to the capacitors for 120 minutes at 105°C.

◆ DIMENSIONS [mm]

- Terminal Code : E

F08,H08

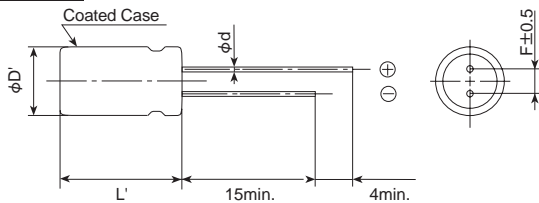

Size code	F08	H08	HB5	JB5
φD	6.3	8.0	10.0	
φd	0.6			
F	2.5	3.5	5.0	
φD'	φD+0.5max.			
L'	L+1.0max.		L+1.5max.	

HB5,JB5

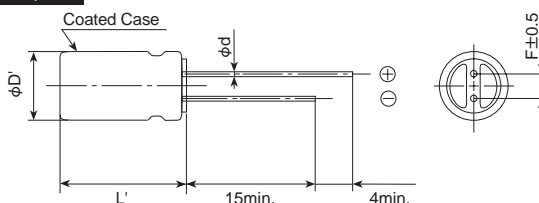

◆ MARKING

EX) 25V180μF





NPCAP™-PSW Series Upgrade!

◆PART NUMBERING SYSTEM

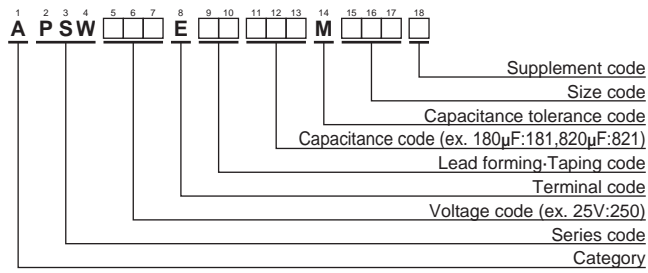

Please refer to "Product code guide (conductive polymer type)"

◆STANDARD RATINGS

WV (V _{dc})	Cap (µF)	Case size φD×L (mm)	ESR (mΩ max./20°C, 100k to 300kHz)	Rated ripple current (mA _{rms} /105°C, 100kHz)	Part No.
25	180	6.3 × 8	28	2,780	APSW250E□□181MF08S
	330	8 × 8	18	3,770	APSW250E□□331MH08S
	470	8 × 11.5	16	4,650	APSW250E□□471MHB5S
	820	10 × 11.5	14	5,000	APSW250E□□821MJB5S

□□ : Enter the appropriate lead forming or taping code.

◆RATED RIPPLE CURRENT MULTIPLIERS

● Frequency Multipliers

Frequency(Hz)	120	1k	10k	50k	100k to 500k
Radial lead type	0.10	0.35	0.60	0.80	1.00

NPCAP™-PSJ Series

- Super low ESR, high ripple current capability
- ESR 4mΩ max. lineup
- Endurance : 2,000 to 5,000 hours at 105°C
- Solvent resistant type (see PRECAUTIONS AND GUIDELINES)
- RoHS2 Compliant
- Halogen Free

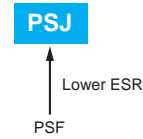

◆ SPECIFICATIONS

Items	Characteristics										
Category	-55 to +105°C										
Temperature Range											
Rated Voltage Range	2.5V _{dc}										
Capacitance Tolerance	±20% (M) (at 20°C, 120Hz)										
Leakage Current *Note	500μA max. (at 20°C after 2 minutes)										
Dissipation Factor (tan δ)	0.10 max. (at 20°C, 120Hz)										
Low Temperature Characteristics (Max.Impedance Ratio)	Z(-25°C)/Z(+20°C) ≤ 1.15 Z(-55°C)/Z(+20°C) ≤ 1.25 (at 100kHz)										
Endurance	The following specifications shall be satisfied when the capacitors are restored to 20°C after the rated voltage is applied for 5,000 hours (φ 5.4×8L : 2,000 hours) at 105°C.										
	<table border="1"> <tr><td>Appearance</td><td>No significant damage</td></tr> <tr><td>Capacitance change</td><td>≤ ±20% of the initial value</td></tr> <tr><td>D.F. (tan δ)</td><td>≤ 150% of the initial specified value</td></tr> <tr><td>ESR</td><td>≤ 150% of the initial specified value</td></tr> <tr><td>Leakage current</td><td>≤ The initial specified value</td></tr> </table>	Appearance	No significant damage	Capacitance change	≤ ±20% of the initial value	D.F. (tan δ)	≤ 150% of the initial specified value	ESR	≤ 150% of the initial specified value	Leakage current	≤ The initial specified value
Appearance	No significant damage										
Capacitance change	≤ ±20% of the initial value										
D.F. (tan δ)	≤ 150% of the initial specified value										
ESR	≤ 150% of the initial specified value										
Leakage current	≤ The initial specified value										
Bias Humidity Test	The following specifications shall be satisfied when the capacitors are restored to 20°C after subjecting them to DC voltage at 60°C, 90 to 95% RH for 1,000 hours.										
	<table border="1"> <tr><td>Appearance</td><td>No significant damage</td></tr> <tr><td>Capacitance change</td><td>≤ ±20% of the initial value</td></tr> <tr><td>D.F. (tan δ)</td><td>≤ 150% of the initial specified value</td></tr> <tr><td>ESR</td><td>≤ 150% of the initial specified value</td></tr> <tr><td>Leakage current</td><td>≤ The initial specified value</td></tr> </table>	Appearance	No significant damage	Capacitance change	≤ ±20% of the initial value	D.F. (tan δ)	≤ 150% of the initial specified value	ESR	≤ 150% of the initial specified value	Leakage current	≤ The initial specified value
Appearance	No significant damage										
Capacitance change	≤ ±20% of the initial value										
D.F. (tan δ)	≤ 150% of the initial specified value										
ESR	≤ 150% of the initial specified value										
Leakage current	≤ The initial specified value										
Surge Voltage Test	The capacitors shall be subjected to 1,000 cycles each consisting of charge with the surge voltage specified at 105°C for 30 seconds through a protective resistor(R=1kΩ) and discharge for 5 minutes 30 seconds.										
	<table border="1"> <tr><td>Rated voltage (V_{dc})</td><td>2.5</td></tr> <tr><td>Surge voltage (V_{dc})</td><td>2.9</td></tr> </table>	Rated voltage (V _{dc})	2.5	Surge voltage (V _{dc})	2.9						
Rated voltage (V _{dc})	2.5										
Surge voltage (V _{dc})	2.9										
	<table border="1"> <tr><td>Appearance</td><td>No significant damage</td></tr> <tr><td>Capacitance change</td><td>≤ ±20% of the initial value</td></tr> <tr><td>D.F. (tan δ)</td><td>≤ 150% of the initial specified value</td></tr> <tr><td>ESR</td><td>≤ 150% of the initial specified value</td></tr> <tr><td>Leakage current</td><td>≤ The initial specified value</td></tr> </table>	Appearance	No significant damage	Capacitance change	≤ ±20% of the initial value	D.F. (tan δ)	≤ 150% of the initial specified value	ESR	≤ 150% of the initial specified value	Leakage current	≤ The initial specified value
Appearance	No significant damage										
Capacitance change	≤ ±20% of the initial value										
D.F. (tan δ)	≤ 150% of the initial specified value										
ESR	≤ 150% of the initial specified value										
Leakage current	≤ The initial specified value										

*Note : If any doubt arises, measure the leakage current after the following voltage treatment.
Voltage treatment : DC rated voltage is applied to the capacitors for 120 minutes at 105°C.

◆ DIMENSIONS [mm]

● Terminal Code : E

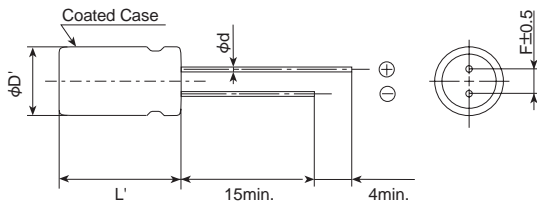

Size code	E08	F08
φD	5.4	6.3
φd	0.6	0.6
F	2.0	2.5
φD'	φD+0.5max.	
L'	L+1.5max.	

◆ MARKING

EX) 2.5V560μF





NPCAP™-PSJ Series

◆PART NUMBERING SYSTEM

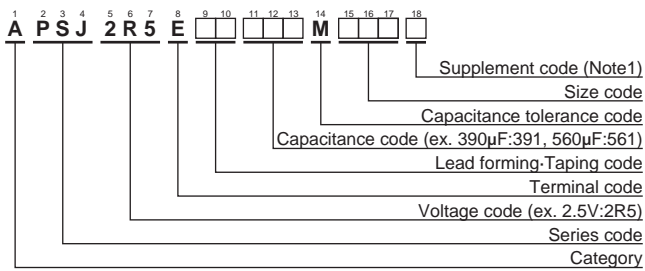

(Note1) : PSJ series, 2.5V560μF (ESR 4mΩ max.) has supplement code "J".
Terminal and terminal plating are the same as all other in PSJ series.

Please refer to "Product code guide (conductive polymer type)"

◆STANDARD RATINGS

WV (V _{dc})	Cap (μF)	Case size φD×L(mm)	ESR (mΩ max./20°C, 300kHz)	Rated ripple current (mArms/105°C, 100kHz)	Part No.
2.5	390	5.4 × 8	4	5,600	APSJ2R5E□□□391ME08S
	470	5.4 × 8	4.5	5,200	APSJ2R5E□□□471ME08S
	560	6.3 × 8	4	6,500	APSJ2R5E□□□561MF08J
	560	6.3 × 8	4.5	6,200	APSJ2R5E□□□561MF08S

□□ : Enter the appropriate lead forming or taping code.

◆RATED RIPPLE CURRENT MULTIPLIERS

⊙ Frequency Multipliers

Frequency (Hz)	120	1k	10k	50k	100k to 500k
Radial lead type	0.10	0.35	0.60	0.80	1.00

NPCAP™-PSG Series

- High capacitance model has been introduced to the product range.
- Super low ESR, high ripple current capability
- Endurance: 15,000 to 20,000 hours at 105°C
- Rated voltage : 16 to 35V_{dc}
- RoHS2 Compliant
- Halogen Free

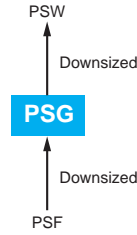

◆ SPECIFICATIONS

Items	Characteristics																				
Category	-55 to +105°C																				
Temperature Range																					
Rated Voltage	16 to 35V _{dc}																				
Capacitance Tolerance	±20% (M) (at 20°C, 120Hz)																				
Leakage Current *Note	I=0.2CV or 500µA, whichever is greater Where, I : Max. leakage current (µA), C : Nominal capacitance (µF), V : Rated voltage (V) (at 20°C after 2 minutes)																				
Dissipation Factor (tan δ)	0.12 max. (at 20°C, 120Hz)																				
Low Temperature Characteristics (Max.Impedance Ratio)	Z(-25°C)/Z(+20°C) ≤ 1.15 Z(-55°C)/Z(+20°C) ≤ 1.25 (at 100kHz)																				
Endurance	The following specifications shall be satisfied when the capacitors are restored to 20°C after the rated voltage is applied for 20,000 hours (20 to 35V : 15,000 hours) at 105°C. <table border="1"> <tr><td>Appearance</td><td>No significant damage</td></tr> <tr><td>Capacitance change</td><td>≤ ±20% of the initial value</td></tr> <tr><td>D.F. (tan δ)</td><td>≤ 150% of the initial specified value</td></tr> <tr><td>ESR</td><td>≤ 150% of the initial specified value</td></tr> <tr><td>Leakage current</td><td>≤ The initial specified value</td></tr> </table>	Appearance	No significant damage	Capacitance change	≤ ±20% of the initial value	D.F. (tan δ)	≤ 150% of the initial specified value	ESR	≤ 150% of the initial specified value	Leakage current	≤ The initial specified value										
Appearance	No significant damage																				
Capacitance change	≤ ±20% of the initial value																				
D.F. (tan δ)	≤ 150% of the initial specified value																				
ESR	≤ 150% of the initial specified value																				
Leakage current	≤ The initial specified value																				
Bias Humidity Test	The following specifications shall be satisfied when the capacitors are restored to 20°C after subjecting them to DC voltage at 60°C, 90 to 95% RH for 1,000 hours. <table border="1"> <tr><td>Appearance</td><td>No significant damage</td></tr> <tr><td>Capacitance change</td><td>≤ ±20% of the initial value</td></tr> <tr><td>D.F. (tan δ)</td><td>≤ The initial specified value</td></tr> <tr><td>ESR</td><td>≤ 150% of the initial specified value</td></tr> <tr><td>Leakage current</td><td>≤ The initial specified value</td></tr> </table>	Appearance	No significant damage	Capacitance change	≤ ±20% of the initial value	D.F. (tan δ)	≤ The initial specified value	ESR	≤ 150% of the initial specified value	Leakage current	≤ The initial specified value										
Appearance	No significant damage																				
Capacitance change	≤ ±20% of the initial value																				
D.F. (tan δ)	≤ The initial specified value																				
ESR	≤ 150% of the initial specified value																				
Leakage current	≤ The initial specified value																				
Surge Voltage Test	The capacitors shall be subjected to 1,000 cycles each consisting of charge with the surge voltage specified at 105°C for 30 seconds through a protective resistor(R=1kΩ) and discharge for 5 minutes 30 seconds. <table border="1"> <tr><td>Rated voltage (V_{dc})</td><td>16</td><td>20</td><td>25</td><td>35</td></tr> <tr><td>Surge voltage (V_{dc})</td><td>18</td><td>23</td><td>29</td><td>40</td></tr> </table> <table border="1"> <tr><td>Appearance</td><td>No significant damage</td></tr> <tr><td>Capacitance change</td><td>≤ ±20% of the initial value</td></tr> <tr><td>D.F. (tan δ)</td><td>≤ The initial specified value</td></tr> <tr><td>ESR</td><td>≤ 150% of the initial specified value</td></tr> <tr><td>Leakage current</td><td>≤ The initial specified value</td></tr> </table>	Rated voltage (V _{dc})	16	20	25	35	Surge voltage (V _{dc})	18	23	29	40	Appearance	No significant damage	Capacitance change	≤ ±20% of the initial value	D.F. (tan δ)	≤ The initial specified value	ESR	≤ 150% of the initial specified value	Leakage current	≤ The initial specified value
Rated voltage (V _{dc})	16	20	25	35																	
Surge voltage (V _{dc})	18	23	29	40																	
Appearance	No significant damage																				
Capacitance change	≤ ±20% of the initial value																				
D.F. (tan δ)	≤ The initial specified value																				
ESR	≤ 150% of the initial specified value																				
Leakage current	≤ The initial specified value																				

*Note : If any doubt arises, measure the leakage current after the following voltage treatment.
Voltage treatment : DC rated voltage is applied to the capacitors for 120 minutes at 105°C.

◆ DIMENSIONS [mm]

● Terminal Code : E

F05,F08,H08

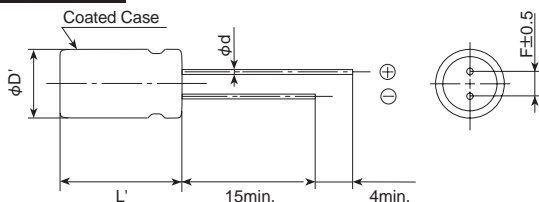

Size code	F05	F08	H08	HB5	H16	H20	JB5	J16	J20
φD	6.3		8.0			10.0			
φd	0.45		0.6						
F	2.5		3.5			5.0			
φD'	φD+0.5max.								
L'	L+1.0max. (Note1)			L+1.5max.					

Note1: L+1.2 max. for 16V270µF (Rated ripple current 5,080mArms), for 16V330µF (Rated ripple current 5,080mArms).

HB5,H16,H20,JB5,J16,J20

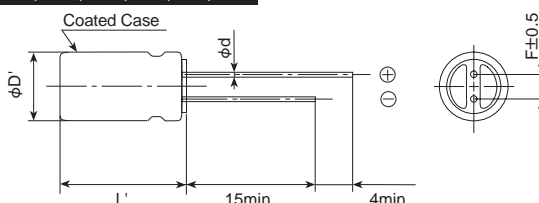

◆ MARKING

EX) 16V150µF





NPCAP™-PSG Series

◆PART NUMBERING SYSTEM

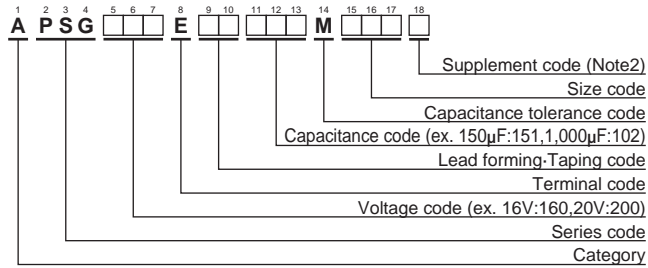

(Note2) : PSG series, 16V270μF (Rated ripple current 5,080mArms), 16V330μF (Rated ripple current 5,080mArms), 16V470μF (Rated ripple current 5,400mArms), 16V560μF (Rated ripple current 5,400mArms), 16V560μF (Rated ripple current 6,100mArms), and 16V680μF (Rated ripple current 6,100mArms) have supplement code "J". Terminal and terminal plating are the same as all others in the PSG series.

Please refer to "Product code guide (conductive polymer type)"

◆STANDARD RATINGS

WV (V _{dc})	Cap (μF)	Case size φ D × L (mm)	ESR (mΩ max./20°C, 100k to 300kHz)	Rated ripple current (mArms/105°C, 100kHz)	Part No.
16	150	6.3 × 5	20	3,200	APSG160E□□151MF05S
	270	6.3 × 8	10	5,080	APSG160E□□271MF08J
	270	6.3 × 8	15	3,800	APSG160E□□271MF08S
	330	6.3 × 8	10	5,080	APSG160E□□331MF08J
	330	6.3 × 8	15	3,800	APSG160E□□331MF08S
	470	8 × 8	8	5,400	APSG160E□□471MH08J
	470	8 × 8	16	4,000	APSG160E□□471MH08S
	560	8 × 8	8	5,400	APSG160E□□561MH08J
	560	8 × 8	16	4,000	APSG160E□□561MH08S
	560	8 × 11.5	8	6,100	APSG160E□□561MHB5J
	560	8 × 11.5	14	4,970	APSG160E□□561MHB5S
	680	8 × 11.5	8	6,100	APSG160E□□681MHB5J
	680	8 × 11.5	14	4,970	APSG160E□□681MHB5S
	820	8 × 16	8	7,000	APSG160E□□821MH16S
	820	10 × 11.5	12	5,400	APSG160E□□821MJB5S
	1,000	8 × 16	8	7,000	APSG160E□□102MH16S
	1,000	8 × 20	8	7,500	APSG160E□□102MH20S
	1,000	10 × 11.5	12	5,400	APSG160E□□102MJB5S
	1,200	8 × 20	8	7,500	APSG160E□□122MH20S
	1,200	10 × 11.5	12	5,400	APSG160E□□122MJB5S
1,500	8 × 20	8	7,500	APSG160E□□152MH20S	
1,500	10 × 16	8	7,700	APSG160E□□152MJ16S	
1,800	10 × 16	8	7,700	APSG160E□□182MJ16S	
1,800	10 × 20	8	8,100	APSG160E□□182MJ20S	
2,200	10 × 20	8	8,100	APSG160E□□222MJ20S	
2,700	10 × 20	8	8,100	APSG160E□□272MJ20S	
20	120	6.3 × 5	20	3,200	APSG200E□□121MF05S
	180	6.3 × 8	18	3,460	APSG200E□□181MF08S
	330	8 × 8	17	3,880	APSG200E□□331MH08S
	390	8 × 11.5	14	4,970	APSG200E□□391MHB5S
	680	8 × 16	10	6,260	APSG200E□□681MH16S
	680	10 × 11.5	12	5,400	APSG200E□□681MJB5S
25	56	6.3 × 5	30	2,600	APSG250E□□560MF05S
	82	6.3 × 8	28	2,780	APSG250E□□820MF08S
	100	6.3 × 8	28	2,780	APSG250E□□101MF08S
	120	6.3 × 8	28	2,780	APSG250E□□121MF08S
	150	6.3 × 8	28	2,780	APSG250E□□151MF08S
	180	8 × 8	18	3,770	APSG250E□□181MH08S
	180	8 × 11.5	16	4,650	APSG250E□□181MHB5S
	220	8 × 8	18	3,770	APSG250E□□221MH08S
	220	8 × 11.5	16	4,650	APSG250E□□221MHB5S
	270	8 × 8	18	3,770	APSG250E□□271MH08S
	270	8 × 11.5	16	4,650	APSG250E□□271MHB5S
	330	8 × 11.5	16	4,650	APSG250E□□331MHB5S
	330	10 × 11.5	14	5,000	APSG250E□□331MJB5S
	390	8 × 11.5	16	4,650	APSG250E□□391MHB5S
	390	10 × 11.5	14	5,000	APSG250E□□391MJB5S
	470	10 × 11.5	14	5,000	APSG250E□□471MJB5S
	560	8 × 16	14	5,400	APSG250E□□561MH16S
	560	10 × 11.5	14	5,000	APSG250E□□561MJB5S
680	10 × 11.5	14	5,000	APSG250E□□681MJB5S	
35	68	8 × 11.5	18	4,380	APSG350E□□680MHB5S
	120	10 × 11.5	16	4,670	APSG350E□□121MJB5S

□ □ : Enter the appropriate lead forming or taping code.

◆RATED RIPPLE CURRENT MULTIPLIERS

● Frequency Multipliers

Frequency (Hz)	120	1k	10k	50k	100k to 500k
Radial lead type	0.10	0.35	0.60	0.80	1.00



NPCAP™-PSK Series

- Super low ESR, high ripple current capability
- Downsized from PSE series (φ 6.3x8L to φ 5x8L)
- Long life (20,000 hours at 105°C)
- Solvent resistant type (see PRECAUTIONS AND GUIDELINES)
- RoHS2 Compliant
- Halogen Free

PSK

↑ Downsized
Longer life
PSE



◆ SPECIFICATIONS

Items	Characteristics										
Category	-55 to +105°C										
Temperature Range											
Rated Voltage Range	2.5 to 6.3 V _{dc}										
Capacitance Tolerance	±20% (M) (at 20°C, 120Hz)										
Leakage Current* ^{Note}	500μA max. (at 20°C after 2 minutes)										
Dissipation Factor (tan δ)	0.10 max. (at 20°C, 120Hz)										
Low Temperature Characteristics (Max.Impedance Ratio)	Z(-25°C)/Z(+20°C) ≤ 1.15 Z(-55°C)/Z(+20°C) ≤ 1.25 (at 100kHz)										
Endurance	The following specifications shall be satisfied when the capacitors are restored to 20°C after the rated voltage is applied for 20,000 hours at 105°C.										
	<table border="1"> <tr><td>Appearance</td><td>No significant damage</td></tr> <tr><td>Capacitance change</td><td>≤ ±20% of the initial value</td></tr> <tr><td>D.F. (tan δ)</td><td>≤ 150% of the initial specified value</td></tr> <tr><td>ESR</td><td>≤ 150% of the initial specified value</td></tr> <tr><td>Leakage current</td><td>≤ The initial specified value</td></tr> </table>	Appearance	No significant damage	Capacitance change	≤ ±20% of the initial value	D.F. (tan δ)	≤ 150% of the initial specified value	ESR	≤ 150% of the initial specified value	Leakage current	≤ The initial specified value
Appearance	No significant damage										
Capacitance change	≤ ±20% of the initial value										
D.F. (tan δ)	≤ 150% of the initial specified value										
ESR	≤ 150% of the initial specified value										
Leakage current	≤ The initial specified value										
Bias Humidity Test	The following specifications shall be satisfied when the capacitors are restored to 20°C after subjecting them to DC voltage at 60°C, 90 to 95% RH for 1,000 hours.										
	<table border="1"> <tr><td>Appearance</td><td>No significant damage</td></tr> <tr><td>Capacitance change</td><td>≤ ±20% of the initial value</td></tr> <tr><td>D.F. (tan δ)</td><td>≤ The initial specified value</td></tr> <tr><td>ESR</td><td>≤ The initial specified value</td></tr> <tr><td>Leakage current</td><td>≤ The initial specified value</td></tr> </table>	Appearance	No significant damage	Capacitance change	≤ ±20% of the initial value	D.F. (tan δ)	≤ The initial specified value	ESR	≤ The initial specified value	Leakage current	≤ The initial specified value
Appearance	No significant damage										
Capacitance change	≤ ±20% of the initial value										
D.F. (tan δ)	≤ The initial specified value										
ESR	≤ The initial specified value										
Leakage current	≤ The initial specified value										
Surge Voltage Test	The capacitors shall be subjected to 1,000 cycles each consisting of charge with the surge voltage specified at 105°C for 30 seconds through a protective resistor(R=1kΩ) and discharge for 5 minutes 30 seconds.										
	<table border="1"> <tr><td>Rated voltage (V_{dc})</td><td>2.5</td><td>4.0</td><td>6.3</td></tr> <tr><td>Surge voltage (V_{dc})</td><td>2.9</td><td>4.6</td><td>7.2</td></tr> </table>	Rated voltage (V _{dc})	2.5	4.0	6.3	Surge voltage (V _{dc})	2.9	4.6	7.2		
Rated voltage (V _{dc})	2.5	4.0	6.3								
Surge voltage (V _{dc})	2.9	4.6	7.2								
	<table border="1"> <tr><td>Appearance</td><td>No significant damage</td></tr> <tr><td>Capacitance change</td><td>≤ ±20% of the initial value</td></tr> <tr><td>D.F. (tan δ)</td><td>≤ The initial specified value</td></tr> <tr><td>ESR</td><td>≤ The initial specified value</td></tr> <tr><td>Leakage current</td><td>≤ The initial specified value</td></tr> </table>	Appearance	No significant damage	Capacitance change	≤ ±20% of the initial value	D.F. (tan δ)	≤ The initial specified value	ESR	≤ The initial specified value	Leakage current	≤ The initial specified value
Appearance	No significant damage										
Capacitance change	≤ ±20% of the initial value										
D.F. (tan δ)	≤ The initial specified value										
ESR	≤ The initial specified value										
Leakage current	≤ The initial specified value										

*Note : If any doubt arises, measure the leakage current after the following voltage treatment.
Voltage treatment : DC rated voltage is applied to the capacitors for 120 minutes at 105°C.

◆ DIMENSIONS [mm]

● Terminal Code : E

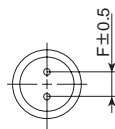
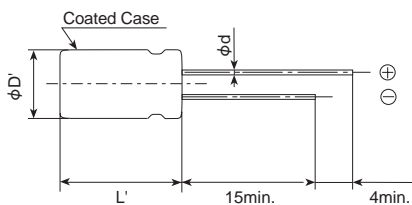

Size code	E08
φD	5.0
φd	0.5
F	2.0
φD'	φD+0.5max.
L'	L+1.0max.

◆ MARKING

EX) 2.5V560μF





NPCAP™-PSK Series

◆PART NUMBERING SYSTEM

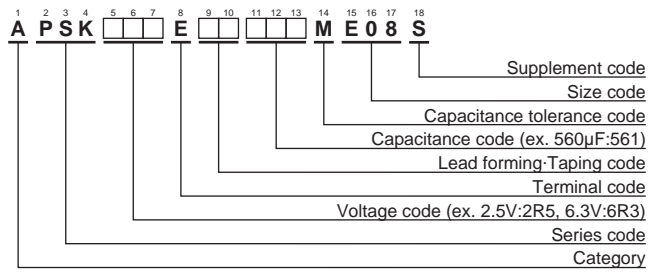

Please refer to "Product code guide (conductive polymer type)"

◆STANDARD RATINGS

WV (V _{dc})	Cap (μF)	Case size φD×L (mm)	ESR (mΩ max./20°C, 100k to 300kHz)	Rated ripple current (mA _{rms} /105°C, 100kHz)	Part No.
2.5	220	5 × 8	7	4,350	APSK2R5E□□221ME08S
	330	5 × 8	7	4,350	APSK2R5E□□331ME08S
	470	5 × 8	7	4,350	APSK2R5E□□471ME08S
	560	5 × 8	7	4,350	APSK2R5E□□561ME08S
4	330	5 × 8	8	4,050	APSK4R0E□□331ME08S
6.3	270	5 × 8	10	3,700	APSK6R3E□□271ME08S
	330	5 × 8	8	4,050	APSK6R3E□□331ME08S

□□ : Enter the appropriate lead forming or taping code.

◆RATED RIPPLE CURRENT MULTIPLIERS

● Frequency Multipliers

Frequency(Hz)	120	1k	10k	50k	100k to 500k
Radial lead type	0.10	0.35	0.60	0.80	1.00

NPCAP™-PSF Series

- Super low ESR, high ripple current capability
- ESR 5mΩmax. (2 to 4V_{dc})
- Longer life (20,000 hours at 105°C)
- Rated voltage range : 2 to 16V_{dc}
- Solvent resistant type (see PRECAUTIONS AND GUIDELINES)
- RoHS2 Compliant
- Halogen Free

PSF

Lower ESR
PSE



◆ SPECIFICATIONS

Items	Characteristics												
Category													
Temperature Range	-55 to +105°C												
Rated Voltage Range	2 to 16V _{dc}												
Capacitance Tolerance	±20%(M) (at 20°C, 120Hz)												
Leakage Current *Note	Shall not exceed values shown in STANDARD RATINGS. (at 20°C after 2 minutes)												
Dissipation Factor (tan δ)	0.10 max. (at 20°C, 120Hz)												
Low Temperature Characteristics (Max.Impedance Ratio)	Z(-25°C)/Z(+20°C) ≤ 1.15 Z(-55°C)/Z(+20°C) ≤ 1.25 (at 100kHz)												
Endurance	The following specifications shall be satisfied when the capacitors are restored to 20°C after the rated voltage is applied for 20,000 hours at 105°C.												
	<table border="1"> <tr> <td>Appearance</td> <td>No significant damage</td> </tr> <tr> <td>Capacitance change</td> <td>≤ ±20% of the initial value</td> </tr> <tr> <td>D.F. (tan δ)</td> <td>≤ 150% of the initial specified value</td> </tr> <tr> <td>ESR</td> <td>≤ 150% of the initial specified value</td> </tr> <tr> <td>Leakage current</td> <td>≤ The initial specified value</td> </tr> </table>	Appearance	No significant damage	Capacitance change	≤ ±20% of the initial value	D.F. (tan δ)	≤ 150% of the initial specified value	ESR	≤ 150% of the initial specified value	Leakage current	≤ The initial specified value		
Appearance	No significant damage												
Capacitance change	≤ ±20% of the initial value												
D.F. (tan δ)	≤ 150% of the initial specified value												
ESR	≤ 150% of the initial specified value												
Leakage current	≤ The initial specified value												
Bias Humidity Test	The following specifications shall be satisfied when the capacitors are restored to 20°C after subjecting them to DC voltage at 60°C, 90 to 95% RH for 1,000 hours.												
	<table border="1"> <tr> <td>Appearance</td> <td>No significant damage</td> </tr> <tr> <td>Capacitance change</td> <td>≤ ±20% of the initial value</td> </tr> <tr> <td>D.F. (tan δ)</td> <td>≤ The initial specified value</td> </tr> <tr> <td>ESR</td> <td>2 to 6.3V_{dc} : ≤ The initial specified value 16V_{dc} : ≤ 150% of the initial specified value</td> </tr> <tr> <td>Leakage current</td> <td>≤ The initial specified value</td> </tr> </table>	Appearance	No significant damage	Capacitance change	≤ ±20% of the initial value	D.F. (tan δ)	≤ The initial specified value	ESR	2 to 6.3V _{dc} : ≤ The initial specified value 16V _{dc} : ≤ 150% of the initial specified value	Leakage current	≤ The initial specified value		
Appearance	No significant damage												
Capacitance change	≤ ±20% of the initial value												
D.F. (tan δ)	≤ The initial specified value												
ESR	2 to 6.3V _{dc} : ≤ The initial specified value 16V _{dc} : ≤ 150% of the initial specified value												
Leakage current	≤ The initial specified value												
Surge Voltage Test	The capacitors shall be subjected to 1,000 cycles each consisting of charge with the surge voltage specified at 105°C for 30 seconds through a protective resistor(R=1kΩ) and discharge for 5 minutes 30 seconds.												
	<table border="1"> <tr> <td>Rated voltage (V_{dc})</td> <td>2.0</td> <td>2.5</td> <td>4.0</td> <td>6.3</td> <td>16</td> </tr> <tr> <td>Surge voltage (V_{dc})</td> <td>2.3</td> <td>2.9</td> <td>4.6</td> <td>7.2</td> <td>18</td> </tr> </table>	Rated voltage (V _{dc})	2.0	2.5	4.0	6.3	16	Surge voltage (V _{dc})	2.3	2.9	4.6	7.2	18
Rated voltage (V _{dc})	2.0	2.5	4.0	6.3	16								
Surge voltage (V _{dc})	2.3	2.9	4.6	7.2	18								
	<table border="1"> <tr> <td>Appearance</td> <td>No significant damage</td> </tr> <tr> <td>Capacitance change</td> <td>≤ ±20% of the initial value</td> </tr> <tr> <td>D.F. (tan δ)</td> <td>≤ The initial specified value</td> </tr> <tr> <td>ESR</td> <td>2 to 6.3V_{dc} : ≤ The initial specified value 16V_{dc} : ≤ 150% of the initial specified value</td> </tr> <tr> <td>Leakage current</td> <td>≤ The initial specified value</td> </tr> </table>	Appearance	No significant damage	Capacitance change	≤ ±20% of the initial value	D.F. (tan δ)	≤ The initial specified value	ESR	2 to 6.3V _{dc} : ≤ The initial specified value 16V _{dc} : ≤ 150% of the initial specified value	Leakage current	≤ The initial specified value		
Appearance	No significant damage												
Capacitance change	≤ ±20% of the initial value												
D.F. (tan δ)	≤ The initial specified value												
ESR	2 to 6.3V _{dc} : ≤ The initial specified value 16V _{dc} : ≤ 150% of the initial specified value												
Leakage current	≤ The initial specified value												

*Note : If any doubt arises, measure the leakage current after the following voltage treatment.
Voltage treatment : DC rated voltage is applied to the capacitors for 120 minutes at 105°C.

◆ DIMENSIONS [mm]

● Terminal Code : E

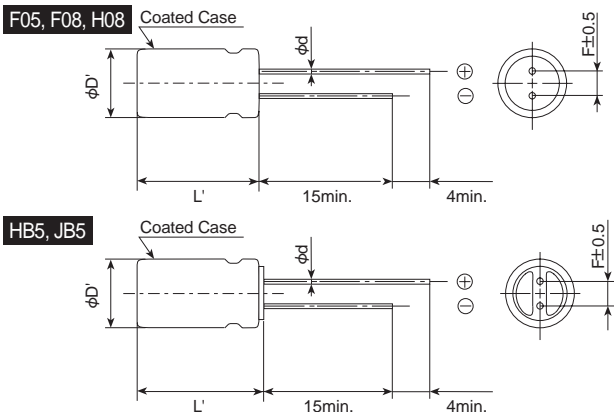

Size code	F05	F08	H08	HB5	JB5
φD	6.3		8.0		10.0
φd	0.45		0.6		
F	2.5		3.5		5.0
φD'	φD+0.5max.				
Note 1	L+1.2max. for 6.3V820μF, 1.5max.				

◆ MARKING

EX) 2.5V560μF

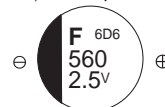

NPCAP™-PSF Series

◆PART NUMBERING SYSTEM

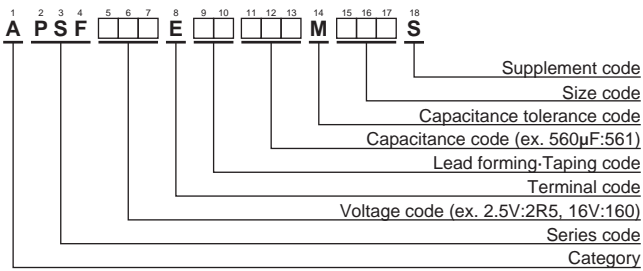

Please refer to "Product code guide (conductive polymer type)"

◆STANDARD RATINGS

WV (V _{dc})	Cap (µF)	Case size φD×L(mm)	Leakage current (µA max./after 2min.)	ESR (mΩ max./20°C, 100k to 300kHz)	Rated ripple current (mArms/105°C, 100kHz)	Part No.
2	1,000	6.3×8	500	5	5,900	APSF2R0E□□102MF08S
	330	6.3×8	500	5	5,900	APSF2R5E□□331MF08S
2.5	470	6.3×8	500	5	5,900	APSF2R5E□□471MF08S
	560	6.3×8	500	5	5,900	APSF2R5E□□561MF08S
	820	6.3×8	500	5	5,900	APSF2R5E□□821MF08S
	1,200	6.3×8	1,200	5	5,900	APSF2R5E□□122MF08S
	1,600	8×8	800	5	6,100	APSF2R5E□□162MH08S
	470	6.3×8	500	5	5,900	APSF4R0E□□471MF08S
4	560	6.3×8	500	5	5,900	APSF4R0E□□561MF08S
	820	6.3×8	1,030	8	4,700	APSF6R3E□□821MF08S
16	100	6.3×5	500	24	2,490	APSF160E□□101MF05S
	270	8×8	864	10	5,000	APSF160E□□271MH08S
	270	8×11.5	864	11	5,080	APSF160E□□271MHB5S
	330	8×8	1,050	13	4,700	APSF160E□□331MH08S
	470	8×11.5	1,500	11	5,400	APSF160E□□471MHB5S
	470	10×11.5	1,500	10	6,100	APSF160E□□471MJB5S

□□ : Enter the appropriate lead forming or taping code.

◆RATED RIPPLE CURRENT MULTIPLIERS

● Frequency Multipliers

Frequency(Hz)	120	1k	10k	50k	100k to 500k
Radial lead type	0.10	0.35	0.60	0.80	1.00

NPCAP™-PSE Series

- Super low ESR, high ripple current capability
- Endurance : 20,000 hours at 105°C
- Rated voltage range : 2.5 to 6.3V_{dc}
- Solvent resistant type (see PRECAUTIONS AND GUIDELINES)
- RoHS2 Compliant
- Halogen Free

PSE

↑ Longer life
Downsized
PSC



◆ SPECIFICATIONS

Items	Characteristics																		
Category	-55 to +105°C																		
Temperature Range																			
Rated Voltage Range	2.5 to 6.3V _{dc}																		
Capacitance Tolerance	±20% (M) (at 20°C, 120Hz)																		
Leakage Current *Note	I=0.2CV or 500μA, whichever is greater Where, I : Max. leakage current (μA), C : Nominal capacitance (μF), V : Rated voltage (V) (at 20°C after 2 minutes)																		
Dissipation Factor (tan δ)	0.10 max. (at 20°C, 120Hz)																		
Low Temperature Characteristics (Max.Impedance Ratio)	Z(-25°C)/Z(+20°C) ≤ 1.15 Z(-55°C)/Z(+20°C) ≤ 1.25 (at 100kHz)																		
Endurance	The following specifications shall be satisfied when the capacitors are restored to 20°C after the rated voltage is applied for 20,000 hours at 105°C. <table border="1"> <tr><td>Appearance</td><td>No significant damage</td></tr> <tr><td>Capacitance change</td><td>≤ ±20% of the initial value</td></tr> <tr><td>D.F. (tan δ)</td><td>≤ 150% of the initial specified value</td></tr> <tr><td>ESR</td><td>≤ 200% of the initial specified value</td></tr> <tr><td>Leakage current</td><td>≤ The initial specified value</td></tr> </table>	Appearance	No significant damage	Capacitance change	≤ ±20% of the initial value	D.F. (tan δ)	≤ 150% of the initial specified value	ESR	≤ 200% of the initial specified value	Leakage current	≤ The initial specified value								
Appearance	No significant damage																		
Capacitance change	≤ ±20% of the initial value																		
D.F. (tan δ)	≤ 150% of the initial specified value																		
ESR	≤ 200% of the initial specified value																		
Leakage current	≤ The initial specified value																		
Bias Humidity Test	The following specifications shall be satisfied when the capacitors are restored to 20°C after subjecting them to DC voltage at 60°C, 90 to 95% RH for 1,000 hours. <table border="1"> <tr><td>Appearance</td><td>No significant damage</td></tr> <tr><td>Capacitance change</td><td>≤ ±20% of the initial value</td></tr> <tr><td>D.F. (tan δ)</td><td>≤ The initial specified value</td></tr> <tr><td>ESR</td><td>≤ The initial specified value</td></tr> <tr><td>Leakage current</td><td>≤ The initial specified value</td></tr> </table>	Appearance	No significant damage	Capacitance change	≤ ±20% of the initial value	D.F. (tan δ)	≤ The initial specified value	ESR	≤ The initial specified value	Leakage current	≤ The initial specified value								
Appearance	No significant damage																		
Capacitance change	≤ ±20% of the initial value																		
D.F. (tan δ)	≤ The initial specified value																		
ESR	≤ The initial specified value																		
Leakage current	≤ The initial specified value																		
Surge Voltage Test	The capacitors shall be subjected to 1,000 cycles each consisting of charge with the surge voltage specified at 105°C for 30 seconds through a protective resistor(R=1kΩ) and discharge for 5 minutes 30 seconds. <table border="1"> <tr><td>Rated voltage (V_{dc})</td><td>2.5</td><td>4.0</td><td>6.3</td></tr> <tr><td>Surge voltage (V_{dc})</td><td>2.9</td><td>4.6</td><td>7.2</td></tr> </table> <table border="1"> <tr><td>Appearance</td><td>No significant damage</td></tr> <tr><td>Capacitance change</td><td>≤ ±20% of the initial value</td></tr> <tr><td>D.F. (tan δ)</td><td>≤ The initial specified value</td></tr> <tr><td>ESR</td><td>≤ The initial specified value</td></tr> <tr><td>Leakage current</td><td>≤ The initial specified value</td></tr> </table>	Rated voltage (V _{dc})	2.5	4.0	6.3	Surge voltage (V _{dc})	2.9	4.6	7.2	Appearance	No significant damage	Capacitance change	≤ ±20% of the initial value	D.F. (tan δ)	≤ The initial specified value	ESR	≤ The initial specified value	Leakage current	≤ The initial specified value
Rated voltage (V _{dc})	2.5	4.0	6.3																
Surge voltage (V _{dc})	2.9	4.6	7.2																
Appearance	No significant damage																		
Capacitance change	≤ ±20% of the initial value																		
D.F. (tan δ)	≤ The initial specified value																		
ESR	≤ The initial specified value																		
Leakage current	≤ The initial specified value																		

*Note : If any doubt arises, measure the leakage current after the following voltage treatment.
Voltage treatment : DC rated voltage is applied to the capacitors for 120 minutes at 105°C.

◆ DIMENSIONS [mm]

● Terminal Code : E

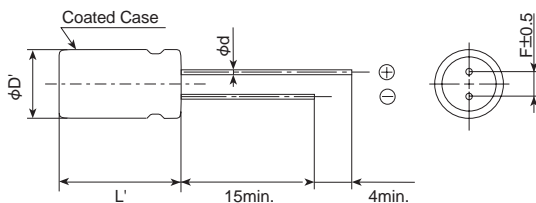

Size code	F08
φD	6.3
φd	0.6
F	2.5
φD'	φD+0.5max.
L'	L+1.5max.

◆ MARKING

EX) 2.5V820μF





NPCAP™-PSE Series

◆PART NUMBERING SYSTEM

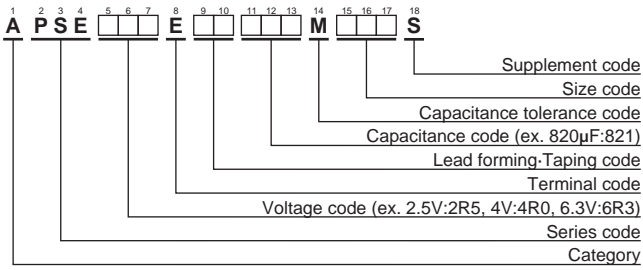

Please refer to "Product code guide (conductive polymer type)"

◆STANDARD RATINGS

WV (V _{dc})	Cap (μF)	Case size φ D×L(mm)	ESR (mΩ max./20°C, 100k to 300kHz)	Rated ripple current (mA _{rms} /105°C, 100kHz)	Part No.
2.5	820	6.3 × 8	7	5,000	APSE2R5E[][]821MF08S
4	560	6.3 × 8	7	5,000	APSE4R0E[][]561MF08S
6.3	470	6.3 × 8	8	4,700	APSE6R3E[][]471MF08S
	560	6.3 × 8	8	4,700	APSE6R3E[][]561MF08S

[][] : Enter the appropriate lead forming or taping code.

◆RATED RIPPLE CURRENT MULTIPLIERS

⊙ Frequency Multipliers

Frequency(Hz)	120	1k	10k	50k	100k to 500k
Radial lead type	0.10	0.35	0.60	0.80	1.00

NPCAP™-PSC Series

- Super low ESR, high ripple current capability
- Rated voltage range : 2.5 to 16V_{dc}
- Nominal capacitance range : 270 to 2,700μF
- Endurance : 15,000 hours at 105°C
- Suitable for DC-DC converters, voltage regulators and decoupling applications for computer motherboards
- Added 2.5V 820μF (ESR 5mΩ max.)
- Solvent resistant type (see PRECAUTIONS AND GUIDELINES)
- RoHS2 Compliant
- Halogen Free

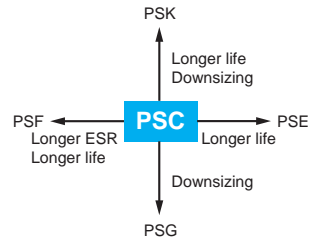

◆ SPECIFICATIONS

Items	Characteristics																						
Category Temperature Range	-55 to +105°C																						
Rated Voltage Range	2.5 to 16V _{dc}																						
Capacitance Tolerance	±20% (M) (at 20°C, 120Hz)																						
Leakage Current <small>*Note</small>	I=0.2CV or 500μA, whichever is greater. Where, I : Max. leakage current (μA), C : Nominal capacitance (μF), V : Rated voltage (V _{dc}) (at 20°C after 2 minutes)																						
Dissipation Factor (tan δ)	0.10 max. (at 20°C, 120Hz)																						
Low Temperature Characteristics (Max.Impedance Ratio)	Z(-25°C)/Z(+20°C) ≤ 1.15 Z(-55°C)/Z(+20°C) ≤ 1.25 (at 100kHz)																						
Endurance	The following specifications shall be satisfied when the capacitors are restored to 20°C after the rated voltage is applied for 15,000 hours at 105°C. <table border="1"> <tr><td>Appearance</td><td>No significant damage</td></tr> <tr><td>Capacitance change</td><td>≤ ±20% of the initial value</td></tr> <tr><td>D.F. (tan δ)</td><td>≤ 150% of the initial specified value</td></tr> <tr><td>ESR</td><td>≤ 150% of the initial specified value</td></tr> <tr><td>Leakage current</td><td>≤ The initial specified value</td></tr> </table>	Appearance	No significant damage	Capacitance change	≤ ±20% of the initial value	D.F. (tan δ)	≤ 150% of the initial specified value	ESR	≤ 150% of the initial specified value	Leakage current	≤ The initial specified value												
Appearance	No significant damage																						
Capacitance change	≤ ±20% of the initial value																						
D.F. (tan δ)	≤ 150% of the initial specified value																						
ESR	≤ 150% of the initial specified value																						
Leakage current	≤ The initial specified value																						
Bias Humidity Test	The following specifications shall be satisfied when the capacitors are restored to 20°C after subjecting them to DC voltage at 60°C, 90 to 95% RH for 1,000 hours. <table border="1"> <tr><td>Appearance</td><td>No significant damage</td></tr> <tr><td>Capacitance change</td><td>≤ ±20% of the initial value</td></tr> <tr><td>D.F. (tan δ)</td><td>≤ 150% of the initial specified value</td></tr> <tr><td>ESR</td><td>≤ 150% of the initial specified value</td></tr> <tr><td>Leakage current</td><td>≤ The initial specified value</td></tr> </table>	Appearance	No significant damage	Capacitance change	≤ ±20% of the initial value	D.F. (tan δ)	≤ 150% of the initial specified value	ESR	≤ 150% of the initial specified value	Leakage current	≤ The initial specified value												
Appearance	No significant damage																						
Capacitance change	≤ ±20% of the initial value																						
D.F. (tan δ)	≤ 150% of the initial specified value																						
ESR	≤ 150% of the initial specified value																						
Leakage current	≤ The initial specified value																						
Surge Voltage Test	The capacitors shall be subjected to 1,000 cycles each consisting of charge with the surge voltage specified at 105°C for 30 seconds through a protective resistor(R=1kΩ) and discharge for 5 minutes 30 seconds. <table border="1"> <tr><td>Rated voltage (V_{dc})</td><td>2.5</td><td>4.0</td><td>6.3</td><td>10</td><td>16</td></tr> <tr><td>Surge voltage (V_{dc})</td><td>2.9</td><td>4.6</td><td>7.2</td><td>12</td><td>18</td></tr> </table> <table border="1"> <tr><td>Appearance</td><td>No significant damage</td></tr> <tr><td>Capacitance change</td><td>≤ ±20% of the initial value</td></tr> <tr><td>D.F. (tan δ)</td><td>≤ 150% of the initial specified value</td></tr> <tr><td>ESR</td><td>≤ 150% of the initial specified value</td></tr> <tr><td>Leakage current</td><td>≤ The initial specified value</td></tr> </table>	Rated voltage (V _{dc})	2.5	4.0	6.3	10	16	Surge voltage (V _{dc})	2.9	4.6	7.2	12	18	Appearance	No significant damage	Capacitance change	≤ ±20% of the initial value	D.F. (tan δ)	≤ 150% of the initial specified value	ESR	≤ 150% of the initial specified value	Leakage current	≤ The initial specified value
Rated voltage (V _{dc})	2.5	4.0	6.3	10	16																		
Surge voltage (V _{dc})	2.9	4.6	7.2	12	18																		
Appearance	No significant damage																						
Capacitance change	≤ ±20% of the initial value																						
D.F. (tan δ)	≤ 150% of the initial specified value																						
ESR	≤ 150% of the initial specified value																						
Leakage current	≤ The initial specified value																						

*Note : If any doubt arises, measure the leakage current after the following voltage treatment.
Voltage treatment : DC rated voltage is applied to the capacitors for 120 minutes at 105°C.

◆ DIMENSIONS [mm]

- Terminal Code : E

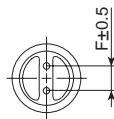
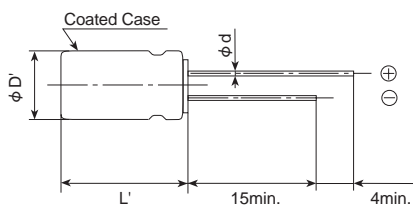

Size code	H08	HB5	JB5	JC5
φ D	8.0	8.0	10.0	10.0
φ d	0.6	0.8(Note1)	0.8(Note1)	0.6
F	3.5	3.5	5.0	5.0
φ D'	φ D+0.5max.			
L'	L+1.0max.		L+1.5max.	

Note 1 : 0.6 for rated volt 16V.

◆ MARKING

EX) 2.5V820μF



NPCAP™-PSC Series

◆PART NUMBERING SYSTEM

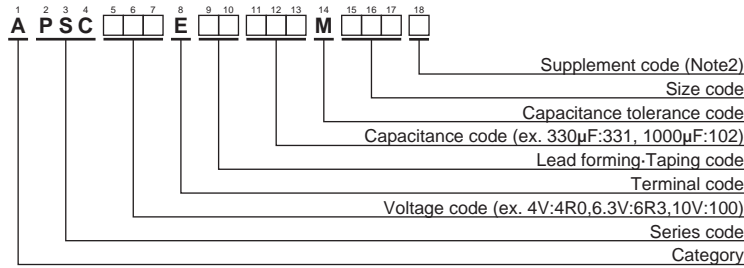

(Note2) PSC series, 2.5V820μF(ESR 5mΩ max.) has supplement code "J".
Can case, terminal and terminal plating are the same as all others in PSC series.

Please refer to "Product code guide (conductive polymer type)"

◆STANDARD RATINGS

WV (V _{dc})	Cap (μF)	Case size φ D×L(mm)	ESR (mΩ max./20°C, 100k to 300kHz)	Rated ripple current (mA rms/105°C, 100kHz)	Part No.
2.5	560	8×8	7	6,100	APSC2R5E□□561MH08S
	820	8×8	5	6,100	APSC2R5E□□821MH08J
	820	8×8	7	6,100	APSC2R5E□□821MH08S
	1,000	8×8	7	6,100	APSC2R5E□□102MH08S
	1,000	8×11.5	7	6,100	APSC2R5E□□102MHB5S
	1,500	8×11.5	7	6,100	APSC2R5E□□152MHB5S
2,700	10×11.5	8	5,560	APSC2R5E□□272MJB5S	
4	560	8×8	7	6,100	APSC4R0E□□561MH08S
	680	8×11.5	7	6,100	APSC4R0E□□681MHB5S
	1,000	10×11.5	6	6,640	APSC4R0E□□102MJB5S
6.3	470	8×8	8	5,700	APSC6R3E□□471MH08S
	560	8×8	8	5,700	APSC6R3E□□561MH08S
	820	10×11.5	7	6,640	APSC6R3E□□821MJB5S
	1,500	10×11.5	10	5,560	APSC6R3E□□152MJB5S
10	390	8×11.5	9	5,650	APSC100E□□391MHB5S
	680	10×11.5	7	6,100	APSC100E□□681MJB5S
16	270	8×11.5	11	5,080	APSC160E□□271MHB5S
	330	10×11.5	10	6,100	APSC160E□□331MJB5S
	330	10×12.5	10	6,100	APSC160E□□331MJC5S
	470	10×11.5	10	6,100	APSC160E□□471MJB5S

□□ : Enter the appropriate lead forming or taping code.

◆RATED RIPPLE CURRENT MULTIPLIERS

● Frequency Multipliers

Frequency(Hz)	120	1k	10k	50k	100k to 500k
Radial lead type	0.10	0.35	0.60	0.80	1.00

Conductive Polymer Hybrid Aluminum Electrolytic Capacitors





PRECAUTIONS AND GUIDELINES (Conductive Polymer Hybrid)

Conductive Polymer Hybrid Aluminum Electrolytic Capacitors (Hereinafter called capacitor) that uses highly conductive polymer electrolytic materials and electrolyte. Please read the following in order to get the most out of your capacitor. The circuits described as examples in this catalog and the "delivery specifications" are featured in order to show the operations and usage of our products, however, this fact does not guarantee that the circuits are available to function in your equipment systems.

We are not in any case responsible for any failures or damage caused by the use of information contained herein.

You should examine our products, of which the characteristics are described in the "delivery specifications" and other documents, and determine whether or not our products suit your requirements according to the specifications of your equipment systems. Therefore, you bear final responsibility regarding the use of our products.

Please make sure that you take appropriate safety measures such as use of redundant design and malfunction prevention measures in order to prevent fatal accidents and/or fires in the event any of our products malfunction.

For Conductive Polymer Aluminum Solid Capacitors, see Precautions and Guidelines (Conductive Polymer).

For Aluminum Electrolytic Capacitors, see Precautions and Guidelines (Aluminum Electrolytic Capacitors).

1) Device circuits design considerations

1) Confirm installation and operating requirements for the capacitors, then use them within the performance limits prescribed in this catalog or product specifications.

2) Polarity

Capacitors are polarized.

Never apply a reverse voltage or AC voltage. Connecting with wrong polarity will short-circuit or damage the capacitor with the pressure relief vent opening early on. To identify the polarity of a capacitor, see the relevant diagram in the catalogs or product specifications, or the polarity marking on the body of the capacitors.

3) Operating voltage

Do not apply an over-voltage that exceeds a rated voltage specified for the capacitors.

The total peak value of the ripple voltage plus the DC voltage must not exceed the rated voltage of the capacitors. Capacitors do not require voltage derating within the category temperature. Although capacitors specify a surge voltage that exceeds the full rated voltage, it does not assure long-term use but limited use under specific conditions.

4) Ripple current

Do not apply an over current that exceeds the rated ripple current specified for the capacitors. Excessive ripple current will increase heat production within the capacitors, causing the capacitors to be damaged as follows:

- Shorten lifetime
- Open pressure relief vent
- Short circuit

At the time of low DC bias voltage, reverse voltage may be applied if uses with less than rated ripple current. Please use it as far as the reverse voltage is not applied. The rated ripple current is specified along with a specific ripple frequency. Where using the capacitors at any ripple frequency other than the specified frequency, calculate the allowable ripple current by multiplying the rated ripple current by a frequency compensation factor (Frequency Multiplier) specified for each product series.

5) Operating temperature (Category temperature)

Do not apply high temperatures that exceed the upper limit of the category temperature range specified for the capacitors.

Using the capacitors at temperatures higher than the upper limit will considerably shorten the lifetime of the capacitors and make the pressure relief vent open. The temperature, please confirm the temperature of the capacitors which included the ambient temperature of the device, not only the temperature in the device but also radiant heat of the heating element (power transistor, resistance) in the apparatus, self heating caused by the ripple current. Additionally, please do not place heating ele-

ment on the back side of the capacitors. In addition, please use the capacitors within category temperature range because the life of the capacitors are affected by the operating temperature. In other words, lowering ambient temperatures will extend the expected lifetime of the capacitors.

6) Lifetime

Select the capacitors to meet the service life requirements of device.

7) Charging and discharging

Do not use capacitors in circuits intended for rapid charge and discharge cycle operations.

If capacitors are used in the circuits that repeat a charge and discharge with a large voltage drop or a rapid charge and discharge at short interval cycle, capacitance will decrease and/or the capacitors will be damaged by internal heat generation.

Please consult us the capacitors to use for the circuit where rapid charge and discharge is repeated.

Please be careful about rush currents. Recommend to install protective circuit.

8) Leakage current

The leakage current may increase due to thermal stress such as reflow soldering. After that, however, the leakage current will gradually decrease by self-healing action of the dielectric oxide layer when the capacitors are applied with a voltage less than the rated voltage within the Category Temperature range. As the voltage is closer to the rated voltage and the temperature is closer to the upper limit of Category Temperature range, the leakage current decreases faster.

The leakage current will increase by the following factors,

- ① Soldering
- ② Testing of high temperature exposure with no voltage applied, high temperature/humidity storage, temperature cycles, etc.

9) Failure mode of capacitors

Non-solid aluminum electrolytic capacitors have a limited lifetime which ends in an open circuit failure mode, in general.

Depending on the product type and operating conditions, the failure mode may involve in opening of the pressure relief vent. But it may lead to shot circuit mode failure when capacitor is used in the overload more than the guarantee ranges including over voltage and the over current.

Failure modes depend on the application conditions that lead to fail.

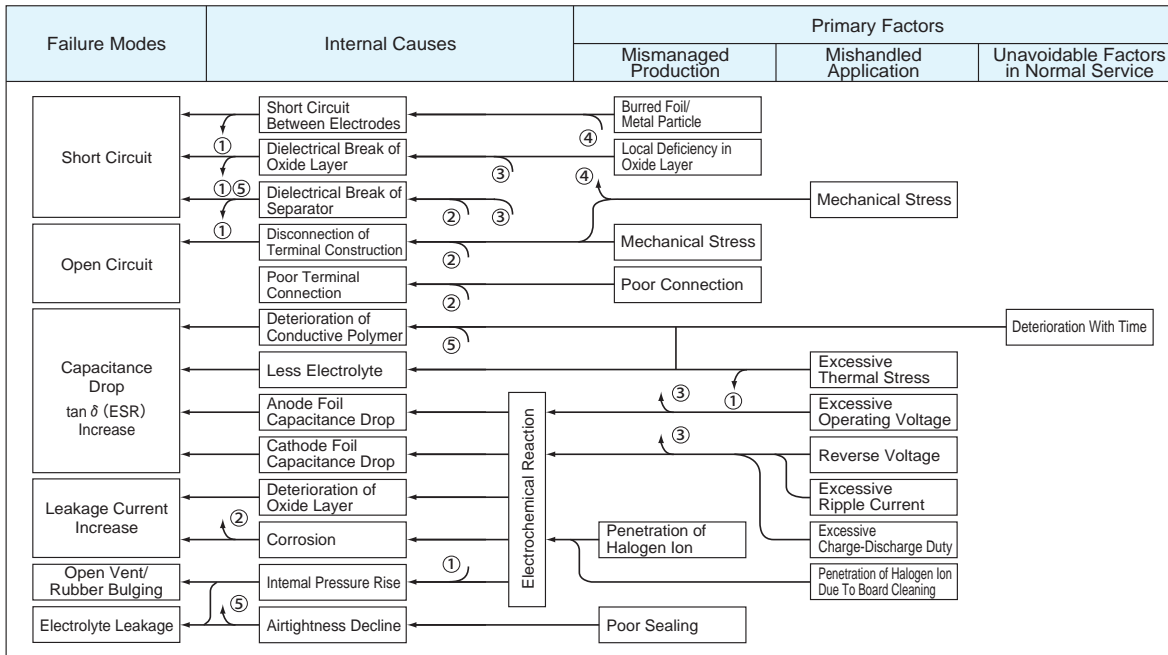

10) Capacitor insulation

The can case of capacitor does not assure electrical insulation. The outer coating on can case is aimed for indication and does not assure function of the electrical insulation. Electrically isolate the outer can case of a capacitor from the negative terminal, the positive terminal and circuit patterns.

11) Operating conditions

Do not use/expose capacitors to the following conditions:

- ① Direct contact with water, salt water or oil, or high condensation environment.
 - ② Direct sunlight
 - ③ Toxic gases such as hydrogen sulfide, sulfurous acid, nitrous acid, chlorine and its compounds, bromine and its compounds and ammonium.
 - ④ Ozone, ultraviolet rays or radiation.
 - ⑤ Extreme vibration or mechanical shock that exceeds limits in the catalogs or product specifications.
- The standard vibration condition is applicable to JIS C 5101-4.

12) Mounting

Capacitors contain paper separators and electric-conductive electrolyte that contains organic solvent as main solvent material, both of which are flammable. If the electrolyte leaks onto a printed circuit board, it can erode the device circuit pattern, may short-circuit the copper traces, smoke and burn. Make sure of designing a PC board as follows:

- ① Provide clearance space (2mm minimum) over the pressure relief vent of a capacitor to avoid blocking the correct opening of the pressure relief vent for 10mm case diameter of capacitor.
- ② Do not locate any wire or circuit pattern over the pressure relief vent of a capacitor.
- ③ Avoid locating any heat source components near capacitors or on the opposite side of the PC board under capacitors.
- ④ Design the solder land on the PC board in accordance with the catalog or the product specification.
- ⑤ For radial capacitors, design the terminal holes on the PC board to fit the terminal dimension of the capacitor.
- ⑥ Do not print any copper trace under the seal (terminal) side of a capacitor. When the electrolyte leaks out, it may occur circuit pattern short-circuit, and tracking or migration. Copper traces should be 1 mm (preferably 2mm or more) spaced apart from the side of the capacitor body.
- ⑦ In designing a double-sided PC board, do not locate any through-hole via or unnecessary hole underneath a capacitor.

- ⑧ In designing a double-sided PC board, do not print any circuit pattern underneath a capacitor.

13) Using capacitors for significantly safety-oriented applications

Consult with us in advance of usage of our products in the following listed applications. ① Aerospace equipment ② Power generation equipment such as thermal power, nuclear power etc. ③ Medical equipment ④ Transport equipment (automobiles, trains, ships, etc.) ⑤ Transportation control equipment ⑥ Disaster prevention / crime prevention equipment ⑦ Highly publicized information processing equipment ⑧ Submarine equipment ⑨ Other applications that are not considered general-purpose applications.

14) Others

Design device circuits taking into consideration the following conditions:

- ① Electrical characteristics of a capacitor depend on the temperature and frequency. In designing the device circuits, consider the change in the characteristics.
- ② If using more than one capacitor connected in parallel, design the device circuits to balance the current flow in individual capacitors.
- ③ If using more than one capacitor connected in series, connect shunting resistors in parallel with the individual capacitors to balance the voltage.

2) Installation

1) Assembling

- ① Do not try to reuse the capacitors once assembled and electrified
- ② Capacitors may have been spontaneously recharged with time by a recovery voltage phenomenon. Capacitors may produce recovery voltage higher than aluminum electrolytic capacitors and conductive polymer aluminum solid capacitors. In this case, discharge electricity through approximately 1kΩ before use.
- ③ If capacitors have been stored at any conditions more than 35°C and 75%RH for long storage periods of time more than the limits specified in the catalogs or product specifications, they may have high leakage current. In this case, make pre-conditioning by applying the rated voltage through a resistor of approximately 1kΩ.
- ④ Confirm the rated capacitance and voltage of capacitors

before installation.

- ⑤ Confirm the polarity of capacitors before installation.
- ⑥ Do not try to use the capacitors that were dropped to the floor and so forth.
- ⑦ Do not deform the can case of a capacitor.
- ⑧ Verify that the lead spacing of the capacitor fits the hole spacing in the PC board before installing the capacitors.
- ⑨ Do not apply excessive mechanical force to capacitors more than the limits prescribed in the catalogs or product specifications. Avoid excessive mechanical force while the capacitors are in the process of vacuum-picking, placing and positioning by automatic mounting machines or cutting the lead wires by automatic insertion machines.

2) Soldering and heat resistance

- ① For soldering using a soldering iron, consider the following conditions:
Soldering conditions (temperature and time) should be (380 ± 10°C, 3 ± 0.5second).
Do not touch the body of a capacitor with the hot tip of the soldering iron.
- ② Verify the following when flow soldering:
 - Do not dip the body of a capacitor into the solder bath only dip the terminals in. The soldering must be done on the reverse side of PC board.
 - Soldering conditions (preheat, solder temperature and dipping time) should be within the limits prescribed in the catalog or the product specifications.
 - Do not apply flux to any part of capacitors other than their terminals.
 - Make sure the capacitors do not come into contact with any other components while soldering.
- ③ For reflow soldering, consider the following conditions:
Soldering conditions (preheat, reflow temperature and time) should be within the limits prescribed in the catalogs or product specifications.
 - When using the infrared heater and setting its temperatures, adjust the heating levels taking into consideration that the color and materials of a capacitor vary in their infrared absorbance.
 - The allowable number of reflow passes is specified in the catalogs or product specifications.
 - Please consult us about vapor phase soldering (VPS).
- ④ Do not try to reuse the capacitors once assembled.
- ⑤ Only use radial lead type capacitors for flow soldering. The other type capacitors are not designed for the flow soldering.
- ⑥ Only use chip type capacitors for reflow soldering. The other type capacitors are not designed for the reflow soldering.

3) Handling after soldering

After soldering the PC board, do not apply the following mechanical stress to the capacitor:

- ① Do not tilt, push down or twist the body of the capacitor.
- ② Do not grab the body of the capacitor to carry the assembly board.
- ③ Do not hit anything against the capacitor. When stacking the assembled boards, do not put any of the PC boards or other components against the capacitor.
- ④ Do not drop the assembled board.

4) Cleaning assembly boards

- ① Do not clean capacitors with the following cleaning agents:
 - Halogenated solvents: cause capacitor failures due to corrosion.
 - Alkali system solvents: corrode (dissolve) the aluminum can case.
 - Terpene and petroleum system solvents: deteriorate the rubber seal materials.
 - Xylene and toluene: deteriorates the rubber seal materials as well.
 - Acetone: erases the markings printed on a capacitor.

Where cleaning is necessary, use only solvent resistant type capacitors that have been assured for the cleaning within the specific cleaning conditions prescriber in the catalogs or product specifications. In particular, carefully set up the conditions for ultrasonic cleaning system. Consult us regarding alternative

CFCs or other cleaners before use.

- ② Where cleaning the capacitors, confirm the following conditions:

- Control the contamination (the conductivity, pH, specific gravity, water content, etc.) of the cleaning agents.
- After the cleaning, do not leave the capacitors (assembly boards) in an environment of cleaning agent-rich or in a closed container. Sufficiently evaporate the residual cleaning agent from the assembly boards and the capacitors by forced hot air at temperatures less than the upper limit of category temperature range for more than 10 minutes.

In general, aluminum electrolytic capacitors are sensitive to contamination of halogen ions (particularly to chlorine ions). Depending on the properties of the electrolyte and rubber seal materials used in a capacitor, the halogen ions lead up to catastrophic failures on the capacitor. Where the inside of a capacitor has been contaminated with more than a certain amount of halogen ions and the capacitor is in use, the corrosion reaction of aluminum occurs. The corrosion causes the capacitor to have a significant increase in leakage current with heat produced, open the pressure relief vent and become open circuit mode failure.

Due to global environmental issues (greenhouse effects and other environmental destruction by depletion of the ozone layer), the conventional cleaning solvents of CFC 113, Trichloroethylene and 1,1,1-trichloroethylene were replaced by substitutes. The following are some substitute cleaning agents and allowable cleaning conditions:

a) Fatty-alcohol cleaning agents

Pine Alpha ST-100S (Arakawa Chemical)
Clean Through 750H, 750HS and 750J (Kao)

[Cleaning conditions]

Either of immersion or ultrasonic cleaning, for a maximum of 10 minutes and at a maximum liquid temperature of 60°C is acceptable. Make sure that the markings on the capacitor are not rubbed against any other component or the PC board during cleaning. Note that shower cleaning affects the markings on the capacitor.

b) Alternative CFCs

AK225AES (Asahi Glass)

[Cleaning conditions]

Solvent resistant type capacitors, which were originally developed to intend to resist Freon TE or Freon TES, are also capable of withstanding any one of immersion, ultrasonic or vapor cleaning, for a maximum of 5 minutes.

However, this type of cleaning agent is not recommended to use, as the cleaning materials may be banned in near future in view of global environmental issues

c) IPA (Isopropyl Alcohol)

Immersion cleaning with a maximum flux concentration of 2 wt% is acceptable.

5) Adhesives and coating materials

- ① Do not use any adhesive or coating materials containing halogenated solvents.
- ② Make sure of the following conditions before applying adhesive or coating materials to a capacitor,
 - No flux residue nor stain is left between the rubber seal of a capacitor and PC board.
 - Dry the capacitor to remove residual cleaning agents before applying adhesive and coating materials. Do not cover up the entire surface of the rubber seal of the capacitor with adhesives or coating materials.
 - Consult us Heating and curing conditions for adhesives and coating materials.
 - Covering up the entire surface of the rubber seal with resin mold materials will obstruct the normal diffusion of internal

hydrogen gas from a capacitor and result in serious failures. Also, where the adhesive and coating materials contain a large amount of halogen ions, the halogen ions will contaminate the inside of the capacitor through the rubber seal materials, causing the capacitor to become a failure.

- Depending on solvent materials that the adhesive or coating materials contains, note that the surface of a capacitor may change in appearance.

6) Fumigation

In exporting or importing electronic devices, they may be exposed to fumigation with halide such as methyl bromide.

Where the capacitors are exposed to halide such as methyl bromide, the capacitors will be damaged with the corrosion reaction with halogen ions in the same way as cleaning agents. For the export and import, Nippon Chemi-Con considers using some packaging method and so forth so that fumigation is not required. For customers to export or import electronic devices, semi-assembly products or capacitor components, confirm if they will be exposed to fumigation and also consider final condition of packaging. (Note that either cardboard or vinyl package has a risk of fumigation gas penetration.)

3) Precautions during operation of devices

- (1) Never touch the terminals of a capacitor directly with bare hands.
- (2) Do not short-circuit between the capacitor terminals with anything conductive. Also, do not spill any conductive liquid such as acid or alkaline solution over a capacitor.
- (3) Confirm environmental conditions where the device will be placed. Do not use the device in the following environmental conditions:
 - ① Water or oil spatters, or high condensation environment.
 - ② Direct sunlight.
 - ③ Ozone, ultraviolet rays or radiation.
 - ④ Toxic gases such as hydrogen sulfide, sulfuric acid, nitrous acid, chlorine and its compounds, bromine and its compounds and ammonium.
 - ⑤ Severe vibration or mechanical shock conditions beyond the limits prescribed in the catalog or product specification. The standard vibration condition is applicable to JIS C 5101-4.

4) Maintenance inspections

- (1) For industrial use capacitors, make periodic inspections of the capacitors. Before the inspections, turn off the power supply of the device and discharge the electricity of the capacitors. Where checking it by a volt-ohm meter, confirm the polarity beforehand. Do not apply mechanical stress to the terminals of the capacitors during inspection.
- (2) Characteristics to be inspected
 - ① Significant damage in appearance: vent opening, electrolyte leakage, etc.
 - ② Electrical characteristics: Leakage current, capacitance, $\tan \delta$ and other characteristics prescribed in the catalogs or product specifications. If finding anything abnormal on the characteristics above, check the specifications of the capacitor and take appropriate actions such as replacement.

5) Contingencies

- (1) A capacitor with more than a certain case size has the pressure relief vent functioning to escape abnormal gas pressure increase. If gas expels from a venting capacitor, disconnect the power supply of the device or unplug the power supply cord. If not disconnecting the power supply, the device circuit may be damaged due to the short circuit failure of the capacitor or short-circuited with the liquid that the gas was condensed to. It may cause secondary damages

such as device burnout in the worst case scenario. The gas that comes out of the open vent is vaporized electrolyte not smoke.

- (2) The gas expelled from a venting capacitor is more than 100°C. Never expose your face to the capacitor. If your eyes are exposed to the gas or you inhale it, immediately flush your eyes and/or gargle with water. If the electrolyte comes in contact with the skin, wash with soap and water.

6) Storage

- (1) Do not store capacitors at high temperature or high humidity. Store the capacitors indoors at temperatures of 5 to 35°C and humidities of less than 75%RH. In principle, conductive polymer hybrid aluminum electrolytic capacitors should be used within 2 years after production.
- (2) Keep capacitors packed in the original packaging material whenever possible.
- (3) Avoid the following storage environmental conditions:
 - ① Water spattering, high temperatures, high humidity or condensation environment.
 - ② Oil spattering or oil mist filled.
 - ③ Salt water spattering or salt filled.
 - ④ Acidic toxic gases such as hydrogen sulfide, sulfuric acid, nitrous acid, chlorine, bromine and methyl bromide filled.
 - ⑤ Alkaline toxic gases such as ammonium filled.
 - ⑥ Acid or alkaline solutions spattering.
 - ⑦ Direct sunlight, ozone, ultraviolet rays or radiation.
 - ⑧ Extreme vibration or shock loading.
- (4) JEDEC J-STD-020 is not applicable.

7) Capacitor disposal

Please consult with a local organization for the proper disposal of industrial waste. For incinerating capacitors, apply a high temperature incineration (over 800°C). Incinerating them at temperatures lower than that may produce toxic gases such as chlorine. To prevent capacitors from explosion, punch holes in or sufficiently crush the can cases of the capacitors, then incinerate.

8) About AEC-Q200

The Automotive Electronics Council (AEC) was originally established by major American automotive related manufactures. Today, the committees are composed of representatives from the sustaining Members of manufacturing companies in automotive electrical components. It has standardized the criteria for "stress test qualification" and "reliability tests" for electronic components.

AEC-Q200 is the reliability test standard for approval of passive components in Automotive applications. It specifies the test type, parameters and quantity, etc. for each component. The criteria of the reliability tests such as for our main products, "Aluminum Electrolytic Capacitors" are described in this standard.

Pursuant to the customer's specific testing requirements, Chemi-Con submits the test results according to AEC-Q200 for Aluminum Electrolytic Capacitors used in automotive applications on request.

An electronic component manufacturer cannot simply claim that their product is "AEC-Q200 Qualified". It can be claimed "Compliant", "Capable", "Available", etc., however each component must be tested per each users "Qualification Test Plan" in order to claim AEC-Q200 status.

Please contact us for more information.

9) Response to the Substances of Concern

- (1) Nippon Chemi-Con aims for developing products that meet laws and regulations concerning substances of concern. (Some products may contain regulated substances for ex-



PRECAUTIONS AND GUIDELINES (Conductive Polymer Hybrid)

empted application)

Please contact us for more information about law-compliance status.

- 2) According to the content of REACH handbook (Guidance on requirements for substances in articles which is published on May 2008), our electronic components are “articles without any intended release”. Therefore they are not applicable for “Registration” for EU REACH Regulation Article 7 (1). Reference: Electrolytic Condenser Investigation Society Study of REACH Regulation in EU about Electrolytic Capacitor (publicized on 13 March 2008)

10 Catalogs

Specifications in the catalogs are subject to change without notice. Test data shown in the catalogs are not assured as the whole performance values, but typical values. For more details, refer to JEITA RCR-2367D (March 2019) with the title of “Safety Application Guide for fixed aluminum electrolytic capacitors for use in electronic equipment”.

RECOMMENDED SOLDERING CONDITIONS

◆ SURFACE MOUNT TYPE

The following conditions are recommended for air or infrared reflow soldering on the SMD products onto a glass epoxy circuit board of 90×50×0.8mm (with resist) by cream solder. The temperatures shown are the surface temperature values on the top of the can and temperature of capacitor terminal.

Reflow should be performed twice or less.

Please ensure that the capacitor became cold enough to the room temperature (5 to 35°C) before the second reflow.

● Recommended soldering heat conditions

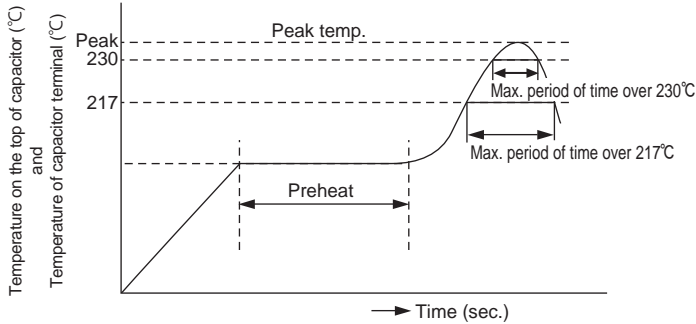

Size Code	Preheat	Time maintained above 217°C	Time maintained above 230°C	Peak temp.	Reflow number
E61, F61, F80	150 to 180°C	50 sec. max.	40 sec. max.	260°C max.	2-cycles allowed
HA0 to JH0	120 sec. max.	50 sec. max.	40 sec. max.	260°C max. 245°C max.	1-cycle only 2-cycles allowed

● Recommended Solder Land on PC Board

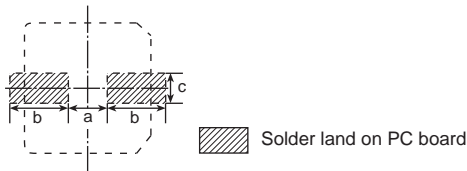

Size code	Terminal code : [mm]					
	Terminal code : A			Terminal code : G		
	a	b	c	a	b	c
E61	1.4	3.0	1.6			
F61, F80	1.9	3.5	1.6	1.9	3.5	3.3
HA0	3.1	4.2	2.2	3.1	4.2	3.5
JA0	4.5	4.4	2.2	4.5	4.4	3.5
JC5	4.5	4.4	2.2	4.5	4.4	3.5
JH0	4.0	4.7	2.5	4.0	4.7	3.8

◆ RADIAL LEAD TYPE

● Recommended soldering heat conditions

Preheat : 150°C 120 seconds max.

Flow soldering : 260±5°C max. 10+1 seconds max. (Or 380±10°C max. 3±0.5 seconds max.: hand soldering)

◆ PRECAUTIONS FOR USERS

Soldering method

SMD type have no capability to withstand such dip or wave soldering as totally immersing components into a solder bath.

Reflow soldering

Reflow the capacitors within Recommended Reflow Soldering Conditions. Verify there is no temperature stress to the capacitors because the following differences might degrade capacitors electrically and mechanically. Please consult with us if other reflow conditions are employed.

1. Location of components : Temperature increases at the edge of PC board more than the center.
2. Population of PC board : The lower the component population is, the more temperature rises.
3. Material of PC board : A ceramic-made board needs more heat than a glass epoxy-made board. The heat increase may cause damage to the capacitors.
4. Thickness of PC board : A thicker board needs more heat than a thinner board. The heat may damage the capacitors.
5. Size of PC board : A larger board needs more heat than a smaller board. The heat may damage the capacitors.
6. Solder thickness
If very thin cream solder paste is to be used for SMD types, please consult with us.
7. Location of infrared ray lamps : IR reflow as well as hot plate reflow heats only on the reverse side of the PC board to lessen heat stress to the capacitors.
8. Case leakage current will increase (~mA) after the reflow process, the leakage current which rose gradually decreases when voltage is applied.
9. Please consult us about vapor phase soldering (VPS).

Rework of soldering

Use a soldering iron for rework. Do not exceed an iron tip temperature of 380±10°C and an exposure time of 3±0.5 seconds.

Mechanical stress

Do not grab the capacitors to lift the PC board and give stress to the capacitor. Avoid bending the PC board. This may damage the capacitors.

Cleaning assembly board

Immediately after solvent cleaning, remove residual solvent with an air knife for at least 10 minutes. If the solvent is insufficiently dry, the capacitors may corrode.

Coating on assembly board

1. Before curing coating material, remove the cleaning solvents from the assembly board.
2. Before conformal coating, a chloride free pre-coat material is recommended to decrease the stress on the capacitors.

Molding with resin

Internal chemical reaction gradually produces gas in the capacitor; increasing internal pressure. If the end seal of the capacitor is completely covered by resin the gas will be unable to escape causing a potentially dangerous situation. The chlorine in resin will penetrate the end seal, reach the element, and damage of the capacitor.

Glue

The followings are requirements for glue.

1. A low curing temperature over a short period of time
2. Strong adhesion and heat resistance after curing
3. Long shelf life
4. No corrosion

Others

Refer to PRECAUTIONS AND GUIDELINES(Conductive Polymer Hybrid).



Lifetime Estimation of Conductive Polymer Hybrid Aluminum Electrolytic Capacitors

Subject series : HXC/HXD/HXJ/HXK/HXE/HSC/HSD/HSE

Please consult us about lifetime equations for HXF series.

Conductive polymer hybrid aluminum electrolytic capacitors, in common with other aluminum electrolytic capacitors, are electronic components with a finite lifespan. The lifetime of these capacitors is influenced by ambient temperatures, environmental conditions such as humidity, and operating conditions such as the level of ripple current and surge voltage, all of which can reduce capacitance and increase ESR as a result.

1. Lifetime Estimation

Estimation of lifetime can be expressed by the following equations (1) to (3), which take the effects of ambient temperatures and self-heat rise resulting from ripple current into account.

Subject series : HXC/HXD/HXJ/HXK/HSC/HSD

$$Lx=Lr \times Bt^{\frac{Kt(To-Tx)}{10}} \times Bt^{\frac{\Delta To-\Delta T}{10}} \dots\dots\dots(1)$$

Subject series : HXE/HSE

125 °C < Tx ≤ 135 °C

$$Lx=Lr \times Bt^{\frac{To-Tx}{10}} \times Bt^{\frac{\Delta To-\Delta T}{10}} \dots\dots\dots(2)$$

Tx ≤ 125 °C

$$Lx=Lr \times Bt^{\frac{Kt(125-Tx)}{10}} \times Bt^{\frac{\Delta To-\Delta T}{10}} \dots\dots\dots(3)$$

- Lx : Estimation of actual lifetime (hour)
- Lr : Stated lifetime under the rated ripple current superimposition at the upper limit of the category temperature (hours)
- Bt : Temperature acceleration factor (Table-1)
- Kt : Correction factor of ambient temperature acceleration factor..... (Table-2)
- To : Maximum category temperature (°C)
- Tx : Actual ambient temperature of the capacitor (°C)
Use 40°C if the actual ambient temperature is below it.
- ΔTo : Rise of internal temperature due to the rated ripple current (°C) (Table-3)
- ΔT : Rise of internal temperature due to actual ripple current (°C)

Table-1 Bt : Temperature acceleration factor

Subject series	φ 5, 6.3	φ 8, 10
HXC/HXD/HXJ/HXK/HSC/HSD	1.7	2
HXE/HSE	Tx ≤ 125 °C	2
	125 °C < Tx ≤ 135 °C	1.7

Table-2 Kt : Correction factor of ambient temperature acceleration factor

Actual ambient temperature of the capacitor	Tx ≤ 65 °C	65 °C < Tx ≤ 105 °C	105 °C < Tx ≤ 125 °C
Bt=1.7	1.06	1.03	1
Bt=2	1		

Table-3 ΔTo : Rise in internal temperature due to the rated ripple current (°C)

Subject series	HXC		HSC	HXD/HSD/HXK	HXJ			
Case size	φ 6.3×5.8 to φ 10×10L	φ 10×12.5L	—	—	φ 6.3x5.8L	φ 6.3x7.7L	φ 8×10L, φ 10×10L	φ 10×12.5L
ΔTo	5°C	6°C	5°C	15°C	5°C	8°C	10°C	11°C

Subject series	HXE		HSE
Case size	φ 6.3×5.8L to φ 10×10L, φ 10×16.5L		φ 10×12.5L
ΔTo	15°C (Tx ≤ 125 °C) 5°C (125 °C < Tx ≤ 135 °C)		16°C (Tx ≤ 125 °C) 6°C (125 °C < Tx ≤ 135 °C)

An approximate value of ripple current-caused ΔT can be calculated using Equation (4)

$$\Delta T = \Delta To \times \left(\frac{Ix}{Io} \right)^2 \dots\dots\dots(4)$$

- ΔTo : Rise in internal temperature due to the rated ripple current (Table-3)
- Ix : Operating ripple current (Arms) actually flowing in the capacitor
- Io : Rated ripple current (Arms), frequency compensated, at the upper limit of the category temperature range

To determine more accurate values of ΔT, they can be actually measured using a thermocouple.



2. Rated Ripple Current Frequency Multipliers

Self-heat rise is generated by the ripple current even though the conductive polymer hybrid aluminum electrolytic capacitors have low ESR compared to liquid based electrolyte aluminum electrolytic capacitor. The ESR value differs depending on the frequency, thus the degree of self-heat rise differs depending on the ripple current frequency. Therefore, if the actual ripple current frequency differs from the specifications stated in the standard ratings, use the value obtained by multiplying the rated ripple current multiplier to convert the rated current.

Conductive polymer hybrid aluminum electrolytic capacitors have super low ESR characteristic in high-frequency range. On the whole, ESR in low-frequency range relatively rises. Therefore, they can use only small ripple current in low-frequency range. Please ensure that excessive ripple current is not applied to the capacitors in all frequency range.

3. Restriction of estimated lifetime calculation

The result calculated by the estimated lifetime formula, it is not guaranteed lifetime by Nippon Chemi-Con Corporation.

When designer calculate the lifetime of apparatus, please include an ample margin in consideration to the estimated lifetime of a capacitor.

When calculated lifetime result are over 15 years by using the estimated lifetime formula, please consider 15 years to be a maximum in considering that the sealing rubber characteristics vary during the lifetime.

If 15 years or more may be required as an expected lifetime, please consult us.

CHEMI-CON PART NUMBERING SYSTEM

Product code guide (Conductive polymer hybrid Surface mount type)

(Example : HXC series, 16V-82 μ F, ϕ 6.3 \times 5.8L)



Please refer to the following table

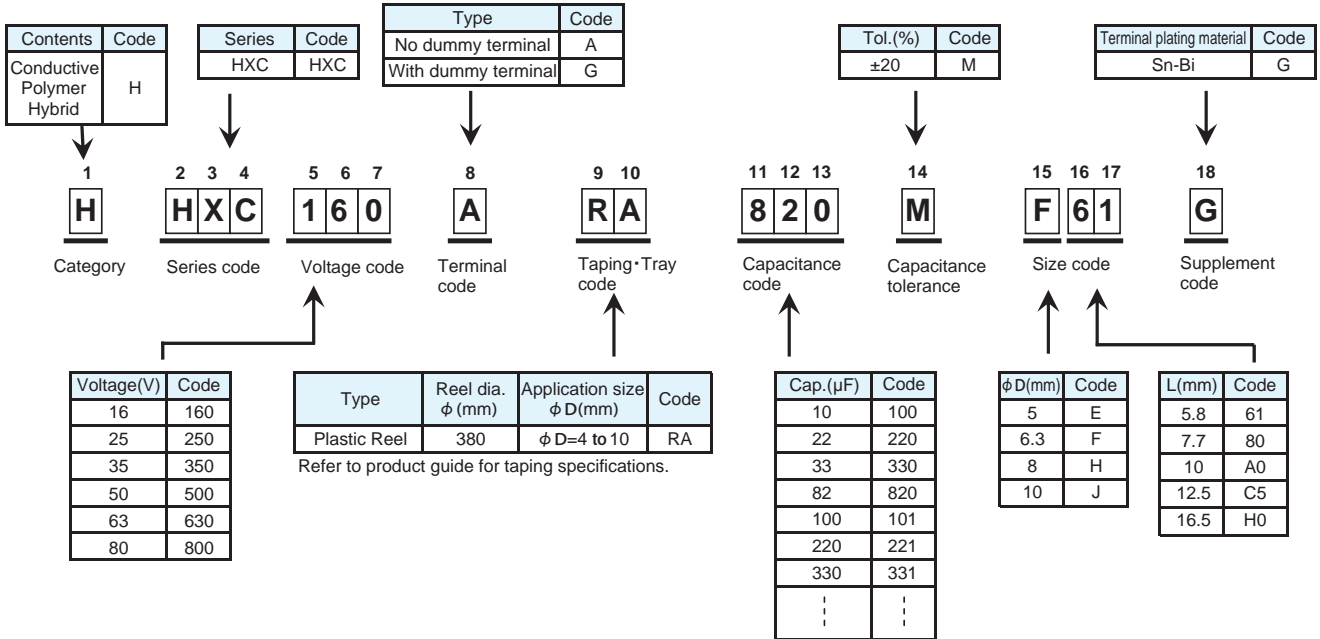

*Refer to the appendix (Part number) for codes not listed here.

Product code guide (Conductive polymer hybrid Radial lead type)

(Example : HSC series, 25V-330 μ F, ϕ 10 \times 12.5L, Long Lead with bulk)



Please refer to the following table

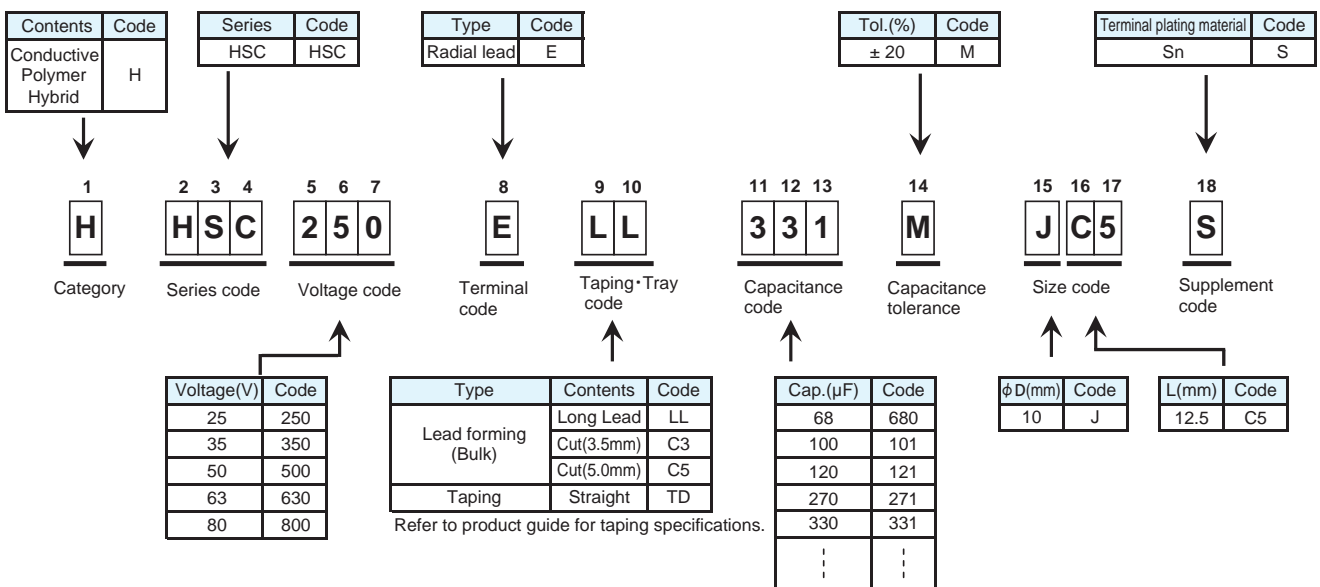

*Refer to the appendix (Part number) for codes not listed here.

HXF Series

- Guaranteed short time operating temperature at 150°C
- High reliability is realized by hybrid electrolyte
- Endurance with ripple current : 4,000 hours at 135°C
- Rated voltage range : 25 to 63V_{dc}, Capacitance range : 33 to 560μF
- For high temperature and high reliability applications.
(Automotive equipment, Base station equipment, etc.)
- RoHS2 Compliant
- Halogen Free
- AEC-Q200 compliant : Please contact Chemi-Con for more details, test data, information.

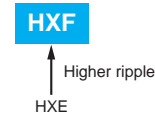

SPECIFICATIONS

Items	Characteristics
Category	-55 to +135°C
Temperature Range	-55 to +135°C
Rated Voltage Range	25 to 63V _{dc}
Capacitance Tolerance	±20% (M) (at 20°C, 120Hz)
Leakage Current	I=0.01CV or 3μA, whichever is greater Where, I : Max. leakage current (μA), C: Nominal capacitance (μF), V : Rated voltage(V) (at 20°C after 2 minutes)
Dissipation Factor (tan δ)	Rated voltage(V _{dc}) 25V 35V 50V 63V tan δ (Max.) 0.14 0.12 0.10 0.08 (at 20°C, 120Hz)
Low Temperature Characteristics (Max. Impedance Ratio)	Z(-25°C)/Z(+20°C) ≤ 1.5 Z(-55°C)/Z(+20°C) ≤ 2.0 (at 100kHz)
Endurance 1	The following specifications shall be satisfied when the capacitors are restored to 20°C after subjected to DC voltage with the rated ripple current is applied (the peak voltage shall not exceed the rated voltage) for 4,000 hours at 125°C or 135°C. Capacitance change ≤ ±30% of the initial value D.F. (tan δ) ≤ 200% of the initial specified value ESR ≤ 200% of the initial specified value Leakage current ≤ The initial specified value
Endurance 2	The following specifications shall be satisfied when the temperatures of capacitors are restored to 20°C after the rated voltage is applied for 300 hours at 150°C and subjected to DC voltage while the rated ripple current is applied (the peak voltage shall not exceed the rated voltage) for 3,000 hours at 125°C or 135°C. Capacitance change ≤ ±30% of the initial value D.F. (tan δ) ≤ 200% of the initial specified value ESR ≤ 200% of the initial specified value Leakage current ≤ The initial specified value
Shelf Life	The following specifications shall be satisfied when the capacitors are restored to 20°C after exposing them for 1,000 hours at 135°C without voltage applied. Before the measurement, the capacitor shall be preconditioned by applying voltage according to item 4.1 of JIS C 5101-4. Capacitance change ≤ ±30% of the initial value D.F. (tan δ) ≤ 200% of the initial specified value ESR ≤ 200% of the initial specified value Leakage current ≤ The initial specified value
Bias Humidity Test	The following specifications shall be satisfied when the capacitors are restored to 20°C after subjecting them to the DC rated voltage at 85°C, 85% RH for 2,000 hours. Appearance No significant damage Capacitance change ≤ ±30% of the initial value D.F. (tan δ) ≤ 200% of the initial specified value ESR ≤ 200% of the initial specified value Leakage current ≤ The initial specified value

DIMENSIONS [mm]

- Terminal Code : A
- Size code : HA0 to JH0
- Terminal Code : G (Vibration resistant structure)
- Size code : HA0 to JH0

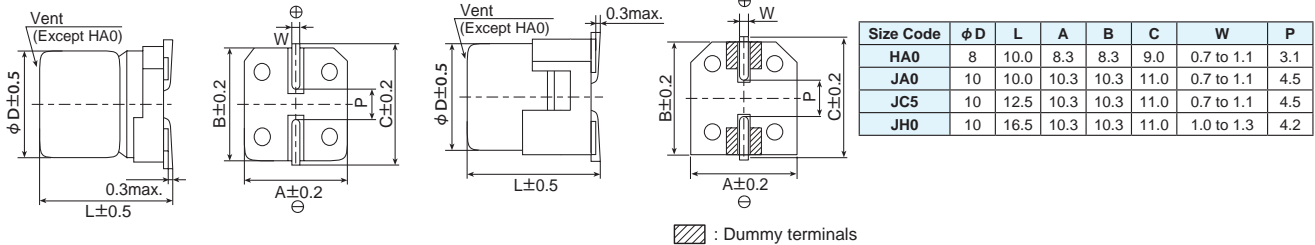

PART NUMBERING SYSTEM

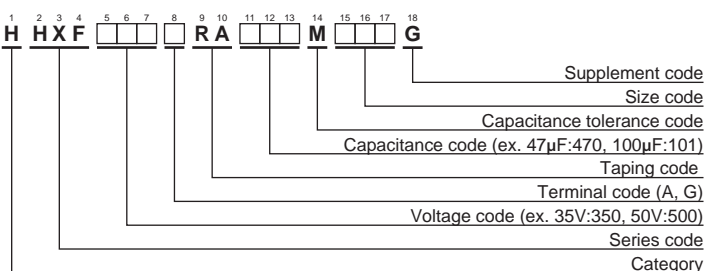

MARKING

EX) 35V270μF



Rated voltage symbol

Rated voltage (V _{dc})	Symbol
25	E
35	V
50	H
63	J

Please refer to "Product code guide (conductive polymer hybrid type)"



HXF Series

◆ **STANDARD RATINGS**

WV (V _{dc})	Cap (μF)	Size code	ESR (mΩ max./20°C, 100kHz)	Rated ripple current (mArms/100kHz)		Part No.
				125°C	135°C	
25	150	HA0	18	3,900	2,800	HHXF250□RA151MHA0G
	220	HA0	18	3,900	2,800	HHXF250□RA221MHA0G
	270	JA0	16	4,500	3,300	HHXF250□RA271MJA0G
	330	JA0	16	4,500	3,300	HHXF250□RA331MJA0G
	470	JC5	14	5,100	3,600	HHXF250□RA471MJC5G
	560	JH0	10	6,000	4,300	HHXF250□RA561MJH0G
35	100	HA0	18	3,900	2,800	HHXF350□RA101MHA0G
	150	HA0	18	3,900	2,800	HHXF350□RA151MHA0G
	150	JA0	16	4,500	3,300	HHXF350□RA151MJA0G
	270	JA0	16	4,500	3,300	HHXF350□RA271MJA0G
	330	JC5	15	4,900	3,500	HHXF350□RA331MJC5G
	470	JH0	11	5,800	4,100	HHXF350□RA471MJH0G
50	47	HA0	24	3,600	2,500	HHXF500□RA470MHA0G
	68	HA0	24	3,600	2,500	HHXF500□RA680MHA0G
	100	JA0	20	4,300	3,000	HHXF500□RA101MJA0G
	120	JA0	20	4,300	3,000	HHXF500□RA121MJA0G
	150	JC5	17	4,600	3,300	HHXF500□RA151MJC5G
	220	JH0	13	5,300	3,800	HHXF500□RA221MJH0G
63	33	HA0	27	3,300	2,300	HHXF630□RA330MHA0G
	47	HA0	27	3,300	2,300	HHXF630□RA470MHA0G
	56	JA0	22	4,000	2,800	HHXF630□RA560MJA0G
	82	JA0	22	4,000	2,800	HHXF630□RA820MJA0G
	100	JC5	17	4,600	3,300	HHXF630□RA101MJC5G
	150	JH0	13	5,300	3,800	HHXF630□RA151MJH0G

□ : Enter the appropriate terminal code.

◆ **RATED RIPPLE CURRENT MULTIPLIERS**

● Frequency Multipliers

Capacitance(μF)	Frequency(Hz)						
	120	1k	5k	10k	20k	30k	100k to 500k
33 to 150	0.10	0.30	0.50	0.60	0.75	0.75	1.00
220 to 560	0.10	0.40	0.60	0.70	0.80	0.85	1.00

HXE Series

- High ripple current model is now available for JC5 size.
- High reliability is realized by hybrid electrolyte
- Endurance with ripple current : 2,000 to 4,000 hours at 135°C
- Rated voltage range : 16 to 63V_{dc}, Capacitance range : 22 to 560μF
- For high temperature and high reliability applications.
(Automotive equipment, Base station equipment, etc.)
- RoHS2 Compliant
- Halogen Free
- AEC-Q200 compliant : Please contact Chemi-Con for more details, test data, information.

HXE

↑ Higher temperature
Higher ripple
HXC



◆ SPECIFICATIONS

Items	Characteristics						
Category	-55 to +135°C						
Temperature Range	-55 to +135°C						
Rated Voltage Range	16 to 63V _{dc}						
Capacitance Tolerance	±20% (M) (at 20°C, 120Hz)						
Leakage Current	I=0.01CV or 3μA, whichever is greater Where, I : Max. leakage current (μA), C: Nominal capacitance(μF), V : Rated voltage(V) (at 20°C after 2 minutes)						
Dissipation Factor (tan δ)	Rated voltage(V _{dc})	16V	25V	35V	50V	63V	(at 20°C, 120Hz)
	tan δ (Max.)	0.16	0.14	0.12	0.10	0.08	
Low Temperature Characteristics (Max. Impedance Ratio)	Z(-25°C)/Z(+20°C) ≤ 1.5 Z(-55°C)/Z(+20°C) ≤ 2.0 (at 100kHz)						
Endurance	The following specifications shall be satisfied when the capacitors are restored to 20°C after subjected to DC voltage with the rated ripple current is applied (the peak voltage shall not exceed the rated voltage) for 4,000 hours (F61, F80 : 2,000 hours) at 125°C or 135°C.						
	Capacitance change	≤ ±30% of the initial value					
	D.F. (tan δ)	≤ 200% of the initial specified value					
	ESR	≤ 200% of the initial specified value					
	Leakage current	≤ The initial specified value					
Shelf Life	The following specifications shall be satisfied when the capacitors are restored to 20°C after exposing them for 1,000 hours at 135°C without voltage applied. Before the measurement, the capacitor shall be preconditioned by applying voltage according to item 4.1 of JIS C 5101-4.						
	Capacitance change	≤ ±30% of the initial value					
	D.F. (tan δ)	≤ 200% of the initial specified value					
	ESR	≤ 200% of the initial specified value					
	Leakage current	≤ The initial specified value					
Bias Humidity Test	The following specifications shall be satisfied when the capacitors are restored to 20°C after subjecting them to the DC rated voltage at 85°C, 85% RH for 2,000 hours.						
	Appearance	No significant damage					
	Capacitance change	≤ ±30% of the initial value					
	D.F. (tan δ)	≤ 200% of the initial specified value					
	ESR	≤ 200% of the initial specified value					
	Leakage current	≤ The initial specified value					

◆ DIMENSIONS [mm]

- Terminal Code : A
- Size code : F61 to JH0
- Terminal Code : G (Vibration resistant structure)
- Size code : F61 to JH0

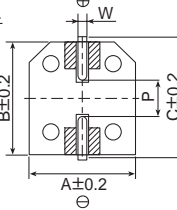
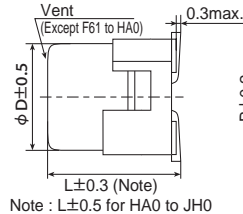
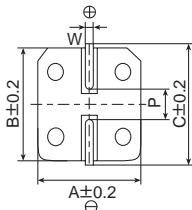
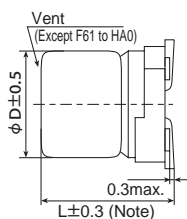

Size Code	φD	L	A	B	C	W	P
F61	6.3	5.8	6.6	6.6	7.2	0.5 to 0.8	1.9
F80	6.3	7.7	6.6	6.6	7.2	0.5 to 0.8	1.9
HA0	8	10.0	8.3	8.3	9.0	0.7 to 1.1	3.1
JA0	10	10.0	10.3	10.3	11.0	0.7 to 1.1	4.5
JC5	10	12.5	10.3	10.3	11.0	0.7 to 1.1	4.5
JH0	10	16.5	10.3	10.3	11.0	1.0 to 1.3	4.2

▨ : Dummy terminals

◆ PART NUMBERING SYSTEM

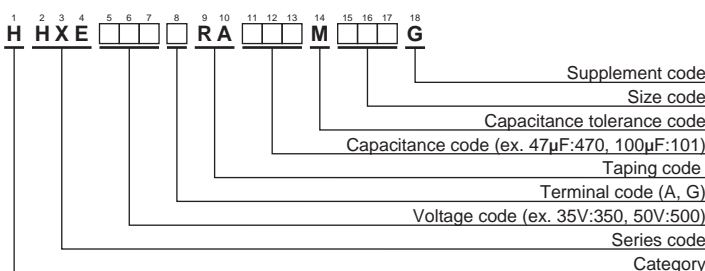

◆ MARKING

EX) 35V270μF



● Rated voltage symbol

Rated voltage (V _{dc})	Symbol
16	C
25	E
35	V
50	H
63	J

Please refer to "Product code guide (conductive polymer hybrid type)"



HXESeries

◆ **STANDARD RATINGS**

WV (V _{dc})	Cap (μF)	Size code	ESR (mΩ max./20°C, 100kHz)	Rated ripple current (mArms/100kHz)		Part No.
				125°C	135°C	
16	82	F61	45	1,700	950	HHXE160□RA820MF61G
	150	F80	27	2,500	1,450	HHXE160□RA151MF80G
	270	HA0	20	3,050	1,700	HHXE160□RA271MHA0G
	470	JA0	18	3,400	2,100	HHXE160□RA471MJA0G
	560	JC5	15	4,200	2,550	HHXE160□RA561MJC5G
25	56	F61	50	1,400	900	HHXE250□RA560MF61G
	100	F80	30	2,100	1,400	HHXE250□RA101MF80G
	220	HA0	22	2,900	1,600	HHXE250□RA221MHA0G
	330	JA0	20	3,300	2,000	HHXE250□RA331MJA0G
	470	JC5	16	4,050	2,500	HHXE250□RA471MJC5G
35	560	JH0	14	4,300	2,500	HHXE250□RA561MJH0G
	47	F61	60	1,400	900	HHXE350□RA470MF61G
	68	F80	35	2,100	1,400	HHXE350□RA680MF80G
	150	HA0	22	2,900	1,600	HHXE350□RA151MHA0G
	270	JA0	20	3,300	2,000	HHXE350□RA271MJA0G
50	330	JC5	17	3,950	2,400	HHXE350□RA331MJC5G
	470	JH0	14	4,300	2,500	HHXE350□RA471MJH0G
	33	HA0	30	2,400	1,250	HHXE500□RA330MHA0G
	47	HA0	30	2,400	1,250	HHXE500□RA470MHA0G
	56	JA0	25	2,900	1,600	HHXE500□RA560MJA0G
63	68	HA0	30	2,400	1,250	HHXE500□RA680MHA0G
	100	JA0	25	2,900	1,600	HHXE500□RA101MJA0G
	120	JA0	25	2,900	1,600	HHXE500□RA121MJA0G
	150	JC5	19	3,700	2,250	HHXE500□RA151MJC5G
	220	JH0	16	4,100	2,400	HHXE500□RA221MJH0G
	22	HA0	40	2,100	1,100	HHXE630□RA220MHA0G
	33	HA0	40	2,100	1,100	HHXE630□RA330MHA0G
63	33	JA0	30	2,600	1,400	HHXE630□RA330MJA0G
	47	HA0	40	2,100	1,100	HHXE630□RA470MHA0G
	56	JA0	30	2,600	1,400	HHXE630□RA560MJA0G
	82	JA0	30	2,600	1,400	HHXE630□RA820MJA0G
	100	JC5	22	3,450	2,100	HHXE630□RA101MJC5G
	150	JH0	16	4,100	2,400	HHXE630□RA151MJH0G

□ : Enter the appropriate terminal code.

◆ **RATED RIPPLE CURRENT MULTIPLIERS**

● Frequency Multipliers

Capacitance(μF)	Frequency(Hz)							
	120	1k	5k	10k	20k	30k	100k to 500k	
22 to 33	0.07	0.30	0.50	0.60	0.70	0.75	1.00	
47 to 150	0.10	0.40	0.60	0.70	0.80	0.80	1.00	
220 to 560	0.13	0.45	0.65	0.75	0.85	0.85	1.00	

HXK New! Series

- High reliability is realized by hybrid electrolyte
- Endurance with ripple current : 4,000 hours at 125°C
- Rated voltage range : 16 to 35V_{dc}, Capacitance range : 270 to 1,200μF
- For high temperature and high reliability applications. (Automotive equipment, etc.)
- RoHS2 Compliant
- Halogen Free
- AEC-Q200 compliant : Please contact Chemi-Con for more details, test data, information.

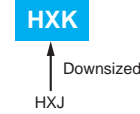

◆ SPECIFICATIONS

Items	Characteristics	
Category	-55 to +125°C	
Temperature Range		
Rated Voltage Range	16 to 35V _{dc}	
Capacitance Tolerance	±20% (M) (at 20°C, 120Hz)	
Leakage Current	I=0.01CV or 3μA, whichever is greater Where, I : Max. leakage current (μA), C: Nominal capacitance(μF), V : Rated voltage(V) (at 20°C after 2 minutes)	
Dissipation Factor (tan δ)	Rated voltage(V _{dc})	16V 25V 35V
	tan δ (Max.)	0.16 0.14 0.12 (at 20°C, 120Hz)
Low Temperature Characteristics (Max. Impedance Ratio)	Z(-25°C)/Z(+20°C) ≤ 1.5 Z(-55°C)/Z(+20°C) ≤ 2.0 (at 100kHz)	
Endurance	The following specifications shall be satisfied when the capacitors are restored to 20°C after subjected to DC voltage with the rated ripple current is applied (the peak voltage shall not exceed the rated voltage) for 4,000 hours at 125°C.	
	Capacitance change	≤ ±30% of the initial value
	D.F. (tan δ)	≤ 200% of the initial specified value
	ESR	≤ 200% of the initial specified value
	Leakage current	≤ The initial specified value
Shelf Life	The following specifications shall be satisfied when the capacitors are restored to 20°C after exposing them for 1,000 hours at 125°C without voltage applied. Before the measurement, the capacitor shall be preconditioned by applying voltage according to item 4.1 of JIS C 5101-4.	
	Capacitance change	≤ ±30% of the initial value
	D.F. (tan δ)	≤ 200% of the initial specified value
	ESR	≤ 200% of the initial specified value
	Leakage current	≤ The initial specified value
Bias Humidity Test	The following specifications shall be satisfied when the capacitors are restored to 20°C after subjecting them to the DC rated voltage at 85°C, 85% RH for 2,000 hours.	
	Appearance	No significant damage
	Capacitance change	≤ ±30% of the initial value
	D.F. (tan δ)	≤ 200% of the initial specified value
	ESR	≤ 200% of the initial specified value
	Leakage current	≤ The initial specified value

◆ DIMENSIONS [mm]

- Terminal Code : A
- Size code : HA0 to JC5
- Terminal Code : G (Vibration resistant structure)
- Size code : HA0 to JC5

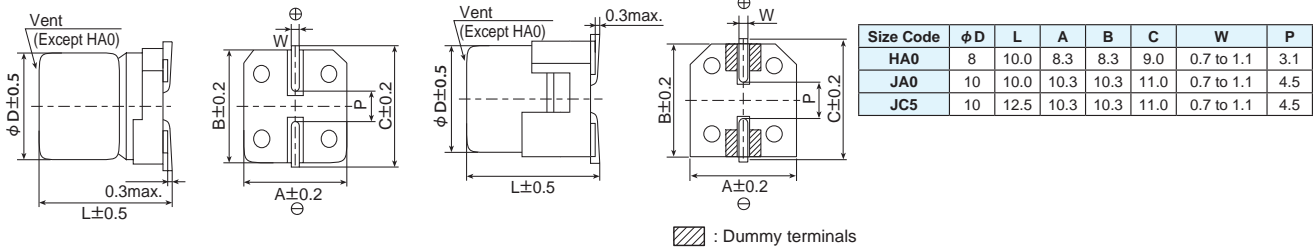

◆ PART NUMBERING SYSTEM

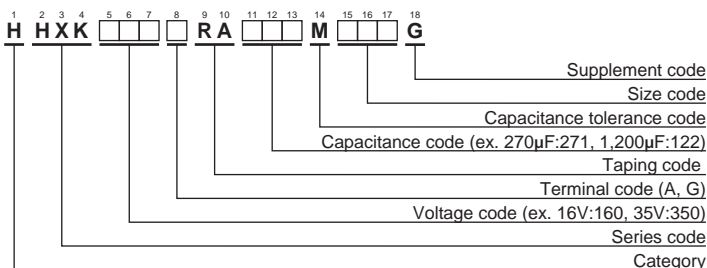

◆ MARKING



● Rated voltage symbol

Rated voltage (V _{dc})	Symbol
16	C
25	E
35	V

Please refer to "Product code guide (conductive polymer hybrid type)"



◆STANDARD RATINGS

WV (V _{dc})	Cap (μF)	Size code	ESR (mΩ max./20°C, 100kHz)	Rated ripple current (mA _{rms} /125°C, 100kHz)	Part No.
16	560	HA0	20	3,100	HHXK160□RA561MHA0G
	1,000	JA0	18	3,500	HHXK160□RA102MJA0G
	1,200	JC5	15	4,100	HHXK160□RA122MJC5G
25	390	HA0	22	3,100	HHXK250□RA391MHA0G
	680	JA0	20	3,500	HHXK250□RA681MJA0G
	820	JC5	15	4,100	HHXK250□RA821MJC5G
35	270	HA0	22	3,100	HHXK350□RA271MHA0G
	470	JA0	20	3,500	HHXK350□RA471MJA0G
	560	JC5	16	4,100	HHXK350□RA561MJC5G

□ : Enter the appropriate terminal code.

◆RATED RIPPLE CURRENT MULTIPLIERS

● Frequency Multipliers

Capacitance(μF)	Frequency(Hz)										
	120	1k	2k	3k	5k	10k	15k	20k	30k	50k	100k to 500k
270 to 1,200	0.15	0.50	0.60	0.65	0.70	0.75	0.80	0.85	0.85	0.90	1.00

HXJ Series

- High reliability is realized by hybrid electrolyte
- Endurance with ripple current : 4,000 hours at 125°C
- Rated voltage range : 16 to 63V_{dc}, Capacitance range : 56 to 820μF
- For high temperature and high reliability applications.
(Automotive equipment, Base station equipment, etc.)
- RoHS2 Compliant
- Halogen Free
- AEC-Q200 compliant : Please contact Chemi-Con for more details, test data, information.

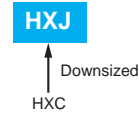

SPECIFICATIONS

Items	Characteristics						
Category	-55 to +125°C						
Temperature Range							
Rated Voltage Range	16 to 63V _{dc}						
Capacitance Tolerance	±20% (M) (at 20°C, 120Hz)						
Leakage Current	I=0.01CV or 3μA, whichever is greater Where, I : Max. leakage current (μA), C: Nominal capacitance(μF), V : Rated voltage(V) (at 20°C after 2 minutes)						
Dissipation Factor (tan δ)	Rated voltage(V _{dc})	16V	25V	35V	50V	63V	
	tan δ (Max.)	0.16	0.14	0.12	0.10	0.08	(at 20°C, 120Hz)
Low Temperature Characteristics (Max. Impedance Ratio)	Z(-25°C)/Z(+20°C) ≤ 1.5 Z(-55°C)/Z(+20°C) ≤ 2.0 (at 100kHz)						
Endurance	The following specifications shall be satisfied when the capacitors are restored to 20°C after subjected to DC voltage with the rated ripple current is applied (the peak voltage shall not exceed the rated voltage) for 4,000 hours at 125°C.						
	Capacitance change	≤ ±30% of the initial value					
	D.F. (tan δ)	≤ 200% of the initial specified value					
	ESR	≤ 200% of the initial specified value					
	Leakage current	≤ The initial specified value					
Shelf Life	The following specifications shall be satisfied when the capacitors are restored to 20°C after exposing them for 1,000 hours at 125°C without voltage applied. Before the measurement, the capacitor shall be preconditioned by applying voltage according to item 4.1 of JIS C 5101-4.						
	Capacitance change	≤ ±30% of the initial value					
	D.F. (tan δ)	≤ 200% of the initial specified value					
	ESR	≤ 200% of the initial specified value					
	Leakage current	≤ The initial specified value					
Bias Humidity Test	The following specifications shall be satisfied when the capacitors are restored to 20°C after subjecting them to the DC rated voltage at 85°C, 85% RH for 2,000 hours.						
	Appearance	No significant damage					
	Capacitance change	≤ ±30% of the initial value					
	D.F. (tan δ)	≤ 200% of the initial specified value					
	ESR	≤ 200% of the initial specified value					
	Leakage current	≤ The initial specified value					

DIMENSIONS [mm]

- Terminal Code : A
- Size code : F61 to JC5
- Terminal Code : G (Vibration resistant structure)
- Size code : F61 to JC5

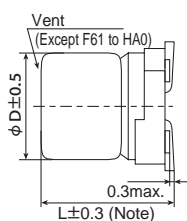

Note : L±0.5 for HA0 to JC5

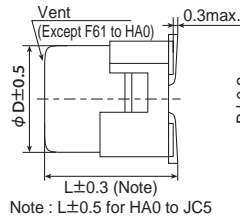
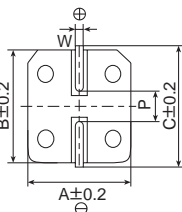

Note : L±0.5 for HA0 to JC5

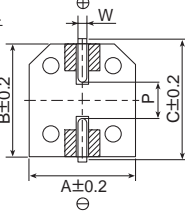

▨ : Dummy terminals

Size Code	φD	L	A	B	C	W	P
F61	6.3	5.8	6.6	6.6	7.2	0.5 to 0.8	1.9
F80	6.3	7.7	6.6	6.6	7.2	0.5 to 0.8	1.9
HA0	8	10.0	8.3	8.3	9.0	0.7 to 1.1	3.1
JA0	10	10.0	10.3	10.3	11.0	0.7 to 1.1	4.5
JC5	10	12.5	10.3	10.3	11.0	0.7 to 1.1	4.5

PART NUMBERING SYSTEM

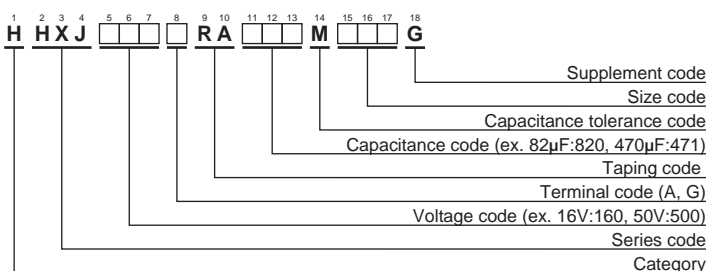

MARKING

EX) 35V330μF



Rated voltage symbol

Rated voltage (V _{dc})	Symbol
16	C
25	E
35	V
50	H
63	J

Please refer to "Product code guide (conductive polymer hybrid type)"



HXJ Series

◆STANDARD RATINGS

WV (V _{dc})	Cap (μF)	Size code	ESR (mΩ max./20°C, 100kHz)	Rated ripple current (mA _{rms} /125°C, 100kHz)	Part No.
16	150	F61	45	1,080	HHXJ160□RA151MF61G
	220	F80	27	1,800	HHXJ160□RA221MF80G
	470	HA0	20	2,000	HHXJ160□RA471MHA0G
	820	JA0	18	2,800	HHXJ160□RA821MJA0G
25	68	F61	50	1,300	HHXJ250□RA680MF61G
	82	F61	50	1,300	HHXJ250□RA820MF61G
	100	F61	50	1,300	HHXJ250□RA101MF61G
	150	F80	30	1,800	HHXJ250□RA151MF80G
	180	F80	30	1,800	HHXJ250□RA181MF80G
	270	HA0	22	2,000	HHXJ250□RA271MHA0G
	330	HA0	22	2,000	HHXJ250□RA331MHA0G
	470	JA0	20	2,800	HHXJ250□RA471MJA0G
	560	JA0	20	2,800	HHXJ250□RA561MJA0G
	680	JC5	15	3,700	HHXJ250□RA681MJC5G
35	56	F61	60	1,200	HHXJ350□RA560MF61G
	68	F61	60	1,200	HHXJ350□RA680MF61G
	100	F80	35	1,700	HHXJ350□RA101MF80G
	120	F80	35	1,700	HHXJ350□RA121MF80G
	180	HA0	22	2,000	HHXJ350□RA181MHA0G
	220	HA0	22	2,000	HHXJ350□RA221MHA0G
	330	JA0	20	2,800	HHXJ350□RA331MJA0G
	390	JA0	20	2,800	HHXJ350□RA391MJA0G
	470	JC5	16	3,600	HHXJ350□RA471MJC5G
50	82	HA0	30	1,700	HHXJ500□RA820MHA0G
	150	JA0	25	2,000	HHXJ500□RA151MJA0G
	180	JC5	19	3,300	HHXJ500□RA181MJC5G
63	56	HA0	40	1,700	HHXJ630□RA560MHA0G
	100	JA0	30	2,000	HHXJ630□RA101MJA0G
	120	JC5	19	3,300	HHXJ630□RA121MJC5G

□ : Enter the appropriate terminal code.

◆RATED RIPPLE CURRENT MULTIPLIERS

● Frequency Multipliers

Capacitance(μF)	Frequency(Hz)						
	120	1k	5k	10k	20k	30k	100k to 500k
56 to 82	0.15	0.50	0.70	0.75	0.80	0.80	1.00
100 to 820	0.15	0.50	0.70	0.75	0.85	0.85	1.00

HXC Series

- 80VV model has been introduced to the product range. High ripple current model is now available for JC5 size.
- High reliability and high voltage are realized by hybrid electrolyte
- Endurance with ripple current : 4,000 hours at 125°C
- Rated voltage range : 16 to 80V_{dc}, Capacitance range : 6.8 to 560μF
- For high temperature and high reliability applications.
(Automotive equipment, Base station equipment, etc.)
- RoHS2 Compliant
- Halogen Free
- AEC-Q200 compliant : Please contact Chemi-Con for more details, test data, information.

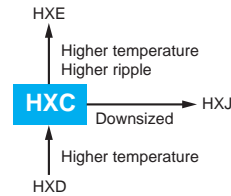

SPECIFICATIONS

Items	Characteristics							
Category	-55 to +125°C							
Temperature Range	-55 to +125°C							
Rated Voltage Range	16 to 80V _{dc}							
Capacitance Tolerance	±20% (M) (at 20°C, 120Hz)							
Leakage Current	I=0.01CV or 3μA, whichever is greater Where, I : Max. leakage current (μA), C: Nominal capacitance(μF), V : Rated voltage(V) (at 20°C after 2 minutes)							
Dissipation Factor (tan δ)	Rated voltage(V _{dc})	16V	25V	35V	50V	63V	80V	(at 20°C, 120Hz)
	tan δ (Max.)	0.16	0.14	0.12	0.10	0.08	0.08	
Low Temperature Characteristics (Max. Impedance Ratio)	Z(-25°C)/Z(+20°C) ≤ 1.5 Z(-55°C)/Z(+20°C) ≤ 2.0 (at 100kHz)							
Endurance	The following specifications shall be satisfied when the capacitors are restored to 20°C after subjected to DC voltage with the rated ripple current is applied (the peak voltage shall not exceed the rated voltage) for 4,000 hours at 125°C.							
	Capacitance change	≤ ±30% of the initial value						
	D.F. (tan δ)	≤ 200% of the initial specified value						
	ESR	≤ 200% of the initial specified value						
	Leakage current	≤ The initial specified value						
Shelf Life	The following specifications shall be satisfied when the capacitors are restored to 20°C after exposing them for 1,000 hours at 125°C without voltage applied. Before the measurement, the capacitor shall be preconditioned by applying voltage according to item 4.1 of JIS C 5101-4.							
	Capacitance change	≤ ±30% of the initial value						
	D.F. (tan δ)	≤ 200% of the initial specified value						
	ESR	≤ 200% of the initial specified value						
	Leakage current	≤ The initial specified value						
Bias Humidity Test	The following specifications shall be satisfied when the capacitors are restored to 20°C after subjecting them to the DC rated voltage at 85°C, 85% RH for 2,000 hours.							
	Appearance	No significant damage						
	Capacitance change	≤ ±30% of the initial value						
	D.F. (tan δ)	≤ 200% of the initial specified value						
	ESR	≤ 200% of the initial specified value						
	Leakage current	≤ The initial specified value						

DIMENSIONS [mm]

- Terminal Code : A
- Size code : E61 to JC5
- Terminal Code : G (Vibration resistant structure)
- Size code : F61 to JC5

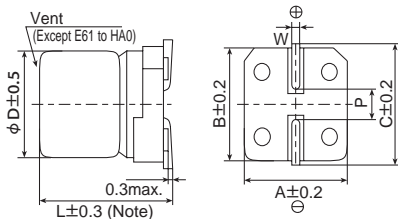

Note : L±0.5 for HA0 to JC5

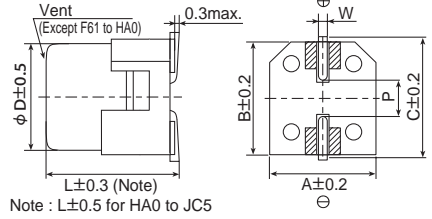

Note : L±0.5 for HA0 to JC5

▨ : Dummy terminals

Size Code	φD	L	A	B	C	W	P
E61	5	5.8	5.3	5.3	5.9	0.5 to 0.8	1.4
F61	6.3	5.8	6.6	6.6	7.2	0.5 to 0.8	1.9
F80	6.3	7.7	6.6	6.6	7.2	0.5 to 0.8	1.9
HA0	8	10.0	8.3	8.3	9.0	0.7 to 1.1	3.1
JA0	10	10.0	10.3	10.3	11.0	0.7 to 1.1	4.5
JC5	10	12.5	10.3	10.3	11.0	0.7 to 1.1	4.5

PART NUMBERING SYSTEM

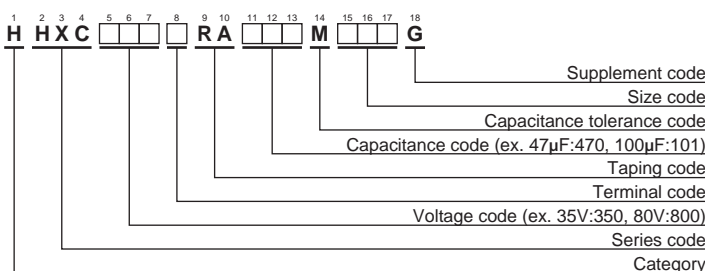

Please refer to "Product code guide (conductive polymer hybrid type)"

MARKING

EX) 35V270μF



Rated voltage symbol

Rated voltage (V _{dc})	Symbol
16	C
25	E
35	V
50	H
63	J
80	K



HXC Series

◆STANDARD RATINGS

WV (V _{dc})	Cap (μF)	Size code	ESR (mΩ max./20°C, 100kHz)	Rated ripple current (mA rms/125°C, 100kHz)	Part No.
16	47	E61	80	550	HHXC160ARA470ME61G
	82	F61	45	950	HHXC160□RA820MF61G
	150	F80	27	1,450	HHXC160□RA151MF80G
	270	HA0	22	1,700	HHXC160□RA271MHA0G
	470	JA0	18	2,100	HHXC160□RA471MJA0G
	560	JC5	15	2,550	HHXC160□RA561MJC5G
25	33	E61	80	550	HHXC250ARA330ME61G
	47	F61	50	900	HHXC250□RA470MF61G
	56	F61	50	900	HHXC250□RA560MF61G
	68	F80	30	1,400	HHXC250□RA680MF80G
	100	F80	30	1,400	HHXC250□RA101MF80G
	150	HA0	27	1,600	HHXC250□RA151MHA0G
	220	HA0	27	1,600	HHXC250□RA221MHA0G
	270	JA0	20	2,000	HHXC250□RA271MJA0G
	330	JA0	20	2,000	HHXC250□RA331MJA0G
470	JC5	16	2,500	HHXC250□RA471MJC5G	
35	22	E61	100	550	HHXC350ARA220ME61G
	27	F61	60	900	HHXC350□RA270MF61G
	47	F61	60	900	HHXC350□RA470MF61G
	47	F80	35	1,400	HHXC350□RA470MF80G
	68	F80	35	1,400	HHXC350□RA680MF80G
	100	HA0	27	1,600	HHXC350□RA101MHA0G
	150	HA0	27	1,600	HHXC350□RA151MHA0G
	150	JA0	20	2,000	HHXC350□RA151MJA0G
	270	JA0	20	2,000	HHXC350□RA271MJA0G
330	JC5	17	2,400	HHXC350□RA331MJC5G	
50	10	F61	80	750	HHXC500□RA100MF61G
	15	F80	40	1,100	HHXC500□RA150MF80G
	22	F61	80	750	HHXC500□RA220MF61G
	33	F80	40	1,100	HHXC500□RA330MF80G
	33	HA0	30	1,250	HHXC500□RA330MHA0G
	47	HA0	30	1,250	HHXC500□RA470MHA0G
	56	JA0	25	1,600	HHXC500□RA560MJA0G
	68	HA0	30	1,250	HHXC500□RA680MHA0G
	100	JA0	25	1,600	HHXC500□RA101MJA0G
	120	JA0	25	1,600	HHXC500□RA121MJA0G
150	JC5	19	2,250	HHXC500□RA151MJC5G	
63	6.8	F61	120	700	HHXC630□RA6R8MF61G
	10	F61	120	700	HHXC630□RA100MF61G
	10	F80	80	900	HHXC630□RA100MF80G
	22	F80	80	900	HHXC630□RA220MF80G
	22	HA0	40	1,100	HHXC630□RA220MHA0G
	33	HA0	40	1,100	HHXC630□RA330MHA0G
	33	JA0	30	1,400	HHXC630□RA330MJA0G
	47	HA0	40	1,100	HHXC630□RA470MHA0G
	56	JA0	30	1,400	HHXC630□RA560MJA0G
	82	JA0	30	1,400	HHXC630□RA820MJA0G
	100	JC5	22	2,100	HHXC630□RA101MJC5G
80	22	HA0	45	1,100	HHXC800□RA220MHA0G
	39	JA0	33	1,400	HHXC800□RA390MJA0G
	47	JA0	33	1,700	HHXC800□RA470MJA0G

□ : Enter the appropriate terminal code.

◆RATED RIPPLE CURRENT MULTIPLIERS

●Frequency Multipliers

Capacitance(μF)	Frequency(Hz)							
	120	1k	5k	10k	20k	30k	100k to 500k	
to 10	0.03	0.30	0.50	0.60	0.70	0.75	1.00	
15 to 33	0.07	0.30	0.50	0.60	0.70	0.75	1.00	
39 to 150	0.10	0.40	0.60	0.70	0.80	0.80	1.00	
220 to 560	0.13	0.45	0.65	0.75	0.85	0.85	1.00	

HXD Series

- High reliability and high voltage are realized by hybrid electrolyte
- Endurance with ripple current : 5,000 to 10,000 hours at 105°C
- Rated voltage range : 16 to 80V_{dc}, Capacitance range : 6.8 to 560μF
- For high reliability applications.
(Automotive equipment, Base station equipment, etc.)
- RoHS2 Compliant
- Halogen Free
- AEC-Q200 compliant : Please contact Chemi-Con for more details, test data, information.

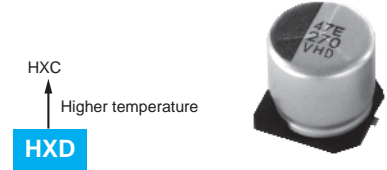

SPECIFICATIONS

Items	Characteristics	
Category	-55 to +105°C	
Temperature Range		
Rated Voltage Range	16 to 80V _{dc}	
Capacitance Tolerance	±20% (M) (at 20°C, 120Hz)	
Leakage Current	I=0.01CV or 3μA, whichever is greater Where, I : Max. leakage current (μA), C: Nominal capacitance(μF), V : Rated voltage(V) (at 20°C after 2 minutes)	
Dissipation Factor (tan δ)	Rated voltage(V _{dc})	16V 25V 35V 50V 63V 80V
	tan δ (Max.)	0.16 0.14 0.12 0.10 0.08 0.08 (at 20°C, 120Hz)
Low Temperature Characteristics (Max. Impedance Ratio)	Z(-25°C)/Z(+20°C) ≤ 1.5 Z(-55°C)/Z(+20°C) ≤ 2.0 (at 100kHz)	
Endurance	The following specifications shall be satisfied when the capacitors are restored to 20°C after subjected to DC voltage with the rated ripple current is applied (the peak voltage shall not exceed the rated voltage) for 10,000 hours (E61 and F61: 5,000 hours) at 105 °C.	
	Capacitance change	≤ ±30% of the initial value
	D.F. (tan δ)	≤ 200% of the initial specified value
	ESR	≤ 200% of the initial specified value
	Leakage current	≤ The initial specified value
Shelf Life	The following specifications shall be satisfied when the capacitors are restored to 20°C after exposing them for 1,000 hours at 105 °C without voltage applied. Before the measurement, the capacitor shall be preconditioned by applying voltage according to item 4.1 of JIS C 5101-4.	
	Capacitance change	≤ ±30% of the initial value
	D.F. (tan δ)	≤ 200% of the initial specified value
	ESR	≤ 200% of the initial specified value
	Leakage current	≤ The initial specified value
Bias Humidity Test	The following specifications shall be satisfied when the capacitors are restored to 20°C after subjecting them to the DC rated voltage at 85°C, 85% RH for 2,000 hours.	
	Appearance	No significant damage
	Capacitance change	≤ ±30% of the initial value
	D.F. (tan δ)	≤ 200% of the initial specified value
	ESR	≤ 200% of the initial specified value
	Leakage current	≤ The initial specified value

DIMENSIONS [mm]

- Terminal Code : A
- Size code : E61 to JA0
- Terminal Code : G(Vibration resistant structure)
- Size code : F61 to JA0

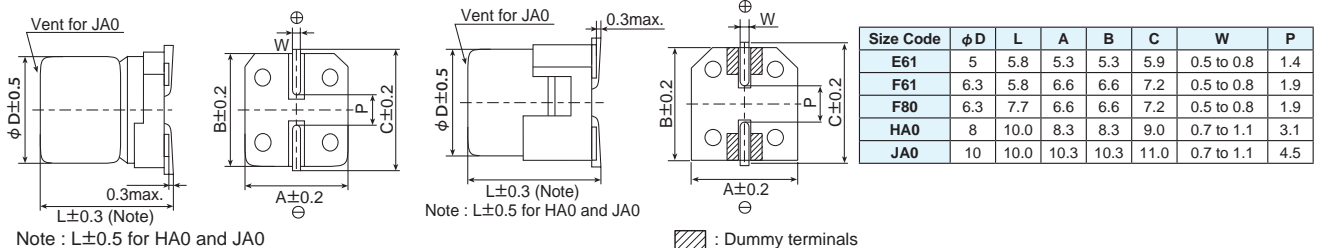

PART NUMBERING SYSTEM

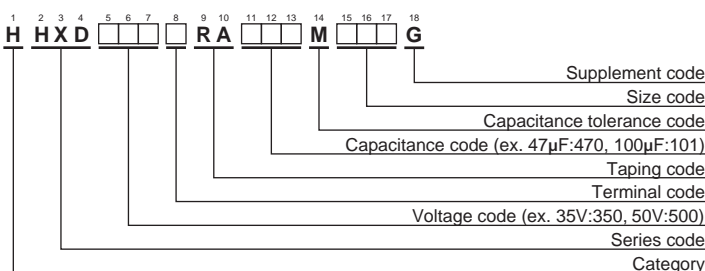

MARKING

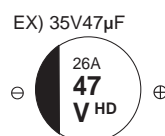

Rated voltage symbol

Rated voltage (V _{dc})	Symbol
16	C
25	E
35	V
50	H
63	J
80	K

Please refer to "Product code guide (conductive polymer hybrid type)"



HXD Series

◆STANDARD RATINGS

WV (V _{dc})	Cap (μF)	Size code	ESR (mΩ max./20°C, 100kHz)	Rated ripple current (mA rms/105°C, 100kHz)	Part No.
16	47	E61	80	900	HHXD160ARA470ME61G
	82	F61	45	1,600	HHXD160□RA820MF61G
	100	F61	45	1,600	HHXD160□RA101MF61G
	150	F80	27	2,200	HHXD160□RA151MF80G
	180	F80	27	2,200	HHXD160□RA181MF80G
	270	HA0	22	2,500	HHXD160□RA271MHA0G
	330	HA0	22	2,500	HHXD160□RA331MHA0G
	470	JA0	18	2,600	HHXD160□RA471MJA0G
560	JA0	18	2,600	HHXD160□RA561MJA0G	
25	33	E61	80	900	HHXD250ARA330ME61G
	47	F61	50	1,300	HHXD250□RA470MF61G
	56	F61	50	1,300	HHXD250□RA560MF61G
	68	F80	30	2,000	HHXD250□RA680MF80G
	100	F80	30	2,000	HHXD250□RA101MF80G
	150	HA0	27	2,300	HHXD250□RA151MHA0G
	220	HA0	27	2,300	HHXD250□RA221MHA0G
	270	JA0	20	2,500	HHXD250□RA271MJA0G
	330	JA0	20	2,500	HHXD250□RA331MJA0G
	390	JA0	20	2,500	HHXD250□RA391MJA0G
35	22	E61	100	900	HHXD350ARA220ME61G
	27	F61	60	1,300	HHXD350□RA270MF61G
	47	F61	60	1,300	HHXD350□RA470MF61G
	47	F80	35	2,000	HHXD350□RA470MF80G
	68	F80	35	2,000	HHXD350□RA680MF80G
	100	HA0	27	2,300	HHXD350□RA101MHA0G
	150	HA0	27	2,300	HHXD350□RA151MHA0G
	150	JA0	20	2,500	HHXD350□RA151MJA0G
270	JA0	20	2,500	HHXD350□RA271MJA0G	
50	10	F61	80	1,100	HHXD500□RA100MF61G
	15	F80	40	1,600	HHXD500□RA150MF80G
	22	F61	80	1,100	HHXD500□RA220MF61G
	33	F80	40	1,600	HHXD500□RA330MF80G
	33	HA0	30	1,800	HHXD500□RA330MHA0G
	47	HA0	30	1,800	HHXD500□RA470MHA0G
	56	JA0	25	2,400	HHXD500□RA560MJA0G
	68	HA0	30	1,800	HHXD500□RA680MHA0G
	82	HA0	30	1,800	HHXD500□RA820MHA0G
	100	JA0	25	2,400	HHXD500□RA101MJA0G
120	JA0	25	2,400	HHXD500□RA121MJA0G	
63	6.8	F61	120	1,000	HHXD630□RA6R8MF61G
	10	F61	120	1,000	HHXD630□RA100MF61G
	10	F80	80	1,500	HHXD630□RA100MF80G
	22	F80	80	1,500	HHXD630□RA220MF80G
	22	HA0	40	1,600	HHXD630□RA220MHA0G
	33	HA0	40	1,600	HHXD630□RA330MHA0G
	33	JA0	30	2,400	HHXD630□RA330MJA0G
	47	HA0	40	1,600	HHXD630□RA470MHA0G
	56	JA0	30	2,400	HHXD630□RA560MJA0G
	82	JA0	30	2,400	HHXD630□RA820MJA0G
100	JA0	30	2,400	HHXD630□RA101MJA0G	
80	27	HA0	45	1,600	HHXD800□RA270MHA0G
	56	JA0	33	2,400	HHXD800□RA560MJA0G

□ : Enter the appropriate terminal code.

◆RATED RIPPLE CURRENT MULTIPLIERS

● Frequency Multipliers

Capacitance(μF)	Frequency(Hz)							
	120	1k	5k	10k	20k	30k	100k to 500k	
to 10	0.03	0.30	0.50	0.60	0.70	0.75	1.00	
15 to 33	0.07	0.30	0.50	0.60	0.70	0.75	1.00	
47 to 180	0.10	0.40	0.60	0.70	0.80	0.80	1.00	
220 to 560	0.13	0.45	0.65	0.75	0.85	0.85	1.00	

HSE Series

- High reliability and high voltage are realized by hybrid electrolyte
- Endurance with ripple current : 4,000 hours at 135°C
- Rated voltage range : 25 to 63V_{dc}, Capacitance range : 100 to 330μF
- For high temperature and high reliability applications.
(Automotive equipment, Base station equipment, etc.)
- RoHS2 Compliant
- Halogen Free
- AEC-Q200 compliant : Please contact Chemi-Con for more details, test data, information.

HSE

↑ Higher temperature
Higher ripple
HSC



SPECIFICATIONS

Items	Characteristics										
Category	-55 to +135°C										
Temperature Range	-55 to +135°C										
Rated Voltage Range	25 to 63V _{dc}										
Capacitance Tolerance	±20% (M) (at 20°C, 120Hz)										
Leakage Current	I=0.05CV Where, I : Max. leakage current (μA), C: Nominal capacitance(μF), V : Rated voltage(V) (at 20°C after 2 minutes)										
Dissipation Factor (tan δ)	0.16 max. (at 20°C, 120Hz)										
Low Temperature Characteristics (Max. Impedance Ratio)	Z(-25°C)/Z(+20°C) ≤ 1.5 Z(-55°C)/Z(+20°C) ≤ 2.0 (at 100kHz)										
Endurance	The following specifications shall be satisfied when the capacitors are restored to 20°C after subjected to DC voltage with the rated ripple current is applied (the peak voltage shall not exceed the rated voltage) for 4,000 hours at 125°C or 135°C. <table border="1"> <tr> <td>Capacitance change</td> <td>≤ ±30% of the initial value</td> </tr> <tr> <td>D.F. (tan δ)</td> <td>≤ 200% of the initial specified value</td> </tr> <tr> <td>ESR</td> <td>≤ 200% of the initial specified value</td> </tr> <tr> <td>Leakage current</td> <td>≤ The initial specified value</td> </tr> </table>	Capacitance change	≤ ±30% of the initial value	D.F. (tan δ)	≤ 200% of the initial specified value	ESR	≤ 200% of the initial specified value	Leakage current	≤ The initial specified value		
Capacitance change	≤ ±30% of the initial value										
D.F. (tan δ)	≤ 200% of the initial specified value										
ESR	≤ 200% of the initial specified value										
Leakage current	≤ The initial specified value										
Shelf Life	The following specifications shall be satisfied when the capacitors are restored to 20°C after exposing them for 1,000 hours at 135°C without voltage applied. Before the measurement, the capacitor shall be preconditioned by applying voltage according to item 4.1 of JIS C 5101-4. <table border="1"> <tr> <td>Capacitance change</td> <td>≤ ±30% of the initial value</td> </tr> <tr> <td>D.F. (tan δ)</td> <td>≤ 200% of the initial specified value</td> </tr> <tr> <td>ESR</td> <td>≤ 200% of the initial specified value</td> </tr> <tr> <td>Leakage current</td> <td>≤ The initial specified value</td> </tr> </table>	Capacitance change	≤ ±30% of the initial value	D.F. (tan δ)	≤ 200% of the initial specified value	ESR	≤ 200% of the initial specified value	Leakage current	≤ The initial specified value		
Capacitance change	≤ ±30% of the initial value										
D.F. (tan δ)	≤ 200% of the initial specified value										
ESR	≤ 200% of the initial specified value										
Leakage current	≤ The initial specified value										
Bias Humidity Test	The following specifications shall be satisfied when the capacitors are restored to 20°C after subjecting them to the DC rated voltage at 85°C, 85% RH for 2,000 hours. <table border="1"> <tr> <td>Appearance</td> <td>No significant damage</td> </tr> <tr> <td>Capacitance change</td> <td>≤ ±30% of the initial value</td> </tr> <tr> <td>D.F. (tan δ)</td> <td>≤ 200% of the initial specified value</td> </tr> <tr> <td>ESR</td> <td>≤ 200% of the initial specified value</td> </tr> <tr> <td>Leakage current</td> <td>≤ The initial specified value</td> </tr> </table>	Appearance	No significant damage	Capacitance change	≤ ±30% of the initial value	D.F. (tan δ)	≤ 200% of the initial specified value	ESR	≤ 200% of the initial specified value	Leakage current	≤ The initial specified value
Appearance	No significant damage										
Capacitance change	≤ ±30% of the initial value										
D.F. (tan δ)	≤ 200% of the initial specified value										
ESR	≤ 200% of the initial specified value										
Leakage current	≤ The initial specified value										

DIMENSIONS [mm]

Terminal Code : E

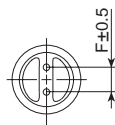
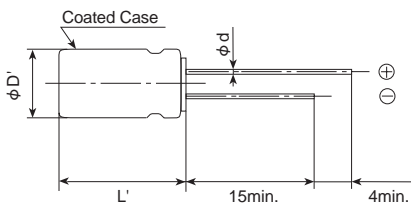

Size Code	JC5
φD	10
φd	0.6
F	5.0
φD'	φD+0.5max.
L'	L+1.5max.

MARKING

EX) 35V270μF



Rated voltage symbol

Rated voltage (V _{dc})	Symbol
25	E
35	V
50	H
63	J

PART NUMBERING SYSTEM

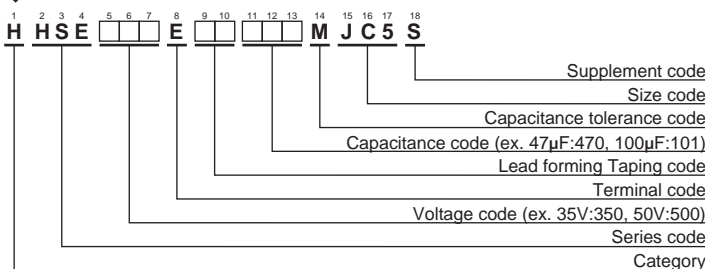

Please refer to "Product code guide (conductive polymer hybrid type)"



HSE Series

◆ **STANDARD RATINGS**

WV (V _{dc})	Cap (μF)	Case size φ D×L (mm)	ESR (mΩ max./20°C, 100kHz)	Rated ripple current (mArms/100kHz)		Part No.
				125°C	135°C	
25	330	10×12.5	16	3,800	2,300	HHSE250E□□331MJC5S
35	270	10×12.5	17	3,700	2,200	HHSE350E□□271MJC5S
50	120	10×12.5	19	3,500	2,100	HHSE500E□□121MJC5S
63	100	10×12.5	20	3,400	2,000	HHSE630E□□101MJC5S

□□:Enter the appropriate lead forming or taping code.

◆ **RATED RIPPLE CURRENT MULTIPLIERS**

● Frequency Multipliers

Capacitance(μF) \ Frequency(Hz)	120	1k	5k	10k	20k	30k	100k to 500k
100, 120	0.10	0.40	0.60	0.70	0.80	0.80	1.00
270, 330	0.13	0.45	0.65	0.75	0.85	0.85	1.00

HSC Series

- High reliability and high voltage are realized by hybrid electrolyte
- Endurance with ripple current : 4,000 hours at 125°C
- Rated voltage range : 25 to 80V_{dc}, Capacitance range : 56 to 330μF
- For high temperature and high reliability applications.
(Automotive equipment, Base station equipment, etc.)
- RoHS2 Compliant
- Halogen Free
- AEC-Q200 compliant : Please contact Chemi-Con for more details, test data, information.

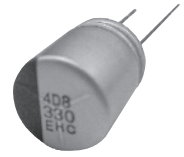
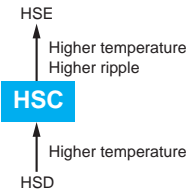

SPECIFICATIONS

Items	Characteristics										
Category	-55 to +125°C										
Temperature Range											
Rated Voltage Range	25 to 80V _{dc}										
Capacitance Tolerance	±20% (M) (at 20°C, 120Hz)										
Leakage Current	I=0.05CV Where, I : Max. leakage current (μA), C: Nominal capacitance(μF), V : Rated voltage(V) (at 20°C after 2 minutes)										
Dissipation Factor (tan δ)	0.16 max. (at 20°C, 120Hz)										
Low Temperature Characteristics (Max. Impedance Ratio)	Z(-25°C)/Z(+20°C) ≤ 1.5 Z(-55°C)/Z(+20°C) ≤ 2.0 (at 100kHz)										
Endurance	The following specifications shall be satisfied when the capacitors are restored to 20°C after subjected to DC voltage with the rated ripple current is applied (the peak voltage shall not exceed the rated voltage) for 4,000 hours at 125°C. <table border="1"> <tr> <td>Capacitance change</td> <td>≤ ±30% of the initial value</td> </tr> <tr> <td>D.F. (tan δ)</td> <td>≤ 200% of the initial specified value</td> </tr> <tr> <td>ESR</td> <td>≤ 200% of the initial specified value</td> </tr> <tr> <td>Leakage current</td> <td>≤ The initial specified value</td> </tr> </table>	Capacitance change	≤ ±30% of the initial value	D.F. (tan δ)	≤ 200% of the initial specified value	ESR	≤ 200% of the initial specified value	Leakage current	≤ The initial specified value		
Capacitance change	≤ ±30% of the initial value										
D.F. (tan δ)	≤ 200% of the initial specified value										
ESR	≤ 200% of the initial specified value										
Leakage current	≤ The initial specified value										
Shelf Life	The following specifications shall be satisfied when the capacitors are restored to 20°C after exposing them for 1,000 hours at 125°C without voltage applied. Before the measurement, the capacitor shall be preconditioned by applying voltage according to item 4.1 of JIS C 5101-4. <table border="1"> <tr> <td>Capacitance change</td> <td>≤ ±30% of the initial value</td> </tr> <tr> <td>D.F. (tan δ)</td> <td>≤ 200% of the initial specified value</td> </tr> <tr> <td>ESR</td> <td>≤ 200% of the initial specified value</td> </tr> <tr> <td>Leakage current</td> <td>≤ The initial specified value</td> </tr> </table>	Capacitance change	≤ ±30% of the initial value	D.F. (tan δ)	≤ 200% of the initial specified value	ESR	≤ 200% of the initial specified value	Leakage current	≤ The initial specified value		
Capacitance change	≤ ±30% of the initial value										
D.F. (tan δ)	≤ 200% of the initial specified value										
ESR	≤ 200% of the initial specified value										
Leakage current	≤ The initial specified value										
Bias Humidity Test	The following specifications shall be satisfied when the capacitors are restored to 20°C after subjecting them to the DC rated voltage at 85°C, 85% RH for 2,000 hours. <table border="1"> <tr> <td>Appearance</td> <td>No significant damage</td> </tr> <tr> <td>Capacitance change</td> <td>≤ ±30% of the initial value</td> </tr> <tr> <td>D.F. (tan δ)</td> <td>≤ 200% of the initial specified value</td> </tr> <tr> <td>ESR</td> <td>≤ 200% of the initial specified value</td> </tr> <tr> <td>Leakage current</td> <td>≤ The initial specified value</td> </tr> </table>	Appearance	No significant damage	Capacitance change	≤ ±30% of the initial value	D.F. (tan δ)	≤ 200% of the initial specified value	ESR	≤ 200% of the initial specified value	Leakage current	≤ The initial specified value
Appearance	No significant damage										
Capacitance change	≤ ±30% of the initial value										
D.F. (tan δ)	≤ 200% of the initial specified value										
ESR	≤ 200% of the initial specified value										
Leakage current	≤ The initial specified value										

DIMENSIONS [mm]

Terminal Code : E

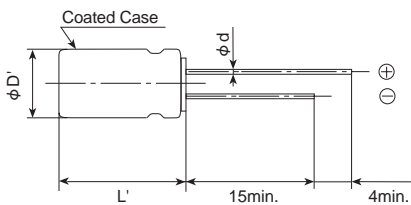

Size Code	JC5
φD	10
φd	0.6
F	5.0
φD'	φD+0.5max.
L'	L+1.5max.

MARKING

EX) 80V56μF



Rated voltage symbol

Rated voltage (V _{dc})	Symbol
25	E
35	V
50	H
63	J
80	K

PART NUMBERING SYSTEM

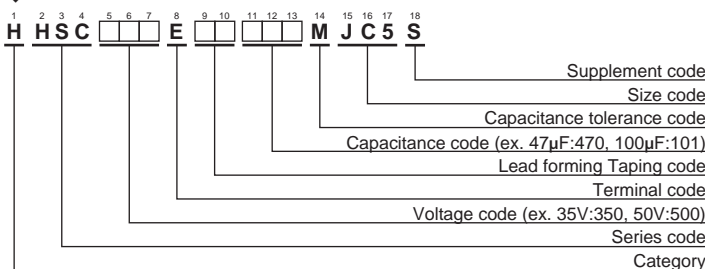

Please refer to "Product code guide (conductive polymer hybrid type)"



HSCSeries

◆ **STANDARD RATINGS**

WV (V _{dc})	Cap (μF)	Case size φD×L (mm)	ESR (mΩ max./20°C, 100kHz)	Rated ripple current (mA _{rms} /125°C, 100kHz)	Part No.
25	330	10×12.5	16	2,300	HHSC250E□□331MJC5S
35	270	10×12.5	17	2,200	HHSC350E□□271MJC5S
50	120	10×12.5	19	2,100	HHSC500E□□121MJC5S
63	100	10×12.5	20	2,000	HHSC630E□□101MJC5S
80	56	10×12.5	28	1,900	HHSC800E□□560MJC5S

□□:Enter the appropriate lead forming or taping code.

◆ **RATED RIPPLE CURRENT MULTIPLIERS**

● Frequency Multipliers

Capacitance(μF) \ Frequency(Hz)	120	1k	5k	10k	20k	30k	100k to 500k
56 to 120	0.10	0.40	0.60	0.70	0.80	0.80	1.00
270, 330	0.13	0.45	0.65	0.75	0.85	0.85	1.00

HSD Series

- High reliability and high voltage are realized by hybrid electrolyte
- Endurance with ripple current : 10,000 hours at 105°C
- Rated voltage range : 25 to 80V_{dc}, Capacitance range : 68 to 470μF
- For high reliability applications.
(Automotive equipment, Base station equipment, etc.)
- RoHS2 Compliant
- Halogen Free
- AEC-Q200 compliant : Please contact Chemi-Con for more details, test data, information.

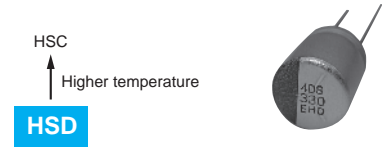

SPECIFICATIONS

Items	Characteristics										
Category	-55 to +105°C										
Temperature Range											
Rated Voltage Range	25 to 80V _{dc}										
Capacitance Tolerance	±20% (M) (at 20°C, 120Hz)										
Leakage Current	I=0.05CV Where, I : Max. leakage current (μA), C: Nominal capacitance(μF), V : Rated voltage(V) (at 20°C after 2 minutes)										
Dissipation Factor (tan δ)	0.16 max. (at 20°C, 120Hz)										
Low Temperature Characteristics (Max. Impedance Ratio)	Z(-25°C)/Z(+20°C) ≤ 1.5 Z(-55°C)/Z(+20°C) ≤ 2.0 (at 100kHz)										
Endurance	The following specifications shall be satisfied when the capacitors are restored to 20°C after subjected to DC voltage with the rated ripple current is applied (the peak voltage shall not exceed the rated voltage) for 10,000 hours at 105 °C. <table border="1"> <tr> <td>Capacitance change</td> <td>≤ ±30% of the initial value</td> </tr> <tr> <td>D.F. (tan δ)</td> <td>≤ 200% of the initial specified value</td> </tr> <tr> <td>ESR</td> <td>≤ 200% of the initial specified value</td> </tr> <tr> <td>Leakage current</td> <td>≤ The initial specified value</td> </tr> </table>	Capacitance change	≤ ±30% of the initial value	D.F. (tan δ)	≤ 200% of the initial specified value	ESR	≤ 200% of the initial specified value	Leakage current	≤ The initial specified value		
Capacitance change	≤ ±30% of the initial value										
D.F. (tan δ)	≤ 200% of the initial specified value										
ESR	≤ 200% of the initial specified value										
Leakage current	≤ The initial specified value										
Shelf Life	The following specifications shall be satisfied when the capacitors are restored to 20°C after exposing them for 1,000 hours at 105 °C without voltage applied. Before the measurement, the capacitor shall be preconditioned by applying voltage according to item 4.1 of JIS C 5101-4. <table border="1"> <tr> <td>Capacitance change</td> <td>≤ ±30% of the initial value</td> </tr> <tr> <td>D.F. (tan δ)</td> <td>≤ 200% of the initial specified value</td> </tr> <tr> <td>ESR</td> <td>≤ 200% of the initial specified value</td> </tr> <tr> <td>Leakage current</td> <td>≤ The initial specified value</td> </tr> </table>	Capacitance change	≤ ±30% of the initial value	D.F. (tan δ)	≤ 200% of the initial specified value	ESR	≤ 200% of the initial specified value	Leakage current	≤ The initial specified value		
Capacitance change	≤ ±30% of the initial value										
D.F. (tan δ)	≤ 200% of the initial specified value										
ESR	≤ 200% of the initial specified value										
Leakage current	≤ The initial specified value										
Bias Humidity Test	The following specifications shall be satisfied when the capacitors are restored to 20°C after subjecting them to the DC rated voltage at 85°C, 85% RH for 2,000 hours. <table border="1"> <tr> <td>Appearance</td> <td>No significant damage</td> </tr> <tr> <td>Capacitance change</td> <td>≤ ±30% of the initial value</td> </tr> <tr> <td>D.F. (tan δ)</td> <td>≤ 200% of the initial specified value</td> </tr> <tr> <td>ESR</td> <td>≤ 200% of the initial specified value</td> </tr> <tr> <td>Leakage current</td> <td>≤ The initial specified value</td> </tr> </table>	Appearance	No significant damage	Capacitance change	≤ ±30% of the initial value	D.F. (tan δ)	≤ 200% of the initial specified value	ESR	≤ 200% of the initial specified value	Leakage current	≤ The initial specified value
Appearance	No significant damage										
Capacitance change	≤ ±30% of the initial value										
D.F. (tan δ)	≤ 200% of the initial specified value										
ESR	≤ 200% of the initial specified value										
Leakage current	≤ The initial specified value										

DIMENSIONS [mm]

Terminal Code : E

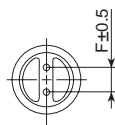
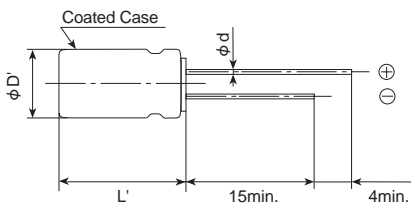

Size Code	JC5
φD	10
φd	0.6
F	5.0
φD'	φD+0.5max.
L'	L+1.5max.

MARKING

EX) 25V330μF



Rated voltage symbol

Rated voltage (V _{dc})	Symbol
25	E
35	V
50	H
63	J
80	K

PART NUMBERING SYSTEM

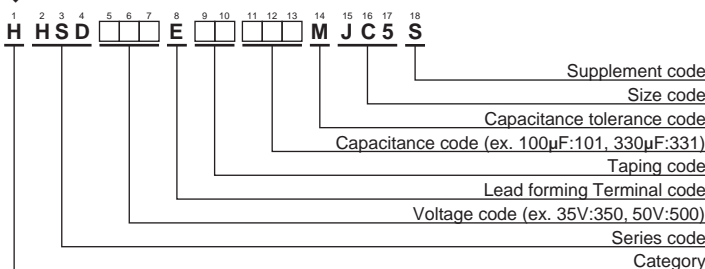

Please refer to "Product code guide (conductive polymer hybrid type)"



HSDSeries

◆STANDARD RATINGS

WV (V _{dc})	Cap (μF)	Case size φ D×L (mm)	ESR (mΩ max./20°C, 100kHz)	Rated ripple current (mA _{rms} /105°C, 100kHz)	Part No.
25	330	10×12.5	16	3,100	HHSD250E□□331MJC5S
	470	10×12.5	16	3,100	HHSD250E□□471MJC5S
35	270	10×12.5	17	3,000	HHSD350E□□271MJC5S
	330	10×12.5	17	3,000	HHSD350E□□331MJC5S
50	120	10×12.5	19	2,800	HHSD500E□□121MJC5S
	180	10×12.5	19	3,000	HHSD500E□□181MJC5S
63	100	10×12.5	20	2,600	HHSD630E□□101MJC5S
	120	10×12.5	20	3,000	HHSD630E□□121MJC5S
80	68	10×12.5	28	3,000	HHSD800E□□680MJC5S

□□:Enter the appropriate lead forming or taping code.

◆RATED RIPPLE CURRENT MULTIPLIERS

● Frequency Multipliers

Capacitance(μF)	Frequency(Hz)						
	120	1k	5k	10k	20k	30k	100k to 500k
68 to 180	0.10	0.40	0.60	0.70	0.80	0.80	1.00
270 to 470	0.13	0.45	0.65	0.75	0.85	0.85	1.00

Aluminum Electrolytic Capacitors



Precautions and Guidelines (Aluminum Electrolytic Capacitors)

The circuits described as examples in this catalog and the "delivery specifications" are featured in order to show the operations and usage of our products, however, this fact does not guarantee that the circuits are available to function in your equipment systems.

We are not in any case responsible for any failures or damage caused by the use of information contained herein.

You should examine our products, of which the characteristics are described in the "delivery specifications" and other documents, and determine whether or not our products suit your requirements according to the specifications of your equipment systems. Therefore, you bear final responsibility regarding the use of our products.

Please make sure that you take appropriate safety measures such as use of redundant design and malfunction prevention measures in order to prevent fatal accidents and/or fires in the event any of our products malfunction.

For Conductive Polymer Aluminum Solid Capacitors, see Precautions and Guidelines (Conductive Polymer).

For Conductive Polymer Hybrid Aluminum Electrolytic Capacitors, see Precautions and Guidelines (Conductive Polymer Hybrid).

1 Device circuits design considerations

1) Confirm installation and operating requirements for capacitors, then use them within the performance limits prescribed in this catalog or product specifications.

2) Polarity

Aluminum electrolytic capacitors are polarized.

Never apply a reverse voltage or AC voltage. Connecting with wrong polarity will short-circuit or damage the capacitor with the pressure relief vent opening early on. To identify the polarity of a capacitor, see the relevant diagram in the catalogs or product specifications, or the polarity marking on the body of the capacitor. Incidentally, the rubber end seal bungs of the radial lead type capacitors have a solder-flux gas escaping configuration, which is nothing to do with the polarity of the capacitors. For circuits where the polarity is occasionally reversed, use a bipolar type of aluminum electrolytic capacitor. However, note that even bi-polar type capacitors must not be used for AC circuits.

3) Operating voltage

Do not apply an over-voltage that exceeds a rated voltage specified for the capacitors. The total peak value of the ripple voltage plus the DC voltage must not exceed the rated voltage of the capacitors. Although capacitors specify a surge voltage that exceeds the full rated voltage, it does not assure long-term use but limited use under specific conditions.

4) Ripple current

Do not apply an overcurrent that exceeds the rated ripple current specified for the capacitors. Excessive ripple current will increase heat production within the capacitors, causing the capacitors to be damaged as follows:

- Shorten lifetime
- Open pressure relief vent
- Short circuit

The rated ripple current is specified along with a specific ripple frequency.

When using the capacitors at any other ripple frequency other than the specified frequency, calculate the allowable ripple current by multiplying the rated ripple current by a frequency compensation factor (Frequency Multiplier) specified for each product series.

5) Operating temperature (Category temperature)

Do not apply high temperatures that exceed the upper limit of the category temperature range specified for the capacitors.

Using the capacitor at temperatures higher than the upper limit will considerably shorten the lifetime of the capacitor and make the pressure relief vent open.

In other words, lowering ambient temperatures will extend the expected lifetime of the capacitors.

6) Lifetime

Select the capacitors to meet the service life requirements of a device.

7) Charging and discharging

Do not use capacitors in circuits intended for rapid charge and discharge cycle operations.

If capacitors are used in the circuits that repeat a charge and discharge with a large voltage drop or a rapid charge and discharge at a short interval cycle, capacitance will decrease and/or the capacitors will be damaged by internal heat generation.

Consult us for a heavy charge and discharge type of capacitor so that the capacitor will be designed in accordance with requirements of duty cycle of charge and discharge, the number of cycles, discharging resistance and operating temperatures.

8) Failure mode of capacitors

Non-solid aluminum electrolytic capacitors have a limited lifetime which ends in an open circuit failure mode, in general. Depending on the product type and operating conditions, the failure mode may involve in opening of the pressure relief vent.

9) Capacitor insulation

Electrically isolate the following sections of a capacitor from the negative terminal, the positive terminal and the circuit patterns.

- The outer can case of a non-solid aluminum capacitor.
- The dummy terminal of a snap-in type non-solid aluminum capacitor, which is designed for mounting stability.

10) Outer sleeve

The outer sleeve of a capacitor does not assure electrical insulation (except for screw-terminal type capacitors). It should not be used where electrical insulation is required.

11) Operating conditions

Do not use/expose capacitors to the following conditions:

- ① Direct contact with water, salt water or oil, or high condensation environment.
 - ② Direct sunlight.
 - ③ Toxic gases such as hydrogen sulfide, sulfurous acid, nitrous acid, chlorine and its compounds, bromine and its compounds and ammonium.
 - ④ Ozone, ultraviolet rays or radiation.
 - ⑤ Extreme vibration or mechanical shock that exceeds limits in the catalogs or product specifications.
- The standard vibration condition is applicable to JIS C 5101-4.

12) Mounting

① Non-solid aluminum electrolytic capacitors contain paper separators and electric-conductive electrolyte that contains organic solvent as main solvent material, both of which are flammable. If the electrolyte leaks onto a printed circuit board, it can erode the device circuit pattern, may short-circuit the copper traces, smoke and burn. Make sure of designing a PC board as follows:

- Provide the appropriate hole spacing on the PC board to match the terminal spacing of a capacitor.
- Provide the following adequate clearance space over the pressure relief vent of a capacitor to avoid blocking the correct opening of the pressure relief vent.



Precautions and Guidelines (Aluminum Electrolytic Capacitors)

Case diameter	Clearance
φ 8(6.3) to φ 16mm:	2mm minimum
φ 18 to φ 35mm:	3mm minimum
φ 40 mm and above:	5mm minimum

- Do not locate any wire or circuit pattern over the pressure relief vent of a capacitor.
 - If a capacitor is mounted with its pressure relief vent facing down on the PC board, provide a ventilation hole in the board beneath it to let gas escape when the vent opens.
 - Do not print any copper trace under the seal (terminal) side of a capacitor. Copper traces should be 1 mm (preferably 2mm or more) spaced apart from the side of the capacitor body.
 - Avoid locating any heat source components near capacitors or on the opposite side of the PC board under capacitors.
 - In designing a double-sided PC board, do not locate any through-hole via or unnecessary hole underneath a capacitor.
 - In designing a double-sided PC board, do not print any circuit pattern underneath a capacitor.
- ② For a screw terminal type capacitor, tightening the terminal screws and the mounting clamp should be within the maximum torque specified in the catalogs or product specifications. Do not mount a screw terminal type capacitor with the terminals facing downward. Also, if the body of a capacitor is installed horizontally such as being laid on its side, do not position the pressure relief vent downward.
 - ③ For a chip type capacitor, design the land patterns of the PC board in accordance with the recommended footprint dimensions described in the catalogs or product specifications.

13) Using capacitors for significantly safety-oriented applications

Consult with us in advance of usage of our products in the following listed applications. ① Aerospace equipment ② Power generation equipment such as thermal power, nuclear power etc. ③ Medical equipment ④ Transport equipment (automobiles, trains, ships, etc.) ⑤ Transportation control equipment ⑥ Disaster prevention / crime prevention equipment ⑦ Highly publicized information processing equipment ⑧ Submarine equipment ⑨ Other applications that are not considered general-purpose applications.

Note that some products such as photoflash use capacitors which have been designed for specific applications cannot be used for any other application.

14) Others

Design device circuits taking into consideration the following conditions:

- ① Electrical characteristics of a capacitor depend on the temperature and frequency. In designing the device circuits, consider the change in the characteristics.
- ② If using more than one capacitor connected in parallel, design the device circuits to balance the current flow in individual capacitors.
- ③ If using more than one capacitor connected in series, connect shunting resistors in parallel with the individual capacitors to balance the voltage.

2) Installation

1) Assembling

- ① Do not try to reuse the capacitors once assembled and electrified, except only capacitors that are taken from a device for periodic inspection to measure their electrical characteristics.
- ② Capacitors may have been spontaneously recharged with time by a recovery voltage phenomenon. In this case, discharge the capacitors through a resistor of approximately 1kΩ before use.
- ③ If non-solid aluminum electrolytic capacitors have been stored at any conditions more than 35°C and 75%RH for long storage periods of time more than the limits specified in the catalogs or product specifications, they may have high leakage current. In this case, make pre-conditioning by applying the rated voltage through a resistor of approximately 1kΩ.

- ④ Confirm the rated capacitance and voltage of capacitors before installation.
- ⑤ Confirm the polarity of capacitors before installation.
- ⑥ Do not try to use the capacitors that were dropped to the floor and so forth.
- ⑦ Do not deform the can case of a capacitor.
- ⑧ Make sure that the terminal spacing of a capacitor equals the holes spacing on the PC board before installing the capacitor. For radial lead type capacitors, some standard pre-formed lead types are also available.
- ⑨ When installing a snap-in type capacitor on the PC board, insert the terminals into the holes and press the capacitor down until the body is settled flush on the surface of the PC board (without the body standing off).
- ⑩ Do not apply excessive mechanical force to capacitors more than the limits prescribed in the catalogs or product specifications. Avoid excessive mechanical force while the capacitors are in the process of vacuum-picking, placing and positioning by automatic mounting machines or cutting the lead wires by automatic insertion machines.

2) Soldering and heat resistance

- ① For soldering using a soldering iron, consider the following conditions:
 - Soldering conditions (temperature and time) should be within the limits prescribed in the catalogs or product specifications.
 - If it is necessary to pre-form the terminal spacing of a capacitor to match the hole spacing on the PC board before assembly and soldering, do not make mechanical stress reach into the body of the capacitor but only the lead wires.
 - Do not touch the body of a capacitor with the hot tip of the soldering iron.
- ② For flow soldering, consider the following conditions:
 - Do not dip the body of a capacitor into a solder bath. Expose only the terminals to the melt solder with the PC board interposing between the solder and the body of the capacitor. Solder only the reverse side of the PC board where the body of the capacitor is not located.
 - Soldering conditions should be within the limits prescribed in the catalogs or product specifications.
 - Do not apply flux to any part of a capacitor other than the terminals.
 - Do not let any other component lean against nor come into contact with the capacitor while soldering.
- ③ For reflow soldering, consider the following conditions:
 - Soldering conditions (preheat, reflow temperature and time) should be within the limits prescribed in the catalogs or product specifications.
 - When using the infrared heater and setting its temperatures, adjust the heating levels taking into consideration that the color and materials of a capacitor vary in their infrared absorbance.
 - The allowable number of reflow passes is specified in the catalogs or product specifications.
 - When mounting a capacitor on the double-sided PC board, do not place any wiring pattern underneath the capacitor.
 - Please consult us about vapor phase soldering (VPS).
- ④ Do not try to reuse the capacitor that was removed from the PC board after soldering.
- ⑤ Only use chip type capacitors for reflow soldering. The other type capacitors are not designed for the reflow.

3) Handling after soldering

After soldering the PC board, do not apply the following mechanical stress to the capacitor:

- ① Do not tilt, push down or twist the body of the capacitor.
- ② Do not grab the body of the capacitor to carry the assembly board.
- ③ Do not hit anything against the capacitor. When stacking the assembled boards, do not put any of the PC boards or other



Precautions and Guidelines (Aluminum Electrolytic Capacitors)

components against the capacitor.

- ④ Do not drop the assembled board.

4) Cleaning assembly boards

- ① Do not clean capacitors with the following cleaning agents:
• Halogenated solvents: cause capacitor failures due to corrosion.
• Alkali system solvents: corrode (dissolve) the aluminum can case.
• Terpene and petroleum system solvents: deteriorate the rubber seal materials.
• Xylene and toluene: deteriorates the rubber seal materials as well.
• Acetone: erases the markings printed on a capacitor.

Where cleaning is necessary, use only solvent resistant type capacitors that have been assured for the cleaning within the specific cleaning conditions prescriber in the catalogs or product specifications. In particular, carefully set up the conditions for ultrasonic cleaning system.

- ② Where cleaning the solvent resistance type of aluminum electrolytic capacitors, confirm the following conditions:
• Control the contamination (the conductivity, pH, specific gravity, water content, etc.) of the cleaning agents.
• After the cleaning, do not leave the capacitors (assembly boards) in an environment of cleaning agent-rich or in a closed container. Sufficiently evaporate the residual cleaning agent from the assembly boards and the capacitors by forced hot air at temperatures less than the upper limit of category temperature range for more than 10 minutes.

In general, aluminum electrolytic capacitors are sensitive to contamination of halogen ions (particularly to chlorine ions). Depending on the properties of the electrolyte and rubber seal materials used in a capacitor, the halogen ions lead up to catastrophic failures on the capacitor. Where the inside of a capacitor has been contaminated with more than a certain amount of halogen ions and the capacitor is in use, the corrosion reaction of aluminum occurs. The corrosion causes the capacitor to have a significant increase in leakage current with heat produced, open the pressure relief vent and become open circuit mode failure.

Due to global environmental issues (greenhouse effects and other environmental destruction by depletion of the ozone layer), the conventional cleaning solvents of CFC 113, Trichloroethylene and 1,1,1-trichloroethylene were replaced by substitutes.

The following are some substitute cleaning agents and allowable cleaning conditions:

- a) Fatty-alcohol cleaning agents
Pine Alpha ST-100S (Arakawa Chemical)
Clean Through 750H, 750HS and 750J (Kao)

[Compatible capacitor products]

Terminal Shape	Subject Series
Surface Mount Type	All Series
Radial Lead Type	All Series
Snap-in Type	All Series (Less and equal 100Vdc)

[Cleaning conditions]

Either of immersion or ultrasonic cleaning, for a maximum of 10 minutes and at a maximum liquid temperature of 60°C is acceptable. Make sure that the markings on the capacitor are not rubbed against any other component or the PC board during cleaning. Note that shower cleaning affects the markings on the capacitor.

- b) HCFC (Freon 225) as Alternative CFCs
AK225AES (Asahi Glass)

[Cleaning conditions]

Solvent resistant type capacitors, which were originally developed to intend to resist Freon TE or Freon TES, are also capable of withstanding any one of immersion, ultrasonic or vapor cleaning, for a maximum of 5 minutes (or 2 minutes for

KRE series capacitors or 3 minutes for SRM series).

However, this type of cleaning agent is not recommended to use, as the cleaning materials may be banned in near future in view of global environmental issues.

- c) IPA (Isopropyl Alcohol)
Immersion cleaning with a maximum flux concentration of 2 wt% is acceptable.

5) Adhesives and coating materials

- ① Do not use any adhesive or coating materials containing halogenated solvents.
② Make sure of the following conditions before applying adhesive or coating materials to a capacitor,
• No flux residue nor stain is left between the rubber seal of a capacitor and PC board.
• Dry the capacitor to remove residual cleaning agents before applying adhesive and coating materials. Do not cover up the entire surface of the rubber seal of the capacitor with adhesives or coating materials.
• Heating and curing conditions for adhesives and coating materials should be followed as prescribed in the catalogs or product specifications.
• Covering up the entire surface of the rubber seal with resin mold materials will obstruct the normal diffusion of internal hydrogen gas from a capacitor and result in serious failures. Also, where the adhesive and coating materials contain a large amount of halogen ions, the halogen ions will contaminate the inside of the capacitor through the rubber seal materials, causing the capacitor to become a failure.
• Depending on solvent materials that the adhesive or coating materials contains, note that the outer sleeve of a capacitor may lose a gloss or whiten in appearance.

6) Fumigation

In exporting or importing electronic devices, they may be exposed to fumigation with halide such as methyl bromide. Where aluminum electrolytic capacitors are exposed to halide such as methyl bromide, the capacitors will be damaged with the corrosion reaction with halogen ions in the same way as cleaning agents. For the export and import, Nippon Chemi-Con considers using some packaging method and so forth so that fumigation is not required. For customers to export or import electronic devices, semi-assembly products or capacitor components, confirm if they will be exposed to fumigation and also consider final condition of packaging. (Note that either cardboard or vinyl package has a risk of fumigation gas penetration.)

3) Precautions during operation of devices

- 1) Never touch the terminals of a capacitor directly with bare hands.
2) Do not short-circuit between the capacitor terminals with anything conductive.
Also, do not spill any conductive liquid such as acid or alkaline solution over a capacitor.
3) Confirm environmental conditions where the device will be placed. Do not use the device in the following environmental conditions:
① Water or oil spatters, or high condensation environment.
② Direct sunlight.
③ Ozone, ultraviolet rays or radiation.
④ Toxic gases such as hydrogen sulfide, sulfuric acid, nitrous acid, chlorine and its compounds, bromine and its compounds and ammonium.
⑤ Severe vibration or mechanical shock conditions beyond the limits prescribed in the catalog or product specification.
The standard vibration condition is applicable to JIS C 5101-4.

4 Maintenance inspections

- 1) For industrial use capacitors, make periodic inspections of the capacitors. Before the inspections, turn off the power supply of the device and discharge the electricity of the capacitors. When checking it by a volt-ohm meter, confirm the polarity beforehand. Do not apply mechanical stress to the terminals of the capacitors during inspection.
- 2) Characteristics to be inspected
 - ① Significant damage in appearance: vent opening, electrolyte leakage, etc.
 - ② Electrical characteristics: Leakage current, capacitance, $\tan \delta$ and other characteristics prescribed in the catalogs or product specifications.

If finding anything abnormal, on the characteristics above, check the specifications of the capacitor and take appropriate actions such as replacement.

5 Capacitor venting

- 1) A capacitor with more than a certain case size has the pressure relief vent functioning to escape abnormal gas pressure increase.
If gas expels from a venting capacitor, disconnect the power supply of the device or unplug the power supply cord. If not disconnecting the power supply, the device circuit may be damaged due to the short circuit failure of the capacitor or short-circuited with the liquid that the gas was condensed to. It may cause secondary damages such as device burnout in the worst case scenario.
The gas that comes out of the open vent is vaporized electrolyte, not smoke.
- 2) The gas expelled from a venting capacitor is more than 100°C. Never expose your face to the capacitor. If your eyes are exposed to the gas or you inhale it, immediately flush your eyes and/or gargle with water. If the electrolyte comes in contact with the skin, wash with soap and water.

6 Storage

- 1) Do not store capacitors at high temperature or high humidity. Store the capacitors indoors at temperatures of 5 to 35°C and humidities of less than 75%RH.
In principle, aluminum electrolytic capacitors should be used within three years after production.
- 2) Keep capacitors packed in the original packaging material wherever possible.
- 3) Avoid the following storage environmental conditions:
 - ① Water spattering, high temperatures, high humidity or condensation environment.
 - ② Oil spattering or oil mist filled.
 - ③ Salt water spattering or salt filled.
 - ④ Acidic toxic gases such as hydrogen sulfide, sulfuric acid, nitrous acid, chlorine, bromine and methyl bromide filled.
 - ⑤ Alkaline toxic gases such as ammonium filled.
 - ⑥ Acid or alkaline solutions spattering.
 - ⑦ Direct sunlight, ozone, ultraviolet rays or radiation.
 - ⑧ Extreme vibration or shock loading.
- 4) JEDEC J-STD-020 is not applicable.

7 Capacitor disposal

Please consult with a local organization for the proper disposal of industrial waste. For incinerating capacitors, apply a high-temperature incineration (over 800°C). Incinerating them at temperatures lower than that may produce toxic gases such as chlorine. To prevent capacitors from explosion, punch holes in or sufficiently crush the can cases of the capacitors, then incinerate.

8 About AEC-Q200

The Automotive Electronics Council (AEC) was originally established by major American automotive related manufactures. Today, the committees are composed of representatives from the sustaining Members of manufacturing companies in automotive electrical components. It has standardized the criteria for "stress test qualification" and "reliability tests" for electronic components.

AEC-Q200 is the reliability test standard for approval of passive components in Automotive applications. It specifies the test type, parameters and quantity, etc. for each component. The criteria of the reliability tests such as for our main products, "Aluminum Electrolytic Capacitors" are described in this standard.

Pursuant to the customer's specific testing requirements, Chemi-Con submits the test results according to AEC-Q200 for Aluminum Electrolytic Capacitors used in automotive applications on request.

An electronic component manufacturer cannot simply claim that their product is "AEC-Q200 Qualified". It can be claimed "Compliant", "Capable", "Available", etc., however each component must be tested per each users "Qualification Test Plan" in order to claim AEC-Q200 status.

Please contact us for more information.

9 Response to the Substances of Concern

- 1) Nippon Chemi-Con aims for developing products that meet laws and regulations concerning substances of concern.
(Some products may contain regulated substances for exempted application)
Please contact us for more information about law-compliance status.
- 2) According to the content of REACH handbook (Guidance on requirements for substances in articles which is published on May 2008), our electronic components are "articles without any intended release". Therefore they are not applicable for "Registration" for EU REACH Regulation Article 7 (1).
Reference: Electrolytic Condenser Investigation Society
"Study of REACH Regulation in EU about Electrolytic Capacitor"
(publicized on 13 March 2008)

10 Catalogs

Specifications in the catalogs are subject to change without notice. Test data shown in the catalogs are not assured as the whole performance values, but typical values.
For more details, refer to JEITA RCR-2367D (March 2019) with the title of "Safety Application Guide for fixed aluminum electrolytic capacitors for use in electronic equipment".

RECOMMENDED SOLDERING CONDITIONS

◆ SURFACE MOUNT TYPE

Alchip™ MVE/MZT/MZS/MZL/MZR/MZJ/MZA/MVY/MZF/MZE/MZK/MLA/MLF/MLE/MLK/MVL/MVJ/MXB/MHS/MVH/MHL/MHB/MHJ/MHK

The following conditions are recommended for air convection and infrared reflow soldering on the SMD products onto a glass epoxy circuit boards by cream solder. The dimensions of the glass epoxy boards with resist are 90×50×0.8mm for D55 to KG5 case code SMD capacitors and 180×90×0.8mm for LH0 to MNO case codes SMD capacitors.

The temperatures shown are the surface temperature values on the top of the can and on the capacitor terminals.

Reflow should be performed twice or less. (Only some products: 3 times)

Please ensure that the capacitor became cold enough to the room temperature (5 to 35°C) before the second reflow and the third reflow (Only some products). Consult with us when performing reflow profile in IPC / JEDEC (J-STD-020)

● Recommended soldering heat conditions (Except for Conductive Polymer Aluminum Solid Capacitors)

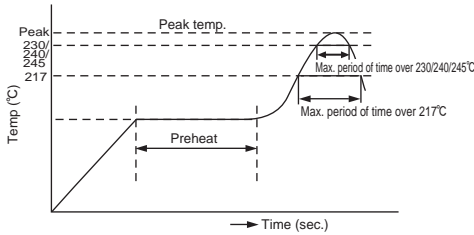

Series	Size code	Voltage range (V _{dc})	Preheat	Time maintained above 217°C	Time maintained above 230°C	Peak temp.	Reflow number
MVE, MZT, MZS MZL, MZR, MZJ, MZA, MVY, MZF, MZE, MZK, MLA, MLF, MLE, MLK, MVL, MVJ, MVH, MHL, MHB, MHJ, MHK, MXB	D55 to F90	4 to 63V (Except 63V for MVH)	150 to 180°C 120sec. max.	90sec. max	60sec. max.	260°Cmax.	2 times or less
		63V(MVH), 80V		60sec. max.	40sec. max.	250°Cmax.	2 times or less
	H63 to JA0	4 to 50V		60sec. max.	30sec. max.	245°Cmax.	2 times or less
		63 to 100V		30sec. max.	20sec. max.	240°Cmax.	2 times or less
	KE0 to MNO	6.3 to 50V		30sec. max.	20sec. max.	240°Cmax.	2 times or less
		63 to 100V		20sec. max.	—	230°Cmax.	2 times or less

Series	Size code	Voltage range (V _{dc})	Preheat	Time maintained above 217°C	Time maintained above 240°C	Time maintained above 245°C	Peak temp.	Reflow number
MHS	HA0	16 to 80V	150 to 180°C 120sec. max.	90sec. max.	—	40sec. max.	250°Cmax.	3 times or less
	JA0			70sec. max.	20sec. max.	—	245°Cmax.	2 times or less
	KE0 to MNO	16 to 100V					245°Cmax.	3 times or less

[mm]

● Recommended Solder Land on PC Board

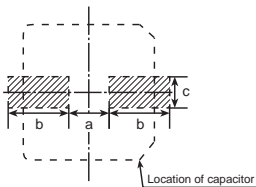

: Solder land on PC board

Size code	Terminal code : A			Terminal code : G		
	a	b	c	a	b	c
D55, D60, D61, D73	1.0	2.6	1.6			
E55, E60, E61, E73	1.4	3.0	1.6			
F55, F60, F73, F90	1.9	3.5	1.6			
F61, F80	1.9	3.5	1.6	1.9	3.5	3.3
H63	2.3	4.5	1.6			
HA0	3.1	4.2	2.2	3.1	4.2	3.5
JA0	4.5	4.4	2.2	4.5	4.4	3.5
KE0, KG5, KNO	4.0	5.7	2.5	3.4	6.3	9.3
LH0, LNO	6.0	6.9	2.5	4.7	7.8	9.6
MHO, MNO	6.0	7.9	2.5	4.7	8.8	9.6

◆ RADIAL LEAD AND SNAP-IN TYPE

● Recommended soldering heat conditions

Preheat : 150°C 120 seconds max. (Radial lead type)

Flow : 260±5°C max. 10±1 seconds max.

(Or 380±10°C max. 3±0.5 seconds max.: hand soldering)

◆ PRECAUTIONS FOR USERS

Soldering method

The capacitors of Alchip-series have no capability to withstand such dip or wave soldering as totally immerses components into a solder bath.

Reflow soldering

Reflow the capacitors within recommended reflow soldering conditions. Verify there is no temperature stress to the capacitors because the following differences might degrade capacitors electrically and mechanically. Please consult us if other reflow conditions are employed.

1. Location of components : Temperature increases at the edge of PC board more than the center.
2. Population of PC board : The lower the component population is, the more temperature rises.
3. Material of PC board : A ceramic made board needs more heat than a glass epoxy made board. The heat increase may cause damage to the capacitors.
4. Thickness of PC board : A thicker board needs more heat than a thinner board. The heat increase may damage the capacitors.
5. Size of PC board : A larger board needs more heat than a smaller board. The heat increase may damage the capacitors.
6. Solder thickness
If very thin cream solder paste is to be used for SMD types, please consult with us.
7. Location of infrared ray lamps : IR reflow as well as hot plate reflow heats only on the reverse side of the PC board to lessen heat stress to the capacitors.
8. Please consult us about vapor phase soldering (VPS).

Rework of soldering

Use a soldering iron for rework. Do not exceed an iron tip temperature of 380±10°C and an exposure time of 3±0.5 seconds.

Mechanical stress

Do not use the capacitors for lifting the PC board and give stress to the capacitor. Avoid bending the PC board. This may damage the capacitors.

Cleaning assembly board

Immediately after solvent cleaning, remove residual solvent with an air knife for at least 10 minutes. If the solvent is insufficiently dry, the capacitors may corrode.

Coating on assembly board

1. Before curing coating material, remove the cleaning solvents from the assembly board.
2. Before conformal coating, a chloride free pre-coat material is recommended to decrease the stress on the capacitors.

Molding with resin

Internal chemical reaction gradually produces gas in the capacitor; then, increasing internal pressure. If the end seal of the capacitor is completely covered by resin the gas will be unable to escape causing a potentially dangerous situation. The chlorine contained resin will penetrate into the end seal, reach the inside element, and cause damage of the capacitor.

Others

Refer to PRECAUTIONS AND GUIDELINES.

CHEMI-CON PART NUMBERING SYSTEM

Product code guide (Surface mount type)

(Example : MVE series, 25V-47 μ F, ϕ 6.3 \times 5.2L)

Please refer to the following table

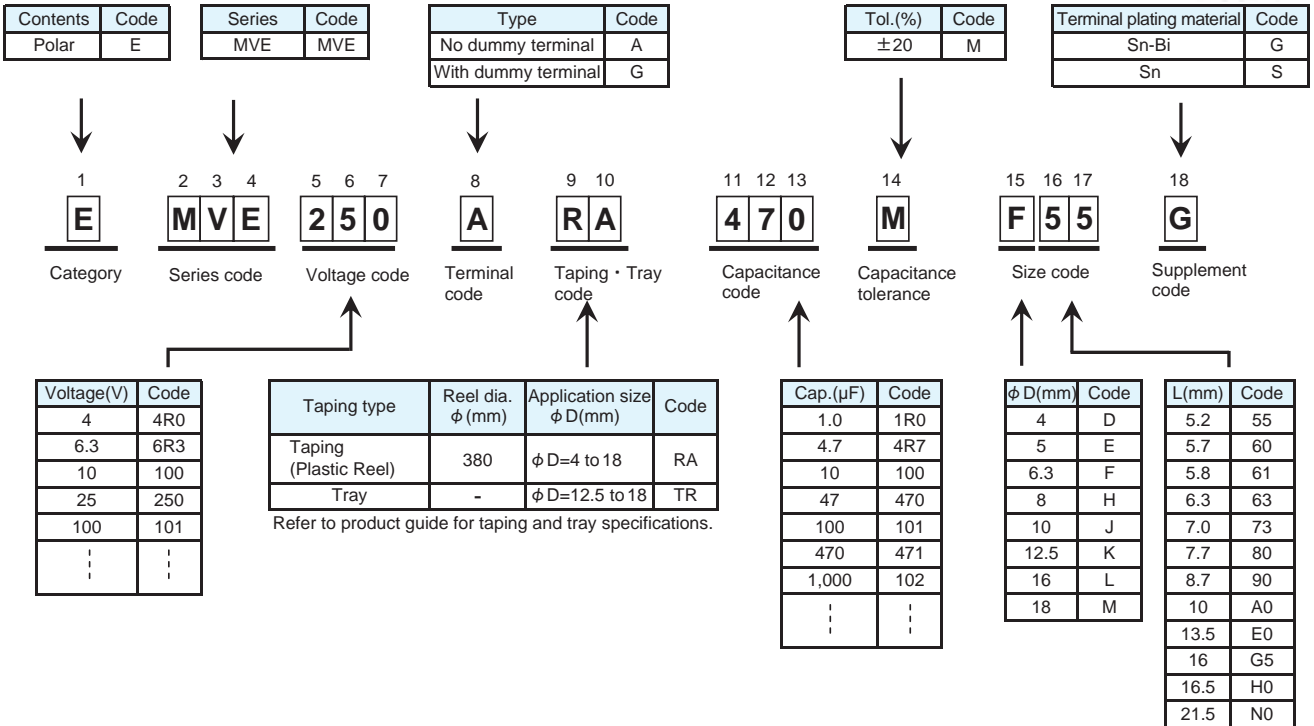

*Refer to the appendix (Part number) for codes not listed here.

Alchip™-MVE Series

- Endurance : 1,000 to 2,000 hours at 105°C
- Case size range : φ 4x5.2L to φ 18x21.5L
- Solvent resistant type except 100V_{dc} (see PRECAUTIONS AND GUIDELINES)
- RoHS2 Compliant
- AEC-Q200 compliant : Please contact Chemi-Con for more details, test data, information.

MVE → Longer life → MVL
MVJ



◆ SPECIFICATIONS

Items	Characteristics		
Category Temperature Range	-40 to +105°C		
Rated Voltage Range	6.3 to 100V _{dc}		
Capacitance Tolerance	±20%(M) (at 20°C, 120Hz)		
Leakage Current	D55 to JA0	I=0.01CV or 3μA, whichever is greater (2 minutes)	
	KE0 to MN0	I=0.03CV or 4μA, whichever is greater (1 minute)	
	Where, I : Max. leakage current (μA), C : Nominal capacitance (μF), V : Rated voltage (V) (at 20°C)		
Dissipation Factor (tan δ)	See STANDARD RATINGS (at 20°C, 120Hz)		
Low Temperature Characteristics (Max. Impedance Ratio)	Rated voltage (V _{dc})	6.3V 10V 16V 25V 35V 50V 63V 100V	
	D55 to JA0	Z(-25°C)/Z(+20°C)	4 3 2 2 2 2 2 3
		Z(-40°C)/Z(+20°C)	12 8 6 4 3 3 3 4
	KE0 to MN0	Z(-25°C)/Z(+20°C)	5 4 3 2 2 2 2 2
Z(-40°C)/Z(+20°C)		10 8 6 4 3 3 3 3	
(at 120Hz)			
Endurance	The following specifications shall be satisfied when the capacitors are restored to 20°C after the rated voltage is applied for the specified period of time at 105°C.		
	Size code	D55 to F80 HA0 to MN0	
	Time	1,000 hours 2,000 hours	
	Capacitance change	≤ ±30% of the initial value ≤ ±20% of the initial value	
	D.F. (tan δ)	≤ 300% of the initial specified value ≤ 200% of the initial specified value	
	Leakage current	≤ The initial specified value ≤ The initial specified value	
Shelf Life	The following specifications shall be satisfied when the capacitors are restored to 20°C after exposing them for 1,000 hours (500 hours for B55 to F80 size) at 105°C without voltage applied. Before the measurement, the capacitor shall be preconditioned by applying voltage according to Item 4.1 of JIS C 5101-4.		
	Size code	D55 to F80 HA0 to MN0	
	Capacitance change	≤ ±25% of the initial value ≤ ±20% of the initial value	
	D.F. (tan δ)	≤ 200% of the initial specified value ≤ 200% of the initial specified value	
	Leakage current	≤ The initial specified value ≤ The initial specified value	

◆ DIMENSIONS [mm]

- Terminal Code : A
- Size code : D55 to MN0

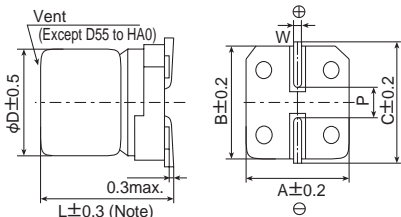

Note : L±0.5 for HA0 to MN0

- Terminal Code : G (Vibration resistant structure)
- Size code : F80 to MN0

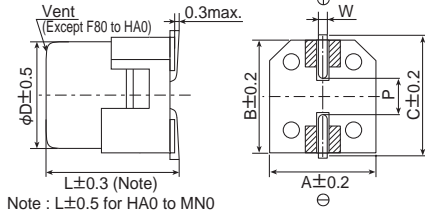

Note : L±0.5 for HA0 to MN0

▨ : Dummy terminals

Size code	D	L	A	B	C	W	P
D55	4	5.2	4.3	4.3	5.1	0.5 to 0.8	1.0
E55	5	5.2	5.3	5.3	5.9	0.5 to 0.8	1.4
F55	6.3	5.2	6.6	6.6	7.2	0.5 to 0.8	1.9
F80	6.3	7.7	6.6	6.6	7.2	0.5 to 0.8	1.9
HA0	8	10.0	8.3	8.3	9.0	0.7 to 1.1	3.1
JA0	10	10.0	10.3	10.3	11.0	0.7 to 1.1	4.5
KE0	12.5	13.5	13.0	13.0	13.7	1.0 to 1.3	4.2
KG5	12.5	16.0	13.0	13.0	13.7	1.0 to 1.3	4.2
LH0	16	16.5	17.0	17.0	18.0	1.0 to 1.3	6.5
LN0	16	21.5	17.0	17.0	18.0	1.0 to 1.3	6.5
MH0	18	16.5	19.0	19.0	20.0	1.0 to 1.3	6.5
MN0	18	21.5	19.0	19.0	20.0	1.0 to 1.3	6.5

◆ MARKING



◆ PART NUMBERING SYSTEM

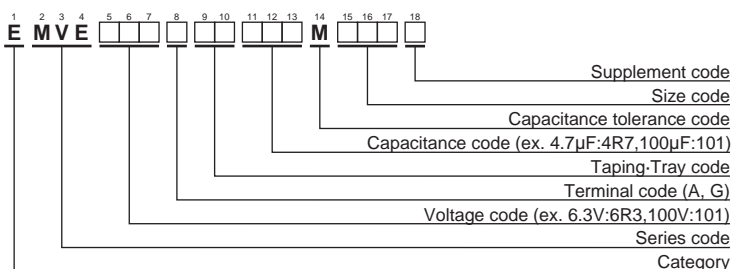

◆ RATED RIPPLE CURRENT MULTIPLIERS

- Frequency Multipliers

Size code	Capacitance(μF)	Frequency(Hz)			
		120	1k	10k	100k
D55 to JA0	1.0	1.00	1.50	1.75	1.80
	2.2 to 10	1.00	1.30	1.40	1.50
	22 to 1,500	1.00	1.05	1.08	1.08
KE0 to MN0	47, 68	1.00	1.50	1.75	1.80
	100 to 1,000	1.00	1.30	1.40	1.50
	2,200 to 6,800	1.00	1.05	1.08	1.08

The deterioration of aluminum electrolytic capacitors accelerates their life due to the internal heating produced by ripple current. For details, refer to Section "5-3 Ripple Current Effect on Lifetime" in the catalog, Technical Note.

Please refer to "Product code guide (surface mount type)"



Alchip™-MVE Series

◆ STANDARD RATINGS

WV (V _{dc})	Cap (μF)	Size code	tan δ	Rated ripple current (mA _{rms} /105°C, 120Hz)	Part No.	WV (V _{dc})	Cap (μF)	Size code	tan δ	Rated ripple current (mA _{rms} /105°C, 120Hz)	Part No.
6.3	22	D55	0.30	22	EMVE6R3ARA220MD55G	35	4.7	D55	0.14	16	EMVE350ARA4R7MD55G
	33	E55	0.30	34	EMVE6R3ARA330ME55G		10	E55	0.14	27	EMVE350ARA100ME55G
	47	E55	0.30	38	EMVE6R3ARA470ME55G		22	F55	0.14	44	EMVE350ARA220MF55G
	100	F55	0.30	69	EMVE6R3ARA101MF55G		47	F80	0.16	80	EMVE350□RA470MF80G
	220	F80	0.45	120	EMVE6R3□RA221MF80G		100	F80	0.16	100	EMVE350□RA101MF80G
	330	HA0	0.40	290	EMVE6R3□RA331MHA0G		150	HA0	0.16	260	EMVE350□RA151MHA0G
	470	HA0	0.45	320	EMVE6R3□RA471MHA0G		220	JA0	0.16	375	EMVE350□RA221MJA0G
	680	HA0	0.45	340	EMVE6R3□RA681MHA0G		330	JA0	0.16	450	EMVE350□RA331MJA0G
	1,000	JA0	0.40	410	EMVE6R3□RA102MJA0G		470	KE0	0.22	520	EMVE350□RA471MKE0S
	1,500	JA0	0.45	550	EMVE6R3□RA152MJA0G		470	LH0	0.22	650	EMVE350□RA471MLH0S
	2,200	KE0	0.40	680	EMVE6R3□RA222MKE0S		1,000	LH0	0.22	750	EMVE350□RA102MLH0S
	2,200	LH0	0.40	840	EMVE6R3□RA222MLH0S		1,000	MH0	0.22	1,000	EMVE350□RA102MMH0S
	3,300	KG5	0.42	850	EMVE6R3□RA332MKG5S		2,200	MN0	0.24	1,450	EMVE350□RA222MMN0S
	3,300	MH0	0.42	1,000	EMVE6R3□RA332MMH0S						
4,700	LN0	0.44	1,200	EMVE6R3□RA472MLN0S	1.0	D55	0.12	8.0	EMVE500ARA1R0MD55G		
4,700	MH0	0.44	1,200	EMVE6R3□RA472MMH0S	2.2	D55	0.12	12	EMVE500ARA2R2MD55G		
6,800	LN0	0.48	1,200	EMVE6R3□RA682MLN0S	3.3	D55	0.12	15	EMVE500ARA3R3MD55G		
6,800	MN0	0.48	1,350	EMVE6R3□RA682MMN0S	4.7	E55	0.12	20	EMVE500ARA4R7ME55G		
10	22	E55	0.24	30	EMVE100ARA220ME55G	10	F55	0.12	32	EMVE500ARA100MF55G	
	33	E55	0.24	34	EMVE100ARA330ME55G	33	F80	0.14	65	EMVE500□RA330MF80G	
	47	F55	0.24	48	EMVE100ARA470MF55G	47	F80	0.14	80	EMVE500□RA470MF80G	
	100	F55	0.30	69	EMVE100ARA101MF55G	100	HA0	0.14	230	EMVE500□RA101MHA0G	
	150	F80	0.35	100	EMVE100□RA151MF80G	220	JA0	0.14	375	EMVE500□RA221MJA0G	
	220	F80	0.35	120	EMVE100□RA221MF80G	330	KE0	0.18	500	EMVE500□RA331MKE0S	
	330	HA0	0.35	290	EMVE100□RA331MHA0G	330	LH0	0.18	600	EMVE500□RA331MLH0S	
	470	HA0	0.35	320	EMVE100□RA471MHA0G	470	LH0	0.18	700	EMVE500□RA471MLH0S	
	1,000	JA0	0.35	410	EMVE100□RA102MJA0G	470	MH0	0.18	750	EMVE500□RA471MMH0S	
	2,200	KG5	0.36	750	EMVE100□RA222MKG5S	1,000	MN0	0.18	1,200	EMVE500□RA102MMN0S	
	2,200	LH0	0.36	850	EMVE100□RA222MLH0S						
	3,300	LH0	0.38	1,000	EMVE100□RA332MLH0S	1.0	D55	0.12	8.0	EMVE630ARA1R0MD55G	
	3,300	MH0	0.38	1,100	EMVE100□RA332MMH0S	2.2	D55	0.12	12	EMVE630ARA2R2MD55G	
	4,700	LN0	0.40	1,300	EMVE100□RA472MLN0S	3.3	E55	0.12	17	EMVE630ARA3R3ME55G	
4,700	MN0	0.40	1,350	EMVE100□RA472MMN0S	4.7	F55	0.12	22	EMVE630ARA4R7MF55G		
16	10	D55	0.20	17	EMVE160ARA100MD55G	10	F55	0.12	32	EMVE630ARA100MF55G	
	22	E55	0.20	30	EMVE160ARA220ME55G	22	F80	0.12	58	EMVE630□RA220MF80G	
	33	F55	0.20	45	EMVE160ARA330MF55G	33	HA0	0.12	140	EMVE630□RA330MHA0G	
	47	F55	0.20	48	EMVE160ARA470MF55G	47	HA0	0.12	170	EMVE630□RA470MHA0G	
	100	F55	0.26	69	EMVE160ARA101MF55G	100	JA0	0.12	310	EMVE630□RA101MJA0G	
	150	F80	0.28	100	EMVE160□RA151MF80G	220	KE0	0.14	470	EMVE630□RA221MKE0S	
	220	F80	0.28	120	EMVE160□RA221MF80G	220	LH0	0.14	560	EMVE630□RA221MLH0S	
	330	HA0	0.28	290	EMVE160□RA331MHA0G	330	LH0	0.14	700	EMVE630□RA331MLH0S	
	470	HA0	0.28	320	EMVE160□RA471MHA0G	330	MH0	0.14	750	EMVE630□RA331MMH0S	
	680	JA0	0.28	470	EMVE160□RA681MJA0G	470	LN0	0.14	900	EMVE630□RA471MLN0S	
	1,000	KE0	0.30	550	EMVE160□RA102MKE0S	470	MH0	0.14	900	EMVE630□RA471MMH0S	
	1,000	LH0	0.30	650	EMVE160□RA102MLH0S						
	2,200	LH0	0.32	950	EMVE160□RA222MLH0S	22	HA0	0.12	100	EMVE101□RA220MHA0G	
	2,200	MH0	0.32	1,000	EMVE160□RA222MMH0S	33	JA0	0.12	150	EMVE101□RA330MJA0G	
3,300	LN0	0.34	1,200	EMVE160□RA332MLN0S	47	KE0	0.10	250	EMVE101□RA470MKE0S		
3,300	MH0	0.34	1,200	EMVE160□RA332MMH0S	68	KE0	0.10	300	EMVE101□RA680MKE0S		
25	10	E55	0.16	27	EMVE250ARA100ME55G	100	KE0	0.10	380	EMVE101□RA101MKE0S	
	22	F55	0.16	44	EMVE250ARA220MF55G	100	LH0	0.10	450	EMVE101□RA101MLH0S	
	33	F55	0.16	50	EMVE250ARA330MF55G	220	LN0	0.10	750	EMVE101□RA221MLN0S	
	47	F55	0.16	60	EMVE250ARA470MF55G	220	MH0	0.10	750	EMVE101□RA221MMH0S	
	100	F80	0.18	100	EMVE250□RA101MF80G	330	MN0	0.10	980	EMVE101□RA331MMN0S	
	150	HA0	0.18	240	EMVE250□RA151MHA0G						
	220	HA0	0.18	320	EMVE250□RA221MHA0G						
	330	JA0	0.16	450	EMVE250□RA331MJA0G						
	470	JA0	0.18	490	EMVE250□RA471MJA0G						
	1,000	LH0	0.26	820	EMVE250□RA102MLH0S						
	1,000	MH0	0.26	880	EMVE250□RA102MMH0S						
	2,200	LN0	0.28	1,250	EMVE250□RA222MLN0S						
	2,200	MN0	0.28	1,300	EMVE250□RA222MMN0S						

□ : Enter the appropriate terminal code.
 Production of the products shown in [] is scheduled to be discontinued.
 *1: Assembly boards with the designated products attached cannot be cleaned.

Alchip™-MZT Series *Upgrade!*

- Downsizing and Lower ESR, 2,000hours at 105°C
- Rated voltage range : 16 to 35V, Nominal capacitance range : 220 to 1,500μF
- Solvent resistant type(see PRECAUTIONS AND GUIDELINES)
- Vibration resistance structure
- RoHS2 Compliant
- AEC-Q200 compliant : Please contact Chemi-Con for more details, test data, information.

MZT

↑ Higher capacitance
MZZ



◆ SPECIFICATIONS

Items	Characteristics	
Category		
Temperature Range	-55 to +105°C	
Rated Voltage Range	16 to 35V _{dc}	
Capacitance Tolerance	±20% (M) (at 20°C, 120Hz)	
Leakage Current	I=0.01CV or 3μA, whichever is greater. Where, I : Max. leakage current (μA), C : Nominal capacitance (μF), V : Rated voltage (V) (at 20°C after 2 minutes)	
Dissipation Factor (tan δ)	Rated voltage (V _{dc})	
	tan δ (Max.)	
Low Temperature Characteristics (Max. Impedance Ratio)	Rated voltage (V _{dc})	
	Z(-25°C)/Z(+20°C)	
	Z(-40°C)/Z(+20°C)	
	Z(-55°C)/Z(+20°C)	
Endurance	The following specifications shall be satisfied when the capacitors are restored to 20°C after the rated voltage is applied for 2,000 hours at 105°C.	
Shelf Life	The following specifications shall be satisfied when the capacitors are restored to 20°C after exposing them for 1,000 hours at 105°C without voltage applied. Before the measurement, the capacitor shall be preconditioned by applying voltage according to Item 4.1 of JIS C 5101-4.	
	Capacitance change	
	D.F. (tan δ)	
	Leakage current	
Surge Voltage Test	The capacitors shall be subjected to 1,000 cycles each consisting of charging with the specified surge voltage for 30±5 seconds through a protective resistor (as required for RC=0.1±0.05sec) and open-circuiting for 5.5 minutes at a room temperature of 15 to 35°C.	
	Rated voltage (V _{dc})	
	Surge voltage (V _{dc})	
	Appearance	
	Capacitance change	
	D.F. (tan δ)	
	Leakage current	
	(Caution)	
	Surge Voltage Test intends to evaluate capacitors in durability of an exceptional excessive voltage under specific conditions. It does not imply long-term use at all.	

◆ DIMENSIONS [mm]

- Terminal Code : A
- Size code : F80 to JA0
- Terminal Code : G(Vibration resistant structure)
- Size code : F80 to JA0

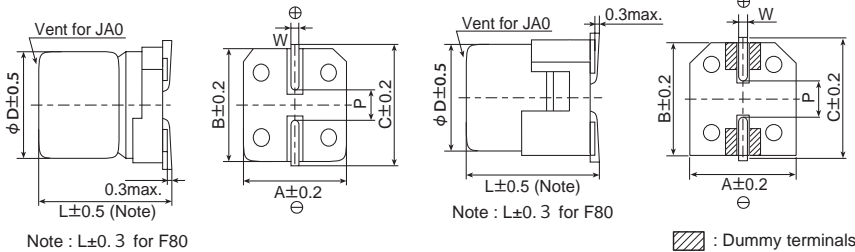

Size code	D	L	A	B	C	W	P
F80	6.3	7.7	6.6	6.6	7.2	0.5 to 0.8	1.9
HA0	8	10.0	8.3	8.3	9.0	0.7 to 1.1	3.1
JA0	10	10.0	10.3	10.3	11.0	0.7 to 1.1	4.5

◆ MARKING

EX) 25V1,200μF



- Rated voltage symbol

Rated voltage (V _{dc})	16	25	35
Symbol	C	E	V

Applying voltage over the rated voltages causes the capacitors to have short lifetime. Besides, applying voltage over the specified surge voltages may cause to have short circuit failure. A protection circuit should be used if applied voltage will exceed the rated voltages.

Alchip™ - **MZT** Upgrade! Series

◆PART NUMBERING SYSTEM

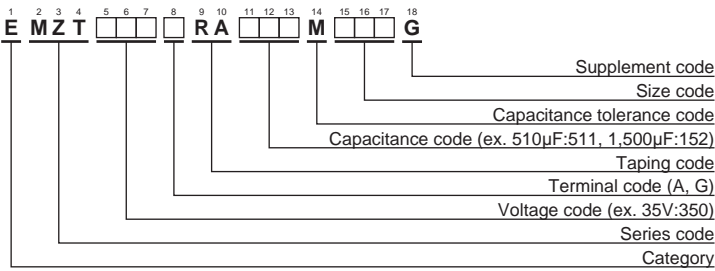

Please refer to "Product code guide (surface mount type)"

◆STANDARD RATINGS

WV (V _{dc})	Cap (μF)	Size code	tan δ	ESR (Ω max./20°C, 100kHz)	Rated ripple current (mA _{rms} /105°C, 100kHz)	Part No.
16	470	F80	0.16	0.16	600	EMZT160□RA471MF80G
	820	HA0	0.16	0.08	850	EMZT160□RA821MHA0G
	1,500	JA0	0.16	0.06	1,190	EMZT160□RA152MJA0G
25	330	F80	0.14	0.16	600	EMZT250□RA331MF80G
	680	HA0	0.14	0.08	850	EMZT250□RA681MHA0G
	1,200	JA0	0.14	0.06	1,190	EMZT250□RA122MJA0G
35	220	F80	0.12	0.16	600	EMZT350□RA221MF80G
	510	HA0	0.12	0.08	850	EMZT350□RA511MHA0G
	820	JA0	0.12	0.06	1,190	EMZT350□RA821MJA0G

□ : Enter the appropriate terminal code.
 New products are indicated in red text.

◆RATED RIPPLE CURRENT MULTIPLIERS

● Frequency Multipliers

Capacitance(μF)	Frequency(Hz)			
	120	1k	10k	100k
220 to 510	0.50	0.85	0.94	1.00
680 to 1,500	0.60	0.87	0.95	1.00

The deterioration of aluminum electrolytic capacitors accelerates their life due to the internal heating produced by ripple current. For details, refer to Section "5-3 Ripple Current Effect on Lifetime" in the catalog, Technical Note.

Alchip™-MZS Series

- Downsizing and Lower ESR, 2,000hours at 105°C
- Rated voltage range : 25, 35V, Nominal capacitance range : 330 to 1,000μF
- Solvent resistant type(see PRECAUTIONS AND GUIDELINES)
- Vibration resistance structure
- RoHS2 Compliant
- AEC-Q200 compliant : Please contact Chemi-Con for more details, test data, information.

MZS

↑ Higher capacitance
MZR



◆ SPECIFICATIONS

Items	Characteristics														
Category Temperature Range	-55 to +105°C														
Rated Voltage Range	25, 35V _{dc}														
Capacitance Tolerance	±20% (M) (at 20°C, 120Hz)														
Leakage Current	I=0.01CV or 3μA, whichever is greater. Where, I : Max. leakage current (μA), C : Nominal capacitance (μF), V : Rated voltage (V) (at 20°C after 2 minutes)														
Dissipation Factor (tan δ)	<table border="1"> <tr> <td>Rated voltage (V_{dc})</td> <td>25V</td> <td>35V</td> </tr> <tr> <td>tan δ (Max.)</td> <td>0.14</td> <td>0.12</td> </tr> </table> (at 20°C, 120Hz)	Rated voltage (V _{dc})	25V	35V	tan δ (Max.)	0.14	0.12								
Rated voltage (V _{dc})	25V	35V													
tan δ (Max.)	0.14	0.12													
Low Temperature Characteristics (Max. Impedance Ratio)	<table border="1"> <tr> <td>Rated voltage (V_{dc})</td> <td>25V</td> <td>35V</td> </tr> <tr> <td>Z(-25°C)/Z(+20°C)</td> <td>2</td> <td>2</td> </tr> <tr> <td>Z(-40°C)/Z(+20°C)</td> <td>3</td> <td>3</td> </tr> <tr> <td>Z(-55°C)/Z(+20°C)</td> <td>3</td> <td>3</td> </tr> </table> (at 120Hz)	Rated voltage (V _{dc})	25V	35V	Z(-25°C)/Z(+20°C)	2	2	Z(-40°C)/Z(+20°C)	3	3	Z(-55°C)/Z(+20°C)	3	3		
Rated voltage (V _{dc})	25V	35V													
Z(-25°C)/Z(+20°C)	2	2													
Z(-40°C)/Z(+20°C)	3	3													
Z(-55°C)/Z(+20°C)	3	3													
Endurance	The following specifications shall be satisfied when the capacitors are restored to 20°C after the rated voltage is applied for 2,000 hours at 105°C. <table border="1"> <tr> <td>Capacitance change</td> <td>≤ ±30% of the initial value</td> </tr> <tr> <td>D.F. (tan δ)</td> <td>≤200% of the initial specified value</td> </tr> <tr> <td>Leakage current</td> <td>≤The initial specified value</td> </tr> </table>	Capacitance change	≤ ±30% of the initial value	D.F. (tan δ)	≤200% of the initial specified value	Leakage current	≤The initial specified value								
Capacitance change	≤ ±30% of the initial value														
D.F. (tan δ)	≤200% of the initial specified value														
Leakage current	≤The initial specified value														
Shelf Life	The following specifications shall be satisfied when the capacitors are restored to 20°C after exposing them for 1,000 hours at 105°C without voltage applied. Before the measurement, the capacitor shall be preconditioned by applying voltage according to Item 4.1 of JIS C 5101-4. <table border="1"> <tr> <td>Capacitance change</td> <td>≤ ±30% of the initial value</td> </tr> <tr> <td>D.F. (tan δ)</td> <td>≤200% of the initial specified value</td> </tr> <tr> <td>Leakage current</td> <td>≤The initial specified value</td> </tr> </table>	Capacitance change	≤ ±30% of the initial value	D.F. (tan δ)	≤200% of the initial specified value	Leakage current	≤The initial specified value								
Capacitance change	≤ ±30% of the initial value														
D.F. (tan δ)	≤200% of the initial specified value														
Leakage current	≤The initial specified value														
Surge Voltage Test	The capacitors shall be subjected to 1,000 cycles each consisting of charging with the specified surge voltage for 30±5 seconds through a protective resistor (as required for RC=0.1±0.05sec) and open-circuiting for 5.5 minutes at a room temperature of 15 to 35°C. <table border="1"> <tr> <td>Rated voltage (V_{dc})</td> <td>25</td> <td>35</td> </tr> <tr> <td>Surge voltage (V_{dc})</td> <td>29</td> <td>40</td> </tr> </table> <table border="1"> <tr> <td>Appearance</td> <td>No significant damage</td> </tr> <tr> <td>Capacitance change</td> <td>≤ ±20% of the initial value</td> </tr> <tr> <td>D.F. (tan δ)</td> <td>≤200% of the initial specified value</td> </tr> <tr> <td>Leakage current</td> <td>≤The initial specified value</td> </tr> </table> (Caution) Surge Voltage Test intends to evaluate capacitors in durability of an exceptional excessive voltage under specific conditions. It does not imply long-term use at all.	Rated voltage (V _{dc})	25	35	Surge voltage (V _{dc})	29	40	Appearance	No significant damage	Capacitance change	≤ ±20% of the initial value	D.F. (tan δ)	≤200% of the initial specified value	Leakage current	≤The initial specified value
Rated voltage (V _{dc})	25	35													
Surge voltage (V _{dc})	29	40													
Appearance	No significant damage														
Capacitance change	≤ ±20% of the initial value														
D.F. (tan δ)	≤200% of the initial specified value														
Leakage current	≤The initial specified value														

◆ DIMENSIONS [mm]

- Terminal Code : A
- Size code : HA0 and JA0

- Terminal Code : G(Vibration resistant structure)
- Size code : HA0 and JA0

Size code	D	L	A	B	C	W	P
HA0	8	10.0	8.3	8.3	9.0	0.7 to 1.1	3.1
JA0	10	10.0	10.3	10.3	11.0	0.7 to 1.1	4.5

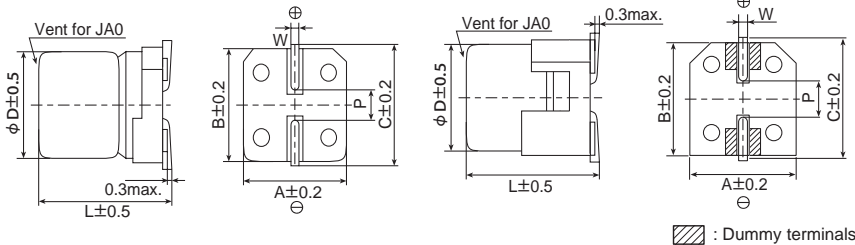

◆ MARKING

EX) 25V1,000μF



- Rated voltage symbol

Rated voltage (V _{dc})	25	35
Symbol	E	V

Applying voltage over the rated voltages causes the capacitors to have short lifetime. Besides, applying voltage over the specified surge voltages may cause to have short circuit failure. A protection circuit should be used if applied voltage will exceed the rated voltages.

Alchip™-MZS Series

◆PART NUMBERING SYSTEM

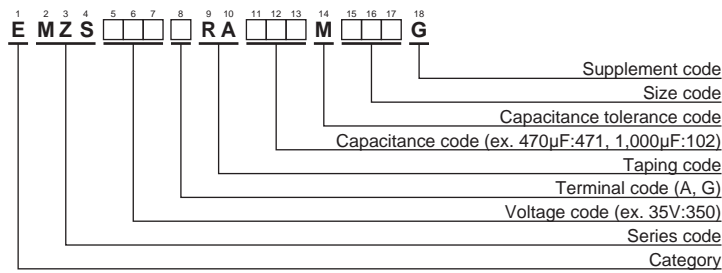

Please refer to "Product code guide (surface mount type)"

◆STANDARD RATINGS

WV (V _{dc})	Cap (µF)	Size code	tan δ	ESR (Ω max./20°C, 100kHz)	Rated ripple current (mArms/105°C, 100kHz)	Part No.
25	470	HA0	0.14	0.08	850	EMZS250□RA471MHA0G
	560	HA0	0.14	0.08	850	EMZS250□RA561MHA0G
	820	JA0	0.14	0.06	1,190	EMZS250□RA821MJA0G
	1,000	JA0	0.14	0.06	1,190	EMZS250□RA102MJA0G
35	330	HA0	0.12	0.08	850	EMZS350□RA331MHA0G
	410	HA0	0.12	0.08	850	EMZS350□RA411MHA0G
	470	HA0	0.12	0.08	850	EMZS350□RA471MHA0G
	560	JA0	0.12	0.06	1,190	EMZS350□RA561MJA0G
	680	JA0	0.12	0.06	1,190	EMZS350□RA681MJA0G

□ : Enter the appropriate terminal code.

◆RATED RIPPLE CURRENT MULTIPLIERS

●Frequency Multipliers

Capacitance(µF) \ Frequency(Hz)	120	1k	10k	100k
330 to 560	0.50	0.85	0.94	1.00
680 to 1,000	0.60	0.87	0.95	1.00

The deterioration of aluminum electrolytic capacitors accelerates their life due to the internal heating produced by ripple current. For details, refer to Section "5-3 Ripple Current Effect on Lifetime" in the catalog, Technical Note.

Alchip™-MZL Series

- Low ESR, 5,000hours at 105°C
- Rated voltage range : 6.3 to 50V, Nominal capacitance range : 100 to 1,500μF
- Solvent resistant type(see PRECAUTIONS AND GUIDELINES)
- Vibration resistance structure
- RoHS2 Compliant
- AEC-Q200 compliant : Please contact Chemi-Con for more details, test data, information.

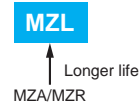

◆ SPECIFICATIONS

Items	Characteristics																												
Category	-55 to +105°C																												
Temperature Range	-55 to +105°C																												
Rated Voltage Range	6.3 to 50V _{dc}																												
Capacitance Tolerance	±20% (M) (at 20°C, 120Hz)																												
Leakage Current	I=0.01CV or 3μA, whichever is greater. Where, I : Max. leakage current (μA), C : Nominal capacitance (μF), V : Rated voltage (V) (at 20°C after 2 minutes)																												
Dissipation Factor (tan δ)	<table border="1"> <tr> <td>Rated voltage (V_{dc})</td> <td>6.3V</td> <td>10V</td> <td>16V</td> <td>25V</td> <td>35V</td> <td>50V</td> </tr> <tr> <td>tan δ (Max.)</td> <td>0.26</td> <td>0.19</td> <td>0.16</td> <td>0.14</td> <td>0.12</td> <td>0.10</td> </tr> </table> (at 20°C, 120Hz)	Rated voltage (V _{dc})	6.3V	10V	16V	25V	35V	50V	tan δ (Max.)	0.26	0.19	0.16	0.14	0.12	0.10														
Rated voltage (V _{dc})	6.3V	10V	16V	25V	35V	50V																							
tan δ (Max.)	0.26	0.19	0.16	0.14	0.12	0.10																							
Low Temperature Characteristics (Max. Impedance Ratio)	<table border="1"> <tr> <td>Rated voltage (V_{dc})</td> <td>6.3V</td> <td>10V</td> <td>16V</td> <td>25V</td> <td>35V</td> <td>50V</td> </tr> <tr> <td>Z(-25°C)/Z(+20°C)</td> <td>2</td> <td>2</td> <td>2</td> <td>2</td> <td>2</td> <td>2</td> </tr> <tr> <td>Z(-40°C)/Z(+20°C)</td> <td>3</td> <td>3</td> <td>3</td> <td>3</td> <td>3</td> <td>3</td> </tr> <tr> <td>Z(-55°C)/Z(+20°C)</td> <td>4</td> <td>4</td> <td>4</td> <td>3</td> <td>3</td> <td>3</td> </tr> </table> (at 120Hz)	Rated voltage (V _{dc})	6.3V	10V	16V	25V	35V	50V	Z(-25°C)/Z(+20°C)	2	2	2	2	2	2	Z(-40°C)/Z(+20°C)	3	3	3	3	3	3	Z(-55°C)/Z(+20°C)	4	4	4	3	3	3
Rated voltage (V _{dc})	6.3V	10V	16V	25V	35V	50V																							
Z(-25°C)/Z(+20°C)	2	2	2	2	2	2																							
Z(-40°C)/Z(+20°C)	3	3	3	3	3	3																							
Z(-55°C)/Z(+20°C)	4	4	4	3	3	3																							
Endurance	The following specifications shall be satisfied when the capacitors are restored to 20°C after the rated voltage is applied for 5,000 hours at 105°C. <table border="1"> <tr> <td>Capacitance change</td> <td>≤ ±35% of the initial value</td> </tr> <tr> <td>D.F. (tan δ)</td> <td>≤300% of the initial specified value</td> </tr> <tr> <td>Leakage current</td> <td>≤The initial specified value</td> </tr> </table>	Capacitance change	≤ ±35% of the initial value	D.F. (tan δ)	≤300% of the initial specified value	Leakage current	≤The initial specified value																						
Capacitance change	≤ ±35% of the initial value																												
D.F. (tan δ)	≤300% of the initial specified value																												
Leakage current	≤The initial specified value																												
Shelf Life	The following specifications shall be satisfied when the capacitors are restored to 20°C after exposing them for 1,000 hours at 105°C without voltage applied. Before the measurement, the capacitor shall be preconditioned by applying voltage according to Item 4.1 of JIS C 5101-4. <table border="1"> <tr> <td>Capacitance change</td> <td>≤ ±30% of the initial value</td> </tr> <tr> <td>D.F. (tan δ)</td> <td>≤200% of the initial specified value</td> </tr> <tr> <td>Leakage current</td> <td>≤The initial specified value</td> </tr> </table>	Capacitance change	≤ ±30% of the initial value	D.F. (tan δ)	≤200% of the initial specified value	Leakage current	≤The initial specified value																						
Capacitance change	≤ ±30% of the initial value																												
D.F. (tan δ)	≤200% of the initial specified value																												
Leakage current	≤The initial specified value																												
Surge Voltage Test	The capacitors shall be subjected to 1,000 cycles each consisting of charging with the specified surge voltage for 30±5 seconds through a protective resistor (as required for RC=0.1±0.05sec) and open-circuiting for 5.5 minutes at a room temperature of 15 to 35°C. <table border="1"> <tr> <td>Rated voltage (V_{dc})</td> <td>6.3</td> <td>10</td> <td>16</td> <td>25</td> <td>35</td> <td>50</td> </tr> <tr> <td>Surge voltage (V_{dc})</td> <td>7.2</td> <td>12</td> <td>18</td> <td>29</td> <td>40</td> <td>58</td> </tr> </table> <table border="1"> <tr> <td>Appearance</td> <td>No significant damage</td> </tr> <tr> <td>Capacitance change</td> <td>≤ ±20% of the initial value</td> </tr> <tr> <td>D.F. (tan δ)</td> <td>≤200% of the initial specified value</td> </tr> <tr> <td>Leakage current</td> <td>≤The initial specified value</td> </tr> </table> (Caution) Surge Voltage Test intends to evaluate capacitors in durability of an exceptional excessive voltage under specific conditions. It does not imply long-term use at all.	Rated voltage (V _{dc})	6.3	10	16	25	35	50	Surge voltage (V _{dc})	7.2	12	18	29	40	58	Appearance	No significant damage	Capacitance change	≤ ±20% of the initial value	D.F. (tan δ)	≤200% of the initial specified value	Leakage current	≤The initial specified value						
Rated voltage (V _{dc})	6.3	10	16	25	35	50																							
Surge voltage (V _{dc})	7.2	12	18	29	40	58																							
Appearance	No significant damage																												
Capacitance change	≤ ±20% of the initial value																												
D.F. (tan δ)	≤200% of the initial specified value																												
Leakage current	≤The initial specified value																												

◆ DIMENSIONS [mm]

● Terminal Code : A

● Terminal Code : G(Vibration resistant structure)

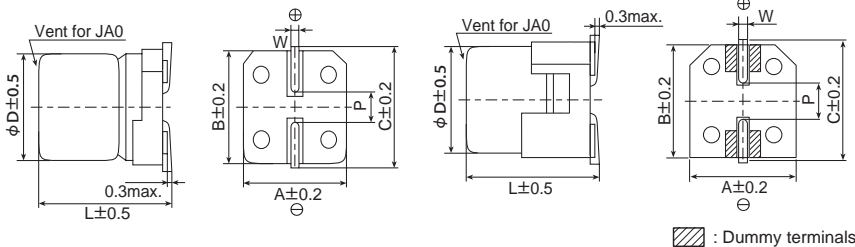

Size code	D	L	A	B	C	W	P
HA0	8	10.0	8.3	8.3	9.0	0.7 to 1.1	3.1
JA0	10	10.0	10.3	10.3	11.0	0.7 to 1.1	4.5

◆ MARKING

EX) 35V560μF



● Rated voltage symbol

Rated voltage (V _{dc})	6.3	10	16	25	35	50
Symbol	j	A	C	E	V	H

Applying voltage over the rated voltages causes the capacitors to have short lifetime. Besides, applying voltage over the specified surge voltages may cause to have short circuit failure. A protection circuit should be used if applied voltage will exceed the rated voltages.

Alchip™-MZL Series

◆PART NUMBERING SYSTEM

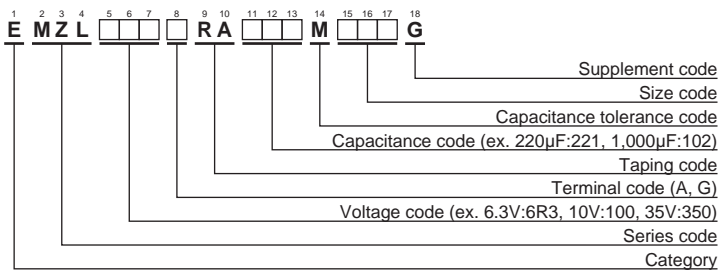

Please refer to "Product code guide (surface mount type)"

◆STANDARD RATINGS

WV (V _{dc})	Cap (µF)	Size code	tan δ	ESR (Ω max./20°C, 100kHz)	Rated ripple current (mA _{RMS} /105°C, 100kHz)	Part No.
6.3	470	HA0	0.26	0.16	600	EMZL6R3 <input type="text"/> RA471MHA0G
	1,000	HA0	0.26	0.16	600	EMZL6R3 <input type="text"/> RA102MHA0G
	1,500	JA0	0.26	0.08	850	EMZL6R3 <input type="text"/> RA152MJA0G
10	330	HA0	0.19	0.16	600	EMZL100 <input type="text"/> RA331MHA0G
	470	HA0	0.19	0.16	600	EMZL100 <input type="text"/> RA471MHA0G
	680	HA0	0.19	0.16	600	EMZL100 <input type="text"/> RA681MHA0G
	1,000	JA0	0.19	0.08	850	EMZL100 <input type="text"/> RA102MJA0G
16	330	HA0	0.16	0.16	600	EMZL160 <input type="text"/> RA331MHA0G
	470	HA0	0.16	0.16	600	EMZL160 <input type="text"/> RA471MHA0G
	680	JA0	0.16	0.08	850	EMZL160 <input type="text"/> RA681MJA0G
25	220	HA0	0.14	0.16	600	EMZL250 <input type="text"/> RA221MHA0G
	330	HA0	0.14	0.16	600	EMZL250 <input type="text"/> RA331MHA0G
	470	HA0	0.14	0.08	850	EMZL250 <input type="text"/> RA471MHA0G
	470	JA0	0.14	0.08	850	EMZL250 <input type="text"/> RA471MJA0G
	820	JA0	0.14	0.06	1,190	EMZL250 <input type="text"/> RA821MJA0G
35	100	HA0	0.12	0.16	600	EMZL350 <input type="text"/> RA101MHA0G
	220	HA0	0.12	0.16	600	EMZL350 <input type="text"/> RA221MHA0G
	330	HA0	0.12	0.08	850	EMZL350 <input type="text"/> RA331MHA0G
	330	JA0	0.12	0.08	850	EMZL350 <input type="text"/> RA331MJA0G
	560	JA0	0.12	0.06	1,190	EMZL350 <input type="text"/> RA561MJA0G
50	100	HA0	0.10	0.34	350	EMZL500 <input type="text"/> RA101MHA0G
	220	JA0	0.10	0.18	670	EMZL500 <input type="text"/> RA221MJA0G

: Enter the appropriate terminal code.

◆RATED RIPPLE CURRENT MULTIPLIERS

● Frequency Multipliers

Capacitance(µF)	Frequency(Hz)	120	1k	10k	100k
100		0.40	0.75	0.90	1.00
220 to 560		0.50	0.85	0.94	1.00
680 to 1,500		0.60	0.87	0.95	1.00

The deterioration of aluminum electrolytic capacitors accelerates their life due to the internal heating produced by ripple current. For details, refer to Section "5-3 Ripple Current Effect on Lifetime" in the catalog, Technical Note.

Alchip™-MZR Series

- Downsizing and Lower ESR, 2,000hours at 105°C
- Rated voltage range : 6.3 to 50V, Nominal capacitance range : 22 to 2,200μF
- Solvent resistant type(see PRECAUTIONS AND GUIDELINES)
- Vibration resistance structure
- RoHS2 Compliant
- AEC-Q200 compliant : Please contact Chemi-Con for more details, test data, information.

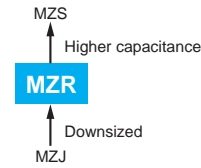

◆ SPECIFICATIONS

Items	Characteristics																												
Category	-55 to +105°C																												
Temperature Range	-55 to +105°C																												
Rated Voltage Range	6.3 to 50V _{dc}																												
Capacitance Tolerance	±20% (M) (at 20°C, 120Hz)																												
Leakage Current	I=0.01CV or 3μA, whichever is greater. Where, I : Max. leakage current (μA), C : Nominal capacitance (μF), V : Rated voltage (V) (at 20°C after 2 minutes)																												
Dissipation Factor (tan δ)	<table border="1"> <tr> <td>Rated voltage (V_{dc})</td> <td>6.3V</td> <td>10V</td> <td>16V</td> <td>25V</td> <td>35V</td> <td>50V</td> </tr> <tr> <td>tan δ (Max.)</td> <td>0.26</td> <td>0.19</td> <td>0.16</td> <td>0.14</td> <td>0.12</td> <td>0.10</td> </tr> </table> (at 20°C, 120Hz)	Rated voltage (V _{dc})	6.3V	10V	16V	25V	35V	50V	tan δ (Max.)	0.26	0.19	0.16	0.14	0.12	0.10														
Rated voltage (V _{dc})	6.3V	10V	16V	25V	35V	50V																							
tan δ (Max.)	0.26	0.19	0.16	0.14	0.12	0.10																							
Low Temperature Characteristics (Max. Impedance Ratio)	<table border="1"> <tr> <td>Rated voltage (V_{dc})</td> <td>6.3V</td> <td>10V</td> <td>16V</td> <td>25V</td> <td>35V</td> <td>50V</td> </tr> <tr> <td>Z(-25°C)/Z(+20°C)</td> <td>2</td> <td>2</td> <td>2</td> <td>2</td> <td>2</td> <td>2</td> </tr> <tr> <td>Z(-40°C)/Z(+20°C)</td> <td>3</td> <td>3</td> <td>3</td> <td>3</td> <td>3</td> <td>3</td> </tr> <tr> <td>Z(-55°C)/Z(+20°C)</td> <td>4</td> <td>4</td> <td>4</td> <td>3</td> <td>3</td> <td>3</td> </tr> </table> (at 120Hz)	Rated voltage (V _{dc})	6.3V	10V	16V	25V	35V	50V	Z(-25°C)/Z(+20°C)	2	2	2	2	2	2	Z(-40°C)/Z(+20°C)	3	3	3	3	3	3	Z(-55°C)/Z(+20°C)	4	4	4	3	3	3
Rated voltage (V _{dc})	6.3V	10V	16V	25V	35V	50V																							
Z(-25°C)/Z(+20°C)	2	2	2	2	2	2																							
Z(-40°C)/Z(+20°C)	3	3	3	3	3	3																							
Z(-55°C)/Z(+20°C)	4	4	4	3	3	3																							
Endurance	The following specifications shall be satisfied when the capacitors are restored to 20°C after the rated voltage is applied for 2,000 hours at 105°C. <table border="1"> <tr> <td>Capacitance change</td> <td>≤ ±30% of the initial value</td> </tr> <tr> <td>D.F. (tan δ)</td> <td>≤200% of the initial specified value</td> </tr> <tr> <td>Leakage current</td> <td>≤The initial specified value</td> </tr> </table>	Capacitance change	≤ ±30% of the initial value	D.F. (tan δ)	≤200% of the initial specified value	Leakage current	≤The initial specified value																						
Capacitance change	≤ ±30% of the initial value																												
D.F. (tan δ)	≤200% of the initial specified value																												
Leakage current	≤The initial specified value																												
Shelf Life	The following specifications shall be satisfied when the capacitors are restored to 20°C after exposing them for 1,000 hours at 105°C without voltage applied. Before the measurement, the capacitor shall be preconditioned by applying voltage according to Item 4.1 of JIS C 5101-4. <table border="1"> <tr> <td>Capacitance change</td> <td>≤ ±30% of the initial value</td> </tr> <tr> <td>D.F. (tan δ)</td> <td>≤200% of the initial specified value</td> </tr> <tr> <td>Leakage current</td> <td>≤The initial specified value</td> </tr> </table>	Capacitance change	≤ ±30% of the initial value	D.F. (tan δ)	≤200% of the initial specified value	Leakage current	≤The initial specified value																						
Capacitance change	≤ ±30% of the initial value																												
D.F. (tan δ)	≤200% of the initial specified value																												
Leakage current	≤The initial specified value																												
Surge Voltage Test	The capacitors shall be subjected to 1,000 cycles each consisting of charging with the specified surge voltage for 30±5 seconds through a protective resistor (as required for RC=0.1±0.05sec) and open-circuiting for 5.5 minutes at a room temperature of 15 to 35°C. <table border="1"> <tr> <td>Rated voltage (V_{dc})</td> <td>6.3</td> <td>10</td> <td>16</td> <td>25</td> <td>35</td> <td>50</td> </tr> <tr> <td>Surge voltage (V_{dc})</td> <td>7.2</td> <td>12</td> <td>18</td> <td>29</td> <td>40</td> <td>58</td> </tr> </table> <table border="1"> <tr> <td>Appearance</td> <td>No significant damage</td> </tr> <tr> <td>Capacitance change</td> <td>≤ ±20% of the initial value</td> </tr> <tr> <td>D.F. (tan δ)</td> <td>≤200% of the initial specified value</td> </tr> <tr> <td>Leakage current</td> <td>≤The initial specified value</td> </tr> </table> (Caution) Surge Voltage Test intends to evaluate capacitors in durability of an exceptional excessive voltage under specific conditions. It does not imply long-term use at all.	Rated voltage (V _{dc})	6.3	10	16	25	35	50	Surge voltage (V _{dc})	7.2	12	18	29	40	58	Appearance	No significant damage	Capacitance change	≤ ±20% of the initial value	D.F. (tan δ)	≤200% of the initial specified value	Leakage current	≤The initial specified value						
Rated voltage (V _{dc})	6.3	10	16	25	35	50																							
Surge voltage (V _{dc})	7.2	12	18	29	40	58																							
Appearance	No significant damage																												
Capacitance change	≤ ±20% of the initial value																												
D.F. (tan δ)	≤200% of the initial specified value																												
Leakage current	≤The initial specified value																												

◆ DIMENSIONS [mm]

- Terminal Code : A
- Size code : E61 to JA0

- Terminal Code : G(Vibration resistant structure)
- Size code : F61 to JA0

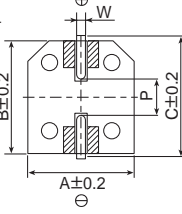
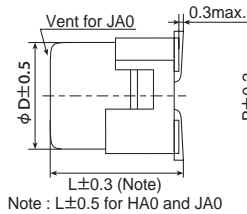
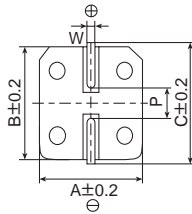
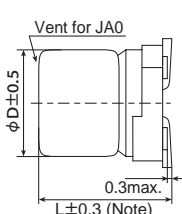

Note : L±0.5 for HA0 and JA0

Note : L±0.5 for HA0 and JA0

▨ : Dummy terminals

Size code	D	L	A	B	C	W	P
E61	5	5.8	5.3	5.3	5.9	0.5 to 0.8	1.4
F61	6.3	5.8	6.6	6.6	7.2	0.5 to 0.8	1.9
F80	6.3	7.7	6.6	6.6	7.2	0.5 to 0.8	1.9
HA0	8	10.0	8.3	8.3	9.0	0.7 to 1.1	3.1
JA0	10	10.0	10.3	10.3	11.0	0.7 to 1.1	4.5

◆ MARKING

EX) 35V330μF



- Rated voltage symbol

Rated voltage (V _{dc})	6.3	10	16	25	35	50
Symbol	j	A	C	E	V	H

Applying voltage over the rated voltages causes the capacitors to have short lifetime. Besides, applying voltage over the specified surge voltages may cause to have short circuit failure. A protection circuit should be used if applied voltage will exceed the rated voltages.



Alchip™-MZR Series

◆PART NUMBERING SYSTEM

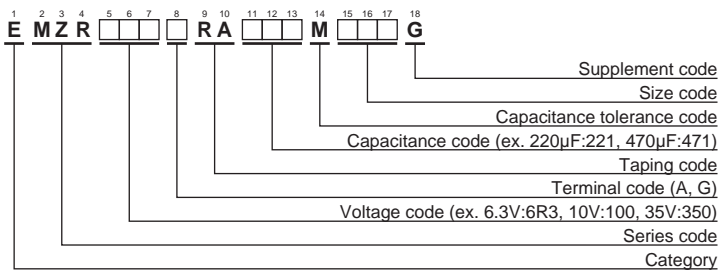

Please refer to "Product code guide (surface mount type)"

◆STANDARD RATINGS

WV (V _{dc})	Cap (µF)	Size code	tan δ	ESR (Ω max./20°C, 100kHz)	Rated ripple current (mA _{rms} /105°C, 100kHz)	Part No.
6.3	220	E61	0.26	0.36	240	EMZR6R3ARA221ME61G
	330	F61	0.26	0.26	300	EMZR6R3 <input type="checkbox"/> RA331MF61G
	680	F80	0.26	0.16	600	EMZR6R3 <input type="checkbox"/> RA681MF80G
	1,500	HA0	0.26	0.08	850	EMZR6R3 <input type="checkbox"/> RA152MHA0G
	2,200	JA0	0.26	0.06	1,190	EMZR6R3 <input type="checkbox"/> RA222MJA0G
10	150	E61	0.19	0.36	240	EMZR100ARA151ME61G
	220	F61	0.19	0.26	300	EMZR100 <input type="checkbox"/> RA221MF61G
	470	F80	0.19	0.16	600	EMZR100 <input type="checkbox"/> RA471MF80G
	1,000	HA0	0.19	0.08	850	EMZR100 <input type="checkbox"/> RA102MHA0G
	1,500	JA0	0.19	0.06	1,190	EMZR100 <input type="checkbox"/> RA152MJA0G
16	100	E61	0.16	0.36	240	EMZR160ARA101ME61G
	220	F61	0.16	0.26	300	EMZR160 <input type="checkbox"/> RA221MF61G
	330	F80	0.16	0.16	600	EMZR160 <input type="checkbox"/> RA331MF80G
	680	HA0	0.16	0.08	850	EMZR160 <input type="checkbox"/> RA681MHA0G
	1,000	JA0	0.16	0.06	1,190	EMZR160 <input type="checkbox"/> RA102MJA0G
25	68	E61	0.14	0.36	240	EMZR250ARA680ME61G
	100	F61	0.14	0.26	300	EMZR250 <input type="checkbox"/> RA101MF61G
	220	F80	0.14	0.16	600	EMZR250 <input type="checkbox"/> RA221MF80G
	470	HA0	0.14	0.08	850	EMZR250 <input type="checkbox"/> RA471MHA0G
	820	JA0	0.14	0.06	1,190	EMZR250 <input type="checkbox"/> RA821MJA0G
35	47	E61	0.12	0.36	240	EMZR350ARA470ME61G
	100	F61	0.12	0.26	300	EMZR350 <input type="checkbox"/> RA101MF61G
	150	F80	0.12	0.16	600	EMZR350 <input type="checkbox"/> RA151MF80G
	330	HA0	0.12	0.08	850	EMZR350 <input type="checkbox"/> RA331MHA0G
	560	JA0	0.12	0.06	1,190	EMZR350 <input type="checkbox"/> RA561MJA0G
50	22	E61	0.10	0.88	165	EMZR500ARA220ME61G
	47	F61	0.10	0.68	195	EMZR500 <input type="checkbox"/> RA470MF61G
	100	F80	0.10	0.34	350	EMZR500 <input type="checkbox"/> RA101MF80G
	220	HA0	0.10	0.18	670	EMZR500 <input type="checkbox"/> RA221MHA0G
	330	JA0	0.10	0.12	900	EMZR500 <input type="checkbox"/> RA331MJA0G

: Enter the appropriate terminal code.

◆RATED RIPPLE CURRENT MULTIPLIERS

●Frequency Multipliers

Capacitance(µF)	Frequency(Hz)			
	120	1k	10k	100k
22 to 150	0.40	0.75	0.90	1.00
220 to 560	0.50	0.85	0.94	1.00
680 to 2,200	0.60	0.87	0.95	1.00

The deterioration of aluminum electrolytic capacitors accelerates their life due to the internal heating produced by ripple current. For details, refer to Section "5-3 Ripple Current Effect on Lifetime" in the catalog, Technical Note.

Alchip™-MZJ Series

- Lower ESR, 2,000 to 5,000 hours at 105°C
- Rated voltage range : 6.3 to 50V
- Nominal capacitance range : 22 to 10,000μF
- Solvent resistant type (see PRECAUTIONS AND GUIDELINES)
- Vibration resistant structure
- RoHS2 Compliant
- AEC-Q200 compliant : Please contact Chemi-Con for more details, test data, information.

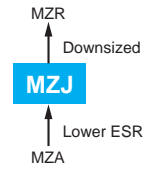

◆ SPECIFICATIONS

Items	Characteristics						
Category	-55 to +105°C						
Temperature Range	-55 to +105°C						
Rated Voltage Range	6.3 to 50V _{dc}						
Capacitance Tolerance	±20% (M) (at 20°C, 120Hz)						
Leakage Current	I=0.01CV or 3μA, whichever is greater. Where, I : Max. leakage current (μA), C : Nominal capacitance (μF), V : Rated voltage (V) (at 20°C after 2 minutes)						
Dissipation Factor (tan δ)	Rated voltage (V _{dc})	6.3V	10V	16V	25V	35V	50V
	tan δ (Max.)	0.26	0.19	0.16	0.14	0.12	0.12
(at 20°C, 120Hz)							
Low Temperature Characteristics (Max. Impedance Ratio)	When nominal capacitance exceeds 1,000μF, add 0.02 to the value above for each 1,000μF increase.						
	Rated voltage (V _{dc})	6.3V	10V	16V	25V	35V	50V
	Z(-25°C)/Z(+20°C)	2	2	2	2	2	2
	Z(-40°C)/Z(+20°C)	3	3	3	3	3	3
(at 120Hz)							
Endurance	The following specifications shall be satisfied when the capacitors are restored to 20°C after the rated voltage is applied for specified time at 105°C.						
	Time	E61 to JA0 : 2,000 hours KE0 to LN0 : 5,000 hours					
	Capacitance change	≤ ±30% of the initial value					
	D.F. (tan δ)	≤200% of the initial specified value					
	Leakage current	≤ The initial specified value					
Shelf Life	The following specifications shall be satisfied when the capacitors are restored to 20°C after exposing them for 1,000 hours at 105°C without voltage applied. Before the measurement, the capacitor shall be preconditioned by applying voltage according to Item 4.1 of JIS C 5101-4.						
	Capacitance change	≤ ±30% of the initial value					
	D.F. (tan δ)	≤200% of the initial specified value					
	Leakage current	≤ The initial specified value					
Surge Voltage Test	The capacitors shall be subjected to 1,000 cycles each consisting of charging with the specified surge voltage for 30±5 seconds through a protective resistor (as required for RC=0.1±0.05sec) and open-circuiting for 5.5 minutes at a room temperature of 15 to 35°C.						
	Rated voltage (V _{dc})	6.3	10	16	25	35	50
	Surge voltage (V _{dc})	7.2	12	18	29	40	58
	Appearance	No significant damage					
	Capacitance change	≤ ±20% of the initial value					
	D.F. (tan δ)	≤200% of the initial specified value					
	Leakage current	≤ The initial specified value					
	(Caution)						
	Surge Voltage Test intends to evaluate capacitors in durability of an exceptional excessive voltage under specific conditions. It does not imply long-term use at all.						

◆ DIMENSIONS [mm]

- Terminal Code : A
- Size code : E61 to LN0
- Terminal Code : G (Vibration resistant structure)
- Size code : F61 to LN0

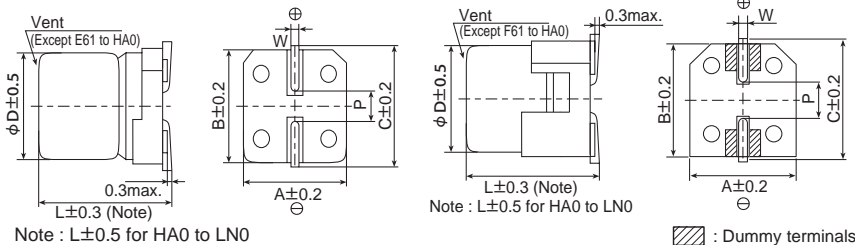

Size code	φD	L	A	B	C	W	P
E61	5	5.8	5.3	5.3	5.9	0.5 to 0.8	1.4
F61	6.3	5.8	6.6	6.6	7.2	0.5 to 0.8	1.9
F80	6.3	7.7	6.6	6.6	7.2	0.5 to 0.8	1.9
HA0	8	10.0	8.3	8.3	9.0	0.7 to 1.1	3.1
JA0	10	10.0	10.3	10.3	11.0	0.7 to 1.1	4.5
KE0	12.5	13.5	13.0	13.0	13.7	1.0 to 1.3	4.2
KG5	12.5	16.0	13.0	13.0	13.7	1.0 to 1.3	4.2
LH0	16	16.5	17.0	17.0	18.0	1.0 to 1.3	6.5
LN0	16	21.5	17.0	17.0	18.0	1.0 to 1.3	6.5

◆ MARKING

EX) 35V220μF



- Rated voltage symbol (E61 to JA0)

Rated voltage (V _{dc})	6.3	10	16	25	35
Symbol	j	A	C	E	V

KE0 to LN0

EX) 16V1,800μF

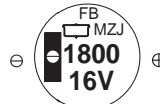

Applying voltage over the rated voltages causes the capacitors to have short lifetime. Besides, applying voltage over the specified surge voltages may cause to have short circuit failure. A protection circuit should be used if applied voltage will exceed the rated voltages.

Alchip™-MZJ Series

◆PART NUMBERING SYSTEM

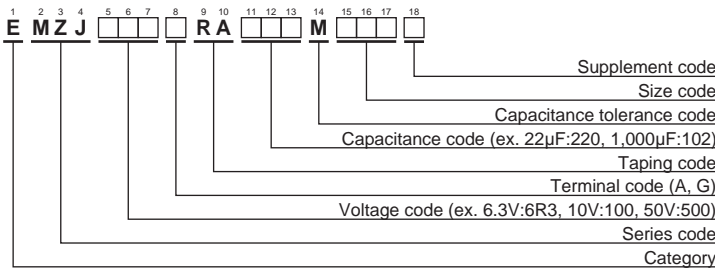

Please refer to "Product code guide (surface mount type)"

◆STANDARD RATINGS

WV (V _{dc})	Cap (μF)	Size code	ESR (Ω max./20°C, 100kHz)	Rated ripple current (mA _{rms} /105°C, 100kHz)	Part No.	WV (V _{dc})	Cap (μF)	Size code	ESR (Ω max./20°C, 100kHz)	Rated ripple current (mA _{rms} /105°C, 100kHz)	Part No.
6.3	100	E61	0.36	240	EMZJ6R3ARA101ME61G	25	33	E61	0.36	240	EMZJ250ARA330ME61G
	220	F61	0.26	300	EMZJ6R3□RA221MF61G		33	F61	0.26	300	EMZJ250□RA330MF61G
	330	F80	0.16	600	EMZJ6R3□RA331MF80G		47	F61	0.26	300	EMZJ250□RA470MF61G
	1,000	HA0	0.08	850	EMZJ6R3□RA102MHA0G		68	F61	0.26	300	EMZJ250□RA680MF61G
	1,500	JA0	0.06	1,190	EMZJ6R3□RA152MJA0G		100	F80	0.16	600	EMZJ250□RA101MF80G
	1,800	JA0	0.06	1,190	EMZJ6R3□RA182MJA0G		330	HA0	0.08	850	EMZJ250□RA331MHA0G
	3,300	KE0	0.051	1,210	EMZJ6R3□RA332MKE0S		470	JA0	0.06	1,190	EMZJ250□RA471MJA0G
	3,900	KG5	0.044	1,420	EMZJ6R3□RA392MKG5S		560	JA0	0.06	1,190	EMZJ250□RA561MJA0G
	6,800	LH0	0.035	1,850	EMZJ6R3□RA682MLH0S		1,200	KE0	0.051	1,210	EMZJ250□RA122MKE0S
	10,000	LN0	0.026	2,330	EMZJ6R3□RA103MLN0S		1,500	KG5	0.044	1,420	EMZJ250□RA152MKG5S
10	150	F61	0.26	300	EMZJ100□RA151MF61G	35	22	E61	0.36	240	EMZJ350ARA220ME61G
	680	HA0	0.08	850	EMZJ100□RA681MHA0G		33	F61	0.26	300	EMZJ350□RA330MF61G
	1,000	JA0	0.06	1,190	EMZJ100□RA102MJA0G		47	F61	0.26	300	EMZJ350□RA470MF61G
	1,200	JA0	0.06	1,190	EMZJ100□RA122MJA0G		68	F61	0.26	300	EMZJ350□RA680MF61G
	2,200	KE0	0.051	1,210	EMZJ100□RA222MKE0S		100	F80	0.16	600	EMZJ350□RA101MF80G
	2,700	KG5	0.044	1,420	EMZJ100□RA272MKG5S		100	HA0	0.08	850	EMZJ350□RA101MHA0G
	4,700	LH0	0.035	1,850	EMZJ100□RA472MLH0S		150	HA0	0.08	850	EMZJ350□RA151MHA0G
6,800	LN0	0.026	2,330	EMZJ100□RA682MLN0S	220	HA0	0.08	850	EMZJ350□RA221MHA0G		
16	47	E61	0.36	240	EMZJ160ARA470ME61G	50	330	JA0	0.06	1,190	EMZJ350□RA331MJA0G
	100	F61	0.26	300	EMZJ160□RA101MF61G		390	JA0	0.06	1,190	EMZJ350□RA391MJA0G
	150	F80	0.16	600	EMZJ160□RA151MF80G		680	KE0	0.051	1,210	EMZJ350□RA681MKE0S
	220	F80	0.16	600	EMZJ160□RA221MF80G		820	KG5	0.044	1,420	EMZJ350□RA821MKG5S
	470	HA0	0.08	850	EMZJ160□RA471MHA0G		1,500	LH0	0.035	1,850	EMZJ350□RA152MLH0S
	680	JA0	0.06	1,190	EMZJ160□RA681MJA0G		2,700	LN0	0.026	2,330	EMZJ350□RA272MLN0S
	820	JA0	0.06	1,190	EMZJ160□RA821MJA0G		390	KE0	0.105	930	EMZJ500□RA391MKE0S
	1,800	KE0	0.051	1,210	EMZJ160□RA182MKE0S		470	KG5	0.092	1,120	EMZJ500□RA471MKG5S
	2,200	KG5	0.044	1,420	EMZJ160□RA222MKG5S		1,000	LH0	0.073	1,660	EMZJ500□RA102MLH0S
	3,900	LH0	0.035	1,850	EMZJ160□RA392MLH0S		1,200	LN0	0.050	1,920	EMZJ500□RA122MLN0S
5,600	LN0	0.026	2,330	EMZJ160□RA562MLN0S							
25	22	E61	0.36	240	EMZJ250ARA220ME61G						

□ : Enter the appropriate terminal code.

◆RATED RIPPLE CURRENT MULTIPLIERS

● Frequency Multipliers

Size code	Capacitance(μF)	Frequency(Hz)			
		120	1k	10k	100k
E61 to JA0	22 to 150	0.40	0.75	0.90	1.00
	220 to 560	0.50	0.85	0.94	1.00
	680 to 1,800	0.60	0.87	0.95	1.00
KE0 to LN0	390 to 470	0.50	0.85	0.94	1.00
	680 to 1,800	0.60	0.87	0.95	1.00
	2,200 to 3,300	0.75	0.90	0.95	1.00
	3,900 to 10,000	0.85	0.95	0.98	1.00

The deterioration of aluminum electrolytic capacitors accelerates their life due to the internal heating produced by ripple current. For details, refer to Section "5-3 Ripple Current Effect on Lifetime" in the catalog, Technical Note.

Alchip™-MZA Series

- Endurance : 2,000 to 5,000 hours at 105°C
- Low impedance
- Solvent resistant type(see PRECAUTIONS AND GUIDELINES)
- Vibration resistant structure
- RoHS2 Compliant
- AEC-Q200 compliant : Please contact Chemi-Con for more details, test data, information.

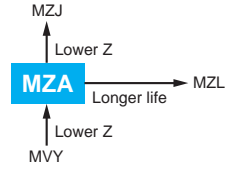

◆ SPECIFICATIONS

Items	Characteristics										
Category	-55 to +105°C										
Temperature Range	-55 to +105°C										
Rated Voltage Range	6.3 to 100V _{dc}										
Capacitance Tolerance	±20%(M) (at 20°C, 120Hz)										
Leakage Current	I=0.01CV or 3μA, whichever is greater Where, I : Max. leakage current (μA), C : Nominal capacitance (μF), V : Rated voltage (V) (at 20°C after 2 minutes)										
Dissipation Factor (tan δ)	Rated voltage(V _{dc})	6.3V	10V	16V	25V	35V	50V	63V	80V	100V	
	tan δ(Max.)	D61 to JA0	0.26	0.19	0.16	0.14	0.12	0.10	0.08	0.08	—
		KE0 to MN0	—	—	—	0.16	0.14	0.12	0.12	0.10	0.10
When nominal capacitance exceeds 1,000μF, add 0.02 to the value above for each 1,000μF increase. (at 20°C, 120Hz)											
Low Temperature Characteristics (Max. impedance Ratio)	Rated voltage(V _{dc})	6.3V	10V	16V	25V	35V	50V	63V	80V	100V	
	Z(-25°C)/Z(+20°C)	2	2	2	2	2	2	2	2	2	
	Z(-40°C)/Z(+20°C)	3	3	3	3	3	3	3	3	3	
	Z(-55°C)/Z(+20°C)	4	4	4	3	3	3	3	3	3	
(at 120Hz)											
Endurance	The following specifications shall be satisfied when the capacitors are restored to 20°C after the rated voltage is applied for specified time at 105°C.										
	Time	D61 to JA0 : 2,000 hours KE0 to MN0 : 5,000 hours									
	Capacitance change	≤ ±30% of the initial value									
	D.F. (tan δ)	≤200% of the initial specified value									
	Leakage current	≤The initial specified value									

◆ DIMENSIONS [mm]

- Terminal Code : A
- Size code : D61 to MN0
- Terminal Code : G(Vibration resistant structure)
- Size code : F61 to MN0

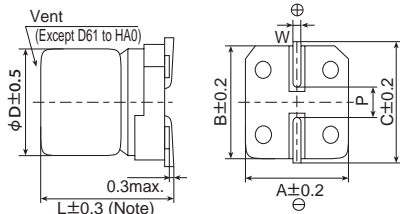

Note : L±0.5 for HA0 to MN0

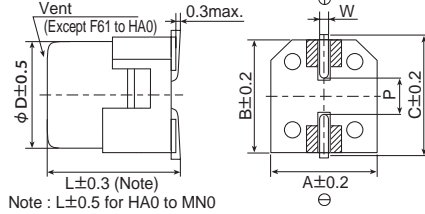

Note : L±0.5 for HA0 to MN0

▨ : Dummy terminals

Size code	D	L	A	B	C	W	P
D61	4	5.8	4.3	4.3	5.1	0.5 to 0.8	1.0
E61	5	5.8	5.3	5.3	5.9	0.5 to 0.8	1.4
F61	6.3	5.8	6.6	6.6	7.2	0.5 to 0.8	1.9
F80	6.3	7.7	6.6	6.6	7.2	0.5 to 0.8	1.9
HA0	8	10.0	8.3	8.3	9.0	0.7 to 1.1	3.1
JA0	10	10.0	10.3	10.3	11.0	0.7 to 1.1	4.5
KE0	12.5	13.5	13.0	13.0	13.7	1.0 to 1.3	4.2
KG5	12.5	16.0	13.0	13.0	13.7	1.0 to 1.3	4.2
LH0	16	16.5	17.0	17.0	18.0	1.0 to 1.3	6.5
LN0	16	21.5	17.0	17.0	18.0	1.0 to 1.3	6.5
MH0	18	16.5	19.0	19.0	20.0	1.0 to 1.3	6.5
MN0	18	21.5	19.0	19.0	20.0	1.0 to 1.3	6.5

◆ PART NUMBERING SYSTEM

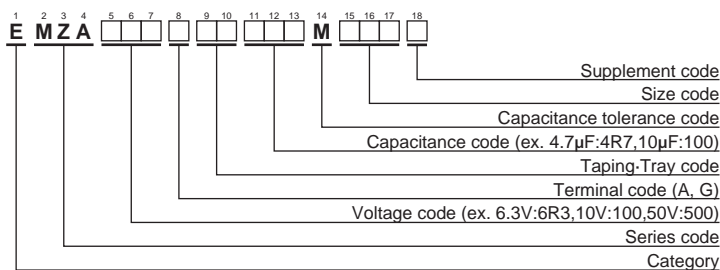

Please refer to "Product code guide (surface mount type)"

◆ MARKING

D61 to JA0
EX) 16V220μF



KE0 to MN0
EX) 25V1,000μF

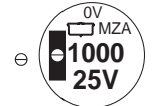

- Rated voltage symbol (D61 to JA0)

Rated voltage (V _{dc})	6.3	10	16	25	35	50	63	80
Symbol	j	A	C	E	V	H	J	K



Alchip™ - **MZA** Series

◆ **STANDARD RATINGS**

WV (Vdc)	Cap (µF)	Size code	Impedance (Ω max./100kHz)		Rated ripple current (mArms/105°C, 100kHz)	Part No.	WV (Vdc)	Cap (µF)	Size code	Impedance (Ω max./100kHz)		Rated ripple current (mArms/105°C, 100kHz)	Part No.
			20°C	-40°C						20°C	-40°C		
6.3	22	D61	1.35	-	90	EMZA6R3ARA220MD61G	35	330	JA0	0.08	-	850	EMZA350 □ RA331MJA0G
	47	D61	1.35	-	90	EMZA6R3ARA470MD61G		620	KE0	0.060	0.30	1,320	EMZA350 □ RA621MKE0S
	47	E61	0.70	-	160	EMZA6R3ARA470ME61G		820	KG5	0.056	0.28	1,470	EMZA350 □ RA821MKG5S
	100	E61	0.70	-	160	EMZA6R3ARA101ME61G		1,200	LH0	0.047	0.24	1,820	EMZA350 □ RA122MLH0S
	100	F61	0.36	-	240	EMZA6R3 □ RA101MF61G		1,600	MH0	0.045	0.23	2,060	EMZA350 □ RA162MMH0S
	220	F61	0.36	-	240	EMZA6R3 □ RA221MF61G		1,800	LNO	0.034	0.17	2,400	EMZA350 □ RA182MLN0S
	330	F80	0.34	-	280	EMZA6R3 □ RA331MF80G		2,400	MNO	0.032	0.16	2,640	EMZA350 □ RA242MMN0S
	470	HA0	0.16	-	600	EMZA6R3 □ RA471MHA0G		4.7	D61	2.9	-	60	EMZA500ARA4R7MD61G
	1,000	HA0	0.16	-	600	EMZA6R3 □ RA102MHA0G		10	E61	1.52	-	85	EMZA500ARA100ME61G
	1,500	JA0	0.08	-	850	EMZA6R3 □ RA152MJA0G		10	F61	0.88	-	165	EMZA500 □ RA100MF61G
10	22	D61	1.35	-	90	EMZA100ARA220MD61G	22	F61	0.88	-	165	EMZA500 □ RA220MF61G	
	33	D61	1.35	-	90	EMZA100ARA330MD61G	33	F80	0.68	-	195	EMZA500 □ RA330MF80G	
	33	E61	0.70	-	160	EMZA100ARA330ME61G	47	F80	0.68	-	195	EMZA500 □ RA470MF80G	
	220	F80	0.34	-	280	EMZA100 □ RA221MF80G	100	HA0	0.34	-	350	EMZA500 □ RA621MLH0S	
	330	HA0	0.16	-	600	EMZA100 □ RA331MHA0G	220	JA0	0.18	-	670	EMZA500 □ RA221MJA0G	
	470	HA0	0.16	-	600	EMZA100 □ RA471MHA0G	330	KE0	0.11	0.55	980	EMZA500 □ RA331MKE0S	
	680	HA0	0.16	-	600	EMZA100 □ RA681MHA0G	430	KG5	0.10	0.50	1,090	EMZA500 □ RA431MKG5S	
	1,000	JA0	0.08	-	850	EMZA100 □ RA102MJA0G	620	LH0	0.087	0.44	1,320	EMZA500 □ RA621MLH0S	
	10	D61	1.35	-	90	EMZA160ARA100MD61G	820	MH0	0.087	0.44	1,420	EMZA500 □ RA821MMH0S	
	22	D61	1.35	-	90	EMZA160ARA220MD61G	1,000	LNO	0.050	0.25	1,910	EMZA500 □ RA102MLN0S	
16	22	E61	0.70	-	160	EMZA160ARA220ME61G	1,300	MNO	0.050	0.25	2,180	EMZA500 □ RA132MMN0S	
	47	E61	0.70	-	160	EMZA160ARA470ME61G	4.7	E61	4.8	-	50	EMZA630ARA4R7ME61G	
	47	F61	0.36	-	240	EMZA160 □ RA470MF61G	10	F61	2.2	-	80	EMZA630 □ RA100MF61G	
	100	F61	0.36	-	240	EMZA160 □ RA101MF61G	22	F80	2.1	-	120	EMZA630 □ RA220MF80G	
	220	F80	0.34	-	280	EMZA160 □ RA221MF80G	33	HA0	0.70	-	250	EMZA630 □ RA330MHA0G	
	330	HA0	0.16	-	600	EMZA160 □ RA331MHA0G	47	HA0	0.70	-	250	EMZA630 □ RA470MHA0G	
	470	HA0	0.16	-	600	EMZA160 □ RA471MHA0G	68	HA0	0.70	-	250	EMZA630 □ RA680MHA0G	
	680	JA0	0.08	-	850	EMZA160 □ RA681MJA0G	100	JA0	0.45	-	400	EMZA630 □ RA101MJA0G	
	10	D61	1.35	-	90	EMZA250ARA100MD61G	240	KE0	0.19	1.54	880	EMZA630 □ RA241MKE0S	
	22	E61	0.70	-	160	EMZA250ARA220ME61G	300	KG5	0.17	1.19	1,000	EMZA630 □ RA301MKG5S	
25	33	E61	0.70	-	160	EMZA250ARA330ME61G	430	LH0	0.15	1.05	1,220	EMZA630 □ RA431MLH0S	
	33	F61	0.36	-	240	EMZA250 □ RA330MF61G	560	MH0	0.12	0.84	1,430	EMZA630 □ RA561MMH0S	
	47	F61	0.36	-	240	EMZA250 □ RA470MF61G	680	LNO	0.085	0.58	1,790	EMZA630 □ RA681MLN0S	
	100	F80	0.34	-	280	EMZA250 □ RA101MF80G	910	MNO	0.070	0.49	1,960	EMZA630 □ RA911MMN0S	
	220	HA0	0.16	-	600	EMZA250 □ RA221MHA0G	3.3	E61	5.0	-	25	EMZA800ARA3R3ME61G	
	330	HA0	0.16	-	600	EMZA250 □ RA331MHA0G	4.7	F61	3.0	-	40	EMZA800 □ RA4R7MF61G	
	470	JA0	0.08	-	850	EMZA250 □ RA471MJA0G	10	F80	2.4	-	60	EMZA800 □ RA100MF80G	
	1,000	KE0	0.060	0.30	1,320	EMZA250 □ RA102MKE0S	22	HA0	1.3	-	130	EMZA800 □ RA220MHA0G	
	1,300	KG5	0.056	0.28	1,470	EMZA250 □ RA132MKG5S	33	HA0	1.3	-	130	EMZA800 □ RA330MHA0G	
	1,800	LH0	0.047	0.24	1,820	EMZA250 □ RA182MLH0S	47	JA0	0.70	-	200	EMZA800 □ RA470MJA0G	
35	2,400	MH0	0.045	0.23	2,060	EMZA250 □ RA242MMH0S	150	KE0	0.22	1.54	810	EMZA800 □ RA151MKE0S	
	3,000	LNO	0.034	0.17	2,400	EMZA250 □ RA302MLN0S	220	KG5	0.17	1.19	1,000	EMZA800 □ RA221MKG5S	
	3,900	MNO	0.032	0.16	2,640	EMZA250 □ RA392MMN0S	330	LH0	0.15	1.05	1,220	EMZA800 □ RA331MLH0S	
	4.7	D61	1.35	-	90	EMZA350ARA4R7MD61G	430	MH0	0.12	0.84	1,430	EMZA800 □ RA431MMH0S	
	10	D61	1.35	-	90	EMZA350ARA100MD61G	470	LNO	0.085	0.58	1,790	EMZA800 □ RA471MLN0S	
	10	E61	0.70	-	160	EMZA350ARA100ME61G	680	MNO	0.070	0.49	1,960	EMZA800 □ RA681MMN0S	
	22	E61	0.70	-	160	EMZA350ARA220ME61G	110	KE0	0.28	2.24	740	EMZA101 □ RA111MKE0S	
	33	F61	0.36	-	240	EMZA350 □ RA330MF61G	130	KG5	0.21	1.68	900	EMZA101 □ RA131MKG5S	
	47	F61	0.36	-	240	EMZA350 □ RA470MF61G	200	LH0	0.18	1.44	1,090	EMZA101 □ RA201MLH0S	
	100	F80	0.34	-	280	EMZA350 □ RA101MF80G	270	MH0	0.15	1.2	1,280	EMZA101 □ RA271MMH0S	
100	HA0	0.16	-	600	EMZA350 □ RA101MHA0G	330	LNO	0.11	0.88	1,580	EMZA101 □ RA331MLN0S		
220	HA0	0.16	-	600	EMZA350 □ RA221MHA0G	430	MNO	0.091	0.73	1,690	EMZA101 □ RA431MMN0S		

□ : Enter the appropriate terminal code.
 Production of the products shown in is scheduled to be discontinued.

◆ **RATED RIPPLE CURRENT MULTIPLIERS**

● Frequency Multipliers

Size code	Capacitance(µF)	Frequency(Hz)			
		120	1k	10k	100k
D61 to JA0	3.3 to 4.7	0.35	0.70	0.90	1.00
	10 to 100	0.40	0.75	0.90	1.00
	220 to 470	0.50	0.85	0.94	1.00
	680 to 1,500	0.60	0.87	0.95	1.00
KE0 to MNO	110 to 200	0.40	0.75	0.90	1.00
	220 to 620	0.50	0.85	0.94	1.00
	680 to 1,800	0.60	0.87	0.95	1.00
	2,400 to 3,000	0.75	0.90	0.95	1.00
	3,900	0.85	0.95	0.98	1.00

The deterioration of aluminum electrolytic capacitors accelerates their life due to the internal heating produced by ripple current. For details, refer to Section "5-3 Ripple Current Effect on Lifetime" in the catalog, Technical Note.

Product specifications in this catalog are subject to change without notice. Request our product specifications before purchase and/or use. Please use our products based on the information contained in this catalog and product specifications.



Alchip™-MVY Series

- Endurance : 1,000 to 5,000 hours at 105°C
- Low impedance
- For digital equipment, especially DC-DC converters
- Solvent resistant type except 80 & 100V_{dc} (see PRECAUTIONS AND GUIDELINES)
- Vibration resistant structure
- RoHS2 Compliant
- AEC-Q200 compliant : Please contact Chemi-Con for more details, test data, information.

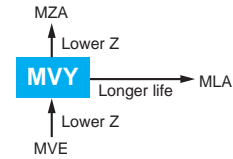

◆ SPECIFICATIONS

Items	Characteristics											
Category	-55 to +105°C (6.3 to 63V _{dc}) -40 to +105°C (80 & 100V _{dc})											
Temperature Range												
Rated Voltage Range	6.3 to 100V _{dc}											
Capacitance Tolerance	±20% (M) (at 20°C, 120Hz)											
Leakage Current	I=0.01CV or 3μA, whichever is greater. Where, I : Max. leakage current (μA), C : Nominal capacitance (μF), V : Rated voltage (V) (at 20°C after 2 minutes)											
Dissipation Factor (tan δ)	Rated voltage (V _{dc})	6.3V	10V	16V	25V	35V	50V	63V	80V	100V	When nominal capacitance exceeds 1,000μF, add 0.02 to the value above for each 1,000μF increase. (at 20°C, 120Hz)	
	tan δ (Max.)	D55 to F80	0.24	0.20	0.16	0.14	0.12	0.12	—	—		—
		HA0 & JA0	0.28	0.24	0.20	0.16	0.14	0.12	—	—		—
Low Temperature Characteristics (Max. Impedance Ratio)	Rated voltage (V _{dc})	6.3V	10V	16V	25V	35V	50V	63V	80V	100V	(at 120Hz)	
	Z(-40°C)/Z(+20°C)	D55 to JA0	3	2	2	2	2	2	—	—		—
		KE0 to MN0	10	8	6	4	3	3	3	3		3
Endurance	The following specifications shall be satisfied when the capacitors are restored to 20°C after the rated voltage is applied for specified time at 105°C.											
	Time	D55 to F80 : 1,000 hours HA0 & JA0 : 2,000 hours KE0 to MN0 : 5,000 hours										
	Rated voltage	6.3V _{dc} (D55 to JA0)					6.3 to 100V _{dc}					
	Capacitance change	≤ ±30% of the initial value					≤ ±20% of the initial value					
	D.F. (tan δ)	≤300% of the initial specified value					≤200% of the initial specified value					
	Leakage current	≤The initial specified value					≤The initial specified value					
	Shelf Life	The following specifications shall be satisfied when the capacitors are restored to 20°C after exposing them for 1,000 hours at 105°C without voltage applied. Before the measurement, the capacitor shall be preconditioned by applying voltage according to Item 4.1 of JIS C 5101-4.										
	Rated voltage	6.3V _{dc} (D55 to JA0)					6.3 to 100V _{dc}					
	Capacitance change	≤ ±30% of the initial value					≤ ±20% of the initial value					
	D.F. (tan δ)	≤300% of the initial specified value					≤200% of the initial specified value					
	Leakage current	≤The initial specified value					≤The initial specified value					

◆ DIMENSIONS [mm]

- Terminal Code : A
- Size code : D55 to MN0

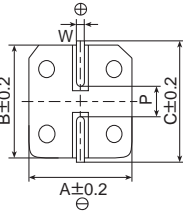
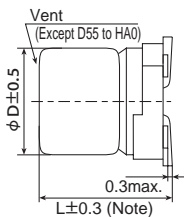

- Terminal Code : G (Vibration resistant structure)
- Size code : F61 to MN0

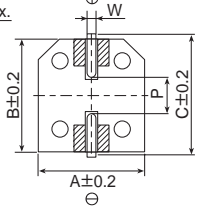
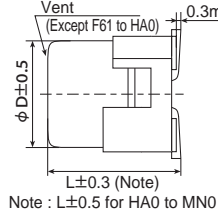

Size code	D	L	A	B	C	W	P
D55	4	5.2	4.3	4.3	5.1	0.5 to 0.8	1.0
E55	5	5.2	5.3	5.3	5.9	0.5 to 0.8	1.4
F55	6.3	5.2	6.6	6.6	7.2	0.5 to 0.8	1.9
F61	6.3	5.8	6.6	6.6	7.2	0.5 to 0.8	1.9
F80	6.3	7.7	6.6	6.6	7.2	0.5 to 0.8	1.9
HA0	8	10.0	8.3	8.3	9.0	0.7 to 1.1	3.1
JA0	10	10.0	10.3	10.3	11.0	0.7 to 1.1	4.5
KE0	12.5	13.5	13.0	13.0	13.7	1.0 to 1.3	4.2
KG5	12.5	16.0	13.0	13.0	13.7	1.0 to 1.3	4.2
LH0	16	16.5	17.0	17.0	18.0	1.0 to 1.3	6.5
LN0	16	21.5	17.0	17.0	18.0	1.0 to 1.3	6.5
MH0	18	16.5	19.0	19.0	20.0	1.0 to 1.3	6.5
MN0	18	21.5	19.0	19.0	20.0	1.0 to 1.3	6.5

◆ PART NUMBERING SYSTEM

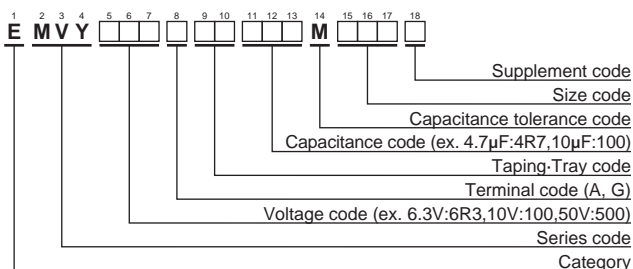

Please refer to "Product code guide (surface mount type)"

◆ MARKING

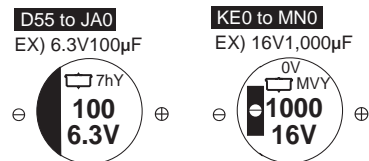



Alchip™-MVY Series

◆STANDARD RATINGS

WV (V _{dc})	Cap (μF)	Size code	Impedance (Ω max./20°C, 100kHz)	Rated ripple current (mA rms/105°C, 100kHz)	Part No.	WV (V _{dc})	Cap (μF)	Size code	Impedance (Ω max./20°C, 100kHz)	Rated ripple current (mA rms/105°C, 100kHz)	Part No.		
6.3	22	D55	3.0	60	EMVY6R3ARA220MD55G	25	330	HA0	0.30	450	EMVY250□RA331MHA0G		
	33	E55	1.8	95	EMVY6R3ARA330ME55G		470	JA0	0.15	670	EMVY250□RA471MJA0G		
	47	E55	1.8	95	EMVY6R3ARA470ME55G		1,000	LH0	0.054	1,260	EMVY250□RA102MLH0S		
	100	F55	1.0	140	EMVY6R3ARA101MF55G		1,000	MH0	0.054	1,350	EMVY250□RA102MMH0S		
	220	F55	1.0	140	EMVY6R3ARA221MF55G		2,200	LNO	0.038	1,630	EMVY250□RA222MLN0S		
	330	F80	0.34	280	EMVY6R3□RA331MF80G		2,200	MNO	0.038	1,750	EMVY250□RA222MMN0S		
	470	HA0	0.30	450	EMVY6R3□RA471MHA0G		3,300	MNO	0.038	1,750	EMVY250□RA332MMN0S		
	680	HA0	0.30	450	EMVY6R3□RA681MHA0G		35	4.7	D55	3.0	60	EMVY350ARA4R7MD55G	
	1,000	HA0	0.30	450	EMVY6R3□RA102MHA0G			10	E55	1.8	95	EMVY350ARA100ME55G	
	1,500	JA0	0.15	670	EMVY6R3□RA152MJA0G			22	F55	1.0	140	EMVY350ARA220MF55G	
	2,200	KE0	0.070	820	EMVY6R3□RA222MKE0S			33	F55	1.0	140	EMVY350ARA330MF55G	
	2,200	LH0	0.054	1,260	EMVY6R3□RA222MLH0S			47	F55	1.0	140	EMVY350ARA470MF55G	
	3,300	KG5	0.060	950	EMVY6R3□RA332MKG5S			47	F61	1.0	140	EMVY350□RA470MF61G	
	3,300	MH0	0.054	1,350	EMVY6R3□RA332MMH0S			68	F80	0.34	280	EMVY350□RA680MF80G	
	4,700	LNO	0.038	1,630	EMVY6R3□RA472MLN0S			100	HA0	0.30	450	EMVY350□RA101MHA0G	
	4,700	MH0	0.054	1,350	EMVY6R3□RA472MMH0S			220	HA0	0.30	450	EMVY350□RA221MHA0G	
	6,800	LNO	0.038	1,630	EMVY6R3□RA682MLN0S			330	JA0	0.15	670	EMVY350□RA331MJA0G	
	6,800	MNO	0.038	1,750	EMVY6R3□RA682MMN0S			470	KE0	0.070	820	EMVY350□RA471MKE0S	
8,200	MNO	0.038	1,750	EMVY6R3□RA822MMN0S	470	LH0		0.054	1,260	EMVY350□RA471MLH0S			
10	22	E55	1.8	95	EMVY100ARA220ME55G	1,000		LH0	0.054	1,260	EMVY350□RA102MLH0S		
	33	E55	1.8	95	EMVY100ARA330ME55G	1,000		MH0	0.054	1,350	EMVY350□RA102MMH0S		
	47	F55	1.0	140	EMVY100ARA470MF55G	2,200		MNO	0.038	1,750	EMVY350□RA222MMN0S		
	100	F55	1.0	140	EMVY100ARA101MF55G	50		1.0	D55	5.0	30	EMVY500ARA1R0MD55G	
	220	F80	0.34	280	EMVY100□RA221MF80G			2.2	D55	5.0	30	EMVY500ARA2R2MD55G	
	330	HA0	0.30	450	EMVY100□RA331MHA0G			3.3	D55	5.0	30	EMVY500ARA3R3MD55G	
	470	HA0	0.30	450	EMVY100□RA471MHA0G		4.7	E55	3.0	50	EMVY500ARA4R7ME55G		
	680	JA0	0.15	670	EMVY100□RA681MJA0G		10	F55	2.0	70	EMVY500ARA100MF55G		
	1,000	JA0	0.15	670	EMVY100□RA102MJA0G		22	F55	2.0	70	EMVY500ARA220MF55G		
	2,200	KG5	0.060	950	EMVY100□RA222MKG5S		33	F80	0.60	170	EMVY500□RA330MF80G		
	2,200	LH0	0.054	1,260	EMVY100□RA222MLH0S		47	F80	0.60	170	EMVY500□RA470MF80G		
	3,300	LH0	0.054	1,260	EMVY100□RA332MLH0S		68	HA0	0.60	300	EMVY500□RA680MHA0G		
	3,300	MH0	0.054	1,350	EMVY100□RA332MMH0S		100	HA0	0.60	300	EMVY500□RA101MHA0G		
	4,700	LNO	0.038	1,630	EMVY100□RA472MLN0S		220	JA0	0.30	500	EMVY500□RA221MJA0G		
	4,700	MNO	0.038	1,750	EMVY100□RA472MMN0S		330	KE0	0.11	650	EMVY500□RA331MKE0S		
	6,800	MNO	0.038	1,750	EMVY100□RA682MMN0S		330	LH0	0.087	900	EMVY500□RA331MLH0S		
	16	10	D55	3.0	60		EMVY160ARA100MD55G	470	LH0	0.087	900	EMVY500□RA471MLH0S	
		22	E55	1.8	95		EMVY160ARA220ME55G	470	MH0	0.087	1,060	EMVY500□RA471MMH0S	
33		F55	1.0	140	EMVY160ARA330MF55G		1,000	MNO	0.050	1,520	EMVY500□RA102MMN0S		
47		F55	1.0	140	EMVY160ARA470MF55G		63	68	KE0	0.19	500	EMVY630□RA680MKE0S	
100		F55	1.0	140	EMVY160ARA101MF55G			100	KE0	0.19	500	EMVY630□RA101MKE0S	
220		F80	0.34	280	EMVY160□RA221MF80G	220		KE0	0.19	500	EMVY630□RA221MKE0S		
330		HA0	0.30	450	EMVY160□RA331MHA0G	220		LH0	0.12	845	EMVY630□RA221MLH0S		
470		HA0	0.30	450	EMVY160□RA471MHA0G	330		LH0	0.12	845	EMVY630□RA331MLH0S		
680		JA0	0.15	670	EMVY160□RA681MJA0G	330		MH0	0.12	905	EMVY630□RA331MMH0S		
1,000		KE0	0.070	820	EMVY160□RA102MKE0S	470		LNO	0.085	1,100	EMVY630□RA471MLN0S		
1,000		LH0	0.054	1,260	EMVY160□RA102MLH0S	470		MH0	0.12	905	EMVY630□RA471MMH0S		
2,200		LH0	0.054	1,260	EMVY160□RA222MLH0S	80		100	KE0	0.33	450	EMVY800□RA101MKE0S	
2,200		MH0	0.054	1,350	EMVY160□RA222MMH0S			220	KG5	0.26	550	EMVY800□RA221MKG5S	
3,300		LNO	0.038	1,630	EMVY160□RA332MLN0S			330	LNO	0.16	900	EMVY800□RA331MLN0S	
3,300		MH0	0.054	1,350	EMVY160□RA332MMH0S			330	MH0	0.24	700	EMVY800□RA331MMH0S	
4,700		MNO	0.038	1,750	EMVY160□RA472MMN0S			470	MNO	0.16	950	EMVY800□RA471MMN0S	
25		10	E55	1.8	95			EMVY250ARA100ME55G	100	47	KE0	0.33	450
		22	F55	1.0	140	EMVY250ARA220MF55G		68		KE0	0.33	450	EMVY101□RA680MKE0S
	33	F55	1.0	140	EMVY250ARA330MF55G	100		KE0		0.33	450	EMVY101□RA101MKE0S	
	47	F55	1.0	140	EMVY250ARA470MF55G	100		LH0		0.24	650	EMVY101□RA101MLH0S	
	100	F80	0.34	280	EMVY250□RA101MF80G	220		LNO		0.16	900	EMVY101□RA221MLN0S	
	220	HA0	0.30	450	EMVY250□RA221MHA0G	220	MH0	0.24		700	EMVY101□RA221MMH0S		

□ : Enter the appropriate terminal code.
 Production of the products shown in □ is scheduled to be discontinued.
 *1: Assembly boards with the designated products attached cannot be cleaned.

◆RATED RIPPLE CURRENT MULTIPLIERS

● Frequency Multipliers

Size code	Capacitance(μF)	Frequency(Hz)			
		120	1k	10k	100k
D55 to JA0	1.0 to 4.7	0.35	0.70	0.90	1.00
	10 to 100	0.40	0.75	0.90	1.00
	220 to 470	0.50	0.85	0.94	1.00
	680 to 1,500	0.60	0.87	0.95	1.00
KE0 to MNO	47 to 100	0.40	0.75	0.90	1.00
	220 to 470	0.50	0.85	0.94	1.00
	1,000	0.60	0.87	0.95	1.00
	2,200 to 3,300	0.75	0.90	0.95	1.00
	4,700 to 8,200	0.85	0.95	0.98	1.00

The deterioration of aluminum electrolytic capacitors accelerates their life due to the internal heating produced by ripple current. For details, refer to Section "5-3 Ripple Current Effect on Lifetime" in the catalog, Technical Note.

Product specifications in this catalog are subject to change without notice. Request our product specifications before purchase and/or use. Please use our products based on the information contained in this catalog and product specifications.



Alchip™-MZF Series

- Endurance : 10,000 hours at 105°C
- Low impedance
- Rated voltage range : 6.3 to 50V
- Nominal capacitance range : 10 to 470µF
- Suitable for long life and low profile products
- Solvent resistant type (see PRECAUTIONS AND GUIDELINES)
- RoHS2 Compliant



◆ SPECIFICATIONS

Items	Characteristics						
Category	-25 to +105°C						
Temperature Range	-25 to +105°C						
Rated Voltage Range	6.3 to 50V _{dc}						
Capacitance Tolerance	±20%(M) (at 20°C, 120Hz)						
Leakage Current	I=0.01CV or 3µA, whichever is greater Where, I : Max. leakage current (µA), C : Nominal capacitance (µF), V : Rated voltage (V) (at 20°C, after 2 minutes)						
Dissipation Factor (tan δ)	Rated voltage (V _{dc})	6.3V	10V	16V	25V	35V	50V
	tan δ (Max.)	0.32	0.28	0.26	0.16	0.14	0.14
Low Temperature Characteristics (Max. Impedance Ratio)	Rated voltage(V _{dc})	6.3V	10V	16V	25V	35V	50V
	Z(-10°C)/Z(+20°C)	4	3	2	2	2	2
Endurance	The following specifications shall be satisfied when the capacitors are restored to 20°C after the rated voltage is applied for 10,000 hours at 105°C.						
	Capacitance change	≤ ±30% of the initial value					
	D.F. (tan δ)	≤ 300% of the initial specified value					
	Leakage current	≤ The initial specified value					
Shelf Life	The following specifications shall be satisfied when the capacitors are restored to 20°C after exposing them for 1,000 hours at 105°C without voltage applied. Before the measurement, the capacitor shall be preconditioned by applying voltage according to Item 4.1 of JIS C 5101-4.						
	Capacitance change	≤ ±30% of the initial value					
	D.F. (tan δ)	≤ 300% of the initial specified value					
	Leakage current	≤ The initial specified value					

◆ DIMENSIONS [mm]

● Terminal Code : A

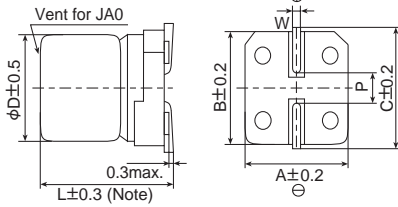

Size code	D	L	A	B	C	W	P
E73	5	7.0	5.3	5.3	5.9	0.5 to 0.8	1.4
F73	6.3	7.0	6.6	6.6	7.2	0.5 to 0.8	1.9
F90	6.3	8.7	6.6	6.6	7.2	0.5 to 0.8	1.9
HA0	8	10.0	8.3	8.3	9.0	0.7 to 1.1	3.1
JA0	10	10.0	10.3	10.3	11.0	0.7 to 1.1	4.5

◆ PART NUMBERING SYSTEM

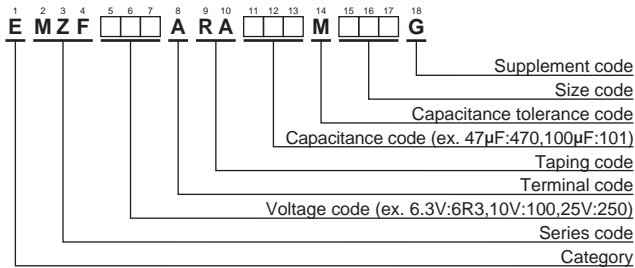

Please refer to "Product code guide (surface mount type)"

◆ MARKING

EX) 16V47µF



● Rated voltage symbol

Rated voltage (V _{dc})	6.3	10	16	25	35	50
Symbol	j	A	C	E	V	H



Alchip™-MZF Series

◆STANDARD RATINGS

WV (V _{dc})	Cap (μF)	Size code	Impedance (Ω max./20°C, 100kHz)	Rated ripple current (mA _{rms} /105°C, 100kHz)	Part No.	WV (V _{dc})	Cap (μF)	Size code	Impedance (Ω max./20°C, 100kHz)	Rated ripple current (mA _{rms} /105°C, 100kHz)	Part No.
6.3	47	E73	2.2	95	EMZF6R3ARA470ME73G	25	33	F73	1.1	140	EMZF250ARA330MF73G
	100	F73	1.1	140	EMZF6R3ARA101MF73G		47	F73	1.1	140	EMZF250ARA470MF73G
	220	F90	1.0	230	EMZF6R3ARA221MF90G		100	F90	1.0	230	EMZF250ARA101MF90G
	330	F90	1.0	230	EMZF6R3ARA331MF90G		220	HA0	0.22	600	EMZF250ARA221MHA0G
	470	HA0	0.22	600	EMZF6R3ARA471MHA0G		330	JA0	0.16	850	EMZF250ARA331MJA0G
10	33	E73	2.2	95	EMZF100ARA330ME73G	35	10	E73	2.2	95	EMZF350ARA100ME73G
	150	F73	1.1	140	EMZF100ARA151MF73G		10	F73	1.1	140	EMZF350ARA100MF73G
16	22	E73	2.2	95	EMZF160ARA220ME73G		22	E73	2.2	95	EMZF350ARA220ME73G
	47	F73	1.1	140	EMZF160ARA470MF73G		22	F73	1.1	140	EMZF350ARA220MF73G
	100	F73	1.1	140	EMZF160ARA101MF73G		33	F90	1.0	230	EMZF350ARA330MF90G
	150	F90	1.0	230	EMZF160ARA151MF90G		47	F90	1.0	230	EMZF350ARA470MF90G
	220	F90	1.0	230	EMZF160ARA221MF90G		100	HA0	0.22	600	EMZF350ARA101MHA0G
	330	HA0	0.22	600	EMZF160ARA331MHA0G		220	JA0	0.16	850	EMZF350ARA221MJA0G
	470	JA0	0.16	850	EMZF160ARA471MJA0G	50	47	HA0	0.53	350	EMZF500ARA470MHA0G
25	22	E73	2.2	95	EMZF250ARA220ME73G		100	JA0	0.35	670	EMZF500ARA101MJA0G

Production of the products shown in is scheduled to be discontinued.

◆RATED RIPPLE CURRENT MULTIPLIERS

● Frequency Multipliers

Capacitance(μF)	Frequency(Hz)			
	120	1k	10k	100k
10 to 150	0.40	0.75	0.90	1.00
220 to 470	0.50	0.85	0.94	1.00

The deterioration of aluminum electrolytic capacitors accelerates their life due to the internal heating produced by ripple current. For details, refer to Section "5-3 Ripple Current Effect on Lifetime" in the catalog, Technical Note.



Alchip™-MZE Series

- Endurance : 7,000 to 8,000 hours at 105°C
- Low impedance
- Rated voltage range : 6.3 to 50V
- Nominal capacitance range : 10 to 470μF
- Suitable for long life and low profile products
- Solvent resistant type (see PRECAUTIONS AND GUIDELINES)
- RoHS2 Compliant



◆ SPECIFICATIONS

Items	Characteristics						
Category	-25 to +105°C						
Temperature Range	-25 to +105°C						
Rated Voltage Range	6.3 to 50V _{dc}						
Capacitance Tolerance	±20%(M) (at 20°C, 120Hz)						
Leakage Current	I=0.01CV or 3μA, whichever is greater Where, I : Max. leakage current (μA), C : Nominal capacitance (μF), V : Rated voltage (V) (at 20°C, after 2 minutes)						
Dissipation Factor (tan δ)	Rated voltage (V _{dc})	6.3V	10V	16V	25V	35V	50V
	tan δ (Max.)	0.32	0.28	0.26	0.16	0.14	0.14
Low Temperature Characteristics (Max. Impedance Ratio)	Rated voltage(V _{dc})	6.3V	10V	16V	25V	35V	50V
	Z(-10°C)/Z(+20°C)	4	3	2	2	2	2
Endurance	The following specifications shall be satisfied when the capacitors are restored to 20°C after the rated voltage is applied for specified time at 105°C.						
	Time	E73 & F73 : 7,000 hours F90 to JA0 : 8,000 hours					
	Capacitance change	≤ ±30% of the initial value					
	D.F. (tan δ)	≤300% of the initial specified value					
	Leakage current	≤The initial specified value					
Shelf Life	The following specifications shall be satisfied when the capacitors are restored to 20°C after exposing them for 1,000 hours at 105°C without voltage applied. Before the measurement, the capacitor shall be preconditioned by applying voltage according to Item 4.1 of JIS C 5101-4.						
	Capacitance change	≤ ±30% of the initial value					
	D.F. (tan δ)	≤300% of the initial specified value					
	Leakage current	≤The initial specified value					

◆ DIMENSIONS [mm]

● Terminal Code : A

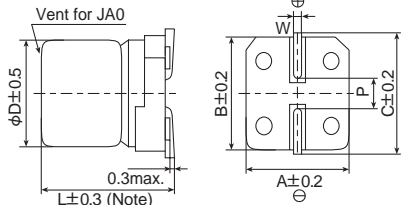

Note : L±0.5 for HA0 and JA0

Size code	D	L	A	B	C	W	P
E73	5	7.0	5.3	5.3	5.9	0.5 to 0.8	1.4
F73	6.3	7.0	6.6	6.6	7.2	0.5 to 0.8	1.9
F90	6.3	8.7	6.6	6.6	7.2	0.5 to 0.8	1.9
HA0	8	10.0	8.3	8.3	9.0	0.7 to 1.1	3.1
JA0	10	10.0	10.3	10.3	11.0	0.7 to 1.1	4.5

◆ PART NUMBERING SYSTEM

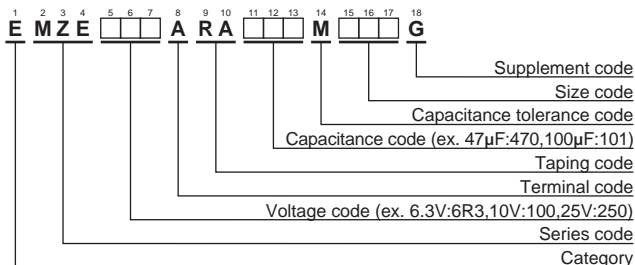

Please refer to "Product code guide (surface mount type)"

◆ MARKING

EX) 16V47μF



● Rated voltage symbol

Rated voltage (V _{dc})	6.3	10	16	25	35	50
Symbol	j	A	C	E	V	H



Alchip™-MZE Series

◆STANDARD RATINGS

WV (V _{dc})	Cap (μF)	Size code	Impedance (Ω max./20°C, 100kHz)	Rated ripple current (mA rms/105°C, 100kHz)	Part No.	WV (V _{dc})	Cap (μF)	Size code	Impedance (Ω max./20°C, 100kHz)	Rated ripple current (mA rms/105°C, 100kHz)	Part No.
6.3	47	E73	2.2	95	EMZE6R3ARA470ME73G	25	33	F73	1.1	140	EMZE250ARA330MF73G
	100	F73	1.1	140	EMZE6R3ARA101MF73G		47	F73	1.1	140	EMZE250ARA470MF73G
	220	F90	1.0	230	EMZE6R3ARA221MF90G		100	F90	1.0	230	EMZE250ARA101MF90G
	330	F90	1.0	230	EMZE6R3ARA331MF90G		220	HA0	0.22	600	EMZE250ARA221MHA0G
470	HA0	0.22	600	EMZE6R3ARA471MHA0G	330		JA0	0.16	850	EMZE250ARA331MJA0G	
10	33	E73	2.2	95	EMZE100ARA330ME73G	35	10	E73	2.2	95	EMZE350ARA100ME73G
	150	F73	1.1	140	EMZE100ARA151MF73G		10	F73	1.1	140	EMZE350ARA100MF73G
16	22	E73	2.2	95	EMZE160ARA220ME73G		22	E73	2.2	95	EMZE350ARA220ME73G
	47	F73	1.1	140	EMZE160ARA470MF73G		22	F73	1.1	140	EMZE350ARA220MF73G
	100	F73	1.1	140	EMZE160ARA101MF73G		33	F90	1.0	230	EMZE350ARA330MF90G
	150	F90	1.0	230	EMZE160ARA151MF90G		47	F90	1.0	230	EMZE350ARA470MF90G
	220	F90	1.0	230	EMZE160ARA221MF90G		100	HA0	0.22	600	EMZE350ARA101MHA0G
	330	HA0	0.22	600	EMZE160ARA331MHA0G		220	JA0	0.16	850	EMZE350ARA221MJA0G
25	470	JA0	0.16	850	EMZE160ARA471MJA0G	50	47	HA0	0.53	350	EMZE500ARA470MHA0G
	22	E73	2.2	95	EMZE250ARA220ME73G		100	JA0	0.35	670	EMZE500ARA101MJA0G

Production of the products shown in is scheduled to be discontinued.

◆RATED RIPPLE CURRENT MULTIPLIERS

● Frequency Multipliers

Capacitance(μF)	Frequency(Hz)			
	120	1k	10k	100k
10 to 150	0.40	0.75	0.90	1.00
220 to 470	0.50	0.85	0.94	1.00

The deterioration of aluminum electrolytic capacitors accelerates their life due to the internal heating produced by ripple current. For details, refer to Section "5-3 Ripple Current Effect on Lifetime" in the catalog, Technical Note.

Alchip™-MZK Series

- Endurance : 5,000 hours at 105°C
- Low impedance
- Rated voltage range : 6.3 to 35V
- Nominal capacitance range : 10 to 150μF
- Suitable for low profile products
- Solvent resistant type (see PRECAUTIONS AND GUIDELINES)
- RoHS2 Compliant

MVY → Longer life → **MZK**



◆ SPECIFICATIONS

Items	Characteristics					
Category	-25 to +105°C					
Temperature Range	-25 to +105°C					
Rated Voltage Range	6.3 to 35V _{dc}					
Capacitance Tolerance	±20%(M) (at 20°C, 120Hz)					
Leakage Current	I=0.01CV or 3μA, whichever is greater Where, I : Max. leakage current (μA), C : Nominal capacitance (μF), V : Rated voltage (V) (at 20°C, after 2 minutes)					
Dissipation Factor (tan δ)	Rated voltage (V _{dc})	6.3V	10V	16V	25V	35V
	tan δ (Max.)	0.32	0.28	0.26	0.16	0.14
Low Temperature Characteristics (Max. Impedance Ratio)	Rated voltage(V _{dc})	6.3V	10V	16V	25V	35V
	Z(-10°C)/Z(+20°C)	4	3	2	2	2
Endurance	The following specifications shall be satisfied when the capacitors are restored to 20°C after the rated voltage is applied for 5,000 hours at 105°C.					
	Capacitance change	≤ ±30% of the initial value				
	D.F. (tan δ)	≤300% of the initial specified value				
	Leakage current	≤The initial specified value				
Shelf Life	The following specifications shall be satisfied when the capacitors are restored to 20°C after exposing them for 1,000 hours at 105°C without voltage applied. Before the measurement, the capacitor shall be preconditioned by applying voltage according to Item 4.1 of JIS C 5101-4.					
	Capacitance change	≤ ±30% of the initial value				
	D.F. (tan δ)	≤300% of the initial specified value				
	Leakage current	≤The initial specified value				

◆ DIMENSIONS [mm]

● Terminal Code : A

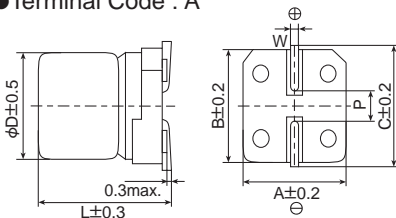

Size code	D	L	A	B	C	W	P
E61	5	5.8	5.3	5.3	5.9	0.5 to 0.8	1.4
F61	6.3	5.8	6.6	6.6	7.2	0.5 to 0.8	1.9

◆ PART NUMBERING SYSTEM

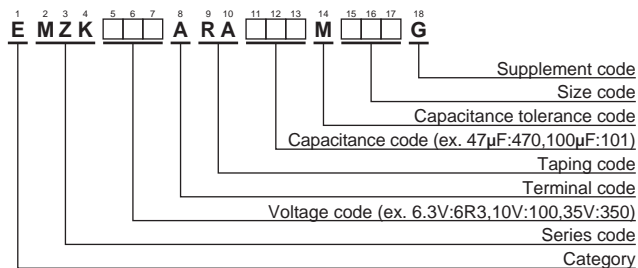

Please refer to "Product code guide (surface mount type)"

◆ MARKING

EX) 35V47μF



● Rated voltage symbol

Rated voltage (V _{dc})	6.3	10	16	25	35
Symbol	j	A	C	E	V



Alchip™ - **MZK** Series

◆ **STANDARD RATINGS**

WV (V _{dc})	Cap (µF)	Size code	Impedance (Ω max./20°C, 100kHz)	Rated ripple current (mA _{rms} /105°C, 100kHz)	Part No.
6.3	100	E61	2.2	95	EMZK6R3ARA101ME61G
10	150	F61	1.1	140	EMZK100ARA151MF61G
16	33	E61	2.2	95	EMZK160ARA330ME61G
	47	E61	2.2	95	EMZK160ARA470ME61G
	100	F61	1.1	140	EMZK160ARA101MF61G
25	68	F61	1.1	140	EMZK250ARA680MF61G
35	10	E61	2.2	95	EMZK350ARA100ME61G
	10	F61	1.1	140	EMZK350ARA100MF61G
	22	E61	2.2	95	EMZK350ARA220ME61G
	22	F61	1.1	140	EMZK350ARA220MF61G
	33	F61	1.1	140	EMZK350ARA330MF61G
	47	F61	1.1	140	EMZK350ARA470MF61G

◆ **RATED RIPPLE CURRENT MULTIPLIERS**

● Frequency Multipliers

Frequency(Hz)	120	1k	10k	100k
6.3 to 35V _{dc}	0.40	0.75	0.90	1.00

The deterioration of aluminum electrolytic capacitors accelerates their life due to the internal heating produced by ripple current. For details, refer to Section "5-3 Ripple Current Effect on Lifetime" in the catalog, Technical Note.

Alchip™-MLA Series

- Low impedance, long life
- Rated voltage 6.3 to 50V, Capacitance 10 to 1,000μF
- Case size φ5×5.8L to φ10×10L
- Suitable for applications requiring long life and low impedance such as equipment in continuous operation, industrial applications, etc.
- Solvent resistant type (see PRECAUTIONS AND GUIDELINES)
- RoHS2 Compliant

MVY → Longer life → **MLA**



◆ SPECIFICATIONS

Items	Characteristics							
Category	-40 to +105°C							
Temperature Range	-40 to +105°C							
Rated Voltage Range	6.3 to 50V _{dc}							
Capacitance Tolerance	±20%(M) (at 20°C, 120Hz)							
Leakage Current	I=0.01CV or 3μA, whichever is greater Where, I : Max. leakage current (μA), C : Nominal capacitance (μF), V : Rated voltage (V) (at 20°C after 2 minutes)							
Dissipation Factor (tan δ)	Rated voltage(V _{dc})	6.3V	10V	16V	25V	35V	50V	
	tan δ (Max.)	E61 to F61	0.28	0.24	0.22	0.16	0.13	0.12
		F80	0.32	0.27	0.24	0.16	0.13	0.12
		HA0 to JA0	0.28	0.24	0.22	0.16	0.13	0.12
Low Temperature Characteristics (Max. impedance Ratio)	Rated voltage(V _{dc})	6.3V	10V	16V	25V	35V	50V	
	Z(-25°C)/Z(+20°C)	4	3	2	2	2	2	
	Z(-40°C)/Z(+20°C)	10	7	5	3	3	3	
Endurance	The following specifications shall be satisfied when the capacitors are restored to 20°C after the rated voltage is applied for 3,000 hours at 105°C.							
	Capacitance change	≤ ±30% of the initial value						
	D.F. (tan δ)	≤300% of the initial specified value						
	Leakage current	≤The initial specified value						
Shelf life	The following specifications shall be satisfied when the capacitors are restored to 20°C after exposing them for 1,000 hours at 105°C without voltage applied. Before the measurement, the capacitor shall be preconditioned by applying voltage according to Item 4.1 of JIS C 5101-4.							
	Capacitance change	≤ ±30% of the initial value						
	D.F. (tan δ)	≤300% of the initial specified value						
	Leakage current	≤The initial specified value						

◆ DIMENSIONS [mm]

● Terminal Code : A

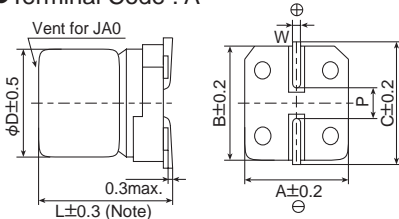

Note : L±0.5 for HA0 and JA0

Size code	D	L	A	B	C	W	P
E61	5	5.8	5.3	5.3	5.9	0.5 to 0.8	1.4
F61	6.3	5.8	6.6	6.6	7.2	0.5 to 0.8	1.9
F80	6.3	7.7	6.6	6.6	7.2	0.5 to 0.8	1.9
HA0	8	10.0	8.3	8.3	9.0	0.7 to 1.1	3.1
JA0	10	10.0	10.3	10.3	11.0	0.7 to 1.1	4.5

◆ MARKING

EX) 16V100μF



◆ PART NUMBERING SYSTEM

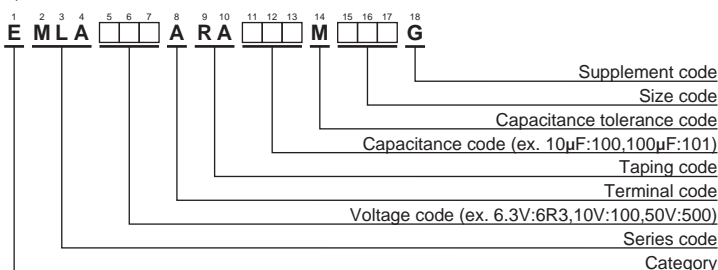

Please refer to "Product code guide (surface mount type)"

● Rated voltage symbol

Rated voltage (V _{dc})	Symbol
6.3	j
10	A
16	C
25	E
35	V
50	H



◆ **STANDARD RATINGS**

WV (V _{dc})	Cap (μF)	Size code	tan δ	Impedance (Ω max./20°C, 100kHz)	Rated ripple current (mA _{rms} /105°C, 100kHz)	Part No.	WV (V _{dc})	Cap (μF)	Size code	tan δ	Impedance (Ω max./20°C, 100kHz)	Rated ripple current (mA _{rms} /105°C, 100kHz)	Part No.
6.3	47	E61	0.28	1.30	95	EMLA6R3ARA470ME61G	25	33	F61	0.16	0.70	140	EMLA250ARA330MF61G
	100	F61	0.28	0.70	140	EMLA6R3ARA101MF61G		47	F61	0.16	0.70	140	EMLA250ARA470MF61G
	150	F61	0.28	0.70	140	EMLA6R3ARA151MF61G		47	F80	0.16	0.70	230	EMLA250ARA470MF80G
	220	F80	0.32	0.70	230	EMLA6R3ARA221MF80G		100	F80	0.16	0.70	230	EMLA250ARA101MF80G
	330	F80	0.32	0.70	230	EMLA6R3ARA331MF80G		100	HA0	0.16	0.16	600	EMLA250ARA101MHA0G
	330	HA0	0.28	0.16	600	EMLA6R3ARA331MHA0G		150	HA0	0.16	0.16	600	EMLA250ARA151MHA0G
	470	HA0	0.28	0.16	600	EMLA6R3ARA471MHA0G		220	HA0	0.16	0.16	600	EMLA250ARA221MHA0G
1,000	JA0	0.28	0.08	850	EMLA6R3ARA102MJA0G	330	HA0	0.16	0.16	600	EMLA250ARA331MHA0G		
10	33	E61	0.24	1.30	95	EMLA100ARA330ME61G	330	JA0	0.16	0.08	850	EMLA250ARA331MJA0G	
	47	F61	0.24	0.70	140	EMLA100ARA470MF61G	470	JA0	0.16	0.08	850	EMLA250ARA471MJA0G	
	100	F61	0.24	0.70	140	EMLA100ARA101MF61G	35	10	E61	0.13	1.30	95	EMLA350ARA100ME61G
	150	F61	0.24	0.70	140	EMLA100ARA151MF61G		22	F61	0.13	0.70	140	EMLA350ARA220MF61G
	220	F80	0.27	0.70	230	EMLA100ARA221MF80G		33	F61	0.13	0.70	140	EMLA350ARA330MF61G
	220	HA0	0.24	0.16	600	EMLA100ARA221MHA0G		33	F80	0.13	0.70	230	EMLA350ARA330MF80G
	330	HA0	0.24	0.16	600	EMLA100ARA331MHA0G		47	F80	0.13	0.70	230	EMLA350ARA470MF80G
470	HA0	0.24	0.16	600	EMLA100ARA471MHA0G	100		F80	0.13	0.70	230	EMLA350ARA101MF80G	
22	E61	0.22	1.30	95	EMLA160ARA220ME61G	100		HA0	0.13	0.16	600	EMLA350ARA101MHA0G	
33	F61	0.22	0.70	140	EMLA160ARA330MF61G	150	HA0	0.13	0.16	600	EMLA350ARA151MHA0G		
47	F61	0.22	0.70	140	EMLA160ARA470MF61G	220	HA0	0.13	0.16	600	EMLA350ARA221MHA0G		
100	F61	0.22	0.70	140	EMLA160ARA101MF61G	220	JA0	0.13	0.08	850	EMLA350ARA221MJA0G		
100	F80	0.24	0.70	230	EMLA160ARA101MF80G	330	JA0	0.13	0.08	850	EMLA350ARA331MJA0G		
150	F80	0.24	0.70	230	EMLA160ARA151MF80G	50	10	F61	0.12	2.00	70	EMLA500ARA100MF61G	
220	F80	0.24	0.70	230	EMLA160ARA221MF80G		22	F61	0.12	2.00	70	EMLA500ARA220MF61G	
220	HA0	0.22	0.16	600	EMLA160ARA221MHA0G		33	F80	0.12	1.60	100	EMLA500ARA330MF80G	
330	HA0	0.22	0.16	600	EMLA160ARA331MHA0G		47	F80	0.12	1.60	100	EMLA500ARA470MF80G	
470	HA0	0.22	0.16	600	EMLA160ARA471MHA0G		47	HA0	0.12	0.34	350	EMLA500ARA470MHA0G	
470	JA0	0.22	0.08	850	EMLA160ARA471MJA0G		100	HA0	0.12	0.34	350	EMLA500ARA101MHA0G	
10	E61	0.16	1.30	95	EMLA250ARA100ME61G		100	JA0	0.12	0.18	670	EMLA500ARA101MJA0G	
22	E61	0.16	1.30	95	EMLA250ARA220ME61G	150	JA0	0.12	0.18	670	EMLA500ARA151MJA0G		
22	F61	0.16	0.70	140	EMLA250ARA220MF61G	220	JA0	0.12	0.18	670	EMLA500ARA221MJA0G		

◆ **RATED RIPPLE CURRENT MULTIPLIERS**

⊙ Frequency Multipliers

Capacitance(μF)	Frequency(Hz)	120	1k	10k	100k
10 to 150		0.40	0.75	0.90	1.00
220 to 470		0.50	0.85	0.94	1.00
1,000		0.60	0.87	0.95	1.00

The deterioration of aluminum electrolytic capacitors accelerates their life due to the internal heating produced by ripple current. For details, refer to Section "5-3 Ripple Current Effect on Lifetime" in the catalog, Technical Note.

Alchip™-MLF Series

- Endurance : 10,000 hours at 105°C
- Rated voltage range : 6.3 to 50V
- Nominal capacitance range : 1.0 to 1,000μF
- Suitable for long life and low profile products
- Solvent resistant type (see PRECAUTIONS AND GUIDELINES)
- RoHS2 Compliant



◆ SPECIFICATIONS

Items	Characteristics						
Category	-25 to +105°C						
Temperature Range	-25 to +105°C						
Rated Voltage Range	6.3 to 50V _{dc}						
Capacitance Tolerance	±20%(M) (at 20°C, 120Hz)						
Leakage Current	I=0.03CV or 4μA, whichever is greater Where, I : Max. leakage current (μA), C : Nominal capacitance (μF), V : Rated voltage (V) (at 20°C, after 2 minutes)						
Dissipation Factor (tan δ)	Rated voltage (V _{dc})	6.3V	10V	16V	25V	35V	50V
	tan δ (Max.)	0.32	0.28	0.26	0.16	0.14	0.14
Low Temperature Characteristics (Max. Impedance Ratio)	Rated voltage(V _{dc})	6.3V	10V	16V	25V	35V	50V
	Z(-10°C)/Z(+20°C)	4	3	2	2	2	2
Endurance	The following specifications shall be satisfied when the capacitors are restored to 20°C after the rated voltage is applied for 10,000 hours at 105°C.						
	Capacitance change	≤ ±30% of the initial value					
	D.F. (tan δ)	≤300% of the initial specified value					
	Leakage current	≤The initial specified value					
Shelf Life	The following specifications shall be satisfied when the capacitors are restored to 20°C after exposing them for 1,000 hours at 105°C without voltage applied. Before the measurement, the capacitor shall be preconditioned by applying voltage according to Item 4.1 of JIS C 5101-4.						
	Capacitance change	≤ ±30% of the initial value					
	D.F. (tan δ)	≤300% of the initial specified value					
	Leakage current	≤The initial specified value					

◆ DIMENSIONS [mm]

● Terminal Code : A

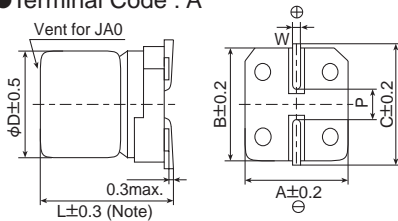

Note : L±0.3 for HA0 and JA0

Size code	D	L	A	B	C	W	P
D73	4	7.0	4.3	4.3	5.1	0.5 to 0.8	1.0
E73	5	7.0	5.3	5.3	5.9	0.5 to 0.8	1.4
F73	6.3	7.0	6.6	6.6	7.2	0.5 to 0.8	1.9
F90	6.3	8.7	6.6	6.6	7.2	0.5 to 0.8	1.9
HA0	8	10.0	8.3	8.3	9.0	0.7 to 1.1	3.1
JA0	10	10.0	10.3	10.3	11.0	0.7 to 1.1	4.5

◆ PART NUMBERING SYSTEM

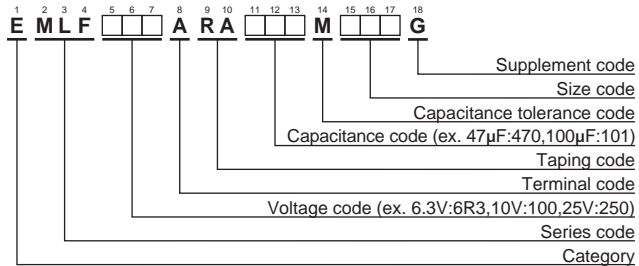

Please refer to "Product code guide (surface mount type)"

◆ MARKING

EX) 16V47μF



● Rated voltage symbol

Rated voltage (V _{dc})	6.3	10	16	25	35	50
Symbol	j	A	C	E	V	H



Alchip™-**MLF** Series

◆ **STANDARD RATINGS**

WV (V _{dc})	Cap (μF)	Size code	Rated ripple current (mA _{rms} /105°C, 120Hz)	Part No.	WV (V _{dc})	Cap (μF)	Size code	Rated ripple current (mA _{rms} /105°C, 120Hz)	Part No.
6.3	22	D73	22	EMLF6R3ARA220MD73G	35	1.0	D73	6.2	EMLF350ARA1R0MD73G
	47	E73	36	EMLF6R3ARA470ME73G		2.2	D73	11	EMLF350ARA2R2MD73G
	100	F73	60	EMLF6R3ARA101MF73G		3.3	D73	14	EMLF350ARA3R3MD73G
	220	F90	101	EMLF6R3ARA221MF90G		4.7	D73	15	EMLF350ARA4R7MD73G
	330	HA0	160	EMLF6R3ARA331MHA0G		4.7	E73	19	EMLF350ARA4R7ME73G
1,000	JA0	313	EMLF6R3ARA102MJA0G	10		E73	25	EMLF350ARA100ME73G	
10	33	E73	35	EMLF100ARA330ME73G		10	F73	30	EMLF350ARA100MF73G
	220	HA0	141	EMLF100ARA221MHA0G		22	F73	42	EMLF350ARA220MF73G
16	10	D73	18	EMLF160ARA100MD73G		22	F90	49	EMLF350ARA220MF90G
	22	E73	30	EMLF160ARA220ME73G		33	F90	57	EMLF350ARA330MF90G
	47	F73	50	EMLF160ARA470MF73G	220	JA0	216	EMLF350ARA221MJA0G	
	100	F90	81	EMLF160ARA101MF90G	50	33	HA0	77	EMLF500ARA330MHA0G
470	JA0	254	EMLF160ARA471MJA0G	47		HA0	92	EMLF500ARA470MHA0G	
33	F73	48	EMLF250ARA330MF73G	100		JA0	151	EMLF500ARA101MJA0G	
25	47	F90	63	EMLF250ARA470MF90G					
	100	HA0	116	EMLF250ARA101MHA0G					

Production of the products shown in is scheduled to be discontinued.

◆ **RATED RIPPLE CURRENT MULTIPLIERS**

⊙ Frequency Multipliers

Capacitance(μF)	Frequency(Hz)			
	120	1k	10k	100k
1.0	1.00	1.50	1.75	1.80
2.2 to 10	1.00	1.30	1.40	1.50
22 to 1,000	1.00	1.05	1.08	1.08

The deterioration of aluminum electrolytic capacitors accelerates their life due to the internal heating produced by ripple current. For details, refer to Section "5-3 Ripple Current Effect on Lifetime" in the catalog, Technical Note.



Alchip™-MLE Series

- Endurance : 7,000 to 8,000 hours at 105°C
- Rated voltage range : 6.3 to 50V
- Nominal capacitance range : 1.0 to 1,000μF
- Suitable for long life and low profile products
- Solvent resistant type (see PRECAUTIONS AND GUIDELINES)
- RoHS2 Compliant

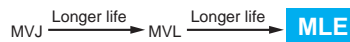

◆ SPECIFICATIONS

Items	Characteristics						
Category	-25 to +105°C						
Temperature Range							
Rated Voltage Range	6.3 to 50V _{dc}						
Capacitance Tolerance	±20%(M) (at 20°C, 120Hz)						
Leakage Current	I=0.03CV or 4μA, whichever is greater Where, I : Max. leakage current (μA), C : Nominal capacitance (μF), V : Rated voltage (V) (at 20°C, after 2 minutes)						
Dissipation Factor (tan δ)	Rated voltage (V _{dc})	6.3V	10V	16V	25V	35V	50V
	tan δ (Max.)	0.32	0.28	0.26	0.16	0.14	0.14
Low Temperature Characteristics (Max. Impedance Ratio)	Rated voltage(V _{dc})	6.3V	10V	16V	25V	35V	50V
	Z(-10°C)/Z(+20°C)	4	3	2	2	2	2
Endurance	The following specifications shall be satisfied when the capacitors are restored to 20°C after the rated voltage is applied for specified time at 105°C.						
	Time	D73 to F73 : 7,000 hours F90 to JA0 : 8,000 hours					
	Capacitance change	≤ ±30% of the initial value					
	D.F. (tan δ)	≤300% of the initial specified value					
	Leakage current	≤The initial specified value					
Shelf Life	The following specifications shall be satisfied when the capacitors are restored to 20°C after exposing them for 1,000 hours at 105°C without voltage applied. Before the measurement, the capacitor shall be preconditioned by applying voltage according to Item 4.1 of JIS C 5101-4.						
	Capacitance change	≤ ±30% of the initial value					
	D.F. (tan δ)	≤300% of the initial specified value					
	Leakage current	≤The initial specified value					

◆ DIMENSIONS [mm]

- Terminal Code : A

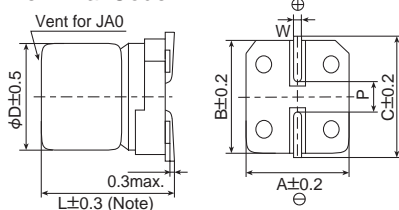

Size code	D	L	A	B	C	W	P
D73	4	7.0	4.3	4.3	5.1	0.5 to 0.8	1.0
E73	5	7.0	5.3	5.3	5.9	0.5 to 0.8	1.4
F73	6.3	7.0	6.6	6.6	7.2	0.5 to 0.8	1.9
F90	6.3	8.7	6.6	6.6	7.2	0.5 to 0.8	1.9
HA0	8	10.0	8.3	8.3	9.0	0.7 to 1.1	3.1
JA0	10	10.0	10.3	10.3	11.0	0.7 to 1.1	4.5

◆ PART NUMBERING SYSTEM

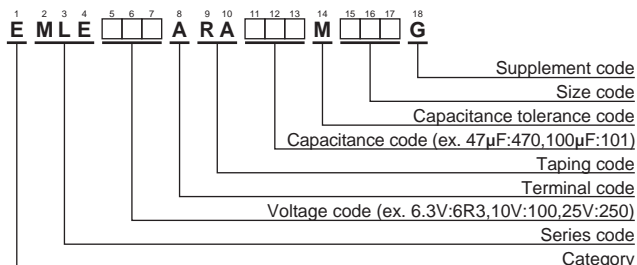

Please refer to "Product code guide (surface mount type)"

◆ MARKING

EX) 16V47μF



- Rated voltage symbol

Rated voltage (V _{dc})	6.3	10	16	25	35	50
Symbol	j	A	C	E	V	H



Alchip™-**MLE**Series

◆ **STANDARD RATINGS**

WV (V _{ac})	Cap (μF)	Size code	Rated ripple current (mA _{RMS} /105°C, 120Hz)	Part No.	WV (V _{ac})	Cap (μF)	Size code	Rated ripple current (mA _{RMS} /105°C, 120Hz)	Part No.	
6.3	22	D73	22	EMLE6R3ARA220MD73G	35	1.0	D73	6.2	EMLE350ARA1R0MD73G	
	47	E73	36	EMLE6R3ARA470ME73G		2.2	D73	11	EMLE350ARA2R2MD73G	
	100	F73	60	EMLE6R3ARA101MF73G		3.3	D73	14	EMLE350ARA3R3MD73G	
	220	F90	101	EMLE6R3ARA221MF90G		4.7	D73	15	EMLE350ARA4R7MD73G	
	330	HA0	160	EMLE6R3ARA331MHA0G		4.7	E73	19	EMLE350ARA4R7ME73G	
	1,000	JA0	313	EMLE6R3ARA102MJA0G		10	E73	25	EMLE350ARA100ME73G	
10	33	E73	35	EMLE100ARA330ME73G		10	F73	30	EMLE350ARA100MF73G	
	220	HA0	141	EMLE100ARA221MHA0G		22	F73	42	EMLE350ARA220MF73G	
16	10	D73	18	EMLE160ARA100MD73G		22	F90	49	EMLE350ARA220MF90G	
	22	E73	30	EMLE160ARA220ME73G		33	F90	57	EMLE350ARA330MF90G	
	47	F73	50	EMLE160ARA470MF73G		220	JA0	216	EMLE350ARA221MJA0G	
	100	F90	81	EMLE160ARA101MF90G		50	33	HA0	77	EMLE500ARA330MHA0G
	470	JA0	254	EMLE160ARA471MJA0G			47	HA0	92	EMLE500ARA470MHA0G
33	F73	48	EMLE250ARA330MF73G	100			JA0	151	EMLE500ARA101MJA0G	
25	47	F90	63	EMLE250ARA470MF90G						
	100	HA0	116	EMLE250ARA101MHA0G						

Production of the products shown in is scheduled to be discontinued.

◆ **RATED RIPPLE CURRENT MULTIPLIERS**

● Frequency Multipliers

Capacitance(μF)	Frequency(Hz)	120	1k	10k	100k
1.0		1.00	1.50	1.75	1.80
2.2 to 10		1.00	1.30	1.40	1.50
22 to 1,000		1.00	1.05	1.08	1.08

The deterioration of aluminum electrolytic capacitors accelerates their life due to the internal heating produced by ripple current. For details, refer to Section "5-3 Ripple Current Effect on Lifetime" in the catalog, Technical Note.

Alchip™-MLK Series

- 6.1mm height
- Endurance : 5,000 hours at 105°C
- Rated voltage range : 6.3 to 35V
- Nominal capacitance range : 4.7 to 100μF
- Suitable to fit for downsized equipment
- Solvent resistant type (see PRECAUTIONS AND GUIDELINES)
- RoHS2 Compliant

MVL $\xrightarrow{\text{Longer life}}$ **MLK**



◆ SPECIFICATIONS

Items	Characteristics					
Category	-25 to +105°C					
Temperature Range	-25 to +105°C					
Rated Voltage Range	6.3 to 35V _{dc}					
Capacitance Tolerance	±20%(M) (at 20°C, 120Hz)					
Leakage Current	I=0.03CV or 4μA, whichever is greater Where, I : Max. leakage current (μA), C : Nominal capacitance (μF), V : Rated voltage (V) (at 20°C, after 2 minutes)					
Dissipation Factor (tan δ)	Rated voltage (V _{dc})	6.3V	10V	16V	25V	35V
	tan δ (Max.)	0.32	0.28	0.26	0.16	0.14
Low Temperature Characteristics (Max. Impedance Ratio)	Rated voltage(V _{dc})	6.3V	10V	16V	25V	35V
	Z(-10°C)/Z(+20°C)	4	3	2	2	2
Endurance	The following specifications shall be satisfied when the capacitors are restored to 20°C after the rated voltage is applied for 5,000 hours at 105°C.					
	Capacitance change	≤ ±30% of the initial value				
	D.F. (tan δ)	≤ 300% of the initial specified value				
	Leakage current	≤ The initial specified value				
Shelf Life	The following specifications shall be satisfied when the capacitors are restored to 20°C after exposing them for 1,000 hours at 105°C without voltage applied. Before the measurement, the capacitor shall be preconditioned by applying voltage according to Item 4.1 of JIS C 5101-4.					
	Capacitance change	≤ ±30% of the initial value				
	D.F. (tan δ)	≤ 300% of the initial specified value				
	Leakage current	≤ The initial specified value				

◆ DIMENSIONS [mm]

● Terminal Code : A

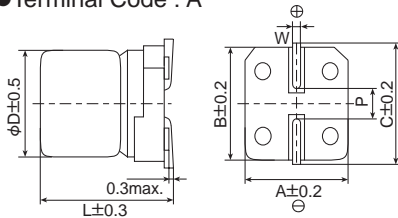

Size code	D	L	A	B	C	W	P
E61	5	5.8	5.3	5.3	5.9	0.5 to 0.8	1.4
F61	6.3	5.8	6.6	6.6	7.2	0.5 to 0.8	1.9

◆ PART NUMBERING SYSTEM

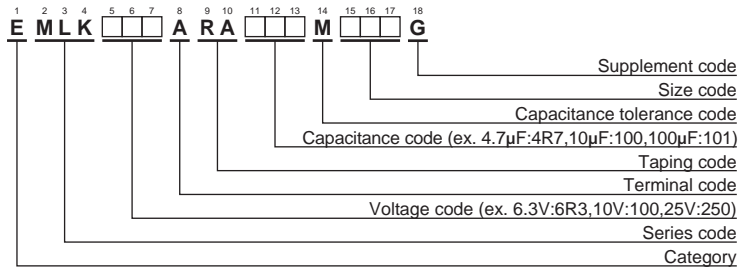

Please refer to "Product code guide (surface mount type)"

◆ MARKING

EX) 35V10μF

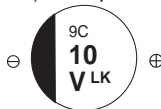

● Rated voltage symbol

Rated voltage (V _{dc})	6.3	10	16	25	35
Symbol	j	A	C	E	V

◆ STANDARD RATINGS

WV (V _{dc})	Cap (μF)	Size code	tan δ	Rated ripple current (mA _{rms} /105°C, 120Hz)	Part No.
6.3	47	E61	0.32	36	EMLK6R3ARA470ME61G
	100	F61	0.32	60	EMLK6R3ARA101MF61G
10	33	E61	0.28	35	EMLK100ARA330ME61G
16	22	E61	0.26	30	EMLK160ARA220ME61G
	47	F61	0.26	50	EMLK160ARA470MF61G
25	33	F61	0.16	48	EMLK250ARA330MF61G
35	4.7	E61	0.14	19	EMLK350ARA4R7ME61G
	10	E61	0.14	25	EMLK350ARA100ME61G
	10	F61	0.14	30	EMLK350ARA100MF61G
	22	F61	0.14	42	EMLK350ARA220MF61G

◆ RATED RIPPLE CURRENT MULTIPLIERS

● Frequency Multipliers

Frequency(Hz)	120	1k	10k	100k
6.3 to 35V _{dc}	1.00	1.05	1.08	1.08

The deterioration of aluminum electrolytic capacitors accelerates their life due to the internal heating produced by ripple current. For details, refer to Section "5-3 Ripple Current Effect on Lifetime" in the catalog, Technical Note.



Alchip™-MVL Series



Longer life

MVJ



- Endurance : 3,000 to 5,000 hours at 105°C
- Suitable for applications requiring long life such as continuously operating equipment, industrial applications, etc
- Solvent resistant type (see PRECAUTIONS AND GUIDELINES)
- RoHS2 Compliant

◆ SPECIFICATIONS

Items	Characteristics						
Category Temperature Range	-40 to +105°C						
Rated Voltage Range	6.3 to 50V _{dc}						
Capacitance Tolerance	±20%(M) (at 20°C,120Hz)						
Leakage Current	I=0.03CV or 4μA, whichever is greater Where, I : Max. leakage current (μA), C : Nominal capacitance (μF), V : Rated voltage (V) (at 20°C, after 2 minutes)						
Dissipation Factor (tan δ)	Rated voltage (V _{dc})	6.3V	10V	16V	25V	35V	50V
	Max. tan δ	0.28	0.24	0.20	0.16	0.13	0.12
Low Temperature Characteristics (Max. impedance Ratio)	Rated voltage(V _{dc})	6.3V	10V	16V	25V	35V	50V
	Z(-25°C)/Z(+20°C)	4	3	2	2	2	2
	Z(-40°C)/Z(+20°C)	10	7	5	3	3	3
Endurance	The following specifications shall be satisfied when the capacitors are restored to 20°C after the rated voltage is applied for specified time at 105°C.						
	Time	D60 to F80 : 3,000 hours HA0 & JA0 : 5,000 hours					
	Capacitance change	≤ ±30% of the initial value					
	D.F. (tan δ)	≤300% of the initial specified value					
	Leakage current	≤The initial specified value					
Shelf Life	The following specifications shall be satisfied when the capacitors are restored to 20°C after exposing them for 1,000 hours at 105°C without voltage applied. Before the measurement, the capacitor shall be preconditioned by applying voltage according to Item 4.1 of JIS C 5101-4.						
	Capacitance change	≤ ±30% of the initial value					
	D.F. (tan δ)	≤300% of the initial specified value					
	Leakage current	≤The initial specified value					

◆ DIMENSIONS [mm]

● Terminal Code : A

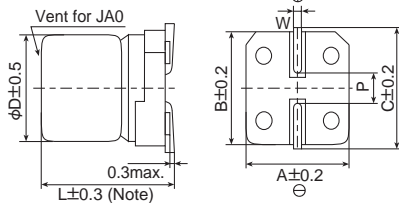

Note : L±0.5 for HA0 and JA0

Size code	D	L	A	B	C	W	P
D60	4	5.7	4.3	4.3	5.1	0.5 to 0.8	1.0
E60	5	5.7	5.3	5.3	5.9	0.5 to 0.8	1.4
F60	6.3	5.7	6.6	6.6	7.2	0.5 to 0.8	1.9
F80	6.3	7.7	6.6	6.6	7.2	0.5 to 0.8	1.9
HA0	8	10.0	8.3	8.3	9.0	0.7 to 1.1	3.1
JA0	10	10.0	10.3	10.3	11.0	0.7 to 1.1	4.5

◆ PART NUMBERING SYSTEM

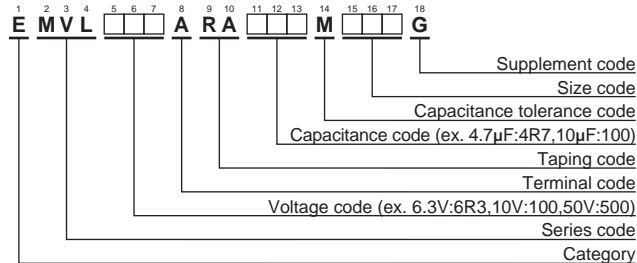

Please refer to "Product code guide (surface mount type)"

◆ MARKING

EX) 16V47μF





Alchip™-**MVL**Series

◆ **STANDARD RATINGS**

WV (V _{dc})	Cap (μF)	Size code	tan δ	Rated ripple current (mA _{rms} /105°C, 120Hz)	Part No.	WV (V _{dc})	Cap (μF)	Size code	tan δ	Rated ripple current (mA _{rms} /105°C, 120Hz)	Part No.
6.3	22	D60	0.28	22	EMVL6R3ARA220MD60G	35	4.7	D60	0.13	15	EMVL350ARA4R7MD60G
	47	E60	0.28	36	EMVL6R3ARA470ME60G		10	E60	0.13	25	EMVL350ARA100ME60G
	100	F60	0.28	60	EMVL6R3ARA101MF60G		22	F60	0.13	42	EMVL350ARA220MF60G
	220	F80	0.28	101	EMVL6R3ARA221MF80G		33	F80	0.13	57	EMVL350ARA330MF80G
	330	HA0	0.28	160	EMVL6R3ARA331MHA0G		220	JA0	0.13	216	EMVL350ARA221MJA0G
10	1,000	JA0	0.28	313	EMVL6R3ARA102MJA0G	50	1.0	D60	0.12	6.2	EMVL500ARA1R0MD60G
	33	E60	0.24	35	EMVL100ARA330ME60G		2.2	D60	0.12	11	EMVL500ARA2R2MD60G
220	HA0	0.24	141	EMVL100ARA221MHA0G	3.3		D60	0.12	14	EMVL500ARA3R3MD60G	
16	10	D60	0.20	18	EMVL160ARA100MD60G		4.7	E60	0.12	19	EMVL500ARA4R7ME60G
	22	E60	0.20	30	EMVL160ARA220ME60G		10	F60	0.12	30	EMVL500ARA100MF60G
	47	F60	0.20	50	EMVL160ARA470MF60G		22	F80	0.12	49	EMVL500ARA220MF80G
	100	F80	0.20	81	EMVL160ARA101MF80G		33	HA0	0.12	77	EMVL500ARA330MHA0G
	470	JA0	0.20	254	EMVL160ARA471MJA0G	47	HA0	0.12	92	EMVL500ARA470MHA0G	
25	33	F60	0.16	48	EMVL250ARA330MF60G	100	JA0	0.12	151	EMVL500ARA101MJA0G	
	47	F80	0.16	63	EMVL250ARA470MF80G						
	100	HA0	0.16	116	EMVL250ARA101MHA0G						
	330	JA0	0.16	238	EMVL250ARA331MJA0G						

Production of the products shown in is scheduled to be discontinued.

◆ **RATED RIPPLE CURRENT MULTIPLIERS**

● Frequency Multipliers

Capacitance(μF)	Frequency(Hz)			
	120	1k	10k	100k
1.0	1.00	1.50	1.75	1.80
2.2 to 10	1.00	1.30	1.40	1.50
22 to 1,000	1.00	1.05	1.08	1.08

The deterioration of aluminum electrolytic capacitors accelerates their life due to the internal heating produced by ripple current. For details, refer to Section "5-3 Ripple Current Effect on Lifetime" in the catalog, Technical Note.

Alchip™-MVJ Series

- Endurance : 2,000 hours at 105°C
- Solvent resistant type (see PRECAUTIONS AND GUIDELINES)
- RoHS2 Compliant

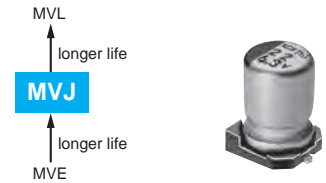

◆ SPECIFICATIONS

Items	Characteristics						
Category Temperature Range	-40 to +105°C						
Rated Voltage Range	6.3 to 50V _{dc}						
Capacitance Tolerance	±20% (M) (at 20°C, 120Hz)						
Leakage Current	I=0.01CV or 3μA, whichever is greater. Where, I : Max. leakage current (μA), C : Nominal capacitance (μF), V : Rated voltage (V) (at 20°C after 2 minutes)						
Dissipation Factor (tan δ)	Rated voltage (V _{dc})	6.3V	10V	16V	25V	35V	50V
	tan δ (Max.)	0.30	0.24	0.20	0.16	0.14	0.12
Low Temperature Characteristics (Max. Impedance Ratio)	Rated voltage (V _{dc})	6.3V	10V	16V	25V	35V	50V
	Z(-25°C)/Z(+20°C)	4	3	2	2	2	2
	Z(-40°C)/Z(+20°C)	12	8	6	4	3	3
Endurance	The following specifications shall be satisfied when the capacitors are restored to 20°C after the rated voltage is applied for 2,000 hours at 105°C.						
	Rated voltage	6.3V _{dc}		10 & 16V _{dc}		25 to 50V _{dc}	
	Capacitance change	≤ ±30% of the initial value		≤ ±25% of the initial value		≤ ±20% of the initial value	
	D.F. (tan δ)	≤ 300% of the initial specified value		≤ 300% of the initial specified value		≤ 200% of the initial specified value	
	Leakage current	≤ The initial specified value		≤ The initial specified value		≤ The initial specified value	
Shelf Life	The following specifications shall be satisfied when the capacitors are restored to 20°C after exposing them for 1,000 hours at 105°C without voltage applied. Before the measurement, the capacitor shall be preconditioned by applying voltage according to Item 4.1 of JIS C 5101-4.						
	Rated voltage	6.3V _{dc}		10 & 16V _{dc}		25 to 50V _{dc}	
	Capacitance change	≤ ±30% of the initial value		≤ ±25% of the initial value		≤ ±20% of the initial value	
	D.F. (tan δ)	≤ 300% of the initial specified value		≤ 300% of the initial specified value		≤ 200% of the initial specified value	
	Leakage current	≤ The initial specified value		≤ The initial specified value		≤ The initial specified value	

◆ DIMENSIONS [mm]

● Terminal Code : A

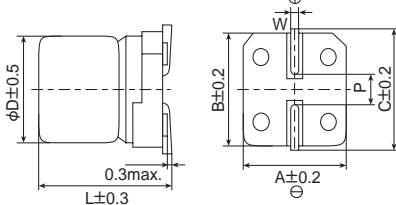

Size code	D	L	A	B	C	W	P
D60	4	5.7	4.3	4.3	5.1	0.5 to 0.8	1.0
E60	5	5.7	5.3	5.3	5.9	0.5 to 0.8	1.4
F60	6.3	5.7	6.6	6.6	7.2	0.5 to 0.8	1.9

◆ PART NUMBERING SYSTEM

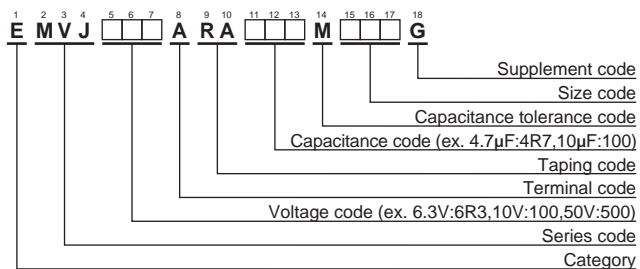

Please refer to "Product code guide (surface mount type)"

◆ MARKING

EX) 6.3V100μF



◆ STANDARD RATINGS

WV (V _{dc})	Cap (μF)	Size code	tan δ	Rated ripple current (mArms/105°C,120Hz)	Part No.	WV (V _{dc})	Cap (μF)	Size code	tan δ	Rated ripple current (mArms/105°C,120Hz)	Part No.
6.3	22	D60	0.30	21	EMVJ6R3ARA220MD60G	35	4.7	D60	0.14	15	EMVJ350ARA4R7MD60G
	47	E60	0.30	36	EMVJ6R3ARA470ME60G		10	E60	0.14	25	EMVJ350ARA100ME60G
	100	F60	0.30	56	EMVJ6R3ARA101MF60G		22	F60	0.14	40	EMVJ350ARA220MF60G
10	33	E60	0.24	34	EMVJ100ARA330ME60G	50	1.0	D60	0.12	5.6	EMVJ500ARA1R0MD60G
16	10	D60	0.20	16	EMVJ160ARA100MD60G		2.2	D60	0.12	10	EMVJ500ARA2R2MD60G
	22	E60	0.20	30	EMVJ160ARA220ME60G		3.3	D60	0.12	14	EMVJ500ARA3R3MD60G
	47	F60	0.20	48	EMVJ160ARA470MF60G		4.7	E60	0.12	19	EMVJ500ARA4R7ME60G
25	33	F60	0.16	45	EMVJ250ARA330MF60G		10	F60	0.12	29	EMVJ500ARA100MF60G

Production of the products shown in [] is scheduled to be discontinued.

◆ RATED RIPPLE CURRENT MULTIPLIERS

● Frequency Multipliers

Capacitance(μF)	Frequency(Hz)			
	120	1k	10k	100k
1.0	1.00	1.50	1.75	1.80
2.2 to 10	1.00	1.30	1.40	1.50
22 to 100	1.00	1.05	1.08	1.08

The deterioration of aluminum electrolytic capacitors accelerates their life due to the internal heating produced by ripple current. For details, refer to Section "5-3 Ripple Current Effect on Lifetime" in the catalog, Technical Note.

Product specifications in this catalog are subject to change without notice. Request our product specifications before purchase and/or use. Please use our products based on the information contained in this catalog and product specifications.



Alchip™-**MHS** Upgrade!
Series

◆ **STANDARD RATINGS**

WV (V _{dc})	Cap (μF)	Size code	ESR (Ω max./100kHz)		Rated ripple current (mArms/125°C, 100kHz)	Part No.
			20°C	-40°C		
16	680	HA0	0.19	2.6	620	EMHS160□RA681MHA0G
	1,000	JA0	0.13	1.7	780	EMHS160□RA102MJA0G
	1,500	KE0	0.087	1.1	1,060	EMHS160□RA152MKE0S
	2,000	KG5	0.070	0.84	1,160	EMHS160□RA202MKG5S
	2,700	LH0	0.057	0.59	1,900	EMHS160□RA272MLH0S
	3,600	MH0	0.055	0.44	2,000	EMHS160□RA362MMH0S
	4,700	LN0	0.037	0.39	2,520	EMHS160□RA472MLN0S
	6,200	MN0	0.036	0.28	2,570	EMHS160□RA622MMN0S
25	470	HA0	0.19	2.6	620	EMHS250□RA471MHA0G
	680	JA0	0.13	1.7	780	EMHS250□RA681MJA0G
	1,000	KE0	0.087	1.1	1,060	EMHS250□RA102MKE0S
	1,300	KG5	0.070	0.84	1,160	EMHS250□RA132MKG5S
	1,800	LH0	0.057	0.59	1,900	EMHS250□RA182MLH0S
	2,400	MH0	0.055	0.44	2,000	EMHS250□RA242MMH0S
	3,300	LN0	0.037	0.39	2,520	EMHS250□RA332MLN0S
	4,300	MN0	0.036	0.28	2,570	EMHS250□RA432MMN0S
35	220	HA0	0.19	2.6	620	EMHS350□RA221MHA0G
	270	HA0	0.19	2.6	620	EMHS350□RA271MHA0G
	470	JA0	0.13	1.7	780	EMHS350□RA471MJA0G
	680	KE0	0.087	1.1	1,060	EMHS350□RA681MKE0S
	820	KG5	0.070	0.84	1,160	EMHS350□RA821MKG5S
	1,200	LH0	0.057	0.59	1,900	EMHS350□RA122MLH0S
	1,500	MH0	0.055	0.44	2,000	EMHS350□RA152MMH0S
	2,000	LN0	0.037	0.39	2,520	EMHS350□RA202MLN0S
	2,400	MN0	0.036	0.28	2,570	EMHS350□RA242MMN0S
50	100	HA0	0.65	8.1	440	EMHS500□RA101MHA0G
	150	JA0	0.45	4.6	600	EMHS500□RA151MJA0G
	180	JA0	0.45	4.6	600	EMHS500□RA181MJA0G
	360	KE0	0.16	2.0	880	EMHS500□RA361MKE0S
	470	KG5	0.12	1.5	970	EMHS500□RA471MKG5S
	560	LH0	0.088	0.94	1,640	EMHS500□RA561MLH0S
	750	MH0	0.085	0.78	1,720	EMHS500□RA751MMH0S
	1,000	LN0	0.056	0.61	2,230	EMHS500□RA102MLN0S
	1,300	MN0	0.053	0.45	2,300	EMHS500□RA132MMN0S
63	68	HA0	0.65	8.1	440	EMHS630□RA680MHA0G
	82	HA0	0.65	8.1	440	EMHS630□RA820MHA0G
	100	JA0	0.45	4.6	600	EMHS630□RA101MJA0G
	120	JA0	0.45	4.6	600	EMHS630□RA121MJA0G
	240	KE0	0.17	2.5	920	EMHS630□RA241MKE0S
	330	KG5	0.13	1.8	1,030	EMHS630□RA331MKG5S
	430	LH0	0.098	1.3	1,640	EMHS630□RA431MLH0S
	560	MH0	0.091	0.98	1,720	EMHS630□RA561MMH0S
	680	LN0	0.063	0.80	2,230	EMHS630□RA681MLN0S
	910	MN0	0.059	0.59	2,300	EMHS630□RA911MMN0S
	1,000	MN0	0.059	0.59	2,300	EMHS630□RA102MMN0S
	1,100	MN0	0.059	0.59	2,300	EMHS630□RA112MMN0S
1,300	MN0	0.059	0.59	2,300	EMHS630□RA132MMN0S	
80	47	HA0	0.65	8.1	440	EMHS800□RA470MHA0G
	68	JA0	0.45	4.6	600	EMHS800□RA680MJA0G
	82	JA0	0.45	4.6	600	EMHS800□RA820MJA0G
	180	KE0	0.17	2.5	920	EMHS800□RA181MKE0S
	240	KG5	0.13	1.8	1,030	EMHS800□RA241MKG5S
	270	LH0	0.098	1.3	1,640	EMHS800□RA271MLH0S
	360	MH0	0.091	0.98	1,720	EMHS800□RA361MMH0S
	430	LN0	0.063	0.80	2,230	EMHS800□RA431MLN0S
	560	MN0	0.059	0.59	2,300	EMHS800□RA561MMN0S
100	110	KE0	0.17	2.5	920	EMHS101□RA111MKE0S
	150	KG5	0.13	1.8	1,030	EMHS101□RA151MKG5S
	160	LH0	0.098	1.3	1,640	EMHS101□RA161MLH0S
	200	MH0	0.091	0.98	1,720	EMHS101□RA201MMH0S
	240	LN0	0.063	0.80	2,230	EMHS101□RA241MLN0S
	330	MN0	0.059	0.59	2,300	EMHS101□RA331MMN0S

□ : Enter the appropriate terminal code.
New products are indicated in red text.

◆ **RATED RIPPLE CURRENT MULTIPLIERS**

● Frequency Multipliers

Size code	Capacitance(μF)	Frequency(Hz)			
		120	1k	10k	100k
HA0, JA0	47 to 180	0.40	0.75	0.90	1.00
	220 to 470	0.50	0.85	0.94	1.00
	680 to 1,000	0.60	0.87	0.95	1.00
KE0 to MN0	110 to 200	0.40	0.75	0.90	1.00
	220 to 620	0.50	0.85	0.94	1.00
	680 to 2,000	0.60	0.87	0.95	1.00
	2,400 to 4,300	0.75	0.90	0.95	1.00
	4,700 to 6,200	0.85	0.95	0.98	1.00

The deterioration of aluminum electrolytic capacitors accelerates their life due to the internal heating produced by ripple current. For details, refer to Section "5-3 Ripple Current Effect on Lifetime" in the catalog, Technical Note.

Alchip™-MVH Series

- Lower ESR, Higher ripple current
- Endurance : 1,000 to 5,000 hours at 125°C
- Suitable to fit for automotive equipment
- Solvent resistant type except 63 to 100V_{dc} (see PRECAUTIONS AND GUIDELINES)
- Vibration resistant structure
- RoHS2 Compliant
- AEC-Q200 compliant : Please contact Chemi-Con for more details, test data, information.

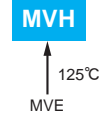

◆ SPECIFICATIONS

Items	Characteristics											
Category Temperature Range	-40 to +125°C											
Rated Voltage Range	10 to 100V _{dc}											
Capacitance Tolerance	±20% (M) (at 20°C, 120Hz)											
Leakage Current	F60 to JA0	I=0.01CV or 3μA, whichever is greater.										
	KE0 to MN0	I=0.03CV or 4μA, whichever is greater.										
	Where, I : Max. leakage current (μA), C : Nominal capacitance (μF), V : Rated voltage (V) (at 20°C after 2 minutes)											
Dissipation Factor (tan δ)	Rated voltage (V _{dc})	10V	16V	25V	35V	50V	63V	80V	100V			
	tan δ (Max.)	F60 to JA0	0.24	0.20	0.16	0.14	0.14	0.12	0.12	0.10		
		KE0 to MN0	0.22	0.18	0.16	0.14	0.12	0.14	—	0.10		
When nominal capacitance exceeds 1,000μF, add 0.02 to the value above for each 1,000μF increase. (at 20°C, 120Hz)												
Low Temperature Characteristics (Max. Impedance Ratio)	Rated voltage (V _{dc})	10V	16V	25V	35V	50V	63V	80V	100V			
	F60 to JA0	Z(-25°C)/Z(+20°C)	3	2	2	2	2	2	2	2		
		Z(-40°C)/Z(+20°C)	6	4	4	3	3	3	3	3		
	KE0 to MN0	Z(-25°C)/Z(+20°C)	4	3	2	2	2	2	—	2		
		Z(-40°C)/Z(+20°C)	8	6	4	3	3	3	—	3	(at 120Hz)	
Endurance												
The following specifications shall be satisfied when the capacitors are restored to 20°C after the rated voltage is applied for the specified time at 125°C.												
Time	F60 to H63 (10 to 100V _{dc}) : 1,000hours HA0 to JA0 (10 to 100V _{dc}) : 2,000hours KE0 to MN0 (10 to 100V _{dc}) : 5,000hours											
Capacitance change	≤ ±30% of the initial value											
D.F. (tan δ)	≤300% of the initial specified value											
Leakage current	≤The initial specified value											
Shelf Life												
The following specifications shall be satisfied when the capacitors are restored to 20°C after exposing them for 1,000 hours at 125°C without voltage applied. Before the measurement, the capacitor shall be preconditioned by applying voltage according to Item 4.1 of JIS C 5101-4.												
Rated voltage(V _{dc})	10 to 50V _{dc}					63 to 100V _{dc}						
Capacitance change	≤ ±30% of the initial value					≤ ±30% of the initial value						
D.F. (tan δ)	≤300% of the initial specified value					≤300% of the initial specified value						
Leakage current	≤The initial specified value					≤500% of the initial specified value						

◆ DIMENSIONS [mm]

- Terminal Code : A
- Size code : F60 to MN0

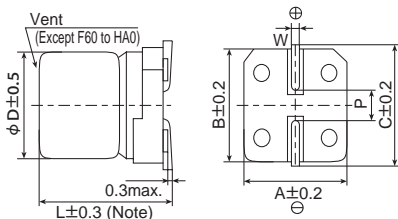

Note : L±0.5 for HA0 to MN0

- Terminal Code : G(Vibration resistant structure)
- Size code : F80, HA0 to MN0

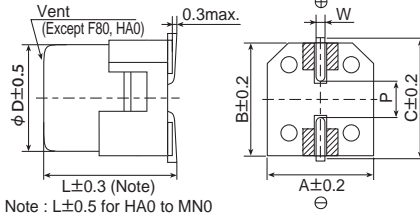

Note : L±0.5 for HA0 to MN0

Size code	D	L	A	B	C	W	P
F60	6.3	5.7	6.6	6.6	7.2	0.5 to 0.8	1.9
F80	6.3	7.7	6.6	6.6	7.2	0.5 to 0.8	1.9
H63	8	6.3	8.3	8.3	9.0	0.5 to 0.8	2.3
HA0	8	10.0	8.3	8.3	9.0	0.7 to 1.1	3.1
JA0	10	10.0	10.3	10.3	11.0	0.7 to 1.1	4.5
KE0	12.5	13.5	13.0	13.0	13.7	1.0 to 1.3	4.2
KG5	12.5	16.0	13.0	13.0	13.7	1.0 to 1.3	4.2
LH0	16	16.5	17.0	17.0	18.0	1.0 to 1.3	6.5
LN0	16	21.5	17.0	17.0	18.0	1.0 to 1.3	6.5
MH0	18	16.5	19.0	19.0	20.0	1.0 to 1.3	6.5
MN0	18	21.5	19.0	19.0	20.0	1.0 to 1.3	6.5

▨ : Dummy terminals

◆ PART NUMBERING SYSTEM

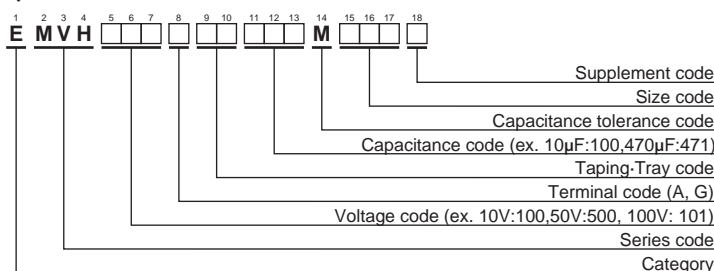

◆ MARKING

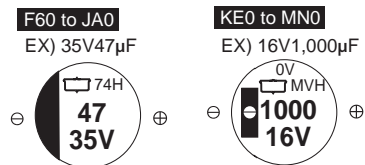

Please refer to "Product code guide (surface mount type)"



Alchip™ - MVH Series

◆ STANDARD RATINGS

WV (V _{dc})	Cap (μF)	Size code	ESR (Ω max./100kHz)		Rated ripple current (mArms/125°C)		Part No.
			20°C	-40°C	100kHz	120Hz	
10	100	F80	0.90	14.0	110	—	EMVH100□RA101MF80G
	100	H63	0.90	14.0	110	—	EMVH100ARA101MH63G
	220	F80	0.90	14.0	110	—	EMVH100□RA221MF80G
	220	H63	0.90	14.0	110	—	EMVH100ARA221MH63G
	220	HA0	0.40	6.0	220	—	EMVH100□RA221MHA0G
	330	HA0	0.40	6.0	220	—	EMVH100□RA331MHA0G
	330	JA0	0.30	4.5	296	—	EMVH100□RA331MJA0G
	470	JA0	0.30	4.5	296	—	EMVH100□RA471MJA0G
	1,000	KE0	0.14	2.1	750	—	EMVH100□RA102MKE0S
	2,200	LH0	0.10	1.5	1,000	—	EMVH100□RA222MLH0S
	2,200	MH0	0.10	1.5	1,200	—	EMVH100□RA222MMH0S
	3,300	MH0	0.10	1.5	1,200	—	EMVH100□RA332MMH0S
4,700	MN0	0.058	0.87	1,550	—	EMVH100□RA472MMN0S	
16	47	F60	1.6	24.0	69	—	EMVH160ARA470MF60G
	100	HA0	0.40	6.0	220	—	EMVH160□RA101MHA0G
	220	HA0	0.40	6.0	220	—	EMVH160□RA221MHA0G
	220	JA0	0.30	4.5	296	—	EMVH160□RA221MJA0G
	330	JA0	0.30	4.5	296	—	EMVH160□RA331MJA0G
	470	KE0	0.14	2.1	750	—	EMVH160□RA471MKE0S
	680	KE0	0.14	2.1	750	—	EMVH160□RA681MKE0S
	680	LH0	0.10	1.5	1,000	—	EMVH160□RA681MLH0S
	1,000	MH0	0.10	1.5	1,200	—	EMVH160□RA102MMH0S
	2,200	MH0	0.10	1.5	1,200	—	EMVH160□RA222MMH0S
25	33	F60	1.6	24.0	69	—	EMVH250ARA330MF60G
	47	F80	0.90	14.0	110	—	EMVH250□RA470MF80G
	47	H63	0.90	14.0	110	—	EMVH250ARA470MH63G
	100	F80	0.90	14.0	110	—	EMVH250□RA101MF80G
	100	H63	0.90	14.0	110	—	EMVH250ARA101MH63G
	100	HA0	0.40	6.0	220	—	EMVH250□RA101MHA0G
	220	HA0	0.40	6.0	220	—	EMVH250□RA221MHA0G
	220	JA0	0.30	4.5	296	—	EMVH250□RA221MJA0G
	330	JA0	0.30	4.5	296	—	EMVH250□RA331MJA0G
	330	KE0	0.14	2.1	750	—	EMVH250□RA331MKE0S
	470	KE0	0.14	2.1	750	—	EMVH250□RA471MKE0S
	470	LH0	0.10	1.5	1,000	—	EMVH250□RA471MLH0S
	680	LH0	0.10	1.5	1,000	—	EMVH250□RA681MLH0S
	680	MH0	0.10	1.5	1,200	—	EMVH250□RA681MMH0S
1,000	MN0	0.058	0.87	1,550	—	EMVH250□RA102MMN0S	
35	10	F60	1.6	24.0	69	—	EMVH350ARA100MF60G
	22	F60	1.6	24.0	69	—	EMVH350ARA220MF60G
	33	F80	0.90	14.0	110	—	EMVH350□RA330MF80G
	33	H63	0.90	14.0	110	—	EMVH350ARA330MH63G
	47	F80	0.90	14.0	110	—	EMVH350□RA470MF80G
	47	H63	0.90	14.0	110	—	EMVH350ARA470MH63G
	47	HA0	0.40	6.0	220	—	EMVH350□RA470MHA0G
	100	HA0	0.40	6.0	220	—	EMVH350□RA101MHA0G
	100	JA0	0.30	4.5	296	—	EMVH350□RA101MJA0G
	220	JA0	0.30	4.5	296	—	EMVH350□RA221MJA0G
	330	KE0	0.14	2.1	750	—	EMVH350□RA331MKE0S
	330	LH0	0.10	1.5	1,000	—	EMVH350□RA331MLH0S
	470	KG5	0.11	1.5	900	—	EMVH350□RA471MKG5S
	470	LH0	0.10	1.5	1,000	—	EMVH350□RA471MLH0S
	680	MH0	0.10	1.5	1,200	—	EMVH350□RA681MMH0S
	50	10	F60	2.8	42.0	51	—
10		H63	1.6	30.0	83	—	EMVH500ARA100MH63G
22		F80	2.0	30.0	83	—	EMVH500□RA220MF80G
22		H63	1.6	30.0	83	—	EMVH500ARA220MH63G
33		F80	2.0	30.0	83	—	EMVH500□RA330MF80G
33		H63	1.6	30.0	83	—	EMVH500ARA330MH63G
33		HA0	0.70	11.0	160	—	EMVH500□RA330MHA0G
47		HA0	0.70	11.0	160	—	EMVH500□RA470MHA0G
47		JA0	0.50	7.5	247	—	EMVH500□RA470MJA0G
100		JA0	0.50	7.5	247	—	EMVH500□RA101MJA0G
100		KE0	0.23	3.5	550	—	EMVH500□RA101MKE0S
220		KE0	0.23	3.5	550	—	EMVH500□RA221MKE0S
220		LH0	0.15	2.3	850	—	EMVH500□RA221MLH0S
330		KG5	0.18	2.7	700	—	EMVH500□RA331MKG5S
330		LH0	0.15	2.3	850	—	EMVH500□RA331MLH0S
470		MH0	0.15	2.3	920	—	EMVH500□RA471MMH0S
63	10	F80	2.0	100	60	—	EMVH630□RA100MF80G
	10	H63	2.0	110	60	—	EMVH630ARA100MH63G
	22	HA0	0.70	35.0	100	—	EMVH630□RA220MHA0G
	33	HA0	0.70	35.0	100	—	EMVH630□RA330MHA0G
	33	JA0	0.50	25.0	170	—	EMVH630□RA330MJA0G
	47	HA0	0.70	35.0	100	—	EMVH630□RA470MHA0G
	47	JA0	0.50	25.0	170	—	EMVH630□RA470MJA0G
	100	KE0	0.25	12.5	500	—	EMVH630□RA101MKE0S
	220	KG5	0.20	10.0	600	—	EMVH630□RA221MKG5S
	330	LH0	0.18	9.0	820	—	EMVH630□RA331MLH0S
470	LH0	0.11	5.5	1,100	—	EMVH630□RA471MLN0S	
80	10	HA0	0.75	50.0	70	—	EMVH800□RA100MHA0G
	22	HA0	0.75	50.0	70	—	EMVH800□RA220MHA0G
	22	JA0	0.55	35.0	115	—	EMVH800□RA220MJA0G
	33	HA0	0.75	50.0	70	—	EMVH800□RA330MHA0G
	33	JA0	0.55	35.0	115	—	EMVH800□RA330MJA0G
	47	JA0	0.55	35.0	115	—	EMVH800□RA470MJA0G
100	10	HA0	0.75	50.0	70	—	EMVH101□RA100MHA0G
	22	HA0	0.75	50.0	70	—	EMVH101□RA220MHA0G
	22	JA0	0.55	35.0	115	—	EMVH101□RA220MJA0G
	33	JA0	0.55	35.0	115	—	EMVH101□RA330MJA0G
	47	KE0	0.33	16.5	450	—	EMVH101□RA470MKE0S
	68	KG5	0.26	13.0	550	—	EMVH101□RA680MKG5S
100	LH0	0.24	12.0	650	—	EMVH101□RA101MLH0S	
220	MN0	0.16	8.0	950	—	EMVH101□RA221MMN0S	

□ : Enter the appropriate terminal code.

Production of the products shown in is scheduled to be discontinued.

*1: Assembly boards with the designated products attached cannot be cleaned.

◆ RATED RIPPLE CURRENT MULTIPLIERS

● Frequency Multipliers

Size code	Capacitance(μF)	Frequency(Hz)			
		120	1k	10k	100k
F60 to JA0	10	0.66	0.86	0.93	1.00
	22 to 470	0.93	0.97	1.00	1.00
KE0 to MN0	47 to 100	0.40	0.75	0.90	1.00
	220 to 470	0.50	0.85	0.94	1.00
	680 to 1,000	0.60	0.87	0.95	1.00
	2,200 to 3,300	0.75	0.90	0.95	1.00
	4,700	0.85	0.95	0.98	1.00

The deterioration of aluminum electrolytic capacitors accelerates their life due to the internal heating produced by ripple current. For details, refer to Section "5-3 Ripple Current Effect on Lifetime" in the catalog, Technical Note.

Alchip™-MHL Series

- Downsized and Longer life from current MVH series
- Endurance : 2,000 to 4,000 hours at 125°C
- Rated voltage range : 10 to 35V. Nominal capacitance range : 47 to 680μF
- For automobile modules and other high temperature applications
- Solvent resistant type (see PRECAUTIONS AND GUIDELINES)
- Vibration resistant structure
- RoHS2 Compliant
- AEC-Q200 compliant : Please contact Chemi-Con for more details, test data, information.

MHL

↑
Downsized
Longer life
MVH

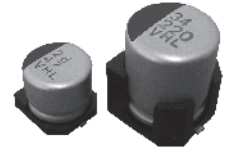

◆ SPECIFICATIONS

Items	Characteristics	
Category	-40 to +125°C	
Temperature Range		
Rated Voltage Range	10 to 35V _{dc}	
Capacitance Tolerance	±20%(M) (at 20°C, 120Hz)	
Leakage Current	I=0.01CV Where, I : Max. leakage current (μA), C : Nominal capacitance (μF), V : Rated voltage (V) (at 20°C after 2 minutes)	
Dissipation Factor (tan δ)	Rated voltage(V _{dc})	10V 16V 25V 35V
	tan δ (Max.)	0.24 0.20 0.16 0.14 (at 20°C, 120Hz)
Low Temperature Characteristics (Max. impedance Ratio)	Rated voltage(V _{dc})	10V 16V 25V 35V
	Z(-25°C)/Z(+20°C)	3 2 2 2 (at 120Hz)
	Z(-40°C)/Z(+20°C)	6 4 4 3
Endurance	The following specifications shall be satisfied when the capacitors are restored to 20°C after the rated voltage is applied for specified time at 125°C.	
	Time	F61 & F80 : 2,000 hours HA0 & JA0 : 4,000 hours
	Capacitance change	≤ ±30% of the initial value
	D.F. (tan δ)	≤ 300% of the initial specified value
	Leakage current	≤ The initial specified value
Shelf Life	The following specifications shall be satisfied when the capacitors are restored to 20°C after exposing them for 1,000 hours at 125°C without voltage applied. Before the measurement, the capacitor shall be preconditioned by applying voltage according to Item 4.1 of JIS C 5101-4.	
	Capacitance change	≤ ±30% of the initial value
	D.F. (tan δ)	≤ 300% of the initial specified value
	Leakage current	≤ The initial specified value

◆ DIMENSIONS [mm]

- Terminal Code : A
- Size code : F61 to JA0

- Terminal Code : G (Vibration resistant structure)
- Size code : F61 to JA0

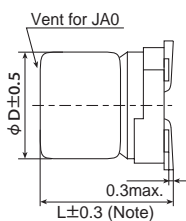

Note : L±0.5 for HA0 and JA0

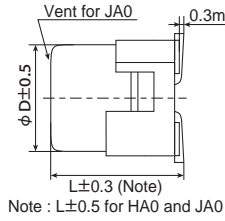
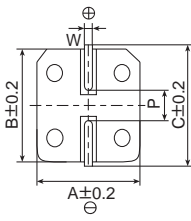

Note : L±0.5 for HA0 and JA0

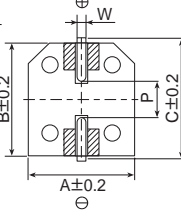

▨ : Dummy terminals

Size code	φD	L	A	B	C	W	P
F61	6.3	5.8	6.6	6.6	7.2	0.5 to 0.8	1.9
F80	6.3	7.7	6.6	6.6	7.2	0.5 to 0.8	1.9
HA0	8	10.0	8.3	8.3	9.0	0.7 to 1.1	3.1
JA0	10	10.0	10.3	10.3	11.0	0.7 to 1.1	4.5

◆ PART NUMBERING SYSTEM

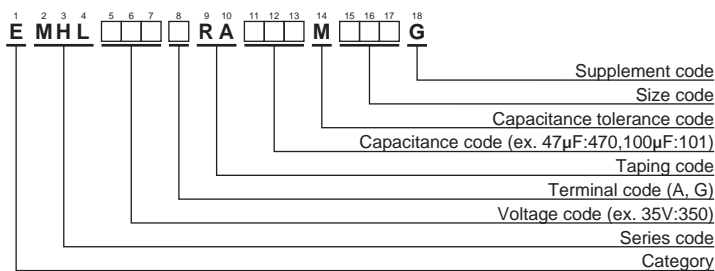

Please refer to "Product code guide (surface mount type)"

◆ MARKING

EX) 35V47μF



● Rated voltage symbol

Rated voltage (V _{dc})	Symbol
10	A
16	C
25	E
35	V



Alchip™-MHL Series

◆STANDARD RATINGS

WV (V _{dc})	Cap (μF)	Size code	ESR (Ω max./100kHz)		Rated ripple current (mA rms/125°C, 100kHz)	Part No.
			20°C	-40°C		
10	100	F61	1.2	22	110	EMHL100 □ RA101MF61G
	220	F80	0.60	12	220	EMHL100 □ RA221MF80G
	330	HA0	0.30	5.5	296	EMHL100 □ RA331MHA0G
	470	HA0	0.30	5.5	296	EMHL100 □ RA471MHA0G
	680	JA0	0.20	3.6	440	EMHL100 □ RA681MJA0G
16	47	F61	1.2	22	110	EMHL160 □ RA470MF61G
	100	F61	1.2	22	110	EMHL160 □ RA101MF61G
	220	F80	0.60	12	220	EMHL160 □ RA221MF80G
	330	HA0	0.30	5.5	296	EMHL160 □ RA331MHA0G
	470	JA0	0.20	3.6	440	EMHL160 □ RA471MJA0G
	680	JA0	0.20	3.6	440	EMHL160 □ RA681MJA0G
25	47	F61	1.2	22	110	EMHL250 □ RA470MF61G
	100	F80	0.60	12	220	EMHL250 □ RA101MF80G
	220	HA0	0.30	5.5	296	EMHL250 □ RA221MHA0G
	330	JA0	0.20	3.6	440	EMHL250 □ RA331MJA0G
35	47	F61	1.2	22	110	EMHL350 □ RA470MF61G
	100	F80	0.60	12	220	EMHL350 □ RA101MF80G
	220	HA0	0.30	5.5	296	EMHL350 □ RA221MHA0G
	330	JA0	0.20	3.6	440	EMHL350 □ RA331MJA0G

□ : Enter the appropriate terminal code.

◆RATED RIPPLE CURRENT MULTIPLIERS

●Frequency Multipliers

Capacitance(μF)	Frequency(Hz)			
	120	1k	10k	100k
47 to 680	0.93	0.97	1.00	1.00

The deterioration of aluminum electrolytic capacitors accelerates their life due to the internal heating produced by ripple current. For details, refer to Section "5-3 Ripple Current Effect on Lifetime" in the catalog, Technical Note.

Alchip™-MHB Series

- ESR : Less than MVH
- Endurance : 1,500 to 3,000 hours at 125°C
- Rated voltage range : 10 to 100V
- Solvent resistant type (see PRECAUTIONS AND GUIDELINES)
- Vibration resistant structure
- RoHS2 Compliant
- AEC-Q200 compliant : Please contact Chemi-Con for more details, test data, information.

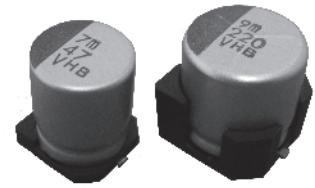
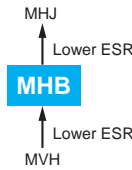

◆ SPECIFICATIONS

Items	Characteristics									
Category	-40 to +125°C									
Temperature Range	-40 to +125°C									
Rated Voltage Range	10 to 100V _{dc}									
Capacitance Tolerance	±20%(M) (at 20°C, 120Hz)									
Leakage Current	HA0 & JA0	I=0.01CV								
	KE0 to MNO	I=0.03CV								
Where, I : Max. leakage current (μA), C : Nominal capacitance (μF), V : Rated voltage (V) (at 20°C after 2 minutes)										
Dissipation Factor (tan δ)	Rated Voltage (V _{dc})	10V	16V	25V	35V	50V	63V	80V	100V	
	tan δ (Max.)	HA0 & JA0	0.24	0.20	0.16	0.14	—	—	—	—
		KE0 to MNO	—	—	0.14	0.12	0.10	0.10	0.08	0.08
When nominal capacitance exceeds 1,000μF, add 0.02 to the value above for each 1,000μF increase. (at 20°C, 120Hz)										
Low Temperature Characteristics (Max. impedance Ratio)	Rated Voltage (V _{dc})	10V	16V	25V	35V	50V	63V	80V	100V	
	HA0 & JA0	Z(-25°C)/Z(+20°C)	3	2	2	2	—	—	—	—
		Z(-40°C)/Z(+20°C)	4	3	3	3	—	—	—	—
	KE0 to MNO	Z(-25°C)/Z(+20°C)	—	—	2	2	2	2	2	2
Z(-40°C)/Z(+20°C)		—	—	4	4	4	4	4	4	
(at 120Hz)										
Endurance	HA0 & JA0	The following specifications shall be satisfied when the capacitors are restored to 20°C after the rated voltage is applied for 2,000 hours at 125°C.								
		Capacitance change	≤ ±30% of the initial value							
		D.F. (tan δ)	≤ 300% of the initial specified value							
	KE0 to MNO	The following specifications shall be satisfied when the capacitors are restored to 20°C after subjected to DC voltage with the rated ripple current is applied (the peak voltage shall not exceed the rated voltage) for the specified period of time at 125°C.								
		Time	KE0 & KG5 : 1,500hours LH0 & MH0 : 2,000hours KN0 & LN0 & MNO : 3,000hours							
		Capacitance change	≤ ±30% of the initial value							
Shelf Life	The following specifications shall be satisfied when the capacitors are restored to 20°C after exposing them for 1,000 hours at 125°C without voltage applied. Before the measurement, the capacitor shall be preconditioned by applying voltage according to Item 4.1 of JIS C 5101-4.									
	Capacitance change	≤ ±30% of the initial value								
	D.F. (tan δ)	≤ 300% of the initial specified value								
Leakage current ≤ The initial specified value										

◆ DIMENSIONS [mm]

- Terminal Code : A
- Size code : HA0 to MNO

- Terminal Code : G (Vibration resistant structure)
- Size code : HA0 to MNO

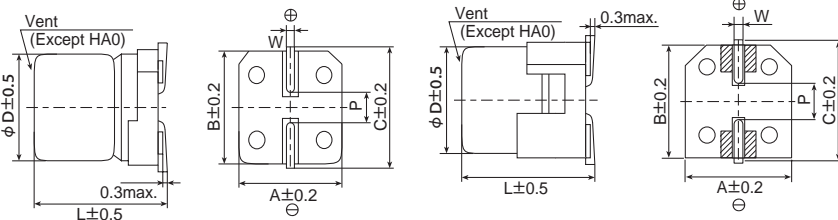

Size code	φD	L	A	B	C	W	P
HA0	8	10.0	8.3	8.3	9.0	0.7 to 1.1	3.1
JA0	10	10.0	10.3	10.3	11.0	0.7 to 1.1	4.5
KE0	12.5	13.5	13.0	13.0	13.7	1.0 to 1.3	4.2
KG5	12.5	16.0	13.0	13.0	13.7	1.0 to 1.3	4.2
KN0	12.5	21.5	13.0	13.0	13.7	1.0 to 1.3	4.2
LH0	16	16.5	17.0	17.0	18.0	1.0 to 1.3	6.5
LN0	16	21.5	17.0	17.0	18.0	1.0 to 1.3	6.5
MH0	18	16.5	19.0	19.0	20.0	1.0 to 1.3	6.5
MNO	18	21.5	19.0	19.0	20.0	1.0 to 1.3	6.5

▨ : Dummy terminals

◆ PART NUMBERING SYSTEM

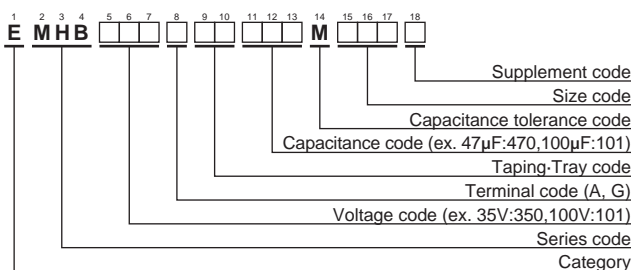

Please refer to "Product code guide (surface mount type)"

◆ MARKING

HA0, JA0
EX) 16V220μF

KE0 to MNO
EX) 35V1,000μF

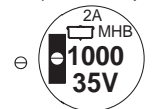

- Rated voltage symbol (HA0, JA0)

Rated voltage (V _{dc})	10	16	25	35
Symbol	A	C	E	V



Alchip™-MHB Series

◆STANDARD RATINGS

WV (V _{dc})	Cap (μF)	Size code	ESR(Initial) (Ω max./100k to 400kHz)		ESR(End of life) (Ω max.)			Rated ripple current (mArms/125°C, 100k to 400kHz)	Part No.
			20°C	-40°C	100kHz		400kHz		
					20°C	-40°C	-40°C		
10	330	HA0	0.3	3.0	-	-	6.0	240	EMHB100 □ RA331MHA0G
	470	JA0	0.2	2.0	-	-	4.5	330	EMHB100 □ RA471MJA0G
16	100	HA0	0.3	3.0	-	-	6.0	240	EMHB160 □ RA101MHA0G
	220	HA0	0.3	3.0	-	-	6.0	240	EMHB160 □ RA221MHA0G
25	100	HA0	0.3	3.0	-	-	6.0	240	EMHB250 □ RA101MHA0G
	220	HA0	0.3	3.0	-	-	6.0	240	EMHB250 □ RA221MHA0G
	330	JA0	0.2	2.0	-	-	4.5	330	EMHB250 □ RA331MJA0G
	820	KE0	0.060	0.30	0.30	3.7	-	1,320	EMHB250 □ RA821MKE0S
	1,100	KG5	0.056	0.28	0.28	3.4	-	1,470	EMHB250 □ RA112MKG5S
	(1,500)	(KN0)	(0.044)	(0.22)	(0.18)	(2.2)	-	(1,620)	(EMHB250 □ TR152MKN0S)
	1,600	LH0	0.047	0.24	0.24	2.9	-	1,820	EMHB250 □ RA162MLH0S
	2,200	MH0	0.045	0.23	0.23	2.8	-	2,000	EMHB250 □ RA222MMH0S
	2,700	LN0	0.034	0.17	0.10	1.3	-	2,280	EMHB250 □ RA272MLN0S
3,300	MN0	0.032	0.16	0.090	0.60	-	2,490	EMHB250 □ RA332MMN0S	
35	47	HA0	0.3	3.0	-	-	6.0	240	EMHB350 □ RA470MHA0G
	100	HA0	0.3	3.0	-	-	6.0	240	EMHB350 □ RA101MHA0G
	100	JA0	0.2	2.0	-	-	4.5	330	EMHB350 □ RA101MJA0G
	220	JA0	0.2	2.0	-	-	4.5	330	EMHB350 □ RA221MJA0G
	560	KE0	0.060	0.30	0.30	3.7	-	1,320	EMHB350 □ RA561MKE0S
	680	KG5	0.056	0.28	0.28	3.4	-	1,470	EMHB350 □ RA681MKG5S
	(910)	(KN0)	(0.044)	(0.22)	(0.18)	(2.2)	-	(1,620)	(EMHB350 □ TR911MKN0S)
	1,000	LH0	0.047	0.24	0.24	2.9	-	1,820	EMHB350 □ RA102MLH0S
	1,300	MH0	0.045	0.23	0.23	2.8	-	2,000	EMHB350 □ RA132MMH0S
1,600	LN0	0.034	0.17	0.10	1.3	-	2,280	EMHB350 □ RA162MLN0S	
2,200	MN0	0.032	0.16	0.090	0.60	-	2,490	EMHB350 □ RA222MMN0S	
50	270	KE0	0.11	0.55	0.55	6.6	-	980	EMHB500 □ RA271MKE0S
	360	KG5	0.10	0.50	0.50	6.0	-	1,090	EMHB500 □ RA361MKG5S
	(470)	(KN0)	(0.076)	(0.38)	(0.38)	(4.6)	-	(1,200)	(EMHB500 □ TR471MKN0S)
	510	LH0	0.087	0.44	0.44	5.2	-	1,320	EMHB500 □ RA511MLH0S
	680	MH0	0.087	0.44	0.44	5.2	-	1,420	EMHB500 □ RA681MMH0S
	820	LN0	0.050	0.25	0.25	3.0	-	2,040	EMHB500 □ RA821MLN0S
1,100	MN0	0.050	0.25	0.25	3.0	-	2,240	EMHB500 □ RA112MMN0S	
63	200	KE0	0.22	1.54	0.88	14	-	540	EMHB630 □ RA201MKE0S
	270	KG5	0.17	1.19	0.68	11	-	650	EMHB630 □ RA271MKG5S
	(330)	(KN0)	(0.13)	(0.94)	(0.53)	(8.5)	-	(830)	(EMHB630 □ TR331MKN0S)
	360	LH0	0.15	1.05	0.60	9.6	-	780	EMHB630 □ RA361MLH0S
	470	MH0	0.12	0.84	0.48	7.7	-	940	EMHB630 □ RA471MMH0S
	560	LN0	0.085	0.58	0.19	3.0	-	1,790	EMHB630 □ RA561MLN0S
750	MN0	0.070	0.49	0.19	3.0	-	1,910	EMHB630 □ RA751MMN0S	
80	130	KE0	0.22	1.54	0.88	14	-	540	EMHB800 □ RA131MKE0S
	160	KG5	0.17	1.19	0.68	11	-	650	EMHB800 □ RA161MKG5S
	(220)	(KN0)	(0.13)	(0.94)	(0.53)	(8.5)	-	(830)	(EMHB800 □ TR221MKN0S)
	240	LH0	0.15	1.05	0.60	9.6	-	780	EMHB800 □ RA241MLH0S
	330	MH0	0.12	0.84	0.48	7.7	-	940	EMHB800 □ RA331MMH0S
	390	LN0	0.085	0.58	0.19	3.0	-	1,790	EMHB800 □ RA391MLN0S
510	MN0	0.070	0.49	0.19	3.0	-	1,910	EMHB800 □ RA511MMN0S	
100	75	KE0	0.28	2.24	1.1	22	-	480	EMHB101 □ RA750MKE0S
	100	KG5	0.21	1.68	0.84	17	-	580	EMHB101 □ RA101MKG5S
	(130)	(KN0)	(0.17)	(1.32)	(0.66)	(13)	-	(740)	(EMHB101 □ TR131MKN0S)
	130	LH0	0.18	1.44	0.72	14	-	720	EMHB101 □ RA131MLH0S
	180	MH0	0.15	1.20	0.60	12	-	840	EMHB101 □ RA181MMH0S
	220	LN0	0.11	0.88	0.25	3.9	-	1,580	EMHB101 □ RA221MLN0S
300	MN0	0.091	0.73	0.22	3.9	-	1,690	EMHB101 □ RA301MMN0S	

□ : Enter the appropriate terminal code.

() : Second standard

◆RATED RIPPLE CURRENT MULTIPLIERS

● Frequency Multipliers

Size code	Capacitance(μF)	Frequency(Hz)			
		120	1k	10k	100k
HA0 to JA0	47 to 470	0.93	0.97	1.00	1.00
	75 to 200	0.40	0.75	0.90	1.00
KE0 to MN0	220 to 560	0.50	0.85	0.94	1.00
	680 to 1,600	0.60	0.87	0.95	1.00
	2,200 to 3,300	0.75	0.90	0.95	1.00

The deterioration of aluminum electrolytic capacitors accelerates their life due to the internal heating produced by ripple current. For details, refer to Section "5-3 Ripple Current Effect on Lifetime" in the catalog, Technical Note.



Alchip™-MHJ Series

- Endurance : 2,000 to 3,000 hours at 125°C
- Rated voltage range : 10 to 35V
- Nominal capacitance range : 47 to 470μF
- Solvent resistant type (see PRECAUTIONS AND GUIDELINES)
- Vibration resistant structure
- RoHS2 Compliant
- AEC-Q200 compliant : Please contact Chemi-Con for more details, test data, information.



◆ SPECIFICATIONS

Items	Characteristics				
Category	-40 to +125°C				
Temperature Range	-40 to +125°C				
Rated Voltage Range	10 to 35V _{dc}				
Capacitance Tolerance	±20%(M) (at 20°C, 120Hz)				
Leakage Current	I=0.01CV Where, I : Max. leakage current (μA), C : Nominal capacitance (μF), V : Rated voltage (V) (at 20°C after 2 minutes)				
Dissipation Factor (tan δ)	Rated voltage(V _{dc})	10V	16V	25V	35V
	tan δ (Max.)	0.30	0.23	0.18	0.16
Low Temperature Characteristics (Max. impedance Ratio)	Rated voltage(V _{dc})	10V	16V	25V	35V
	Z(-25°C)/Z(+20°C)	3	2	2	2
	Z(-40°C)/Z(+20°C)	4	3	3	3
Endurance	The following specifications shall be satisfied when the capacitors are restored to 20°C after the rated voltage is applied for 3,000 hours (2,000 hours for F80 size) at 125°C.				
	Capacitance change	≤ ±30% of the initial value			
	D.F. (tan δ)	≤ 300% of the initial specified value			
	Leakage current	≤ The initial specified value			
	ESR after 2,000 hours (Ω max./100kHz)		F80	HA0	JA0
		20°C	3.5	0.60	0.40
-40°C	40	4.5	3.5		
Shelf Life	The following specifications shall be satisfied when the capacitors are restored to 20°C after exposing them for 1,000 hours at 125°C without voltage applied. Before the measurement, the capacitor shall be preconditioned by applying voltage according to Item 4.1 of JIS C 5101-4.				
	Capacitance change	≤ ±30% of the initial value			
	D.F. (tan δ)	≤ 300% of the initial specified value			
	Leakage current	≤ The initial specified value			

◆ DIMENSIONS [mm]

- Terminal Code : A

- Size code : F80 to JA0

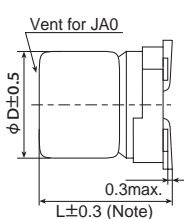

Note : L±0.5 for HA0, JA0

- Terminal Code : G(Vibration resistant structure)

- Size code : F80 to JA0

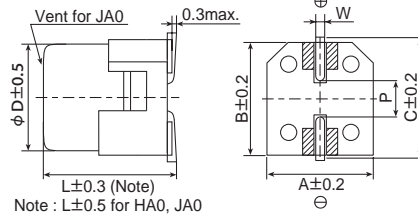

Note : L±0.5 for HA0, JA0

▨ : Dummy terminals

Size code	φD	L	A	B	C	W	P
F80	6.3	7.7	6.6	6.6	7.2	0.5 to 0.8	1.9
HA0	8	10.0	8.3	8.3	9.0	0.7 to 1.1	3.1
JA0	10	10.0	10.3	10.3	11.0	0.7 to 1.1	4.5

◆ PART NUMBERING SYSTEM

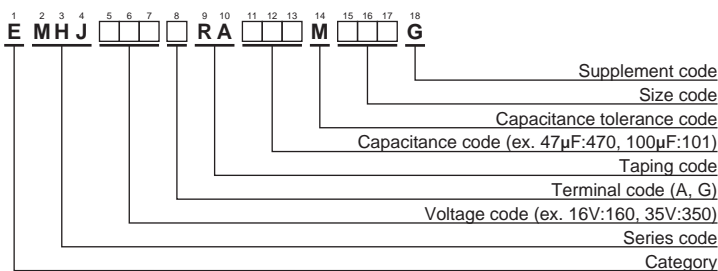

Please refer to "Product code guide (surface mount type)"

◆ MARKING

EX) 16V100μF



- Rated voltage symbol

Rated voltage (V _{dc})	Symbol
10	A
16	C
25	E
35	V



Alchip™-MHJ Series

◆STANDARD RATINGS

WV (V _{dc})	Cap (μF)	Size code	ESR (Ω max./100kHz)		Rated ripple current (mA _{rms} /125°C, 100kHz)	Part No.
			20°C	-40°C		
10	220	HA0	0.15	3.0	350	EMHJ100□RA221MHA0G
	330	HA0	0.15	3.0	350	EMHJ100□RA331MHA0G
	330	JA0	0.12	2.0	550	EMHJ100□RA331MJA0G
	470	JA0	0.12	2.0	550	EMHJ100□RA471MJA0G
16	100	F80	0.45	5.0	220	EMHJ160□RA101MF80G
	100	HA0	0.15	3.0	350	EMHJ160□RA101MHA0G
	220	HA0	0.15	3.0	350	EMHJ160□RA221MHA0G
	330	JA0	0.12	2.0	550	EMHJ160□RA331MJA0G
	470	JA0	0.12	2.0	550	EMHJ160□RA471MJA0G
25	100	HA0	0.15	3.0	350	EMHJ250□RA101MHA0G
	220	JA0	0.12	2.0	550	EMHJ250□RA221MJA0G
	330	JA0	0.12	2.0	550	EMHJ250□RA331MJA0G
35	47	F80	0.45	5.0	220	EMHJ350□RA470MF80G
	47	HA0	0.15	3.0	350	EMHJ350□RA470MHA0G
	100	HA0	0.15	3.0	350	EMHJ350□RA101MHA0G
	220	JA0	0.12	2.0	550	EMHJ350□RA221MJA0G

□ : Enter the appropriate terminal code.

◆RATED RIPPLE CURRENT MULTIPLIERS

●Frequency Multipliers

Capacitance(μF)	Frequency(Hz)	120	1k	10k	100k
47 to 100		0.40	0.75	0.90	1.00
220 to 470		0.50	0.85	0.94	1.00

The deterioration of aluminum electrolytic capacitors accelerates their life due to the internal heating produced by ripple current. For details, refer to Section "5-3 Ripple Current Effect on Lifetime" in the catalog, Technical Note.

Alchip™-MHK Series

- Endurance : 2,000 hours at 125°C
- Specified ESR after endurance
- For automobile modules and other high temperature applications
- Solvent resistant type (see PRECAUTIONS AND GUIDELINES)
- RoHS2 Compliant
- AEC-Q200 compliant : Please contact Chemi-Con for more details, test data, information.

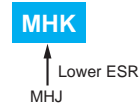

◆ SPECIFICATIONS

Items	Characteristics	
Category	-40 to +125°C	
Temperature Range	-40 to +125°C	
Rated Voltage Range	35V _{dc}	
Capacitance Tolerance	±20%(M) (at 20°C, 120Hz)	
Leakage Current	I=0.01CV Where, I : Max. leakage current (μA), C : Nominal capacitance (μF), V : Rated voltage (V) (at 20°C after 2 minute)	
Dissipation Factor (tan δ)	Rated voltage(V _{dc})	35V
	tan δ (Max.)	0.14 (at 20°C, 120Hz)
Low Temperature Characteristics (Max. impedance Ratio)	Rated voltage(V _{dc})	35V
	Z(-25°C)/Z(+20°C)	2
	Z(-40°C)/Z(+20°C)	3 (at 120Hz)
Endurance	The following specifications shall be satisfied when the capacitors are restored to 20°C after the rated voltage is applied for 2,000 hours at 125°C.	
	Capacitance change	≤ ±30% of the initial value
	D.F. (tan δ)	≤300% of the initial specified value
	Leakage current	≤The initial specified value
	ESR(Ω max./-40°C, 400kHz)	F80 6.0 HA0 4.5
Shelf life	The following specifications shall be satisfied when the capacitors are restored to 20°C after exposing them for 1,000 hours at 125°C without voltage applied. Before the measurement, the capacitor shall be preconditioned by applying voltage according to Item 4.1 of JIS C 5101-4.	
	Capacitance change	≤ ±30% of the initial value
	D.F. (tan δ)	≤300% of the initial specified value
	Leakage current	≤The initial specified value

◆ DIMENSIONS [mm]

- Terminal Code : A
- Size code : F80, HA0
- Terminal Code : G(Vibration resistant structure)
- Size code : F80, HA0

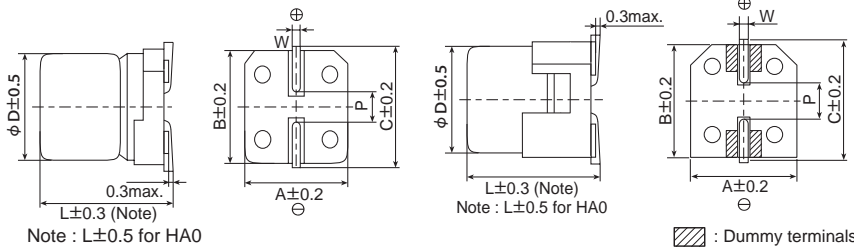

Size code	D	L	A	B	C	W	P
F80	6.3	7.7	6.6	6.6	7.2	0.5 to 0.8	1.9
HA0	8	10.0	8.3	8.3	9.0	0.7 to 1.1	3.1

◆ PART NUMBERING SYSTEM

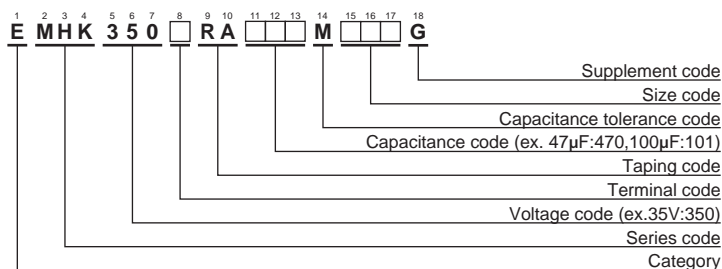

◆ MARKING



● Rated voltage symbol

Rated voltage (V _{dc})	Symbol
35	V

Please refer to "Product code guide (surface mount type)"



Alchip™-MHK Series

◆STANDARD RATINGS

WV (V _{dc})	Cap (μF)	Size code	ESR (Ω max./100k to 400kHz)		Rated ripple current (mA rms/125°C, 100k to 400kHz)	Part No.
			20°C	-40°C		
35	47	F80	0.30	3.0	240	EMHK350□RA470MF80G
	100	F80	0.30	3.0	240	EMHK350□RA101MF80G
	220	HA0	0.20	2.0	330	EMHK350□RA221MHA0G

◆RATED RIPPLE CURRENT MULTIPLIERS

●Frequency Multipliers

Capacitance(μF)	Frequency(Hz)			
	120	1k	10k	100k
47 to 100	0.40	0.75	0.90	1.00
220	0.50	0.85	0.94	1.00

The deterioration of aluminum electrolytic capacitors accelerates their life due to the internal heating produced by ripple current. For details, refer to Section "5-3 Ripple Current Effect on Lifetime" in the catalog, Technical Note.

Alchip™-MXB Series

- Endurance : 1,000 hours at 150°C
- Rated voltage range : 25 & 35V, Nominal capacitance range : 330 to 2,400μF
- For automobile modules and other high temperature applications.
- Solvent resistant type (see PRECAUTIONS AND GUIDELINES).
- Vibration resistant structure.
- RoHS2 Compliant
- AEC-Q200 compliant : Please contact Chemi-Con for more details, test data, information.

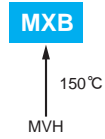

◆ SPECIFICATIONS

Items	Characteristics		
Category	-40 to +150°C		
Temperature Range	-40 to +150°C		
Rated Voltage Range	25, 35V _{dc}		
Capacitance Tolerance	±20%(M) (at 20°C, 120Hz)		
Leakage Current	I=0.03CV Where, I : Max. leakage current (μA), C : Nominal capacitance (μF), V : Rated voltage (V) (at 20°C after 2 minutes)		
Dissipation Factor (tan δ)	Rated voltage(V _{dc})	25V	35V
	tan δ (Max.)	0.16	0.14
	When nominal capacitance exceeds 1,000 μF, add 0.02 to the value above for each 1,000 μF increase. (at 20°C, 120Hz)		
Low Temperature Characteristics (Max. impedance Ratio)	Rated voltage(V _{dc})	25V	35V
	Z(-25°C)/Z(+20°C)	2	2
	Z(-40°C)/Z(+20°C)	4	3
(at 120Hz)			
Endurance	The following specifications shall be satisfied when the capacitors are restored to 20°C after the rated voltage is applied for 1,000 hours at 150°C.		
	Capacitance change	≤ ±30% of the initial value	
	D.F. (tan δ)	≤300% of the initial specified value	
	Leakage current	≤ The initial specified value	
Shelf Life	The following specifications shall be satisfied when the capacitors are restored to 20°C after exposing them for 1,000 hours at 150°C without voltage applied. Before the measurement, the capacitor shall be preconditioned by applying voltage according to Item 4.1 of JIS C 5101-4.		
	Capacitance change	≤ ±30% of the initial value	
	D.F. (tan δ)	≤300% of the initial specified value	
	Leakage current	≤ The initial specified value	

◆ DIMENSIONS [mm]

- Terminal Code : A
- Size code : KE0 to MNO

- Terminal Code : G(Vibration resistant structure)
- Size code : KE0 to MNO

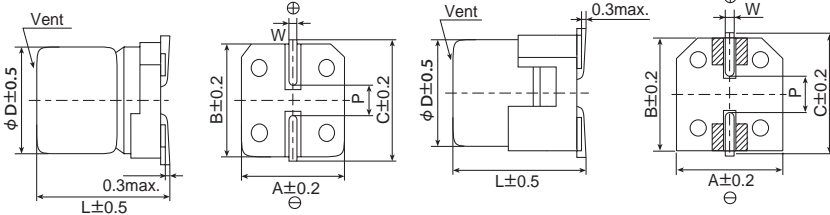

Size code	φD	L	A	B	C	W	P
KE0	12.5	13.5	13.0	13.0	13.7	1.0 to 1.3	4.2
KG5	12.5	16.0	13.0	13.0	13.7	1.0 to 1.3	4.2
LH0	16	16.5	17.0	17.0	18.0	1.0 to 1.3	6.5
LNO	16	21.5	17.0	17.0	18.0	1.0 to 1.3	6.5
MH0	18	16.5	19.0	19.0	20.0	1.0 to 1.3	6.5
MNO	18	21.5	19.0	19.0	20.0	1.0 to 1.3	6.5

▨ : Dummy terminals

◆ PART NUMBERING SYSTEM

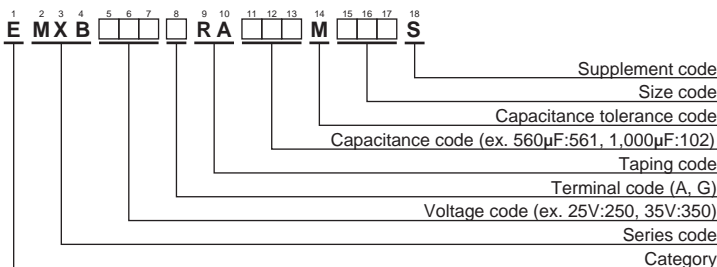

Please refer to "Product code guide (surface mount type)"

◆ MARKING





Alchip™-**MXB**Series

◆ **STANDARD RATINGS**

WV (V _{dc})	Cap (μF)	Size code	ESR (Ω max./100kHz)		Rated ripple current (mA _{rms} /150°C, 100kHz)	Part No.
			20°C	-40°C		
25	560	KE0	0.14	2.1	860	EMXB250□RA561MKE0S
	750	KG5	0.11	1.5	1,000	EMXB250□RA751MKG5S
	1,000	LH0	0.10	1.5	1,120	EMXB250□RA102MLH0S
	1,500	MH0	0.10	1.5	1,210	EMXB250□RA152MMH0S
	1,800	LN0	0.058	0.87	1,460	EMXB250□RA182MLN0S
	2,400	MN0	0.058	0.87	1,560	EMXB250□RA242MMN0S
35	330	KE0	0.27	8.1	670	EMXB350□RA331MKE0S
	390	KG5	0.21	6.3	800	EMXB350□RA391MKG5S
	560	LH0	0.16	4.8	920	EMXB350□RA561MLH0S
	750	MH0	0.13	3.9	1,000	EMXB350□RA751MMH0S
	910	LN0	0.10	3.0	1,260	EMXB350□RA911MLN0S
	1,200	MN0	0.084	1.7	1,320	EMXB350□RA122MMN0S

□ : Enter the appropriate terminal code.

◆ **RATED RIPPLE CURRENT MULTIPLIERS**

⊙ Frequency Multipliers

Capacitance(μF)	Frequency(Hz)			
	120	1k	10k	100k
330 to 560	0.50	0.85	0.94	1.00
750 to 1,800	0.60	0.87	0.95	1.00
2,400	0.75	0.90	0.95	1.00

The deterioration of aluminum electrolytic capacitors accelerates their life due to the internal heating produced by ripple current. For details, refer to Section "5-3 Ripple Current Effect on Lifetime" in the catalog, Technical Note.

Please contact us for lifetime estimation.

CHEMI-CON PART NUMBERING SYSTEM

Product code guide (Radial lead type)

(Example : KMQ series, 100V-100 μ F, ϕ 10 \times 16L, Long lead with bulk)



Please refer to the following table

Contents	Code	Series	Code	Type	Code	Tol.(%)	Code	Sleeve materia	Terminal plating material	Code
Polar	E	KMQ	KMQ	Radial lead	E	\pm 20	M	PET	Sn-Bi	D
		KY	KY-			-10 to +20	V		Sn	S
								Sleeveless (Coating case)	Sn-Bi	G
									Sn	H

1	2	3	4	5	6	7	8	9	10	11	12	13	14	15	16	17	18
E	K	M	Q	1	0	1	E	L	L	1	0	1	M	J	1	6	S
Category	Series code			Voltage code			Terminal code	Lead forming/ Taping code		Capacitance code		Capacitance tolerance	Size code		Supplement code		

Voltage(V)	Code
6.3	6R3
10	100
25	250
100	101
250	251
⋮	⋮

Type	Contents	Code
Lead forming (Bulk)	Long Lead	LL
	Cut(3.5mm)	C3
	Cut(5.0mm)	C5
	Forming Cut	FC
	Snap-in ϕ D=5 to 8	FM
	Snap-in ϕ D=10 to 18	MC
Taping	Horizontal	BC
		BD
	Straight	TD
	Gradual forming	
	Straight(Skip a hole)	TE
Forming(F=5.0mm)	TC	

Cap.(μ F)	Code
1.0	1R0
4.7	4R7
10	100
47	470
100	101
470	471
1,000	102
⋮	⋮

ϕ D(mm)	Code
5	E
6.3	F
8	H
10	J
12.5	K
14.5	U
16	L
18	M

L(mm)	Code
11	11
11.5	B5
12.5	C5
13	13
15	15
16	16
20	20
25	25
30	30
31.5	N3
35	35
35.5	P1
40	40
45	45
50	50

Refer to product guide for lead forming and taping specifications.

*Refer to the appendix (Part number) for codes not listed here.

CUT/FORMED LEAD

<p>Terminal type</p> <p>●Lead code : FC (Forming Cut type) Size : ϕD=5 to 8</p>	<p>Terminal type</p> <p>●Lead code : C3 (Cutting type) Size : ϕD=5 to 18</p> <p>Dimension (C)</p> <ul style="list-style-type: none"> ϕD= 5 to 8 : C3: 3.5\pm0.5(Second standard C5: 5.0\pm0.5) ϕD=10 to 18: C3: 3.5\pm0.5(Second standard C5: 5.0\pm1.0) 	<p>Terminal type</p> <p>●Lead code : IJ (Forming Cut type) Size : ϕD=10 to 18</p> <p>Dimension</p> <table border="1" style="width: 100%; border-collapse: collapse;"> <tr> <th>ϕD</th> <th>A-B</th> <th>ϕd</th> <th>P</th> </tr> <tr> <td>10 to 12.5</td> <td>3.2\pm0.5</td> <td>0.6</td> <td>5.0\pm0.5</td> </tr> <tr> <td>14.5 to 18</td> <td>3.2\pm0.5</td> <td>0.8</td> <td>7.5\pm0.5</td> </tr> </table>	ϕ D	A-B	ϕ d	P	10 to 12.5	3.2 \pm 0.5	0.6	5.0 \pm 0.5	14.5 to 18	3.2 \pm 0.5	0.8	7.5 \pm 0.5
ϕ D	A-B	ϕ d	P											
10 to 12.5	3.2 \pm 0.5	0.6	5.0 \pm 0.5											
14.5 to 18	3.2 \pm 0.5	0.8	7.5 \pm 0.5											
<p>●Lead code : FM (Snap-in type) Size : ϕD=5 to 8</p>	<p>●Lead code : MC (Snap-in type) Size : ϕD=10 to 18</p>	<p>*1 Please consult with us about other terminal forming. *2 Please refer to dimensions of each series for gas escape end seal. *3 Conventionally, lead forming code is used in common by (BC) for two type of the lead bent directions. We added lead forming code (BD) newly and clarified the lead bent directions. Please place an order after the choice for an appropriate lead forming code depending on condition of use.</p>												
<p>●Lead code : BC (Horizontal type)*3 Size : ϕD=10 to 18</p> <p>Dimension (P)</p> <ul style="list-style-type: none"> ϕ10, ϕ12.5 : P=5.0\pm0.5 ϕ14.5, ϕ16, ϕ18 : P=7.5\pm0.5 	<p>●Lead code : BD (Horizontal type)*3 Size : ϕD=10 to 18</p> <p>Dimension (P)</p> <ul style="list-style-type: none"> ϕ10, ϕ12.5 : P=5.0\pm0.5 ϕ14.5, ϕ16, ϕ18 : P=7.5\pm0.5 													

SRG Series



- Low profile : $\phi 10 \times 12.5\text{mm}$ to $\phi 18 \times 25\text{mm}$
- Endurance : 2,000 hours at 85°C
- Solvent resistant type (see PRECAUTIONS AND GUIDELINES)
- RoHS2 Compliant

SPECIFICATIONS

Items	Characteristics						
Category	-40 to +85°C						
Temperature Range	-40 to +85°C						
Rated Voltage Range	6.3 to 50V _{dc}						
Capacitance Tolerance	$\pm 20\%$ (M) (at 20°C, 120Hz)						
Leakage Current	I=0.01CV or 3 μ A, whichever is greater. Where, I : Max. leakage current (μ A), C : Nominal capacitance (μ F), V : Rated voltage (V) (at 20°C after 2 minutes)						
Dissipation Factor (tan δ)	Rated voltage (V _{dc})	6.3V	10V	16V	25V	35V	50V
	tan δ (Max.)	0.28	0.24	0.20	0.16	0.14	0.12
	When nominal capacitance exceeds 1,000 μ F, add 0.03 to the value above for each 1,000 μ F increase. (at 20°C, 120Hz)						
Low Temperature Characteristics (Max. Impedance Ratio)	Rated voltage (V _{dc})	6.3V	10V	16V	25V	35V	50V
	Z(-25°C)/Z(+20°C)	5	4	3	2	2	2
	Z(-40°C)/Z(+20°C)	12	10	8	5	4	3
Endurance	The following specifications shall be satisfied when the capacitors are restored to 20°C after the rated voltage is applied for 2,000 hours at 85°C.						
	Capacitance change	$\leq \pm 20\%$ of the initial value					
	D.F. (tan δ)	$\leq 200\%$ of the initial specified value					
	Leakage current	\leq The initial specified value					
Shelf Life	The following specifications shall be satisfied when the capacitors are restored to 20°C after exposing them for 1,000 hours at 85°C without voltage applied. Before the measurement, the capacitor shall be preconditioned by applying voltage according to Item 4.1 of JIS C 5101-4.						
	Capacitance change	$\leq \pm 20\%$ of the initial value					
	D.F. (tan δ)	$\leq 200\%$ of the initial specified value					
	Leakage current	\leq The initial specified value					

DIMENSIONS [mm]

● Terminal Code : E

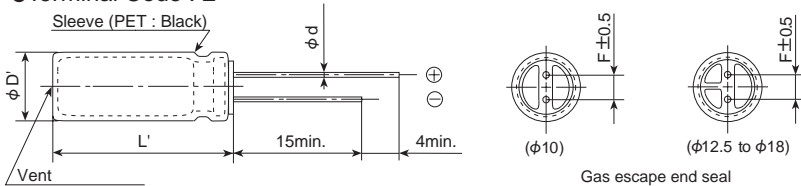

ϕD	10 & 12.5	16 & 18
ϕd	0.6	0.8
F	5.0	7.5
$\phi D'$	$\phi D + 0.5\text{max.}$	
L'	L + 1.5max.	

PART NUMBERING SYSTEM

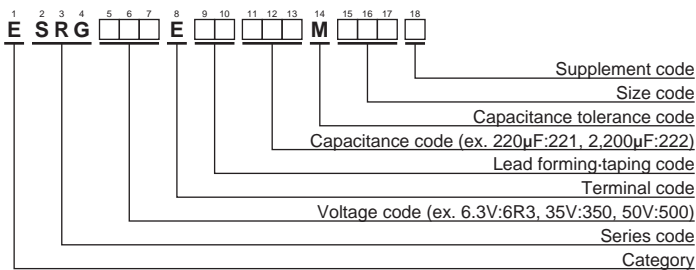

Please refer to "Product code guide (radial lead type)"



SRG Series

◆ STANDARD RATINGS

WV (V _{dc})	Cap (μF)	Case code φD×L(mm)	tan δ	Rated ripple current (mA _{rms} /85°C, 120Hz)	Part No.	WV (V _{dc})	Cap (μF)	Case code φD×L(mm)	tan δ	Rated ripple current (mA _{rms} /85°C, 120Hz)	Part No.
6.3	4,700	16 × 15	0.37	1,410	ESRG6R3E□□472ML15S	25	470	10 × 12.5	0.16	525	ESRG250E□□471MJC5S
	6,800	18 × 15	0.43	1,660	ESRG6R3E□□682MM15S		1,000	12.5 × 15	0.16	830	ESRG250E□□102MK15S
	10,000	18 × 20	0.55	2,020	ESRG6R3E□□103MM20S		2,200	18 × 15	0.19	1,360	ESRG250E□□222MM15S
10	1,000	10 × 12.5	0.24	625	ESRG100E□□102MJC5S	35	3,300	18 × 20	0.22	1,720	ESRG250E□□332MM20S
	2,200	12.5 × 15	0.27	970	ESRG100E□□222MK15S		4,700	18 × 25	0.25	2,070	ESRG250E□□472MM25S
	3,300	16 × 15	0.30	1,310	ESRG100E□□332ML15S		330	10 × 12.5	0.14	475	ESRG350E□□331MJC5S
	4,700	18 × 15	0.33	1,560	ESRG100E□□472MM15S	470	12.5 × 13	0.14	585	ESRG350E□□471MK13S	
	6,800	18 × 20	0.39	1,870	ESRG100E□□682MM20S	1,000	16 × 15	0.14	1,010	ESRG350E□□102ML15S	
	10,000	18 × 25	0.51	2,370	ESRG100E□□103MM25S	2,200	18 × 20	0.17	1,560	ESRG350E□□222MM20S	
16	1,000	12.5 × 13	0.20	715	ESRG160E□□102MK13S	50	220	10 × 12.5	0.12	415	ESRG500E□□221MJC5S
	2,200	16 × 15	0.23	1,160	ESRG160E□□222ML15S		330	12.5 × 13	0.12	525	ESRG500E□□331MK13S
	3,300	18 × 15	0.26	1,460	ESRG160E□□332MM15S		470	16 × 15	0.12	745	ESRG500E□□471ML15S
	4,700	18 × 20	0.29	1,770	ESRG160E□□472MM20S		1,000	18 × 20	0.12	1,160	ESRG500E□□102MM20S
	6,800	18 × 25	0.35	2,170	ESRG160E□□682MM25S						

□□ : Enter the appropriate lead forming or taping code.

◆ RATED RIPPLE CURRENT MULTIPLIERS

● Frequency Multipliers

Capacitance(μF)	Frequency(Hz)	50	120	300	1k	10k	100k
220 to 1,000		0.80	1.00	1.15	1.30	1.40	1.50
2,200 to		0.85	1.00	1.03	1.05	1.08	1.08

The deterioration of aluminum electrolytic capacitors accelerates their life due to the internal heating produced by ripple current. For details, refer to Section "5-3 Ripple Current Effect on Lifetime" in the catalog, Technical Note.

KRG Series



- Low profile : $\phi 10 \times 12.5\text{mm}$ to $\phi 18 \times 25\text{mm}$
- Endurance : 1,000 hours at 105°C
- Solvent resistant type (see PRECAUTIONS AND GUIDELINES)
- RoHS2 Compliant

SPECIFICATIONS

Items	Characteristics						
Category	-55 to +105°C						
Temperature Range	-55 to +105°C						
Rated Voltage Range	6.3 to 50V _{dc}						
Capacitance Tolerance	±20% (M) (at 20°C, 120Hz)						
Leakage Current	I=0.01CV or 3μA, whichever is greater. Where, I : Max. leakage current (μA), C : Nominal capacitance (μF), V : Rated voltage (V) (at 20°C after 2 minutes)						
Dissipation Factor (tan δ)	Rated voltage (V _{dc})	6.3V	10V	16V	25V	35V	50V
	tan δ (Max.)	0.28	0.24	0.20	0.16	0.14	0.12
	When nominal capacitance exceeds 1,000μF, add 0.03 to the value above for each 1,000μF increase. (at 20°C, 120Hz)						
Low Temperature Characteristics (Max. Impedance Ratio)	Rated voltage (V _{dc})	6.3V	10V	16V	25V	35V	50V
	Z(-25°C)/Z(+20°C)	5	4	3	2	2	2
	Z(-40°C)/Z(+20°C)	10	8	6	4	3	3
Endurance	The following specifications shall be satisfied when the capacitors are restored to 20°C after the rated voltage is applied for 1,000 hours at 105°C.						
	Rated voltage	6.3 to 16V _{dc}			25 to 50V _{dc}		
	Capacitance change	≤ ±25% of the initial value			≤ ±20% of the initial value		
	D.F. (tan δ)	≤200% of the initial specified value			≤200% of the initial specified value		
	Leakage current	≤The initial specified value			≤The initial specified value		
Shelf Life	The following specifications shall be satisfied when the capacitors are restored to 20°C after exposing them for 500 hours at 105°C without voltage applied. Before the measurement, the capacitor shall be preconditioned by applying voltage according to Item 4.1 of JIS C 5101-4.						
	Rated voltage	6.3 to 16V _{dc}			25 to 50V _{dc}		
	Capacitance change	≤ ±25% of the initial value			≤ ±20% of the initial value		
	D.F. (tan δ)	≤200% of the initial specified value			≤200% of the initial specified value		
	Leakage current	≤The initial specified value			≤The initial specified value		

DIMENSIONS [mm]

● Terminal Code : E

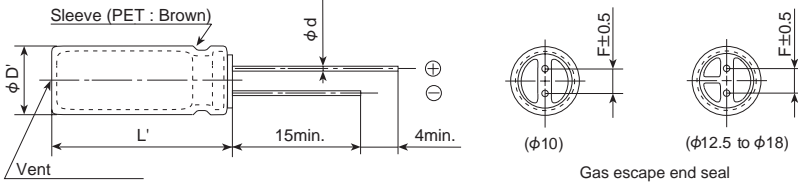

φD	10 & 12.5	16 & 18
φd	0.6	0.8
F	5.0	7.5
φD'	φD+0.5max.	
L'	L+1.5max.	

PART NUMBERING SYSTEM

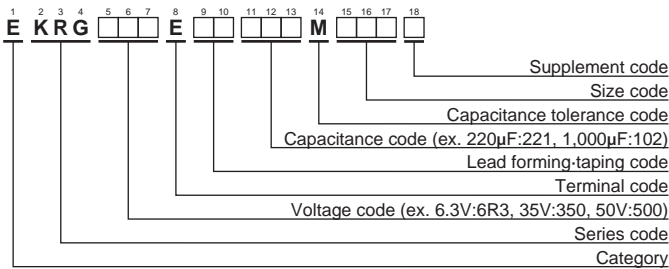

Please refer to "Product code guide (radial lead type)"



KRG Series

◆ STANDARD RATINGS

WV (V _{dc})	Cap (μF)	Case size φD×L(mm)	tan δ	Rated ripple current (mA _{rms} /105°C, 120Hz)	Part No.	WV (V _{dc})	Cap (μF)	Case size φD×L(mm)	tan δ	Rated ripple current (mA _{rms} /105°C, 120Hz)	Part No.
6.3	4,700	16 × 15	0.37	1,010	EKRG6R3E□□472ML15S	25	470	10 × 12.5	0.16	370	EKRG250E□□471MJC5S
	6,800	18 × 15	0.43	1,190	EKRG6R3E□□682MM15S		1,000	12.5 × 15	0.16	590	EKRG250E□□102MK15S
	10,000	18 × 20	0.55	1,440	EKRG6R3E□□103MM20S		2,200	18 × 15	0.19	970	EKRG250E□□222MM15S
10	1,000	10 × 12.5	0.24	445	EKRG100E□□102MJC5S	35	3,300	18 × 20	0.22	1,220	EKRG250E□□332MM20S
	2,200	12.5 × 15	0.27	690	EKRG100E□□222MK15S		4,700	18 × 25	0.25	1,470	EKRG250E□□472MM25S
	3,300	16 × 15	0.30	940	EKRG100E□□332ML15S	50	330	10 × 12.5	0.14	340	EKRG350E□□331MJC5S
	4,700	18 × 15	0.33	1,120	EKRG100E□□472MM15S		470	12.5 × 13	0.14	415	EKRG350E□□471MK13S
	6,800	18 × 20	0.39	1,330	EKRG100E□□682MM20S		1,000	16 × 15	0.14	720	EKRG350E□□102ML15S
	10,000	18 × 25	0.51	1,700	EKRG100E□□103MM25S		2,200	18 × 20	0.17	1,110	EKRG350E□□222MM20S
16	1,000	12.5 × 13	0.20	515	EKRG160E□□102MK13S	50	220	10 × 12.5	0.12	290	EKRG500E□□221MJC5S
	2,200	16 × 15	0.23	830	EKRG160E□□222ML15S		330	12.5 × 13	0.12	370	EKRG500E□□331MK13S
	3,300	18 × 15	0.26	1,050	EKRG160E□□332MM15S		470	16 × 15	0.12	535	EKRG500E□□471ML15S
	4,700	18 × 20	0.29	1,260	EKRG160E□□472MM20S		1,000	18 × 20	0.12	830	EKRG500E□□102MM20S
	6,800	18 × 25	0.35	1,560	EKRG160E□□682MM25S						

□□ : Enter the appropriate lead forming or taping code.

◆ RATED RIPPLE CURRENT MULTIPLIERS

● Frequency Multipliers

Capacitance(μF)	Frequency(Hz)	50	120	300	1k	10k	100k
220 to 1,000		0.80	1.00	1.15	1.30	1.40	1.50
2,200 to		0.85	1.00	1.03	1.05	1.08	1.08

The deterioration of aluminum electrolytic capacitors accelerates their life due to the internal heating produced by ripple current. For details, refer to Section "5-3 Ripple Current Effect on Lifetime" in the catalog, Technical Note.



KMQ Series

- Downsized from current standard KMG series
- Solvent resistant type except 160 to 450V_{dc} (see PRECAUTIONS AND GUIDELINES)
- RoHS2 Compliant



SPECIFICATIONS

Items	Characteristics													
Category	-55 to +105°C(6.3 to 100V _{dc}) -40 to +105°C(160 to 400V _{dc}) -25 to +105°C(450V _{dc})													
Temperature Range														
Rated Voltage Range	6.3 to 450V _{dc}													
Capacitance Tolerance	±20% (M) (at 20°C, 120Hz)													
Leakage Current	6.3 to 100V _{dc}						160 to 450V _{dc}							
	I=0.03CV or 4μA, whichever is greater.						CV≤1,000		I=0.1CV+40 max.					
							CV>1,000		I=0.04CV+100 max.					
Where, I : Max. leakage current (μA), C : Nominal capacitance (μF), V : Rated voltage (V) (at 20°C after 1 minute)														
Dissipation Factor (tan δ)	Rated voltage (V _{dc})	6.3V	10V	16V	25V	35V	50V	63V	100V	160 to 250V	350 to 400V	450V		
	tan δ (Max.)	0.28	0.24	0.20	0.16	0.14	0.12	0.10	0.08	0.20	0.24	0.24		
	When nominal capacitance exceeds 1,000μF, add 0.02 to the value above for each 1,000μF increase. (at 20°C, 120Hz)													
Low Temperature Characteristics (Max. Impedance Ratio)	Rated voltage (V _{dc})	6.3V	10V	16V	25V	35V	50V	63 to 100V	160 to 200V	250V	350V	400V	450V	
	Z(-25°C)/Z(+20°C)	≤φ8	5	4	3	2	2	2	2	3	3	4	4	6
		≥φ10	5	4	3	2	2	2	2	3	3	4	4	6
	Z(-40°C)/Z(+20°C)	≤φ8	10	8	6	4	3	3	3	8	10	8	8	—
≥φ10		10	8	6	4	3	3	3	4	4	6	6	—	
(at 120Hz)														
Endurance	The following specifications shall be satisfied when the capacitors are restored to 20°C after subjected to DC voltage with the rated ripple current is applied (the peak voltage shall not exceed the rated voltage) for 1,000 hours (2,000 hours for φ 10 and more) at 105°C.													
	Capacitance change	≤ ±20% of the initial value												
	D.F. (tan δ)	≤200% of the initial specified value												
	Leakage current	≤The initial specified value												
Shelf Life	The following specifications shall be satisfied when the capacitors are restored to 20°C after exposing them for 1,000 hours at 105°C without voltage applied. Before the measurement, the capacitor shall be preconditioned by applying voltage according to Item 4.1 of JIS C 5101-4.													
	Rated voltage	6.3 to 100V _{dc}						160 to 450V _{dc}						
	Capacitance change	≤ ±20% of the initial value						≤ ±20% of the initial value						
	D.F. (tan δ)	≤200% of the initial specified value						≤200% of the initial specified value						
	Leakage current	≤The initial specified value						≤500% of the initial specified value						

DIMENSIONS [mm]

- Terminal Code : E

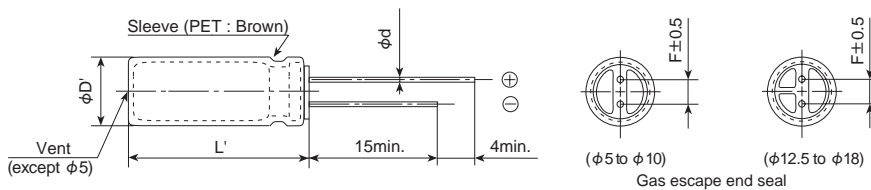

φD	5	6.3	8	10	12.5	16	18
φd	0.5	0.5	0.6	0.6	0.6	0.8	0.8
F	2.0	2.5	3.5	5.0	5.0	7.5	7.5
φD'	φD+0.5max.						
L'	L+1.5max.						

PART NUMBERING SYSTEM

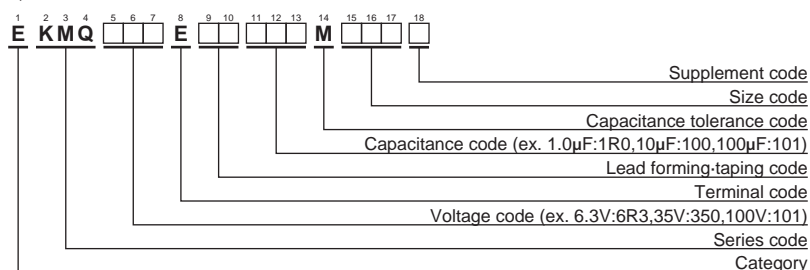

Please refer to "Product code guide (radial lead type)"



◆STANDARD RATINGS

WV (V _{dc})	Cap (μF)	Case size φD×L(mm)	tan δ	Rated ripple current (mA _{rms} /105°C, 120Hz)	Part No.	WV (V _{dc})	Cap (μF)	Case size φD×L(mm)	tan δ	Rated ripple current (mA _{rms} /105°C, 120Hz)	Part No.			
6.3	1,000	8 × 11.5	0.28	390	EKMQR3E□□102MHB5D	50	220	10 × 12.5	0.12	300	EKMQ500E□□221MJC5S			
	2,200	10 × 16	0.30	635	EKMQR3E□□222MJ16S		330	10 × 16	0.12	410	EKMQ500E□□331MJ16S			
	3,300	10 × 20	0.32	840	EKMQR3E□□332MJ20S		470	10 × 20	0.12	540	EKMQ500E□□471MJ20S			
	4,700	12.5 × 20	0.34	1,090	EKMQR3E□□472MK20S		1,000	12.5 × 25	0.12	950	EKMQ500E□□102MK25S			
	6,800	12.5 × 25	0.38	1,350	EKMQR3E□□682MK25S		2,200	16 × 31.5	0.14	1,410	EKMQ500E□□222MLN3S			
	10,000	16 × 25	0.46	1,650	EKMQR3E□□103ML25S		3,300	18 × 35.5	0.16	1,770	EKMQ500E□□332MMP1S			
	15,000	16 × 31.5	0.56	1,820	EKMQR3E□□153MLN3S									
22,000	18 × 35.5	0.70	2,280	EKMQR3E□□223MMP1S										
10	220	5 × 11	0.24	155	EKMQ100E□□221ME11D	63	22	5 × 11	0.10	71	EKMQ630E□□220ME11D			
	330	6.3 × 11	0.24	210	EKMQ100E□□331MF11D		33	6.3 × 11	0.10	100	EKMQ630E□□330MF11D			
	470	6.3 × 11	0.24	250	EKMQ100E□□471MF11D		47	6.3 × 11	0.10	120	EKMQ630E□□470MF11D			
	1,000	10 × 12.5	0.24	460	EKMQ100E□□102MJC5S		68	8 × 11.5	0.10	155	EKMQ630E□□680MHB5D			
	2,200	10 × 16	0.26	705	EKMQ100E□□222MJ16S		100	8 × 11.5	0.10	200	EKMQ630E□□101MHB5D			
	3,300	12.5 × 20	0.28	1,000	EKMQ100E□□332MK20S		220	10 × 16	0.10	335	EKMQ630E□□221MJ16S			
	4,700	12.5 × 25	0.30	1,260	EKMQ100E□□472MK25S		330	10 × 20	0.10	510	EKMQ630E□□331MJ20S			
	6,800	16 × 25	0.34	1,570	EKMQ100E□□682ML25S		470	12.5 × 20	0.10	640	EKMQ630E□□471MK20S			
	10,000	16 × 31.5	0.42	1,820	EKMQ100E□□103MLN3S		1,000	16 × 25	0.10	930	EKMQ630E□□101MK25S			
15,000	16 × 35.5	0.52	2,050	EKMQ100E□□153MLP1S	2,200	18 × 35.5	0.12	1,650	EKMQ630E□□222MMP1S					
22,000	18 × 40	0.66	2,420	EKMQ100E□□223MM40S										
16	220	6.3 × 11	0.20	190	EKMQ160E□□221MF11D	100	1.0	5 × 11	0.08	15	EKMQ101E□□1R0ME11D			
	330	6.3 × 11	0.20	225	EKMQ160E□□331MF11D		2.2	5 × 11	0.08	21	EKMQ101E□□2R2ME11D			
	470	8 × 11.5	0.20	315	EKMQ160E□□471MHB5D		3.3	5 × 11	0.08	29	EKMQ101E□□3R3ME11D			
	1,000	10 × 12.5	0.20	500	EKMQ160E□□102MJC5S		4.7	5 × 11	0.08	32	EKMQ101E□□4R7ME11D			
	2,200	10 × 20	0.22	710	EKMQ160E□□222MJ20S		10	5 × 11	0.08	50	EKMQ101E□□100ME11D			
	3,300	12.5 × 25	0.24	1,170	EKMQ160E□□332MK25S		22	6.3 × 11	0.08	93	EKMQ101E□□220MF11D			
	4,700	16 × 25	0.26	1,500	EKMQ160E□□472ML25S		33	8 × 11.5	0.08	130	EKMQ101E□□330MHB5D			
	6,800	16 × 25	0.30	1,600	EKMQ160E□□682ML25S		47	8 × 11.5	0.08	140	EKMQ101E□□470MHB5D			
	10,000	16 × 35.5	0.38	1,930	EKMQ160E□□103MLP1S		68	10 × 12.5	0.08	190	EKMQ101E□□680MJC5S			
	15,000	18 × 40	0.48	2,210	EKMQ160E□□153MM40S		100	10 × 16	0.08	240	EKMQ101E□□101MJ16S			
25	100	5 × 11	0.16	125	EKMQ250E□□101ME11D	160	220	12.5 × 20	0.08	390	EKMQ101E□□221MK20S			
	220	6.3 × 11	0.16	200	EKMQ250E□□102MF11D		330	12.5 × 25	0.08	540	EKMQ101E□□331MK25S			
	330	8 × 11.5	0.16	310	EKMQ250E□□331MHB5D		470	16 × 25	0.08	715	EKMQ101E□□471ML25S			
	470	10 × 12.5	0.16	380	EKMQ250E□□471MJC5S		1,000	18 × 35.5	0.08	960	EKMQ101E□□102MMP1S			
	1,000	10 × 16	0.16	610	EKMQ250E□□102MJ16S		68	12.5 × 20	0.20	250	EKMQ161E□□680MK20S			
	2,200	12.5 × 25	0.18	1,090	EKMQ250E□□222MK25S		100	12.5 × 25	0.20	310	EKMQ161E□□101MK25S			
	3,300	16 × 25	0.20	1,400	EKMQ250E□□332ML25S		220	16 × 31.5	0.20	540	EKMQ161E□□221MLN3S			
	4,700	16 × 25	0.22	1,570	EKMQ250E□□472ML25S		330	18 × 35.5	0.20	705	EKMQ161E□□331MMP1S			
	6,800	16 × 35.5	0.26	1,850	EKMQ250E□□682MLP1S		470	18 × 40	0.20	855	EKMQ161E□□471MM40S			
	10,000	18 × 40	0.34	2,000	EKMQ250E□□103MM40S									
35	47	5 × 11	0.14	93	EKMQ350E□□470ME11D	200	47	12.5 × 20	0.20	195	EKMQ201E□□470MK20S			
	68	6.3 × 11	0.14	110	EKMQ350E□□680MF11D		68	12.5 × 25	0.20	250	EKMQ201E□□680MK25S			
	100	6.3 × 11	0.14	150	EKMQ350E□□101MF11D		100	16 × 25	0.20	335	EKMQ201E□□101ML25S			
	220	8 × 11.5	0.14	270	EKMQ350E□□221MHB5D		220	16 × 35.5	0.20	500	EKMQ201E□□221MMP1S			
	330	10 × 12.5	0.14	350	EKMQ350E□□331MJC5S		330	18 × 40	0.20	675	EKMQ201E□□331MM40S			
	470	10 × 16	0.14	460	EKMQ350E□□471MJ16S									
	1,000	12.5 × 20	0.14	810	EKMQ350E□□102MK20S		47	12.5 × 20	0.20	190	EKMQ251E□□470MK20S			
	2,200	16 × 25	0.16	1,260	EKMQ350E□□222ML25S		68	16 × 25	0.20	270	EKMQ251E□□680ML25S			
	3,300	16 × 31.5	0.18	1,500	EKMQ350E□□332MLN3S		100	16 × 25	0.20	310	EKMQ251E□□101ML25S			
	4,700	16 × 35.5	0.20	1,780	EKMQ350E□□472MLP1S		220	18 × 35.5	0.20	485	EKMQ251E□□221MMP1S			
6,800	18 × 40	0.24	2,000	EKMQ350E□□682MM40S										
50	1.0	5 × 11	0.12	13	EKMQ500E□□1R0ME11D	350	22	12.5 × 20	0.24	130	EKMQ351E□□220MK20S			
	2.2	5 × 11	0.12	20	EKMQ500E□□2R2ME11D		33	12.5 × 25	0.24	170	EKMQ351E□□330MK25S			
	3.3	5 × 11	0.12	25	EKMQ500E□□3R3ME11D		47	16 × 25	0.24	230	EKMQ351E□□470ML25S			
	4.7	5 × 11	0.12	30	EKMQ500E□□4R7ME11D		68	16 × 25	0.24	285	EKMQ351E□□680ML25S			
	10	5 × 11	0.12	46	EKMQ500E□□100ME11D		100	18 × 31.5	0.24	375	EKMQ351E□□101MMN3S			
	22	5 × 11	0.12	68	EKMQ500E□□220ME11D									
	33	5 × 11	0.12	90	EKMQ500E□□330ME11D		22	12.5 × 25	0.24	145	EKMQ401E□□220MK25S			
	47	6.3 × 11	0.12	115	EKMQ500E□□470MF11D		33	16 × 25	0.24	195	EKMQ401E□□330ML25S			
	68	6.3 × 11	0.12	150	EKMQ500E□□680MF11D		47	16 × 25	0.24	200	EKMQ401E□□470ML25S			
	100	8 × 11.5	0.12	190	EKMQ500E□□101MHB5D		68	16 × 31.5	0.24	240	EKMQ401E□□680MLN3S			
50	22	5 × 11	0.12	68	EKMQ500E□□220ME11D	400	100	18 × 35.5	0.24	310	EKMQ401E□□101MMP1S			
	33	5 × 11	0.12	90	EKMQ500E□□330ME11D		22	12.5 × 25	0.24	145	EKMQ451E□□220MK25S			
	47	6.3 × 11	0.12	115	EKMQ500E□□470MF11D		33	16 × 25	0.24	125	EKMQ451E□□330ML25S			
	68	6.3 × 11	0.12	150	EKMQ500E□□680MF11D		47	16 × 25	0.24	155	EKMQ451E□□470MLN3S			
	100	8 × 11.5	0.12	190	EKMQ500E□□101MHB5D		68	18 × 35.5	0.24	185	EKMQ451E□□680MMP1S			
	50	22	5 × 11	0.12	68		EKMQ500E□□220ME11D	450	100	18 × 40	0.24	200	EKMQ451E□□101MM40S	
		33	5 × 11	0.12	90		EKMQ500E□□330ME11D							
		47	6.3 × 11	0.12	115		EKMQ500E□□470MF11D							
		68	6.3 × 11	0.12	150		EKMQ500E□□680MF11D							
		100	8 × 11.5	0.12	190		EKMQ500E□□101MHB5D							

□□ : Enter the appropriate lead forming or taping code.
 Production of the products shown in □□□□ is scheduled to be discontinued.
 *1: Assembly boards with the designated products attached cannot be cleaned.



KMQ Series

◆ RATED RIPPLE CURRENT MULTIPLIERS

● Frequency Multipliers

Capacitance(μF) \ Frequency(Hz)	50	120	300	1k	10k	100k
1.0 to 4.7	0.65	1.00	1.35	1.75	2.30	2.50
10 to 68	0.75	1.00	1.25	1.50	1.75	1.80
100 to 1,000	0.80	1.00	1.15	1.30	1.40	1.50
2,200 to	0.85	1.00	1.03	1.05	1.08	1.08

The deterioration of aluminum electrolytic capacitors accelerates their life due to the internal heating produced by ripple current. For details, refer to Section "5-3 Ripple Current Effect on Lifetime" in the catalog, Technical Note.



KZN Series

- Adoption of innovative high stability electrolyte
- High ripple current and long endurance
- Rated voltage range : 6.3 to 100V_{dc}, Capacitance range : 8.2 to 22,000μF
- Endurance with ripple current : 6,000 to 10,000 hours at 105°C
- Non solvent resistant type
- RoHS2 Compliant



SPECIFICATIONS

Items	Characteristics	
Category	-40 to +105°C	
Temperature Range		
Rated Voltage Range	6.3 to 100V _{dc}	
Capacitance Tolerance	±20% (M) (at 20°C, 120Hz)	
Leakage Current	I=0.01CV or 3μA, whichever is greater. Where, I : Max. leakage current (μA), C : Nominal capacitance (μF), V : Rated voltage (V) (at 20°C after 2 minutes)	
Dissipation Factor (tan δ)	Rated voltage (V _{dc})	6.3V 10V 16V 25V 35V 50V 63V 80V 100V
	tan δ (Max.)	0.22 0.19 0.16 0.14 0.12 0.10 0.09 0.09 0.08
	When nominal capacitance exceeds 1,000μF, add 0.02 to the value above for each 1,000μF increase. (at 20°C, 120Hz)	
Low Temperature Characteristics (Max. Impedance Ratio)	Z (-25°C) / Z (+20°C)	2max.
	Z (-40°C) / Z (+20°C)	3max.
Endurance	The following specifications shall be satisfied when the capacitors are restored to 20°C after subjected to DC voltage with the rated ripple current is applied (the peak voltage shall not exceed the rated voltage) for the specified period of time at 105°C.	
	Time	Case size φ 5 & φ 6.3 φ 8 × 11.5L φ 10 × 12.5L φ 8 × 15L, 20L φ 10 × 16L, 20L, 25L φ 12.5 to φ 18
		6.3V _{dc} 6,000 hours 8,000 hours 9,000 hours 9,000 hours 10,000 hours
		10 to 50V _{dc} 7,000 hours 9,000 hours 9,000 hours 10,000 hours 10,000 hours
		63 to 100V _{dc} 6,000 hours 8,000 hours 9,000 hours 9,000 hours 10,000 hours
	Capacitance change	≤ ±25% of the initial value (6.3, 10V _{dc} : ≤ ±30%)
	D.F. (tan δ)	≤ 200% of the initial specified value
Leakage current	≤ The initial specified value	
Shelf Life	The following specifications shall be satisfied when the capacitors are restored to 20°C after exposing them for 500 hours at 105°C without voltage applied. Before the measurement, the capacitor shall be preconditioned by applying voltage according to Item 4.1 of JIS C 5101-4.	
	Capacitance change	≤ ±25% of the initial value (6.3, 10V _{dc} : ≤ ±30%)
	D.F. (tan δ)	≤ 200% of the initial specified value
	Leakage current	≤ The initial specified value

DIMENSIONS [mm]

- Terminal Code : E

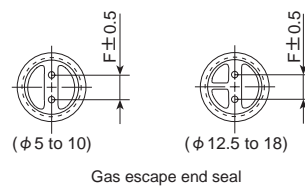
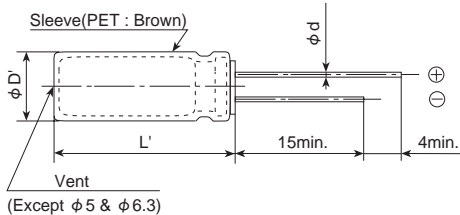

φ D	5	6.3	8	10	12.5	16	18
φ d	0.5	0.5	0.6	0.6	0.6	0.8	0.8
F	2.0	2.5	3.5	5.0	5.0	7.5	7.5
D'	φ D + 0.5max.						
L'	L + 1.5max.						

PART NUMBERING SYSTEM

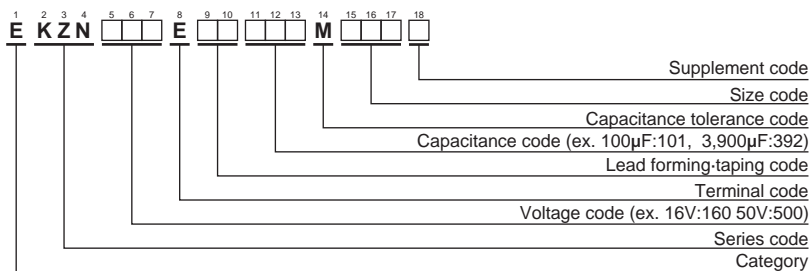

Please refer to "Product code guide (radial lead type)"



KZN Series

◆ STANDARD RATINGS

WV (V _{dc})	Cap (μF)	Case size φD×L(mm)	Impedance (Ω max./100kHz)		Rated ripple current (mA rms/105°C, 100kHz)	Part No.	WV (V _{dc})	Cap (μF)	Case size φD×L(mm)	Impedance (Ω max./100kHz)		Rated ripple current (mA rms/105°C, 100kHz)	Part No.	
			20°C	-10°C						20°C	-10°C			
6.3	220	5×11	0.38	1.2	345	EKZN6R3E□□221ME11D	16	3,300	12.5×30	0.018	0.054	3,660	EKZN160E□□332MK30S	
	470	6.3×11	0.17	0.51	540	EKZN6R3E□□471MF11D		3,900	12.5×35	0.016	0.048	4,120	EKZN160E□□392MK35S	
	820	8×11.5	0.075	0.23	945	EKZN6R3E□□821MHB5D		3,900	16×20	0.021	0.063	3,330	EKZN160E□□392ML20S	
	1,200	8×15	0.059	0.18	1,250	EKZN6R3E□□122MH15D		4,700	18×20	0.020	0.060	3,450	EKZN160E□□472MM20S	
	1,200	10×12.5	0.053	0.16	1,330	EKZN6R3E□□122MJC5S		5,600	16×25	0.017	0.051	3,810	EKZN160E□□562ML25S	
	1,500	8×20	0.041	0.13	1,500	EKZN6R3E□□152MH20D		6,800	16×31.5	0.016	0.048	4,100	EKZN160E□□682MLN3S	
	1,800	10×16	0.038	0.12	1,760	EKZN6R3E□□182MJ16S		6,800	18×25	0.016	0.048	3,880	EKZN160E□□682MM25S	
	2,700	10×20	0.028	0.084	1,960	EKZN6R3E□□272MJ20S		8,200	16×35.5	0.014	0.042	4,280	EKZN160E□□822MLP1S	
	2,700	12.5×16	0.035	0.11	1,900	EKZN6R3E□□272MK16S		8,200	18×31.5	0.014	0.042	4,190	EKZN160E□□822MMN3S	
	3,300	10×25	0.026	0.072	2,250	EKZN6R3E□□332MJ25S		10,000	16×40	0.013	0.039	4,580	EKZN160E□□103ML40S	
	3,900	12.5×20	0.025	0.075	2,480	EKZN6R3E□□392MK20S		10,000	18×35.5	0.012	0.036	4,380	EKZN160E□□103MMP1S	
	5,600	12.5×25	0.019	0.057	2,900	EKZN6R3E□□562MK25S		12,000	18×40	0.011	0.033	4,960	EKZN160E□□123MM40S	
	6,800	12.5×30	0.018	0.054	3,450	EKZN6R3E□□682MK30S		25	68	5×11	0.38	1.2	450	EKZN250E□□680ME11D
	6,800	16×20	0.021	0.063	3,250	EKZN6R3E□□682ML20S			150	6.3×11	0.17	0.51	700	EKZN250E□□151MF11D
	8,200	12.5×35	0.016	0.048	3,570	EKZN6R3E□□822MK35S			270	8×11.5	0.075	0.23	1,200	EKZN250E□□271MHB5D
	8,200	18×20	0.020	0.060	3,450	EKZN6R3E□□822MM20S			470	8×15	0.059	0.18	1,600	EKZN250E□□471MH15D
	10,000	16×25	0.017	0.051	3,630	EKZN6R3E□□103ML25S			470	10×12.5	0.053	0.16	1,700	EKZN250E□□471MJC5S
	12,000	16×31.5	0.016	0.048	4,100	EKZN6R3E□□123MLN3S			560	8×20	0.041	0.13	1,960	EKZN250E□□561MH20D
	12,000	18×25	0.016	0.048	3,880	EKZN6R3E□□123MM25S			680	10×16	0.038	0.12	2,000	EKZN250E□□681MJ16S
	15,000	16×35.5	0.014	0.042	4,280	EKZN6R3E□□153MLP1S			820	10×20	0.028	0.084	2,500	EKZN250E□□821MJ20S
	15,000	18×31.5	0.014	0.042	4,190	EKZN6R3E□□153MMN3S			1,000	12.5×16	0.035	0.11	2,400	EKZN250E□□102MK16S
	18,000	16×40	0.013	0.039	4,580	EKZN6R3E□□183ML40S			1,200	10×25	0.026	0.072	2,900	EKZN250E□□122MJ25S
18,000	18×35.5	0.012	0.036	4,380	EKZN6R3E□□183MMP1S	1,500	12.5×20		0.025	0.075	2,600	EKZN250E□□152MK20S		
22,000	18×40	0.011	0.033	4,960	EKZN6R3E□□223MM40S	1,800	12.5×25		0.019	0.057	3,200	EKZN250E□□182MK25S		
10	150	5×11	0.38	1.2	450	EKZN100E□□151ME11D	2,200		12.5×30	0.018	0.054	3,660	EKZN250E□□222MK30S	
	330	6.3×11	0.17	0.51	700	EKZN100E□□331MF11D	2,200		16×20	0.021	0.063	3,330	EKZN250E□□222ML20S	
	560	8×11.5	0.075	0.23	1,200	EKZN100E□□561MHB5D	2,700		12.5×35	0.016	0.048	4,120	EKZN250E□□272MK35S	
	820	8×15	0.059	0.18	1,600	EKZN100E□□821MH15D	3,300		16×25	0.017	0.051	3,810	EKZN250E□□332ML25S	
	1,000	8×20	0.041	0.13	1,960	EKZN100E□□102MH20D	3,300		18×20	0.020	0.060	3,450	EKZN250E□□332MM20S	
	1,000	10×12.5	0.053	0.16	1,700	EKZN100E□□102MJC5S	4,700		16×31.5	0.016	0.048	4,100	EKZN250E□□472MLN3S	
	1,200	10×16	0.038	0.12	2,000	EKZN100E□□122MJ16S	4,700		18×25	0.016	0.048	3,880	EKZN250E□□472MM25S	
	1,800	10×20	0.028	0.084	2,500	EKZN100E□□182MJ20S	5,600		16×35.5	0.014	0.042	4,280	EKZN250E□□562MLP1S	
	1,800	12.5×16	0.035	0.11	2,400	EKZN100E□□182MK16S	5,600		18×31.5	0.014	0.042	4,190	EKZN250E□□562MMN3S	
	2,200	10×25	0.026	0.072	2,900	EKZN100E□□222MJ25S	6,800		16×40	0.013	0.039	4,580	EKZN250E□□682ML40S	
	2,700	12.5×20	0.025	0.075	2,600	EKZN100E□□272MK20S	6,800	18×35.5	0.012	0.036	4,380	EKZN250E□□682MMP1S		
	3,900	12.5×25	0.019	0.057	3,200	EKZN100E□□392MK25S	8,200	18×40	0.011	0.033	4,960	EKZN250E□□822MM40S		
	4,700	12.5×30	0.018	0.054	3,660	EKZN100E□□472MK30S	35	47	5×11	0.38	1.2	450	EKZN350E□□470ME11D	
	4,700	16×20	0.021	0.063	3,330	EKZN100E□□472ML20S		100	6.3×11	0.17	0.51	700	EKZN350E□□101MF11D	
	5,600	12.5×35	0.016	0.048	4,120	EKZN100E□□562MK35S		180	8×11.5	0.075	0.23	1,200	EKZN350E□□181MHB5D	
	5,600	18×20	0.020	0.060	3,450	EKZN100E□□562MM20S		220	8×15	0.059	0.18	1,600	EKZN350E□□221MH15D	
	6,800	16×25	0.017	0.051	3,810	EKZN100E□□682ML25S		270	10×12.5	0.053	0.16	1,700	EKZN350E□□271MJC5S	
	8,200	16×31.5	0.016	0.048	4,100	EKZN100E□□822MLN3S		330	8×20	0.041	0.13	1,960	EKZN350E□□331MH20D	
	8,200	18×25	0.016	0.048	3,880	EKZN100E□□822MM25S		390	10×16	0.038	0.12	2,000	EKZN350E□□391MJ16S	
	10,000	16×35.5	0.014	0.042	4,280	EKZN100E□□103MLP1S		470	10×20	0.028	0.084	2,500	EKZN350E□□471MJ20S	
	10,000	18×31.5	0.014	0.042	4,190	EKZN100E□□103MMN3S		560	12.5×16	0.035	0.11	2,400	EKZN350E□□561MK16S	
	12,000	16×40	0.013	0.039	4,580	EKZN100E□□123ML40S		680	10×25	0.026	0.072	2,900	EKZN350E□□681MJ25S	
12,000	18×35.5	0.012	0.036	4,380	EKZN100E□□123MMP1S	820		12.5×20	0.025	0.075	2,600	EKZN350E□□821MK20S		
15,000	18×40	0.011	0.033	4,960	EKZN100E□□153MM40S	1,200		12.5×25	0.019	0.057	3,200	EKZN350E□□122MK25S		
16	120	5×11	0.38	1.2	450	EKZN160E□□121ME11D		1,500	12.5×30	0.018	0.054	3,660	EKZN350E□□152MK30S	
	270	6.3×11	0.17	0.51	700	EKZN160E□□271MF11D		1,500	16×20	0.021	0.063	3,330	EKZN350E□□152ML20S	
	470	8×11.5	0.075	0.23	1,200	EKZN160E□□471MHB5D		1,800	12.5×35	0.016	0.048	4,120	EKZN350E□□182MK35S	
	680	8×15	0.059	0.18	1,600	EKZN160E□□681MH15D		1,800	16×25	0.017	0.051	3,810	EKZN350E□□182ML25S	
	680	10×12.5	0.053	0.16	1,700	EKZN160E□□681MJC5S		1,800	18×20	0.020	0.060	3,450	EKZN350E□□182MM20S	
	820	8×20	0.041	0.13	1,960	EKZN160E□□821MH20D		2,700	16×31.5	0.016	0.048	4,100	EKZN350E□□272MLN3S	
	1,000	10×16	0.038	0.12	2,000	EKZN160E□□102MJ16S		2,700	18×25	0.016	0.048	3,880	EKZN350E□□272MM25S	
	1,500	10×20	0.028	0.084	2,500	EKZN160E□□152MJ20S		3,300	16×35.5	0.014	0.042	4,280	EKZN350E□□332MLP1S	
	1,500	12.5×16	0.035	0.11	2,400	EKZN160E□□152MK16S		3,300	18×31.5	0.014	0.042	4,190	EKZN350E□□332MMN3S	
	1,800	10×25	0.026	0.072	2,900	EKZN160E□□182MJ25S		3,900	16×40	0.013	0.039	4,580	EKZN350E□□392ML40S	
	2,200	12.5×20	0.025	0.075	2,600	EKZN160E□□222MK20S	3,900	18×35.5	0.012	0.036	4,380	EKZN350E□□392MMP1S		
	2,700	12.5×25	0.019	0.057	3,200	EKZN160E□□272MK25S	4,700	18×40	0.011	0.033	4,960	EKZN350E□□472MM40S		

□ □ : Enter the appropriate lead forming or taping code.
 Production of the products shown in [] is scheduled to be discontinued.



KZN Series

◆ STANDARD RATINGS

WV (V _{dc})	Cap (μF)	Case size φD×L(mm)	Impedance (Ω max./100kHz)		Rated ripple current (mA _{rms} /105°C, 100kHz)	Part No.	WV (V _{dc})	Cap (μF)	Case size φD×L(mm)	Impedance (Ω max./100kHz)		Rated ripple current (mA _{rms} /105°C, 100kHz)	Part No.
			20°C	-10°C						20°C	-10°C		
50	27	5×11	0.40	1.3	450	EKZN500E□□270ME11D	80	120	10×16	0.090	0.36	1,150	EKZN800E□□121MJ16S
	56	6.3×11	0.18	0.54	700	EKZN500E□□560MF11D		150	10×16	0.090	0.36	1,150	EKZN800E□□151MJ16S
	100	8×11.5	0.085	0.26	1,200	EKZN500E□□101MHB5D		180	10×20	0.068	0.28	1,570	EKZN800E□□181MJ20S
	120	8×15	0.065	0.20	1,600	EKZN500E□□121MH15D		180	12.5×16	0.090	0.27	1,430	EKZN800E□□181MK16S
	150	10×12.5	0.073	0.22	1,280	EKZN500E□□151MJC5S		220	10×20	0.068	0.28	1,570	EKZN800E□□221MJ20S
	180	8×20	0.049	0.16	1,960	EKZN500E□□181MH20D		220	10×25	0.055	0.22	1,780	EKZN800E□□221MJ25S
	220	10×16	0.053	0.16	1,650	EKZN500E□□221MJ16S		220	12.5×16	0.090	0.27	1,430	EKZN800E□□221MK16S
	330	10×20	0.038	0.12	2,060	EKZN500E□□331MJ20S		270	10×25	0.055	0.22	1,780	EKZN800E□□271MJ25S
	330	12.5×16	0.045	0.14	2,160	EKZN500E□□331MK16S		270	12.5×20	0.048	0.15	1,800	EKZN800E□□271MK20S
	390	10×25	0.032	0.10	2,420	EKZN500E□□391MJ25S		330	12.5×20	0.048	0.15	1,800	EKZN800E□□331MK20S
	470	12.5×20	0.032	0.10	2,300	EKZN500E□□471MK20S		390	12.5×25	0.038	0.12	2,210	EKZN800E□□391MK25S
	680	12.5×25	0.025	0.080	2,800	EKZN500E□□681MK25S		470	12.5×30	0.033	0.11	2,520	EKZN800E□□471MK30S
	820	12.5×30	0.023	0.074	3,370	EKZN500E□□821MK30S		470	16×20	0.036	0.12	2,150	EKZN800E□□471ML20S
	820	16×20	0.026	0.084	3,070	EKZN500E□□821ML20S		560	12.5×35	0.026	0.078	2,860	EKZN800E□□561MK35S
	1,000	12.5×35	0.021	0.067	3,810	EKZN500E□□102MK35S		680	12.5×40	0.026	0.078	3,150	EKZN800E□□681MK40S
	1,200	16×25	0.022	0.070	3,510	EKZN500E□□122ML25S		680	16×25	0.028	0.084	2,620	EKZN800E□□681ML25S
	1,200	18×20	0.025	0.075	3,120	EKZN500E□□122MM20S		680	18×20	0.032	0.096	2,280	EKZN800E□□681MM20S
	1,500	16×31.5	0.019	0.057	4,030	EKZN500E□□152MLN3S		820	16×31.5	0.022	0.066	2,900	EKZN800E□□821MLN3S
	1,500	18×25	0.021	0.063	3,530	EKZN500E□□152MM25S		820	18×25	0.027	0.081	2,750	EKZN800E□□821MM25S
	1,800	16×35.5	0.016	0.048	4,220	EKZN500E□□182MLP1S		1,000	18×25	0.027	0.081	2,750	EKZN800E□□102MM25S
2,200	16×40	0.014	0.042	4,500	EKZN500E□□222ML40S	1,000	16×35.5	0.020	0.060	3,150	EKZN800E□□102MLP1S		
2,200	18×31.5	0.016	0.048	4,080	EKZN500E□□222MMN3S	1,200	16×40	0.018	0.054	3,710	EKZN800E□□122ML40S		
2,700	18×35.5	0.013	0.039	4,270	EKZN500E□□272MMP1S	1,200	18×31.5	0.020	0.060	3,150	EKZN800E□□122MMN3S		
3,300	18×40	0.012	0.036	4,850	EKZN500E□□332MM40S	1,500	18×35.5	0.018	0.054	3,710	EKZN800E□□152MMP1S		
63	18	5×11	0.52	2.3	240	EKZN630E□□180ME11D	100	8.2	5×11	0.72	3.2	235	EKZN101E□□8R2ME11D
	39	6.3×11	0.24	1.1	420	EKZN630E□□390MF11D		18	6.3×11	0.34	1.5	390	EKZN101E□□180MF11D
	68	8×11.5	0.15	0.68	720	EKZN630E□□680MHB5D		33	8×11.5	0.20	0.90	650	EKZN101E□□330MHB5D
	100	8×15	0.10	0.45	990	EKZN630E□□101MH15D		47	8×15	0.14	0.63	820	EKZN101E□□470MH15D
	120	8×20	0.077	0.35	1,200	EKZN630E□□121MH20D		56	8×20	0.12	0.54	1,090	EKZN101E□□560MH20D
	120	10×12.5	0.090	0.36	990	EKZN630E□□121MJC5S		56	10×12.5	0.14	0.56	860	EKZN101E□□560MJC5S
	180	10×16	0.061	0.25	1,200	EKZN630E□□181MJ16S		82	10×16	0.090	0.36	1,150	EKZN101E□□820MJ16S
	270	10×20	0.045	0.18	1,570	EKZN630E□□271MJ20S		100	10×20	0.068	0.28	1,570	EKZN101E□□101MJ20S
	270	12.5×16	0.058	0.18	1,570	EKZN630E□□271MK16S		120	10×20	0.068	0.28	1,570	EKZN101E□□121MJ20S
	330	10×25	0.037	0.12	1,990	EKZN630E□□331MJ25S		120	12.5×16	0.090	0.27	1,430	EKZN101E□□121MK16S
	390	12.5×20	0.033	0.10	1,990	EKZN630E□□391MK20S		150	10×25	0.055	0.22	1,780	EKZN101E□□151MJ25S
	560	12.5×25	0.026	0.080	2,460	EKZN630E□□561MK25S		180	12.5×20	0.048	0.15	1,800	EKZN101E□□181MK20S
	680	12.5×30	0.024	0.075	2,760	EKZN630E□□681MK30S		220	12.5×25	0.038	0.12	2,210	EKZN101E□□221MK25S
	680	16×20	0.027	0.085	2,380	EKZN630E□□681ML20S		270	12.5×30	0.033	0.11	2,520	EKZN101E□□271MK30S
	820	12.5×35	0.022	0.068	3,040	EKZN630E□□821MK35S		270	16×20	0.036	0.12	2,150	EKZN101E□□271ML20S
	820	18×20	0.026	0.078	2,530	EKZN630E□□821MM20S		330	16×20	0.036	0.12	2,150	EKZN101E□□331ML20S
	1,000	16×25	0.024	0.072	2,890	EKZN630E□□102ML25S		390	12.5×35	0.026	0.078	2,860	EKZN101E□□391MK35S
	1,200	16×31.5	0.020	0.060	3,280	EKZN630E□□122MLN3S		390	16×25	0.028	0.084	2,620	EKZN101E□□391ML25S
	1,200	18×25	0.022	0.066	2,930	EKZN630E□□122MM25S		390	18×20	0.032	0.096	2,280	EKZN101E□□391MM20S
	1,500	16×35.5	0.018	0.054	3,440	EKZN630E□□152MLP1S		470	12.5×40	0.026	0.078	3,150	EKZN101E□□471MK40S
1,500	18×31.5	0.018	0.054	3,380	EKZN630E□□152MMN3S	470	16×31.5	0.022	0.066	2,900	EKZN101E□□471MLN3S		
1,800	16×40	0.016	0.048	3,690	EKZN630E□□182ML40S	560	16×31.5	0.022	0.066	2,900	EKZN101E□□561MLN3S		
1,800	18×35.5	0.017	0.051	3,550	EKZN630E□□182MMP1S	560	16×35.5	0.020	0.060	3,150	EKZN101E□□561MLP1S		
2,200	18×40	0.015	0.045	3,930	EKZN630E□□222MM40S	560	18×25	0.027	0.081	2,750	EKZN101E□□561MM25S		
80	12	5×11	0.72	3.2	235	EKZN800E□□120ME11D	680	16×35.5	0.020	0.060	3,150	EKZN101E□□681MLP1S	
	27	6.3×11	0.34	1.5	390	EKZN800E□□270MF11D	680	16×40	0.018	0.054	3,710	EKZN101E□□681ML40S	
	47	8×11.5	0.20	0.90	650	EKZN800E□□470MHB5D	680	18×31.5	0.020	0.060	3,150	EKZN101E□□681MMN3S	
	68	8×15	0.14	0.63	820	EKZN800E□□680MH15D	820	16×40	0.018	0.054	3,710	EKZN101E□□821ML40S	
	82	8×20	0.12	0.54	1,090	EKZN800E□□820MH20D	820	18×35.5	0.018	0.054	3,710	EKZN101E□□821MMP1S	
	82	10×12.5	0.14	0.56	860	EKZN800E□□820MJC5S	1,000	18×40	0.017	0.051	4,060	EKZN101E□□102MM40S	
	100	10×12.5	0.14	0.56	860	EKZN800E□□101MJC5S							

□ □ : Enter the appropriate lead forming or taping code.
 Production of the products shown in is scheduled to be discontinued.



KZN Series

◆ RATED RIPPLE CURRENT MULTIPLIERS

● Frequency Multipliers

Capacitance(μF) \ Frequency(Hz)	120	1k	10k	100k
8.2 to 180	0.40	0.75	0.90	1.00
220 to 560	0.50	0.85	0.94	1.00
680 to 1,800	0.60	0.87	0.95	1.00
2,200 to 3,900	0.75	0.90	0.95	1.00
4,700 to 22,000	0.85	0.95	0.98	1.00

The deterioration of aluminum electrolytic capacitors accelerates their life due to the internal heating produced by ripple current. For details, refer to Section "5-3 Ripple Current Effect on Lifetime" in the catalog, Technical Note.

KZM Series

- Long-Life version of KZH series
- Endurance with ripple current : 6,000 to 10,000 hours at 105°C
- Newly innovative electrolyte is employed to minimize ESR
- Rated voltage range : 6.3 to 50V_{dc}, Nominal capacitance range : 27 to 10,000μF
- Non solvent resistant type
- RoHS2 Compliant



SPECIFICATIONS

Items	Characteristics	
Category	-40 to +105°C	
Temperature Range	-40 to +105°C	
Rated Voltage Range	6.3 to 50V _{dc}	
Capacitance Tolerance	±20% (M) (at 20°C, 120Hz)	
Leakage Current	I=0.01CV or 3μA, whichever is greater. Where, I : Max. leakage current (μA), C : Nominal capacitance (μF), V : Rated voltage (V) (at 20°C after 2 minutes)	
Dissipation Factor (tan δ)	Rated voltage (V _{dc})	6.3V 10V 16V 25V 35V 50V
	tan δ (Max.)	0.22 0.19 0.16 0.14 0.12 0.10
	When nominal capacitance exceeds 1,000μF, add 0.02 to the value above for each 1,000μF increase. (at 20°C, 120Hz)	
Low Temperature Characteristics (Max. Impedance Ratio)	Z (-25°C) / Z (+20°C)	2max.
	Z (-40°C) / Z (+20°C)	3max.
Endurance	The following specifications shall be satisfied when the capacitors are restored to 20°C after subjected to DC voltage with the rated ripple current is applied (the peak voltage shall not exceed the rated voltage) for the specified period of time at 105°C.	
	Time	φ 5 & φ 6.3 : 6,000hours φ 8 : 8,000hours φ 10 to φ 18 : 10,000hours
	Capacitance change	≤ ±25% of the initial value (6.3, 10V _{dc} : ≤ ± 30%)
	D.F. (tan δ)	≤200% of the initial specified value
	Leakage current	≤ The initial specified value
Shelf Life	The following specifications shall be satisfied when the capacitors are restored to 20°C after exposing them for 500 hours at 105°C without voltage applied. Before the measurement, the capacitor shall be preconditioned by applying voltage according to Item 4.1 of JIS C 5101-4.	
	Capacitance change	≤ ±25% of the initial value (6.3, 10V _{dc} : ≤ ±30%)
	D.F. (tan δ)	≤200% of the initial specified value
	Leakage current	≤ The initial specified value

DIMENSIONS [mm]

- Terminal Code : E

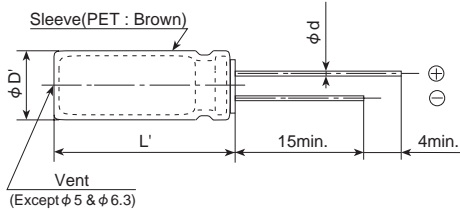

φD	5	6.3	8	10	12.5	16	18
φd	0.5	0.5	0.6	0.6	0.6	0.8	0.8
F	2.0	2.5	3.5	5.0	5.0	7.5	7.5
φD'	φD+0.5max.						
L'	L+1.5max.						

PART NUMBERING SYSTEM

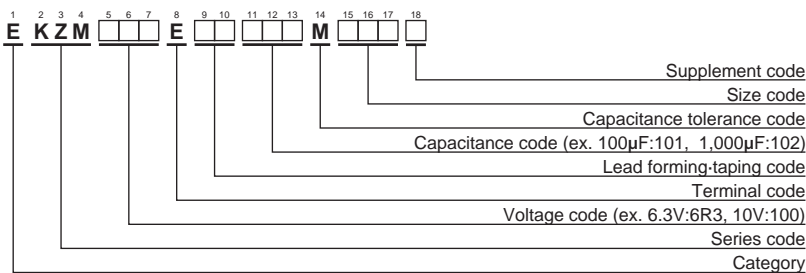

Please refer to "Product code guide (radial lead type)"

RATED RIPPLE CURRENT MULTIPLIERS

- Frequency Multipliers

Capacitance(μF)	Frequency(Hz)			
	120	1k	10k	100k
27 to 180	0.40	0.75	0.90	1.00
220 to 560	0.50	0.85	0.94	1.00
680 to 1,800	0.60	0.87	0.95	1.00
2,200 to 3,900	0.75	0.90	0.95	1.00
4,700 to 10,000	0.85	0.95	0.98	1.00

The deterioration of aluminum electrolytic capacitors accelerates their life due to the internal heating produced by ripple current. For details, refer to Section "5-3 Ripple Current Effect on Lifetime" in the catalog, Technical Note.



KZMSeries

◆ **STANDARD RATINGS**

WV (V _{dc})	Cap (μF)	Case size φD×L(mm)	tan δ	Impedance (Ω max./100kHz)		Rated ripple current (mArms/105°C, 100kHz)	Part No.
				20°C	-10°C		
6.3	220	5 × 11	0.22	0.22	0.80	345	EKZM6R3E□□221ME11D
	470	6.3 × 11	0.22	0.094	0.35	540	EKZM6R3E□□471MF11D
	820	8 × 11.5	0.22	0.056	0.19	945	EKZM6R3E□□821MHB5D
	1,200	8 × 15	0.22	0.045	0.15	1,250	EKZM6R3E□□122MH15D
	1,200	10 × 12.5	0.22	0.039	0.14	1,330	EKZM6R3E□□122MJC5S
	1,500	8 × 20	0.22	0.029	0.11	1,500	EKZM6R3E□□152MH20D
	1,800	10 × 16	0.22	0.028	0.10	1,760	EKZM6R3E□□182MJ16S
	2,200	10 × 20	0.24	0.020	0.060	1,960	EKZM6R3E□□222MJ20S
	2,700	10 × 25	0.24	0.018	0.054	2,250	EKZM6R3E□□272MJ25S
	3,900	12.5 × 20	0.26	0.017	0.043	2,480	EKZM6R3E□□392MK20S
	4,700	12.5 × 25	0.28	0.015	0.038	2,900	EKZM6R3E□□472MK25S
	5,600	12.5 × 30	0.30	0.013	0.033	3,450	EKZM6R3E□□562MK30S
	6,800	12.5 × 35	0.32	0.012	0.031	3,570	EKZM6R3E□□682MK35S
	6,800	16 × 20	0.32	0.015	0.038	3,250	EKZM6R3E□□682ML20S
8,200	16 × 25	0.36	0.013	0.035	3,630	EKZM6R3E□□822ML25S	
10,000	18 × 25	0.40	0.012	0.031	3,650	EKZM6R3E□□103MM25S	
10	150	5 × 11	0.19	0.22	0.80	345	EKZM100E□□151ME11D
	330	6.3 × 11	0.19	0.094	0.35	540	EKZM100E□□331MF11D
	680	8 × 11.5	0.19	0.056	0.19	945	EKZM100E□□681MHB5D
	1,000	8 × 15	0.19	0.045	0.15	1,250	EKZM100E□□102MH15D
	1,000	10 × 12.5	0.19	0.039	0.14	1,330	EKZM100E□□102MJC5S
	1,500	8 × 20	0.19	0.029	0.11	1,500	EKZM100E□□152MH20D
	1,500	10 × 16	0.19	0.028	0.10	1,760	EKZM100E□□152MJ16S
	1,800	10 × 20	0.19	0.020	0.060	1,960	EKZM100E□□182MJ20S
	2,200	10 × 25	0.21	0.018	0.054	2,250	EKZM100E□□222MJ25S
	3,300	12.5 × 20	0.23	0.017	0.043	2,480	EKZM100E□□332MK20S
	3,900	12.5 × 25	0.23	0.015	0.038	2,900	EKZM100E□□392MK25S
	4,700	12.5 × 30	0.25	0.013	0.033	3,450	EKZM100E□□472MK30S
	4,700	16 × 20	0.25	0.015	0.038	3,250	EKZM100E□□472ML20S
	5,600	12.5 × 35	0.27	0.012	0.031	3,570	EKZM100E□□562MK35S
6,800	16 × 25	0.29	0.013	0.035	3,630	EKZM100E□□682ML25S	
8,200	18 × 25	0.33	0.012	0.031	3,650	EKZM100E□□822MM25S	
16	100	5 × 11	0.16	0.22	0.80	345	EKZM160E□□101ME11D
	220	6.3 × 11	0.16	0.094	0.35	540	EKZM160E□□221MF11D
	470	8 × 11.5	0.16	0.056	0.19	945	EKZM160E□□471MHB5D
	680	8 × 15	0.16	0.045	0.15	1,250	EKZM160E□□681MH15D
	680	10 × 12.5	0.16	0.039	0.14	1,330	EKZM160E□□681MJC5S
	1,000	8 × 20	0.16	0.029	0.11	1,500	EKZM160E□□102MH20D
	1,000	10 × 16	0.16	0.028	0.10	1,760	EKZM160E□□102MJ16S
	1,500	10 × 20	0.16	0.020	0.060	1,960	EKZM160E□□152MJ20S
	1,800	10 × 25	0.16	0.018	0.054	2,250	EKZM160E□□182MJ25S
	2,200	12.5 × 20	0.18	0.017	0.043	2,480	EKZM160E□□222MK20S
	2,700	12.5 × 25	0.18	0.015	0.038	2,900	EKZM160E□□272MK25S
	3,300	12.5 × 30	0.20	0.013	0.033	3,450	EKZM160E□□332MK30S
	3,300	16 × 20	0.20	0.015	0.038	3,250	EKZM160E□□332ML20S
	3,900	12.5 × 35	0.20	0.012	0.031	3,570	EKZM160E□□392MK35S
	4,700	16 × 25	0.22	0.013	0.035	3,630	EKZM160E□□472ML25S
	5,600	18 × 25	0.24	0.012	0.031	3,650	EKZM160E□□562MM25S

□□ : Enter the appropriate lead forming or taping code.

Production of the products shown in is scheduled to be discontinued.



KZMSeries

◆STANDARD RATINGS

WV (V _{dc})	Cap (μF)	Case size φD×L(mm)	tan δ	Impedance (Ω max./100kHz)		Rated ripple current (mArms/105°C, 100kHz)	Part No.
				20°C	-10°C		
25	68	5 × 11	0.14	0.22	0.80	345	EKZM250E□□680ME11D
	150	6.3 × 11	0.14	0.094	0.35	540	EKZM250E□□151MF11D
	330	8 × 11.5	0.14	0.056	0.19	945	EKZM250E□□331MHB5D
	390	8 × 15	0.14	0.045	0.15	1,250	EKZM250E□□391MH15D
	470	10 × 12.5	0.14	0.039	0.14	1,330	EKZM250E□□471MJC5S
	560	8 × 20	0.14	0.029	0.11	1,500	EKZM250E□□561MH20D
	680	10 × 16	0.14	0.028	0.10	1,760	EKZM250E□□681MJ16S
	820	10 × 20	0.14	0.020	0.060	1,960	EKZM250E□□821MJ20S
	1,000	10 × 25	0.14	0.018	0.054	2,250	EKZM250E□□102MJ25S
	1,500	12.5 × 20	0.14	0.017	0.043	2,480	EKZM250E□□152MK20S
	1,800	12.5 × 25	0.14	0.015	0.038	2,900	EKZM250E□□182MK25S
	2,200	12.5 × 30	0.16	0.013	0.033	3,450	EKZM250E□□222MK30S
	2,200	16 × 20	0.16	0.015	0.038	3,250	EKZM250E□□222ML20S
	2,700	12.5 × 35	0.16	0.012	0.031	3,570	EKZM250E□□272MK35S
3,300	16 × 25	0.18	0.013	0.035	3,630	EKZM250E□□332ML25S	
3,900	18 × 25	0.18	0.012	0.031	3,650	EKZM250E□□392MM25S	
35	47	5 × 11	0.12	0.22	0.80	345	EKZM350E□□470ME11D
	100	6.3 × 11	0.12	0.094	0.35	540	EKZM350E□□101MF11D
	220	8 × 11.5	0.12	0.056	0.19	945	EKZM350E□□221MHB5D
	270	8 × 15	0.12	0.045	0.15	1,250	EKZM350E□□271MH15D
	330	10 × 12.5	0.12	0.039	0.14	1,330	EKZM350E□□331MJC5S
	390	8 × 20	0.12	0.029	0.11	1,500	EKZM350E□□391MH20D
	470	10 × 16	0.12	0.028	0.10	1,760	EKZM350E□□471MJ16S
	560	10 × 20	0.12	0.020	0.060	1,960	EKZM350E□□561MJ20S
	680	10 × 25	0.12	0.018	0.054	2,250	EKZM350E□□681MJ25S
	1,000	12.5 × 20	0.12	0.017	0.043	2,480	EKZM350E□□102MK20S
	1,200	12.5 × 25	0.12	0.015	0.038	2,900	EKZM350E□□122MK25S
	1,500	12.5 × 30	0.12	0.013	0.033	3,450	EKZM350E□□152MK30S
	1,500	16 × 20	0.12	0.015	0.038	3,250	EKZM350E□□152ML20S
	1,800	12.5 × 35	0.12	0.012	0.031	3,570	EKZM350E□□182MK35S
2,200	16 × 25	0.14	0.013	0.035	3,630	EKZM350E□□222ML25S	
2,700	18 × 25	0.14	0.012	0.031	3,650	EKZM350E□□272MM25S	
50	27	5 × 11	0.10	0.34	1.18	238	EKZM500E□□270ME11D
	56	6.3 × 11	0.10	0.14	0.50	385	EKZM500E□□560MF11D
	100	8 × 11.5	0.10	0.074	0.22	724	EKZM500E□□101MHB5D
	120	8 × 15	0.10	0.061	0.18	950	EKZM500E□□121MH15D
	150	10 × 12.5	0.10	0.061	0.18	979	EKZM500E□□151MJC5S
	180	8 × 20	0.10	0.046	0.14	1,190	EKZM500E□□181MH20D
	220	10 × 16	0.10	0.042	0.12	1,370	EKZM500E□□221MJ16S
	270	10 × 20	0.10	0.030	0.090	1,580	EKZM500E□□271MJ20S
	330	10 × 25	0.10	0.028	0.085	1,870	EKZM500E□□331MJ25S
	470	12.5 × 20	0.10	0.027	0.068	2,050	EKZM500E□□471MK30S
	560	12.5 × 25	0.10	0.023	0.059	2,410	EKZM500E□□561MK25S
	680	12.5 × 30	0.10	0.021	0.052	2,860	EKZM500E□□681MK30S
	820	12.5 × 35	0.10	0.019	0.051	2,960	EKZM500E□□821MK35S
	820	16 × 20	0.10	0.023	0.059	2,730	EKZM500E□□821ML20S
1,000	16 × 25	0.10	0.021	0.056	3,010	EKZM500E□□102ML25S	
1,500	18 × 25	0.10	0.019	0.051	3,290	EKZM500E□□152MM25S	

□□ : Enter the appropriate lead forming or taping code.

Production of the products shown in is scheduled to be discontinued.

KZH Series

- Newly innovative electrolyte is employed to minimize impedance
- Endurance with ripple current: 5,000 to 6,000 hours at 105°C
- Non solvent resistant type
- RoHS2 Compliant

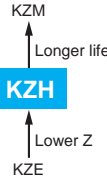

SPECIFICATIONS

Items	Characteristics					
Category	-40 to +105°C					
Temperature Range	-40 to +105°C					
Rated Voltage Range	6.3 to 35V _{dc}					
Capacitance Tolerance	±20% (M) (at 20°C, 120Hz)					
Leakage Current	I=0.01CV or 3μA, whichever is greater. Where, I : Max. leakage current (μA), C : Nominal capacitance (μF), V : Rated voltage (V) (at 20°C after 2 minutes)					
Dissipation Factor (tan δ)	Rated voltage (V _{dc})	6.3V	10V	16V	25V	35V
	tan δ (Max.)	0.22	0.19	0.16	0.14	0.12
	When nominal capacitance exceeds 1,000μF, add 0.02 to the value above for each 1,000μF increase. (at 20°C, 120Hz)					
Low Temperature Characteristics (Max. Impedance Ratio)	Z (-25°C) / Z (+20°C)	2max.				
	Z (-40°C) / Z (+20°C)	3max.				
Endurance	The following specifications shall be satisfied when the capacitors are restored to 20°C after subjected to DC voltage with the rated ripple current is applied (the peak voltage shall not exceed the rated voltage) for the specified period of time at 105°C.					
	Time	φ 5 & φ 6.3 : 5,000hours φ 8 to φ 16 : 6,000hours				
	Capacitance change	≤ ±25% of the initial value (6.3, 10V _{dc} : ≤ ±30%)				
	D.F. (tan δ)	≤200% of the initial specified value				
	Leakage current	≤The initial specified value				
Shelf Life	The following specifications shall be satisfied when the capacitors are restored to 20°C after exposing them for 500 hours at 105°C without voltage applied. Before the measurement, the capacitor shall be preconditioned by applying voltage according to Item 4.1 of JIS C 5101-4.					
	Capacitance change	≤ ±25% of the initial value (6.3, 10V _{dc} : ≤ ±30%)				
	D.F. (tan δ)	≤200% of the initial specified value				
	Leakage current	≤The initial specified value				

DIMENSIONS [mm]

● Terminal Code : E

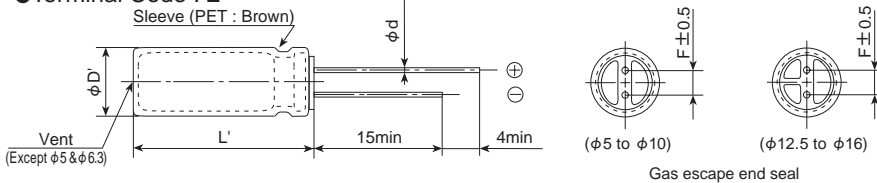

φD	5	6.3	8	10	12.5	16
φd	0.5	0.5	0.6	0.6	0.6	0.8
F	2.0	2.5	3.5	5.0	5.0	7.5
φD'	φD+0.5max.					
L'	L+1.5max.					

PART NUMBERING SYSTEM

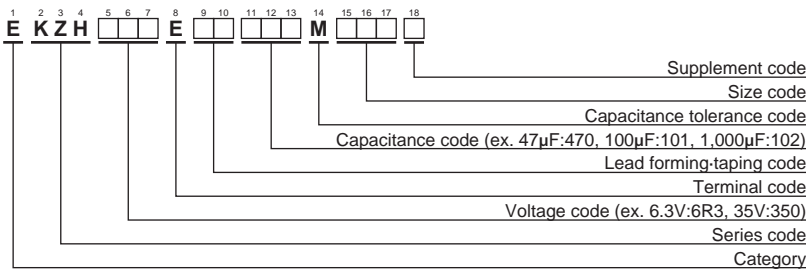

Please refer to "Product code guide (radial lead type)"



KZH Series

◆ STANDARD RATINGS

WV (V _{dc})	Cap (μF)	Case size φD×L(mm)	Impedance (Ω max./100kHz)		Rated ripple current (mA _{rms} /105°C, 100kHz)	Part No.	WV (V _{dc})	Cap (μF)	Case size φD×L(mm)	Impedance (Ω max./100kHz)		Rated ripple current (mA _{rms} /105°C, 100kHz)	Part No.	
			20°C	-10°C						20°C	-10°C			
6.3	220	5×11	0.24	0.80	330	EKZH6R3E□□221ME11D	16	1,800	10×25	0.018	0.054	2,250	EKZH160E□□182MJ25S	
	470	6.3×11	0.11	0.35	500	EKZH6R3E□□471MF11D		2,200	12.5×20	0.017	0.043	2,480	EKZH160E□□222MK20S	
	820	8×11.5	0.062	0.19	900	EKZH6R3E□□821MHB5D		2,700	12.5×25	0.015	0.038	2,900	EKZH160E□□272MK25S	
	1,200	8×15	0.048	0.15	1,210	EKZH6R3E□□122MH15D		3,300	12.5×30	0.013	0.033	3,450	EKZH160E□□332MK30S	
	1,200	10×12.5	0.045	0.14	1,240	EKZH6R3E□□122MJC5S		3,300	16×20	0.015	0.038	3,250	EKZH160E□□332ML20S	
	1,500	8×20	0.033	0.11	1,410	EKZH6R3E□□152MH20D		3,900	12.5×35	0.012	0.031	3,570	EKZH160E□□392MK35S	
	1,800	10×16	0.032	0.10	1,650	EKZH6R3E□□182MJ16S		4,700	16×25	0.013	0.035	3,630	EKZH160E□□472ML25S	
	2,200	10×20	0.020	0.060	1,960	EKZH6R3E□□222MJ20S		25	68	5×11	0.24	0.80	330	EKZH250E□□680ME11D
	2,700	10×25	0.018	0.054	2,250	EKZH6R3E□□272MJ25S			150	6.3×11	0.11	0.35	500	EKZH250E□□151MF11D
	3,900	12.5×20	0.017	0.043	2,480	EKZH6R3E□□392MK20S			330	8×11.5	0.062	0.19	900	EKZH250E□□331MHB5D
	4,700	12.5×25	0.015	0.038	2,900	EKZH6R3E□□472MK25S			390	8×15	0.048	0.15	1,210	EKZH250E□□391MH15D
	5,600	12.5×30	0.013	0.033	3,450	EKZH6R3E□□562MK30S			470	10×12.5	0.045	0.14	1,240	EKZH250E□□471MJ25S
	6,800	12.5×35	0.012	0.031	3,570	EKZH6R3E□□682MK35S			560	8×20	0.033	0.11	1,410	EKZH250E□□561MH20D
	6,800	16×20	0.015	0.038	3,250	EKZH6R3E□□682ML20S			680	10×16	0.032	0.10	1,650	EKZH250E□□681MJ16S
	8,200	16×25	0.013	0.035	3,630	EKZH6R3E□□822ML25S			820	10×20	0.020	0.060	1,960	EKZH250E□□821MJ20S
	10	150	5×11	0.24	0.80	330			EKZH100E□□151ME11D	1,000	10×25	0.018	0.054	2,250
330		6.3×11	0.11	0.35	500	EKZH100E□□331MF11D	1,500		12.5×20	0.017	0.043	2,480	EKZH250E□□152MK20S	
680		8×11.5	0.062	0.19	900	EKZH100E□□681MHB5D	1,800		12.5×25	0.015	0.038	2,900	EKZH250E□□182MK25S	
1,000		8×15	0.048	0.15	1,210	EKZH100E□□102MH15D	2,200		12.5×30	0.013	0.033	3,450	EKZH250E□□222MK30S	
1,000		10×12.5	0.045	0.14	1,240	EKZH100E□□102MJC5S	2,200		16×20	0.015	0.038	3,250	EKZH250E□□222ML20S	
1,500		8×20	0.033	0.11	1,410	EKZH100E□□152MH20D	2,700		12.5×35	0.012	0.031	3,570	EKZH250E□□272MK35S	
1,500		10×16	0.032	0.10	1,650	EKZH100E□□152MJ16S	3,300		16×25	0.013	0.035	3,630	EKZH250E□□332ML25S	
1,800		10×20	0.020	0.060	1,960	EKZH100E□□182MJ20S	35		47	5×11	0.24	0.80	330	EKZH350E□□470ME11D
2,200		10×25	0.018	0.054	2,250	EKZH100E□□222MJ25S		100	6.3×11	0.11	0.35	500	EKZH350E□□101MF11D	
3,300		12.5×20	0.017	0.043	2,480	EKZH100E□□332MK20S		220	8×11.5	0.062	0.19	900	EKZH350E□□221MHB5D	
3,900		12.5×25	0.015	0.038	2,900	EKZH100E□□392MK25S		270	8×15	0.048	0.15	1,210	EKZH350E□□271MH15D	
4,700		12.5×30	0.013	0.033	3,450	EKZH100E□□472MK30S		330	10×12.5	0.045	0.14	1,240	EKZH350E□□331MJC5S	
4,700		16×20	0.015	0.038	3,250	EKZH100E□□472ML20S		390	8×20	0.033	0.11	1,410	EKZH350E□□391MH20D	
5,600		12.5×35	0.012	0.031	3,570	EKZH100E□□562MK35S		470	10×16	0.032	0.10	1,650	EKZH350E□□471MJ16S	
6,800		16×25	0.013	0.035	3,630	EKZH100E□□682ML25S		560	10×20	0.020	0.060	1,960	EKZH350E□□561MJ20S	
16		100	5×11	0.24	0.80	330		EKZH160E□□101ME11D	680	10×25	0.018	0.054	2,250	EKZH350E□□681MJ25S
	220	6.3×11	0.11	0.35	500	EKZH160E□□221MF11D		1,000	12.5×20	0.017	0.043	2,480	EKZH350E□□102MK20S	
	470	8×11.5	0.062	0.19	900	EKZH160E□□471MHB5D		1,200	12.5×25	0.015	0.038	2,900	EKZH350E□□122MK25S	
	680	8×15	0.048	0.15	1,210	EKZH160E□□681MH15D		1,500	12.5×30	0.013	0.033	3,450	EKZH350E□□152MK30S	
	680	10×12.5	0.045	0.14	1,240	EKZH160E□□681MJC5S		1,500	16×20	0.015	0.038	3,250	EKZH350E□□152ML20S	
	1,000	8×20	0.033	0.11	1,410	EKZH160E□□102MH20D		1,800	12.5×35	0.012	0.031	3,570	EKZH350E□□182MK35S	
	1,000	10×16	0.032	0.10	1,650	EKZH160E□□102MJ16S		2,200	16×25	0.013	0.035	3,630	EKZH350E□□222ML25S	
	1,500	10×20	0.020	0.060	1,960	EKZH160E□□152MJ20S								

□□ : Enter the appropriate lead forming or taping code.
 Production of the products shown in [] is scheduled to be discontinued.

◆ RATED RIPPLE CURRENT MULTIPLIERS

● Frequency Multipliers

Capacitance(μF)	Frequency(Hz)			
	120	1k	10k	100k
0.47 to 150	0.40	0.75	0.90	1.00
220 to 560	0.50	0.85	0.94	1.00
680 to 1,800	0.60	0.87	0.95	1.00
2,200 to 3,900	0.75	0.90	0.95	1.00
4,700 to 8,200	0.85	0.95	0.98	1.00

The deterioration of aluminum electrolytic capacitors accelerates their life due to the internal heating produced by ripple current. For details, refer to Section "5-3 Ripple Current Effect on Lifetime" in the catalog, Technical Note.

KZE Series

- Newly innovative electrolyte is employed to minimize impedance
- Endurance with ripple current: 2,000 to 5,000 hours at 105°C
- Non solvent resistant type
- RoHS2 Compliant



SPECIFICATIONS

Items	Characteristics									
Category	-40 to +105°C									
Temperature Range	-40 to +105°C									
Rated Voltage Range	6.3 to 100V _{dc}									
Capacitance Tolerance	±20% (M) (at 20°C, 120Hz)									
Leakage Current	I=0.01CV or 3μA, whichever is greater. Where, I : Max. leakage current (μA), C : Nominal capacitance (μF), V : Rated voltage (V) (at 20°C after 2 minutes)									
Dissipation Factor (tan δ)	Rated voltage (V _{dc})	6.3V	10V	16V	25V	35V	50V	63V	80V	100V
	tan δ (Max.)	0.22	0.19	0.16	0.14	0.12	0.10	0.09	0.09	0.08
	When nominal capacitance exceeds 1,000μF, add 0.02 to the value above for each 1,000μF increase. (at 20°C, 120Hz)									
Low Temperature Characteristics (Max. Impedance Ratio)	Z (-25°C) / Z (+20°C)	2max.								
	Z (-40°C) / Z (+20°C)	3max.								
Endurance	The following specifications shall be satisfied when the capacitors are restored to 20°C after subjected to DC voltage with the rated ripple current is applied (the peak voltage shall not exceed the rated voltage) for the specified period of time at 105°C.									
	Time	φ 5 & φ 6.3 : 2,000hours	φ 8 : 3,000hours	φ 10 : 4,000hours	φ 12.5 to φ 18 : 5,000hours					
	Capacitance change	≤ ±25% of the initial value								
	D.F. (tan δ)	≤ 200% of the initial specified value								
	Leakage current	≤ The initial specified value								
Shelf Life	The following specifications shall be satisfied when the capacitors are restored to 20°C after exposing them for 500 hours at 105°C without voltage applied. Before the measurement, the capacitor shall be preconditioned by applying voltage according to Item 4.1 of JIS C 5101-4.									
	Capacitance change	≤ ±25% of the initial value								
	D.F. (tan δ)	≤ 200% of the initial specified value								
	Leakage current	≤ The initial specified value								

DIMENSIONS [mm]

- Terminal Code : E

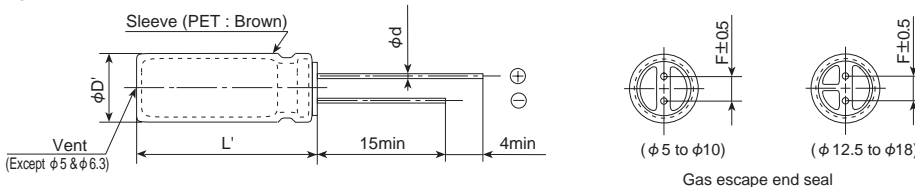

φD	5	6.3	8	10, 12.5	16, 18
φd	0.5	0.5	0.6	0.6	0.8
F	2.0	2.5	3.5	5.0	7.5
φD'	φ D+0.5max.				
L'	L+1.5max.				

PART NUMBERING SYSTEM

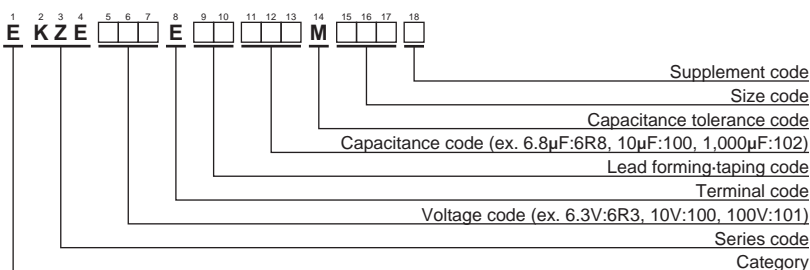

Please refer to "Product code guide (radial lead type)"



STANDARD RATINGS

Table with columns: WV (Vdc), Cap (µF), Case size φD×L(mm), Impedance (Ω max./100kHz) at 20°C and -10°C, Rated ripple current (mArms/105°C, 100kHz), Part No. The table is organized into four main sections based on voltage ratings: 6.3V, 10V, 16V, and 25V, each with sub-sections for different capacitance values and case sizes.

□ □ : Enter the appropriate lead forming or taping code. Production of the products shown in [] is scheduled to be discontinued.

Product specifications in this catalog are subject to change without notice. Request our product specifications before purchase and/or use. Please use our products based on the information contained in this catalog and product specifications.



KZE Series

◆ STANDARD RATINGS

WV (V _{dc})	Cap (μF)	Case size φD×L(mm)	Impedance (Ω max./100kHz)		Rated ripple current (mA _{rms} / 105°C, 100kHz)	Part No.	WV (V _{dc})	Cap (μF)	Case size φD×L(mm)	Impedance (Ω max./100kHz)		Rated ripple current (mA _{rms} / 105°C, 100kHz)	Part No.
			20°C	-10°C						20°C	-10°C		
80	820	16×35.5	0.029	0.086	2,000	EKZE800E□□821MLP1S	100	150	12.5×20	0.062	0.18	1,100	EKZE101E□□151MK20S
	820	18×31.5	0.030	0.090	1,900	EKZE800E□□821MMN3S		220	12.5×25	0.047	0.14	1,250	EKZE101E□□221MK25S
	1,000	16×40	0.027	0.081	2,200	EKZE800E□□102ML40S		220	16×20	0.048	0.15	1,350	EKZE101E□□221ML20S
	1,000	18×35.5	0.027	0.081	2,200	EKZE800E□□102MMP1S		270	12.5×30	0.042	0.13	1,500	EKZE101E□□271MK30S
	1,200	18×40	0.026	0.077	2,700	EKZE800E□□122MM40S		330	12.5×35	0.036	0.11	1,650	EKZE101E□□331MK35S
100	6.8	5×11	1.4	5.6	125	EKZE101E□□6R8ME11D		330	16×25	0.038	0.12	1,700	EKZE101E□□331ML25S
	15	6.3×11	0.57	2.3	205	EKZE101E□□150MF11D		330	18×20	0.045	0.14	1,500	EKZE101E□□331MM20S
	27	8×11.5	0.36	1.4	355	EKZE101E□□270MHB5D		390	12.5×40	0.032	0.095	1,800	EKZE101E□□391MK40S
	39	8×15	0.25	1.0	450	EKZE101E□□390MH15D		470	16×31.5	0.032	0.095	1,850	EKZE101E□□471MLN3S
	47	10×12.5	0.17	0.66	480	EKZE101E□□470MJC5S		470	18×25	0.036	0.11	1,750	EKZE101E□□471MM25S
	56	8×20	0.19	0.76	565	EKZE101E□□560MH20D		560	16×35.5	0.029	0.086	2,000	EKZE101E□□561MLP1S
	68	10×16	0.11	0.47	600	EKZE101E□□680MJ16S		560	18×31.5	0.030	0.090	1,900	EKZE101E□□561MMN3S
	82	10×20	0.084	0.34	800	EKZE101E□□820MJ20S		680	16×40	0.027	0.081	2,200	EKZE101E□□681ML40S
	100	12.5×16	0.11	0.34	750	EKZE101E□□101MK16S		680	18×35.5	0.027	0.081	2,200	EKZE101E□□681MMP1S
	120	10×25	0.069	0.28	900	EKZE101E□□121MJ25S		820	18×40	0.026	0.077	2,700	EKZE101E□□821MM40S

□□ : Enter the appropriate lead forming or taping code.
 Production of the products shown in is scheduled to be discontinued.

◆ RATED RIPPLE CURRENT MULTIPLIERS

⊙ Frequency Multipliers

Capacitance(μF)	Frequency(Hz)			
	120	1k	10k	100k
6.8 to 180	0.40	0.75	0.90	1.00
220 to 560	0.50	0.85	0.94	1.00
680 to 1,800	0.60	0.87	0.95	1.00
2,200 to 3,900	0.75	0.90	0.95	1.00
4,700 to	0.85	0.95	0.98	1.00

The deterioration of aluminum electrolytic capacitors accelerates their life due to the internal heating produced by ripple current. For details, refer to Section "5-3 Ripple Current Effect on Lifetime" in the catalog, Technical Note.

KYC Series Upgrade!

- New highly reliable electrolyte is employed to minimize ESR and maximize ripple current.
- For motorcycle ACG starter.
- Endurance with ripple current : 3,000 to 5,000 hours at 105°C
- Rated voltage range : 16 to 100V, Capacitance range : 68 to 12,000μF
- Non solvent resistant type
- RoHS2 Compliant
- AEC-Q200 compliant : Please contact Chemi-Con for more details, test data, information.



SPECIFICATIONS

Items	Characteristics							
Category	-40 to +105°C							
Temperature Range								
Rated Voltage Range	16 to 100V _{dc}							
Capacitance Tolerance	±20% (M) (at 20°C, 120Hz)							
Leakage Current	I=0.01CV or 3μA, whichever is greater. Where, I : Max. leakage current (μA), C : Nominal capacitance (μF), V : Rated voltage (V) (at 20°C after 2 minutes)							
Dissipation Factor (tan δ)	Rated voltage (V _{dc})	16V	25V	35V	50V	63V	80V	100V
	tan δ (Max.)	0.16	0.14	0.12	0.10	0.09	0.09	0.08
When nominal capacitance exceeds 1,000μF, add 0.02 to the value above for each 1,000μF increase. (at 20°C, 120Hz)								
Low Temperature Characteristics (Max. Impedance Ratio)	Rated voltage (V _{dc})	16V	25V	35V	50V	63V	80V	100V
	Z (-25°C) / Z (+20°C)	3	2	2	2	2	2	2
	Z (-40°C) / Z (+20°C)	8	5	4	3	3	3	3
(at 120Hz)								
Endurance	The following specifications shall be satisfied when the capacitors are restored to 20°C after subjected to DC voltage with the rated ripple current is applied (the peak voltage shall not exceed the rated voltage) for 5,000 hours (3,000 hours for φ 10) at 105°C.							
	Capacitance change	≤ ±25% of the initial value						
	D.F. (tan δ)	≤200% of the initial specified value						
	Leakage current	≤The initial specified value						
Shelf Life	The following specifications shall be satisfied when the capacitors are restored to 20°C after exposing them for 500 hours at 105°C without voltage applied. Before the measurement, the capacitor shall be preconditioned by applying voltage according to Item 4.1 of JIS C 5101-4.							
	Capacitance change	≤ ±25% of the initial value						
	D.F. (tan δ)	≤200% of the initial specified value						
	Leakage current	≤The initial specified value						

*Note: If any doubts arises, measure the leakage current after carrying out the following voltage treatment.
Voltage treatment: DC rated voltage is applied to the capacitors for 30 to 60 minutes at room temperature.

DIMENSIONS [mm]

Terminal Code : E

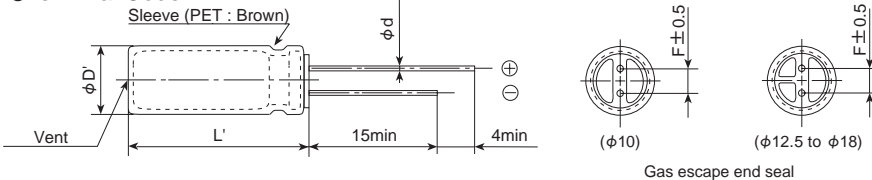

φD	10	12.5	16	18
φd	0.6	0.6	0.8	0.8
F	5.0	5.0	7.5	7.5
φD'	φD+0.5max.			
L'	L+1.5max.			

PART NUMBERING SYSTEM

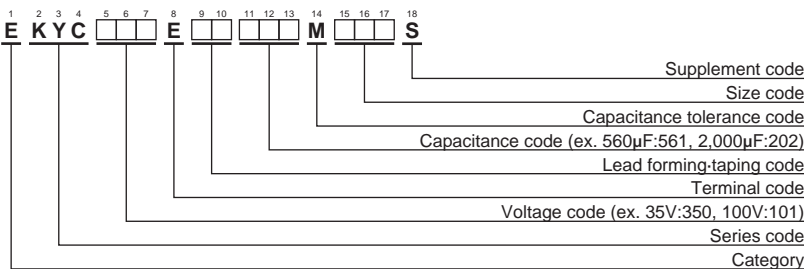

Please refer to "Product code guide (radial lead type)"

KYC series is the product, based on AEC-Q200 standard, for specific applications or market such as compact mobility. Please contact us when selecting KYC series for the important applications related to automotive or its safety.



STANDARD RATINGS

Table with columns: WV (Vdc), Cap (µF), Case size (φD×L(mm)), ESR (Ω max./20°C, 100kHz), Rated ripple current (mArms/105°C, 100kHz), Part No. (repeated for two columns). Rows are categorized by WV values: 16, 25, 35, 50, 63, 80, 100.

□ □ : Enter the appropriate lead forming or taping code.

RATED RIPPLE CURRENT MULTIPLIERS

Frequency Multipliers

Table with columns: Capacitance (µF), Frequency (Hz), 120, 1k, 10k, 100k. Rows show capacitance ranges and their corresponding multipliers.

The deterioration of aluminum electrolytic capacitors accelerates their life due to the internal heating produced by ripple current. For details, refer to Section "5-3 Ripple Current Effect on Lifetime" in the catalog, Technical Note.

KYC series is the product, based on AEC-Q200 standard, for specific applications or market such as compact mobility. Please contact us when selecting KYC series for the important applications related to automotive or its safety.



KYB Series

- Low impedance, high ripple and long life from KYA series
- Newly innovative electrolyte is employed to minimize impedance
- Endurance with ripple current : 4,000 to 10,000 hours at 105°C
- Non solvent resistant type
- RoHS2 Compliant

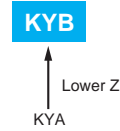

SPECIFICATIONS

Items	Characteristics										
Category	-40 to +105°C										
Temperature Range	-40 to +105°C										
Rated Voltage Range	6.3 to 100V _{dc}										
Capacitance Tolerance	±20% (M) (at 20°C, 120Hz)										
Leakage Current	I=0.01CV or 3μA, whichever is greater. Where, I : Max. leakage current (μA), C : Nominal capacitance (μF), V : Rated voltage (V) (at 20°C after 2 minutes)										
Dissipation Factor (tan δ)	Rated voltage (V _{dc})	6.3V	10V	16V	25V	35V	50V	63V	80V	100V	
	tan δ (Max.)	0.22	0.19	0.16	0.14	0.12	0.10	0.09	0.09	0.08	
	When nominal capacitance exceeds 1,000μF, add 0.02 to the value above for each 1,000μF increase. (at 20°C, 120Hz)										
Low Temperature Characteristics (Max. Impedance Ratio)	Rated voltage (V _{dc})	6.3V	10V	16V	25V	35V	50V	63V	80V	100V	
	Z(-25°C)/Z(+20°C)	4	3	2	2	2	2	2	2	2	
	Z(-40°C)/Z(+20°C)	8	6	4	3	3	3	3	3	3	
Endurance	The following specifications shall be satisfied when the capacitors are restored to 20°C after subjected to DC voltage with the rated ripple current is applied (the peak voltage shall not exceed the rated voltage) for the specified period of time at 105°C.										
	Rated Voltage(V _{dc})	6.3 to 10V _{dc}					16 to 100V _{dc}				
	Time	φ5: 4,000hours φ6.3 & 8: 6,000hours φ10 to 18: 8,000hours					φ5: 5,000hours φ6.3 & 8: 7,000hours φ10 to 18: 10,000hours				
	Capacitance change	≤ ±30% of the initial value					≤ ±25% of the initial value				
	D.F. (tan δ)	≤200% of the initial specified value					≤200% of the initial specified value				
	Leakage current	≤The initial specified value					≤The initial specified value				
Shelf Life	The following specifications shall be satisfied when the capacitors are restored to 20°C after exposing them for 500 hours at 105°C without voltage applied. Before the measurement, the capacitor shall be preconditioned by applying voltage according to Item 4.1 of JIS C 5101-4.										
	Capacitance change	≤ ±25% of the initial value									
	D.F. (tan δ)	≤200% of the initial specified value									
	Leakage current	≤The initial specified value									

DIMENSIONS [mm]

● Terminal Code : E

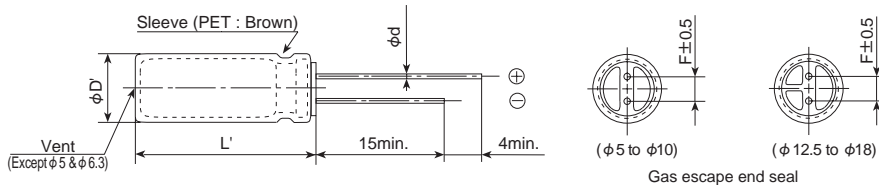

φD	5	6.3	8	10	12.5	16	18
φd	0.5	0.5	0.6	0.6	0.6	0.8	0.8
F	2.0	2.5	3.5	5.0	5.0	7.5	7.5
φD'	φD+0.5max.						
L'	L+1.5max.						

PART NUMBERING SYSTEM

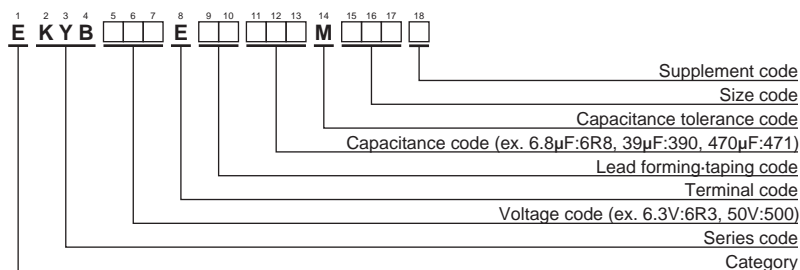

Please refer to "Product code guide (radial lead type)"



◆ STANDARD RATINGS

VV (V _{dc})	Cap (μF)	Case size φD×L(mm)	Impedance (Ω max./100kHz)		Rated ripple current (mA rms/105°C, 100kHz)	Part No.	VV (V _{dc})	Cap (μF)	Case size φD×L(mm)	Impedance (Ω max./100kHz)		Rated ripple current (mA rms/105°C, 100kHz)	Part No.
			20°C	-10°C						20°C	-10°C		
6.3	180	5×11	0.29	1.2	340	EKYB6R3E□□181ME11D	16	4,700	12.5×35	0.018	0.072	3,140	EKYB160E□□472MK35S
	390	6.3×11	0.15	0.60	540	EKYB6R3E□□391MF11D		4,700	18×20	0.021	0.084	3,000	EKYB160E□□472MM20S
	820	8×11.5	0.087	0.35	840	EKYB6R3E□□821MHB5D		5,600	12.5×40	0.017	0.068	3,640	EKYB160E□□562MK40S
	1,200	8×15	0.069	0.28	1,050	EKYB6R3E□□122MH15D		5,600	16×25	0.020	0.080	3,140	EKYB160E□□562ML25S
	1,200	10×12.5	0.064	0.26	1,050	EKYB6R3E□□122MJC5S		6,800	16×31.5	0.016	0.064	3,610	EKYB160E□□682MLN3S
	1,500	8×20	0.060	0.24	1,210	EKYB6R3E□□152MH20D		6,800	18×25	0.017	0.068	3,530	EKYB160E□□682MM25S
	1,800	10×16	0.049	0.20	1,400	EKYB6R3E□□182MJ16S		8,200	16×35.5	0.014	0.056	4,080	EKYB160E□□822MLP1S
	2,200	10×20	0.037	0.15	1,650	EKYB6R3E□□222MJ20S		8,200	18×31.5	0.014	0.056	4,220	EKYB160E□□822MMN3S
	2,700	10×25	0.031	0.13	1,910	EKYB6R3E□□272MJ25S		10,000	16×40	0.013	0.052	4,220	EKYB160E□□103ML40S
	3,300	10×30	0.027	0.11	2,230	EKYB6R3E□□332MJ30S		10,000	18×35.5	0.012	0.048	4,280	EKYB160E□□103MMP1S
	3,900	12.5×20	0.027	0.11	2,230	EKYB6R3E□□392MK20S		12,000	18×40	0.011	0.044	4,700	EKYB160E□□123MM40S
	4,700	12.5×25	0.024	0.096	2,530	EKYB6R3E□□472MK20S		82	5×11	0.29	1.2	340	EKYB250E□□820ME11D
	6,800	12.5×30	0.021	0.084	2,860	EKYB6R3E□□682MK30S		150	6.3×11	0.15	0.60	540	EKYB250E□□151MF11D
	6,800	16×20	0.025	0.10	2,610	EKYB6R3E□□682ML20S		330	8×11.5	0.087	0.35	840	EKYB250E□□331MHB5D
	8,200	12.5×35	0.018	0.072	3,140	EKYB6R3E□□822MK35S		390	8×15	0.069	0.28	1,050	EKYB250E□□391MH15D
	8,200	18×20	0.021	0.084	3,000	EKYB6R3E□□822MM20S		470	10×12.5	0.064	0.26	1,050	EKYB250E□□471MJC5S
	10,000	12.5×40	0.017	0.068	3,640	EKYB6R3E□□103MK40S		560	8×20	0.060	0.24	1,210	EKYB250E□□561MH20D
	10,000	16×25	0.020	0.080	3,140	EKYB6R3E□□103ML25S		680	10×16	0.049	0.20	1,400	EKYB250E□□681MJ16S
	12,000	16×31.5	0.016	0.064	3,610	EKYB6R3E□□123MLN3S		1,000	10×20	0.037	0.15	1,650	EKYB250E□□102MJ20S
	12,000	18×25	0.017	0.068	3,530	EKYB6R3E□□123MM25S		1,200	10×25	0.031	0.13	1,910	EKYB250E□□122MJ25S
	15,000	16×35.5	0.014	0.056	4,080	EKYB6R3E□□153MLP1S		1,500	10×30	0.027	0.11	2,230	EKYB250E□□152MJ30S
	15,000	18×31.5	0.014	0.056	4,220	EKYB6R3E□□153MMN3S		1,500	12.5×20	0.027	0.11	2,230	EKYB250E□□152MK20S
18,000	16×40	0.013	0.052	4,220	EKYB6R3E□□183ML40S	2,200	12.5×25	0.024	0.096	2,530	EKYB250E□□222MK25S		
18,000	18×35.5	0.012	0.048	4,280	EKYB6R3E□□183MMP1S	2,700	12.5×30	0.021	0.084	2,860	EKYB250E□□272MK30S		
22,000	18×40	0.011	0.044	4,700	EKYB6R3E□□223MM40S	2,700	16×20	0.025	0.10	2,610	EKYB250E□□272ML20S		
10	120	5×11	0.29	1.2	340	EKYB100E□□121ME11D	3,300	12.5×35	0.018	0.072	3,140	EKYB250E□□332MK35S	
	330	6.3×11	0.15	0.60	540	EKYB100E□□331MF11D	3,300	18×20	0.021	0.084	3,000	EKYB250E□□332MM20S	
	560	8×11.5	0.087	0.35	840	EKYB100E□□561MHB5D	3,900	12.5×40	0.017	0.068	3,640	EKYB250E□□392MK40S	
	820	8×15	0.069	0.28	1,050	EKYB100E□□821MH15D	3,900	16×25	0.020	0.080	3,140	EKYB250E□□392ML25S	
	1,000	8×20	0.060	0.24	1,210	EKYB100E□□102MH20D	4,700	16×31.5	0.016	0.064	3,610	EKYB250E□□472MLN3S	
	1,000	10×12.5	0.064	0.26	1,050	EKYB100E□□102MJC5S	4,700	18×25	0.017	0.068	3,530	EKYB250E□□472MM25S	
	1,200	10×16	0.049	0.20	1,400	EKYB100E□□122MJ16S	5,600	16×35.5	0.014	0.056	4,080	EKYB250E□□562MLP1S	
	1,800	10×20	0.037	0.15	1,650	EKYB100E□□182MJ20S	6,800	16×40	0.013	0.052	4,220	EKYB250E□□682ML40S	
	2,200	10×25	0.031	0.13	1,910	EKYB100E□□222MJ25S	6,800	18×31.5	0.014	0.056	4,220	EKYB250E□□682MMN3S	
	2,700	10×30	0.027	0.11	2,230	EKYB100E□□272MJ30S	8,200	18×35.5	0.012	0.048	4,280	EKYB250E□□822MMP1S	
	2,700	12.5×20	0.027	0.11	2,230	EKYB100E□□272MK20S	47	5×11	0.29	1.2	340	EKYB350E□□470ME11D	
	3,900	12.5×25	0.024	0.096	2,530	EKYB100E□□392MK25S	100	6.3×11	0.15	0.60	540	EKYB350E□□101MF11D	
	4,700	12.5×30	0.021	0.084	2,860	EKYB100E□□472MK30S	180	8×11.5	0.087	0.35	840	EKYB350E□□181MHB5D	
	4,700	16×20	0.025	0.10	2,610	EKYB100E□□472ML20S	270	8×15	0.069	0.28	1,050	EKYB350E□□271MH15D	
	5,600	12.5×35	0.018	0.072	3,140	EKYB100E□□562MK35S	330	8×20	0.060	0.24	1,210	EKYB350E□□331MH20D	
	6,800	12.5×40	0.017	0.068	3,640	EKYB100E□□682MK40S	330	10×12.5	0.064	0.26	1,050	EKYB350E□□331MJC5S	
	6,800	16×25	0.020	0.080	3,140	EKYB100E□□682ML25S	470	10×16	0.049	0.20	1,400	EKYB350E□□471MJ16S	
	6,800	18×20	0.021	0.084	3,000	EKYB100E□□682MM20S	680	10×20	0.037	0.15	1,650	EKYB350E□□681MJ20S	
8,200	16×31.5	0.016	0.064	3,610	EKYB100E□□822MLN3S	820	10×25	0.031	0.13	1,910	EKYB350E□□821MJ25S		
8,200	18×25	0.017	0.068	3,530	EKYB100E□□822MM25S	1,000	10×30	0.027	0.11	2,230	EKYB350E□□102MJ30S		
10,000	16×35.5	0.014	0.056	4,080	EKYB100E□□103MLP1S	1,000	12.5×20	0.027	0.11	2,230	EKYB350E□□102MK20S		
10,000	18×31.5	0.014	0.056	4,220	EKYB100E□□103MMN3S	1,500	12.5×25	0.024	0.096	2,530	EKYB350E□□152MK25S		
12,000	16×40	0.013	0.052	4,220	EKYB100E□□123ML40S	1,800	12.5×30	0.021	0.084	2,860	EKYB350E□□182MK30S		
12,000	18×35.5	0.012	0.048	4,280	EKYB100E□□123MMP1S	1,800	16×20	0.025	0.10	2,610	EKYB350E□□182ML20S		
15,000	18×40	0.011	0.044	4,700	EKYB100E□□153MM40S	2,200	12.5×35	0.018	0.072	3,140	EKYB350E□□222MK35S		
16	120	5×11	0.29	1.2	340	EKYB160E□□121ME11D	2,200	18×20	0.021	0.084	3,000	EKYB350E□□222MM20S	
	270	6.3×11	0.15	0.60	540	EKYB160E□□271MF11D	2,700	12.5×40	0.017	0.068	3,640	EKYB350E□□272MK40S	
	470	8×11.5	0.087	0.35	840	EKYB160E□□471MHB5D	2,700	16×25	0.020	0.080	3,140	EKYB350E□□272ML25S	
	680	8×15	0.069	0.28	1,050	EKYB160E□□681MH15D	3,300	16×31.5	0.016	0.064	3,610	EKYB350E□□332MLN3S	
	680	10×12.5	0.064	0.26	1,050	EKYB160E□□681MJC5S	3,300	18×25	0.017	0.068	3,530	EKYB350E□□332MM25S	
	820	8×20	0.060	0.24	1,210	EKYB160E□□821MH20D	3,900	16×35.5	0.014	0.056	4,080	EKYB350E□□392MLP1S	
	1,000	10×16	0.049	0.20	1,400	EKYB160E□□102MJ16S	4,700	16×40	0.013	0.052	4,220	EKYB350E□□472ML40S	
	1,500	10×20	0.037	0.15	1,650	EKYB160E□□152MJ20S	4,700	18×31.5	0.014	0.056	4,220	EKYB350E□□472MMN3S	
	1,800	10×25	0.031	0.13	1,910	EKYB160E□□182MJ25S	5,600	18×35.5	0.012	0.048	4,280	EKYB350E□□562MMP1S	
	2,200	10×30	0.027	0.11	2,230	EKYB160E□□222MJ30S	27	5×11	0.48	2.0	238	EKYB500E□□270ME11D	
	2,200	12.5×20	0.027	0.11	2,230	EKYB160E□□222MK20S	56	6.3×11	0.20	0.80	385	EKYB500E□□560MF11D	
	3,300	12.5×25	0.024	0.096	2,530	EKYB160E□□332MK25S	100	8×11.5	0.12	0.48	620	EKYB500E□□101MHB5D	
	3,900	12.5×30	0.021	0.084	2,860	EKYB160E□□392MK30S	150	8×15	0.093	0.38	810	EKYB500E□□151MH15D	
	3,900	16×20	0.025	0.10	2,610	EKYB160E□□392ML20S	150	10×12.5	0.10	0.40	810	EKYB500E□□151MJC5S	

□ □ : Enter the appropriate lead forming or taping code.
 Production of the products shown in [] is scheduled to be discontinued.



KYB Series

◆STANDARD RATINGS

WV (V _{dc})	Cap (μF)	Case size φD×L(mm)	Impedance (Ω max./100kHz)		Rated ripple current (mA _{rms} /105°C, 100kHz)	Part No.	WV (V _{dc})	Cap (μF)	Case size φD×L(mm)	Impedance (Ω max./100kHz)		Rated ripple current (mA _{rms} /105°C, 100kHz)	Part No.
			20°C	-10°C						20°C	-10°C		
50	180	8×20	0.075	0.30	980	EKYB500E□□181MH20D	80	56	8×15	0.14	0.56	585	EKYB800E□□560MH15D
	220	10×16	0.069	0.28	1,100	EKYB500E□□221MJ16S		82	8×20	0.11	0.44	735	EKYB800E□□820MH20D
	270	10×20	0.055	0.22	1,300	EKYB500E□□271MJ20S		82	10×12.5	0.14	0.56	624	EKYB800E□□820MJC5S
	390	10×25	0.043	0.18	1,600	EKYB500E□□391MJ25S		120	10×16	0.10	0.40	780	EKYB800E□□121MJ16S
	470	10×30	0.038	0.16	1,820	EKYB500E□□471MJ30S		180	10×20	0.075	0.30	1,040	EKYB800E□□181MJ20S
	470	12.5×20	0.034	0.14	1,820	EKYB500E□□471MK20S		220	10×25	0.060	0.24	1,170	EKYB800E□□221MJ25S
	680	12.5×25	0.030	0.12	2,100	EKYB500E□□681MK25S		270	10×30	0.053	0.22	1,350	EKYB800E□□271MJ30S
	820	12.5×30	0.025	0.10	2,450	EKYB500E□□821MK30S		270	12.5×20	0.048	0.20	1,430	EKYB800E□□271MK20S
	820	16×20	0.028	0.12	2,350	EKYB500E□□821ML20S		390	12.5×25	0.039	0.16	1,620	EKYB800E□□391MK25S
	1,000	12.5×35	0.021	0.084	2,800	EKYB500E□□102MK35S		470	12.5×30	0.033	0.14	1,950	EKYB800E□□471MK30S
	1,000	18×20	0.025	0.10	2,600	EKYB500E□□102MM20S		470	16×20	0.036	0.15	1,750	EKYB800E□□471ML20S
	1,200	12.5×40	0.019	0.076	3,100	EKYB500E□□122MK30S		560	12.5×35	0.026	0.11	2,250	EKYB800E□□561MM20S
	1,200	16×25	0.024	0.096	2,750	EKYB500E□□122ML25S		560	18×20	0.032	0.13	2,100	EKYB800E□□561MM20S
	1,500	16×31.5	0.019	0.076	3,150	EKYB500E□□152MLN3S		680	12.5×40	0.024	0.096	2,450	EKYB800E□□681MK40S
	1,500	18×25	0.021	0.084	2,890	EKYB500E□□152MM25S		680	16×25	0.028	0.12	2,250	EKYB800E□□681ML25S
	1,800	16×35.5	0.016	0.064	3,550	EKYB500E□□180ME11D		820	16×31.5	0.022	0.088	2,400	EKYB800E□□821MLN3S
	2,200	16×40	0.014	0.056	3,900	EKYB500E□□222ML40S		820	18×25	0.027	0.11	2,270	EKYB800E□□821MM25S
	2,200	18×31.5	0.014	0.056	3,800	EKYB500E□□222MMN3S		1,000	16×35.5	0.020	0.080	2,600	EKYB800E□□102MLP1S
	2,700	18×35.5	0.013	0.052	4,100	EKYB500E□□272MMP1S		1,200	16×40	0.018	0.072	2,900	EKYB800E□□122ML40S
	63	18	5×11	0.50	2.0	220		EKYB630E□□180ME11D	1,200	18×31.5	0.020	0.080	2,550
33		6.3×11	0.25	1.0	350	EKYB630E□□330MF11D	1,500	18×35.5	0.018	0.072	3,050	EKYB800E□□152MMP1S	
56		8×11.5	0.16	0.64	530	EKYB630E□□560MHB5D	100	6.8	5×11	0.80	3.2	163	EKYB101E□□6R8ME11D
82		8×15	0.12	0.48	700	EKYB630E□□820MH15D		15	6.3×11	0.43	1.8	267	EKYB101E□□150MF11D
120		8×20	0.085	0.34	880	EKYB630E□□121MH20S		27	8×11.5	0.18	0.72	462	EKYB101E□□270MHB5D
120		10×12.5	0.11	0.44	725	EKYB630E□□121MJC5S		39	8×15	0.14	0.56	585	EKYB101E□□390MH15D
180		10×16	0.073	0.30	1,050	EKYB630E□□181MJ16S		56	8×20	0.11	0.44	735	EKYB101E□□560MH20D
220		10×20	0.055	0.22	1,300	EKYB630E□□221MJ20S		56	10×12.5	0.14	0.56	624	EKYB101E□□560MJC5S
330		10×25	0.045	0.18	1,550	EKYB630E□□331MJ25S		82	10×16	0.10	0.40	780	EKYB101E□□820MJ16S
390		10×30	0.040	0.16	1,780	EKYB630E□□391MJ30S		100	10×20	0.075	0.30	1,040	EKYB101E□□101MJ20S
390		12.5×20	0.036	0.15	1,780	EKYB630E□□391MK20S		120	10×25	0.060	0.24	1,170	EKYB101E□□121MJ25S
560		12.5×25	0.030	0.12	2,100	EKYB630E□□561MK25S		150	10×30	0.053	0.22	1,350	EKYB101E□□151MJ30S
680		12.5×30	0.026	0.11	2,415	EKYB630E□□681MK30S		180	12.5×20	0.048	0.20	1,430	EKYB101E□□181MK20S
680		16×20	0.028	0.12	2,250	EKYB630E□□681ML20S		220	12.5×25	0.039	0.16	1,620	EKYB101E□□221MK25S
820		12.5×35	0.022	0.088	2,700	EKYB630E□□821MK35S		270	12.5×30	0.033	0.14	1,950	EKYB101E□□271MK30S
820		18×20	0.028	0.12	2,500	EKYB630E□□821MM20S		270	16×20	0.036	0.15	1,750	EKYB101E□□271ML20S
1,000		12.5×40	0.020	0.080	3,000	EKYB630E□□102MK40S		330	16×25	0.028	0.12	2,250	EKYB101E□□331ML25S
1,000		16×25	0.025	0.10	2,730	EKYB630E□□102ML25S		390	12.5×35	0.026	0.11	2,250	EKYB101E□□391MK35S
1,200		16×31.5	0.020	0.080	3,000	EKYB630E□□122MLN3S		390	18×20	0.032	0.13	2,100	EKYB101E□□391MM20S
1,200		18×25	0.022	0.088	2,800	EKYB630E□□122MM25S		470	12.5×40	0.024	0.096	2,450	EKYB101E□□471MK40S
1,500	16×35.5	0.018	0.072	3,200	EKYB630E□□152MLP1S	470		16×31.5	0.022	0.088	2,400	EKYB101E□□471MLN3S	
1,500	18×31.5	0.018	0.072	3,300	EKYB630E□□152MMN3S	560		16×35.5	0.020	0.080	2,600	EKYB101E□□561MLP1S	
1,800	16×40	0.016	0.064	3,590	EKYB630E□□182ML40S	560	18×25	0.027	0.11	2,270	EKYB101E□□561MM25S		
1,800	18×35.5	0.017	0.068	3,570	EKYB630E□□182MMP1S	680	16×40	0.018	0.072	2,900	EKYB101E□□681ML40S		
2,200	18×40	0.016	0.064	3,670	EKYB630E□□222MM40S	680	18×31.5	0.020	0.080	2,550	EKYB101E□□681MMN3S		
80	12	5×11	0.80	3.2	163	EKYB800E□□120ME11D	820	18×35.5	0.018	0.072	3,050	EKYB101E□□821MMP1S	
	22	6.3×11	0.43	1.8	267	EKYB800E□□220MF11D	1,000	18×40	0.017	0.068	3,510	EKYB101E□□102MM40S	
	39	8×11.5	0.18	0.72	462	EKYB800E□□390MHB5D							

□□ : Enter the appropriate lead forming or taping code.
 Production of the products shown in [] is scheduled to be discontinued.

◆RATED RIPPLE CURRENT MULTIPLIERS

● Frequency Multipliers

Capacitance(μF)	Frequency(Hz)			
	120	1k	10k	100k
6.8 to 180	0.40	0.75	0.90	1.00
220 to 560	0.50	0.85	0.94	1.00
680 to 1,800	0.60	0.87	0.95	1.00
2,200 to 3,900	0.75	0.90	0.95	1.00
4,700 to	0.85	0.95	0.98	1.00

The deterioration of aluminum electrolytic capacitors accelerates their life due to the internal heating produced by ripple current. For details, refer to Section "5-3 Ripple Current Effect on Lifetime" in the catalog, Technical Note.



KYA Series

- Downsized from KY series
- Newly innovative electrolyte is employed to minimize impedance
- Endurance with ripple current : 4,000 to 10,000 hours at 105°C
- Non solvent resistant type
- RoHS2 Compliant

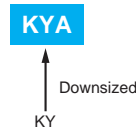

SPECIFICATIONS

Items	Characteristics	
Category	-40 to +105°C	
Temperature Range		
Rated Voltage Range	6.3 to 100V _{dc}	
Capacitance Tolerance	±20% (M) (at 20°C, 120Hz)	
Leakage Current	I=0.01CV or 3μA, whichever is greater. Where, I : Max. leakage current (μA), C : Nominal capacitance (μF), V : Rated voltage (V) (at 20°C after 2 minutes)	
Dissipation Factor (tan δ)	Rated voltage (V _{dc})	6.3V 10V 16V 25V 35V 50V 63V 100V
	tan δ (Max.)	0.22 0.19 0.16 0.14 0.12 0.10 0.09 0.08
	When nominal capacitance exceeds 1,000μF, add 0.02 to the value above for each 1,000μF increase. (at 20°C, 120Hz)	
Low Temperature Characteristics (Max. Impedance Ratio)	Rated voltage (V _{dc})	6.3V 10V 16V 25V 35V 50V 63V 100V
	Z(-25°C)/Z(+20°C)	4 3 2 2 2 2 2 2
	Z(-40°C)/Z(+20°C)	8 6 4 3 3 3 3 3 (at 120Hz)
Endurance	The following specifications shall be satisfied when the capacitors are restored to 20°C after subjected to DC voltage with the rated ripple current is applied (the peak voltage shall not exceed the rated voltage) for the specified period of time at 105°C.	
	Time	6.3 to 10V _{dc} φ5 & 6.3 : 4,000hours φ8 & 10 : 6,000hours φ12.5 to 16 : 8,000hours 16 to 100V _{dc} φ5 & 6.3 : 5,000hours φ8 & 10 : 7,000hours φ12.5 to 16 : 10,000hours
	Capacitance change	≤ ±25% of the initial value
	D.F. (tan δ)	≤200% of the initial specified value
	Leakage current	≤The initial specified value
Shelf Life	The following specifications shall be satisfied when the capacitors are restored to 20°C after exposing them for 500 hours at 105°C without voltage applied. Before the measurement, the capacitor shall be preconditioned by applying voltage according to Item 4.1 of JIS C 5101-4.	
	Capacitance change	≤ ±25% of the initial value
	D.F. (tan δ)	≤200% of the initial specified value
	Leakage current	≤The initial specified value

DIMENSIONS [mm]

● Terminal Code : E

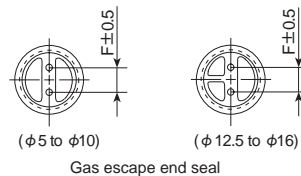
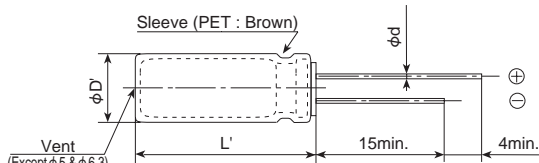

φD	5	6.3	8	10	12.5	16
φd	0.5	0.5	0.6	0.6	0.6	0.8
F	2.0	2.5	3.5	5.0	5.0	7.5
φD'	φD+0.5max.					
L'	L+1.5max.					

PART NUMBERING SYSTEM

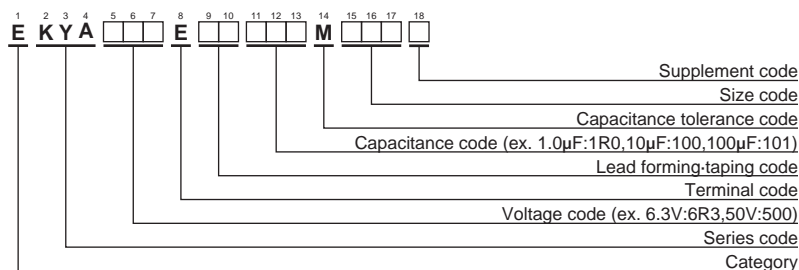

Please refer to "Product code guide (radial lead type)"



◆STANDARD RATINGS

WV (V _{dc})	Cap (μF)	Case size φD×L(mm)	Impedance (Ω max./100kHz)		Rated ripple current (mA rms/105°C, 100kHz)	Part No.	WV (V _{dc})	Cap (μF)	Case size φD×L(mm)	Impedance (Ω max./100kHz)		Rated ripple current (mA rms/105°C, 100kHz)	Part No.	
			20°C	-10°C						20°C	-10°C			
6.3	100	5×11	0.90	3.6	150	EKYA6R3E□□101ME11D	25	3,300	16×25	0.021	0.060	2,930	EKYA250E□□332ML25S	
	180	5×11	0.40	1.6	250	EKYA6R3E□□181ME11D		3,900	16×25	0.021	0.060	2,930	EKYA250E□□392ML25S	
	220	5×11	0.40	1.6	250	EKYA6R3E□□221ME11D		4,700	16×31.5	0.017	0.050	3,450	EKYA250E□□472MLN3S	
	330	6.3×11	0.22	0.87	400	EKYA6R3E□□331MF11D		5,600	16×35.5	0.015	0.044	3,610	EKYA250E□□562MLP1S	
	470	6.3×11	0.22	0.87	400	EKYA6R3E□□471MF11D		35	33	5×11	0.40	1.6	250	EKYA350E□□330ME11D
	820	8×11.5	0.13	0.52	640	EKYA6R3E□□821MHB5D			47	5×11	0.40	1.6	250	EKYA350E□□470ME11D
	1,200	10×12.5	0.080	0.32	865	EKYA6R3E□□122MJC5S			100	6.3×11	0.22	0.87	400	EKYA350E□□101MF11D
	1,200	8×15	0.087	0.35	840	EKYA6R3E□□122MH20D			220	8×11.5	0.13	0.52	640	EKYA350E□□221MHB5D
	1,500	8×20	0.069	0.27	1,050	EKYA6R3E□□152MH20D			270	8×15	0.087	0.35	840	EKYA350E□□271MH15D
	1,800	10×16	0.060	0.24	1,300	EKYA6R3E□□182MJ16S			330	10×12.5	0.080	0.32	865	EKYA350E□□331MJC5S
	2,700	10×20	0.046	0.18	1,400	EKYA6R3E□□272MJ20S			390	8×20	0.069	0.27	1,050	EKYA350E□□391MH20D
	3,300	10×25	0.042	0.17	1,650	EKYA6R3E□□332MJ25S			470	10×16	0.060	0.24	1,300	EKYA350E□□471MJ16S
	3,900	12.5×20	0.035	0.12	1,900	EKYA6R3E□□392MK20S			680	10×20	0.046	0.18	1,400	EKYA350E□□681MJ20S
	4,700	12.5×25	0.027	0.089	2,230	EKYA6R3E□□472MK25S			820	10×25	0.042	0.17	1,650	EKYA350E□□821MJ25S
	5,600	12.5×25	0.027	0.089	2,230	EKYA6R3E□□562MK25S			1,000	12.5×20	0.035	0.12	1,900	EKYA350E□□102MK20S
10,000	16×25	0.021	0.060	2,930	EKYA6R3E□□103ML25S	1,500	12.5×25		0.027	0.089	2,230	EKYA350E□□152MK25S		
12,000	16×31.5	0.017	0.050	3,450	EKYA6R3E□□123MLN3S	2,200	16×25		0.021	0.060	2,930	EKYA350E□□222ML25S		
15,000	16×35.5	0.015	0.044	3,610	EKYA6R3E□□153MLP1S	2,700	16×25		0.021	0.060	2,930	EKYA350E□□272ML25S		
10	100	5×11	0.90	3.6	150	EKYA100E□□101ME11D	3,300		16×31.5	0.017	0.050	3,450	EKYA350E□□332MLN3S	
	120	5×11	0.40	1.6	250	EKYA100E□□121ME11D	3,900	16×35.5	0.015	0.044	3,610	EKYA350E□□392MLP1S		
	330	6.3×11	0.22	0.87	400	EKYA100E□□331MF11D	50	1.0	5×11	4.0	16	30	EKYA500E□□1R0ME11D	
	560	8×11.5	0.13	0.52	640	EKYA100E□□561MHB5D		2.2	5×11	2.5	10	43	EKYA500E□□2R2ME11D	
	820	8×15	0.087	0.35	840	EKYA100E□□821MH15D		3.3	5×11	2.2	8.8	53	EKYA500E□□3R3ME11D	
	820	10×12.5	0.080	0.32	865	EKYA100E□□821MJC5S		4.7	5×11	1.9	7.6	88	EKYA500E□□4R7ME11D	
	1,000	10×12.5	0.080	0.32	865	EKYA100E□□102MJC5S		10	5×11	1.5	6.0	100	EKYA500E□□100ME11D	
	1,200	8×20	0.069	0.27	1,050	EKYA100E□□122MH20D		22	5×11	0.70	2.8	180	EKYA500E□□220ME11D	
	1,200	10×16	0.060	0.24	1,300	EKYA100E□□122MJ16S		27	5×11	0.70	2.8	250	EKYA500E□□270ME11D	
	1,800	10×20	0.046	0.18	1,400	EKYA100E□□182MJ20S		47	6.3×11	0.30	1.2	295	EKYA500E□□470MF11D	
	2,200	10×25	0.042	0.17	1,650	EKYA100E□□222MJ25S		56	6.3×11	0.30	1.2	295	EKYA500E□□560MF11D	
	3,300	12.5×20	0.035	0.12	1,900	EKYA100E□□332MK20S		100	8×11.5	0.17	0.68	555	EKYA500E□□101MHB5D	
3,900	12.5×25	0.027	0.089	2,230	EKYA100E□□392MK25S	150		8×15	0.12	0.48	730	EKYA500E□□151MH15D		
6,800	16×25	0.021	0.060	2,930	EKYA100E□□682ML25S	180		10×12.5	0.12	0.48	760	EKYA500E□□181MJC5S		
10,000	16×31.5	0.017	0.050	3,450	EKYA100E□□103MLN3S	180	8×20	0.091	0.36	910	EKYA500E□□181MH20D			
12,000	16×35.5	0.015	0.044	3,610	EKYA100E□□123MLP1S	220	10×16	0.084	0.34	1,050	EKYA500E□□221MJ16S			
16	47	5×11	0.40	1.6	250	EKYA160E□□470ME11D	330	10×20	0.060	0.24	1,220	EKYA500E□□331MJ20S		
	100	5×11	0.40	1.6	250	EKYA160E□□101ME11D	470	10×25	0.055	0.22	1,440	EKYA500E□□471MJ25S		
	220	6.3×11	0.22	0.87	400	EKYA160E□□221MF11D	470	12.5×20	0.045	0.15	1,660	EKYA500E□□471MK20S		
	270	6.3×11	0.22	0.87	400	EKYA160E□□271MF11D	560	12.5×20	0.045	0.15	1,660	EKYA500E□□561MK20S		
	470	8×11.5	0.13	0.52	640	EKYA160E□□471MHB5D	820	12.5×25	0.034	0.11	1,950	EKYA500E□□821MK25S		
	680	8×15	0.087	0.35	840	EKYA160E□□681MH15D	1,000	16×25	0.025	0.075	2,555	EKYA500E□□102ML25S		
	680	10×12.5	0.080	0.32	865	EKYA160E□□681MJC5S	1,200	16×25	0.025	0.075	2,555	EKYA500E□□122ML25S		
	820	8×20	0.069	0.27	1,050	EKYA160E□□821MH20D	1,800	16×31.5	0.022	0.066	3,010	EKYA500E□□182MLN3S		
	1,000	10×16	0.060	0.24	1,300	EKYA160E□□102MJ16S	2,200	16×35.5	0.019	0.057	3,150	EKYA500E□□222MLP1S		
	1,500	10×20	0.046	0.18	1,400	EKYA160E□□152MJ20S	63	10	5×11	0.88	3.5	173	EKYA630E□□100ME11D	
	1,800	10×25	0.042	0.17	1,650	EKYA160E□□182MJ25S		15	5×11	0.88	3.5	173	EKYA630E□□150ME11D	
	2,200	12.5×20	0.035	0.12	1,900	EKYA160E□□222MK20S		33	6.3×11	0.35	1.4	278	EKYA630E□□330MF11D	
	3,300	12.5×25	0.027	0.089	2,230	EKYA160E□□332MK25S		56	8×11.5	0.22	0.88	500	EKYA630E□□560MHB5D	
	4,700	16×25	0.021	0.060	2,930	EKYA160E□□472ML25S		82	8×15	0.16	0.64	665	EKYA630E□□820MH15D	
	5,600	16×25	0.021	0.060	2,930	EKYA160E□□562ML25S		100	10×12.5	0.11	0.44	725	EKYA630E□□101MJC5S	
6,800	16×31.5	0.017	0.050	3,450	EKYA160E□□682MLN3S	120		8×20	0.12	0.48	820	EKYA630E□□121MH20D		
8,200	16×31.5	0.017	0.050	3,450	EKYA160E□□822MLN3S	120		10×16	0.076	0.31	950	EKYA630E□□121MJ16S		
10,000	16×35.5	0.015	0.044	3,610	EKYA160E□□103MLP1S	220		10×20	0.056	0.23	1,200	EKYA630E□□221MJ20S		
25	33	5×11	0.40	1.6	250	EKYA250E□□330ME11D		330	10×25	0.046	0.19	1,350	EKYA630E□□331MJ25S	
	47	5×11	0.40	1.6	250	EKYA250E□□470ME11D		330	12.5×20	0.041	0.13	1,570	EKYA630E□□331MK20S	
	68	5×11	0.40	1.6	250	EKYA250E□□680ME11D		390	12.5×20	0.041	0.13	1,570	EKYA630E□□391MK20S	
	150	6.3×11	0.22	0.87	400	EKYA250E□□151MF11D		470	12.5×25	0.031	0.093	1,990	EKYA630E□□471MK25S	
	330	8×11.5	0.13	0.52	640	EKYA250E□□331MHB5D		560	12.5×25	0.031	0.093	1,990	EKYA630E□□561MK25S	
	390	8×15	0.087	0.35	840	EKYA250E□□391MH15D		1,000	16×25	0.025	0.075	2,730	EKYA630E□□102ML25S	
	470	10×12.5	0.080	0.32	865	EKYA250E□□471MJC5S	1,200	16×31.5	0.021	0.063	2,850	EKYA630E□□122MLN3S		
	560	8×20	0.069	0.27	1,050	EKYA250E□□561MH20D	1,500	16×35.5	0.019	0.057	2,900	EKYA630E□□152MLP1S		
	680	10×16	0.060	0.24	1,300	EKYA250E□□681MJ16S	100	1.0	5×11	4.5	15	20	EKYA101E□□1R0ME11D	
	1,000	10×20	0.046	0.18	1,400	EKYA250E□□102MJ20S		2.2	5×11	3.0	13	30	EKYA101E□□2R2ME11D	
	1,200	10×25	0.042	0.17	1,650	EKYA250E□□122MJ25S		3.3	5×11	2.7	11	40	EKYA101E□□3R3ME11D	
	1,500	12.5×20	0.035	0.12	1,900	EKYA250E□□152MK20S		4.7	5×11	2.5	10	65	EKYA101E□□4R7ME11D	
	2,200	12.5×25	0.027	0.089	2,230	EKYA250E□□222MK25S		6.8	5×11	1.4	5.6	125	EKYA101E□□6R8ME11D	

□ □ : Enter the appropriate lead forming or taping code.

Production of the products shown in [] is scheduled to be discontinued.

Product specifications in this catalog are subject to change without notice. Request our product specifications before purchase and/or use. Please use our products based on the information contained in this catalog and product specifications.



KYA Series

◆STANDARD RATINGS

WV (V _{dc})	Cap (μF)	Case size φD×L(mm)	Impedance (Ω max./100kHz)		Rated ripple current (mA rms/ 105°C, 100kHz)	Part No.
			20°C	-10°C		
100	10	6.3×11	0.57	2.3	205	EKYA101E□□100MF11D
	15	6.3×11	0.57	2.3	205	EKYA101E□□150MF11D
	27	8×11.5	0.36	1.4	355	EKYA101E□□270MHB5D
	39	8×15	0.25	1.0	450	EKYA101E□□390MH15D
	47	10×12.5	0.17	0.66	480	EKYA101E□□470MJC5S
	56	8×20	0.19	0.76	565	EKYA101E□□560MH20D
	68	10×16	0.11	0.47	600	EKYA101E□□680MJ16S
	100	10×20	0.084	0.34	800	EKYA101E□□101MJ20S
	150	10×25	0.069	0.28	900	EKYA101E□□151MJ25S
	180	12.5×20	0.062	0.18	1,100	EKYA101E□□181MK20S
	220	12.5×25	0.047	0.14	1,250	EKYA101E□□221MK25S
	330	16×25	0.038	0.12	1,700	EKYA101E□□331ML25S
	470	16×31.5	0.032	0.095	1,850	EKYA101E□□471MLN3S
	560	16×35.5	0.029	0.086	2,000	EKYA101E□□561MLP1S

□□ : Enter the appropriate lead forming or taping code.
 Production of the products shown in □□□□ is scheduled to be discontinued.

◆RATED RIPPLE CURRENT MULTIPLIERS

⊙ Frequency Multipliers

Capacitance(μF)	Frequency(Hz)			
	120	1k	10k	100k
1.0 to 180	0.40	0.75	0.90	1.00
220 to 560	0.50	0.85	0.94	1.00
680 to 1,800	0.60	0.87	0.95	1.00
2,200 to 3,900	0.75	0.90	0.95	1.00
4,700 to	0.85	0.95	0.98	1.00

The deterioration of aluminum electrolytic capacitors accelerates their life due to the internal heating produced by ripple current. For details, refer to Section "5-3 Ripple Current Effect on Lifetime" in the catalog, Technical Note.

KY Series

- Newly innovative electrolyte is employed to minimize ESR
- Endurance with ripple current : 6,000 to 10,000 hours at 105°C
- Non solvent resistant type
- RoHS2 Compliant



SPECIFICATIONS

Items	Characteristics										
Category	-40 to +105°C										
Temperature Range	-40 to +105°C										
Rated Voltage Range	6.3 to 100V _{dc}										
Capacitance Tolerance	±20% (M) (at 20°C, 120Hz)										
Leakage Current	I=0.01CV or 3μA, whichever is greater. Where, I : Max. leakage current (μA), C : Nominal capacitance (μF), V : Rated voltage (V) (at 20°C after 2 minutes)										
Dissipation Factor (tan δ)	Rated voltage (V _{dc})	6.3V	10V	16V	25V	35V	50V	63V	80V	100V	
	tan δ (Max.)	0.22	0.19	0.16	0.14	0.12	0.10	0.09	0.09	0.08	
	When nominal capacitance exceeds 1,000μF, add 0.02 to the value above for each 1,000μF increase. (at 20°C, 120Hz)										
Low Temperature Characteristics (Max. Impedance Ratio)	Rated voltage (V _{dc})	6.3V	10V	16V	25V	35V	50V	63V	80V	100V	
	Z(-25°C)/Z(+20°C)	4	3	2	2	2	2	2	2	2	
	Z(-40°C)/Z(+20°C)	8	6	4	3	3	3	3	3	3	
(at 120Hz)											
Endurance	The following specifications shall be satisfied when the capacitors are restored to 20°C after subjected to DC voltage with the rated ripple current is applied (the peak voltage shall not exceed the rated voltage) for the specified period of time at 105°C.										
	Time	6.3 to 10V _{dc}	φ 10 : 6,000hours			φ 12.5 to 18 : 8,000hours					
		16 to 100V _{dc}	φ 10 : 7,000hours			φ 12.5 to 18 : 10,000hours					
	Capacitance change	≤ ±25% of the initial value									
	D.F. (tan δ)	≤ 200% of the initial specified value									
Leakage current	≤ The initial specified value										
Shelf Life	The following specifications shall be satisfied when the capacitors are restored to 20°C after exposing them for 500 hours at 105°C without voltage applied. Before the measurement, the capacitor shall be preconditioned by applying voltage according to Item 4.1 of JIS C 5101-4.										
	Capacitance change	≤ ±25% of the initial value									
	D.F. (tan δ)	≤ 200% of the initial specified value									
	Leakage current	≤ The initial specified value									

DIMENSIONS [mm]

● Terminal Code : E

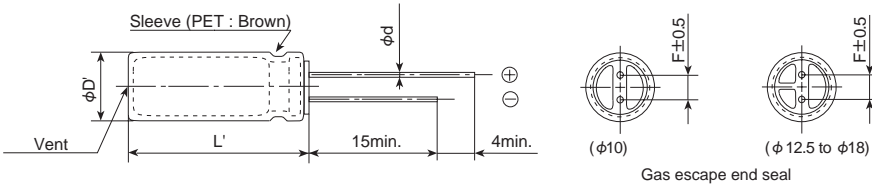

φD	10	12.5	16	18
φd	0.6	0.6	0.8	0.8
F	5.0	5.0	7.5	7.5
φD'	φD+0.5max.			
L'	L+1.5max.			

PART NUMBERING SYSTEM

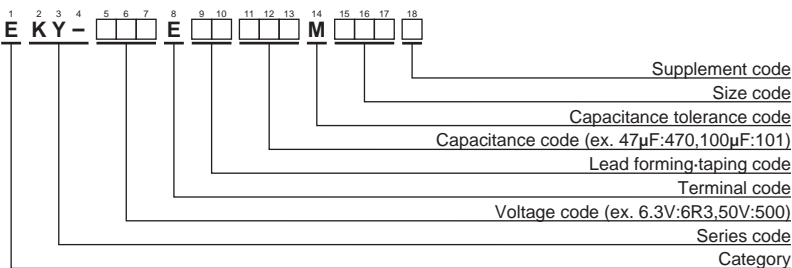

Please refer to "Product code guide (radial lead type)"



◆ STANDARD RATINGS

WV (V _{dc})	Cap (μF)	Case size φD×L(mm)	Impedance (Ω max./100kHz)		Rated ripple current (mA rms/105°C, 100kHz)	Part No.	WV (V _{dc})	Cap (μF)	Case size φD×L(mm)	Impedance (Ω max./100kHz)		Rated ripple current (mA rms/105°C, 100kHz)	Part No.
			20°C	-10°C						20°C	-10°C		
6.3	820	10×12.5	0.080	0.32	865	EKY-6R3E□□821MJCS5	16	8,200	18×35.5	0.014	0.038	4,220	EKY-160E□□822MMP1S
	1,200	10×16	0.060	0.24	1,210	EKY-6R3E□□122MJ16S		10,000	18×40	0.012	0.032	4,280	EKY-160E□□103MM40S
	1,500	10×20	0.046	0.18	1,400	EKY-6R3E□□152MJ20S		330	10×12.5	0.080	0.32	865	EKY-250E□□331MJCS5
	1,800	12.5×15	0.049	0.16	1,450	EKY-6R3E□□182MK15S		470	10×16	0.060	0.24	1,210	EKY-250E□□471MJ16S
	2,200	10×25	0.042	0.17	1,650	EKY-6R3E□□222MJ25S		680	10×20	0.046	0.18	1,400	EKY-250E□□681MJ20S
	2,700	10×30	0.031	0.12	1,910	EKY-6R3E□□272MJ30S		680	12.5×15	0.049	0.16	1,450	EKY-250E□□681MK15S
	2,700	16×15	0.042	0.12	1,940	EKY-6R3E□□272ML15S		820	10×25	0.042	0.17	1,650	EKY-250E□□821MJ25S
	3,300	12.5×20	0.035	0.12	1,900	EKY-6R3E□□332MK20S		1,000	10×30	0.031	0.12	1,910	EKY-250E□□102MJ30S
	3,900	12.5×25	0.027	0.089	2,230	EKY-6R3E□□392MK25S		1,000	12.5×20	0.035	0.12	1,900	EKY-250E□□102MK20S
	3,900	18×15	0.043	0.11	2,210	EKY-6R3E□□392MM15S		1,000	16×15	0.042	0.12	1,940	EKY-250E□□102ML15S
	4,700	12.5×30	0.024	0.078	2,650	EKY-6R3E□□472MK30S		1,200	18×15	0.043	0.11	2,210	EKY-250E□□122MM15S
	5,600	12.5×35	0.020	0.065	2,880	EKY-6R3E□□562MK35S		1,500	12.5×25	0.027	0.089	2,230	EKY-250E□□152MK25S
	5,600	16×20	0.027	0.078	2,530	EKY-6R3E□□562ML20S		1,800	12.5×30	0.024	0.078	2,650	EKY-250E□□182MK30S
	6,800	12.5×40	0.017	0.056	3,350	EKY-6R3E□□682MK40S		1,800	16×20	0.027	0.078	2,530	EKY-250E□□182ML20S
	6,800	16×25	0.021	0.060	2,930	EKY-6R3E□□682ML25S		2,200	12.5×35	0.020	0.065	2,880	EKY-250E□□222MK35S
	6,800	18×20	0.026	0.067	2,860	EKY-6R3E□□682MM20S		2,200	18×20	0.026	0.067	2,860	EKY-250E□□222MM20S
	8,200	16×31.5	0.017	0.050	3,450	EKY-6R3E□□822MLN3S		2,700	12.5×40	0.017	0.056	3,350	EKY-250E□□272MK40S
	10,000	16×35.5	0.015	0.044	3,610	EKY-6R3E□□103MLP1S		2,700	16×25	0.021	0.060	2,930	EKY-250E□□272ML25S
10,000	18×25	0.019	0.049	3,140	EKY-6R3E□□103MM25S	3,300	16×31.5	0.017	0.050	3,450	EKY-250E□□332MLN3S		
12,000	16×40	0.013	0.038	4,080	EKY-6R3E□□123ML40S	3,300	18×25	0.019	0.049	3,140	EKY-250E□□332MM25S		
12,000	18×31.5	0.015	0.040	4,170	EKY-6R3E□□123MMN3S	3,900	16×35.5	0.015	0.044	3,610	EKY-250E□□392MLP1S		
15,000	18×35.5	0.014	0.038	4,220	EKY-6R3E□□153MMP1S	3,900	18×31.5	0.015	0.040	4,170	EKY-250E□□392MMN3S		
18,000	18×40	0.012	0.032	4,280	EKY-6R3E□□183MM40S	4,700	16×40	0.013	0.038	4,080	EKY-250E□□472ML40S		
10	680	10×12.5	0.080	0.32	865	EKY-100E□□681MJCS5	4,700	18×35.5	0.014	0.038	4,220	EKY-250E□□472MMP1S	
	1,000	10×16	0.060	0.24	1,210	EKY-100E□□102MJ16S	5,600	18×40	0.012	0.032	4,280	EKY-250E□□562MM40S	
	1,200	10×20	0.046	0.18	1,400	EKY-100E□□122MJ20S	220	10×12.5	0.080	0.32	865	EKY-350E□□221MJCS5	
	1,500	10×25	0.042	0.17	1,650	EKY-100E□□152MJ25S	330	10×16	0.060	0.24	1,210	EKY-350E□□331MJ16S	
	1,500	12.5×15	0.049	0.16	1,450	EKY-100E□□152MK15S	470	10×20	0.046	0.18	1,400	EKY-350E□□471MJ20S	
	2,200	10×30	0.031	0.12	1,910	EKY-100E□□222MJ30S	470	12.5×15	0.049	0.16	1,450	EKY-350E□□471MK15S	
	2,200	12.5×20	0.035	0.12	1,900	EKY-100E□□222MK20S	560	10×25	0.042	0.17	1,650	EKY-350E□□561MJ25S	
	2,200	16×15	0.042	0.12	1,940	EKY-100E□□222ML15S	680	10×30	0.031	0.12	1,910	EKY-350E□□681MJ30S	
	2,700	18×15	0.043	0.11	2,210	EKY-100E□□272MM15S	680	12.5×20	0.035	0.12	1,900	EKY-350E□□681MK20S	
	3,300	12.5×25	0.027	0.089	2,230	EKY-100E□□332MK25S	680	16×15	0.042	0.12	1,940	EKY-350E□□681ML15S	
	3,900	12.5×30	0.024	0.078	2,650	EKY-100E□□392MK30S	1,000	12.5×25	0.027	0.089	2,230	EKY-350E□□102MK25S	
	3,900	16×20	0.027	0.078	2,530	EKY-100E□□392ML20S	1,000	18×15	0.043	0.11	2,210	EKY-350E□□102MM15S	
	4,700	12.5×35	0.020	0.065	2,880	EKY-100E□□472MK35S	1,200	12.5×30	0.024	0.078	2,650	EKY-350E□□122MK30S	
	5,600	12.5×40	0.017	0.056	3,350	EKY-100E□□562MK40S	1,200	16×20	0.027	0.078	2,530	EKY-350E□□122ML20S	
	5,600	16×25	0.021	0.060	2,930	EKY-100E□□562ML25S	1,500	12.5×35	0.020	0.065	2,880	EKY-350E□□152MK35S	
	5,600	18×20	0.026	0.067	2,860	EKY-100E□□562MM20S	1,800	12.5×40	0.017	0.056	3,350	EKY-350E□□182MK40S	
	6,800	16×31.5	0.017	0.050	3,450	EKY-100E□□682MLN3S	1,800	16×25	0.021	0.060	2,930	EKY-350E□□182ML25S	
	6,800	18×25	0.019	0.049	3,140	EKY-100E□□682MM25S	1,800	18×20	0.026	0.067	2,860	EKY-350E□□182MM20S	
8,200	16×35.5	0.015	0.044	3,610	EKY-100E□□822MLP1S	2,200	16×31.5	0.017	0.050	3,450	EKY-350E□□222MLN3S		
8,200	18×31.5	0.015	0.040	4,170	EKY-100E□□822MMN3S	2,200	18×25	0.019	0.049	3,140	EKY-350E□□222MM25S		
10,000	16×40	0.013	0.038	4,080	EKY-100E□□103ML40S	2,700	16×35.5	0.015	0.044	3,610	EKY-350E□□272MLP1S		
10,000	18×35.5	0.014	0.038	4,220	EKY-100E□□103MMP1S	2,700	18×31.5	0.015	0.040	4,170	EKY-350E□□272MMN3S		
12,000	18×40	0.012	0.032	4,280	EKY-100E□□123MM40S	3,300	16×40	0.013	0.038	4,080	EKY-350E□□332ML40S		
16	470	10×12.5	0.080	0.32	865	EKY-160E□□471MJCS5	3,300	18×35.5	0.014	0.038	4,220	EKY-350E□□332MMP1S	
	680	10×16	0.060	0.24	1,210	EKY-160E□□681MJ16S	3,900	18×40	0.012	0.032	4,280	EKY-350E□□392MM40S	
	1,000	10×20	0.046	0.18	1,400	EKY-160E□□102MJ20S	150	10×12.5	0.12	0.48	760	EKY-500E□□151MJCS5	
	1,000	12.5×15	0.049	0.16	1,450	EKY-160E□□102MK15S	220	10×16	0.084	0.34	1,050	EKY-500E□□221MJ16S	
	1,200	10×25	0.042	0.17	1,650	EKY-160E□□122MJ25S	270	10×20	0.060	0.24	1,220	EKY-500E□□271MJ20S	
	1,500	10×30	0.031	0.12	1,910	EKY-160E□□152MJ30S	270	12.5×15	0.061	0.20	1,260	EKY-500E□□271MK15S	
	1,500	12.5×20	0.035	0.12	1,900	EKY-160E□□152MK20S	330	10×25	0.055	0.22	1,440	EKY-500E□□331MJ25S	
	1,500	16×15	0.042	0.12	1,940	EKY-160E□□152ML15S	470	10×30	0.043	0.17	1,690	EKY-500E□□471MJ30S	
	2,200	12.5×25	0.027	0.089	2,230	EKY-160E□□222MK25S	470	12.5×20	0.045	0.15	1,660	EKY-500E□□471MK20S	
	2,200	18×15	0.043	0.11	2,210	EKY-160E□□222MM15S	470	16×15	0.055	0.17	1,690	EKY-500E□□471ML15S	
	2,700	12.5×30	0.024	0.078	2,650	EKY-160E□□272MK30S	560	12.5×25	0.034	0.11	1,950	EKY-500E□□561MK25S	
	2,700	16×20	0.027	0.078	2,530	EKY-160E□□272ML20S	560	18×15	0.054	0.15	1,930	EKY-500E□□561MM15S	
	3,300	12.5×35	0.020	0.065	2,880	EKY-160E□□332MK35S	680	12.5×30	0.030	0.10	2,310	EKY-500E□□681MK30S	
	3,900	12.5×40	0.017	0.056	3,350	EKY-160E□□392MK40S	820	12.5×35	0.025	0.083	2,510	EKY-500E□□821MK35S	
	3,900	16×25	0.021	0.060	2,930	EKY-160E□□392ML25S	820	16×20	0.034	0.10	2,210	EKY-500E□□821ML20S	
	3,900	18×20	0.026	0.067	2,860	EKY-160E□□392MM20S	1,000	12.5×40	0.021	0.069	2,920	EKY-500E□□102MK40S	
	4,700	16×31.5	0.017	0.050	3,450	EKY-160E□□472MLN3S	1,000	16×25	0.025	0.075	2,555	EKY-500E□□102ML25S	
	4,700	18×25	0.019	0.049	3,140	EKY-160E□□472MM25S	1,000	18×20	0.036	0.097	2,490	EKY-500E□□102MM20S	
5,600	16×35.5	0.015	0.044	3,610	EKY-160E□□562MLP1S	1,200	16×31.5	0.022	0.066	3,010	EKY-500E□□122MLN3S		
5,600	18×31.5	0.015	0.040	4,170	EKY-160E□□562MMN3S	1,200	18×25	0.026	0.070	2,740	EKY-500E□□122MM25S		
6,800	16×40	0.013	0.038	4,080	EKY-160E□□682ML40S	1,500	16×35.5	0.019	0.057	3,150	EKY-500E□□152MLP1S		

□□ : Enter the appropriate lead forming or taping code.



◆STANDARD RATINGS

WV (V _{dc})	Cap (μF)	Case size φD×L(mm)	Impedance (Ω max./100kHz)		Rated ripple current (mA _{rms} /105°C, 100kHz)	Part No.	WV (V _{dc})	Cap (μF)	Case size φD×L(mm)	Impedance (Ω max./100kHz)		Rated ripple current (mA _{rms} /105°C, 100kHz)	Part No.	
			20°C	-10°C						20°C	-10°C			
50	1,800	16×40	0.016	0.048	3,710	EKY-500E□□182ML40S	80	390	12.5×30	0.042	0.13	1,500	EKY-800E□□391MK30S	
	1,800	18×31.5	0.021	0.057	3,635	EKY-500E□□182MMN3S		470	12.5×35	0.036	0.11	1,650	EKY-800E□□471MK35S	
	2,200	18×35.5	0.017	0.046	3,680	EKY-500E□□222MMP1S		470	16×25	0.038	0.12	1,700	EKY-800E□□471ML25S	
	2,700	18×40	0.014	0.038	3,800	EKY-500E□□272MM40S		470	18×20	0.045	0.14	1,500	EKY-800E□□471MM20S	
								560	12.5×40	0.032	0.095	1,800	EKY-800E□□561MK40S	
63	82	10×12.5	0.11	0.44	690	EKY-630E□□820MJC5S		680	16×31.5	0.032	0.095	1,850	EKY-800E□□681MLN3S	
	120	10×16	0.076	0.31	950	EKY-630E□□121MJ16S		680	18×25	0.036	0.11	1,750	EKY-800E□□681MM25S	
	180	10×20	0.056	0.23	1,150	EKY-630E□□181MJ20S		820	16×35.5	0.029	0.086	2,000	EKY-800E□□821MLP1S	
	180	12.5×16	0.072	0.29	1,150	EKY-630E□□181MK16S		820	18×31.5	0.030	0.090	1,900	EKY-800E□□821MMN3S	
	220	10×25	0.046	0.19	1,350	EKY-630E□□221MJ25S		1,000	16×40	0.027	0.081	2,200	EKY-800E□□102ML40S	
	270	12.5×20	0.041	0.13	1,500	EKY-630E□□271MK20S		1,000	18×35.5	0.027	0.081	2,200	EKY-800E□□102MMP1S	
	390	12.5×25	0.031	0.093	1,900	EKY-630E□□391MK25S		1,200	18×40	0.026	0.077	2,700	EKY-800E□□122MM40S	
	470	12.5×30	0.028	0.084	2,300	EKY-630E□□471MK30S		100	47	10×12.5	0.17	0.66	480	EKY-101E□□470MJC5S
	470	16×20	0.032	0.096	2,000	EKY-630E□□471ML20S			68	10×16	0.11	0.47	600	EKY-101E□□680MJ16S
	560	12.5×35	0.024	0.072	2,500	EKY-630E□□561MK35S			82	10×20	0.084	0.34	800	EKY-101E□□820MJ20S
	680	12.5×40	0.021	0.063	2,800	EKY-630E□□681MK40S	100		12.5×16	0.11	0.34	750	EKY-101E□□101MK16S	
	680	16×25	0.025	0.075	2,600	EKY-630E□□681ML25S	120		10×25	0.069	0.28	900	EKY-101E□□121MJ25S	
	680	18×20	0.030	0.090	2,500	EKY-630E□□681MM20S	150		12.5×20	0.062	0.18	1,100	EKY-101E□□151MK20S	
	820	16×31.5	0.021	0.063	2,850	EKY-630E□□821MLN3S	220		12.5×25	0.047	0.14	1,250	EKY-101E□□221MK25S	
	820	18×25	0.024	0.072	2,800	EKY-630E□□821MM25S	220		16×20	0.048	0.15	1,350	EKY-101E□□221ML20S	
1,000	16×35.5	0.019	0.057	2,900	EKY-630E□□102MLP1S	270	12.5×30		0.042	0.13	1,500	EKY-101E□□271MK30S		
1,200	16×40	0.018	0.054	3,400	EKY-630E□□122ML40S	330	12.5×35		0.036	0.11	1,650	EKY-101E□□331MK35S		
1,200	18×31.5	0.020	0.060	3,300	EKY-630E□□122MMN3S	330	16×25		0.038	0.12	1,700	EKY-101E□□331ML25S		
1,500	18×35.5	0.018	0.054	3,400	EKY-630E□□152MMP1S	330	18×20		0.045	0.14	1,500	EKY-101E□□331MM20S		
1,800	18×40	0.017	0.051	3,500	EKY-630E□□182MM40S	390	12.5×40		0.032	0.095	1,800	EKY-101E□□391MK40S		
80	68	10×12.5	0.17	0.66	480	EKY-800E□□680MJC5S	470		16×31.5	0.032	0.095	1,850	EKY-101E□□471MLN3S	
	100	10×16	0.11	0.47	600	EKY-800E□□101MJ16S	470		18×25	0.036	0.11	1,750	EKY-101E□□471MM25S	
	120	10×20	0.084	0.34	800	EKY-800E□□121MJ20S	560	16×35.5	0.029	0.086	2,000	EKY-101E□□561MLP1S		
	150	10×25	0.069	0.28	900	EKY-800E□□151MJ25S	560	18×31.5	0.030	0.090	1,900	EKY-101E□□561MMN3S		
	150	12.5×16	0.11	0.34	750	EKY-800E□□151MK16S	680	16×40	0.027	0.081	2,200	EKY-101E□□681ML40S		
	220	12.5×20	0.062	0.18	1,100	EKY-800E□□221MK20S	680	18×35.5	0.027	0.081	2,200	EKY-101E□□681MMP1S		
	330	12.5×25	0.047	0.14	1,250	EKY-800E□□331MK25S	820	18×40	0.026	0.077	2,700	EKY-101E□□821MM40S		
	330	16×20	0.048	0.15	1,350	EKY-800E□□331ML20S								

□□ : Enter the appropriate lead forming or taping code.

◆RATED RIPPLE CURRENT MULTIPLIERS

●Frequency Multipliers

Capacitance(μF)	Frequency(Hz)			
	120	1k	10k	100k
47 to 180	0.40	0.75	0.90	1.00
220 to 560	0.50	0.85	0.94	1.00
680 to 1,800	0.60	0.87	0.95	1.00
2,200 to 3,900	0.75	0.90	0.95	1.00
4,700 to	0.85	0.95	0.98	1.00

The deterioration of aluminum electrolytic capacitors accelerates their life due to the internal heating produced by ripple current. For details, refer to Section "5-3 Ripple Current Effect on Lifetime" in the catalog, Technical Note.

LZA Series

- Adoption of innovative electrolyte and new technologies
- Very low impedance at high frequency
- Endurance with ripple current: 4,000 to 7,000 hours at 105°C
- Solvent resistant type (see PRECAUTIONS AND GUIDELINES)
- RoHS2 Compliant
- AEC-Q200 compliant : Please contact Chemi-Con for more details, test data, information.

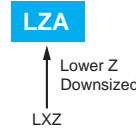

SPECIFICATIONS

Items	Characteristics					
Category	-55 to +105°C					
Temperature Range	-55 to +105°C					
Rated Voltage Range	6.3 to 35V _{dc}					
Capacitance Tolerance	±20% (M) (at 20°C, 120Hz)					
Leakage Current	I=0.01CV or 3μA, whichever is greater. (at 20°C after 2 minutes) Where, I : Max. leakage current (μA), C : Nominal capacitance (μF), V : Rated voltage (V)					
Dissipation Factor (tan δ)	Rated voltage (V _{dc})	6.3V	10V	16V	25V	35V
	tan δ (Max.)	0.22	0.19	0.16	0.14	0.12
	When nominal capacitance exceeds 1,000μF, add 0.02 to the value above for each 1,000μF increase. (at 20°C, 120Hz)					
Low Temperature Characteristics (Max. Impedance Ratio)	Rated voltage (V _{dc})	6.3V	10V	16V	25V	35V
	Z(-55°C)/Z(+20°C)	4	3	3	3	3
Endurance	The following specifications shall be satisfied when the capacitors are restored to 20°C after subjected to DC voltage with the rated ripple current is applied (the peak voltage shall not exceed the rated voltage) for the specified period of time at 105°C.					
	Time	φ 10 : 4,000hours		φ 12.5 : 5,000hours		φ 16 to φ 18 : 7,000hours
	Rated voltage	6.3 to 10V _{dc} (φ 10)		6.3 to 10V _{dc} (φ 12.5 to φ 18)		16 to 35V _{dc}
	Capacitance change	≤ ±30% of the initial value		≤ ±20% of the initial value		≤ ±20% of the initial value
	D.F.(tan δ)	≤300% of the initial specified value		≤200% of the initial specified value		≤200% of the initial specified value
	Leakage current	≤The initial specified value		≤The initial specified value		≤The initial specified value
	Shelf Life	The following specifications shall be satisfied when the capacitors are restored to 20°C after exposing them for 1,000 hours at 105°C without voltage applied. Before the measurement, the capacitor shall be preconditioned by applying voltage according to Item 4.1 of JIS C 5101-4.				
Rated voltage		6.3 to 10V _{dc} (φ 10)		6.3 to 10V _{dc} (φ 12.5 to φ 18)		16 to 35V _{dc}
Capacitance change		≤ ±30% of the initial value		≤ ±20% of the initial value		≤ ±20% of the initial value
D.F.(tan δ)		≤300% of the initial specified value		≤200% of the initial specified value		≤200% of the initial specified value
Leakage current		≤The initial specified value		≤The initial specified value		≤The initial specified value

DIMENSIONS [mm]

● Terminal Code : E

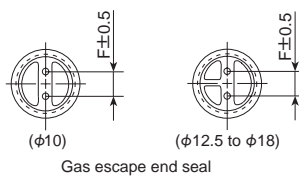
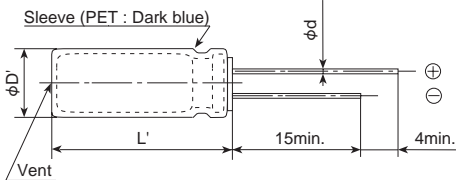

φD	10	12.5	16	18
φd	0.6	0.6	0.8	0.8
F	5.0	5.0	7.5	7.5
φD'	φD+0.5max.			
L'	L+1.5max.			

PART NUMBERING SYSTEM

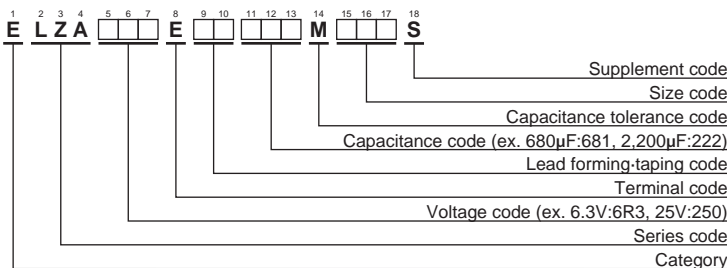

Please refer to "Product code guide (radial lead type)"



LZA Series

◆ STANDARD RATINGS

WV (V _{dc})	Cap (μF)	Case size φD×L(mm)	Impedance (Ω max./20°C, 100kHz)	Rated ripple current (mA _{rms} /105°C, 100kHz)	Part No.	WV (V _{dc})	Cap (μF)	Case size φD×L(mm)	Impedance (Ω max./20°C, 100kHz)	Rated ripple current (mA _{rms} /105°C, 100kHz)	Part No.	
6.3	1,500	10 × 12.5	0.063	960	ELZA6R3E□□152MJC5S	16	3,300	12.5 × 25	0.022	2,350	ELZA160E□□332MK25S	
	1,800	10 × 16	0.049	1,240	ELZA6R3E□□182MJ16S		3,900	16 × 20	0.026	2,330	ELZA160E□□392ML20S	
	2,700	10 × 20	0.035	1,550	ELZA6R3E□□272MJ20S		5,600	16 × 25	0.019	2,760	ELZA160E□□562ML25S	
	3,300	10 × 25	0.033	1,740	ELZA6R3E□□332MJ25S		5,600	18 × 20	0.025	2,640	ELZA160E□□562MM20S	
	4,700	12.5 × 20	0.029	1,890	ELZA6R3E□□472MK20S		8,200	18 × 25	0.018	2,850	ELZA160E□□822MM25S	
	6,800	12.5 × 25	0.022	2,350	ELZA6R3E□□682MK25S		25	470	10 × 12.5	0.063	960	ELZA250E□□471MJC5S
	6,800	16 × 20	0.026	2,330	ELZA6R3E□□682ML20S			680	10 × 16	0.049	1,240	ELZA250E□□681MJ16S
	8,200	18 × 20	0.025	2,640	ELZA6R3E□□822MM20S			1,000	10 × 20	0.035	1,550	ELZA250E□□102MJ20S
	10,000	16 × 25	0.019	2,760	ELZA6R3E□□103ML25S			1,200	10 × 25	0.033	1,740	ELZA250E□□122MJ25S
	12,000	18 × 25	0.018	2,850	ELZA6R3E□□123MM25S			1,500	12.5 × 20	0.029	1,890	ELZA250E□□152MK20S
10	1,000	10 × 12.5	0.063	960	ELZA100E□□102MJC5S	2,200		12.5 × 25	0.022	2,350	ELZA250E□□222MK25S	
	1,500	10 × 16	0.049	1,240	ELZA100E□□152MJ16S	2,700		16 × 20	0.026	2,330	ELZA250E□□272ML20S	
	2,200	10 × 20	0.035	1,550	ELZA100E□□222MJ20S	3,300		18 × 20	0.025	2,640	ELZA250E□□332MM20S	
	2,700	10 × 25	0.033	1,740	ELZA100E□□272MJ25S	3,900		16 × 25	0.019	2,760	ELZA250E□□392ML25S	
	3,300	12.5 × 20	0.029	1,890	ELZA100E□□332MK20S	4,700		18 × 25	0.018	2,850	ELZA250E□□472MM25S	
	4,700	12.5 × 25	0.022	2,350	ELZA100E□□472MK25S	35	330	10 × 12.5	0.063	960	ELZA350E□□331MJC5S	
	4,700	16 × 20	0.026	2,330	ELZA100E□□472ML20S		470	10 × 16	0.049	1,240	ELZA350E□□471MJ16S	
	6,800	16 × 25	0.019	2,760	ELZA100E□□682ML25S		680	10 × 20	0.035	1,550	ELZA350E□□681MJ20S	
	6,800	18 × 20	0.025	2,640	ELZA100E□□682MM20S		820	10 × 25	0.033	1,740	ELZA350E□□821MJ25S	
	8,200	18 × 25	0.018	2,850	ELZA100E□□822MM25S		1,000	12.5 × 20	0.029	1,890	ELZA350E□□102MK20S	
16	820	10 × 12.5	0.063	960	ELZA100E□□821MJC5S		1,500	12.5 × 25	0.022	2,350	ELZA350E□□152MK25S	
	1,000	10 × 16	0.049	1,240	ELZA160E□□102MJ16S		1,800	16 × 20	0.026	2,330	ELZA350E□□182ML20S	
	1,500	10 × 20	0.035	1,550	ELZA160E□□152MJ20S		2,200	18 × 20	0.025	2,640	ELZA350E□□222MM20S	
	1,800	10 × 25	0.033	1,740	ELZA160E□□182MJ25S		2,700	16 × 25	0.019	2,760	ELZA350E□□272ML25S	
	2,200	12.5 × 20	0.029	1,890	ELZA160E□□222MK20S		3,300	18 × 25	0.018	2,850	ELZA350E□□332MM25S	

□ □ : Enter the appropriate lead forming or taping code.

◆ RATED RIPPLE CURRENT MULTIPLIERS

● Frequency Multipliers

Capacitance(μF)	Frequency(Hz)			
	120	1k	10k	100k
330 to 470	0.50	0.85	0.94	1.00
680 to 1,800	0.60	0.87	0.95	1.00
2,200 to 3,900	0.75	0.90	0.95	1.00
4,700 to 12,000	0.85	0.95	0.98	1.00

The deterioration of aluminum electrolytic capacitors accelerates their life due to the internal heating produced by ripple current. For details, refer to Section "5-3 Ripple Current Effect on Lifetime" in the catalog, Technical Note.

LXZ Upgrade! Series

- Adoption of innovative electrolyte and new technologies
- Very low impedance at high frequency
- Endurance with ripple current: 2,000 to 8,000 hours at 105°C
- Solvent resistant type (see PRECAUTIONS AND GUIDELINES)
- RoHS2 Compliant
- AEC-Q200 compliant : Please contact Chemi-Con for more details, test data, information.

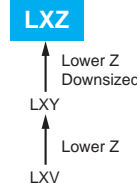

◆ SPECIFICATIONS

Items	Characteristics
Category	-55 to +105°C
Temperature Range	
Rated Voltage Range	6.3 to 63V _{dc}
Capacitance Tolerance	±20% (M) (at 20°C, 120Hz)
Leakage Current	I=0.01CV or 3μA, whichever is greater. Where, I : Max. leakage current (μA), C : Nominal capacitance (μF), V : Rated voltage (V) (at 20°C after 2 minutes)
Dissipation Factor (tan δ)	Rated voltage (V _{dc})
	tan δ (Max.)
Endurance	When nominal capacitance exceeds 1,000μF, add 0.02 to the value above for each 1,000μF increase. (at 20°C, 120Hz)
	The following specifications shall be satisfied when the capacitors are restored to 20°C after subjected to DC voltage with the rated ripple current is applied (the peak voltage shall not exceed the rated voltage) for the specified period of time at 105°C.
	Time
	Capacitance change
Shelf Life	The following specifications shall be satisfied when the capacitors are restored to 20°C after exposing them for 1,000 hours at 105°C without voltage applied. Before the measurement, the capacitor shall be preconditioned by applying voltage according to Item 4.1 of JIS C 5101-4.
	Capacitance change
	D.F. (tan δ)

◆ DIMENSIONS [mm]

● Terminal Code : E

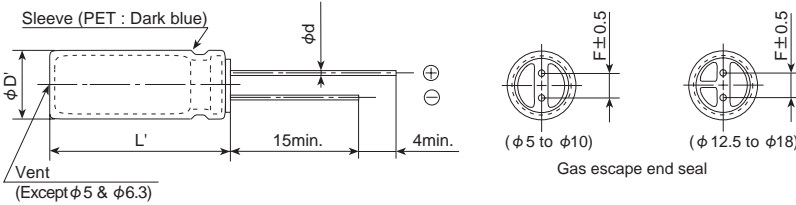

◆ PART NUMBERING SYSTEM

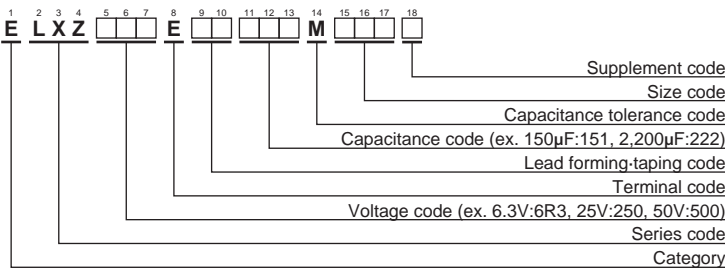

Please refer to "Product code guide (radial lead type)"



STANDARD RATINGS

WV (Vdc)	Cap (µF)	Case size ϕD×L(mm)	Impedance (Ω max./100kHz)		Rated ripple current (mA rms/105°C, 100kHz)	Part No.	WV (Vdc)	Cap (µF)	Case size ϕD×L(mm)	Impedance (Ω max./100kHz)		Rated ripple current (mA rms/105°C, 100kHz)	Part No.
			20°C	-10°C						20°C	-10°C		
6.3	150	5×11.5	0.50	1.0	175	ELXZ6R3E□□151MEB5D	16	2,700	16×20	0.029	0.058	2,210	ELXZ160E□□272ML20S
	330	6.3×11.5	0.25	0.50	290	ELXZ6R3E□□331MFB5D		3,300	12.5×35	0.022	0.044	2,510	ELXZ160E□□332MK35S
	470	6.3×15	0.18	0.36	400	ELXZ6R3E□□471MF15D		3,900	12.5×40	0.017	0.034	2,870	ELXZ160E□□392MK40S
	680	8×12	0.12	0.24	555	ELXZ6R3E□□681MH12D		3,900	16×25	0.022	0.044	2,560	ELXZ160E□□392ML25S
	820	10×12.5	0.090	0.18	760	ELXZ6R3E□□821MJC5S		3,900	18×20	0.028	0.056	2,490	ELXZ160E□□392MM20S
	1,000	8×15	0.090	0.18	730	ELXZ6R3E□□102MH15D		4,700	16×30	0.019	0.038	3,010	ELXZ160E□□472ML30S
	1,200	8×20	0.080	0.16	810	ELXZ6R3E□□122MH20D		4,700	18×25	0.020	0.040	2,740	ELXZ160E□□472MM25S
	1,200	10×16	0.068	0.136	1,050	ELXZ6R3E□□122MJ16S		5,600	16×35	0.017	0.034	3,150	ELXZ160E□□562ML35S
	1,500	10×20	0.052	0.104	1,220	ELXZ6R3E□□152MJ20S		5,600	18×30	0.018	0.036	3,330	ELXZ160E□□562MM30S
	2,200	10×25	0.045	0.090	1,440	ELXZ6R3E□□222MJ25S		6,800	16×40	0.015	0.030	3,710	ELXZ160E□□682ML40S
	2,700	10×30	0.037	0.074	1,690	ELXZ6R3E□□272MJ30S		8,200	18×35	0.016	0.032	3,680	ELXZ160E□□822MM35S
	3,300	12.5×20	0.038	0.076	1,660	ELXZ6R3E□□332MK20S		10,000	18×40	0.015	0.030	3,800	ELXZ160E□□103MM40S
	3,900	12.5×25	0.030	0.060	1,950	ELXZ6R3E□□392MK25S		47	5×11.5	0.50	1.0	175	ELXZ250E□□470MEB5D
	4,700	12.5×30	0.025	0.050	2,310	ELXZ6R3E□□472MK30S		100	6.3×11.5	0.25	0.50	290	ELXZ250E□□101MFB5D
	5,600	12.5×35	0.022	0.044	2,510	ELXZ6R3E□□562MK35S		150	6.3×15	0.18	0.36	400	ELXZ250E□□151MF15D
	5,600	16×20	0.029	0.058	2,210	ELXZ6R3E□□562ML20S		220	8×12	0.12	0.24	555	ELXZ250E□□221MH12D
	6,800	12.5×40	0.017	0.034	2,870	ELXZ6R3E□□682MK40S		330	8×15	0.090	0.18	730	ELXZ250E□□331MH15D
	6,800	16×25	0.022	0.044	2,560	ELXZ6R3E□□682ML25S		330	10×12.5	0.090	0.18	760	ELXZ250E□□331MJC5S
	6,800	18×20	0.028	0.056	2,490	ELXZ6R3E□□682MM20S		390	8×20	0.080	0.16	810	ELXZ250E□□391MH20D
	8,200	16×30	0.019	0.038	3,010	ELXZ6R3E□□822ML30S		470	10×16	0.068	0.136	1,050	ELXZ250E□□471MJ16S
10,000	16×35	0.017	0.034	3,150	ELXZ6R3E□□103ML35S	680	10×20	0.052	0.104	1,220	ELXZ250E□□681MJ20S		
10,000	18×25	0.020	0.040	2,740	ELXZ6R3E□□103MM25S	820	10×25	0.045	0.090	1,440	ELXZ250E□□821MJ25S		
12,000	16×40	0.015	0.030	3,710	ELXZ6R3E□□123ML40S	1,000	10×30	0.037	0.074	1,690	ELXZ250E□□102MJ30S		
12,000	18×30	0.018	0.036	3,330	ELXZ6R3E□□123MM30S	1,000	12.5×20	0.038	0.076	1,660	ELXZ250E□□102MK20S		
15,000	18×35	0.016	0.032	3,680	ELXZ6R3E□□153MM35S	1,500	12.5×25	0.030	0.060	1,950	ELXZ250E□□152MK25S		
18,000	18×40	0.015	0.030	3,800	ELXZ6R3E□□183MM40S	1,800	12.5×30	0.025	0.050	2,310	ELXZ250E□□182MK30S		
10	100	5×11.5	0.50	1.0	175	ELXZ100E□□101MEB5D	25	1,800	16×20	0.029	0.058	2,210	ELXZ250E□□182ML20S
	220	6.3×11.5	0.25	0.50	290	ELXZ100E□□221MFB5D		2,200	12.5×30	0.025	0.050	2,310	ELXZ250E□□222MK30S
	330	6.3×15	0.18	0.36	400	ELXZ100E□□331MF15D		2,200	12.5×35	0.022	0.044	2,510	ELXZ250E□□222MK35S
	470	8×12	0.12	0.24	555	ELXZ100E□□471MH12D		2,200	18×20	0.028	0.056	2,490	ELXZ250E□□222MM20S
	680	8×15	0.090	0.18	730	ELXZ100E□□681MH15D		2,700	12.5×40	0.017	0.034	2,870	ELXZ250E□□272MK40S
	680	10×12.5	0.090	0.18	760	ELXZ100E□□681MJC5S		2,700	16×25	0.022	0.044	2,560	ELXZ250E□□272ML25S
	1,000	8×20	0.080	0.16	810	ELXZ100E□□102MH20D		3,300	16×25	0.022	0.044	2,560	ELXZ250E□□332ML25S
	1,000	10×16	0.068	0.136	1,050	ELXZ100E□□102MJ16S		3,300	16×30	0.019	0.038	3,010	ELXZ250E□□332ML30S
	1,200	10×20	0.052	0.104	1,220	ELXZ100E□□122MJ20S		3,300	18×20	0.028	0.056	2,490	ELXZ250E□□332MM20S
	1,500	10×25	0.045	0.090	1,440	ELXZ100E□□152MJ25S		3,300	18×25	0.020	0.040	2,740	ELXZ250E□□332MM25S
	1,800	10×30	0.037	0.074	1,690	ELXZ100E□□182MJ30S		3,900	16×35	0.017	0.034	3,150	ELXZ250E□□392ML35S
	2,200	10×30	0.037	0.074	1,690	ELXZ100E□□222MJ30S		3,900	18×30	0.018	0.036	3,330	ELXZ250E□□392MM30S
	2,200	12.5×20	0.038	0.076	1,660	ELXZ100E□□222MK20S		4,700	16×40	0.015	0.030	3,710	ELXZ250E□□472ML40S
	3,300	12.5×25	0.030	0.060	1,950	ELXZ100E□□332MK25S		4,700	18×35	0.016	0.032	3,680	ELXZ250E□□472MM35S
	3,900	12.5×30	0.025	0.050	2,310	ELXZ100E□□392MK30S		5,600	18×40	0.015	0.030	3,800	ELXZ250E□□562MM40S
	3,900	16×20	0.029	0.058	2,210	ELXZ100E□□392ML20S		33	5×11.5	0.50	1.0	175	ELXZ350E□□330MEB5D
4,700	12.5×35	0.022	0.044	2,510	ELXZ100E□□472MK35S	56	6.3×11.5	0.25	0.50	290	ELXZ350E□□560MFB5D		
5,600	12.5×40	0.017	0.034	2,870	ELXZ100E□□562MK40S	100	6.3×15	0.18	0.36	400	ELXZ350E□□101MF15D		
5,600	16×25	0.022	0.044	2,560	ELXZ100E□□562ML25S	150	8×12	0.12	0.24	555	ELXZ350E□□151MH12D		
5,600	18×20	0.028	0.056	2,490	ELXZ100E□□562MM20S	220	8×15	0.090	0.18	730	ELXZ350E□□221MH15D		
6,800	16×30	0.019	0.038	3,010	ELXZ100E□□682ML30S	220	10×12.5	0.090	0.18	760	ELXZ350E□□221MJC5S		
6,800	18×25	0.020	0.040	2,740	ELXZ100E□□682MM25S	270	8×20	0.080	0.16	810	ELXZ350E□□271MH20D		
8,200	16×35	0.017	0.034	3,150	ELXZ100E□□822ML35S	330	10×16	0.068	0.136	1,050	ELXZ350E□□331MJ16S		
8,200	18×30	0.018	0.036	3,330	ELXZ100E□□822MM30S	470	10×20	0.052	0.104	1,220	ELXZ350E□□471MJ20S		
10,000	16×40	0.015	0.030	3,710	ELXZ100E□□103ML40S	560	10×20	0.052	0.104	1,220	ELXZ350E□□561MJ20S		
10,000	18×35	0.016	0.032	3,680	ELXZ100E□□103MM35S	560	10×25	0.045	0.090	1,440	ELXZ350E□□561MJ25S		
12,000	18×40	0.015	0.030	3,800	ELXZ100E□□123MM40S	680	10×30	0.037	0.074	1,690	ELXZ350E□□681MJ30S		
16	47	5×11.5	0.50	1.0	175	ELXZ160E□□470MEB5D	35	680	12.5×20	0.038	0.076	1,660	ELXZ350E□□681MK20S
	100	6.3×11.5	0.25	0.50	290	ELXZ160E□□101MFB5D		1,000	12.5×20	0.038	0.076	1,660	ELXZ350E□□102MK20S
	220	6.3×15	0.18	0.36	400	ELXZ160E□□221MF15D		1,000	12.5×25	0.030	0.060	1,950	ELXZ350E□□102MK25S
	330	8×12	0.12	0.24	555	ELXZ160E□□331MH12D		1,200	12.5×30	0.025	0.050	2,310	ELXZ350E□□122MK30S
	470	8×15	0.090	0.18	730	ELXZ160E□□471MH15D		1,200	16×20	0.029	0.058	2,210	ELXZ350E□□122ML20S
	470	10×12.5	0.090	0.18	760	ELXZ160E□□471MJC5S		1,500	12.5×35	0.022	0.044	2,510	ELXZ350E□□152MK35S
	560	8×20	0.080	0.16	810	ELXZ160E□□561MH20D		1,800	12.5×40	0.017	0.034	2,870	ELXZ350E□□182MK40S
	680	10×16	0.068	0.136	1,050	ELXZ160E□□681MJ16S		1,800	16×25	0.022	0.044	2,560	ELXZ350E□□182ML25S
	1,000	10×20	0.052	0.104	1,220	ELXZ160E□□102MJ20S		1,800	18×20	0.028	0.056	2,490	ELXZ350E□□182MM20S
	1,200	10×25	0.045	0.090	1,440	ELXZ160E□□122MJ25S		2,200	16×25	0.022	0.044	2,560	ELXZ350E□□222ML25S
	1,500	10×30	0.037	0.074	1,690	ELXZ160E□□152MJ30S		2,200	16×30	0.019	0.038	3,010	ELXZ350E□□222ML30S
	1,500	12.5×20	0.038	0.076	1,660	ELXZ160E□□152MK20S		2,200	18×20	0.028	0.056	2,490	ELXZ350E□□222MM20S
	2,200	12.5×25	0.030	0.060	1,950	ELXZ160E□□222MK25S		2,200	18×25	0.020	0.040	2,740	ELXZ350E□□222MM25S
	2,700	12.5×30	0.025	0.050	2,310	ELXZ160E□□272MK30S		2,700	16×35	0.017	0.034	3,150	ELXZ350E□□272ML35S

□□ : Enter the appropriate lead forming or taping code.

Production of the products shown in [] is scheduled to be discontinued.

Product specifications in this catalog are subject to change without notice. Request our product specifications before purchase and/or use. Please use our products based on the information contained in this catalog and product specifications.



◆STANDARD RATINGS

VV (V _{dc})	Cap (μF)	Case size φD×L(mm)	Impedance (Ω max./100kHz)		Rated ripple current (mA _{rms} /105°C, 100kHz)	Part No.	VV (V _{dc})	Cap (μF)	Case size φD×L(mm)	Impedance (Ω max./100kHz)		Rated ripple current (mA _{rms} /105°C, 100kHz)	Part No.
			20°C	-10°C						20°C	-10°C		
35	2,700	18×30	0.018	0.036	3,330	ELXZ350E□□272MM30S	50	2,700	18×40	0.020	0.040	3,400	ELXZ500E□□272MM40S
	3,300	16×40	0.015	0.030	3,710	ELXZ350E□□332ML40S		12	5×11.5	1.9	4.0	145	ELXZ630E□□120MEB5D
	3,300	18×35	0.016	0.032	3,680	ELXZ350E□□332MM35S		22	6.3×11.5	1.0	2.0	240	ELXZ630E□□220MFB5D
	3,900	18×40	0.015	0.030	3,800	ELXZ350E□□392MM40S		39	6.3×15	0.61	1.4	330	ELXZ630E□□390MF15D
	4,700	18×40	0.015	0.030	3,800	ELXZ350E□□472MM40S		68	8×12	0.34	0.75	405	ELXZ630E□□680MH12D
50	22	5×11.5	0.90	1.8	155	ELXZ500E□□220MEB5D	100	8×15	0.27	0.65	535	ELXZ630E□□101MH15D	
	47	6.3×11.5	0.45	0.90	260	ELXZ500E□□470MFB5D	100	10×12.5	0.255	0.51	540	ELXZ630E□□101MJC5S	
	68	6.3×15	0.31	0.62	360	ELXZ500E□□680MF15D	120	10×16	0.19	0.38	600	ELXZ630E□□121MJ16S	
	100	8×12	0.22	0.44	485	ELXZ500E□□101MH12D	150	8×20	0.21	0.52	690	ELXZ630E□□151MH20D	
	120	8×15	0.16	0.32	635	ELXZ500E□□121MH15D	180	10×20	0.145	0.29	890	ELXZ630E□□181MJ20S	
	120	10×12.5	0.16	0.32	620	ELXZ500E□□121MJC5S	220	10×25	0.13	0.26	1,050	ELXZ630E□□221MJ25S	
	180	8×20	0.12	0.24	730	ELXZ500E□□181MH20D	330	10×30	0.090	0.18	1,300	ELXZ630E□□331MJ30S	
	180	10×16	0.13	0.26	850	ELXZ500E□□181MJ16S	330	12.5×20	0.085	0.17	1,290	ELXZ630E□□331MK20S	
	220	10×20	0.088	0.18	1,050	ELXZ500E□□221MJ20S	390	12.5×25	0.070	0.14	1,720	ELXZ630E□□391MK25S	
	330	10×25	0.073	0.15	1,250	ELXZ500E□□331MJ25S	470	12.5×30	0.055	0.11	2,090	ELXZ630E□□471MK30S	
	390	10×30	0.054	0.11	1,500	ELXZ500E□□391MJ30S	63	470	16×20	0.059	0.12	1,770	ELXZ630E□□471ML20S
	390	12.5×20	0.059	0.12	1,480	ELXZ500E□□391MK20S		680	12.5×35	0.047	0.094	2,270	ELXZ630E□□681MK35S
	470	12.5×20	0.059	0.12	1,480	ELXZ500E□□471MK20S		680	16×25	0.050	0.10	2,160	ELXZ630E□□681ML25S
	560	12.5×25	0.044	0.088	1,840	ELXZ500E□□561MK25S		680	18×20	0.055	0.11	2,290	ELXZ630E□□681MM20S
	680	12.5×30	0.039	0.078	2,220	ELXZ500E□□681MK30S		820	12.5×40	0.042	0.084	2,560	ELXZ630E□□821MK40S
	680	16×20	0.048	0.096	1,840	ELXZ500E□□681ML20S		820	16×30	0.043	0.086	2,670	ELXZ630E□□821ML30S
	820	12.5×35	0.033	0.066	2,290	ELXZ500E□□821MK35S		820	18×25	0.043	0.086	2,590	ELXZ630E□□821MM25S
	820	18×20	0.042	0.084	1,980	ELXZ500E□□821MM20S		1,000	16×30	0.043	0.086	2,670	ELXZ630E□□102ML30S
	1,000	12.5×40	0.029	0.058	2,500	ELXZ500E□□102MK40S		1,000	16×35	0.036	0.072	2,770	ELXZ630E□□102ML35S
	1,000	16×25	0.034	0.068	2,240	ELXZ500E□□102ML25S		1,200	16×40	0.030	0.060	2,850	ELXZ630E□□122ML40S
1,200	16×30	0.028	0.056	2,700	ELXZ500E□□122ML30S	1,200		18×30	0.032	0.064	2,950	ELXZ630E□□122MM30S	
1,200	18×25	0.029	0.058	2,610	ELXZ500E□□122MM25S	1,500		18×35	0.030	0.060	3,100	ELXZ630E□□152MM35S	
1,500	16×35	0.025	0.050	2,800	ELXZ500E□□152ML35S	1,800		18×40	0.025	0.050	3,210	ELXZ630E□□182MM40S	
1,800	16×40	0.021	0.042	3,200	ELXZ500E□□182ML40S	2,200	18×40	0.025	0.050	3,210	ELXZ630E□□222MM40S		
1,800	18×30	0.025	0.050	3,000	ELXZ500E□□182MM30S	3,300	18×40	0.021	0.042	3,900	ELXZ630E□□332MM40S		
2,200	18×35	0.023	0.046	3,100	ELXZ500E□□222MM35S								

□ □ : Enter the appropriate lead forming or taping code.
 Production of the products shown in is scheduled to be discontinued.

◆RATED RIPPLE CURRENT MULTIPLIERS

●Frequency Multipliers

Capacitance(μF)	Frequency(Hz)			
	120	1k	10k	100k
12 to 180	0.40	0.75	0.90	1.00
220 to 560	0.50	0.85	0.94	1.00
680 to 1,800	0.60	0.87	0.95	1.00
2,200 to 3,900	0.75	0.90	0.95	1.00
4,700 to 18,000	0.85	0.95	0.98	1.00

The deterioration of aluminum electrolytic capacitors accelerates their life due to the internal heating produced by ripple current. For details, refer to Section "5-3 Ripple Current Effect on Lifetime" in the catalog, Technical Note.

LXY Series

- Adoption of innovative electrolyte and new technologies
- Endurance with ripple current : 2,000 to 8,000 hours at 105°C
- Solvent resistant type (see PRECAUTIONS AND GUIDELINES)
- RoHS2 Compliant
- AEC-Q200 compliant : Please contact Chemi-Con for more details, test data, information.



SPECIFICATIONS

Items	Characteristics	
Category Temperature Range	-55 to +105°C	
Rated Voltage Range	10 to 63V _{dc}	
Capacitance Tolerance	±20% (M) (at 20°C, 120Hz)	
Leakage Current	I=0.01CV or 3μA, whichever is greater. Where, I : Max. leakage current (μA), C : Nominal capacitance (μF), V : Rated voltage (V) (at 20°C after 2 minutes)	
Dissipation Factor (tan δ)	Rated voltage (V _{dc})	10V 16V 25V 35V 50V 63V
	tan δ (Max.)	0.19 0.16 0.14 0.12 0.10 0.10
	When nominal capacitance exceeds 1,000μF, add 0.02 to the value above for each 1,000μF increase. (at 20°C, 120Hz)	
Low Temperature Characteristics (Max. Impedance Ratio)	Z(-55°C)/Z(+20°C)	10 to 50V _{dc} : 3max. 63V _{dc} : 6max. (at 120Hz)
	Endurance	The following specifications shall be satisfied when the capacitors are restored to 20°C after subjected to DC voltage with the rated ripple current is applied (the peak voltage shall not exceed the rated voltage) for the specified period of time at 105°C.
	Time	φ5 & 6.3 : 2,000hours φ8 : 3,000hours φ10 : 5,000hours φ12.5 : 7,000hours φ16 & 18 : 8,000hours
	Capacitance change	≤ ±20% of the initial value
	D.F. (tan δ)	≤200% of the initial specified value
	Leakage current	≤The initial specified value
Shelf Life	The following specifications shall be satisfied when the capacitors are restored to 20°C after exposing them for 1,000 hours at 105°C without voltage applied. Before the measurement, the capacitor shall be preconditioned by applying voltage according to Item 4.1 of JIS C 5101-4.	
	Capacitance change	≤ ±20% of the initial value
	D.F. (tan δ)	≤200% of the initial specified value
	Leakage current	≤The initial specified value

DIMENSIONS [mm]

- Terminal Code : E

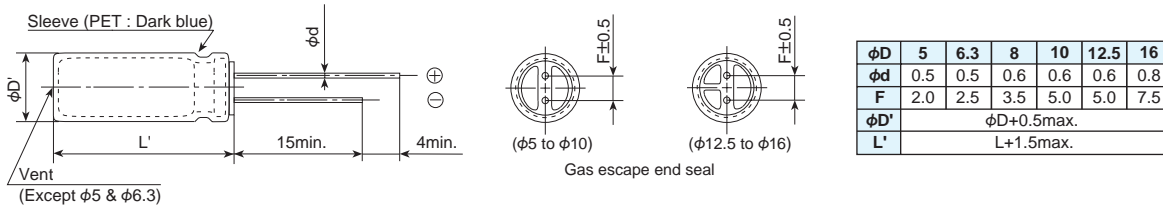

PART NUMBERING SYSTEM

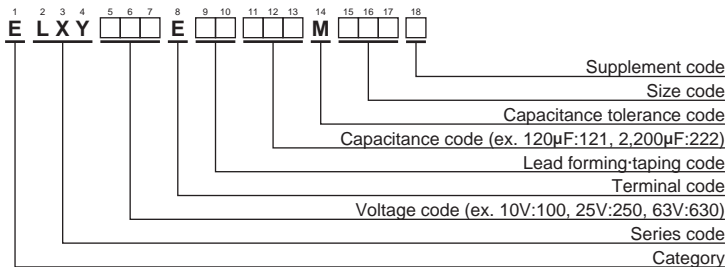

Please refer to "Product code guide (radial lead type)"

RATED RIPPLE CURRENT MULTIPLIERS

- Frequency Multipliers

Capacitance(μF)	Frequency(Hz)			
	120	1k	10k	100k
10 to 180	0.40	0.75	0.90	1.00
220 to 560	0.50	0.85	0.94	1.00
680 to 1,800	0.60	0.87	0.95	1.00
2,200 to 3,900	0.75	0.90	0.95	1.00
4,700 to 8,200	0.85	0.95	0.98	1.00

The deterioration of aluminum electrolytic capacitors accelerates their life due to the internal heating produced by ripple current. For details, refer to Section "5-3 Ripple Current Effect on Lifetime" in the catalog, Technical Note.



LXY Series

◆ **STANDARD RATINGS**

WV (V _{dc})	Cap (μF)	Case size φD×L(mm)	Impedance (Ω max./100kHz)		Rated ripple current (mA rms/105°C, 100kHz)	Part No.	WV (V _{dc})	Cap (μF)	Case size φD×L(mm)	Impedance (Ω max./100kHz)		Rated ripple current (mA rms/105°C, 100kHz)	Part No.
			20°C	-10°C						20°C	-10°C		
10	82	5×11.5	0.75	1.5	163	ELXY100E□□820MEB5D	35	27	5×11.5	0.75	1.5	163	ELXY350E□□270MEB5D
	180	6.3×11.5	0.35	0.70	273	ELXY100E□□181MFB5D		56	6.3×11.5	0.35	0.70	273	ELXY350E□□560MFB5D
	220	6.3×15	0.25	0.50	390	ELXY100E□□221MF15D		82	6.3×15	0.25	0.50	390	ELXY350E□□820MF15D
	330	8×12	0.17	0.34	445	ELXY100E□□331MH12D		120	8×12	0.17	0.34	445	ELXY350E□□121MH12D
	390	10×12.5	0.12	0.24	625	ELXY100E□□391MJC5S		120	10×12.5	0.12	0.24	625	ELXY350E□□121MJC5S
	470	8×15	0.13	0.26	555	ELXY100E□□471MH15D		180	8×15	0.13	0.26	555	ELXY350E□□181MH15D
	680	8×20	0.095	0.19	740	ELXY100E□□681MH20D		220	8×20	0.095	0.19	740	ELXY350E□□221MH20D
	680	10×16	0.084	0.17	825	ELXY100E□□681MJ16S		220	10×16	0.084	0.17	825	ELXY350E□□221MJ16S
	1,000	10×20	0.062	0.13	1,040	ELXY100E□□102MJ20S		330	10×20	0.062	0.13	1,040	ELXY350E□□331MJ20S
	1,200	10×25	0.052	0.11	1,260	ELXY100E□□122MJ25S		390	10×25	0.052	0.11	1,260	ELXY350E□□391MJ25S
	1,500	10×30	0.044	0.088	1,440	ELXY100E□□152MJ30S		560	10×30	0.044	0.088	1,440	ELXY350E□□561MJ30S
	1,800	12.5×20	0.046	0.092	1,340	ELXY100E□□181MK20S		560	12.5×20	0.046	0.092	1,340	ELXY350E□□561MK20S
	2,200	12.5×25	0.034	0.068	1,690	ELXY100E□□222MK25S		680	12.5×25	0.034	0.068	1,690	ELXY350E□□681MK25S
	2,700	12.5×30	0.030	0.060	1,950	ELXY100E□□272MK30S		1,000	12.5×30	0.030	0.060	1,950	ELXY350E□□102MK30S
	3,300	12.5×35	0.024	0.048	2,220	ELXY100E□□332MK35S		1,000	16×20	0.038	0.076	1,630	ELXY350E□□102ML20S
	3,300	16×20	0.038	0.076	1,630	ELXY100E□□332ML20S		1,200	12.5×35	0.024	0.048	2,220	ELXY350E□□122ML35S
	3,900	12.5×40	0.022	0.044	2,390	ELXY100E□□392MK40S		1,200	16×25	0.028	0.056	2,070	ELXY350E□□122ML25S
	3,900	16×25	0.028	0.056	2,070	ELXY100E□□392ML25S		1,500	12.5×40	0.022	0.044	2,390	ELXY350E□□152MK40S
5,600	16×30	0.025	0.050	2,350	ELXY100E□□562ML30S	1,800	16×30	0.025	0.050	2,350	ELXY350E□□182ML30S		
6,800	16×35	0.022	0.044	2,550	ELXY100E□□682ML35S	2,200	16×35	0.022	0.044	2,550	ELXY350E□□222ML35S		
8,200	16×40	0.018	0.036	2,900	ELXY100E□□822ML40S	2,700	16×40	0.018	0.036	2,900	ELXY350E□□272ML40S		
16	56	5×11.5	0.75	1.5	163	ELXY160E□□560MEB5D	50	18	5×11.5	1.2	2.4	129	ELXY500E□□180MEB5D
	120	6.3×11.5	0.35	0.70	273	ELXY160E□□121MFB5D		39	6.3×11.5	0.54	1.1	219	ELXY500E□□390MFB5D
	180	6.3×15	0.25	0.50	390	ELXY160E□□181MF15D		56	6.3×15	0.34	0.68	310	ELXY500E□□560MF15D
	270	8×12	0.17	0.34	445	ELXY160E□□271MH12D		68	8×12	0.30	0.60	340	ELXY500E□□680MH12D
	270	10×12.5	0.12	0.24	625	ELXY160E□□271MJC5S		82	8×15	0.20	0.40	470	ELXY500E□□820MH15D
	330	8×15	0.13	0.26	555	ELXY160E□□331MH15D		82	10×12.5	0.20	0.40	480	ELXY500E□□820MJC5S
	470	8×20	0.095	0.19	740	ELXY160E□□471MH20D		120	8×20	0.14	0.28	610	ELXY500E□□121MH20D
	470	10×16	0.084	0.17	825	ELXY160E□□471MJ16S		120	10×16	0.13	0.26	755	ELXY500E□□121MJ16S
	680	10×20	0.062	0.13	1,040	ELXY160E□□681MJ20S		180	10×20	0.088	0.18	945	ELXY500E□□181MJ20S
	820	10×25	0.052	0.11	1,260	ELXY160E□□821MJ25S		220	10×25	0.073	0.15	1,150	ELXY500E□□221MJ25S
	1,200	10×30	0.044	0.088	1,440	ELXY160E□□122MJ30S		330	10×30	0.054	0.11	1,260	ELXY500E□□331MJ30S
	1,200	12.5×20	0.046	0.092	1,340	ELXY160E□□122MK20S		330	12.5×20	0.059	0.12	1,190	ELXY500E□□331MK20S
	1,500	12.5×25	0.034	0.068	1,690	ELXY160E□□152MK25S		470	12.5×25	0.044	0.088	1,490	ELXY500E□□471MK25S
	2,200	12.5×30	0.030	0.060	1,950	ELXY160E□□222MK30S		560	12.5×30	0.039	0.078	1,720	ELXY500E□□561MK30S
	2,200	16×20	0.038	0.076	1,630	ELXY160E□□222ML20S		680	12.5×35	0.033	0.066	1,890	ELXY500E□□681MK35S
	2,700	12.5×35	0.024	0.048	2,220	ELXY160E□□272MK35S		680	16×20	0.050	0.10	1,420	ELXY500E□□681ML20S
	2,700	16×25	0.028	0.056	2,070	ELXY160E□□272ML25S		820	12.5×40	0.029	0.058	2,030	ELXY500E□□821MK40S
	3,300	12.5×40	0.022	0.044	2,390	ELXY160E□□332MK40S		820	16×25	0.034	0.068	1,880	ELXY500E□□821ML25S
3,900	16×30	0.025	0.050	2,350	ELXY160E□□392ML30S	1,000	16×30	0.030	0.060	2,150	ELXY500E□□102ML30S		
4,700	16×35	0.022	0.044	2,550	ELXY160E□□472ML35S	1,200	16×35	0.027	0.054	2,320	ELXY500E□□122ML35S		
5,600	16×40	0.018	0.036	2,900	ELXY160E□□562ML40S	1,500	16×40	0.024	0.048	2,540	ELXY500E□□152ML40S		
25	39	5×11.5	0.75	1.5	163	ELXY250E□□390MEB5D	63	10	5×11.5	1.9	4.8	103	ELXY630E□□100MEB5D
	82	6.3×11.5	0.35	0.70	273	ELXY250E□□820MFB5D		18	6.3×11.5	1.0	2.5	161	ELXY630E□□180MFB5D
	120	6.3×15	0.25	0.50	390	ELXY250E□□121MF15D		33	6.3×15	0.61	1.6	233	ELXY630E□□330MF15D
	150	8×12	0.17	0.34	445	ELXY250E□□151MH12D		47	8×12	0.47	1.2	274	ELXY630E□□470MH12D
	180	10×12.5	0.12	0.24	625	ELXY250E□□181MJC5S		56	10×12.5	0.27	0.68	418	ELXY630E□□560MJC5S
	220	8×15	0.13	0.26	555	ELXY250E□□221MH15D		68	8×15	0.34	0.85	360	ELXY630E□□680MH15D
	330	8×20	0.095	0.19	740	ELXY250E□□331MH20D		68	10×16	0.21	0.53	525	ELXY630E□□680MJ16S
	330	10×16	0.084	0.17	825	ELXY250E□□331MJ16S		82	8×20	0.21	0.53	500	ELXY630E□□820MH20D
	470	10×20	0.062	0.13	1,040	ELXY250E□□471MJ20S		120	10×20	0.16	0.40	650	ELXY630E□□121MJ20S
	560	10×25	0.052	0.11	1,260	ELXY250E□□561MJ25S		150	10×25	0.13	0.33	783	ELXY630E□□151MJ25S
	820	10×30	0.044	0.088	1,440	ELXY250E□□821MJ30S		180	10×30	0.10	0.25	960	ELXY630E□□181MJ30S
	820	12.5×20	0.046	0.092	1,340	ELXY250E□□821MK20S		220	12.5×20	0.11	0.28	870	ELXY630E□□221MK20S
	1,000	12.5×25	0.034	0.068	1,690	ELXY250E□□102MK25S		270	12.5×25	0.074	0.19	1,150	ELXY630E□□271MK25S
	1,500	12.5×30	0.030	0.060	1,950	ELXY250E□□152MK30S		330	16×20	0.085	0.22	1,100	ELXY630E□□331ML20S
	1,500	16×20	0.038	0.076	1,630	ELXY250E□□152ML20S		390	12.5×30	0.068	0.17	1,280	ELXY630E□□391MK30S
	1,800	12.5×35	0.024	0.048	2,220	ELXY250E□□182MK35S		470	12.5×35	0.063	0.16	1,390	ELXY630E□□471MK35S
	1,800	16×25	0.028	0.056	2,070	ELXY250E□□182ML25S		470	16×25	0.055	0.14	1,480	ELXY630E□□471ML25S
	2,200	12.5×40	0.022	0.044	2,390	ELXY250E□□222MK40S		560	12.5×40	0.051	0.13	1,530	ELXY630E□□561MK40S
2,700	16×30	0.025	0.050	2,350	ELXY250E□□272ML30S	680	16×30	0.046	0.12	1,720	ELXY630E□□681ML30S		
3,300	16×35	0.022	0.044	2,550	ELXY250E□□332ML35S	820	16×35	0.040	0.10	1,910	ELXY630E□□821ML35S		
3,900	16×40	0.018	0.036	2,900	ELXY250E□□392ML40S	1,000	16×40	0.036	0.090	2,070	ELXY630E□□102ML40S		

□ □ : Enter the appropriate lead forming or taping code.

Production of the products shown in is scheduled to be discontinued.



LXV Series

- Low impedance
- Endurance with ripple current : 2,000 to 5,000 hours at 105°C
- Solvent resistant type (see PRECAUTIONS AND GUIDELINES)
- RoHS2 Compliant
- AEC-Q200 compliant : Please contact Chemi-Con for more details, test data, information.

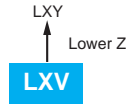

SPECIFICATIONS

Items	Characteristics	
Category	-55 to +105°C	
Temperature Range	-55 to +105°C	
Rated Voltage Range	6.3 to 100V _{dc}	
Capacitance Tolerance	±20% (M) (at 20°C, 120Hz)	
Leakage Current	I=0.01CV or 3μA, whichever is greater. Where, I : Max. leakage current (μA), C : Nominal capacitance (μF), V : Rated voltage (V) (at 20°C after 2 minutes)	
Dissipation Factor (tan δ)	Rated voltage (V _{dc})	6.3V 10V 16V 25V 35V 50V 63V 80V 100V
	tan δ (Max.)	0.22 0.19 0.16 0.14 0.12 0.10 0.10 0.09 0.08
	When nominal capacitance exceeds 1,000μF, add 0.02 to the value above for each 1,000μF increase. (at 20°C, 120Hz)	
Low Temperature Characteristics	Capacitance change ΔC (-55°C /+20°C)	0.7min.
	Max. impedance ratio (-55°C /+20°C)	3max.(6.3V _{dc} : 4max.) (at 120Hz)
Endurance	The following specifications shall be satisfied when the capacitors are restored to 20°C after subjected to DC voltage with the rated ripple current is applied (the peak voltage shall not exceed the rated voltage) for the specified period of time at 105°C.	
	Time	φ 5 to 6.3 : 2,000hours φ 8 & 10: 3,000hours φ 12.5 to φ 18: 5,000hours
	Capacitance change	≤ ±20% of the initial value
	D.F. (tan δ)	≤200% of the initial specified value
	Leakage current	≤The initial specified value
Shelf Life	The following specifications shall be satisfied when the capacitors are restored to 20°C after exposing them for 1,000 hours at 105°C without voltage applied. Before the measurement, the capacitor shall be preconditioned by applying voltage according to Item 4.1 of JIS C 5101-4.	
	Capacitance change	≤ ±20% of the initial value
	D.F. (tan δ)	≤200% of the initial specified value
	Leakage current	≤The initial specified value

DIMENSIONS [mm]

- Terminal Code : E

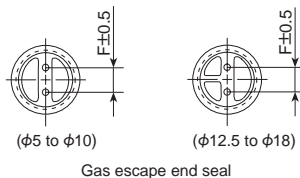
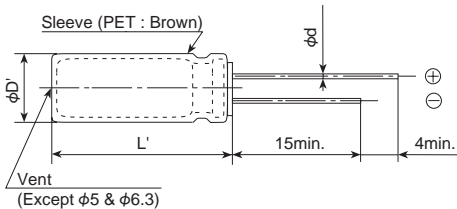

φD	5	6.3	8	10	12.5	16	18
φd	0.5	0.5	0.6	0.6	0.6	0.8	0.8
F	2.0	2.5	3.5	5.0	5.0	7.5	7.5
φD'	φD+0.5max.						
L'	L+1.5max.						

PART NUMBERING SYSTEM

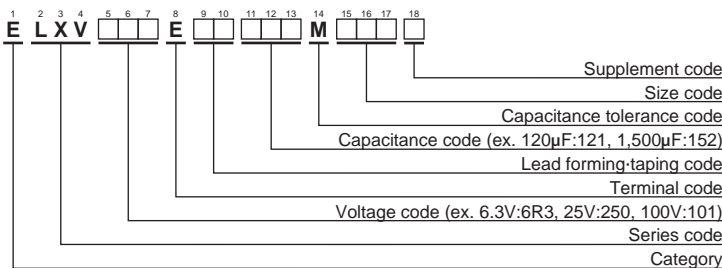

Please refer to "Product code guide (radial lead type)"



◆STANDARD RATINGS

VV (V _{dc})	Cap (μF)	Case size φD×L(mm)	Impedance (Ω max./100kHz)		Rated ripple current (mA rms/105°C, 100kHz)	Part No.	VV (V _{dc})	Cap (μF)	Case size φD×L(mm)	Impedance (Ω max./100kHz)		Rated ripple current (mA rms/105°C, 100kHz)	Part No.
			20°C	-10°C						20°C	-10°C		
6.3	120	5×11.5	0.72	1.8	165	ELXV6R3E□□121MEB5D	16	2,700	12.5×35	0.027	0.068	2,230	ELXV160E□□272MK35S
	220	6.3×11.5	0.38	0.95	255	ELXV6R3E□□221MFB5D		2,700	16×25	0.028	0.070	2,190	ELXV160E□□272ML25S
	330	6.3×15	0.27	0.68	330	ELXV6R3E□□331MF15D		3,300	12.5×40	0.024	0.060	2,460	ELXV160E□□332MK40S
	390	8×12	0.20	0.50	415	ELXV6R3E□□391MH12D		3,300	18×20	0.036	0.090	1,940	ELXV160E□□332MM20S
	470	10×12.5	0.12	0.30	635	ELXV6R3E□□471MJC5S		3,900	16×30	0.025	0.063	2,510	ELXV160E□□392ML30S
	560	8×15	0.16	0.40	495	ELXV6R3E□□561MH15D		3,900	18×25	0.027	0.068	2,350	ELXV160E□□392MM25S
	680	10×16	0.084	0.21	825	ELXV6R3E□□681MJ16S		4,700	16×35	0.022	0.055	2,770	ELXV160E□□472ML35S
	820	8×20	0.11	0.28	640	ELXV6R3E□□821MH20D		4,700	18×30	0.024	0.060	2,720	ELXV160E□□472MM30S
	1,200	10×20	0.062	0.16	1,060	ELXV6R3E□□122MJ20S		5,600	16×40	0.018	0.045	3,110	ELXV160E□□562ML40S
	1,500	10×25	0.052	0.13	1,260	ELXV6R3E□□152MJ25S		6,800	18×35	0.021	0.053	3,050	ELXV160E□□682MM35S
	2,200	10×30	0.044	0.11	1,450	ELXV6R3E□□222MJ30S		8,200	18×40	0.017	0.043	3,300	ELXV160E□□822MM40S
	2,200	12.5×20	0.046	0.12	1,360	ELXV6R3E□□222MK20S		39	5×11.5	0.72	1.8	165	ELXV250E□□390MEB5D
	2,700	12.5×25	0.034	0.085	1,700	ELXV6R3E□□272MK25S		82	6.3×11.5	0.38	0.95	255	ELXV250E□□820MFB5D
	3,900	12.5×30	0.030	0.075	1,980	ELXV6R3E□□392MK30S		120	6.3×15	0.27	0.68	330	ELXV250E□□121MF15D
	3,900	16×20	0.038	0.095	1,770	ELXV6R3E□□392ML20S		150	8×12	0.20	0.50	415	ELXV250E□□331MH12D
	4,700	12.5×35	0.027	0.068	2,230	ELXV6R3E□□472MK35S		180	10×12.5	0.12	0.30	635	ELXV250E□□181MJC5S
	5,600	12.5×40	0.024	0.060	2,460	ELXV6R3E□□562MK40S		220	8×15	0.16	0.40	495	ELXV250E□□221MH15D
	5,600	16×25	0.028	0.070	2,190	ELXV6R3E□□562ML25S		330	8×20	0.11	0.28	640	ELXV250E□□331MH20D
5,600	18×20	0.036	0.090	1,940	ELXV6R3E□□562MM20S	330	10×16	0.084	0.21	825	ELXV250E□□331MJ16S		
6,800	16×30	0.025	0.063	2,510	ELXV6R3E□□682ML30S	470	10×20	0.062	0.16	1,060	ELXV250E□□471MJ20S		
6,800	18×25	0.027	0.068	2,350	ELXV6R3E□□682MM25S	560	10×25	0.052	0.13	1,260	ELXV250E□□561MJ25S		
8,200	16×35	0.022	0.055	2,770	ELXV6R3E□□822ML35S	820	10×30	0.044	0.11	1,450	ELXV250E□□821MJ30S		
10,000	16×40	0.018	0.045	3,110	ELXV6R3E□□103ML40S	820	12.5×20	0.046	0.12	1,360	ELXV250E□□821MK20S		
10,000	18×30	0.024	0.060	2,720	ELXV6R3E□□103MM30S	1,000	12.5×25	0.034	0.085	1,700	ELXV250E□□102MK25S		
12,000	18×35	0.021	0.053	3,050	ELXV6R3E□□123MM35S	1,500	12.5×30	0.030	0.075	1,980	ELXV250E□□152MK30S		
15,000	18×40	0.017	0.043	3,300	ELXV6R3E□□153MM40S	1,500	16×20	0.038	0.095	1,770	ELXV250E□□152ML20S		
10	82	5×11.5	0.72	1.8	165	ELXV100E□□820MEB5D	1,800	12.5×35	0.027	0.068	2,230	ELXV250E□□182MK35S	
	180	6.3×11.5	0.38	0.95	255	ELXV100E□□181MFB5D	1,800	16×25	0.028	0.070	2,190	ELXV250E□□182ML25S	
	270	6.3×15	0.27	0.68	330	ELXV100E□□271MF15D	2,200	12.5×40	0.024	0.060	2,460	ELXV250E□□222MK40S	
	330	8×12	0.20	0.50	415	ELXV100E□□331MH12D	2,200	18×20	0.036	0.090	1,940	ELXV250E□□222MM20S	
	390	10×12.5	0.12	0.30	635	ELXV100E□□391MJC5S	2,700	16×30	0.025	0.063	2,510	ELXV250E□□272ML30S	
	470	8×15	0.16	0.40	495	ELXV100E□□471MH15D	2,700	18×25	0.027	0.068	2,350	ELXV250E□□272MM25S	
	680	8×20	0.11	0.28	640	ELXV100E□□681MH20D	3,300	16×35	0.022	0.055	2,770	ELXV250E□□332ML35S	
	680	10×16	0.084	0.21	825	ELXV100E□□681MJ16S	3,300	18×30	0.024	0.060	2,720	ELXV250E□□332MM30S	
	1,000	10×20	0.062	0.16	1,060	ELXV100E□□102MJ20S	3,900	16×40	0.018	0.045	3,110	ELXV250E□□392ML40S	
	1,200	10×25	0.052	0.13	1,260	ELXV100E□□122MJ25S	3,900	18×35	0.021	0.053	3,050	ELXV250E□□392MM35S	
	1,500	10×30	0.044	0.11	1,450	ELXV100E□□152MJ30S	4,700	18×40	0.017	0.043	3,300	ELXV250E□□472MM40S	
	1,800	12.5×20	0.046	0.12	1,360	ELXV100E□□182MK20S	27	5×11.5	0.72	1.8	165	ELXV350E□□270MEB5D	
	2,200	12.5×25	0.034	0.085	1,700	ELXV100E□□222MK25S	56	6.3×11.5	0.38	0.95	255	ELXV350E□□560MFB5D	
	2,700	12.5×30	0.030	0.075	1,980	ELXV100E□□272MK30S	82	6.3×15	0.27	0.68	330	ELXV350E□□820MF15D	
	3,300	12.5×35	0.027	0.068	2,230	ELXV100E□□323MK35S	120	8×12	0.20	0.50	415	ELXV350E□□121MH12D	
	3,300	16×20	0.038	0.095	1,770	ELXV100E□□332ML20S	120	10×12.5	0.12	0.30	635	ELXV350E□□121MJC5S	
	3,900	12.5×40	0.024	0.060	2,460	ELXV100E□□392MK40S	180	8×15	0.16	0.40	495	ELXV350E□□181MH15D	
	3,900	16×25	0.028	0.070	2,190	ELXV100E□□392ML25S	220	8×20	0.11	0.28	640	ELXV350E□□221MH20D	
3,900	18×20	0.036	0.090	1,940	ELXV100E□□392MM20S	220	10×16	0.084	0.21	825	ELXV350E□□221MJ16S		
4,700	18×25	0.027	0.068	2,350	ELXV100E□□472MM25S	330	10×20	0.062	0.16	1,060	ELXV350E□□331MJ20S		
5,600	16×30	0.025	0.063	2,510	ELXV100E□□562ML30S	390	10×25	0.052	0.13	1,260	ELXV350E□□391MJ25S		
6,800	16×35	0.022	0.055	2,770	ELXV100E□□682ML35S	560	10×30	0.044	0.11	1,450	ELXV350E□□561MJ30S		
6,800	18×30	0.024	0.060	2,720	ELXV100E□□682MM30S	560	12.5×20	0.046	0.12	1,360	ELXV350E□□561MK20S		
8,200	16×40	0.018	0.045	3,110	ELXV100E□□822ML40S	680	12.5×25	0.034	0.085	1,700	ELXV350E□□681MK25S		
8,200	18×35	0.021	0.053	3,050	ELXV100E□□822MM35S	1,000	12.5×30	0.030	0.075	1,980	ELXV350E□□102MK30S		
10,000	18×40	0.017	0.043	3,300	ELXV100E□□103MM40S	1,000	16×20	0.038	0.095	1,770	ELXV350E□□102ML20S		
16	56	5×11.5	0.72	1.8	165	ELXV160E□□560MEB5D	1,200	12.5×35	0.027	0.068	2,230	ELXV350E□□122MK35S	
	120	6.3×11.5	0.38	0.95	255	ELXV160E□□121MFB5D	1,200	16×25	0.028	0.070	2,190	ELXV350E□□122ML25S	
	180	6.3×15	0.27	0.68	330	ELXV160E□□181MF15D	1,500	12.5×40	0.024	0.060	2,460	ELXV350E□□152MK40S	
	270	8×12	0.20	0.50	415	ELXV160E□□271MH12D	1,500	18×20	0.036	0.090	1,940	ELXV350E□□152MM20S	
	270	10×12.5	0.12	0.30	635	ELXV160E□□271MJC5S	1,800	16×30	0.025	0.063	2,510	ELXV350E□□182ML30S	
	330	8×15	0.16	0.40	495	ELXV160E□□331MH15D	1,800	18×25	0.027	0.068	2,350	ELXV350E□□182MM25S	
	470	8×20	0.11	0.28	640	ELXV160E□□471MH20D	2,200	16×35	0.022	0.055	2,770	ELXV350E□□222ML35S	
	470	10×16	0.084	0.21	825	ELXV160E□□471MJ16S	2,200	18×30	0.024	0.060	2,720	ELXV350E□□222MM30S	
	680	10×20	0.062	0.16	1,060	ELXV160E□□681MJ20S	2,700	16×40	0.018	0.045	3,110	ELXV350E□□272ML40S	
	820	10×25	0.052	0.13	1,260	ELXV160E□□821MJ25S	2,700	18×35	0.021	0.053	3,050	ELXV350E□□272MM35S	
	1,200	10×30	0.044	0.11	1,450	ELXV160E□□122MJ30S	3,300	18×40	0.017	0.043	3,300	ELXV350E□□332MM40S	
	1,200	12.5×20	0.046	0.12	1,360	ELXV160E□□122MK20S	18	5×11.5	1.1	3.3	165	ELXV500E□□180MEB5D	
	1,500	12.5×25	0.034	0.085	1,700	ELXV160E□□152MK25S	39	6.3×11.5	0.56	1.6	255	ELXV500E□□390MFB5D	
	2,200	12.5×30	0.030	0.075	1,980	ELXV160E□□222MK30S	56	6.3×15	0.41	1.2	310	ELXV500E□□560MF15D	
	2,200	16×20	0.038	0.095	1,770	ELXV160E□□222ML20S	68	8×12	0.29	0.84	415	ELXV500E□□680MH12D	

□□ : Enter the appropriate lead forming or taping code. Production of the products shown in [] is scheduled to be discontinued.



◆STANDARD RATINGS

VV (V _{dc})	Cap (μF)	Case size φD×L(mm)	Impedance (Ω max./100kHz)		Rated ripple current (mA _{rms} /105°C, 100kHz)	Part No.	VV (V _{dc})	Cap (μF)	Case size φD×L(mm)	Impedance (Ω max./100kHz)		Rated ripple current (mA _{rms} /105°C, 100kHz)	Part No.
			20°C	-10°C						20°C	-10°C		
50	82	8×15	0.24	0.72	505	ELXV500E□□820MH15D	80	27	6.3×15	0.62	1.7	220	ELXV800E□□270MF15D
	82	10×12.5	0.16	0.40	530	ELXV500E□□820MJC5S		33	8×12	0.53	1.5	275	ELXV800E□□330MH12D
	120	8×20	0.18	0.52	610	ELXV500E□□121MH20D		39	10×12.5	0.47	1.3	380	ELXV800E□□390MJC5S
	120	10×16	0.12	0.30	755	ELXV500E□□121MJ16S		47	8×15	0.35	0.97	360	ELXV800E□□470MH15D
	180	10×20	0.088	0.22	945	ELXV500E□□181MJ20S		56	8×20	0.27	0.74	490	ELXV800E□□560MH20D
	220	10×25	0.068	0.17	1,150	ELXV500E□□221MJ25S		56	10×16	0.33	0.90	500	ELXV800E□□560MJ16S
	330	10×30	0.059	0.15	1,260	ELXV500E□□331MJ30S		82	10×20	0.26	0.70	620	ELXV800E□□820MJ20S
	330	12.5×20	0.059	0.15	1,190	ELXV500E□□331MK20S		100	10×25	0.19	0.52	795	ELXV800E□□101MJ25S
	470	12.5×25	0.045	0.11	1,500	ELXV500E□□471MK25S		150	10×30	0.15	0.41	955	ELXV800E□□151MJ30S
	560	12.5×30	0.039	0.098	1,720	ELXV500E□□561MK30S		150	12.5×20	0.15	0.41	890	ELXV800E□□151MK20S
	680	12.5×35	0.033	0.083	1,900	ELXV500E□□681MK35S		180	12.5×25	0.11	0.30	1,040	ELXV800E□□181MK25S
	680	16×20	0.043	0.11	1,500	ELXV500E□□681ML20S		270	12.5×30	0.094	0.26	1,270	ELXV800E□□271MK30S
	820	12.5×40	0.029	0.073	2,120	ELXV500E□□821MK40S		270	16×20	0.11	0.30	1,240	ELXV800E□□271ML20S
	820	16×25	0.033	0.083	1,880	ELXV500E□□821ML25S		330	12.5×35	0.087	0.24	1,450	ELXV800E□□331MK35S
	820	18×20	0.039	0.098	1,660	ELXV500E□□821MM20S		330	16×25	0.081	0.22	1,440	ELXV800E□□331ML25S
	1,000	16×30	0.029	0.073	2,150	ELXV500E□□102ML30S		390	12.5×40	0.060	0.17	1,610	ELXV800E□□391MK40S
	1,000	18×25	0.030	0.075	2,020	ELXV500E□□102MM25S		390	18×20	0.085	0.23	1,450	ELXV800E□□391MM20S
	1,200	16×35	0.025	0.063	2,320	ELXV500E□□122ML35S		470	16×30	0.058	0.16	1,790	ELXV800E□□471ML30S
	1,500	16×40	0.021	0.053	2,650	ELXV500E□□152ML40S		470	18×25	0.070	0.19	1,650	ELXV800E□□471MM25S
	1,500	18×30	0.026	0.065	2,340	ELXV500E□□152MM30S		560	16×35	0.052	0.14	2,000	ELXV800E□□561ML35S
1,800	18×35	0.023	0.058	2,620	ELXV500E□□182MM35S	680	16×40	0.041	0.11	2,200	ELXV800E□□681ML40S		
2,200	18×40	0.020	0.050	2,790	ELXV500E□□222MM40S	680	18×30	0.058	0.16	1,850	ELXV800E□□681MM30S		
63	12	5×11.5	1.9	4.8	100	ELXV630E□□120MEB5D	100	5.6	5×11.5	1.9	5.1	100	ELXV101E□□5R6MEB5D
	27	6.3×11.5	1.1	2.8	160	ELXV630E□□270MFB5D		12	6.3×11.5	1.1	3.0	150	ELXV101E□□120MFB5D
	39	6.3×15	0.62	1.6	230	ELXV630E□□390MF15D		18	6.3×15	0.62	1.7	220	ELXV101E□□180MF15D
	47	8×12	0.49	1.3	275	ELXV630E□□470MH12D		22	8×12	0.53	1.5	275	ELXV101E□□220MH12D
	56	10×12.5	0.27	0.68	420	ELXV630E□□560MJC5S		27	10×12.5	0.47	1.3	380	ELXV101E□□270MJC5S
	68	8×15	0.34	0.85	360	ELXV630E□□680MH15D		33	8×15	0.35	0.97	360	ELXV101E□□330MH15D
	68	10×16	0.21	0.53	523	ELXV630E□□680MJ16S		33	10×16	0.33	0.90	500	ELXV101E□□330MJ16S
	82	8×20	0.21	0.53	500	ELXV630E□□820MH20D		39	8×20	0.27	0.74	490	ELXV101E□□390MH20D
	120	10×20	0.16	0.40	650	ELXV630E□□121MJ20S		56	10×20	0.26	0.70	620	ELXV101E□□560MJ20S
	150	10×25	0.13	0.33	780	ELXV630E□□151MJ25S		68	10×25	0.19	0.52	795	ELXV101E□□680MJ25S
	180	10×30	0.10	0.25	960	ELXV630E□□181MJ30S		100	10×30	0.15	0.41	955	ELXV101E□□101MJ30S
	220	12.5×20	0.11	0.28	870	ELXV630E□□221MK20S		100	12.5×20	0.15	0.41	890	ELXV101E□□101MK20S
	270	12.5×25	0.074	0.19	1,150	ELXV630E□□271MK25S		120	12.5×25	0.11	0.30	1,040	ELXV101E□□121MK25S
	390	12.5×30	0.068	0.17	1,280	ELXV630E□□391MK30S		180	12.5×30	0.094	0.26	1,270	ELXV101E□□181MK30S
	390	16×20	0.085	0.22	1,100	ELXV630E□□391ML20S		180	16×20	0.11	0.30	1,240	ELXV101E□□181ML20S
	470	12.5×35	0.063	0.16	1,390	ELXV630E□□471MK35S		220	12.5×35	0.087	0.24	1,450	ELXV101E□□221MK35S
	470	16×25	0.055	0.14	1,480	ELXV630E□□471ML25S		220	16×25	0.081	0.22	1,440	ELXV101E□□221ML25S
	560	12.5×40	0.051	0.13	1,530	ELXV630E□□561MK40S		270	12.5×40	0.060	0.17	1,610	ELXV101E□□271MK40S
	560	18×20	0.085	0.22	1,170	ELXV630E□□561MM20S		270	18×20	0.085	0.23	1,450	ELXV101E□□271MM20S
	680	16×30	0.046	0.12	1,720	ELXV630E□□681ML30S		330	16×30	0.058	0.16	1,790	ELXV101E□□331ML30S
680	18×25	0.055	0.14	1,520	ELXV630E□□681MM25S	330	18×25	0.070	0.19	1,650	ELXV101E□□331MM25S		
820	16×35	0.040	0.10	1,910	ELXV630E□□821ML35S	390	16×35	0.052	0.14	2,000	ELXV101E□□391ML35S		
820	18×30	0.046	0.12	1,770	ELXV630E□□821MM30S	390	18×30	0.058	0.16	1,850	ELXV101E□□391MM30S		
1,000	16×40	0.036	0.09	2,070	ELXV630E□□102ML40S	470	16×40	0.041	0.11	2,200	ELXV101E□□471ML40S		
1,000	18×35	0.040	0.10	1,970	ELXV630E□□102MM35S	560	18×35	0.052	0.14	1,990	ELXV101E□□561MM35S		
1,200	18×40	0.036	0.09	2,130	ELXV630E□□122MM40S	680	18×40	0.041	0.11	2,370	ELXV101E□□681MM40S		
80	8.2	5×11.5	1.9	5.1	100	ELXV800E□□8R2MEB5D							
	18	6.3×11.5	1.1	3.0	150	ELXV800E□□180MFB5D							

□ □ : Enter the appropriate lead forming or taping code.
 Production of the products shown in [] is scheduled to be discontinued.

◆RATED RIPPLE CURRENT MULTIPLIERS

● Frequency Multipliers

Rated voltage (V _{dc})	Case size φD (mm)	Frequency (Hz)				Rated voltage (V _{dc})	Case size φD (mm)	Frequency (Hz)			
		120	1k	10k	100k			120	1k	10k	100k
6.3 & 10	5 to 8	0.65	0.83	0.95	1.00	35 & 50	5 to 8	0.40	0.66	0.85	1.00
	10 & 12.5	0.70	0.85	0.96	1.00		10 & 12.5	0.50	0.73	0.89	1.00
	16 & 18	0.85	0.92	0.97	1.00		16 & 18	0.60	0.81	0.94	1.00
16 & 25	5 to 8	0.55	0.76	0.91	1.00	63 to 100	5 to 8	0.20	0.55	0.80	1.00
	10 & 12.5	0.65	0.83	0.93	1.00		10 & 12.5	0.35	0.65	0.85	1.00
	16 & 18	0.70	0.87	0.96	1.00		16 & 18	0.50	0.75	0.90	1.00

The deterioration of aluminum electrolytic capacitors accelerates their life due to the internal heating produced by ripple current.

For details, refer to Section "5-3 Ripple Current Effect on Lifetime" in the catalog, Technical Note.



KXQ Series

KXJ → Downsized → KXQ



- Ideal for on-board charger
- Downsized from KXJ series
- Rated voltage range : 400 to 450V_{dc}, Capacitance range : 47 to 180μF
- Endurance with ripple current : 10,000 to 12,000 hours at 105°C
- Non solvent resistant type
- RoHS2 Compliant
- AEC-Q200 compliant : Please contact Chemi-Con for more details, test data, information.

◆ SPECIFICATIONS

Items	Characteristics	
Category	-40 to +105°C	
Temperature Range	-40 to +105°C	
Rated Voltage Range	400 to 450V _{dc}	
Capacitance Tolerance	±20% (M) (at 20°C, 120Hz)	
Leakage Current	I=0.04CV+100 (after 1 minute) I=0.02CV+25 (after 5 minutes) Where, I : Max. leakage current(μA), C : Nominal capacitance (μF), V : Rated voltage (V) (at 20°C)	
Dissipation Factor (tan δ)	Rated voltage (V _{dc})	400 to 450V
	tan δ (Max.)	0.30 (at 20°C, 120Hz)
Low Temperature Characteristics (Max. Impedance Ratio)	Rated voltage (V _{dc})	400 to 450V
	Z(-25°C)/Z(+20°C)	6 (at 120Hz)
Endurance	The following specifications shall be satisfied when the capacitors are restored to 20°C after subjected to DC voltage with the rated ripple current is applied (the peak voltage shall not exceed the rated voltage) for 12,000 hours (10,000 hours for 25L and less) at 105°C.	
	Capacitance change	≤ ±20% of the initial value
	D.F. (tan δ)	≤ 200% of the initial specified value
	Leakage current	≤ The initial specified value
Shelf Life	The following specifications shall be satisfied when the capacitors are restored to 20°C after exposing them for 1,000 hours at 105°C without voltage applied. Before the measurement, the capacitor shall be preconditioned by applying voltage according to Item 4.1 of JIS C 5101-4.	
	Capacitance change	≤ ±20% of the initial value
	D.F. (tan δ)	≤ 200% of the initial specified value
	Leakage current	≤ 500% of the initial specified value

◆ DIMENSIONS [mm]

● Terminal Code : E

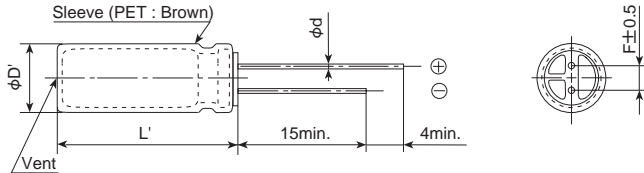

φD	16	18
φd	0.8	0.8
F	7.5	7.5
φD'	φD+0.5 max.	
L'	L+2.0 max.	

◆ PART NUMBERING SYSTEM

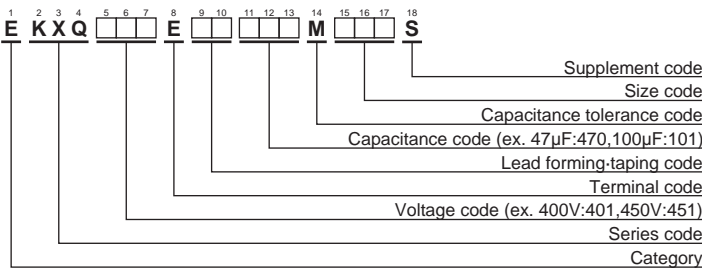

Please refer to "Product code guide (radial lead type)"



KXQ Series

◆ STANDARD RATINGS

WV (V _{dc})	Cap (μF)	Case size φD×L(mm)	tan δ	Rated ripple current (mA _{rms} /105°C, 120Hz)	Part No.	WV (V _{dc})	Cap (μF)	Case size φD×L(mm)	tan δ	Rated ripple current (mA _{rms} /105°C, 120Hz)	Part No.
400	56	16×20	0.30	450	EKXQ401E□□560ML20S	450	47	16×20	0.30	400	EKXQ451E□□470ML20S
	68	18×20	0.30	530	EKXQ401E□□680MM20S		62	16×25	0.30	510	EKXQ451E□□620ML25S
	75	16×25	0.30	580	EKXQ401E□□750ML25S		62	18×20	0.30	510	EKXQ451E□□620MM20S
	100	16×31.5	0.30	730	EKXQ401E□□101MLN3S		82	16×31.5	0.30	650	EKXQ451E□□820MLN3S
	100	18×25	0.30	660	EKXQ401E□□101MM25S		82	18×25	0.30	640	EKXQ451E□□820MM25S
	120	16×35.5	0.30	830	EKXQ401E□□121MLP1S		100	16×35.5	0.30	750	EKXQ451E□□101MLP1S
	130	16×40	0.30	910	EKXQ401E□□131ML40S		110	18×31.5	0.30	800	EKXQ451E□□111MMN3S
	130	18×31.5	0.30	860	EKXQ401E□□131MMN3S		120	16×40	0.30	860	EKXQ451E□□121ML40S
	160	18×35.5	0.30	980	EKXQ401E□□161MMP1S		130	18×35.5	0.30	920	EKXQ451E□□131MMP1S
	180	18×40	0.30	1,020	EKXQ401E□□181MM40S		160	18×40	0.30	980	EKXQ451E□□161MM40S
180	18×45	0.30	1,080	EKXQ401E□□181MM45S	180	18×45	0.30	1,000	EKXQ451E□□181MM45S		
420	51	16×20	0.30	400	EKXQ421E□□510ML20S						
	68	16×25	0.30	510	EKXQ421E□□680ML25S						
	68	18×20	0.30	510	EKXQ421E□□680MM20S						
	91	16×31.5	0.30	650	EKXQ421E□□910MLN3S						
	91	18×25	0.30	640	EKXQ421E□□910MM25S						
	110	16×35.5	0.30	750	EKXQ421E□□111MLP1S						
	120	18×31.5	0.30	800	EKXQ421E□□121MMN3S						
	130	16×40	0.30	860	EKXQ421E□□131ML40S						
	150	18×35.5	0.30	920	EKXQ421E□□151MMP1S						
	160	18×40	0.30	980	EKXQ421E□□161MM40S						
180	18×45	0.30	1,000	EKXQ421E□□181MM45S							

□ □ : Enter the appropriate lead forming or taping code.

◆ RATED RIPPLE CURRENT MULTIPLIERS

● Frequency Multipliers

Capacitance(μF)	Frequency(Hz)			
	120	1k	10k	100k
47 to 91	1.00	1.50	1.90	2.00
100 to 180	1.00	1.40	1.65	1.70

The deterioration of aluminum electrolytic capacitors accelerates their life due to the internal heating produced by ripple current. For details, refer to Section "5-3 Ripple Current Effect on Lifetime" in the catalog, Technical Note.

KXN Series

KXL → Downsized → KXN



- Ideal for low profile power supply applications
- Downsized from KXL series
- Rated voltage range : 350 to 450V_{dc}, Capacitance range : 15 to 330μF
- Endurance with ripple current : 10,000 to 12,000 hours at 105°C
- Non solvent resistant type
- RoHS2 Compliant

◆ SPECIFICATIONS

Items	Characteristics	
Category	-40 to +105°C	
Temperature Range		
Rated Voltage Range	350 to 450V _{dc}	
Capacitance Tolerance	±20% (M) (at 20°C, 120Hz)	
Leakage Current	I=0.04CV+100 (after 1 minute) I=0.02CV+25 (after 5 minutes) Where, I : Max. leakage current(μA), C : Nominal capacitance (μF), V : Rated voltage (V) (at 20°C)	
Dissipation Factor (tan δ)	Rated voltage (V _{dc})	350 to 450V
	tan δ (Max.)	0.24 (at 20°C, 120Hz)
Low Temperature Characteristics (Max. Impedance Ratio)	Rated voltage (V _{dc})	350 to 450V
	Z(-25°C)/Z(+20°C)	6
	Z(-40°C)/Z(+20°C)	10 (at 120Hz)
Endurance	The following specifications shall be satisfied when the capacitors are restored to 20°C after subjected to DC voltage with the rated ripple current is applied (the peak voltage shall not exceed the rated voltage) for 12,000 hours (10,000 hours for 20L and less) at 105°C.	
	Capacitance change	≤ ±20% of the initial value
	D.F. (tan δ)	≤200% of the initial specified value
	Leakage current	≤The initial specified value
Shelf Life	The following specifications shall be satisfied when the capacitors are restored to 20°C after exposing them for 1,000 hours at 105°C without voltage applied. Before the measurement, the capacitor shall be preconditioned by applying voltage according to Item 4.1 of JIS C 5101-4.	
	Capacitance change	≤ ±20% of the initial value
	D.F. (tan δ)	≤200% of the initial specified value
	Leakage current	≤500% of the initial specified value

◆ DIMENSIONS [mm]

- Terminal Code : E

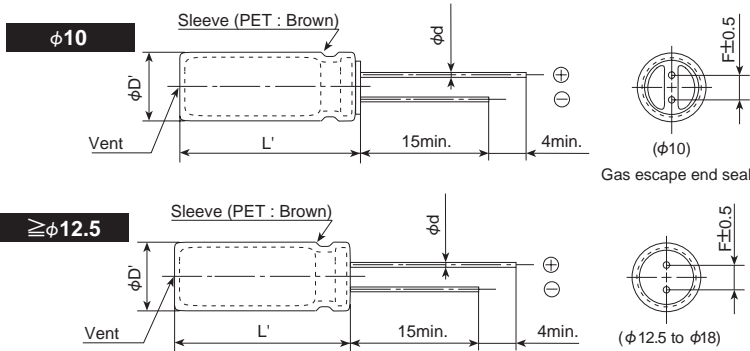

◆ PART NUMBERING SYSTEM

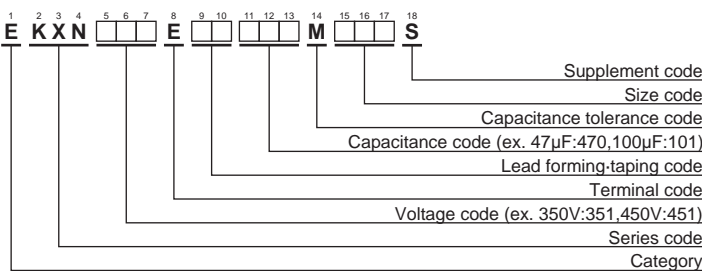

Please refer to "Product code guide (radial lead type)"



◆STANDARD RATINGS

WV (V _{dc})	Cap (μF)	Case size φD×L(mm)	tan δ	Rated ripple current (mA _{rms} /105°C, 120Hz)	Part No.	WV (V _{dc})	Cap (μF)	Case size φD×L(mm)	tan δ	Rated ripple current (mA _{rms} /105°C, 120Hz)	Part No.
350	18	10×16	0.24	205	EKXN351E□□180MJ16S	420	15	10×16	0.24	185	EKXN421E□□150MJ16S
	27	10×20	0.24	270	EKXN351E□□270MJ20S		22	10×20	0.24	245	EKXN421E□□220MJ20S
	33	10×25	0.24	325	EKXN351E□□330MJ25S		27	10×25	0.24	295	EKXN421E□□270MJ25S
	33	12.5×16	0.24	315	EKXN351E□□330MK16S		27	12.5×16	0.24	285	EKXN421E□□270MK16S
	47	10×30	0.24	420	EKXN351E□□470MJ30S		33	10×30	0.24	350	EKXN421E□□330MJ30S
	47	12.5×20	0.24	420	EKXN351E□□470MK20S		39	10×35	0.24	405	EKXN421E□□390MJ35S
	56	10×35	0.24	485	EKXN351E□□560MJ35S		39	12.5×20	0.24	380	EKXN421E□□390MK20S
	56	16×16	0.24	475	EKXN351E□□560ML16S		39	16×16	0.24	400	EKXN421E□□390ML16S
	68	10×40	0.24	560	EKXN351E□□680MJ40S		47	10×40	0.24	465	EKXN421E□□470MJ40S
	68	10×45	0.24	580	EKXN351E□□680MJ45S		56	10×45	0.24	530	EKXN421E□□560MJ45S
	68	12.5×25	0.24	550	EKXN351E□□680MK25S		56	10×50	0.24	545	EKXN421E□□560MJ50S
	68	18×16	0.24	550	EKXN351E□□680MM16S		56	12.5×25	0.24	500	EKXN421E□□560MK25S
	82	10×50	0.24	660	EKXN351E□□820MJ50S		56	18×16	0.24	500	EKXN421E□□560MM16S
	82	12.5×30	0.24	640	EKXN351E□□820MK30S		68	12.5×30	0.24	585	EKXN421E□□680MK30S
	82	16×20	0.24	615	EKXN351E□□820ML20S		68	16×20	0.24	560	EKXN421E□□680ML20S
	100	12.5×35	0.24	745	EKXN351E□□101MK35S		82	12.5×35	0.24	675	EKXN421E□□820MK35S
	100	12.5×40	0.24	775	EKXN351E□□101MK40S		82	12.5×40	0.24	705	EKXN421E□□820MK40S
	100	18×20	0.24	715	EKXN351E□□101MM20S		82	16×25	0.24	670	EKXN421E□□820ML25S
	120	12.5×45	0.24	880	EKXN351E□□121MK45S		82	18×20	0.24	645	EKXN421E□□820MM20S
	120	16×25	0.24	810	EKXN351E□□121ML25S		100	12.5×45	0.24	805	EKXN421E□□101MK45S
	120	16×30	0.24	870	EKXN351E□□121ML30S		100	16×30	0.24	795	EKXN421E□□101ML30S
	150	12.5×50	0.24	1,010	EKXN351E□□151MK50S		120	12.5×50	0.24	905	EKXN421E□□121MK50S
	150	18×25	0.24	930	EKXN351E□□151MM25S		120	16×35	0.24	890	EKXN421E□□121ML35S
	180	16×35	0.24	1,090	EKXN351E□□181ML35S		120	18×25	0.24	830	EKXN421E□□121MM25S
	180	16×40	0.24	1,120	EKXN351E□□181ML40S		150	16×40	0.24	1,030	EKXN421E□□151ML40S
	180	18×30	0.24	1,090	EKXN351E□□181MM30S		150	18×30	0.24	995	EKXN421E□□151MM30S
	220	16×45	0.24	1,270	EKXN351E□□221ML45S		180	16×45	0.24	1,140	EKXN421E□□181ML45S
220	18×35	0.24	1,250	EKXN351E□□221MM35S	180	16×50	0.24	1,160	EKXN421E□□181ML50S		
220	18×40	0.24	1,280	EKXN351E□□221MM40S	180	18×35	0.24	1,130	EKXN421E□□181MM35S		
270	16×50	0.24	1,430	EKXN351E□□271ML50S	180	18×40	0.24	1,160	EKXN421E□□181MM40S		
270	18×45	0.24	1,450	EKXN351E□□271MM45S	220	18×45	0.24	1,310	EKXN421E□□221MM45S		
330	18×50	0.24	1,600	EKXN351E□□331MM50S	270	18×50	0.24	1,450	EKXN421E□□271MM50S		
400	15	10×16	0.24	185	EKXN401E□□150MJ16S	450	15	10×16	0.24	185	EKXN451E□□150MJ16S
	22	10×20	0.24	245	EKXN401E□□220MJ20S		18	10×20	0.24	220	EKXN451E□□180MJ20S
	27	10×25	0.24	295	EKXN401E□□270MJ25S		22	12.5×16	0.24	255	EKXN451E□□220MK16S
	27	12.5×16	0.24	285	EKXN401E□□270MK16S		27	10×25	0.24	295	EKXN451E□□270MJ25S
	39	10×30	0.24	385	EKXN401E□□390MJ30S		33	10×30	0.24	360	EKXN451E□□330MJ30S
	39	12.5×20	0.24	380	EKXN401E□□390MK20S		33	12.5×20	0.24	350	EKXN451E□□330MK20S
	47	10×35	0.24	445	EKXN401E□□470MJ35S		39	10×35	0.24	410	EKXN451E□□390MJ35S
	47	16×16	0.24	435	EKXN401E□□470ML16S		39	16×16	0.24	400	EKXN451E□□390ML16S
	56	10×40	0.24	505	EKXN401E□□560MJ40S		47	10×40	0.24	465	EKXN451E□□470MJ40S
	56	10×45	0.24	530	EKXN401E□□560MJ45S		47	10×45	0.24	485	EKXN451E□□470MJ45S
	56	12.5×25	0.24	500	EKXN401E□□560MK25S		47	12.5×25	0.24	455	EKXN451E□□470MK25S
	56	18×16	0.24	500	EKXN401E□□560MM16S		47	18×16	0.24	455	EKXN451E□□470MM16S
	68	10×50	0.24	600	EKXN401E□□680MJ50S		56	10×50	0.24	545	EKXN451E□□560MJ50S
	68	12.5×30	0.24	585	EKXN401E□□680MK30S		56	12.5×30	0.24	530	EKXN451E□□560MK30S
	68	16×20	0.24	560	EKXN401E□□680ML20S		56	16×20	0.24	510	EKXN451E□□560ML20S
	82	12.5×35	0.24	675	EKXN401E□□820MK35S		68	12.5×35	0.24	615	EKXN451E□□680MK35S
	82	18×20	0.24	645	EKXN401E□□820MM20S		82	12.5×40	0.24	705	EKXN451E□□820MK40S
	100	12.5×40	0.24	775	EKXN401E□□101MK40S		82	12.5×45	0.24	725	EKXN451E□□820MK45S
	100	12.5×45	0.24	805	EKXN401E□□101MK45S		82	16×25	0.24	670	EKXN451E□□820ML25S
	100	16×25	0.24	740	EKXN401E□□101ML25S		82	18×20	0.24	645	EKXN451E□□820MM20S
	120	12.5×50	0.24	905	EKXN401E□□121MK50S		100	12.5×50	0.24	825	EKXN451E□□101MK50S
	120	16×30	0.24	870	EKXN401E□□121ML30S		100	16×30	0.24	795	EKXN451E□□101ML30S
	120	18×25	0.24	830	EKXN401E□□121MM25S		100	18×25	0.24	760	EKXN451E□□101MM25S
	150	16×35	0.24	995	EKXN401E□□151ML35S		120	16×35	0.24	890	EKXN451E□□121ML35S
	150	16×40	0.24	1,030	EKXN401E□□151ML40S		120	16×40	0.24	920	EKXN451E□□121ML40S
	150	18×30	0.24	995	EKXN401E□□151MM30S		120	18×30	0.24	890	EKXN451E□□121MM30S
	180	16×45	0.24	1,140	EKXN401E□□181ML45S		150	16×45	0.24	1,040	EKXN451E□□151ML45S
180	18×35	0.24	1,130	EKXN401E□□181MM35S	150	18×35	0.24	1,030	EKXN451E□□151MM35S		
220	16×50	0.24	1,290	EKXN401E□□221ML50S	180	16×50	0.24	1,160	EKXN451E□□181ML50S		
220	18×40	0.24	1,280	EKXN401E□□221MM40S	180	18×40	0.24	1,160	EKXN451E□□181MM40S		
220	18×45	0.24	1,310	EKXN401E□□221MM45S	180	18×45	0.24	1,180	EKXN451E□□181MM45S		
270	18×50	0.24	1,450	EKXN401E□□271MM50S	220	18×50	0.24	1,310	EKXN451E□□221MM50S		

□ □ : Enter the appropriate lead forming or taping code.

◆RATED RIPPLE CURRENT MULTIPLIERS

●Frequency Multipliers

Capacitance(μF)	Frequency(Hz)			
	120	1k	10k	100k
15 to 82	1.00	1.75	2.25	2.50
100 to 330	1.00	1.67	2.05	2.25

The deterioration of aluminum electrolytic capacitors accelerates their life due to the internal heating produced by ripple current. For details, refer to Section "5-3 Ripple Current Effect on Lifetime" in the catalog, Technical Note.

KXL Series

- Ideal for low profile power supply applications
- Downsized from KXJ series
- Rated voltage range : 400 to 450V_{dc}, Capacitance range : 15 to 150μF
- Endurance with ripple current : 10,000 to 12,000 hours at 105°C
- Non solvent resistant type
- RoHS2 Compliant

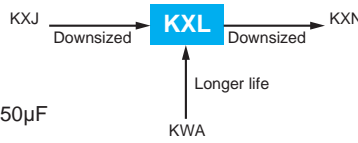

SPECIFICATIONS

Items	Characteristics	
Category	-40 to +105°C	
Temperature Range		
Rated Voltage Range	400 to 450V _{dc}	
Capacitance Tolerance	±20% (M) (at 20°C, 120Hz)	
Leakage Current	I=0.04CV+100 (after 1 minute) I=0.02CV+25 (after 5 minutes) Where, I : Max. leakage current(μA), C : Nominal capacitance (μF), V : Rated voltage (V) (at 20°C)	
Dissipation Factor (tan δ)	Rated voltage (V _{dc})	400 to 450V
	tan δ (Max.)	0.24 (at 20°C, 120Hz)
Low Temperature Characteristics (Max. Impedance Ratio)	Rated voltage (V _{dc})	400 to 450V
	Z(-25°C)/Z(+20°C)	6
	Z(-40°C)/Z(+20°C)	10 (at 120Hz)
Endurance	The following specifications shall be satisfied when the capacitors are restored to 20°C after subjected to DC voltage with the rated ripple current is applied (the peak voltage shall not exceed the rated voltage) for 12,000 hours (10,000 hours for 20L) at 105°C.	
	Capacitance change	≤ ±20% of the initial value
	D.F. (tan δ)	≤200% of the initial specified value
	Leakage current	≤The initial specified value
Shelf Life	The following specifications shall be satisfied when the capacitors are restored to 20°C after exposing them for 1,000 hours at 105°C without voltage applied. Before the measurement, the capacitor shall be preconditioned by applying voltage according to Item 4.1 of JIS C 5101-4.	
	Capacitance change	≤ ±20% of the initial value
	D.F. (tan δ)	≤200% of the initial specified value
	Leakage current	≤500% of the initial specified value

DIMENSIONS [mm]

- Terminal Code : E

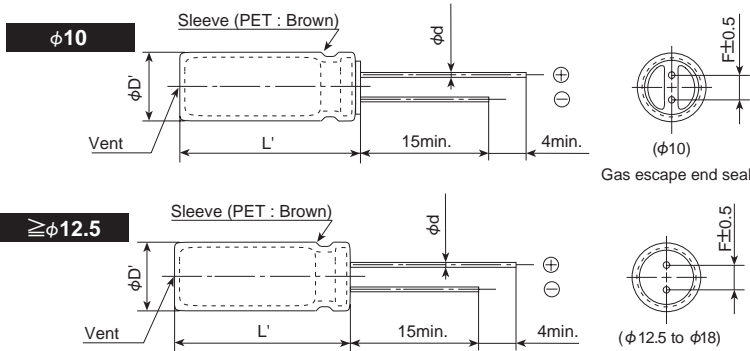

φD	10	12.5	14.5	16	18
φd	0.6	0.6	0.8	0.8	0.8
F	5.0	5.0	7.5	7.5	7.5
φD'	φD+0.5 max.				
L'	L+2.0 max.				

PART NUMBERING SYSTEM

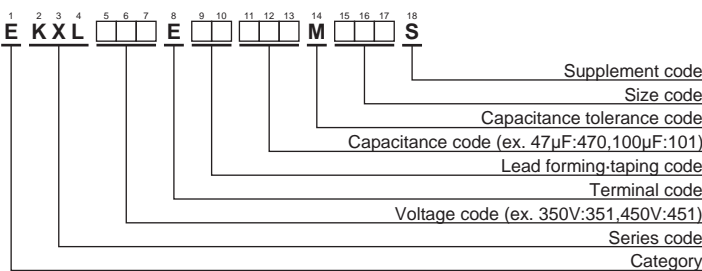

Please refer to "Product code guide (radial lead type)"



◆STANDARD RATINGS

WV (V _{dc})	Cap (μF)	Case size φD×L(mm)	tan δ	Rated ripple current (mA _{rms} /105°C, 120Hz)	Part No.	WV (V _{dc})	Cap (μF)	Case size φD×L(mm)	tan δ	Rated ripple current (mA _{rms} /105°C, 120Hz)	Part No.
400	18	10×20	0.24	220	EKXL401E□□180MJ20S	450	15	10×20	0.24	190	EKXL451E□□150MJ20S
	22	10×25	0.24	250	EKXL401E□□220MJ25S		18	10×25	0.24	230	EKXL451E□□180MJ25S
	27	12.5×20	0.24	300	EKXL401E□□270MK20S		27	10×30	0.24	300	EKXL451E□□270MJ30S
	33	10×30	0.24	340	EKXL401E□□330MJ30S		27	12.5×20	0.24	290	EKXL451E□□270MK20S
	39	10×35	0.24	390	EKXL401E□□390MJ35S		33	10×35	0.24	350	EKXL451E□□330MJ35S
	39	12.5×25	0.24	390	EKXL401E□□390MK25S		33	12.5×25	0.24	360	EKXL451E□□330MK25S
	39	14.5×20	0.24	370	EKXL401E□□390MU20S		33	14.5×20	0.24	335	EKXL451E□□330MU20S
	47	10×40	0.24	440	EKXL401E□□470MJ40S		39	10×40	0.24	400	EKXL451E□□390MJ40S
	56	10×45	0.24	500	EKXL401E□□560MJ45S		39	16×20	0.24	400	EKXL451E□□390ML20S
	56	12.5×30	0.24	495	EKXL401E□□560MK30S		47	10×50	0.24	480	EKXL451E□□470MJ50S
	56	14.5×25	0.24	495	EKXL401E□□560MK25S		47	12.5×30	0.24	440	EKXL451E□□470MK30S
	56	16×20	0.24	480	EKXL401E□□560ML20S		47	14.5×25	0.24	450	EKXL451E□□470MU25S
	68	12.5×35	0.24	570	EKXL401E□□680MK35S		56	12.5×35	0.24	500	EKXL451E□□560MK35S
	68	14.5×30	0.24	585	EKXL401E□□680MU30S		56	14.5×30	0.24	540	EKXL451E□□560MU30S
	68	16×25	0.24	570	EKXL401E□□680ML25S		56	16×25	0.24	500	EKXL451E□□560ML25S
	68	18×20	0.24	530	EKXL401E□□680MM20S		56	18×20	0.24	500	EKXL451E□□560MM20S
	82	12.5×40	0.24	650	EKXL401E□□820MK40S		68	12.5×40	0.24	580	EKXL451E□□680MK40S
	82	14.5×35	0.24	670	EKXL401E□□820MU35S		68	14.5×35	0.24	620	EKXL451E□□680MU35S
	100	12.5×50	0.24	760	EKXL401E□□101MK50S		82	12.5×50	0.24	680	EKXL451E□□820MK50S
	100	14.5×40	0.24	760	EKXL401E□□101MU40S		82	14.5×40	0.24	670	EKXL451E□□820MU40S
100	16×30	0.24	720	EKXL401E□□101ML30S	82	16×30	0.24	650	EKXL451E□□820ML30S		
100	18×25	0.24	710	EKXL401E□□101MM25S	82	18×25	0.24	650	EKXL451E□□820MM25S		
120	14.5×45	0.24	840	EKXL401E□□121MU45S	100	14.5×45	0.24	760	EKXL451E□□101MU45S		
120	16×35	0.24	810	EKXL401E□□121ML35S	100	16×35	0.24	730	EKXL451E□□101ML35S		
120	18×30	0.24	840	EKXL401E□□121MM30S	100	18×30	0.24	750	EKXL451E□□101MM30S		
150	18×35	0.24	930	EKXL401E□□151MM35S	120	18×35	0.24	860	EKXL451E□□121MM35S		
420	15	10×20	0.24	195	EKXL421E□□150MJ20S						
	22	10×25	0.24	250	EKXL421E□□220MJ25S						
	27	10×30	0.24	300	EKXL421E□□270MJ30S						
	27	12.5×20	0.24	300	EKXL421E□□270MK20S						
	33	10×35	0.24	350	EKXL421E□□330MJ35S						
	33	12.5×25	0.24	350	EKXL421E□□330MK25S						
	33	14.5×20	0.24	350	EKXL421E□□330MU20S						
	39	10×40	0.24	400	EKXL421E□□390MJ40S						
	47	10×45	0.24	460	EKXL421E□□470MJ45S						
	47	12.5×30	0.24	440	EKXL421E□□470MK30S						
	47	16×20	0.24	430	EKXL421E□□470ML20S						
	56	10×50	0.24	520	EKXL421E□□560MJ50S						
	56	12.5×35	0.24	510	EKXL421E□□560MK35S						
	56	14.5×25	0.24	490	EKXL421E□□560MU25S						
	68	12.5×40	0.24	580	EKXL421E□□680MK40S						
	68	14.5×30	0.24	560	EKXL421E□□680MU30S						
	68	16×25	0.24	560	EKXL421E□□680ML25S						
	68	18×20	0.24	540	EKXL421E□□680MM20S						
	82	12.5×45	0.24	660	EKXL421E□□820MK45S						
	82	14.5×35	0.24	660	EKXL421E□□820MU35S						
82	16×30	0.24	650	EKXL421E□□820ML30S							
82	18×25	0.24	640	EKXL421E□□820MM25S							
100	12.5×50	0.24	750	EKXL421E□□101MK50S							
100	14.5×40	0.24	720	EKXL421E□□101MU40S							
100	16×35	0.24	730	EKXL421E□□101ML35S							
120	16×40	0.24	840	EKXL421E□□121ML40S							
120	18×30	0.24	800	EKXL421E□□121MM30S							

□□ : Enter the appropriate lead forming or taping code.

◆RATED RIPPLE CURRENT MULTIPLIERS

● Frequency Multipliers

Capacitance(μF)	Frequency(Hz)	120	1k	10k	100k
15 to 82		1.00	1.75	2.25	2.50
100 to 150		1.00	1.67	2.05	2.25

The deterioration of aluminum electrolytic capacitors accelerates their life due to the internal heating produced by ripple current. For details, refer to Section "5-3 Ripple Current Effect on Lifetime" in the catalog, Technical Note.

KXJ Series

- Downsized and Longer life from current KXG series
- Endurance with ripple current : 8,000 to 12,000 hours at 105°C
- Rated voltage range : 160 to 500V, Capacitance range : 6.8 to 680μF
- For electronic ballast circuits and other long life applications
- Non solvent resistant type
- RoHS2 Compliant
- AEC-Q200 compliant : Please contact Chemi-Con for more details, test data, information.

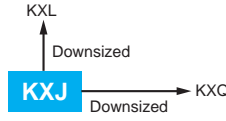

SPECIFICATIONS

Items	Characteristics			
Category	-40 to +105°C (160 to 450V _{dc}) -25 to +105°C (500V _{dc})			
Temperature Range				
Rated Voltage Range	160 to 500V _{dc}			
Capacitance Tolerance	±20% (M) (at 20°C, 120Hz)			
Leakage Current		After 1 minute	After 5 minutes	
	CV ≤ 1000	I = 0.1CV + 40	I = 0.03CV + 15	
	CV > 1000	I = 0.04CV + 100	I = 0.02CV + 25	
	Where, I : Max. leakage current (μA), C : Nominal capacitance (μF), V : Rated voltage (V) (at 20°C)			
Dissipation Factor (tan δ)	Rated voltage (V _{dc})	160 to 250V	350 to 500V	
	tan δ (Max.)	0.20	0.24	(at 20°C, 120Hz)
Low Temperature Characteristics (Max. Impedance Ratio)	Rated voltage (V _{dc})	160 to 250V	350, 400V	420 to 500V
	Z(-25°C)/Z(+20°C)	3	5	6
	Z(-40°C)/Z(+20°C)	6	6	—
	(at 120Hz)			
Endurance	The following specifications shall be satisfied when the capacitors are restored to 20°C after subjected to DC voltage with the rated ripple current is applied (the peak voltage shall not exceed the rated voltage) for the specified time at 105°C.			
	Rated voltage (V _{dc})	160 to 450V		500V
	Time	16L to 20L : 10,000hours, 25L to 50L : 12,000hours		φ10 : 8,000hours, φ12.5 to φ18 : 10,000hours
	Capacitance change	≤ ±20% of the initial value		
	D.F. (tan δ)	≤ 200% of the initial specified value		
	Leakage current	≤ The initial specified value		
Shelf Life	The following specifications shall be satisfied when the capacitors are restored to 20°C after exposing them for 1,000 hours at 105°C without voltage applied. Before the measurement, the capacitor shall be preconditioned by applying voltage according to Item 4.1 of JIS C 5101-4.			
	Capacitance change	≤ ±20% of the initial value		
	D.F. (tan δ)	≤ 200% of the initial specified value		
	Leakage current	≤ 500% of the initial specified value		

DIMENSIONS [mm]

Terminal Code : E

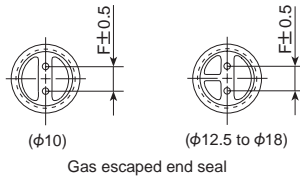
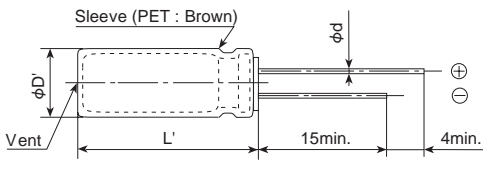

φD	10	12.5	14.5	16	18
φd	0.6	0.6	0.8	0.8	0.8
F	5.0	5.0	7.5	7.5	7.5
φD'	φD + 0.5max.				
L'	L + 1.5max.				

Gas escaped end seal

PART NUMBERING SYSTEM

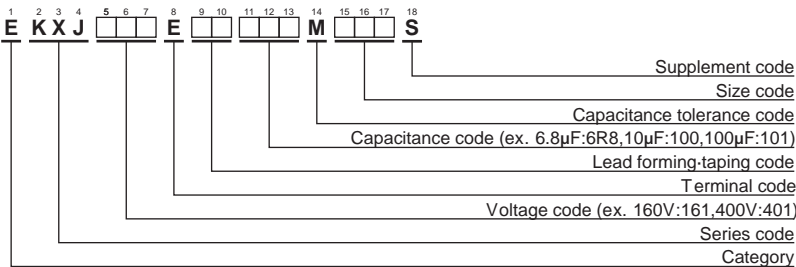

Please refer to "Product code guide (radial lead type)"



◆STANDARD RATINGS

VV (V _{dc})	Cap (μF)	Case size φD×L(mm)	tan δ	Rated ripple current (mA rms/105°C, 120Hz)	Part No.	VV (V _{dc})	Cap (μF)	Case size φD×L(mm)	tan δ	Rated ripple current (mA rms/105°C, 120Hz)	Part No.
160	39	10×16	0.20	245	EKXJ161E□□390MJ16S	220	27	10×16	0.20	200	EKXJ221E□□270MJ16S
	56	10×20	0.20	315	EKXJ161E□□560MJ20S		39	10×20	0.20	265	EKXJ221E□□390MJ20S
	82	10×25	0.20	415	EKXJ161E□□820MJ25S		56	10×25	0.20	345	EKXJ221E□□560MJ25S
	82	10×30	0.20	445	EKXJ161E□□820MJ30S		56	10×30	0.20	370	EKXJ221E□□560MJ30S
	100	12.5×20	0.20	575	EKXJ161E□□101MK20S		68	12.5×20	0.20	475	EKXJ221E□□680MK20S
	120	10×35	0.20	570	EKXJ161E□□121MJ35S		82	10×35	0.20	470	EKXJ221E□□820MJ35S
	120	14.5×20	0.20	675	EKXJ161E□□121MU20S		82	14.5×20	0.20	555	EKXJ221E□□820MU20S
	150	10×40	0.20	665	EKXJ161E□□151MJ40S		100	10×40	0.20	545	EKXJ221E□□101MJ40S
	150	10×45	0.20	695	EKXJ161E□□151MJ45S		100	10×45	0.20	565	EKXJ221E□□101MJ45S
	150	12.5×25	0.20	765	EKXJ161E□□151MK25S		100	12.5×25	0.20	625	EKXJ221E□□101MK25S
	180	10×50	0.20	785	EKXJ161E□□181MJ50S		120	10×50	0.20	645	EKXJ221E□□121MJ50S
	180	12.5×30	0.20	885	EKXJ161E□□181MK30S		120	12.5×30	0.20	725	EKXJ221E□□121MK30S
	180	14.5×25	0.20	890	EKXJ161E□□181MU25S		120	14.5×25	0.20	725	EKXJ221E□□121MU25S
	180	16×20	0.20	855	EKXJ161E□□181ML20S		120	16×20	0.20	695	EKXJ221E□□121ML20S
	220	12.5×35	0.20	1,040	EKXJ161E□□221MK35S		150	12.5×35	0.20	860	EKXJ221E□□151MK35S
	220	16×25	0.20	1,020	EKXJ161E□□221ML25S		150	16×25	0.20	845	EKXJ221E□□151ML25S
	220	18×20	0.20	990	EKXJ161E□□221MM20S		150	18×20	0.20	815	EKXJ221E□□151MM20S
	270	12.5×40	0.20	1,190	EKXJ161E□□271MK40S		180	12.5×40	0.20	975	EKXJ221E□□181MK40S
	270	12.5×45	0.20	1,230	EKXJ161E□□271MK45S		180	12.5×45	0.20	1,005	EKXJ221E□□181MK45S
	270	14.5×31.5	0.20	1,170	EKXJ161E□□271MUN3S		180	14.5×31.5	0.20	955	EKXJ221E□□181MUN3S
	270	14.5×35.5	0.20	1,210	EKXJ161E□□271MUP1S		220	12.5×50	0.20	1,145	EKXJ221E□□221MK50S
	330	12.5×50	0.20	1,400	EKXJ161E□□331MK50S		220	14.5×35.5	0.20	1,095	EKXJ221E□□221MUP1S
	330	14.5×40	0.20	1,385	EKXJ161E□□331MU40S		220	14.5×40	0.20	1,130	EKXJ221E□□221MU40S
	330	16×31.5	0.20	1,350	EKXJ161E□□331MLN3S		220	16×31.5	0.20	1,100	EKXJ221E□□221MLN3S
	330	18×25	0.20	1,290	EKXJ161E□□331MM25S		220	18×25	0.20	1,050	EKXJ221E□□221MM25S
	390	14.5×45	0.20	1,545	EKXJ161E□□391MU45S		270	14.5×45	0.20	1,285	EKXJ221E□□271MU45S
	390	16×35.5	0.20	1,500	EKXJ161E□□391MLP1S		270	14.5×50	0.20	1,315	EKXJ221E□□271MU50S
	470	14.5×50	0.20	1,735	EKXJ161E□□471MU50S		270	16×35.5	0.20	1,245	EKXJ221E□□271MLP1S
	470	16×40	0.20	1,700	EKXJ161E□□471ML40S		270	18×31.5	0.20	1,260	EKXJ221E□□271MMN3S
	470	16×45	0.20	1,730	EKXJ161E□□471ML45S		330	16×40	0.20	1,425	EKXJ221E□□331ML40S
	470	18×31.5	0.20	1,660	EKXJ161E□□471MMN3S		330	16×45	0.20	1,450	EKXJ221E□□331ML45S
	470	18×35.5	0.20	1,715	EKXJ161E□□471MMP1S		330	18×35.5	0.20	1,440	EKXJ221E□□331MMP1S
	560	16×50	0.20	1,920	EKXJ161E□□561ML50S		390	16×50	0.20	1,600	EKXJ221E□□391ML50S
560	18×40	0.20	1,905	EKXJ161E□□561MM40S	390	18×40	0.20	1,590	EKXJ221E□□391MM40S		
680	18×45	0.20	2,130	EKXJ161E□□681MM45S	390	18×45	0.20	1,620	EKXJ221E□□391MM45S		
680	18×50	0.20	2,145	EKXJ161E□□681MM50S	470	18×50	0.20	1,785	EKXJ221E□□471MM50S		
200	27	10×16	0.20	200	EKXJ201E□□270MJ16S	250	22	10×16	0.20	185	EKXJ251E□□220MJ16S
	47	10×20	0.20	290	EKXJ201E□□470MJ20S		33	10×20	0.20	240	EKXJ251E□□330MJ20S
	56	10×25	0.20	345	EKXJ201E□□560MJ25S		47	10×25	0.20	315	EKXJ251E□□470MJ25S
	68	10×30	0.20	405	EKXJ201E□□680MJ30S		47	10×30	0.20	340	EKXJ251E□□470MJ30S
	82	12.5×20	0.20	520	EKXJ201E□□820MK20S		56	12.5×20	0.20	430	EKXJ251E□□560MK20S
	100	10×35	0.20	520	EKXJ201E□□101MJ35S		68	10×35	0.20	430	EKXJ251E□□680MJ35S
	100	12.5×25	0.20	625	EKXJ201E□□101MK25S		68	14.5×20	0.20	505	EKXJ251E□□680MU20S
	100	14.5×20	0.20	615	EKXJ201E□□101MU20S		82	10×40	0.20	495	EKXJ251E□□820MJ40S
	120	10×40	0.20	595	EKXJ201E□□121MJ40S		82	10×45	0.20	515	EKXJ251E□□820MJ45S
	120	10×45	0.20	620	EKXJ201E□□121MJ45S		82	12.5×25	0.20	565	EKXJ251E□□820MK25S
	120	12.5×30	0.20	725	EKXJ201E□□121MK30S		100	10×50	0.20	585	EKXJ251E□□101MJ50S
	120	16×20	0.20	695	EKXJ201E□□121ML20S		100	12.5×30	0.20	660	EKXJ251E□□101MK30S
	150	10×50	0.20	720	EKXJ201E□□151MJ50S		100	14.5×25	0.20	665	EKXJ251E□□101MJ25S
	150	12.5×35	0.20	860	EKXJ201E□□151MK35S		100	16×20	0.20	635	EKXJ251E□□101ML20S
	150	14.5×25	0.20	810	EKXJ201E□□151MU25S		120	12.5×35	0.20	770	EKXJ251E□□121MK35S
	180	14.5×31.5	0.20	955	EKXJ201E□□181MUN3S		120	16×25	0.20	755	EKXJ251E□□121ML25S
	180	16×25	0.20	925	EKXJ201E□□181ML25S		120	18×20	0.20	730	EKXJ251E□□121MM20S
	180	18×20	0.20	895	EKXJ201E□□181MM20S		150	12.5×40	0.20	890	EKXJ251E□□151MK40S
	220	12.5×40	0.20	1,075	EKXJ201E□□221MK40S		150	12.5×45	0.20	920	EKXJ251E□□151MK45S
	220	12.5×45	0.20	1,110	EKXJ201E□□221MK45S		150	14.5×31.5	0.20	870	EKXJ251E□□151MUN3S
	220	14.5×35.5	0.20	1,095	EKXJ201E□□221MUP1S		180	12.5×50	0.20	1,035	EKXJ251E□□181MK50S
	220	18×25	0.20	1,050	EKXJ201E□□221MM25S		180	14.5×35.5	0.20	990	EKXJ251E□□181MUP1S
	270	12.5×50	0.20	1,265	EKXJ201E□□271MK50S		180	14.5×40	0.20	1,020	EKXJ251E□□181MU40S
	270	14.5×40	0.20	1,250	EKXJ201E□□271MU40S		180	16×31.5	0.20	995	EKXJ251E□□181MLN3S
	270	14.5×45	0.20	1,290	EKXJ201E□□271MU45S		180	18×25	0.20	950	EKXJ251E□□181MM25S
	270	16×31.5	0.20	1,220	EKXJ201E□□271MLN3S		220	14.5×45	0.20	1,160	EKXJ251E□□221MU45S
	270	16×35.5	0.20	1,250	EKXJ201E□□271MLP1S		220	14.5×50	0.20	1,185	EKXJ251E□□221MU50S
	330	14.5×50	0.20	1,450	EKXJ201E□□331MU50S		220	16×35.5	0.20	1,125	EKXJ251E□□221MLP1S
	330	16×40	0.20	1,425	EKXJ201E□□331ML40S		220	18×31.5	0.20	1,135	EKXJ251E□□221MMN3S
	330	18×31.5	0.20	1,395	EKXJ201E□□331MMN3S		270	16×40	0.20	1,285	EKXJ251E□□271ML40S
	390	16×45	0.20	1,575	EKXJ201E□□391ML45S		270	16×45	0.20	1,310	EKXJ251E□□271ML45S
	390	18×35.5	0.20	1,565	EKXJ201E□□391MMP1S		270	18×35.5	0.20	1,300	EKXJ251E□□271MMP1S
	470	16×50	0.20	1,755	EKXJ201E□□471ML50S		330	16×50	0.20	1,475	EKXJ251E□□331ML50S
470	18×40	0.20	1,745	EKXJ201E□□471MM40S	330	18×40	0.20	1,460	EKXJ251E□□331MM40S		
470	18×45	0.20	1,770	EKXJ201E□□471MM45S	330	18×45	0.20	1,485	EKXJ251E□□331MM45S		
560	18×50	0.20	1,945	EKXJ201E□□561MM50S	390	18×50	0.20	1,625	EKXJ251E□□391MM50S		

□ □ : Enter the appropriate lead forming or taping code.



◆STANDARD RATINGS

WV (V _{dc})	Cap (μF)	Case size φD×L(mm)	tan δ	Rated ripple current (mA _{rms} /105°C, 120Hz)	Part No.	WV (V _{dc})	Cap (μF)	Case size φD×L(mm)	tan δ	Rated ripple current (mA _{rms} /105°C, 120Hz)	Part No.
350	12	10×16	0.24	135	EKXJ351E□□120MJ16S	420	6.8	10×16	0.24	105	EKXJ421E□□6R8MJ16S
	22	10×20	0.24	200	EKXJ351E□□220MJ20S		12	10×20	0.24	150	EKXJ421E□□120MJ20S
	27	10×25	0.24	240	EKXJ351E□□270MJ25S		15	10×25	0.24	185	EKXJ421E□□150MJ25S
	27	10×30	0.24	255	EKXJ351E□□270MJ30S		18	10×30	0.24	215	EKXJ421E□□180MJ30S
	33	12.5×20	0.24	330	EKXJ351E□□330MK20S		22	12.5×20	0.24	285	EKXJ421E□□220MK20S
	39	10×35	0.24	325	EKXJ351E□□390MJ35S		27	10×35	0.24	275	EKXJ421E□□270MJ35S
	47	10×40	0.24	375	EKXJ351E□□470MJ40S		27	10×40	0.24	290	EKXJ421E□□270MJ40S
	47	12.5×25	0.24	425	EKXJ351E□□470MK25S		27	12.5×25	0.24	340	EKXJ421E□□270MK25S
	47	14.5×20	0.24	420	EKXJ351E□□470MU20S		27	14.5×20	0.24	335	EKXJ421E□□270MU20S
	56	10×45	0.24	425	EKXJ351E□□560MJ45S		33	10×45	0.24	335	EKXJ421E□□330MJ45S
	56	12.5×30	0.24	495	EKXJ351E□□560MK30S		33	12.5×30	0.24	400	EKXJ421E□□330MK30S
	56	16×20	0.24	475	EKXJ351E□□560ML20S		33	16×20	0.24	385	EKXJ421E□□330ML20S
	68	10×50	0.24	485	EKXJ351E□□680MJ50S		39	10×50	0.24	375	EKXJ421E□□390MJ50S
	68	12.5×35	0.24	580	EKXJ351E□□680MK35S		39	14.5×25	0.24	435	EKXJ421E□□390MU25S
	68	14.5×25	0.24	545	EKXJ351E□□680MU25S		47	12.5×35	0.24	505	EKXJ421E□□470MK35S
	68	18×20	0.24	550	EKXJ351E□□680MM20S		47	16×25	0.24	500	EKXJ421E□□470ML25S
	82	12.5×40	0.24	655	EKXJ351E□□820MK40S		47	18×20	0.24	480	EKXJ421E□□470MM20S
	82	14.5×31.5	0.24	645	EKXJ351E□□820MUN3S		56	12.5×40	0.24	570	EKXJ421E□□560MK40S
	82	16×25	0.24	625	EKXJ351E□□820ML25S		56	12.5×45	0.24	590	EKXJ421E□□560MK45S
	100	12.5×45	0.24	750	EKXJ351E□□101MK45S		56	14.5×31.5	0.24	560	EKXJ421E□□560MUN3S
	100	12.5×50	0.24	770	EKXJ351E□□101MK50S		68	12.5×50	0.24	670	EKXJ421E□□680MK50S
	100	14.5×35.5	0.24	740	EKXJ351E□□101MUP1S		68	14.5×35.5	0.24	640	EKXJ421E□□680MUP1S
	100	16×31.5	0.24	740	EKXJ351E□□101MLN3S		68	14.5×40	0.24	660	EKXJ421E□□680MU40S
	100	18×25	0.24	710	EKXJ351E□□101MM25S		68	16×31.5	0.24	645	EKXJ421E□□680MLN3S
	120	14.5×40	0.24	835	EKXJ351E□□121MU40S		68	18×25	0.24	615	EKXJ421E□□680MM25S
	120	14.5×45	0.24	860	EKXJ351E□□121MU45S		82	14.5×45	0.24	750	EKXJ421E□□820MU45S
	120	16×35.5	0.24	830	EKXJ351E□□121MLP1S		82	16×35.5	0.24	725	EKXJ421E□□820MLP1S
	150	14.5×50	0.24	980	EKXJ351E□□151MU50S		82	18×31.5	0.24	730	EKXJ421E□□820MMN3S
150	16×40	0.24	960	EKXJ351E□□151ML40S	100	14.5×50	0.24	845	EKXJ421E□□101MU50S		
150	16×45	0.24	975	EKXJ351E□□151ML45S	100	16×40	0.24	825	EKXJ421E□□101ML40S		
150	18×31.5	0.24	940	EKXJ351E□□151MMN3S	100	16×45	0.24	840	EKXJ421E□□101ML45S		
180	16×50	0.24	1,090	EKXJ351E□□181ML50S	100	18×35.5	0.24	835	EKXJ421E□□101MMP1S		
180	18×35.5	0.24	1,065	EKXJ351E□□181MMP1S	120	16×50	0.24	935	EKXJ421E□□121ML50S		
180	18×40	0.24	1,080	EKXJ351E□□181MM40S	120	18×40	0.24	930	EKXJ421E□□121MM40S		
220	18×45	0.24	1,210	EKXJ351E□□221MM45S	120	18×45	0.24	945	EKXJ421E□□121MM45S		
220	18×50	0.24	1,220	EKXJ351E□□221MM50S	150	18×50	0.24	1,060	EKXJ421E□□151MM50S		
400	10	10×16	0.24	125	EKXJ401E□□100MJ16S	450	6.8	10×16	0.24	105	EKXJ451E□□6R8MJ16S
	18	10×20	0.24	180	EKXJ401E□□180MJ20S		12	10×20	0.24	150	EKXJ451E□□120MJ20S
	22	10×25	0.24	215	EKXJ401E□□220MJ25S		15	10×25	0.24	185	EKXJ451E□□150MJ25S
	27	10×30	0.24	255	EKXJ401E□□270MJ30S		18	10×30	0.24	215	EKXJ451E□□180MJ30S
	27	12.5×20	0.24	300	EKXJ401E□□270MK20S		18	12.5×20	0.24	255	EKXJ451E□□180MK20S
	33	10×35	0.24	300	EKXJ401E□□330MJ35S		22	10×35	0.24	250	EKXJ451E□□220MJ35S
	39	10×40	0.24	340	EKXJ401E□□390MJ40S		27	10×40	0.24	290	EKXJ451E□□270MJ40S
	39	10×45	0.24	355	EKXJ401E□□390MJ45S		27	10×45	0.24	305	EKXJ451E□□270MJ45S
	39	12.5×25	0.24	390	EKXJ401E□□390MK25S		27	12.5×25	0.24	340	EKXJ451E□□270MK25S
	39	14.5×20	0.24	385	EKXJ401E□□390MU20S		27	14.5×20	0.24	335	EKXJ451E□□270MU20S
	47	12.5×30	0.24	455	EKXJ401E□□470MK30S		33	12.5×30	0.24	400	EKXJ451E□□330MK30S
	47	16×20	0.24	435	EKXJ401E□□470ML20S		33	14.5×25	0.24	400	EKXJ451E□□330MU25S
	56	10×50	0.24	440	EKXJ401E□□560MJ50S		33	16×20	0.24	385	EKXJ451E□□330ML20S
	56	12.5×35	0.24	525	EKXJ401E□□560MK35S		39	10×50	0.24	375	EKXJ451E□□390MJ50S
	56	14.5×25	0.24	495	EKXJ401E□□560MU25S		39	12.5×35	0.24	460	EKXJ451E□□390MK35S
	56	18×20	0.24	500	EKXJ401E□□560MM20S		39	18×20	0.24	440	EKXJ451E□□390MM20S
	68	12.5×40	0.24	600	EKXJ401E□□680MK40S		47	12.5×40	0.24	525	EKXJ451E□□470MK40S
	68	14.5×31.5	0.24	585	EKXJ401E□□680MUN3S		47	14.5×31.5	0.24	515	EKXJ451E□□470MUN3S
	68	16×25	0.24	570	EKXJ401E□□680ML25S		47	16×25	0.24	500	EKXJ451E□□470ML25S
	82	12.5×45	0.24	680	EKXJ401E□□820MK45S		56	12.5×45	0.24	590	EKXJ451E□□560MK45S
	82	12.5×50	0.24	700	EKXJ401E□□820MK50S		56	14.5×35.5	0.24	580	EKXJ451E□□560MUP1S
	82	14.5×35.5	0.24	670	EKXJ401E□□820MUP1S		56	16×31.5	0.24	585	EKXJ451E□□560MLN3S
	82	16×31.5	0.24	670	EKXJ401E□□820MLN3S		56	18×25	0.24	560	EKXJ451E□□560MM25S
	82	18×25	0.24	640	EKXJ401E□□820MM25S		68	12.5×50	0.24	670	EKXJ451E□□680MK50S
	100	14.5×40	0.24	760	EKXJ401E□□101MU40S		68	14.5×40	0.24	660	EKXJ451E□□680MU40S
	100	14.5×45	0.24	785	EKXJ401E□□101MU45S		68	14.5×45	0.24	680	EKXJ451E□□680MU45S
	100	16×35.5	0.24	760	EKXJ401E□□101MLP1S		68	16×35.5	0.24	660	EKXJ451E□□680MLP1S
	120	14.5×50	0.24	875	EKXJ401E□□121MU50S		82	14.5×50	0.24	765	EKXJ451E□□820MU50S
120	16×40	0.24	860	EKXJ401E□□121ML40S	82	16×40	0.24	750	EKXJ451E□□820ML40S		
120	16×45	0.24	875	EKXJ401E□□121ML45S	82	16×45	0.24	760	EKXJ451E□□820ML45S		
120	18×31.5	0.24	840	EKXJ401E□□121MMN3S	82	18×31.5	0.24	730	EKXJ451E□□820MMN3S		
120	18×35.5	0.24	870	EKXJ401E□□121MMP1S	100	16×50	0.24	855	EKXJ451E□□101ML50S		
150	16×50	0.24	995	EKXJ401E□□151ML50S	100	18×35.5	0.24	835	EKXJ451E□□101MMP1S		
150	18×40	0.24	985	EKXJ401E□□151MM40S	120	18×40	0.24	930	EKXJ451E□□121MM40S		
180	18×45	0.24	1,095	EKXJ401E□□181MM45S	120	18×45	0.24	945	EKXJ451E□□121MM45S		
220	18×50	0.24	1,220	EKXJ401E□□221MM50S	150	18×50	0.24	1,060	EKXJ451E□□151MM50S		

□ □ : Enter the appropriate lead forming or taping code.



KXJ Series

◆STANDARD RATINGS

WV (V _{dc})	Cap (μF)	Case size φD×L(mm)	tan δ	Rated ripple current (mA _{rms} /105°C, 120Hz)	Part No.
500	6.8	10 × 20	0.24	90	EKXJ501E□□6R8MJ20S
	8.2	10 × 25	0.24	110	EKXJ501E□□8R2MJ25S
	10	10 × 30	0.24	130	EKXJ501E□□100MJ30S
	12	12.5 × 20	0.24	135	EKXJ501E□□120MK20S
	15	10 × 35	0.24	170	EKXJ501E□□150MJ35S
	15	10 × 40	0.24	175	EKXJ501E□□150MJ40S
	15	12.5 × 25	0.24	165	EKXJ501E□□150MK25S
	18	10 × 45	0.24	190	EKXJ501E□□180MJ45S
	18	12.5 × 30	0.24	190	EKXJ501E□□180MK30S
	22	10 × 50	0.24	230	EKXJ501E□□220MJ50S
	22	12.5 × 35	0.24	220	EKXJ501E□□220MK35S
	27	12.5 × 40	0.24	260	EKXJ501E□□270MK40S
	33	12.5 × 45	0.24	285	EKXJ501E□□330MK45S
39	12.5 × 50	0.24	330	EKXJ501E□□390MK50S	

□□ : Enter the appropriate lead forming or taping code.

◆RATED RIPPLE CURRENT MULTIPLIERS

● Frequency Multipliers

(160 to 450V_{dc})

Capacitance(μF)	Frequency(Hz)	120	1k	10k	100k
6.8 to 82		1.00	1.75	2.25	2.50
100 to 680		1.00	1.67	2.05	2.25

(500V_{dc})

Capacitance(μF)	Frequency(Hz)	120	1k	10k	100k
6.8 to 22		1.00	1.78	2.30	2.59
27 to 39		1.00	1.75	2.25	2.50

The deterioration of aluminum electrolytic capacitors accelerates their life due to the internal heating produced by ripple current. For details, refer to Section "5-3 Ripple Current Effect on Lifetime" in the catalog, Technical Note.

KWB Series

- Ideal for low profile power supply applications
- Downsized form KWA series
- Rated voltage range : 400 to 450V_{dc}, Capacitance range : 18 to 270μF
- Endurance with ripple current : 5,000 hours at 105°C
- Non solvent resistant type
- RoHS2 Compliant

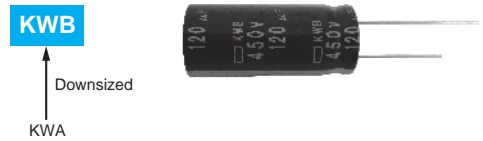

SPECIFICATIONS

Items	Characteristics	
Category	-40 to +105°C	
Temperature Range		
Rated Voltage Range	400 to 450V _{dc}	
Capacitance Tolerance	±20% (M) (at 20°C, 120Hz)	
Leakage Current	I=0.04CV+100 (after 1 minute) I=0.02CV+25 (after 5 minutes) Where, I : Max. leakage current(μA), C : Nominal capacitance (μF), V : Rated voltage (V) (at 20°C)	
Dissipation Factor (tan δ)	Rated voltage (V _{dc})	400 to 450V
	tan δ (Max.)	0.20 (at 20°C, 120Hz)
Low Temperature Characteristics (Max. Impedance Ratio)	Rated voltage (V _{dc})	400 to 450V
	Z(-25°C)/Z(+20°C)	6
	Z(-40°C)/Z(+20°C)	10 (at 120Hz)
Endurance	The following specifications shall be satisfied when the capacitors are restored to 20°C after subjected to DC voltage with the rated ripple current is applied (the peak voltage shall not exceed the rated voltage) for 5,000 hours at 105°C.	
	Capacitance change	≤ ±20% of the initial value
	D.F. (tan δ)	≤200% of the initial specified value
	Leakage current	≤The initial specified value
Shelf Life	The following specifications shall be satisfied when the capacitors are restored to 20°C after exposing them for 1,000 hours at 105°C without voltage applied. Before the measurement, the capacitor shall be preconditioned by applying voltage according to Item 4.1 of JIS C 5101-4.	
	Capacitance change	≤ ±20% of the initial value
	D.F. (tan δ)	≤200% of the initial specified value
	Leakage current	≤500% of the initial specified value

DIMENSIONS [mm]

- Terminal Code : E

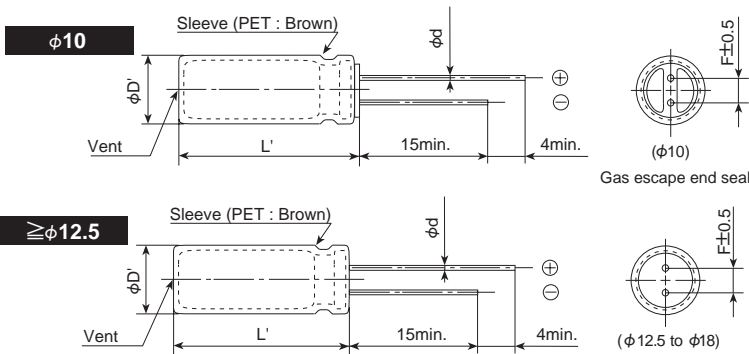

PART NUMBERING SYSTEM

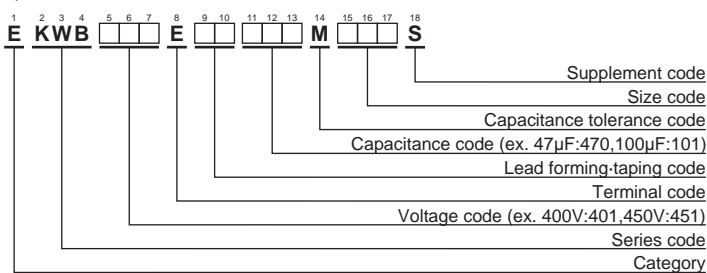

Please refer to "Product code guide (radial lead type)"



◆STANDARD RATINGS

WV (V _{dc})	Cap (μF)	Case size φD×L(mm)	tan δ	Rated ripple current (mA _{rms} /105°C, 120Hz)	Part No.	WV (V _{dc})	Cap (μF)	Case size φD×L(mm)	tan δ	Rated ripple current (mA _{rms} /105°C, 120Hz)	Part No.
400	22	10×20	0.20	235	EKWB401E□□220MJ20S	450	18	10×20	0.20	210	EKWB451E□□180MJ20S
	27	10×25	0.20	285	EKWB401E□□270MJ25S		27	10×25	0.20	285	EKWB451E□□270MJ25S
	39	10×30	0.20	365	EKWB401E□□390MJ30S		33	10×30	0.20	335	EKWB451E□□330MJ30S
	39	12.5×20	0.20	345	EKWB401E□□390MK20S		33	12.5×20	0.20	320	EKWB451E□□330MK20S
	47	10×35	0.20	425	EKWB401E□□470MJ35S		39	10×35	0.20	385	EKWB451E□□390MJ35S
	56	10×40	0.20	485	EKWB401E□□560MJ40S		47	10×40	0.20	445	EKWB451E□□470MJ40S
	56	12.5×25	0.20	450	EKWB401E□□560MK25S		47	12.5×25	0.20	415	EKWB451E□□470MK25S
	68	10×45	0.20	555	EKWB401E□□680MJ45S		56	10×45	0.20	505	EKWB451E□□560MJ45S
	68	10×50	0.20	575	EKWB401E□□680MJ50S		56	10×50	0.20	520	EKWB451E□□560MJ50S
	68	12.5×30	0.20	530	EKWB401E□□680MK30S		56	12.5×30	0.20	480	EKWB451E□□560MK30S
	68	16×20	0.20	510	EKWB401E□□680ML20S		56	16×20	0.20	460	EKWB451E□□560ML20S
	82	12.5×35	0.20	610	EKWB401E□□820MK35S		68	12.5×35	0.20	560	EKWB451E□□680MK35S
	82	18×20	0.20	585	EKWB401E□□820MM20S		82	12.5×40	0.20	640	EKWB451E□□820MK40S
	100	12.5×40	0.20	705	EKWB401E□□101MK40S		82	12.5×45	0.20	660	EKWB451E□□820MK45S
	100	14.5×31.5	0.20	680	EKWB401E□□101MUN3S		82	14.5×31.5	0.20	615	EKWB451E□□820MUN3S
	100	16×25	0.20	670	EKWB401E□□101ML25S		82	16×25	0.20	605	EKWB451E□□820ML25S
	120	12.5×45	0.20	800	EKWB401E□□121MK45S		82	18×20	0.20	585	EKWB451E□□820MM20S
	120	12.5×50	0.20	820	EKWB401E□□121MK50S		100	12.5×50	0.20	750	EKWB451E□□101MK50S
	120	14.5×35	0.20	765	EKWB401E□□121MU35S		100	14.5×35	0.20	700	EKWB451E□□101MU35S
	120	16×31.5	0.20	790	EKWB401E□□121MLN3S		100	16×31.5	0.20	720	EKWB451E□□101MLN3S
	120	18×25	0.20	755	EKWB401E□□121MM25S		100	18×25	0.20	690	EKWB451E□□101MM25S
	150	16×35	0.20	905	EKWB401E□□151ML35S		120	16×35	0.20	810	EKWB451E□□121ML35S
	150	18×31.5	0.20	915	EKWB401E□□151MMN3S		120	18×31.5	0.20	815	EKWB451E□□121MMN3S
	180	16×40	0.20	1,020	EKWB401E□□181ML40S		150	16×40	0.20	935	EKWB451E□□151ML40S
	180	16×45	0.20	1,040	EKWB401E□□181ML45S		150	16×45	0.20	950	EKWB451E□□151ML45S
	180	18×31.5	0.20	1,000	EKWB401E□□181MMN3S		150	18×31.5	0.20	915	EKWB451E□□151MMN3S
	180	18×35	0.20	1,020	EKWB401E□□181MM35S		150	18×35	0.20	935	EKWB451E□□151MM35S
220	16×50	0.20	1,170	EKWB401E□□221ML50S	180	16×50	0.20	1,060	EKWB451E□□181ML50S		
220	18×40	0.20	1,160	EKWB401E□□221MM40S	180	18×40	0.20	1,050	EKWB451E□□181MM40S		
270	18×45	0.20	1,310	EKWB401E□□271MM45S	220	18×45	0.20	1,190	EKWB451E□□221MM45S		
270	18×50	0.20	1,310	EKWB401E□□271MM50S	220	18×50	0.20	1,190	EKWB451E□□221MM50S		
420	22	10×20	0.20	235	EKWB421E□□220MJ20S	27	10×25	0.20	285	EKWB421E□□270MJ25S	
	33	12.5×20	0.20	320	EKWB421E□□330MK20S	39	10×30	0.20	365	EKWB421E□□390MJ30S	
	39	10×30	0.20	365	EKWB421E□□390MJ30S	47	10×35	0.20	425	EKWB421E□□470MJ35S	
	47	10×35	0.20	425	EKWB421E□□470MJ35S	47	12.5×25	0.20	415	EKWB421E□□470MK25S	
	47	12.5×25	0.20	415	EKWB421E□□470MK25S	56	10×40	0.20	485	EKWB421E□□560MJ40S	
	56	10×40	0.20	485	EKWB421E□□560MJ40S	56	10×45	0.20	505	EKWB421E□□560MJ45S	
	56	10×45	0.20	505	EKWB421E□□560MJ45S	56	10×50	0.20	520	EKWB421E□□560MJ50S	
	56	10×50	0.20	520	EKWB421E□□560MJ50S	68	12.5×30	0.20	530	EKWB421E□□680MK30S	
	68	12.5×30	0.20	530	EKWB421E□□680MK30S	68	16×20	0.20	510	EKWB421E□□680ML20S	
	68	16×20	0.20	510	EKWB421E□□680ML20S	82	12.5×35	0.20	610	EKWB421E□□820MK35S	
	82	12.5×35	0.20	610	EKWB421E□□820MK35S	82	12.5×40	0.20	640	EKWB421E□□820MK40S	
	82	12.5×40	0.20	640	EKWB421E□□820MK40S	82	14.5×31.5	0.20	615	EKWB421E□□820MUN3S	
	82	14.5×31.5	0.20	615	EKWB421E□□820MUN3S	82	16×25	0.20	605	EKWB421E□□820ML25S	
	82	16×25	0.20	605	EKWB421E□□820ML25S	82	18×20	0.20	585	EKWB421E□□820MM20S	
	82	18×20	0.20	585	EKWB421E□□820MM20S	100	12.5×45	0.20	730	EKWB421E□□101MK45S	
	100	12.5×45	0.20	730	EKWB421E□□101MK45S	100	14.5×35	0.20	700	EKWB421E□□101MU35S	
	100	14.5×35	0.20	700	EKWB421E□□101MU35S	120	12.5×50	0.20	820	EKWB421E□□121MK50S	
	120	12.5×50	0.20	820	EKWB421E□□121MK50S	120	16×31.5	0.20	790	EKWB421E□□121MLN3S	
	120	16×31.5	0.20	790	EKWB421E□□121MLN3S	120	18×25	0.20	755	EKWB421E□□121MM25S	
	120	18×25	0.20	755	EKWB421E□□121MM25S	150	16×35	0.20	905	EKWB421E□□151ML35S	
	150	16×35	0.20	905	EKWB421E□□151ML35S	150	16×40	0.20	935	EKWB421E□□151ML40S	
	150	16×40	0.20	935	EKWB421E□□151ML40S	150	18×31.5	0.20	915	EKWB421E□□151MMN3S	
	150	18×31.5	0.20	915	EKWB421E□□151MMN3S	180	16×45	0.20	1,040	EKWB421E□□181ML45S	
	180	16×45	0.20	1,040	EKWB421E□□181ML45S	180	16×50	0.20	1,060	EKWB421E□□181ML50S	
	180	16×50	0.20	1,060	EKWB421E□□181ML50S	180	18×35	0.20	1,020	EKWB421E□□181MM35S	
	180	18×35	0.20	1,020	EKWB421E□□181MM35S	180	18×40	0.20	1,050	EKWB421E□□181MM40S	
	180	18×40	0.20	1,050	EKWB421E□□181MM40S	220	18×45	0.20	1,190	EKWB421E□□221MM45S	
220	18×45	0.20	1,190	EKWB421E□□221MM45S	270	18×50	0.20	1,310	EKWB421E□□271MM50S		
270	18×50	0.20	1,310	EKWB421E□□271MM50S							

□□ : Enter the appropriate lead forming or taping code.

◆RATED RIPPLE CURRENT MULTIPLIERS

● Frequency Multipliers

Capacitance(μF)	Frequency(Hz)			
	120	1k	10k	100k
18 to 82	1.00	1.50	1.75	1.80
100 to 270	1.00	1.30	1.40	1.50

The deterioration of aluminum electrolytic capacitors accelerates their life due to the internal heating produced by ripple current. For details, refer to Section "5-3 Ripple Current Effect on Lifetime" in the catalog, Technical Note.



KWA Series

- Ideal for low profile power supply applications
- Longer life form KHE series
- Rated voltage range : 400 to 450V_{dc}, Capacitance range : 27 to 120μF
- Endurance with ripple current : 5,000 hours at 105°C
- Non solvent resistant type
- RoHS2 Compliant



Longer life
KHE

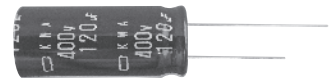

SPECIFICATIONS

Items	Characteristics			
Category	-40 to +105°C			
Temperature Range	-40 to +105°C			
Rated Voltage Range	400 to 450V _{dc}			
Capacitance Tolerance	±20% (M) (at 20°C, 120Hz)			
Leakage Current	I=0.04CV+100 (after 1 minute) I=0.02CV+25 (after 5 minutes) Where, I : Max. leakage current(μA), C : Nominal capacitance (μF), V : Rated voltage (V) (at 20°C)			
Dissipation Factor (tan δ)	Rated voltage (V _{dc})	400 to 450V		
	tan δ (Max.)	0.20 (at 20°C, 120Hz)		
Low Temperature Characteristics (Max. Impedance Ratio)	Rated voltage (V _{dc})	400V	420V	450V
	Z(-25°C)/Z(+20°C)	5	6	6
	Z(-40°C)/Z(+20°C)	6	—	—
Endurance	The following specifications shall be satisfied when the capacitors are restored to 20°C after subjected to DC voltage with the rated ripple current is applied (the peak voltage shall not exceed the rated voltage) for 5,000 hours at 105°C.			
	Capacitance change	≤ ±20% of the initial value		
	D.F. (tan δ)	≤200% of the initial specified value		
	Leakage current	≤The initial specified value		
Shelf Life	The following specifications shall be satisfied when the capacitors are restored to 20°C after exposing them for 1,000 hours at 105°C without voltage applied. Before the measurement, the capacitor shall be preconditioned by applying voltage according to Item 4.1 of JIS C 5101-4.			
	Capacitance change	≤ ±20% of the initial value		
	D.F. (tan δ)	≤200% of the initial specified value		
	Leakage current	≤500% of the initial specified value		

DIMENSIONS [mm]

- Terminal Code : E

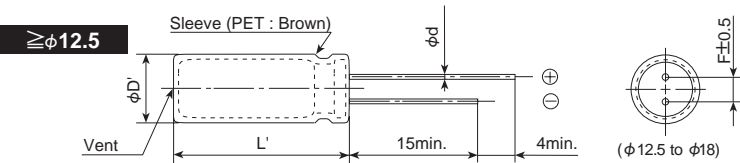
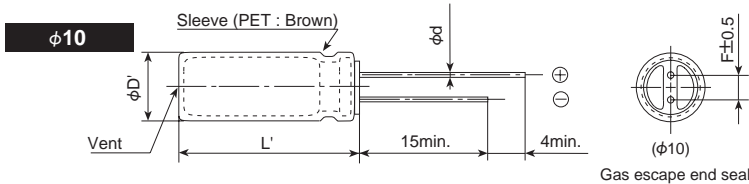

PART NUMBERING SYSTEM

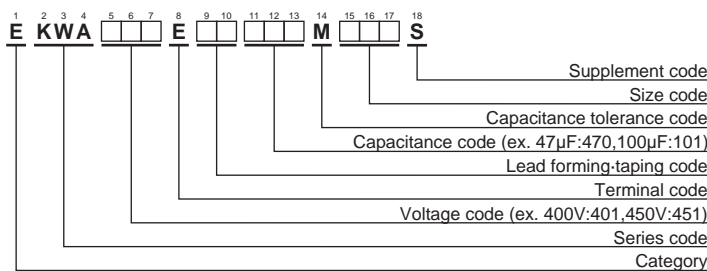

Please refer to "Product code guide (radial lead type)"



KWA Series

◆STANDARD RATINGS

WV (V _{dc})	Cap (μF)	Case size φD×L(mm)	tan δ	Rated ripple current (mA _{rms} /105°C, 120Hz)	Part No.	WV (V _{dc})	Cap (μF)	Case size φD×L(mm)	tan δ	Rated ripple current (mA _{rms} /105°C, 120Hz)	Part No.
400	33	10×30	0.20	320	EKWA401E□□330MJ30S	450	27	10×30	0.20	290	EKWA451E□□270MJ30S
	39	10×35	0.20	370	EKWA401E□□390MJ35S		33	10×35	0.20	340	EKWA451E□□330MJ35S
	47	10×40	0.20	420	EKWA401E□□470MJ40S		39	10×40	0.20	380	EKWA451E□□390MJ40S
	56	10×45	0.20	480	EKWA401E□□560MJ45S		47	10×45	0.20	440	EKWA451E□□470MJ45S
	56	12.5×30	0.20	460	EKWA401E□□560MK30S		47	12.5×30	0.20	420	EKWA451E□□470MK30S
	68	12.5×35	0.20	530	EKWA401E□□680MK35S		56	12.5×35	0.20	480	EKWA451E□□560MK35S
	82	12.5×40	0.20	610	EKWA401E□□820MK40S		68	12.5×40	0.20	550	EKWA451E□□680MK40S
	82	14.5×31.5	0.20	590	EKWA401E□□820MUN3S		68	14.5×31.5	0.20	530	EKWA451E□□680MUN3S
	100	12.5×45	0.20	690	EKWA401E□□101MK45S		82	12.5×45	0.20	630	EKWA451E□□820MK45S
	100	14.5×40	0.20	700	EKWA401E□□101MU40S		82	14.5×35	0.20	620	EKWA451E□□820MU35S
	100	16×31.5	0.20	710	EKWA401E□□101MLN3S		82	16×31.5	0.20	640	EKWA451E□□820MLN3S
	120	14.5×45	0.20	790	EKWA401E□□121MU45S		100	14.5×45	0.20	720	EKWA451E□□101MU45S
120	16×35	0.20	800	EKWA401E□□121ML35S	100	16×35	0.20	730	EKWA451E□□101ML35S		
120	18×31.5	0.20	800	EKWA401E□□121MMN3S	120	18×31.5	0.20	800	EKWA451E□□121MMN3S		
420	33	10×30	0.20	320	EKWA421E□□330MJ30S						
	39	10×35	0.20	370	EKWA421E□□390MJ35S						
	47	10×40	0.20	420	EKWA421E□□470MJ40S						
	56	10×50	0.20	500	EKWA421E□□560MJ50S						
	56	12.5×30	0.20	460	EKWA421E□□560MK30S						
	68	12.5×35	0.20	530	EKWA421E□□680MK35S						
	68	14.5×31.5	0.20	530	EKWA421E□□680MUN3S						
	82	12.5×40	0.20	610	EKWA421E□□820MK40S						
	82	14.5×35	0.20	620	EKWA421E□□820MU35S						
	100	12.5×50	0.20	680	EKWA421E□□101MK50S						
	100	14.5×40	0.20	700	EKWA421E□□101MU40S						
	100	16×31.5	0.20	710	EKWA421E□□101MLN3S						
120	14.5×45	0.20	790	EKWA421E□□121MU45S							
120	16×35	0.20	800	EKWA421E□□121ML35S							
120	18×31.5	0.20	800	EKWA421E□□121MMN3S							

□□ : Enter the appropriate lead forming or taping code.

◆RATED RIPPLE CURRENT MULTIPLIERS

● Frequency Multipliers

Capacitance(μF)	Frequency(Hz)			
	120	1k	10k	100k
27 to 82	1.00	1.50	1.75	1.80
100 to 120	1.00	1.30	1.40	1.50

The deterioration of aluminum electrolytic capacitors accelerates their life due to the internal heating produced by ripple current. For details, refer to Section "5-3 Ripple Current Effect on Lifetime" in the catalog, Technical Note.

KHF Series

- Ideal for low profile power supply applications
- Downsize, high ripple design
- Rated voltage range : 400 to 450V_{dc}, Capacitance range : 18 to 270μF
- Endurance with ripple current : 3,000 hours at 105°C
- Non solvent resistant type
- RoHS2 Compliant

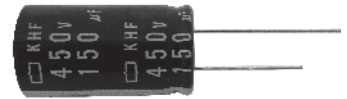
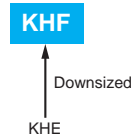

SPECIFICATIONS

Items	Characteristics		
Category	-40 to +105°C		
Temperature Range	-40 to +105°C		
Rated Voltage Range	400 to 450V _{dc}		
Capacitance Tolerance	±20% (M) (at 20°C, 120Hz)		
Leakage Current		After 1 minute	After 5 minutes
	CV ≤ 1,000	I = 0.1CV + 40	I = 0.03CV + 15
	CV > 1,000	I = 0.04CV + 100	I = 0.02CV + 25
	Where, I : Max. leakage current(μA), C : Nominal capacitance (μF), V : Rated voltage (V) (at 20°C)		
Dissipation Factor (tan δ)	Rated voltage (V _{dc})	400 to 450V	
	tan δ (Max.)	0.20 (at 20°C, 120Hz)	
Low Temperature Characteristics (Max. Impedance Ratio)	Rated voltage (V _{dc})	400 to 450V	
	Z(-25°C)/Z(+20°C)	6	
	Z(-40°C)/Z(+20°C)	10 (at 120Hz)	
Endurance	The following specifications shall be satisfied when the capacitors are restored to 20°C after subjected to DC voltage with the rated ripple current is applied (the peak voltage shall not exceed the rated voltage) for 3,000 hours at 105°C.		
	Capacitance change	≤ ±20% of the initial value	
	D.F. (tan δ)	≤ 200% of the initial specified value	
	Leakage current	≤ The initial specified value	
Shelf Life	The following specifications shall be satisfied when the capacitors are restored to 20°C after exposing them for 1,000 hours at 105°C without voltage applied. Before the measurement, the capacitor shall be preconditioned by applying voltage according to Item 4.1 of JIS C 5101-4.		
	Capacitance change	≤ ±20% of the initial value	
	D.F. (tan δ)	≤ 200% of the initial specified value	
	Leakage current	≤ 500% of the initial specified value	

DIMENSIONS [mm]

● Terminal Code : E

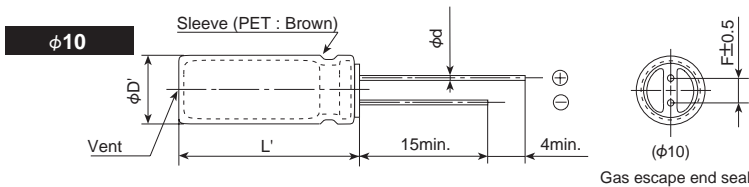

φD	10	12.5	14.5	16	18
φd	0.6	0.6	0.8	0.8	0.8
F	5.0	5.0	7.5	7.5	7.5
φD'	φD+0.5 max.				
L'	L+2.0 max.				

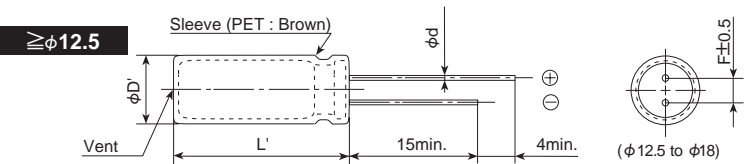

PART NUMBERING SYSTEM

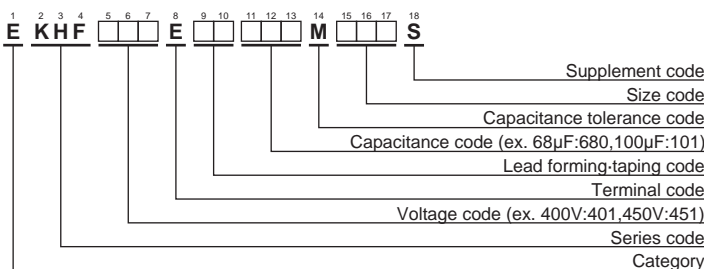

Please refer to "Product code guide (radial lead type)"



◆STANDARD RATINGS

WV (V _{dc})	Cap (μF)	Case size φD×L(mm)	tan δ	Rated ripple current (mA _{rms} /105°C, 120Hz)	Part No.	WV (V _{dc})	Cap (μF)	Case size φD×L(mm)	tan δ	Rated ripple current (mA _{rms} /105°C, 120Hz)	Part No.
400	22	10×20	0.20	235	EKHF401E□□220MJ20S	450	18	10×20	0.20	210	EKHF451E□□180MJ20S
	27	10×25	0.20	285	EKHF401E□□270MJ25S		27	10×25	0.20	285	EKHF451E□□270MJ25S
	39	10×30	0.20	365	EKHF401E□□390MJ30S		33	10×30	0.20	335	EKHF451E□□330MJ30S
	39	12.5×20	0.20	345	EKHF401E□□390MK20S		33	12.5×20	0.20	320	EKHF451E□□330MK20S
	47	10×35	0.20	425	EKHF401E□□470MJ35S		39	10×35	0.20	385	EKHF451E□□390MJ35S
	56	10×40	0.20	485	EKHF401E□□560MJ40S		47	10×40	0.20	445	EKHF451E□□470MJ40S
	56	12.5×25	0.20	450	EKHF401E□□560MK25S		47	12.5×25	0.20	415	EKHF451E□□470MK25S
	68	10×45	0.20	555	EKHF401E□□680MJ45S		56	10×45	0.20	505	EKHF451E□□560MJ45S
	68	10×50	0.20	575	EKHF401E□□680MJ50S		56	10×50	0.20	520	EKHF451E□□560MJ50S
	68	12.5×30	0.20	530	EKHF401E□□680MK30S		56	12.5×30	0.20	480	EKHF451E□□560MK30S
	68	16×20	0.20	510	EKHF401E□□680ML20S		56	16×20	0.20	460	EKHF451E□□560ML20S
	82	12.5×35	0.20	610	EKHF401E□□820MK35S		68	12.5×35	0.20	560	EKHF451E□□680MK35S
	100	12.5×40	0.20	705	EKHF401E□□101MK40S		82	12.5×40	0.20	640	EKHF451E□□820MK40S
	100	14.5×31.5	0.20	680	EKHF401E□□101MUN3S		82	14.5×31.5	0.20	615	EKHF451E□□820MUN3S
	100	16×25	0.20	670	EKHF401E□□101ML25S		82	16×25	0.20	605	EKHF451E□□820ML25S
	100	18×20	0.20	650	EKHF401E□□101MM20S		82	18×20	0.20	585	EKHF451E□□820MM20S
	120	12.5×45	0.20	800	EKHF401E□□121MK45S		100	12.5×45	0.20	730	EKHF451E□□101MK45S
	120	12.5×50	0.20	820	EKHF401E□□121MK50S		100	12.5×50	0.20	750	EKHF451E□□101MK50S
	120	14.5×35	0.20	765	EKHF401E□□121MU35S		100	14.5×35	0.20	700	EKHF451E□□101MU35S
	120	14.5×40	0.20	810	EKHF401E□□121MU40S		100	16×31.5	0.20	720	EKHF451E□□101MLN3S
	120	16×31.5	0.20	790	EKHF401E□□121MLN3S		100	18×25	0.20	690	EKHF451E□□101MM25S
	120	18×25	0.20	755	EKHF401E□□121MM25S		120	14.5×40	0.20	810	EKHF451E□□121MU40S
	150	14.5×45	0.20	905	EKHF401E□□151MU45S		120	14.5×45	0.20	835	EKHF451E□□121MU45S
	150	16×35	0.20	905	EKHF401E□□151ML35S		120	16×35	0.20	810	EKHF451E□□121ML35S
	150	18×31.5	0.20	915	EKHF401E□□151MMN3S		150	16×40	0.20	935	EKHF451E□□151ML40S
	180	16×40	0.20	1020	EKHF401E□□181ML40S		150	16×45	0.20	950	EKHF451E□□151ML45S
	180	16×45	0.20	1040	EKHF401E□□181ML45S		150	18×31.5	0.20	915	EKHF451E□□151MMN3S
180	18×31.5	0.20	1000	EKHF401E□□181MMN3S	150	18×35	0.20	935	EKHF451E□□151MM35S		
180	18×35	0.20	1020	EKHF401E□□181MM35S	180	16×50	0.20	1060	EKHF451E□□181ML50S		
220	16×50	0.20	1170	EKHF401E□□221ML50S	180	18×40	0.20	1050	EKHF451E□□181MM40S		
220	18×40	0.20	1160	EKHF401E□□221MM40S	220	18×45	0.20	1190	EKHF451E□□221MM45S		
270	18×45	0.20	1310	EKHF401E□□271MM45S	220	18×50	0.20	1190	EKHF451E□□221MM50S		
270	18×50	0.20	1310	EKHF401E□□271MM50S							
420	22	10×20	0.20	235	EKHF421E□□220MJ20S						
	27	10×25	0.20	285	EKHF421E□□270MJ25S						
	39	10×30	0.20	365	EKHF421E□□390MJ30S						
	39	12.5×20	0.20	345	EKHF421E□□390MK20S						
	47	10×35	0.20	425	EKHF421E□□470MJ35S						
	56	10×40	0.20	485	EKHF421E□□560MJ40S						
	56	10×45	0.20	505	EKHF421E□□560MJ45S						
	56	12.5×25	0.20	450	EKHF421E□□560MK25S						
	68	10×50	0.20	575	EKHF421E□□680MJ50S						
	68	12.5×30	0.20	530	EKHF421E□□680MK30S						
	68	16×20	0.20	510	EKHF421E□□680ML20S						
	82	12.5×35	0.20	610	EKHF421E□□820MK35S						
	82	14.5×31.5	0.20	615	EKHF421E□□820MUN3S						
	82	16×25	0.20	605	EKHF421E□□820ML25S						
	82	18×20	0.20	585	EKHF421E□□820MM20S						
	100	12.5×40	0.20	705	EKHF421E□□101MK40S						
	100	12.5×45	0.20	730	EKHF421E□□101MK45S						
	100	14.5×35	0.20	700	EKHF421E□□101MU35S						
	120	12.5×50	0.20	820	EKHF421E□□121MK50S						
	120	14.5×40	0.20	810	EKHF421E□□121MU40S						
	120	16×31.5	0.20	790	EKHF421E□□121MLN3S						
	120	18×25	0.20	755	EKHF421E□□121MM25S						
	150	14.5×45	0.20	905	EKHF421E□□151MU45S						
	150	16×35	0.20	905	EKHF421E□□151ML35S						
	150	16×40	0.20	935	EKHF421E□□151ML40S						
	150	18×31.5	0.20	915	EKHF421E□□151MMN3S						
	180	16×45	0.20	1040	EKHF421E□□181ML45S						
180	18×35	0.20	1020	EKHF421E□□181MM35S							
220	16×50	0.20	1170	EKHF421E□□221ML50S							
220	18×40	0.20	1160	EKHF421E□□221MM40S							
220	18×45	0.20	1190	EKHF421E□□221MM45S							
270	18×50	0.20	1310	EKHF421E□□271MM50S							

□□ : Enter the appropriate lead forming or taping code.

◆RATED RIPPLE CURRENT MULTIPLIERS

● Frequency Multipliers

Capacitance(μF)	Frequency(Hz)			
	120	1k	10k	100k
18 to 82	1.00	1.50	1.75	1.80
100 to 270	1.00	1.30	1.40	1.50

The deterioration of aluminum electrolytic capacitors accelerates their life due to the internal heating produced by ripple current. For details, refer to Section "5-3 Ripple Current Effect on Lifetime" in the catalog, Technical Note.

Product specifications in this catalog are subject to change without notice. Request our product specifications before purchase and/or use. Please use our products based on the information contained in this catalog and product specifications.

KHE Series

- Ideal for low profile power supply applications
- Downsize, high ripple design
- Rated voltage range : 400 to 450V_{dc}, Capacitance range : 27 to 120μF
- Endurance with ripple current : 2,000 hours at 105°C
- Non solvent resistant type
- RoHS2 Compliant



SPECIFICATIONS

Items	Characteristics			
Category	-40 to +105°C			
Temperature Range	-40 to +105°C			
Rated Voltage Range	400 to 450V _{dc}			
Capacitance Tolerance	±20% (M) (at 20°C, 120Hz)			
Leakage Current		After 1 minute	After 5 minutes	
	CV ≤ 1,000	I = 0.1CV + 40	I = 0.03CV + 15	
	CV > 1,000	I = 0.04CV + 100	I = 0.02CV + 25	
	Where, I : Max. leakage current (μA), C : Nominal capacitance (μF), V : Rated voltage (V) (at 20°C)			
Dissipation Factor (tan δ)	Rated voltage (V _{dc})	400V	420V	450V
	tan δ (Max.)	0.15	0.20	0.20
	(at 20°C, 120Hz)			
Low Temperature Characteristics (Max. Impedance Ratio)	Rated voltage (V _{dc})	400V	420V	450V
	Z(-25°C)/Z(+20°C)	5	6	6
	Z(-40°C)/Z(+20°C)	6	—	—
	(at 120Hz)			
Endurance	The following specifications shall be satisfied when the capacitors are restored to 20°C after subjected to DC voltage with the rated ripple current is applied (the peak voltage shall not exceed the rated voltage) for 2,000 hours at 105°C.			
	Capacitance change	≤ ±20% of the initial value		
	D.F. (tan δ)	≤ 200% of the initial specified value		
	Leakage current	≤ The initial specified value		
Shelf Life	The following specifications shall be satisfied when the capacitors are restored to 20°C after exposing them for 1,000 hours at 105°C without voltage applied. Before the measurement, the capacitor shall be preconditioned by applying voltage according to Item 4.1 of JIS C 5101-4.			
	Capacitance change	≤ ±20% of the initial value		
	D.F. (tan δ)	≤ 200% of the initial specified value		
	Leakage current	≤ 500% of the initial specified value		

DIMENSIONS [mm]

● Terminal Code : E

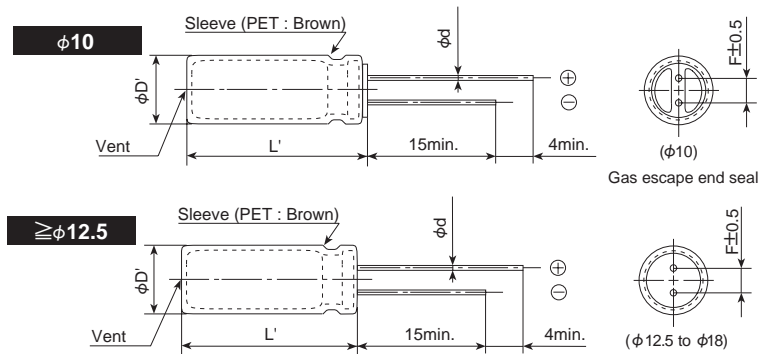

φD	10	12.5	14.5	16	18
φd	0.6	0.6	0.8	0.8	0.8
F	5.0	5.0	7.5	7.5	7.5
φD'	φD+0.5 max.				
L'	L+2.0 max.				

PART NUMBERING SYSTEM

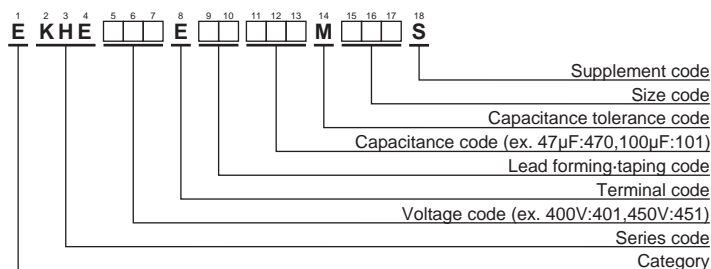

Please refer to "Product code guide (radial lead type)"



KHE Series

◆STANDARD RATINGS

WV (V _{dc})	Cap (μF)	Case size φD×L(mm)	tan δ	Rated ripple current (mA _{rms} /105°C, 120Hz)	Part No.	WV (V _{dc})	Cap (μF)	Case size φD×L(mm)	tan δ	Rated ripple current (mA _{rms} /105°C, 120Hz)	Part No.
400	33	10×30	0.15	335	EKHE401E□□330MJ30S	450	27	10×30	0.20	305	EKHE451E□□270MJ30S
	39	10×35	0.15	385	EKHE401E□□390MJ35S		33	10×35	0.20	355	EKHE451E□□330MJ35S
	47	10×40	0.15	445	EKHE401E□□470MJ40S		39	10×40	0.20	405	EKHE451E□□390MJ40S
	56	10×45	0.15	505	EKHE401E□□560MJ45S		47	10×45	0.20	460	EKHE451E□□470MJ45S
	56	12.5×30	0.15	480	EKHE401E□□560MK30S		47	12.5×30	0.20	440	EKHE451E□□470MK30S
	68	12.5×35	0.15	560	EKHE401E□□680MK35S		56	12.5×35	0.20	505	EKHE451E□□560MK35S
	82	12.5×40	0.15	640	EKHE401E□□820MK40S		68	12.5×40	0.20	580	EKHE451E□□680MK40S
	82	14.5×31.5	0.15	625	EKHE401E□□820MUN3S		68	14.5×31.5	0.20	570	EKHE451E□□680MUN3S
	100	12.5×45	0.15	730	EKHE401E□□101MK45S		82	12.5×45	0.20	660	EKHE451E□□820MK45S
	100	14.5×35	0.15	715	EKHE401E□□101MU35S		82	14.5×35	0.20	650	EKHE451E□□820MU35S
	100	16×31.5	0.15	720	EKHE401E□□101MLN3S		82	16×31.5	0.20	655	EKHE451E□□820MLN3S
	120	14.5×40	0.15	810	EKHE401E□□121MU40S		100	14.5×40	0.20	740	EKHE451E□□101MU40S
120	16×35	0.15	810	EKHE401E□□121ML35S	100	16×35	0.20	740	EKHE451E□□101ML35S		
120	18×31.5	0.15	815	EKHE401E□□121MMN3S	120	18×31.5	0.20	815	EKHE451E□□121MMN3S		
420	33	10×30	0.20	335	EKHE421E□□330MJ30S						
	39	10×35	0.20	385	EKHE421E□□390MJ35S						
	47	10×40	0.20	445	EKHE421E□□470MJ40S						
	56	10×50	0.20	520	EKHE421E□□560MJ50S						
	56	12.5×30	0.20	480	EKHE421E□□560MK30S						
	68	12.5×35	0.20	560	EKHE421E□□680MK35S						
	82	12.5×40	0.20	640	EKHE421E□□820MK40S						
	82	14.5×31.5	0.20	625	EKHE421E□□820MUN3S						
	100	12.5×50	0.20	750	EKHE421E□□101MK50S						
	100	14.5×40	0.20	740	EKHE421E□□101MU40S						
	100	16×31.5	0.20	720	EKHE421E□□101MLN3S						
	120	14.5×45	0.20	835	EKHE421E□□121MU45S						
120	16×35	0.20	810	EKHE421E□□121ML35S							
120	18×31.5	0.20	815	EKHE421E□□121MMN3S							

□□ : Enter the appropriate lead forming or taping code.

◆RATED RIPPLE CURRENT MULTIPLIERS

● Frequency Multipliers

Capacitance(μF)	Frequency(Hz)			
	120	1k	10k	100k
27 to 82	1.00	1.50	1.75	1.80
100 to 120	1.00	1.30	1.40	1.50

The deterioration of aluminum electrolytic capacitors accelerates their life due to the internal heating produced by ripple current. For details, refer to Section "5-3 Ripple Current Effect on Lifetime" in the catalog, Technical Note.



PAG Series

- Downsize, high ripple design (φ 10 to 18)
- Rated voltage range : 200 to 450V_{dc}, Capacitance range : 18 to 560μF
- Endurance with ripple current : 2,000 hours at 105°C
- Ideal for low profile power supply applications
- Non solvent resistant type
- RoHS2 Compliant

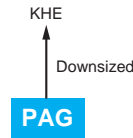

SPECIFICATIONS

Items	Characteristics				
Category	-40 to +105°C (200, 400V _{dc}) -25 to +105°C (420, 450V _{dc})				
Temperature Range					
Rated Voltage Range	200 to 450V _{dc}				
Capacitance Tolerance	±20% (M) (at 20°C, 120Hz)°C				
Leakage Current		After 1 minute		After 5 minutes	
	CV ≤ 1,000	I=0.1CV+40		I=0.03CV+15	
	CV > 1,000	I=0.04CV+100		I=0.02CV+25	
	Where, I : Max. leakage current(μA), C : Nominal capacitance (μF), V : Rated voltage (V) (at 20°C)°C				
Dissipation Factor (tan δ)	Rated voltage (V _{dc})	200V	400V	420V	450V
	tan δ (Max.)	0.12	0.15	0.20	0.20
(at 20°C, 120Hz)°C					
Low Temperature Characteristics (Max. Impedance Ratio)	Rated voltage (V _{dc})	200V	400V	420V	450V
	Z(-25°C)/Z(+20°C)	3	5	6	6
	Z(-40°C)/Z(+20°C)	6	6	—	—
(at 120Hz)					
Endurance	The following specifications shall be satisfied when the capacitors are restored to 20°C after subjected to DC voltage with the rated ripple current is applied (the peak voltage shall not exceed the rated voltage) for 2,000 hours at 105°C.				
	Capacitance change	≤ ±20% of the initial value			
	D.F. (tan δ)	≤200% of the initial specified value			
	Leakage current	≤The initial specified value			
Shelf Life	The following specifications shall be satisfied when the capacitors are restored to 20°C after exposing them for 1,000 hours at 105°C without voltage applied. Before the measurement, the capacitor shall be preconditioned by applying voltage according to Item 4.1 of JIS C 5101-4.				
	Capacitance change	≤ ±20% of the initial value			
	D.F. (tan δ)	≤200% of the initial specified value			
	Leakage current	≤500% of the initial specified value			

DIMENSIONS [mm]

Terminal Code : E

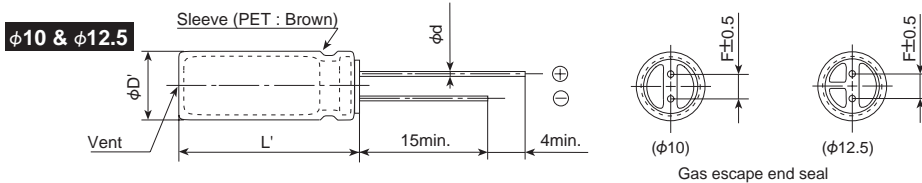

φD	10	12.5	14.5	16	18
φd	0.6	0.6	0.8	0.8	0.8
F	5.0	5.0	7.5	7.5	7.5
φD'	φD+0.5 max.				
L'	L+2.0 max.				

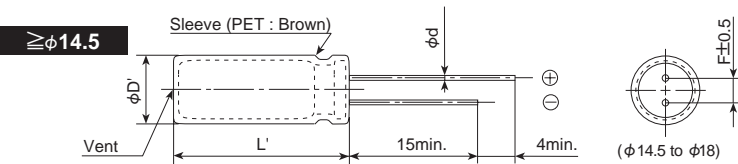

PART NUMBERING SYSTEM

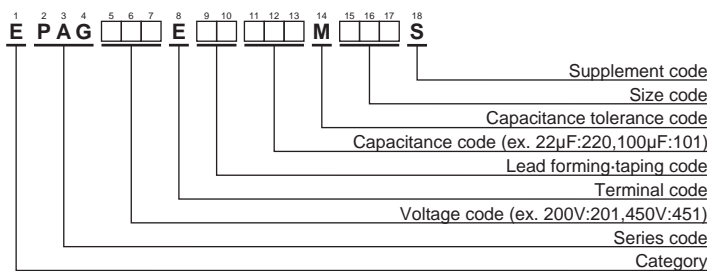

Please refer to "Product code guide (radial lead type)"



PAGSeries

◆STANDARD RATINGS

WV (V _{dc})	Cap (μF)	Case size φD×L(mm)	tan δ	Rated ripple current (mA _{rms} /105°C, 120Hz)	Part No.	WV (V _{dc})	Cap (μF)	Case size φD×L(mm)	tan δ	Rated ripple current (mA _{rms} /105°C, 120Hz)	Part No.
200	82	10×30	0.12	440	EPAG201E□□820MJ30S	420	22	10×30	0.20	230	EPAG421E□□220MJ30S
	100	10×35	0.12	510	EPAG201E□□101MJ35S		27	10×35	0.20	270	EPAG421E□□270MJ35S
	120	10×40	0.12	590	EPAG201E□□121MJ40S		33	10×40	0.20	310	EPAG421E□□330MJ40S
	150	12.5×30	0.12	650	EPAG201E□□151MK30S		39	12.5×30	0.20	330	EPAG421E□□390MK30S
	180	12.5×35	0.12	750	EPAG201E□□181MK35S		47	12.5×35	0.20	390	EPAG421E□□470MK35S
	220	12.5×40	0.12	830	EPAG201E□□221MK40S		56	12.5×40	0.20	430	EPAG421E□□560MK40S
	220	14.5×30	0.12	830	EPAG201E□□221MU30S		56	14.5×30	0.20	430	EPAG421E□□560MU30S
	270	14.5×35	0.12	960	EPAG201E□□271MU35S		68	14.5×35	0.20	510	EPAG421E□□680MU35S
	270	16×30	0.12	960	EPAG201E□□271ML30S		68	16×30	0.20	510	EPAG421E□□680ML30S
	330	16×35	0.12	1,100	EPAG201E□□331ML35S		82	14.5×40	0.20	570	EPAG421E□□820MU40S
	330	18×30	0.12	1,100	EPAG201E□□331MM30S		82	16×35	0.20	570	EPAG421E□□820ML35S
	390	16×40	0.12	1,240	EPAG201E□□391ML40S		100	16×40	0.20	610	EPAG421E□□101ML40S
	390	18×35	0.12	1,240	EPAG201E□□391MM35S		100	18×30	0.20	610	EPAG421E□□101MM30S
	470	18×40	0.12	1,390	EPAG201E□□471MM40S		120	18×35	0.20	690	EPAG421E□□121MM35S
560	18×45	0.12	1,560	EPAG201E□□561MM45S	150	18×40	0.20	790	EPAG421E□□151MM40S		
400	27	10×30	0.15	260	EPAG401E□□270MJ30S	450	18	10×30	0.20	210	EPAG451E□□180MJ30S
	33	10×35	0.15	300	EPAG401E□□330MJ35S		22	10×35	0.20	240	EPAG451E□□220MJ35S
	39	10×40	0.15	340	EPAG401E□□390MJ40S		27	10×40	0.20	280	EPAG451E□□270MJ40S
	47	12.5×30	0.15	370	EPAG401E□□470MK30S		33	12.5×30	0.20	310	EPAG451E□□330MK30S
	56	12.5×35	0.15	420	EPAG401E□□560MK35S		39	12.5×35	0.20	350	EPAG451E□□390MK35S
	68	12.5×40	0.15	480	EPAG401E□□680MK40S		47	12.5×40	0.20	390	EPAG451E□□470MK40S
	68	14.5×30	0.15	480	EPAG401E□□680MU30S		47	14.5×30	0.20	390	EPAG451E□□470MU30S
	82	14.5×35	0.15	530	EPAG401E□□820MU35S		56	14.5×35	0.20	440	EPAG451E□□560MU35S
	100	14.5×40	0.15	580	EPAG401E□□101MU40S		56	16×30	0.20	440	EPAG451E□□560ML30S
	100	16×30	0.15	580	EPAG401E□□101ML30S		68	14.5×40	0.20	500	EPAG451E□□680MU40S
	120	16×35	0.15	670	EPAG401E□□121ML35S		68	16×35	0.20	500	EPAG451E□□680ML35S
	120	18×30	0.15	670	EPAG401E□□121MM30S		82	16×40	0.20	550	EPAG451E□□820ML40S
	150	16×40	0.15	770	EPAG401E□□151ML40S		82	18×30	0.20	550	EPAG451E□□820MM30S
	150	18×35	0.15	770	EPAG401E□□151MM35S		100	18×35	0.20	650	EPAG451E□□101MM35S
180	18×40	0.15	880	EPAG401E□□181MM40S	120	18×40	0.20	740	EPAG451E□□121MM40S		
220	18×45	0.15	1,000	EPAG401E□□221MM45S	150	18×45	0.20	810	EPAG451E□□151MM45S		

□□ : Enter the appropriate lead forming or taping code.

◆RATED RIPPLE CURRENT MULTIPLIERS

● Frequency Multipliers

Capacitance(μF)	Frequency(Hz)	120	1k	10k	100k
18 to 82		1.00	1.50	1.75	1.80
100 to 560		1.00	1.30	1.40	1.50

The deterioration of aluminum electrolytic capacitors accelerates their life due to the internal heating produced by ripple current. For details, refer to Section "5-3 Ripple Current Effect on Lifetime" in the catalog, Technical Note.



KLJ Series

- Doesn't spark with DC over voltage
- Endurance with ripple current : 2,000 hours at 105°C
- Non solvent resistant type
- ESR value prescribed
- RoHS2 Compliant

Doesn't spark with DC over voltage!

KLJ

↓
Downsized
↑
KLG



SPECIFICATIONS

Items	Characteristics			
Category	-25 to +105°C			
Temperature Range	-25 to +105°C			
Rated Voltage Range	200 to 450V _{dc}			
Capacitance Tolerance	±20% (M) (at 20°C, 120Hz)			
Leakage Current	I=0.04CV+100 Where, I : Max. leakage current (μA), C : Nominal capacitance (μF), V : Rated voltage (V) (at 20°C after 1 minute)			
Dissipation Factor (tan δ)	Rated voltage (V _{dc})	200V	400V	450V
	tan δ (Max.)	0.20	0.24	0.24
Low Temperature Characteristics (Max. Impedance Ratio)	Rated voltage (V _{dc})	200V	400V	450V
	Z(-25°C)/Z(+20°C)	4	6	6
Endurance	The following specifications shall be satisfied when the capacitors are restored to 20°C after subjected to DC voltage with the rated ripple current is applied (the peak voltage shall not exceed the rated voltage) for 2,000 hours at 105°C.			
	Capacitance change	≤ ±20% of the initial value		
	D.F. (tan δ)	≤200% of the initial specified value		
	Leakage current	≤The initial specified value		
Shelf Life	The following specifications shall be satisfied when the capacitors are restored to 20°C after exposing them for 1,000 hours at 105°C without voltage applied. Before the measurement, the capacitor shall be preconditioned by applying voltage according to Item 4.1 of JIS C 5101-4.			
	Capacitance change	≤ ±20% of the initial value		
	D.F. (tan δ)	≤200% of the initial specified value		
	Leakage current	≤500% of the initial specified value		

DIMENSIONS [mm]

Terminal Code : E

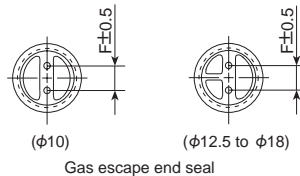
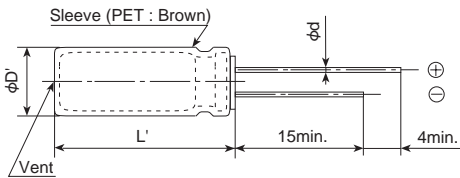

φD	10	12.5	16	18
φd	0.6	0.6	0.8	0.8
F	5.0	5.0	7.5	7.5
φD'	φD+0.5max.			
L'	L+1.5max.			

PART NUMBERING SYSTEM

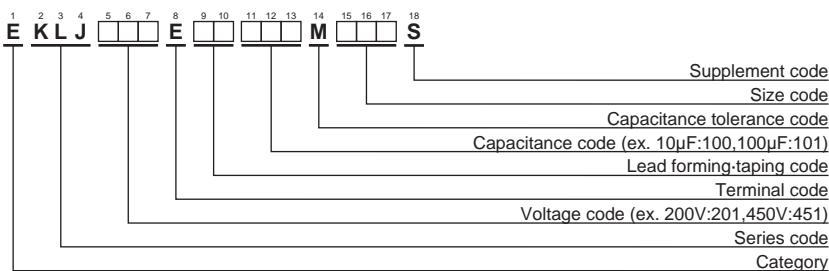

Please refer to "Product code guide (radial lead type)"

RATED RIPPLE CURRENT MULTIPLIERS

Frequency Multipliers

Capacitance(μF)	Frequency(Hz)					
	120	300	1k	10k	50k	100k
10μF	1.00	1.35	1.75	2.30	2.50	2.70
15 to 47μF	1.00	1.25	1.50	1.75	1.80	1.85
56 to 330μF	1.00	1.15	1.30	1.40	1.50	1.60

The deterioration of aluminum electrolytic capacitors accelerates their life due to the internal heating produced by ripple current. For details, refer to Section "5-3 Ripple Current Effect on Lifetime" in the catalog, Technical Note.

◆STANDARD RATINGS

WV (V _{dc})	Cap (μF)	Case size φD×L(mm)	tan δ	ESR (Ω max/20°C, 100kHz)	Rated ripple current (mA rms/105°C, 120Hz)	Part No.
200	33	10×20	0.20	1.8	165	EKLJ201E□□330MJ20S
	39	10×25	0.20	1.4	200	EKLJ201E□□390MJ25S
	56	12.5×20	0.20	1.0	265	EKLJ201E□□560MK20S
	82	12.5×25	0.20	0.72	350	EKLJ201E□□820MK25S
	100	16×20	0.20	0.63	390	EKLJ201E□□101ML20S
	120	16×25	0.20	0.44	465	EKLJ201E□□121ML25S
	150	18×20	0.20	0.31	505	EKLJ201E□□151MM20S
	180	16×31.5	0.20	0.36	615	EKLJ201E□□181MLN3S
	180	18×25	0.20	0.30	585	EKLJ201E□□181MM25S
	220	16×35.5	0.20	0.30	695	EKLJ201E□□221MLP1S
	220	18×31.5	0.20	0.28	700	EKLJ201E□□221MMN3S
270	18×35.5	0.20	0.24	805	EKLJ201E□□271MMP1S	
330	18×40	0.20	0.21	900	EKLJ201E□□331MM40S	
400	10	10×16	0.24	5.7	64	EKLJ401E□□100MJ16S
	15	10×20	0.24	4.0	105	EKLJ401E□□150MJ20S
	18	10×25	0.24	3.2	110	EKLJ401E□□180MJ25S
	22	12.5×20	0.24	2.7	165	EKLJ401E□□220MK20S
	27	12.5×25	0.24	1.9	200	EKLJ401E□□270MK25S
	33	16×20	0.24	1.5	225	EKLJ401E□□330ML20S
	39	18×20	0.24	1.2	255	EKLJ401E□□390MM20S
	47	16×25	0.24	1.1	290	EKLJ401E□□470ML25S
	47	18×20	0.24	1.2	280	EKLJ401E□□470MM20S
	56	16×31.5	0.24	0.84	340	EKLJ401E□□560MLN3S
	68	16×35.5	0.24	0.72	385	EKLJ401E□□680MLP1S
	68	18×25	0.24	0.88	360	EKLJ401E□□680MM25S
	82	16×40	0.24	0.65	435	EKLJ401E□□820ML40S
	82	18×31.5	0.24	0.64	425	EKLJ401E□□820MMN3S
100	18×35.5	0.24	0.54	490	EKLJ401E□□101MMP1S	
120	18×40	0.24	0.49	540	EKLJ401E□□121MM40S	
450	39	16×25	0.24	1.4	265	EKLJ451E□□390ML25S
	39	18×20	0.24	1.4	255	EKLJ451E□□390MM20S
	47	16×25	0.24	1.3	290	EKLJ451E□□470ML25S
	47	18×25	0.24	1.2	320	EKLJ451E□□470MM25S
	56	16×31.5	0.24	1.1	340	EKLJ451E□□560MLN3S
	68	16×35.5	0.24	0.86	420	EKLJ451E□□680MLP1S
	68	18×31.5	0.24	0.91	390	EKLJ451E□□680MMN3S
	82	16×40	0.24	0.79	435	EKLJ451E□□820ML40S
	82	18×31.5	0.24	0.78	425	EKLJ451E□□820MMN3S
	100	18×40	0.24	0.67	490	EKLJ451E□□101MM40S
	110	18×40	0.24	0.59	540	EKLJ451E□□111MM40S
120	18×45	0.24	0.58	570	EKLJ451E□□121MM45S	

□□ : Enter the appropriate lead forming or taping code.

◆DC OVERVOLTAGE TEST CONDITIONS

The vent will operate and the capacitor shall become an open circuit without burning materials when the following excess DC voltage is applied.

●Test DC voltage

Rated voltage	Nominal capacitance	Current limit	Test DC voltage
200V _{dc}	<330μF	4A	300/375V _{dc}
	330μF	5A	
400V _{dc}	<100μF	2A	500/600V _{dc}
	100μF ≤ C ≤ 120μF	4A	
450V _{dc}	<100μF	2A	550/675V _{dc}
	100μF ≤ C ≤ 120μF	4A	

●Test circuit

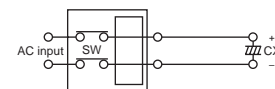

Constant DC voltage/current power supply



KXF Series

- For LED light circuits and other long life applications
- Rated voltage range : 160 to 450 V_{dc} , Capacitance range : 5.6 to 68μF
- Endurance with ripple current : 15,000 to 20,000 hours at 105°C
- Non solvent resistant type
- RoHS2 Compliant

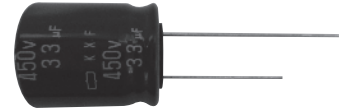

SPECIFICATIONS

Items	Characteristics		
Category	-40 to +105°C		
Temperature Range	-40 to +105°C		
Rated Voltage Range	160 to 450V _{dc}		
Capacitance Tolerance	±20% (M) (at 20°C, 120Hz)		
Leakage Current	After 1 minute	After 5 minutes	
	I=0.04CV+100	I=0.02CV+25	
	Where, I : Max. leakage current (μA), C : Nominal capacitance (μF), V : Rated voltage (V) (at 20°C)		
Dissipation Factor (tan δ)	Rated voltage (V _{dc})	160 to 450V	
	tan δ (Max.)	0.24	(at 20°C, 120Hz)
Low Temperature Characteristics (Max. Impedance Ratio)	Rated voltage (V _{dc})	160 to 250V	400, 450V
	Z(-25°C)/Z(+20°C)	3	6
	Z(-40°C)/Z(+20°C)	8	10
	(at 120Hz)		
Endurance	The following specifications shall be satisfied when the capacitors are restored to 20°C after subjected to DC voltage with the rated ripple current is applied (the peak voltage shall not exceed the rated voltage) for 20,000 hours (15,000 hours for φ10×12.5L) at 105°C.		
	Capacitance change	≤ ±30% of the initial value	
	D.F. (tan δ)	≤300% of the initial specified value	
	Leakage current	≤The initial specified value	
Shelf Life	The following specifications shall be satisfied when the capacitors are restored to 20°C after exposing them for 1,000 hours at 105°C without voltage applied. Before the measurement, the capacitor shall be preconditioned by applying voltage according to Item 4.1 of JIS C 5101-4.		
	Capacitance change	≤ ±30% of the initial value	
	D.F. (tan δ)	≤300% of the initial specified value	
	Leakage current	≤500% of the initial specified value	

DIMENSIONS [mm]

- Terminal Code : E

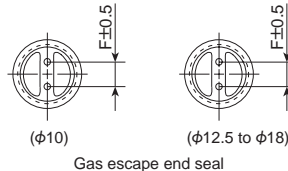
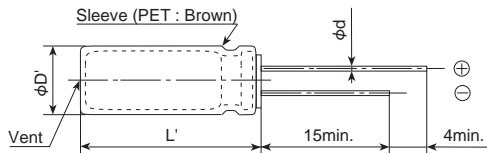

φD	10	12.5	16	18
φd	0.6	0.6	0.8	0.8
F	5.0	5.0	7.5	7.5
φD'	φD+0.5max.			
L'	L+1.5max.			

PART NUMBERING SYSTEM

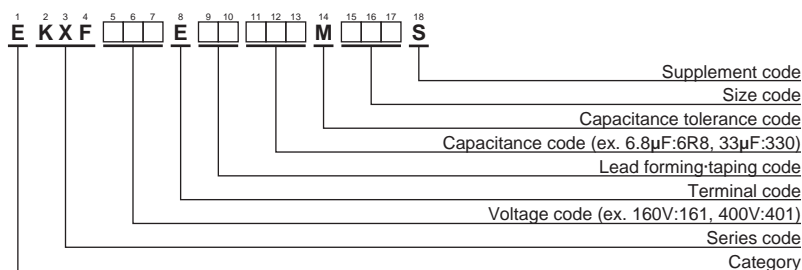

Please refer to "Product code guide (radial lead type)"

RATED RIPPLE CURRENT MULTIPLIERS

- Frequency Multipliers

Capacitance(μF)	Frequency(Hz)			
	120	1k	10k	100k
5.6 ~ 68	1.00	1.75	2.25	2.50

The deterioration of aluminum electrolytic capacitors accelerates their life due to the internal heating produced by ripple current. For details, refer to Section "5-3 Ripple Current Effect on Lifetime" in the catalog, Technical Note.



KXF Series

◆STANDARD RATINGS

WV (V _{dc})	Cap (μF)	Case size φD×L(mm)	tan δ	Rated ripple current (mA _{rms} /105°C, 120Hz)	Part No.
160	22	10 × 12.5	0.24	121	EKXF161E□□220MJC5S
	33	10 × 16	0.24	158	EKXF161E□□330MJ16S
200	18	10 × 12.5	0.24	113	EKXF201E□□180MJC5S
	27	10 × 16	0.24	149	EKXF201E□□270MJ16S
250	10	10 × 12.5	0.24	90	EKXF251E□□100MJC5S
	12	10 × 12.5	0.24	97	EKXF251E□□120MJC5S
	18	10 × 16	0.24	129	EKXF251E□□180MJ16S
400	5.6	10 × 12.5	0.24	64	EKXF401E□□5R6MJC5S
	8.2	10 × 16	0.24	88	EKXF401E□□8R2MJ16S
450	6.8	10 × 16	0.24	62	EKXF451E□□6R8MJ16S
	8.2	10 × 16	0.24	88	EKXF451E□□8R2MJ16S
	10	10 × 20	0.24	92	EKXF451E□□100MJ20S
	15	12.5 × 20	0.24	140	EKXF451E□□150MK20S
	22	12.5 × 25	0.24	240	EKXF451E□□220MK25S
	27	16 × 20	0.24	305	EKXF451E□□270ML20S
	33	16 × 25	0.24	392	EKXF451E□□330ML25S
	33	18 × 20	0.24	312	EKXF451E□□330MM20S
	47	18 × 25	0.24	480	EKXF451E□□470MM25S
68	18 × 31.5	0.24	520	EKXF451E□□680MMN3S	

□□ : Enter the appropriate lead forming or taping code.



LE Series

- Suitable for long life products
- Downsize and long life
- Endurance with ripple current : 10,000 hours at 105°C
- Case size range : $\phi 5 \times 11L$ to $\phi 8 \times 11.5L$
- Solvent resistant type (see PRECAUTIONS AND GUIDELINES)
- RoHS2 Compliant



◆ SPECIFICATION

Items	Characteristics							
Category	-40 to +105°C							
Temperature Range								
Rated Voltage Range	10 to 100V _{dc}							
Capacitance Tolerance	±20% (M) (at 20°C, 120Hz)							
Leakage Current	I=0.01CV or 3μA, whichever is greater. Where, I : Max. leakage current (μA), C : Nominal capacitance (μF), V : Rated voltage (V) (at 20°C after 2 minutes)							
Dissipation Factor (tan δ)	Rated voltage (V _{dc})	10V	16V	25V	35V	50V	63V	100V
	tan δ (Max.)	0.45	0.35	0.30	0.22	0.19	0.17	0.15
Low Temperature Characteristics (Max. Impedance Ratio)	Rated voltage (V _{dc})	10V	16V	25V	35V	50V	63V	100V
	Z(-25°C)/Z(20°C)	8	6	4	4	3	3	3
Endurance	The following specifications shall be satisfied when the capacitors are restored to 20°C after subjected to DC voltage with the rated ripple current is applied (the peak voltage shall not exceed the rated voltage) for 10,000 hours at 105°C.							
	Capacitance change	≤ ±25% of the initial value						
	D.F. (tan δ)	≤ 300% of the initial specified value						
	Leakage current	≤ The initial specified value						
Shelf Life	The following specifications shall be satisfied when the capacitors are restored to 20°C after exposing them for 1,000 hours at 105°C without voltage applied. Before the measurement, the capacitor shall be preconditioned by applying voltage according to Item 4.1 of JIS C 5101-4.							
	Capacitance change	≤ ±25% of the initial value						
	D.F. (tan δ)	≤ 300% of the initial specified value						
	Leakage current	≤ The initial specified value						

◆ DIMENSIONS [mm]

● Terminal Code : E

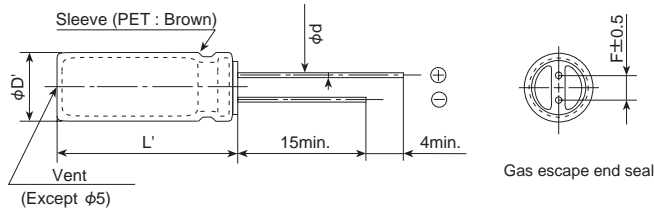

φD	5	6.3	8
φd	0.5	0.5	0.6
F	2.0	2.5	3.5
φD'	φD+0.5max.		
L'	L+1.5max.		

◆ PART NUMBERING SYSTEM

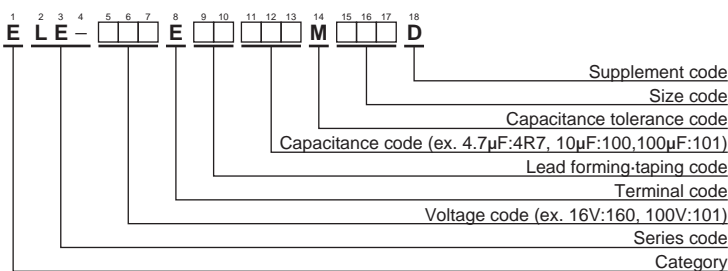

Please refer to "Product code guide (radial lead type)"



LE Series

◆STANDARD RATINGS

WV (V _{dc})	Cap (μF)	Case size φD×L(mm)	tan δ	Rated ripple current (mA _{rms} /105°C, 100kHz)	Part No.
10	100	5 × 11	0.45	130	ELE-100E□□101ME11D
	220	6.3 × 11	0.45	210	ELE-100E□□221MF11D
	330	8 × 11.5	0.45	330	ELE-100E□□331MHB5D
16	47	5 × 11	0.35	130	ELE-160E□□470ME11D
	100	6.3 × 11	0.35	210	ELE-160E□□101MF11D
	220	8 × 11.5	0.35	330	ELE-160E□□221MHB5D
25	33	5 × 11	0.30	130	ELE-250E□□330ME11D
	47	5 × 11	0.30	130	ELE-250E□□470ME11D
	100	6.3 × 11	0.30	210	ELE-250E□□101MF11D
35	33	5 × 11	0.22	130	ELE-350E□□330ME11D
	47	6.3 × 11	0.22	210	ELE-350E□□470MF11D
	100	8 × 11.5	0.22	330	ELE-350E□□101MHB5D
50	1.0	5 × 11	0.19	25	ELE-500E□□1R0ME11D
	2.2	5 × 11	0.19	35	ELE-500E□□2R2ME11D
	3.3	5 × 11	0.19	70	ELE-500E□□3R3ME11D
	4.7	5 × 11	0.19	80	ELE-500E□□4R7ME11D
	10	5 × 11	0.19	90	ELE-500E□□100ME11D
	22	5 × 11	0.19	110	ELE-500E□□220ME11D
	33	6.3 × 11	0.19	190	ELE-500E□□330MF11D
	47	6.3 × 11	0.19	190	ELE-500E□□470MF11D
63	10	5 × 11	0.17	80	ELE-630E□□100ME11D
	22	6.3 × 11	0.17	170	ELE-630E□□220MF11D
	33	6.3 × 11	0.17	170	ELE-630E□□330MF11D
	47	8 × 11.5	0.17	240	ELE-630E□□470MHB5D
100	1.0	5 × 11	0.15	40	ELE-101E□□1R0ME11D
	2.2	5 × 11	0.15	50	ELE-101E□□2R2ME11D
	3.3	5 × 11	0.15	60	ELE-101E□□3R3ME11D
	4.7	5 × 11	0.15	70	ELE-101E□□4R7ME11D
	10	6.3 × 11	0.15	150	ELE-101E□□100MF11D
	22	8 × 11.5	0.15	230	ELE-101E□□220MHB5D

□□ : Enter the appropriate lead forming or taping code.

Production of the products shown in is scheduled to be discontinued.

◆RATED RIPPLE CURRENT MULTIPLIERS

●Frequency Multipliers

Capacitance(μF)	Frequency(Hz)			
	120	1k	10k	100k
1.0 to 10	0.42	0.60	0.80	1.00
22 to 33	0.55	0.75	0.90	1.00
47 to 330	0.70	0.85	0.95	1.00

The deterioration of aluminum electrolytic capacitors accelerates their life due to the internal heating produced by ripple current. For details, refer to Section "5-3 Ripple Current Effect on Lifetime" in the catalog, Technical Note.

GPA Series

- Guaranteed short time at 150°C
- Downsized, low impedance and high-ripple current version of GXE series
- Specified ESR after endurance test
- For high ripple current automotive applications.
(Direct fuel injection and electric power steering etc.)
- Endurance with ripple current : 3,000 to 5,000 hours at 125°C
- Solvent resistant type (see PRECAUTIONS AND GUIDELINES)
- RoHS2 Compliant
- AEC-Q200 compliant : Please contact Chemi-Con for more details, test data, information.



SPECIFICATIONS

Items	Characteristics						
Category Temperature Range	-40 to +125°C						
Rated Voltage Range	25 to 100V _{dc}						
Capacitance Tolerance	±20% (M) (at 20°C, 120Hz)						
Leakage Current	I=0.03CV or 4μA, whichever is greater. Where, I : Max. leakage current (μA), C : Nominal capacitance (μF), V : Rated voltage (V) (at 20°C, 1 minute)						
Dissipation Factor (tan δ)	Rated voltage (V _{dc})	25V	35V	50V	63V	80V	100V
	tan δ (Max.)	0.14	0.12	0.10	0.10	0.08	0.08
	When nominal capacitance exceeds 1,000μF, add 0.02 to the value above for each 1,000μF increase. (at 20°C, 120Hz)						
Low Temperature Characteristics (Max. Impedance Ratio)	Rated voltage (V _{dc})	25V	35V	50V	63V	80V	100V
	Z(-25°C)/Z(+20°C)	2	2	2	2	2	2
	Z(-40°C)/Z(+20°C)	4	4	4	4	4	4
(at 120Hz)							
Endurance 1	The following specifications shall be satisfied when the capacitors are restored to 20°C after subjected to DC voltage with the rated ripple current is applied (the peak voltage shall not exceed the rated voltage) for 5,000 hours (3,000 hours for 25L and less) at 125 °C.						
	Capacitance change	≤ ±30% of the initial value					
	D.F. (tan δ)	≤300% of the initial specified value					
	Leakage current	≤The initial specified value					
Endurance 2	The following specifications shall be satisfied when the capacitors are restored to 20°C after the test condition that the rated voltage is applied for 100 hours at 150°C and DC voltage with the rated ripple current is applied (the peak voltage shall not exceed the rated voltage) for 4,500 hours (2,500 hours for 25L and less) at 125°C.						
	Capacitance change	≤ ±30% of the initial value					
	D.F. (tan δ)	≤300% of the initial specified value					
	Leakage current	≤The initial specified value					
Shelf Life	The following specifications shall be satisfied when the capacitors are restored to 20°C after exposing them for 1,000 hours at 125°C without voltage applied. Before the measurement, the capacitor shall be preconditioned by applying voltage according to Item 4.1 of JIS C 5101-4.						
	Capacitance change	≤ ±30% of the initial value					
	D.F. (tan δ)	≤300% of the initial specified value					
	Leakage current	≤The initial specified value					

DIMENSIONS [mm]

- Terminal Code : E

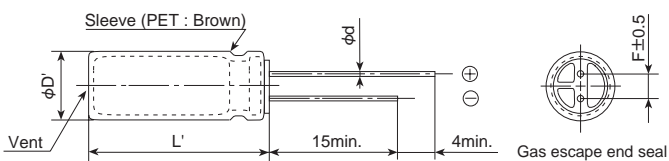

φD	12.5	14.5	16	18
φd	0.6	0.8	0.8	0.8
F	5.0	7.5	7.5	7.5
φD'	φD+0.5max.			
L'	L+1.5max.			

PART NUMBERING SYSTEM

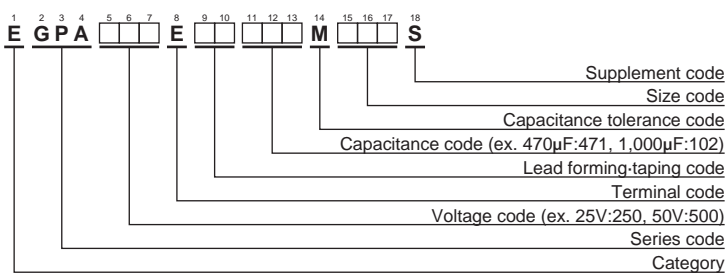

Please refer to "Product code guide (radial lead type)"



GPA Series

◆ STANDARD RATINGS

WV (V _{ac})	Cap (μF)	Case size φD×L(mm)	tan δ	ESR (Initial) (Ω max./100kHz)		ESR (End of Life) (Ω max./100kHz)		Rated ripple current (mA rms/125°C, 100kHz)	Part No.
				20°C	-40°C	20°C	-40°C		
25	1,200	12.5×20	0.14	0.044	0.22	0.18	2.2	1,820	EGPA250E□□122MK20S
	1,500	14.5×20	0.14	0.037	0.19	0.11	1.3	2,100	EGPA250E□□152MU20S
	1,800	12.5×25	0.14	0.033	0.17	0.13	1.6	2,400	EGPA250E□□182MK25S
	1,800	16×20	0.14	0.034	0.17	0.10	1.3	2,280	EGPA250E□□182ML20S
	2,200	12.5×30	0.16	0.029	0.13	0.11	1.3	2,560	EGPA250E□□222MK30S
	2,200	14.5×25	0.16	0.028	0.14	0.080	0.90	2,800	EGPA250E□□222MU25S
	2,700	12.5×35	0.16	0.024	0.11	0.090	0.80	2,970	EGPA250E□□272MK35S
	2,700	14.5×30	0.16	0.023	0.10	0.070	0.70	3,060	EGPA250E□□272MU30S
	2,700	16×25	0.16	0.026	0.13	0.080	1.1	3,100	EGPA250E□□272ML25S
	2,700	18×20	0.16	0.032	0.16	0.090	0.60	2,490	EGPA250E□□272MM20S
	3,300	12.5×40	0.18	0.021	0.095	0.080	0.50	3,600	EGPA250E□□332MK40S
	3,300	14.5×35	0.18	0.021	0.095	0.060	0.70	3,380	EGPA250E□□332MU35S
	3,300	16×30	0.18	0.023	0.10	0.070	0.90	3,160	EGPA250E□□332ML30S
	3,900	16×35	0.18	0.020	0.090	0.060	0.70	3,590	EGPA250E□□392ML35S
	3,900	18×25	0.18	0.024	0.12	0.070	0.50	3,200	EGPA250E□□392MM25S
	4,700	14.5×40	0.20	0.018	0.081	0.050	0.50	4,000	EGPA250E□□472MU40S
	4,700	18×30	0.20	0.022	0.099	0.080	0.60	3,390	EGPA250E□□472ML30S
	5,600	16×40	0.22	0.017	0.077	0.040	0.60	4,300	EGPA250E□□562ML40S
5,600	18×35	0.22	0.019	0.086	0.070	0.50	4,200	EGPA250E□□562MM35S	
6,800	18×40	0.24	0.016	0.072	0.030	0.40	4,600	EGPA250E□□682MM40S	
35	680	12.5×20	0.12	0.044	0.22	0.18	2.2	1,820	EGPA350E□□681MK20S
	1,000	12.5×25	0.12	0.033	0.17	0.13	1.6	2,400	EGPA350E□□102MK25S
	1,000	14.5×20	0.12	0.037	0.19	0.11	1.3	2,100	EGPA350E□□102MU20S
	1,200	12.5×30	0.12	0.029	0.13	0.11	1.3	2,560	EGPA350E□□122MK30S
	1,200	14.5×25	0.12	0.028	0.14	0.080	0.90	2,800	EGPA350E□□122MU25S
	1,200	16×20	0.12	0.034	0.17	0.10	1.3	2,280	EGPA350E□□122ML20S
	1,500	12.5×35	0.12	0.024	0.11	0.090	0.80	2,970	EGPA350E□□152MK35S
	1,500	14.5×30	0.12	0.023	0.10	0.070	0.70	3,060	EGPA350E□□152MU30S
	1,500	18×20	0.12	0.032	0.16	0.090	0.60	2,490	EGPA350E□□152MM20S
	1,800	12.5×40	0.12	0.021	0.095	0.080	0.50	3,600	EGPA350E□□182MK40S
	1,800	16×25	0.12	0.026	0.13	0.080	1.1	3,100	EGPA350E□□182ML25S
	2,200	14.5×35	0.14	0.021	0.095	0.060	0.70	3,380	EGPA350E□□222MU35S
	2,200	16×30	0.14	0.023	0.10	0.070	0.90	3,160	EGPA350E□□222ML30S
	2,200	18×25	0.14	0.024	0.12	0.070	0.50	3,200	EGPA350E□□222MM25S
	2,700	14.5×40	0.14	0.018	0.081	0.050	0.50	4,000	EGPA350E□□272MU40S
	2,700	16×35	0.14	0.020	0.090	0.060	0.70	3,590	EGPA350E□□272ML35S
	2,700	18×30	0.14	0.022	0.099	0.080	0.60	3,390	EGPA350E□□272MM30S
	3,300	16×40	0.16	0.017	0.077	0.040	0.60	4,300	EGPA350E□□332ML40S
3,300	18×35	0.16	0.019	0.086	0.070	0.50	4,200	EGPA350E□□332MM35S	
4,700	18×40	0.18	0.016	0.072	0.030	0.40	4,600	EGPA350E□□472MM40S	
50	470	12.5×20	0.10	0.065	0.33	0.18	2.2	1,500	EGPA500E□□471MK20S
	560	14.5×20	0.10	0.055	0.28	0.11	1.3	1,740	EGPA500E□□561MU20S
	680	12.5×25	0.10	0.048	0.24	0.13	1.6	1,900	EGPA500E□□681MK25S
	680	16×20	0.10	0.043	0.22	0.10	1.3	2,040	EGPA500E□□681ML20S
	820	12.5×30	0.10	0.041	0.18	0.11	1.3	2,150	EGPA500E□□821MK30S
	820	14.5×25	0.10	0.040	0.20	0.080	0.90	2,190	EGPA500E□□821MU25S
	1,000	12.5×35	0.10	0.034	0.15	0.090	0.80	2,510	EGPA500E□□102MK35S
	1,000	14.5×30	0.10	0.036	0.16	0.070	0.70	2,470	EGPA500E□□102MU30S
	1,000	16×25	0.10	0.031	0.16	0.080	1.1	2,620	EGPA500E□□102ML25S
	1,000	18×20	0.10	0.039	0.20	0.090	0.60	2,240	EGPA500E□□102MM20S
	1,200	12.5×40	0.10	0.028	0.13	0.080	0.50	2,870	EGPA500E□□122MK40S
	1,200	14.5×35	0.10	0.029	0.13	0.060	0.70	2,840	EGPA500E□□122MU35S
	1,200	16×30	0.10	0.027	0.13	0.070	0.90	2,940	EGPA500E□□122ML30S
	1,200	18×25	0.10	0.029	0.15	0.070	0.50	2,750	EGPA500E□□122MM25S
	1,500	16×35	0.10	0.023	0.10	0.060	0.70	3,300	EGPA500E□□152ML35S
	1,800	14.5×40	0.10	0.024	0.11	0.050	0.50	3,230	EGPA500E□□182MU40S
	1,800	18×30	0.10	0.026	0.12	0.080	0.60	3,140	EGPA500E□□182MM30S
	2,200	16×40	0.12	0.020	0.090	0.040	0.60	3,720	EGPA500E□□222ML40S
2,200	18×35	0.12	0.022	0.10	0.070	0.50	3,510	EGPA500E□□222MM35S	
2,700	18×40	0.12	0.018	0.080	0.030	0.40	3,940	EGPA500E□□272MM40S	

□□ : Enter the appropriate lead forming or taping code.



GPA Series

◆STANDARD RATINGS

WV (V _{ac})	Cap (μF)	Case size φD×L(mm)	tan δ	ESR (Initial) (Ω max./100kHz)		ESR (End of Life) (Ω max./100kHz)		Rated ripple current (mA rms/125°C, 100kHz)	Part No.
				20°C	-40°C	20°C	-40°C		
63	470	16×20	0.10	0.085	0.58	0.19	3.0	1,790	EGPA630E□□471ML20S
	680	16×25	0.10	0.061	0.48	0.14	2.0	2,030	EGPA630E□□681ML25S
	680	18×20	0.10	0.070	0.49	0.19	3.0	1,910	EGPA630E□□681MM20S
	820	16×30	0.10	0.053	0.41	0.090	1.3	2,330	EGPA630E□□821ML30S
	1,000	16×35	0.10	0.044	0.33	0.070	0.90	2,580	EGPA630E□□102ML35S
	1,000	18×25	0.10	0.049	0.34	0.14	2.0	2,280	EGPA630E□□102MM25S
	1,200	16×40	0.10	0.036	0.26	0.060	0.80	2,900	EGPA630E□□122ML40S
	1,200	18×30	0.10	0.041	0.26	0.090	1.3	2,580	EGPA630E□□122MM30S
	1,500	18×35	0.10	0.035	0.21	0.070	0.90	2,890	EGPA630E□□152MM35S
80	1,800	18×40	0.10	0.030	0.18	0.060	0.80	3,210	EGPA630E□□182MM40S
	330	16×20	0.08	0.085	0.58	0.19	3.0	1,790	EGPA800E□□331ML20S
	470	16×25	0.08	0.061	0.48	0.14	2.0	2,030	EGPA800E□□471ML25S
	470	18×20	0.08	0.070	0.49	0.19	3.0	1,910	EGPA800E□□471MM20S
	560	16×30	0.08	0.053	0.41	0.090	1.3	2,330	EGPA800E□□561ML30S
	560	18×25	0.08	0.049	0.34	0.14	2.0	2,280	EGPA800E□□561MM25S
	680	16×35	0.08	0.044	0.33	0.070	0.90	2,580	EGPA800E□□681ML35S
	680	18×30	0.08	0.041	0.26	0.090	1.3	2,580	EGPA800E□□681MM30S
	820	16×40	0.08	0.036	0.26	0.060	0.80	2,900	EGPA800E□□821ML40S
100	820	18×35	0.08	0.035	0.21	0.070	0.90	2,890	EGPA800E□□821MM35S
	1,200	18×40	0.08	0.030	0.18	0.060	0.80	3,210	EGPA800E□□122MM40S
	200	16×20	0.08	0.11	0.88	0.25	3.9	1,580	EGPA101E□□201ML20S
	270	18×20	0.08	0.091	0.73	0.22	3.9	1,690	EGPA101E□□271MM20S
	300	16×25	0.08	0.079	0.72	0.18	2.7	1,990	EGPA101E□□301ML25S
	360	16×30	0.08	0.068	0.62	0.13	1.9	2,250	EGPA101E□□361ML30S
	390	18×25	0.08	0.064	0.50	0.15	2.7	2,110	EGPA101E□□391MM25S
	470	16×35	0.08	0.056	0.50	0.090	1.3	2,500	EGPA101E□□471ML35S
	510	18×30	0.08	0.054	0.39	0.13	1.9	2,410	EGPA101E□□511MM30S
100	560	16×40	0.08	0.046	0.39	0.080	1.1	2,700	EGPA101E□□561ML40S
	620	18×35	0.08	0.044	0.32	0.090	1.3	2,690	EGPA101E□□621MM35S
	750	18×40	0.08	0.039	0.27	0.080	1.1	2,880	EGPA101E□□751MM40S

□□ : Enter the appropriate lead forming or taping code.

◆RATED RIPPLE CURRENT MULTIPLIERS

● Frequency Multipliers

Capacitance(μF)	Frequency(Hz)			
	120	1k	10k	100k
200	0.40	0.82	0.93	1.00
270 to 560	0.50	0.85	0.94	1.00
620 to 1,800	0.60	0.87	0.95	1.00
2,200 to 3,900	0.75	0.90	0.95	1.00
4,700 to 6,800	0.85	0.95	0.98	1.00

The deterioration of aluminum electrolytic capacitors accelerates their life due to the internal heating produced by ripple current. For details, refer to Section "5-3 Ripple Current Effect on Lifetime" in the catalog, Technical Note.

Please contact us for lifetime estimation.

GVA Series

- Structure of higher vibration by GPA series (acceleration 392m/s², 40G)
- Guaranteed short time at 150°C
- Designed for electric power steering and ECU(include engine control, direct fuel injection) etc.
- Rated voltage range : 25 to 100V, Capacitance range : 430 to 5,100μF
- Solvent resistant type
- RoHS2 Compliant
- AEC-Q200 compliant : Please contact Chemi-Con for more details, test data, information.

 GPA → Vibration resistance → **GVA**

◆ SPECIFICATIONS

Items	Characteristics																					
Category	-40 to +125°C																					
Temperature Range	-40 to +125°C																					
Rated Voltage Range	25 to 100V _{dc}																					
Capacitance Tolerance	±20% (M) (at 20°C, 120Hz)																					
Leakage Current	I=0.03CV or 4μA, whichever is greater. Where, I : Max. leakage current (μA), C : Nominal capacitance (μF), V : Rated voltage (V) (at 20°C, 1 minute)																					
Dissipation Factor (tan δ)	<table border="1"> <tr> <td>Rated voltage (V_{dc})</td> <td>25V</td> <td>35V</td> <td>50V</td> <td>63V</td> <td>80V</td> <td>100V</td> </tr> <tr> <td>tan δ (Max.)</td> <td>0.14</td> <td>0.12</td> <td>0.10</td> <td>0.10</td> <td>0.08</td> <td>0.08</td> </tr> </table> When nominal capacitance exceeds 1,000μF, add 0.02 to the value above for each 1,000μF increase. (at 20°C, 120Hz)	Rated voltage (V _{dc})	25V	35V	50V	63V	80V	100V	tan δ (Max.)	0.14	0.12	0.10	0.10	0.08	0.08							
Rated voltage (V _{dc})	25V	35V	50V	63V	80V	100V																
tan δ (Max.)	0.14	0.12	0.10	0.10	0.08	0.08																
Low Temperature Characteristics (Max. Impedance Ratio)	<table border="1"> <tr> <td>Rated voltage (V_{dc})</td> <td>25V</td> <td>35V</td> <td>50V</td> <td>63V</td> <td>80V</td> <td>100V</td> </tr> <tr> <td>Z(-25°C)/Z(+20°C)</td> <td>2</td> <td>2</td> <td>2</td> <td>2</td> <td>2</td> <td>2</td> </tr> <tr> <td>Z(-40°C)/Z(+20°C)</td> <td>4</td> <td>4</td> <td>4</td> <td>4</td> <td>4</td> <td>4</td> </tr> </table> (at 120Hz)	Rated voltage (V _{dc})	25V	35V	50V	63V	80V	100V	Z(-25°C)/Z(+20°C)	2	2	2	2	2	2	Z(-40°C)/Z(+20°C)	4	4	4	4	4	4
Rated voltage (V _{dc})	25V	35V	50V	63V	80V	100V																
Z(-25°C)/Z(+20°C)	2	2	2	2	2	2																
Z(-40°C)/Z(+20°C)	4	4	4	4	4	4																
Endurance 1	The following specifications shall be satisfied when the capacitors are restored to 20°C after subjected to DC voltage with the rated ripple current is applied (the peak voltage shall not exceed the rated voltage) for 5,000 hours at 125 °C. <table border="1"> <tr> <td>Capacitance change</td> <td>≤ ±30% of the initial value</td> </tr> <tr> <td>D.F. (tan δ)</td> <td>≤300% of the initial specified value</td> </tr> <tr> <td>Leakage current</td> <td>≤The initial specified value</td> </tr> </table>	Capacitance change	≤ ±30% of the initial value	D.F. (tan δ)	≤300% of the initial specified value	Leakage current	≤The initial specified value															
Capacitance change	≤ ±30% of the initial value																					
D.F. (tan δ)	≤300% of the initial specified value																					
Leakage current	≤The initial specified value																					
Endurance 2	The following specifications shall be satisfied when the capacitors are restored to 20°C after the test condition that the rated voltage is applied for 100 hours at 150°C and DC voltage with the rated ripple current is applied (the peak voltage shall not exceed the rated voltage) for 4,500 hours at 125°C. <table border="1"> <tr> <td>Capacitance change</td> <td>≤ ±30% of the initial value</td> </tr> <tr> <td>D.F. (tan δ)</td> <td>≤300% of the initial specified value</td> </tr> <tr> <td>Leakage current</td> <td>≤The initial specified value</td> </tr> </table>	Capacitance change	≤ ±30% of the initial value	D.F. (tan δ)	≤300% of the initial specified value	Leakage current	≤The initial specified value															
Capacitance change	≤ ±30% of the initial value																					
D.F. (tan δ)	≤300% of the initial specified value																					
Leakage current	≤The initial specified value																					
Shelf Life	The following specifications shall be satisfied when the capacitors are restored to 20°C after exposing them for 1,000 hours at 125°C without voltage applied. Before the measurement, the capacitor shall be preconditioned by applying voltage according to Item 4.1 of JIS C 5101-4. <table border="1"> <tr> <td>Capacitance change</td> <td>≤ ±30% of the initial value</td> </tr> <tr> <td>D.F. (tan δ)</td> <td>≤300% of the initial specified value</td> </tr> <tr> <td>Leakage current</td> <td>≤The initial specified value</td> </tr> </table>	Capacitance change	≤ ±30% of the initial value	D.F. (tan δ)	≤300% of the initial specified value	Leakage current	≤The initial specified value															
Capacitance change	≤ ±30% of the initial value																					
D.F. (tan δ)	≤300% of the initial specified value																					
Leakage current	≤The initial specified value																					
Vibration	The following specifications shall be satisfied when the capacitors are restored to 20°C after subjected to vibration test (vibration profile shown below) at room temperature (15 to 35°C). <table border="1"> <tr> <td>Capacitance change</td> <td>≤ ±5% of the initial value</td> </tr> <tr> <td>D.F. (tan δ)</td> <td>≤The initial specified value</td> </tr> <tr> <td>Leakage current</td> <td>≤The initial specified value</td> </tr> </table> Vibration profile <table border="1"> <tr> <td>Vibration frequency range</td> <td>10 to 2,000Hz</td> </tr> <tr> <td>Amplitude or Acceleration</td> <td>1.5mm peak to peak or 392m/s²(40G), whichever is the less severe</td> </tr> <tr> <td>Sweep rate</td> <td>10 to 2,000 to 10Hz 0.5 octave/minute</td> </tr> <tr> <td>Direction and period of motion</td> <td>2 hours in each of 3 mutually perpendicular directions (total of 6hours)</td> </tr> <tr> <td>Fixation</td> <td>Fix main body and Lead terminal using a fixture tool, please contact us for detail.</td> </tr> </table>	Capacitance change	≤ ±5% of the initial value	D.F. (tan δ)	≤The initial specified value	Leakage current	≤The initial specified value	Vibration frequency range	10 to 2,000Hz	Amplitude or Acceleration	1.5mm peak to peak or 392m/s ² (40G), whichever is the less severe	Sweep rate	10 to 2,000 to 10Hz 0.5 octave/minute	Direction and period of motion	2 hours in each of 3 mutually perpendicular directions (total of 6hours)	Fixation	Fix main body and Lead terminal using a fixture tool, please contact us for detail.					
Capacitance change	≤ ±5% of the initial value																					
D.F. (tan δ)	≤The initial specified value																					
Leakage current	≤The initial specified value																					
Vibration frequency range	10 to 2,000Hz																					
Amplitude or Acceleration	1.5mm peak to peak or 392m/s ² (40G), whichever is the less severe																					
Sweep rate	10 to 2,000 to 10Hz 0.5 octave/minute																					
Direction and period of motion	2 hours in each of 3 mutually perpendicular directions (total of 6hours)																					
Fixation	Fix main body and Lead terminal using a fixture tool, please contact us for detail.																					

◆ DIMENSIONS [mm]

- Terminal Code : E

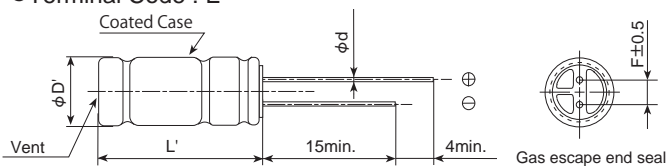

* Please contact us about lead formings and mounting methods.

φD	18
φd	0.8
F	7.5
φD'	φD±0.5
L'	+1.5 L-1.0



GVA Series

◆PART NUMBERING SYSTEM

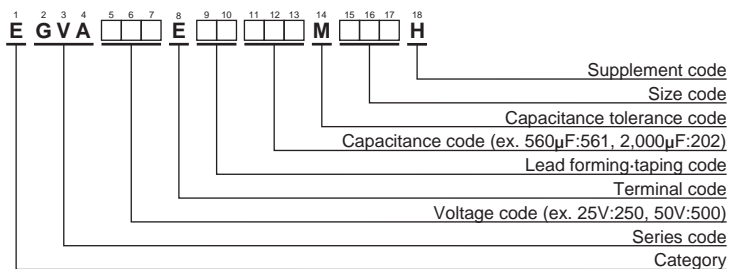

Please refer to "Product code guide (radial lead type)"

◆STANDARD RATINGS

WV (V _{dc})	Cap (μF)	Case size φD×L(mm)	tan δ	ESR (Ω max./100kHz)		Rated ripple current (mA _{rms} /125°C, 100kHz)	Part No.
				20°C	-40°C		
25	3,900	18×30	0.18	0.023	0.11	3,330	EGVA250E□□392MM30H
	5,100	18×35.5	0.22	0.019	0.086	3,750	EGVA250E□□512MMP1H
35	2,700	18×30	0.14	0.023	0.11	3,330	EGVA350E□□272MM30H
	3,600	18×35.5	0.16	0.019	0.086	3,750	EGVA350E□□362MMP1H
50	1,600	18×30	0.10	0.027	0.14	3,000	EGVA500E□□162MM30H
	2,000	18×35.5	0.12	0.022	0.10	3,450	EGVA500E□□202MMP1H
63	1,200	18×30	0.10	0.045	0.34	2,530	EGVA630E□□122MM30H
	1,500	18×35.5	0.10	0.036	0.26	2,870	EGVA630E□□152MMP1H
80	750	18×30	0.08	0.045	0.34	2,530	EGVA800E□□751MM30H
	910	18×35.5	0.08	0.036	0.26	2,870	EGVA800E□□911MMP1H
100	430	18×30	0.08	0.055	0.41	2,290	EGVA101E□□431MM30H
	560	18×35.5	0.08	0.044	0.32	2,620	EGVA101E□□561MMP1H

□□ : Enter the appropriate lead forming or taping code.

◆RATED RIPPLE CURRENT MULTIPLIERS

●Frequency Multipliers

Capacitance(μF)	Frequency(Hz)	120	1k	10k	100k
430 to 560		0.50	0.85	0.94	1.00
750 to 2,000		0.60	0.87	0.95	1.00
2,700 to 3,900		0.75	0.90	0.95	1.00
5,100		0.85	0.95	0.98	1.00

The deterioration of aluminum electrolytic capacitors accelerates their life due to the internal heating produced by ripple current. For details, refer to Section "5-3 Ripple Current Effect on Lifetime" in the catalog, Technical Note.

Please contact us for lifetime estimation.



GXM Series New!

- Suitable for high-temperature applications such as power supplies at communication base stations.
- Rated voltage range : 400 to 450V_{dc}, Capacitance range : 39 to 180μF
- Endurance with ripple current : 5,000 hours at 125°C
- Non solvent resistant type
- RoHS2 Compliant



◆ SPECIFICATIONS

Items	Characteristics	
Category Temperature Range	-40 to +125°C	
Rated Voltage Range	400 to 450V _{dc}	
Capacitance Tolerance	±20% (M) (at 20°C, 120Hz)	
Leakage Current	I=0.04CV+100 (after 1 minute) I=0.02CV+25 (after 5 minutes) Where, I : Max. leakage current(μA), C : Nominal capacitance (μF), V : Rated voltage (V) (at 20°C)	
Dissipation Factor (tan δ)	Rated voltage (V _{dc})	400 to 450V
	tan δ (Max.)	0.24 (at 20°C, 120Hz)
Low Temperature Characteristics (Max. Impedance Ratio)	Rated voltage (V _{dc})	400 to 450V
	Z(-25°C)/Z(+20°C)	6
	Z(-40°C)/Z(+20°C)	10 (at 120Hz)
Endurance	The following specifications shall be satisfied when the capacitors are restored to 20°C after subjected to DC voltage with the rated ripple current is applied (the peak voltage shall not exceed the rated voltage) for 5,000 hours at 125°C.	
	Capacitance change	≤ ±30% of the initial value
	D.F. (tan δ)	≤ 300% of the initial specified value
	Leakage current	≤ The initial specified value
Shelf Life	The following specifications shall be satisfied when the capacitors are restored to 20°C after exposing them for 500 hours at 125°C without voltage applied. Before the measurement, the capacitor shall be preconditioned by applying voltage according to Item 4.1 of JIS C 5101-4.	
	Capacitance change	≤ ±30% of the initial value
	D.F. (tan δ)	≤ 300% of the initial specified value
	Leakage current	≤ 500% of the initial specified value

◆ DIMENSIONS [mm]

- Terminal Code : E

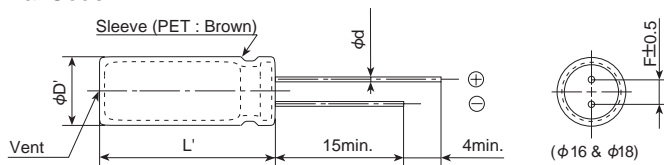

φD	16	18
φd	0.8	0.8
F	7.5	7.5
φD'	φD+0.5 max.	
L'	L+2.0 max.	

◆ PART NUMBERING SYSTEM

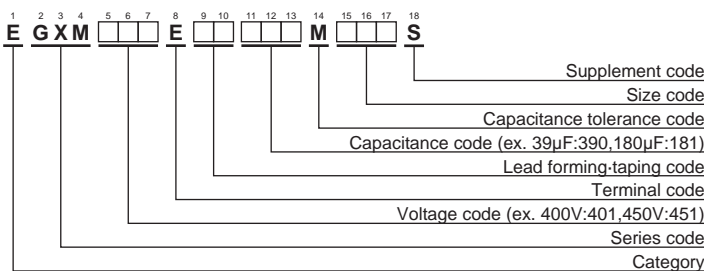

Please refer to "Product code guide (radial lead type)"



◆STANDARD RATINGS

WV (V _{dc})	Cap (μF)	Case size φD×L(mm)	tan δ	Rated ripple current (mA _{rms} /125°C, 120Hz)	Part No.
400	47	16×20	0.24	380	EGXM401E□□470ML20S
	68	16×25	0.24	550	EGXM401E□□680ML25S
	68	18×20	0.24	480	EGXM401E□□680MM20S
	100	16×30	0.24	720	EGXM401E□□101ML30S
	100	18×25	0.24	680	EGXM401E□□101MM25S
	120	16×35	0.24	810	EGXM401E□□121ML35S
	120	16×40	0.24	830	EGXM401E□□121ML40S
	120	18×30	0.24	810	EGXM401E□□121MM30S
	150	18×35	0.24	930	EGXM401E□□151MM35S
180	18×40	0.24	1,040	EGXM401E□□181MM40S	
420	47	16×20	0.24	380	EGXM421E□□470ML20S
	56	18×20	0.24	430	EGXM421E□□560MM20S
	68	16×25	0.24	550	EGXM421E□□680ML25S
	82	16×30	0.24	650	EGXM421E□□820ML30S
	82	18×25	0.24	620	EGXM421E□□820MM25S
	100	16×35	0.24	730	EGXM421E□□101ML35S
	120	16×40	0.24	830	EGXM421E□□121ML40S
	120	18×30	0.24	810	EGXM421E□□121MM30S
	150	18×35	0.24	830	EGXM421E□□121MM35S
180	18×40	0.24	950	EGXM421E□□151MM40S	
450	39	16×20	0.24	340	EGXM451E□□390ML20S
	56	16×25	0.24	500	EGXM451E□□560ML25S
	56	18×20	0.24	430	EGXM451E□□560MM20S
	82	16×30	0.24	650	EGXM451E□□820ML30S
	82	18×25	0.24	620	EGXM451E□□820MM25S
	100	16×35	0.24	730	EGXM451E□□101ML35S
	100	16×40	0.24	760	EGXM451E□□101ML40S
	100	18×30	0.24	740	EGXM451E□□101MM30S
	120	18×35	0.24	830	EGXM451E□□121MM35S
150	18×40	0.24	950	EGXM451E□□151MM40S	

□□ : Enter the appropriate lead forming or taping code.

◆RATED RIPPLE CURRENT MULTIPLIERS

●Frequency Multipliers

Capacitance(μF)	Frequency(Hz)			
	120	1k	10k	100k
39 to 82	1.00	1.60	2.20	2.50
100 to 180	1.00	1.50	2.00	2.25

The deterioration of aluminum electrolytic capacitors accelerates their life due to the internal heating produced by ripple current. For details, refer to Section "5-3 Ripple Current Effect on Lifetime" in the catalog, Technical Note.

GXF Series

- Downsizing and high-ripple current version of GXE series
- For automobile modules and networking equipment and other high temperature applications
- Endurance with ripple current : 3,000 hours at 125°C
- Solvent resistant type except 160 to 400V_{dc}
- RoHS2 Compliant
- AEC-Q200 compliant : Please contact Chemi-Con for more details, test data, information.

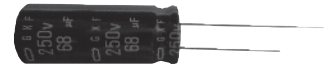

SPECIFICATIONS

Items	Characteristics								
Category	-40 to +125°C								
Temperature Range									
Rated Voltage Range	25 to 400V _{dc}								
Capacitance Tolerance	±20%(M) (20°C, 120Hz)								
Leakage Current	25 to 100V _{dc}				160 to 400V _{dc}				
	I=0.03CV or 4 μA, whichever is greater.				CV ≤ 1,000 I=0.1CV+40		CV > 1,000 I=0.04CV+100		
	Where, I : Max. leakage current (μA), C : Nominal capacitance (μF), V : Rated voltage (V) (at 20°C after 1 minute)								
Dissipation Factor (tan δ)	Rated voltage (V _{dc})	25V	35V	50V	63V	80V	100V	160 to 250V	350 to 400V
	tan δ (Max.)	0.14	0.12	0.10	0.10	0.08	0.08	0.15	0.20
	When nominal capacitance exceeds 1,000 μF, add 0.02 to the value above for each 1,000 μF increase. (at 20°C, 120Hz)								
Low Temperature Characteristics (Max. Impedance Ratio)	Rated voltage (V _{dc})	25V	35V	50V	63V	80V	100V	160 to 250V	350 to 400V
	Z(-25°C)/Z(+20°C)	2	2	2	2	2	2	3	6
	Z(-40°C)/Z(+20°C)	4	4	4	4	4	4	6	12
Endurance	The following specifications shall be satisfied when the capacitors are restored to 20°C after subjected to DC voltage with the rated ripple current is applied (the peak voltage shall not exceed the rated voltage) for the 3,000 hours at 125°C.								
	Rated Voltage	25 to 100V _{dc}				160 to 400V _{dc}			
	Capacitance change	≤ ±30% of the initial value				≤ ±20% of the initial value			
	D.F. (tan δ)	≤ 300% of the initial specified value				≤ 200% of the initial specified value			
	Leakage current	≤ The initial specified value				≤ The initial specified value			
Shelf Life	The following specifications shall be satisfied when the capacitors are restored to 20°C after exposing them for 1,000 hours (500hours for 160 to 400V _{dc}) at 125°C without voltage applied. Before the measurement, the capacitor shall be preconditioned by applying voltage according to Item 4.1 of JIS C 5101-4.								
	Rated Voltage	25 to 100V _{dc}				160 to 400V _{dc}			
	Capacitance change	≤ ±30% of the initial value				≤ ±20% of the initial value			
	D.F. (tan δ)	≤ 300% of the initial specified value				≤ 200% of the initial specified value			
	Leakage current	≤ The initial specified value				≤ 500% of the initial specified value			

DIMENSIONS [mm]

- Terminal Code : E

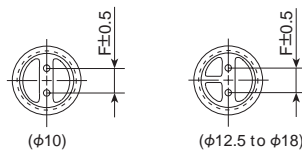
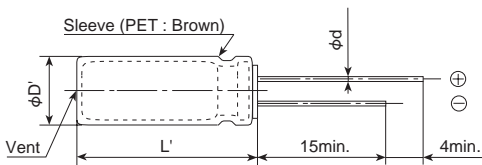

ΦD	10	12.5	14.5	16	18
Φd	0.6	0.6	0.8	0.8	0.8
F	5.0	5.0	7.5	7.5	7.5
ΦD'	ΦD+0.5max.				
L'	L+1.5max.				

PART NUMBERING SYSTEM

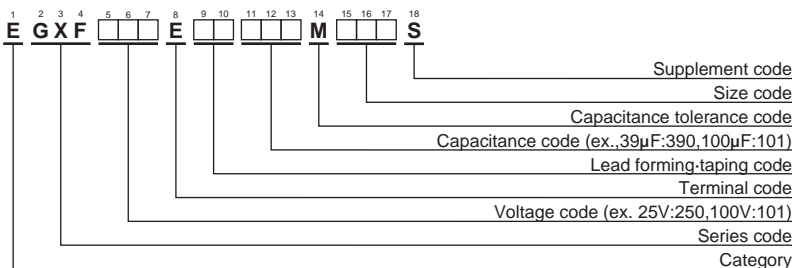

Please refer to "Product code guide (radial lead type)"



◆STANDARD RATINGS

VV (V _{dc})	Cap (μF)	Case size φDxL (mm)	ESR (Ωmax./100kHz)		Rated ripple current (mA _{rms} /125°C, 100kHz)	Part No.	VV (V _{dc})	Cap (μF)	Case size φDxL (mm)	ESR (Ωmax./100kHz)		Rated ripple current (mA _{rms} /125°C, 100kHz)	Part No.
			20°C	-40°C						20°C	-40°C		
25	510	10 × 12.5	0.14	2.1	900	EGXF250E□□511MJC5S	50	680	14.5 × 20	0.038	0.22	1,610	EGXF500E□□681MU20S
	750	10 × 16	0.094	1.5	1,300	EGXF250E□□751MJ16S		750	12.5 × 25	0.038	0.18	2,030	EGXF500E□□751MK25S
	910	12.5 × 15	0.082	1.1	1,220	EGXF250E□□911MK15S		750	18 × 15	0.085	0.87	1,370	EGXF500E□□751MM15S
	1,200	10 × 20	0.073	1.1	1,540	EGXF250E□□122MJ20S		910	16 × 20	0.037	0.17	1,740	EGXF500E□□911ML20S
	1,200	14.5 × 15	0.067	0.80	1,320	EGXF250E□□122MU15S		1,000	12.5 × 30	0.031	0.14	2,510	EGXF500E□□102MK30S
	1,500	10 × 25	0.042	0.24	1,880	EGXF250E□□152MJ25S		1,000	14.5 × 25	0.031	0.14	2,480	EGXF500E□□102MU25S
	1,600	16 × 15	0.063	0.76	1,430	EGXF250E□□162ML15S		1,200	12.5 × 35	0.027	0.11	2,900	EGXF500E□□122MK35S
	1,800	12.5 × 20	0.038	0.19	1,590	EGXF250E□□182MK20S		1,200	18 × 20	0.036	0.14	1,830	EGXF500E□□122MM20S
	2,000	10 × 30	0.033	0.19	2,150	EGXF250E□□202MJ30S		1,300	14.5 × 30	0.026	0.11	2,870	EGXF500E□□132MU30S
	2,200	14.5 × 20	0.030	0.17	1,780	EGXF250E□□222MU20S		1,300	16 × 25	0.027	0.13	2,690	EGXF500E□□132ML25S
	2,400	18 × 15	0.053	0.51	1,630	EGXF250E□□242MM15S		1,500	12.5 × 40	0.023	0.090	3,260	EGXF500E□□152MK40S
	2,700	12.5 × 25	0.030	0.14	2,280	EGXF250E□□272MK25S		1,500	14.5 × 35	0.023	0.085	3,160	EGXF500E□□152MM35S
	3,000	16 × 20	0.029	0.13	1,890	EGXF250E□□302ML20S		1,600	16 × 30	0.023	0.094	3,150	EGXF500E□□162ML30S
	3,300	12.5 × 30	0.025	0.10	2,760	EGXF250E□□332MK30S		1,800	18 × 25	0.025	0.11	2,900	EGXF500E□□182MM25S
	3,600	14.5 × 25	0.025	0.11	2,760	EGXF250E□□362MU25S		2,000	14.5 × 40	0.020	0.072	3,560	EGXF500E□□202MU40S
	4,300	12.5 × 35	0.022	0.080	3,120	EGXF250E□□432MK35S		2,000	16 × 35	0.020	0.074	3,470	EGXF500E□□202ML35S
	4,300	16 × 25	0.022	0.092	3,030	EGXF250E□□432ML25S		2,200	18 × 30	0.021	0.079	3,330	EGXF500E□□222MM30S
	4,300	18 × 20	0.028	0.10	1,930	EGXF250E□□432MM20S		2,400	16 × 40	0.018	0.063	3,800	EGXF500E□□242ML40S
	4,700	14.5 × 30	0.020	0.081	3,090	EGXF250E□□472MU30S		2,700	18 × 35	0.019	0.065	3,590	EGXF500E□□272MM35S
	5,100	12.5 × 40	0.019	0.068	3,610	EGXF250E□□512MK40S		3,300	18 × 40	0.017	0.058	3,850	EGXF500E□□332MM40S
	5,100	14.5 × 35	0.018	0.065	3,430	EGXF250E□□512MU35S		390	12.5 × 20	0.097	0.75	1,310	EGXF630E□□391MK20S
	5,100	16 × 30	0.018	0.071	3,330	EGXF250E□□512ML30S		510	12.5 × 25	0.072	0.55	1,880	EGXF630E□□511MK25S
	5,600	18 × 25	0.020	0.078	3,200	EGXF250E□□562MM25S		510	14.5 × 20	0.072	0.59	1,510	EGXF630E□□511MU20S
	6,800	14.5 × 40	0.016	0.054	3,820	EGXF250E□□682MU40S		620	16 × 20	0.062	0.39	1,630	EGXF630E□□621ML20S
	6,800	16 × 35	0.016	0.056	3,630	EGXF250E□□682ML35S		680	12.5 × 30	0.052	0.37	2,410	EGXF630E□□681MK30S
7,500	18 × 30	0.016	0.060	3,480	EGXF250E□□752MM30S	680	14.5 × 25	0.054	0.40	2,130	EGXF630E□□681MU25S		
8,200	16 × 40	0.015	0.048	3,930	EGXF250E□□822ML40S	820	12.5 × 35	0.044	0.29	2,760	EGXF630E□□821MK35S		
9,100	18 × 35	0.015	0.049	3,750	EGXF250E□□912MM35S	820	18 × 20	0.055	0.29	1,750	EGXF630E□□821MM20S		
11,000	18 × 40	0.014	0.043	4,040	EGXF250E□□113MM40S	910	14.5 × 30	0.042	0.30	2,700	EGXF630E□□911MU30S		
35	300	10 × 12.5	0.14	2.1	900	EGXF350E□□301MJC5S	63	910	16 × 25	0.047	0.27	2,300	EGXF630E□□911ML25S
	510	10 × 16	0.094	1.5	1,300	EGXF350E□□511MJ16S		1,000	12.5 × 40	0.038	0.26	3,080	EGXF630E□□102MK40S
	560	12.5 × 15	0.082	1.1	1,220	EGXF350E□□561MK15S		1,100	14.5 × 35	0.037	0.24	2,940	EGXF630E□□112MU35S
	680	10 × 20	0.073	1.1	1,540	EGXF350E□□681MJ20S		1,100	16 × 30	0.037	0.23	2,940	EGXF630E□□112ML30S
	750	14.5 × 15	0.067	0.80	1,320	EGXF350E□□751MU15S		1,200	18 × 25	0.044	0.22	2,440	EGXF630E□□122MM25S
	820	10 × 25	0.042	0.24	1,880	EGXF350E□□821MJ25S		1,300	14.5 × 40	0.032	0.20	3,350	EGXF630E□□132MU40S
	1,100	12.5 × 20	0.038	0.19	1,590	EGXF350E□□112MK20S		1,300	16 × 35	0.031	0.17	3,220	EGXF630E□□132ML35S
	1,100	16 × 15	0.063	0.76	1,430	EGXF350E□□112ML15S		1,500	18 × 30	0.037	0.18	3,100	EGXF630E□□152MM30S
	1,200	10 × 30	0.033	0.19	2,150	EGXF350E□□122MJ30S		1,800	16 × 40	0.028	0.15	3,590	EGXF630E□□182ML40S
	1,500	12.5 × 25	0.030	0.14	2,280	EGXF350E□□152MK25S		2,000	18 × 35	0.028	0.13	3,450	EGXF630E□□202MM35S
	1,500	14.5 × 20	0.030	0.17	1,780	EGXF350E□□152MU20S		2,400	18 × 40	0.023	0.10	3,690	EGXF630E□□242MM40S
	1,500	18 × 15	0.053	0.51	1,630	EGXF350E□□152MM15S		240	12.5 × 20	0.097	0.75	1,310	EGXF800E□□241MK20S
	2,000	12.5 × 30	0.025	0.10	2,760	EGXF350E□□202MK30S		330	12.5 × 25	0.072	0.55	1,880	EGXF800E□□331MK25S
	2,000	16 × 20	0.029	0.13	1,890	EGXF350E□□202ML20S		330	14.5 × 20	0.072	0.59	1,510	EGXF800E□□331MU20S
	2,200	14.5 × 25	0.025	0.11	2,760	EGXF350E□□222MU25S		390	16 × 20	0.062	0.39	1,630	EGXF800E□□391ML20S
	2,400	12.5 × 35	0.022	0.080	3,120	EGXF350E□□242MK35S		430	12.5 × 30	0.052	0.37	2,410	EGXF800E□□431MK30S
	2,400	16 × 25	0.022	0.092	3,030	EGXF350E□□242ML25S		470	14.5 × 25	0.054	0.40	2,130	EGXF800E□□471MU25S
	2,400	18 × 20	0.028	0.10	1,930	EGXF350E□□242MM20S		560	12.5 × 35	0.044	0.29	2,760	EGXF800E□□561MK35S
	2,700	12.5 × 40	0.019	0.068	3,610	EGXF350E□□272MK40S		560	16 × 25	0.047	0.27	2,300	EGXF800E□□561ML25S
	2,700	14.5 × 30	0.020	0.081	3,090	EGXF350E□□272MJ30S		560	18 × 20	0.055	0.29	1,750	EGXF800E□□561MM20S
	3,000	14.5 × 35	0.018	0.065	3,430	EGXF350E□□302MU35S		620	12.5 × 40	0.038	0.26	3,080	EGXF800E□□621MK40S
	3,300	16 × 30	0.018	0.071	3,330	EGXF350E□□332ML30S		620	14.5 × 30	0.042	0.30	2,700	EGXF800E□□621MU30S
	3,300	18 × 25	0.020	0.078	3,200	EGXF350E□□332MM25S		680	14.5 × 35	0.037	0.24	2,940	EGXF800E□□681MK35S
	3,900	14.5 × 40	0.016	0.054	3,820	EGXF350E□□392MU40S		680	16 × 30	0.037	0.23	2,940	EGXF800E□□681ML30S
	4,300	16 × 35	0.016	0.056	3,630	EGXF350E□□432ML35S		750	18 × 25	0.044	0.22	2,440	EGXF800E□□751MM25S
4,300	18 × 30	0.016	0.060	3,480	EGXF350E□□432MM30S	820	14.5 × 40	0.032	0.20	3,350	EGXF800E□□821MU40S		
4,700	16 × 40	0.015	0.048	3,930	EGXF350E□□472ML40S	910	16 × 35	0.031	0.17	3,220	EGXF800E□□911ML35S		
5,100	18 × 35	0.015	0.049	3,750	EGXF350E□□512MM35S	910	18 × 30	0.037	0.18	3,100	EGXF800E□□911MM30S		
6,200	18 × 40	0.014	0.043	4,040	EGXF350E□□622MM40S	1,100	16 × 40	0.028	0.15	3,590	EGXF800E□□112ML40S		
50	160	10 × 12.5	0.24	3.6	730	EGXF500E□□161MJC5S	100	1,300	18 × 35	0.028	0.13	3,450	EGXF800E□□132MM35S
	240	10 × 16	0.16	2.5	1,080	EGXF500E□□241MJ16S		1,500	18 × 40	0.023	0.10	3,690	EGXF800E□□152MM40S
	270	12.5 × 15	0.14	1.8	1,020	EGXF500E□□271MK15S		130	12.5 × 20	0.12	0.94	1,210	EGXF101E□□131MK20S
	330	10 × 20	0.12	1.8	1,290	EGXF500E□□331MJ20S		180	14.5 × 20	0.082	0.69	1,450	EGXF101E□□181MU20S
	390	14.5 × 15	0.12	1.4	1,090	EGXF500E□□391MU15S		200	12.5 × 25	0.082	0.70	1,800	EGXF101E□□201MK25S
	430	10 × 25	0.055	0.31	1,740	EGXF500E□□431MJ25S		240	12.5 × 30	0.062	0.52	2,290	EGXF101E□□241MK30S
	510	12.5 × 20	0.049	0.24	1,410	EGXF500E□□511MK20S		240	16 × 20	0.071	0.53	1,580	EGXF101E□□241ML20S
	560	10 × 30	0.041	0.25	2,020	EGXF500E□□561MJ30S		270	14.5 × 25	0.064	0.52	2,050	EGXF101E□□271MU25S
	560	16 × 15	0.11	1.3	1,190	EGXF500E□□561ML15S		330	12.5 × 35	0.051	0.38	2,680	EGXF101E□□331MK35S

Product specifications in this catalog are subject to change without notice. Request our product specifications before purchase and/or use. Please use our products based on the information contained in this catalog and product specifications.



◆STANDARD RATINGS

VV (V _{dc})	Cap (μF)	Case size φDxL(mm)	ESR (Ωmax./100kHz)		Rated ripple current (mA _{rms} /125°C, 100kHz)	Part No.	VV (V _{dc})	Cap (μF)	Case size φDxL(mm)	ESR (Ωmax./100kHz)		Rated ripple current (mA _{rms} /125°C, 100kHz)	Part No.
			20°C	-40°C						20°C	-40°C		
100	330	16×25	0.057	0.39	2,190	EGXF101E□□331ML25S	*1	39	10×30	—	—	1,410	EGXF251E□□390MJ30S
	330	18×20	0.069	0.39	1,690	EGXF101E□□331MM20S		47	10×35	—	—	1,600	EGXF251E□□470MJ35S
	360	14.5×30	0.050	0.40	2,620	EGXF101E□□361MU30S		51	12.5×25	—	—	1,510	EGXF251E□□510MK25S
	390	12.5×40	0.044	0.33	2,970	EGXF101E□□391MK40S		51	14.5×20	—	—	1,340	EGXF251E□□510MU20S
	390	14.5×35	0.044	0.33	2,850	EGXF101E□□391MU35S		56	10×40	—	—	1,790	EGXF251E□□560MJ40S
	390	16×30	0.044	0.33	2,770	EGXF101E□□391ML30S		62	16×20	—	—	1,500	EGXF251E□□620ML20S
	430	18×25	0.054	0.32	2,310	EGXF101E□□431MM25S		68	12.5×30	—	—	1,770	EGXF251E□□680MK30S
	510	14.5×40	0.038	0.26	3,230	EGXF101E□□511MU40S		68	14.5×25	—	—	1,610	EGXF251E□□680MU25S
	510	16×35	0.037	0.26	3,010	EGXF101E□□511ML35S		82	12.5×35	—	—	1,970	EGXF251E□□820MK35S
	560	18×30	0.043	0.26	2,830	EGXF101E□□561MM30S		82	18×20	—	—	1,730	EGXF251E□□820MM20S
	620	16×40	0.032	0.21	3,320	EGXF101E□□621ML40S		91	14.5×30	—	—	1,880	EGXF251E□□910MU30S
	680	18×35	0.034	0.19	3,210	EGXF101E□□681MM35S		91	16×25	—	—	1,850	EGXF251E□□910ML25S
	820	18×40	0.029	0.16	3,410	EGXF101E□□821MM40S		100	12.5×40	—	—	2,150	EGXF251E□□101MK40S
	*1	51	10×20	—	—	900		EGXF161E□□510MJ20S	100	14.5×35	—	—	2,030
62		10×25	—	—	1,200	EGXF161E□□620MJ25S	120	18×25	—	—	2,050	EGXF251E□□121MM25S	
75		12.5×20	—	—	1,220	EGXF161E□□750MK20S	130	14.5×40	—	—	2,250	EGXF251E□□131MU40S	
82		10×30	—	—	1,410	EGXF161E□□820MJ30S	16	10×20	—	—	460	EGXF351E□□160MJ20S	
100		10×35	—	—	1,600	EGXF161E□□101MJ35S	20	10×25	—	—	610	EGXF351E□□200MJ25S	
100		14.5×20	—	—	1,340	EGXF161E□□101MU20S	24	12.5×20	—	—	680	EGXF351E□□240MK20S	
110		12.5×25	—	—	1,510	EGXF161E□□111MK25S	27	10×30	—	—	720	EGXF351E□□270MJ30S	
120		10×40	—	—	1,790	EGXF161E□□121MJ40S	33	10×35	—	—	820	EGXF351E□□330MK35S	
130		16×20	—	—	1,500	EGXF161E□□131ML20S	33	14.5×20	—	—	870	EGXF351E□□330MU20S	
150		12.5×30	—	—	1,770	EGXF161E□□151MK30S	36	10×40	—	—	940	EGXF351E□□360MJ40S	
150		14.5×25	—	—	1,610	EGXF161E□□151MU25S	36	12.5×25	—	—	980	EGXF351E□□360MK25S	
180		12.5×35	—	—	1,970	EGXF161E□□181MK35S	43	16×20	—	—	970	EGXF351E□□430ML20S	
180		14.5×30	—	—	1,880	EGXF161E□□181MU30S	47	12.5×30	—	—	1,210	EGXF351E□□470MK30S	
180		18×20	—	—	1,730	EGXF161E□□181MM20S	47	14.5×25	—	—	1,210	EGXF351E□□470MU25S	
200	12.5×40	—	—	2,150	EGXF161E□□201MK40S	56	12.5×35	—	—	1,330	EGXF351E□□560MK35S		
200	16×25	—	—	1,850	EGXF161E□□201ML25S	56	16×25	—	—	1,130	EGXF351E□□560ML25S		
220	14.5×35	—	—	2,030	EGXF161E□□221MU35S	56	18×20	—	—	1,060	EGXF351E□□560MM20S		
240	18×25	—	—	2,050	EGXF161E□□241MM25S	62	14.5×30	—	—	1,410	EGXF351E□□620MU30S		
270	14.5×40	—	—	2,250	EGXF161E□□271MU40S	68	12.5×40	—	—	1,450	EGXF351E□□680MK40S		
*1	36	10×20	—	—	900	EGXF201E□□360MJ20S	68	14.5×35	—	—	1,590	EGXF351E□□680MU35S	
	43	10×25	—	—	1,200	EGXF201E□□430MJ25S	75	18×25	—	—	1,200	EGXF351E□□750MM25S	
	56	12.5×20	—	—	1,220	EGXF201E□□560MK20S	91	14.5×40	—	—	1,820	EGXF351E□□910MU40S	
	62	10×30	—	—	1,410	EGXF201E□□620MJ30S	12	10×20	—	—	460	EGXF401E□□120MJ20S	
	75	10×35	—	—	1,600	EGXF201E□□750MJ35S	16	10×25	—	—	610	EGXF401E□□160MJ25S	
	75	14.5×20	—	—	1,340	EGXF201E□□750MU20S	20	10×30	—	—	720	EGXF401E□□200MJ30S	
	82	10×40	—	—	1,790	EGXF201E□□820MJ40S	20	12.5×20	—	—	680	EGXF401E□□200MK20S	
	82	12.5×25	—	—	1,510	EGXF201E□□820MK25S	24	10×35	—	—	820	EGXF401E□□240MJ35S	
	100	12.5×30	—	—	1,770	EGXF201E□□101MK30S	24	14.5×20	—	—	870	EGXF401E□□240MU20S	
	100	16×20	—	—	1,500	EGXF201E□□101ML20S	27	12.5×25	—	—	980	EGXF401E□□270MK25S	
	110	14.5×25	—	—	1,610	EGXF201E□□111MU25S	30	10×40	—	—	940	EGXF401E□□300MJ40S	
	130	12.5×35	—	—	1,970	EGXF201E□□131MK35S	33	16×20	—	—	970	EGXF401E□□330ML20S	
	130	14.5×30	—	—	1,880	EGXF201E□□131MU30S	36	12.5×30	—	—	1,210	EGXF401E□□360MK30S	
	130	18×20	—	—	1,730	EGXF201E□□131MM20S	36	14.5×25	—	—	1,210	EGXF401E□□360MU25S	
150	12.5×40	—	—	2,150	EGXF201E□□151MK40S	43	12.5×35	—	—	1,330	EGXF401E□□430MK35S		
150	16×25	—	—	1,850	EGXF201E□□151ML25S	43	18×20	—	—	1,060	EGXF401E□□430MM20S		
160	14.5×35	—	—	2,030	EGXF201E□□161MU35S	47	14.5×30	—	—	1,410	EGXF401E□□470MU30S		
180	18×25	—	—	2,050	EGXF201E□□181MM25S	47	16×25	—	—	1,130	EGXF401E□□470ML25S		
200	14.5×40	—	—	2,250	EGXF201E□□201MU40S	51	12.5×40	—	—	1,450	EGXF401E□□510MK40S		
*1	24	10×20	—	—	900	EGXF251E□□240MJ20S	56	14.5×35	—	—	1,590	EGXF401E□□560MU35S	
	30	10×25	—	—	1,200	EGXF251E□□300MJ25S	62	18×25	—	—	1,200	EGXF401E□□620MM25S	
	36	12.5×20	—	—	1,220	EGXF251E□□360MK20S	68	14.5×40	—	—	1,820	EGXF401E□□680MU40S	

□ □ : Enter the appropriate lead forming or taping code.

*1: Assembly boards with the designated products attached cannot be cleaned.

◆RATED RIPPLE CURRENT MULTIPLIERS

● Frequency Multipliers

(25 to 100V_{dc})

Capacitance(μF)	Frequency(Hz)	120	1k	10k	100k
130 to 240		0.40	0.82	0.93	1.00
270 to 560		0.50	0.85	0.94	1.00
620 to 2,000		0.60	0.87	0.95	1.00
2,200 to 4,300		0.75	0.90	0.95	1.00
4,700 to 11,000		0.85	0.95	0.98	1.00

(160 to 400V_{dc})

Capacitance(μF)	Frequency(Hz)	50	120	300	1k	10k	100k
12 to 33		0.15	0.30	0.45	0.65	0.95	1.00
36 to 270		0.25	0.35	0.50	0.70	0.96	1.00

The deterioration of aluminum electrolytic capacitors accelerates their life due to the internal heating produced by ripple current. For details, refer to Section "5-3 Ripple Current Effect on Lifetime" in the catalog, Technical Note.

Please contact us for lifetime estimation.

GXL Series



- Long-Life version of GXE series
- For automobile modules and other high temperature applications
- Endurance with ripple current : 5,000 hours at 125°C
- Solvent resistant type (see PRECAUTIONS AND GUIDELINES)
- RoHS2 Compliant
- AEC-Q200 compliant : Please contact Chemi-Con for more details, test data, information.

◆ SPECIFICATIONS

Items	Characteristics						
Category	-40 to +125°C						
Temperature Range	-40 to +125°C						
Rated Voltage Range	10 to 50V _{ac}						
Capacitance Tolerance	±20% (M) (at 20°C, 120Hz)						
Leakage Current	I=0.03CV or 4μA, whichever is greater. Where, I : Max. leakage current (μA), C : Nominal capacitance (μF), V : Rated voltage (V) (at 20°C, 1 minute)						
Dissipation Factor (tan δ)	Rated voltage (V _{ac})	10V	16V	25V	35V	50V	(at 20°C, 120Hz)
	tan δ (Max.)	0.20	0.16	0.14	0.12	0.10	
Low Temperature Characteristics (Max. Impedance Ratio)	Rated voltage (V _{ac})	10V	16V	25V	35V	50V	(at 120Hz)
	Z(-25°C)/Z(+20°C)	3	2	2	2	2	
	Z(-40°C)/Z(+20°C)	6	4	4	4	4	
Endurance	The following specifications shall be satisfied when the capacitors are restored to 20°C after subjected to DC voltage with the rated ripple current is applied (the peak voltage shall not exceed the rated voltage) for 5,000 hours at 125°C.						
	Capacitance change	≤ ±30% of the initial value					
	D.F. (tan δ)	≤300% of the initial specified value					
	Leakage current	≤The initial specified value					
Shelf Life	The following specifications shall be satisfied when the capacitors are restored to 20°C after exposing them for 1,000 hours at 125°C without voltage applied. Before the measurement, the capacitor shall be preconditioned by applying voltage according to Item 4.1 of JIS C 5101-4.						
	Capacitance change	≤ ±30% of the initial value					
	D.F. (tan δ)	≤300% of the initial specified value					
	Leakage current	≤The initial specified value					

◆ DIMENSIONS [mm]

● Terminal Code : E

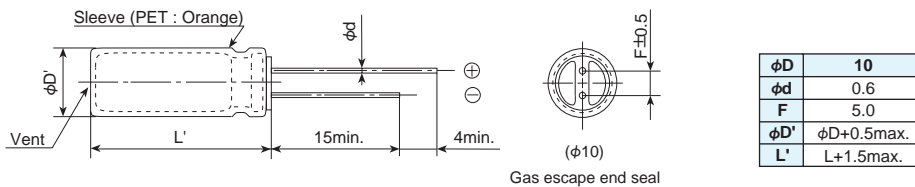

◆ PART NUMBERING SYSTEM

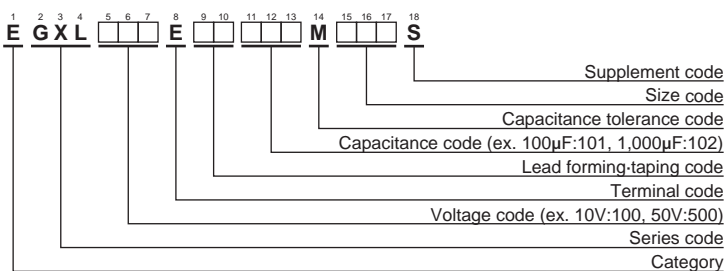

Please refer to "Product code guide (radial lead type)"



GXL Series

◆STANDARD RATINGS

WV (V _{ac})	Cap (μF)	Case size φD×L(mm)	tan δ	Impedance (Ω max./20°C, 100kHz)	Rated ripple current (mA _{rms} /125°C, 100kHz)	Part No.
10	330	10 × 12.5	0.20	0.17	800	EGXL100E□□331MJC5S
	470	10 × 12.5	0.20	0.17	800	EGXL100E□□471MJC5S
	1,000	10 × 20	0.20	0.094	1,300	EGXL100E□□102MJ20S
16	220	10 × 12.5	0.16	0.17	800	EGXL160E□□221MJC5S
	330	10 × 12.5	0.16	0.17	800	EGXL160E□□331MJC5S
	470	10 × 16	0.16	0.12	1,050	EGXL160E□□471MJ16S
25	220	10 × 12.5	0.14	0.17	800	EGXL250E□□221MJC5S
	330	10 × 16	0.14	0.12	1,050	EGXL250E□□331MJ16S
	470	10 × 20	0.14	0.094	1,300	EGXL250E□□471MJ20S
35	100	10 × 12.5	0.12	0.17	800	EGXL350E□□101MJC5S
	220	10 × 16	0.12	0.12	1,050	EGXL350E□□221MJ16S
	330	10 × 20	0.12	0.094	1,300	EGXL350E□□331MJ20S
50	100	10 × 12.5	0.10	0.30	590	EGXL500E□□101MJC5S
	220	10 × 20	0.10	0.19	970	EGXL500E□□221MJ20S

□□ : Enter the appropriate lead forming or taping code.

◆RATED RIPPLE CURRENT MULTIPLIERS

● Frequency Multipliers

Capacitance(μF)	Frequency(Hz)			
	120	1k	10k	100k
100	0.40	0.75	0.90	1.00
220 to 470	0.50	0.85	0.94	1.00
1,000	0.60	0.87	0.95	1.00

The deterioration of aluminum electrolytic capacitors accelerates their life due to the internal heating produced by ripple current. For details, refer to Section "5-3 Ripple Current Effect on Lifetime" in the catalog, Technical Note.



GPD Series

- Guaranteed short time at 150°C
- Downsized and high-ripple current version of GPA series
- For automobile modules and other high temperature applications
- Endurance with ripple current : 2,000 to 3,000 hours at 125°C to 135°C
- Solvent resistant type (see PRECAUTIONS AND GUIDELINES)
- RoHS2 Compliant
- AEC-Q200 compliant : Please contact Chemi-Con for more details, test data, information.

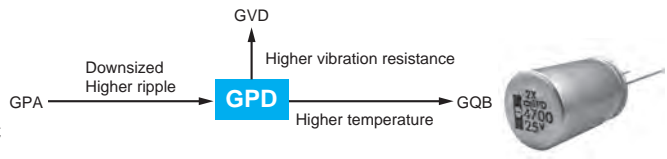

SPECIFICATIONS

Items	Characteristics							
Category	-40 to +135°C							
Temperature Range	-40 to +135°C							
Rated Voltage Range	25 to 100V _{dc}							
Capacitance Tolerance	±20% (M) (at 20°C, 120Hz)							
Leakage Current	I=0.03CV or 4μA, whichever is greater. (at 20°C, 1 minute) Where, I : Max. leakage current (μA), C : Nominal capacitance (μF), V : Rated voltage (V)							
Dissipation Factor (tan δ)	Rated voltage (V _{dc})	25V	35V	50V	63V	80V	100V	
	tan δ (Max.)	0.14	0.12	0.10	0.10	0.08	0.08	
	When nominal capacitance exceeds 1,000μF, add 0.02 to the value above for each 1,000μF increase. (at 20°C, 120Hz)							
Low Temperature Characteristics (Max. Impedance Ratio)	Rated voltage (V _{dc})	25V	35V	50V	63V	80V	100V	
	Z(-25°C)/Z(+20°C)	2	2	2	2	2	2	
	Z(-40°C)/Z(+20°C)	4	4	4	4	4	4	
Endurance 1	The following specifications shall be satisfied when the capacitors are restored to 20°C after subjected to DC voltage with the rated ripple current is applied (the peak voltage shall not exceed the rated voltage) for the specified period of time at 125°C or 135°C.							
	Time	125°C	3,000hours					
		135°C	25 to 50V _{dc} :		3,000hours			
			63 to 100V _{dc} :		2,000hours			
	Capacitance change	≤ ±30% of the initial value						
D.F. (tan δ)	≤300% of the initial specified value							
Leakage current	≤The initial specified value							
Endurance 2	The following specifications shall be satisfied when the capacitors are restored to 20°C after the test condition that the rated voltage is applied for 100 hours at 150°C and DC voltage with the rated ripple current is applied (the peak voltage shall not exceed the rated voltage) for the specified period of time at 125°C or 135°C.							
	Time	125°C	2,500hours					
		135°C	25 to 50V _{dc} :		2,500hours			
			63 to 100V _{dc} :		1,500hours			
	Capacitance change	≤ ±30% of the initial value						
D.F. (tan δ)	≤300% of the initial specified value							
Leakage current	≤The initial specified value							
Shelf Life	The following specifications shall be satisfied when the capacitors are restored to 20°C after exposing them for 1,000 hours at 125°C without voltage applied. Before the measurement, the capacitor shall be preconditioned by applying voltage according to Item 4.1 of JIS C 5101-4.							
	Capacitance change	≤ ±30% of the initial value						
	D.F. (tan δ)	≤300% of the initial specified value						
	Leakage current	≤The initial specified value						

DIMENSIONS [mm]

- Terminal Code : E

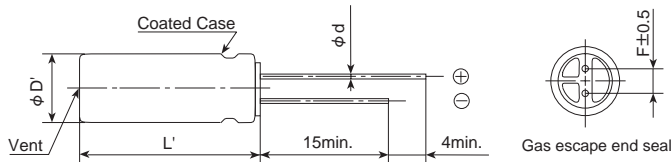

φD	12.5	16	18
φd	0.6	0.8	0.8
F	5.0	7.5	7.5
φD'	φD±0.5		
L'	L ^{+1.5} _{-1.0}		

PART NUMBERING SYSTEM

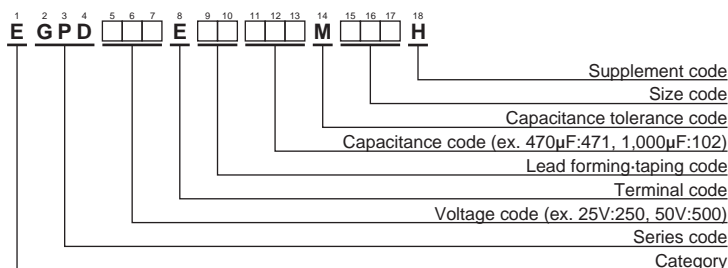

Please refer to "Product code guide (radial lead type)"



GPD Series

◆ STANDARD RATINGS

WV (V _{dc})	Cap (μF)	Case size φD×L(mm)	tan δ	ESR (Ω max./100kHz)		Rated ripple current (mArms/100kHz)		Part No.
				20°C	-40°C	125°C	135°C	
25	2,000	12.5 × 20	0.16	0.042	0.48	2,760	1,690	EGPD250E□□202MK20H
	3,000	12.5 × 25	0.18	0.033	0.30	3,480	2,010	EGPD250E□□302MK25H
	3,300	16 × 20	0.18	0.035	0.27	3,040	1,860	EGPD250E□□332ML20H
	3,600	12.5 × 30	0.18	0.028	0.24	4,490	2,900	EGPD250E□□362MK30H
	4,300	18 × 20	0.20	0.034	0.22	3,250	1,870	EGPD250E□□432MM20H
	4,700	12.5 × 35	0.20	0.025	0.21	5,140	3,190	EGPD250E□□472MK35H
	4,700	16 × 25	0.20	0.028	0.22	4,260	2,870	EGPD250E□□472ML25H
	5,100	12.5 × 40	0.22	0.024	0.19	5,810	3,470	EGPD250E□□512MK40H
	5,600	16 × 30	0.22	0.023	0.18	5,480	3,400	EGPD250E□□562ML30H
	6,200	18 × 25	0.24	0.027	0.19	4,500	2,900	EGPD250E□□622MM25H
	7,500	16 × 35	0.26	0.020	0.14	6,070	3,630	EGPD250E□□752ML35H
	7,500	18 × 30	0.26	0.022	0.16	5,600	3,470	EGPD250E□□752MM30H
35	9,100	16 × 40	0.30	0.019	0.12	6,810	3,930	EGPD250E□□912ML40H
	10,000	18 × 35	0.32	0.019	0.12	6,280	3,750	EGPD250E□□103MM35H
	12,000	18 × 40	0.36	0.018	0.10	7,070	4,080	EGPD250E□□123MM40H
	1,300	12.5 × 20	0.12	0.042	0.48	2,760	1,690	EGPD350E□□132MK20H
	1,800	12.5 × 25	0.12	0.033	0.30	3,480	2,010	EGPD350E□□182MK25H
	2,000	16 × 20	0.14	0.035	0.27	3,040	1,860	EGPD350E□□202ML20H
	2,200	12.5 × 30	0.14	0.028	0.24	4,490	2,900	EGPD350E□□222MK30H
	2,400	18 × 20	0.14	0.034	0.22	3,250	1,870	EGPD350E□□242MM20H
	2,700	12.5 × 35	0.14	0.025	0.21	5,140	3,190	EGPD350E□□272MK35H
	3,000	16 × 25	0.16	0.028	0.22	4,260	2,870	EGPD350E□□302ML25H
	3,300	12.5 × 40	0.16	0.024	0.19	5,810	3,470	EGPD350E□□332MK40H
	3,600	16 × 30	0.16	0.023	0.18	5,480	3,400	EGPD350E□□362ML30H
3,900	18 × 25	0.16	0.027	0.19	4,500	2,900	EGPD350E□□392MM25H	
4,300	16 × 35	0.18	0.020	0.14	6,070	3,630	EGPD350E□□432ML35H	
4,700	18 × 30	0.18	0.022	0.16	5,600	3,470	EGPD350E□□472MM30H	
5,600	16 × 40	0.20	0.019	0.12	6,810	3,930	EGPD350E□□562ML40H	
6,200	18 × 35	0.22	0.019	0.12	6,280	3,750	EGPD350E□□622MM35H	
7,500	18 × 40	0.24	0.018	0.10	7,070	4,080	EGPD350E□□752MM40H	
50	620	12.5 × 20	0.10	0.073	0.88	2,400	1,470	EGPD500E□□621MK20H
	820	12.5 × 25	0.10	0.058	0.67	3,350	2,260	EGPD500E□□821MK25H
	1,000	16 × 20	0.10	0.050	0.55	2,960	1,870	EGPD500E□□102ML20H
	1,100	12.5 × 30	0.10	0.048	0.52	4,220	2,520	EGPD500E□□112MK30H
	1,300	12.5 × 35	0.10	0.042	0.44	4,810	2,780	EGPD500E□□132MK35H
	1,300	16 × 25	0.10	0.042	0.44	4,040	2,500	EGPD500E□□132ML25H
	1,300	18 × 20	0.10	0.042	0.44	3,130	2,110	EGPD500E□□132MM20H
	1,600	12.5 × 40	0.10	0.037	0.36	5,240	3,020	EGPD500E□□162MK40H
	1,600	16 × 30	0.10	0.035	0.36	5,130	2,960	EGPD500E□□162ML30H
	1,800	18 × 25	0.10	0.033	0.32	4,230	2,530	EGPD500E□□182MM25H
	2,200	16 × 35	0.12	0.029	0.27	5,480	3,160	EGPD500E□□222ML35H
	2,400	18 × 30	0.12	0.028	0.25	5,240	3,020	EGPD500E□□242MM30H
	2,700	16 × 40	0.12	0.025	0.22	5,930	3,420	EGPD500E□□272ML40H
	3,000	18 × 35	0.14	0.024	0.20	5,870	3,390	EGPD500E□□302MM35H
3,600	18 × 40	0.14	0.023	0.16	6,420	3,700	EGPD500E□□362MM40H	
63	390	12.5 × 20	0.10	0.072	0.56	1,640	1,420	EGPD630E□□391MK20H
	560	12.5 × 25	0.10	0.052	0.39	2,520	2,050	EGPD630E□□561MK25H
	680	16 × 20	0.10	0.053	0.34	2,140	1,910	EGPD630E□□681ML20H
	750	12.5 × 30	0.10	0.042	0.30	3,110	2,630	EGPD630E□□751MK30H
	910	12.5 × 35	0.10	0.035	0.25	3,760	2,970	EGPD630E□□911MK35H
	910	18 × 20	0.10	0.044	0.26	2,350	2,100	EGPD630E□□911MM20H
	1,000	16 × 25	0.10	0.038	0.23	2,940	2,680	EGPD630E□□102ML25H
	1,100	12.5 × 40	0.10	0.031	0.22	4,610	3,260	EGPD630E□□112MK40H
	1,200	16 × 30	0.10	0.034	0.20	3,860	3,050	EGPD630E□□122ML30H
	1,300	18 × 25	0.10	0.033	0.19	3,080	2,810	EGPD630E□□132MM25H
	1,600	16 × 35	0.10	0.027	0.15	4,590	3,420	EGPD630E□□162ML35H
	1,600	18 × 30	0.10	0.028	0.15	4,080	3,220	EGPD630E□□162MM30H
	1,800	16 × 40	0.10	0.025	0.14	5,190	3,670	EGPD630E□□182ML40H
	2,200	18 × 35	0.12	0.022	0.12	5,220	3,690	EGPD630E□□222MM35H
2,400	18 × 40	0.12	0.021	0.11	5,660	3,820	EGPD630E□□242MM40H	

□□ : Enter the appropriate lead forming or taping code.



GPD Series

◆STANDARD RATINGS

WV (V _{dc})	Cap (μF)	Case size φ D×L(mm)	tan δ	ESR (Ω max./100kHz)		Rated ripple current (mA _{rms} /100kHz)		Part No.
				20°C	-40°C	125°C	135°C	
80	270	12.5 × 20	0.08	0.072	0.56	1,640	1,420	EGPD800E□□271MK20H
	390	12.5 × 25	0.08	0.052	0.39	2,520	2,050	EGPD800E□□391MK25H
	470	16 × 20	0.08	0.053	0.34	2,140	1,910	EGPD800E□□471ML20H
	510	12.5 × 30	0.08	0.042	0.30	3,110	2,630	EGPD800E□□511MK30H
	620	12.5 × 35	0.08	0.035	0.25	3,760	2,970	EGPD800E□□621MK35H
	620	18 × 20	0.08	0.044	0.26	2,350	2,100	EGPD800E□□621MM20H
	680	16 × 25	0.08	0.038	0.23	2,940	2,680	EGPD800E□□681ML25H
	750	12.5 × 40	0.08	0.031	0.22	4,610	3,260	EGPD800E□□751MK40H
	750	16 × 30	0.08	0.034	0.20	3,860	3,050	EGPD800E□□751ML30H
	820	18 × 25	0.08	0.033	0.19	3,080	2,810	EGPD800E□□821MM25H
	1,000	16 × 35	0.08	0.027	0.15	4,590	3,420	EGPD800E□□102ML35H
	1,100	18 × 30	0.08	0.028	0.15	4,080	3,220	EGPD800E□□112MM30H
	1,300	16 × 40	0.08	0.025	0.14	5,190	3,670	EGPD800E□□132ML40H
	1,300	18 × 35	0.08	0.022	0.12	5,220	3,690	EGPD800E□□132MM35H
1,600	18 × 40	0.08	0.021	0.11	5,660	3,820	EGPD800E□□162MM40H	
100	160	12.5 × 20	0.08	0.090	0.75	1,580	1,410	EGPD101E□□161MK20H
	220	12.5 × 25	0.08	0.068	0.55	2,140	1,960	EGPD101E□□221MK25H
	270	16 × 20	0.08	0.067	0.47	2,050	1,670	EGPD101E□□271ML20H
	300	12.5 × 30	0.08	0.052	0.41	2,950	2,330	EGPD101E□□301MK30H
	360	12.5 × 35	0.08	0.045	0.35	3,530	2,630	EGPD101E□□361MK35H
	360	18 × 20	0.08	0.061	0.35	2,270	1,860	EGPD101E□□361MM20H
	390	16 × 25	0.08	0.048	0.33	2,790	2,360	EGPD101E□□391ML25H
	430	12.5 × 40	0.08	0.038	0.29	4,140	2,920	EGPD101E□□431MK40H
	470	16 × 30	0.08	0.041	0.27	3,440	2,720	EGPD101E□□471ML30H
	510	18 × 25	0.08	0.045	0.25	2,920	2,470	EGPD101E□□511MM25H
	560	16 × 35	0.08	0.036	0.23	4,190	2,960	EGPD101E□□561ML35H
	620	18 × 30	0.08	0.037	0.20	3,920	2,920	EGPD101E□□621MM30H
	750	16 × 40	0.08	0.028	0.18	5,020	3,380	EGPD101E□□751ML40H
	820	18 × 35	0.08	0.030	0.16	4,710	3,330	EGPD101E□□821MM35H
	910	18 × 40	0.08	0.026	0.14	5,280	3,560	EGPD101E□□911MM40H

□□ : Enter the appropriate lead forming or taping code.

◆RATED RIPPLE CURRENT MULTIPLIERS

●Frequency Multipliers

Capacitance(μF)	Frequency(Hz)	120	1k	10k	100k
160		0.40	0.75	0.90	1.00
220 to 620		0.50	0.85	0.94	1.00
680 to 2,000		0.60	0.87	0.95	1.00
2,200 to 4,300		0.75	0.90	0.95	1.00
4,700 to 12,000		0.85	0.95	0.98	1.00

The deterioration of aluminum electrolytic capacitors accelerates their life due to the internal heating produced by ripple current. For details, refer to Section "5-3 Ripple Current Effect on Lifetime" in the catalog, Technical Note.

Please contact us for lifetime estimation.

GVD Series

- Structure of higher vibration resistance by GPD series (acceleration 392m/s², 40G)
- Guaranteed short time at 150°C
- Designed for electric power steering and ECU (include engine control, direct fuel injection) etc.
- Rated voltage range : 25 to 100V, Capacitance range : 510 to 8,200μF
- Solvent resistant type
- RoHS2 Compliant
- AEC-Q200 compliant : Please contact Chemi-Con for more details, test data, information.

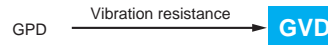

◆ SPECIFICATIONS

Items	Characteristics						
Category							
Temperature Range	-40 to +135°C						
Rated Voltage Range	25 to 100V _{dc}						
Capacitance Tolerance	±20% (M) (at 20°C, 120Hz)						
Leakage Current	I=0.03CV or 4μA, whichever is greater. Where, I : Max. leakage current (μA), C : Nominal capacitance (μF), V : Rated voltage (V) (at 20°C, 1 minute)						
Dissipation Factor (tan δ)	Rated voltage (V _{dc})	25V	35V	50V	63V	80V	100V
	tan δ (Max.)	0.14	0.12	0.10	0.10	0.08	0.08
	When nominal capacitance exceeds 1,000μF, add 0.02 to the value above for each 1,000μF increase. (at 20°C, 120Hz)						
Low Temperature Characteristics (Max. Impedance Ratio)	Rated voltage (V _{dc})	25V	35V	50V	63V	80V	100V
	Z(-25°C)/Z(+20°C)	2	2	2	2	2	2
	Z(-40°C)/Z(+20°C)	4	4	4	4	4	4
Endurance 1	The following specifications shall be satisfied when the capacitors are restored to 20°C after subjected to DC voltage with the rated ripple current is applied (the peak voltage shall not exceed the rated voltage) for the specified period of time at 125°C or 135°C.						
	Time	125°C	25 to 100V _{dc} : 3,000hours				
		135°C	25 to 50V _{dc} : 3,000hours				
			63 to 100V _{dc} : 2,000hours				
	Capacitance change	≤ ±30% of the initial value					
	D.F. (tan δ)	≤300% of the initial specified value					
	Leakage current	≤The initial specified value					
Endurance 2	The following specifications shall be satisfied when the capacitors are restored to 20°C after the test condition that the rated voltage is applied for 100 hours at 150°C and DC voltage with the rated ripple current is applied (the peak voltage shall not exceed the rated voltage) for the specified period of time at 125°C or 135°C.						
	Time	125°C	25 to 100V _{dc} : 2,500hours				
		135°C	25 to 50V _{dc} : 2,500hours				
			63 to 100V _{dc} : 1,500hours				
	Capacitance change	≤ ±30% of the initial value					
	D.F. (tan δ)	≤300% of the initial specified value					
	Leakage current	≤The initial specified value					
Shelf Life	The following specifications shall be satisfied when the capacitors are restored to 20°C after exposing them for 1,000 hours at 125°C without voltage applied. Before the measurement, the capacitor shall be preconditioned by applying voltage according to Item 4.1 of JIS C 5101-4.						
	Capacitance change	≤ ±30% of the initial value					
	D.F. (tan δ)	≤300% of the initial specified value					
	Leakage current	≤The initial specified value					
Vibration	The following specifications shall be satisfied when the capacitors are restored to 20°C after subjected to vibration test (vibration profile shown below) at room temperature (15 to 35°C).						
	Capacitance change	≤ ±5% of the initial value					
	D.F. (tan δ)	≤The initial specified value					
	Leakage current	≤The initial specified value					
	Vibration profile						
	Vibration frequency range	10 to 2,000Hz					
	Amplitude or Acceleration	1.5mm peak to peak or 392m/s ² (40G), whichever is the less severe					
	Sweep rate	10 to 2,000 to 10Hz 0.5 octave/minute					
	Direction and period of motion	2 hours in each of 3 mutually perpendicular directions (total of 6hours)					
	Fixation	Fix main body and Lead terminal using a fixture tool, please contact us for detail.					

◆ DIMENSIONS [mm]

- Terminal Code : E

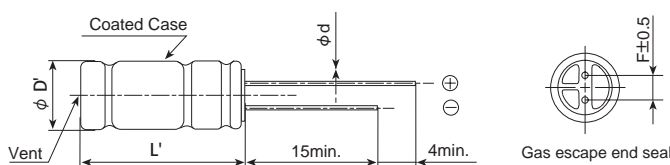

φD	18
φd	0.8
F	7.5
φD'	φD±0.5
L'	L'+1.5 -1.0

* Please contact us about lead formings and mounting methods.

GVD Series

◆PART NUMBERING SYSTEM

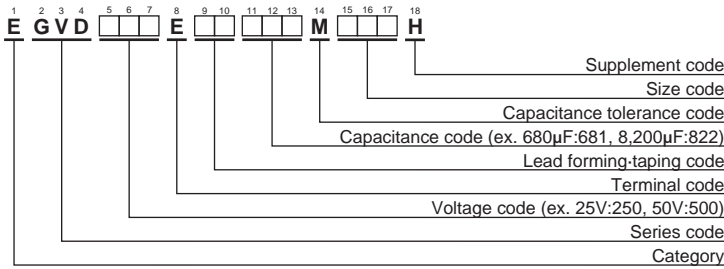

Please refer to "Product code guide (radial lead type)"

◆STANDARD RATINGS

WV (V _{ac})	Cap (µF)	Case size φ D × L (mm)	tan δ	ESR (Ω max/100kHz)		Rated ripple current (mA rms/100kHz)		Part No.
				20°C	-40°C	125°C	135°C	
25	6,200	18 × 30	0.24	0.023	0.19	5,380	3,330	EGVD250E□□622MM30H
	8,200	18 × 35.5	0.28	0.019	0.13	6,110	3,750	EGVD250E□□822MMP1H
35	3,600	18 × 30	0.16	0.023	0.19	5,380	3,330	EGVD350E□□362MM30H
	4,700	18 × 35.5	0.18	0.019	0.13	6,110	3,750	EGVD350E□□472MMP1H
50	2,000	18 × 30	0.12	0.029	0.26	5,050	2,910	EGVD500E□□202MM30H
	2,400	18 × 35.5	0.12	0.024	0.20	5,760	3,330	EGVD500E□□242MMP1H
63	1,300	18 × 30	0.10	0.029	0.18	3,930	3,100	EGVD630E□□132MM30H
	1,800	18 × 35.5	0.10	0.024	0.14	4,920	3,520	EGVD630E□□182MMP1H
80	820	18 × 30	0.08	0.029	0.18	3,930	3,100	EGVD800E□□821MM30H
	1,200	18 × 35.5	0.08	0.024	0.14	4,920	3,520	EGVD800E□□122MMP1H
100	510	18 × 30	0.08	0.038	0.25	3,800	2,830	EGVD101E□□511MM30H
	680	18 × 35.5	0.08	0.030	0.19	4,550	3,210	EGVD101E□□681MMP1H

□□ : Enter the appropriate lead forming or taping code.

◆RATED RIPPLE CURRENT MULTIPLIERS

● Frequency Multipliers

Capacitance(µF)	Frequency(Hz)	120	1k	10k	100k
510		0.50	0.85	0.94	1.00
680 to 2,000		0.60	0.87	0.95	1.00
2,400 to 3,600		0.75	0.90	0.95	1.00
4,700 to 8,200		0.85	0.95	0.98	1.00

The deterioration of aluminum electrolytic capacitors accelerates their life due to the internal heating produced by ripple current. For details, refer to Section "5-3 Ripple Current Effect on Lifetime" in the catalog, Technical Note.

Please contact us for lifetime estimation.

GQB Series

- Endurance with ripple current : 1,000 hours at 150°C
- For automobile transmission, electric water pump and other high temperature applications.
- Rated voltage range : 25 & 35V, Nominal capacitance range : 560 to 3,600μF
- Solvent resistant type (see PRECAUTIONS AND GUIDELINES)
- RoHS2 Compliant
- AEC-Q200 compliant : Please contact Chemi-Con for more details, test data, information.

GPD → Higher temperature Higher ripple current → **GQB**



SPECIFICATIONS

Items	Characteristics		
Category	-40 to +150°C		
Temperature Range	-40 to +150°C		
Rated Voltage Range	25, 35V _{dc}		
Capacitance Tolerance	±20% (M) (at 20°C, 120Hz)		
Leakage Current	I=0.03CV or 4μA, whichever is greater. Where, I : Max. leakage current (μA), C : Nominal capacitance (μF), V : Rated voltage (V) (at 20°C, 1 minute)		
Dissipation Factor (tan δ)	Rated voltage (V _{dc})	25V	35V
	tan δ (Max.)	0.14	0.12
	When nominal capacitance exceeds 1,000μF, add 0.02 to the value above for each 1,000μF increase. (at 20°C, 120Hz)		
Low Temperature Characteristics (Max. Impedance Ratio)	Rated voltage (V _{dc})	25V	35V
	Z(-25°C)/Z(+20°C)	2	2
	Z(-40°C)/Z(+20°C)	4	4
	(at 120Hz)		
Endurance 1	The following specifications shall be satisfied when the capacitors are restored to 20°C after subjected to DC voltage with the rated ripple current is applied (the peak voltage shall not exceed the rated voltage) for 1,000 hours at 150°C.		
	Capacitance change	≤ ±30% of the initial value	
	D.F. (tan δ)	≤300% of the initial specified value	
	Leakage current	≤The initial specified value	
Endurance 2	The following specifications shall be satisfied when the capacitors are restored to 20°C after subjected to DC voltage with the rated ripple current is applied (the peak voltage shall not exceed the rated voltage) for 2,000 hours at 125°C.		
	Capacitance change	≤ ±30% of the initial value	
	D.F. (tan δ)	≤300% of the initial specified value	
	Leakage current	≤The initial specified value	
Shelf Life	The following specifications shall be satisfied when the capacitors are restored to 20°C after exposing them for 500 hours at 150°C without voltage applied. Before the measurement, the capacitor shall be preconditioned by applying voltage according to Item 4.1 of JIS C 5101-4.		
	Capacitance change	≤ ±30% of the initial value	
	D.F. (tan δ)	≤300% of the initial specified value	
	Leakage current	≤The initial specified value	

DIMENSIONS [mm]

Terminal Code : E

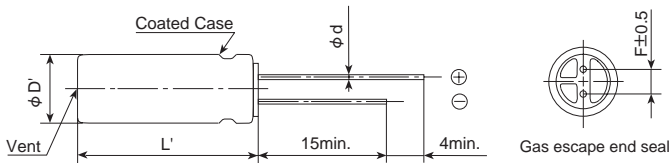

φD	12.5	16	18
φd	0.6	0.8	0.8
F	5.0	7.5	7.5
φD'	φD±0.5		
L'	L +1.5 -1.0		

PART NUMBERING SYSTEM

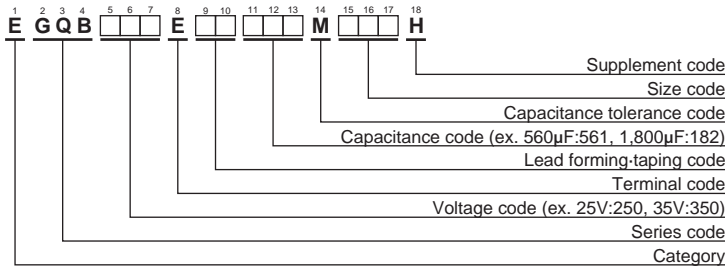

Please refer to "Product code guide (radial lead type)"



GQB Series

◆STANDARD RATINGS

WV (V _{dc})	Cap (μF)	Case size φ D×L(mm)	tan δ	ESR (Ω max./100kHz)		Rated ripple current (mArms/100kHz)		Part No.
				20°C	-40°C	150°C	125°C	
25	1,100	12.5 × 20	0.14	0.12	1.4	1,100	2,620	EGQB250E□□112MK20H
	1,600	12.5 × 25	0.14	0.080	1.0	1,300	2,910	EGQB250E□□162MK25H
	1,800	16 × 20	0.14	0.070	1.0	1,460	3,590	EGQB250E□□182ML20H
	2,400	18 × 20	0.16	0.058	0.90	1,560	3,830	EGQB250E□□242MM20H
	2,700	16 × 25	0.16	0.050	0.80	1,720	4,560	EGQB250E□□272ML25H
	3,600	18 × 25	0.18	0.042	0.70	1,800	4,800	EGQB250E□□362MM25H
35	560	12.5 × 20	0.12	0.15	4.5	1,000	2,230	EGQB350E□□561MK20H
	750	12.5 × 25	0.12	0.12	3.4	1,200	2,680	EGQB350E□□751MK25H
	910	16 × 20	0.12	0.10	3.0	1,260	3,110	EGQB350E□□911ML20H
	1,200	18 × 20	0.12	0.084	2.0	1,320	3,250	EGQB350E□□122MM20H
	1,400	16 × 25	0.12	0.067	2.0	1,600	4,060	EGQB350E□□142ML25H
	1,800	18 × 25	0.12	0.058	1.4	1,680	4,500	EGQB350E□□182MM25H

□□ : Enter the appropriate lead forming or taping code.

◆RATED RIPPLE CURRENT MULTIPLIERS

● Frequency Multipliers

Capacitance(μF) \ Frequency(Hz)	120	1k	10k	100k
560	0.50	0.85	0.94	1.00
750 to 1,800	0.60	0.87	0.95	1.00
2,400 to 3,600	0.75	0.90	0.95	1.00

The deterioration of aluminum electrolytic capacitors accelerates their life due to the internal heating produced by ripple current. For details, refer to Section "5-3 Ripple Current Effect on Lifetime" in the catalog, Technical Note.

Please contact us for lifetime estimation.

LBV Series

- Downsizing of LBG series.
- For airbag application and power supply application
- High capacitance, low ESR and good low temperature behavior
- Endurance with ripple current : 5,000 hours at 105°C
- Solvent resistant type (see PRECAUTIONS AND GUIDELINES)
- RoHS2 Compliant
- AEC-Q200 compliant : Please contact Chemi-Con for more details, test data, information.



SPECIFICATIONS

Items	Characteristics	
Category	-55 to +105°C	
Temperature Range	-55 to +105°C	
Rated Voltage Range	25 & 35V _{dc}	
Capacitance Range	3,000 to 15,000μF (at 20°C, 120Hz)	
Capacitance Tolerance	0 to +30% (A) (at 20°C, 120Hz)	
Leakage Current	I=0.01CV Where, I : Max. leakage current (μA), C : Nominal capacitance (μF), V : Rated voltage (V) (at 20°C after 2 minutes)	
Dissipation Factor (tan δ)	Rated voltage (V _{dc})	25V 35V
	tan δ (Max.)	0.20 0.16
	When nominal capacitance exceeds 1,000μF, add 0.02 to the value above for each 1,000μF increase. (at 20°C, 120Hz)	
Low Temperature Characteristics (Max. Impedance Ratio)	Rated voltage (V _{dc})	25V 35V
	Z(-55°C)/Z(+20°C)	3 3
	(at 120Hz)	
Endurance	The following specifications shall be satisfied when the capacitors are restored to 20°C after subjected to DC voltage with the rated ripple current is applied (the peak voltage shall not exceed the rated voltage) for 5,000 hours at 105°C.	
	Capacitance change	≤ ±30% of the initial value
	D.F. (tan δ)	≤300% of the initial specified value
	Leakage current	≤The initial specified value
Shelf Life	The following specifications shall be satisfied when the capacitors are restored to 20°C after exposing them for 1,000 hours at 105°C without voltage applied. Before the measurement, the capacitor shall be preconditioned by applying voltage according to Item 4.1 of JIS C 5101-4.	
	Capacitance change	≤ ±30% of the initial value
	D.F. (tan δ)	≤300% of the initial specified value
	Leakage current	≤The initial specified value

DIMENSIONS [mm]

- Terminal Code : E

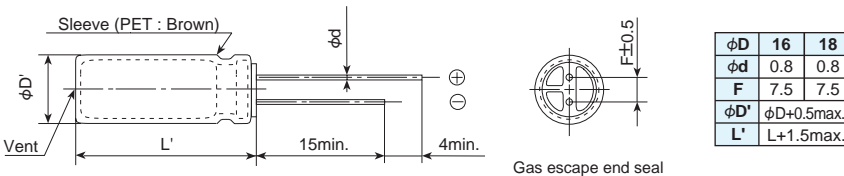

PART NUMBERING SYSTEM

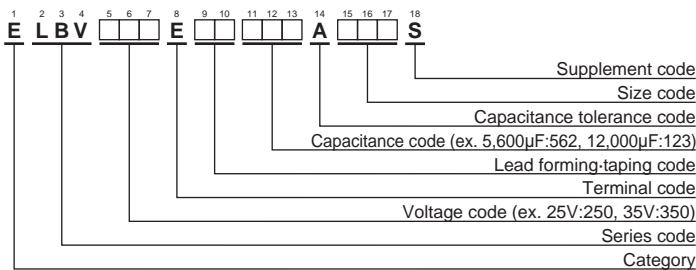

Please refer to "Product code guide (radial lead type)"



LBV Series

◆STANDARD RATINGS

WV (V _{ac})	Cap (μF)	Case size φ D×L (mm)	tan δ	ESR (Ω max./100kHz)		Rated ripple current (mA _{rms} /105°C, 100kHz)	Part No.
				20°C	-40°C		
25	4,400	16 × 20	0.26	0.030	0.095	2,000	ELBV250E□□442AL20S
	5,700	18 × 20	0.28	0.028	0.080	2,100	ELBV250E□□572AM20S
	6,200	16 × 25	0.30	0.024	0.073	2,300	ELBV250E□□622AL25S
	8,100	18 × 25	0.34	0.022	0.060	2,400	ELBV250E□□812AM25S
	8,500	16 × 31.5	0.34	0.020	0.065	2,550	ELBV250E□□852ALN3S
	9,900	16 × 35.5	0.36	0.018	0.055	2,700	ELBV250E□□992ALP1S
	11,000	16 × 40	0.40	0.016	0.050	2,900	ELBV250E□□113AL40S
	11,000	18 × 31.5	0.40	0.018	0.045	2,700	ELBV250E□□113AMN3S
	12,000	18 × 35.5	0.42	0.016	0.040	2,900	ELBV250E□□123AMP1S
15,000	18 × 40	0.48	0.015	0.035	3,100	ELBV250E□□153AM40S	
35	3,000	16 × 20	0.20	0.030	0.095	2,000	ELBV350E□□302AL20S
	4,000	18 × 20	0.22	0.028	0.080	2,100	ELBV350E□□402AM20S
	4,300	16 × 25	0.22	0.024	0.073	2,300	ELBV350E□□432AL25S
	5,600	18 × 25	0.24	0.022	0.060	2,400	ELBV350E□□562AM25S
	5,900	16 × 31.5	0.24	0.020	0.065	2,550	ELBV350E□□592ALN3S
	6,900	16 × 35.5	0.26	0.018	0.055	2,700	ELBV350E□□692ALP1S
	7,600	18 × 31.5	0.28	0.018	0.045	2,700	ELBV350E□□762AMN3S
	8,200	16 × 40	0.30	0.016	0.050	2,900	ELBV350E□□822AL40S
	9,000	18 × 35.5	0.32	0.016	0.040	2,900	ELBV350E□□902AMP1S
10,000	18 × 40	0.34	0.015	0.035	3,100	ELBV350E□□103AM40S	

□□ : Enter the appropriate lead forming or taping code.

◆RATED RIPPLE CURRENT MULTIPLIERS

● Frequency Multipliers

Capacitance(μF)	Frequency(Hz)			
	120	1k	10k	100k
3,000	0.75	0.90	0.95	1.00
4,000 to 15,000	0.85	0.95	0.98	1.00

The deterioration of aluminum electrolytic capacitors accelerates their life due to the internal heating produced by ripple current. For details, refer to Section "5-3 Ripple Current Effect on Lifetime" in the catalog, Technical Note.

LBG Series

- For airbag application
- High capacitance, low impedance, and good low temperature behavior
- Endurance with ripple current : 5,000 hours at 105°C
- Solvent resistant type (see PRECAUTIONS AND GUIDELINES)
- RoHS2 Compliant
- AEC-Q200 compliant : Please contact Chemi-Con for more details, test data, information.



◆ SPECIFICATIONS

Items	Characteristics	
Category	-55 to +105°C	
Temperature Range	-55 to +105°C	
Rated Voltage Range	25 & 35V _{dc}	
Capacitance Range	1,000 to 11,000μF (at 20°C, 120Hz)	
Capacitance Tolerance	0 to +30% (A) (at 20°C, 120Hz)	
Leakage Current	I=0.01CV Where, I : Max. leakage current (μA), C : Nominal capacitance (μF), V : Rated voltage (V) (at 20°C after 2 minutes)	
Dissipation Factor (tan δ)	Rated voltage (V _{dc})	25V 35V
	tan δ (Max.)	0.20 0.16
	When nominal capacitance exceeds 1,000μF, add 0.02 to the value above for each 1,000μF increase. (at 20°C, 120Hz)	
Low Temperature Characteristics (Max. Impedance Ratio)	Rated voltage (V _{dc})	25V 35V
	Z(-55°C)/Z(+20°C)	3 3
	(at 120Hz)	
Endurance	The following specifications shall be satisfied when the capacitors are restored to 20°C after subjected to DC voltage with the rated ripple current is applied (the peak voltage shall not exceed the rated voltage) for 5,000 hours at 105°C.	
	Capacitance change	≤ ±20% of the initial value
	D.F. (tan δ)	≤200% of the initial specified value
	Leakage current	≤The initial specified value
Shelf Life	The following specifications shall be satisfied when the capacitors are restored to 20°C after exposing them for 1,000 hours at 105°C without voltage applied. Before the measurement, the capacitor shall be preconditioned by applying voltage according to Item 4.1 of JIS C 5101-4.	
	Capacitance change	≤ ±20% of the initial value
	D.F. (tan δ)	≤200% of the initial specified value
	Leakage current	≤The initial specified value

◆ DIMENSIONS [mm]

- Terminal Code : E

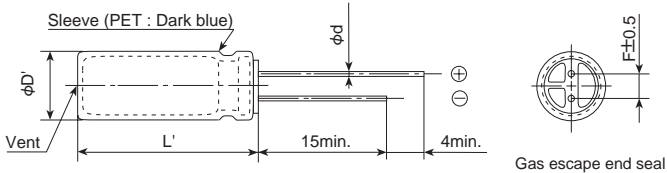

	12.5	14.5	16	18
φD	12.5	14.5	16	18
φd	0.6	0.8	0.8	0.8
F	5.0	7.5	7.5	7.5
φD'	φD+0.5max.			
L'	L+1.5max.			

◆ PART NUMBERING SYSTEM

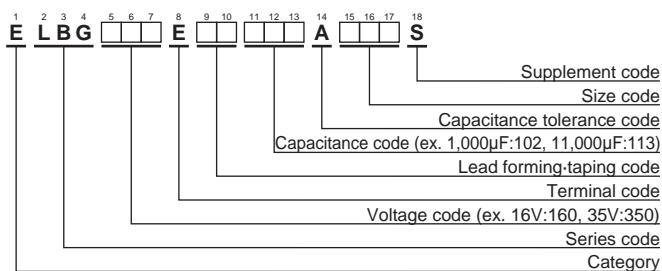

Please refer to "Product code guide (radial lead type)"



LBG Series

◆ **STANDARD RATINGS**

WV (V _{ac})	Cap (μF)	Case size φ D×L(mm)	tan δ	Impedance (Ω max./100kHz)		Rated ripple current (mA _{rms} /105°C, 100kHz)	Part No.
				20°C	-40°C		
25	1,700	12.5 × 20	0.20	0.057	0.29	1,700	ELBG250E □□ 172AK20S
	2,400	12.5 × 25	0.22	0.045	0.23	2,000	ELBG250E □□ 242AK25S
	2,400	14.5 × 20	0.22	0.051	0.26	2,000	ELBG250E □□ 242AU20S
	2,800	12.5 × 30	0.22	0.039	0.20	2,300	ELBG250E □□ 282AK30S
	3,000	16 × 20	0.24	0.044	0.22	2,250	ELBG250E □□ 302AL20S
	3,400	14.5 × 25	0.24	0.041	0.21	2,400	ELBG250E □□ 342AU25S
	3,500	12.5 × 35	0.24	0.033	0.17	2,700	ELBG250E □□ 352AK35S
	4,200	16 × 25	0.26	0.033	0.17	2,600	ELBG250E □□ 422AL25S
	4,200	18 × 20	0.26	0.042	0.21	2,500	ELBG250E □□ 422AM20S
	4,500	12.5 × 40	0.26	0.027	0.14	3,100	ELBG250E □□ 452AK40S
	4,600	14.5 × 31.5	0.26	0.032	0.16	2,700	ELBG250E □□ 462AUN3S
	5,400	14.5 × 35.5	0.28	0.028	0.14	3,100	ELBG250E □□ 542AUP1S
	5,600	16 × 31.5	0.28	0.026	0.13	3,200	ELBG250E □□ 562ALN3S
	6,000	18 × 25	0.30	0.030	0.15	2,800	ELBG250E □□ 602AM25S
	6,400	14.5 × 40	0.30	0.025	0.13	3,400	ELBG250E □□ 642AU40S
	6,600	16 × 35.5	0.30	0.023	0.12	3,500	ELBG250E □□ 662ALP1S
	7,800	16 × 40	0.32	0.021	0.11	3,800	ELBG250E □□ 782AL40S
	7,900	18 × 31.5	0.32	0.024	0.12	3,500	ELBG250E □□ 792AMN3S
9,200	18 × 35.5	0.36	0.022	0.11	3,700	ELBG250E □□ 922AMP1S	
11,000	18 × 40	0.40	0.020	0.10	4,000	ELBG250E □□ 113AM40S	
35	1,000	12.5 × 20	0.16	0.057	0.29	1,700	ELBG350E □□ 102AK20S
	1,400	12.5 × 25	0.16	0.045	0.23	2,000	ELBG350E □□ 142AK25S
	1,400	14.5 × 20	0.16	0.051	0.26	2,000	ELBG350E □□ 142AU20S
	1,600	12.5 × 30	0.16	0.039	0.20	2,300	ELBG350E □□ 162AK30S
	1,800	16 × 20	0.16	0.044	0.22	2,250	ELBG350E □□ 182AL20S
	2,000	14.5 × 25	0.18	0.041	0.21	2,400	ELBG350E □□ 202AU25S
	2,100	12.5 × 35	0.18	0.033	0.17	2,700	ELBG350E □□ 212AK35S
	2,500	16 × 25	0.18	0.033	0.17	2,600	ELBG350E □□ 252AL25S
	2,500	18 × 20	0.18	0.042	0.21	2,500	ELBG350E □□ 252AM20S
	2,700	12.5 × 40	0.18	0.027	0.14	3,100	ELBG350E □□ 272AK40S
	2,800	14.5 × 31.5	0.18	0.032	0.16	2,700	ELBG350E □□ 282AUN3S
	3,200	14.5 × 35.5	0.20	0.028	0.14	3,100	ELBG350E □□ 322AUP1S
	3,400	16 × 31.5	0.20	0.026	0.13	3,200	ELBG350E □□ 342ALN3S
	3,600	18 × 25	0.20	0.030	0.15	2,800	ELBG350E □□ 362AM25S
	3,800	14.5 × 40	0.20	0.025	0.13	3,400	ELBG350E □□ 382AU40S
	4,000	16 × 35.5	0.22	0.023	0.12	3,500	ELBG350E □□ 402ALP1S
	4,700	16 × 40	0.22	0.021	0.11	3,800	ELBG350E □□ 472AL40S
	4,800	18 × 31.5	0.22	0.024	0.12	3,500	ELBG350E □□ 482AMN3S
5,600	18 × 35.5	0.24	0.022	0.11	3,700	ELBG350E □□ 562AMP1S	
6,700	18 × 40	0.26	0.020	0.10	4,000	ELBG350E □□ 672AM40S	

□□ : Enter the appropriate lead forming or taping code.

◆ **RATED RIPPLE CURRENT MULTIPLIERS**

● Frequency Multipliers

Capacitance(μF) \ Frequency(Hz)	120	1k	10k	100k
1,000 to 2,000	0.60	0.87	0.95	1.00
2,100 to 3,800	0.75	0.90	0.95	1.00
4,000 to 11,000	0.85	0.95	0.98	1.00

The deterioration of aluminum electrolytic capacitors accelerates their life due to the internal heating produced by ripple current. For details, refer to Section "5-3 Ripple Current Effect on Lifetime" in the catalog, Technical Note.

Product code guide (Snap-in type)

(Example : KMS series, 400V-330μF, φ30×30L)



Please refer to the following table

For more details, refer to Product Guide.

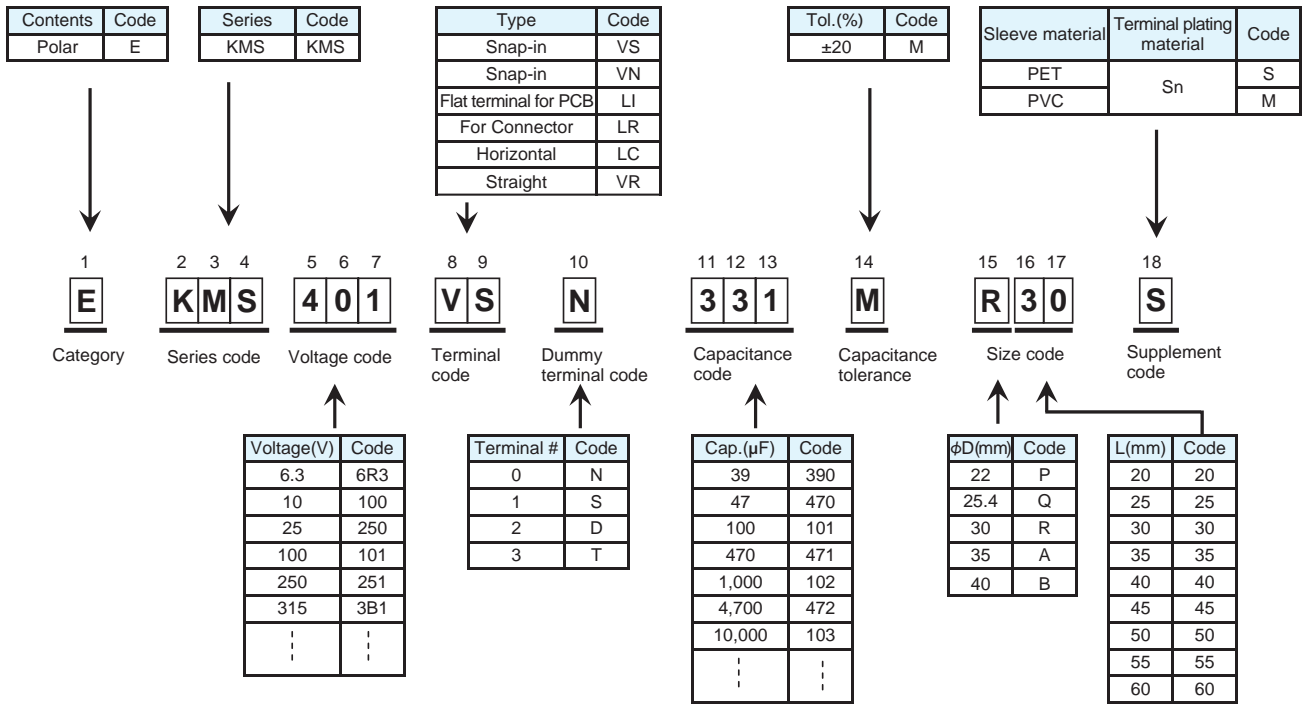

*Refer to the appendix (Part number) for codes not listed here.

Available terminals

[mm]

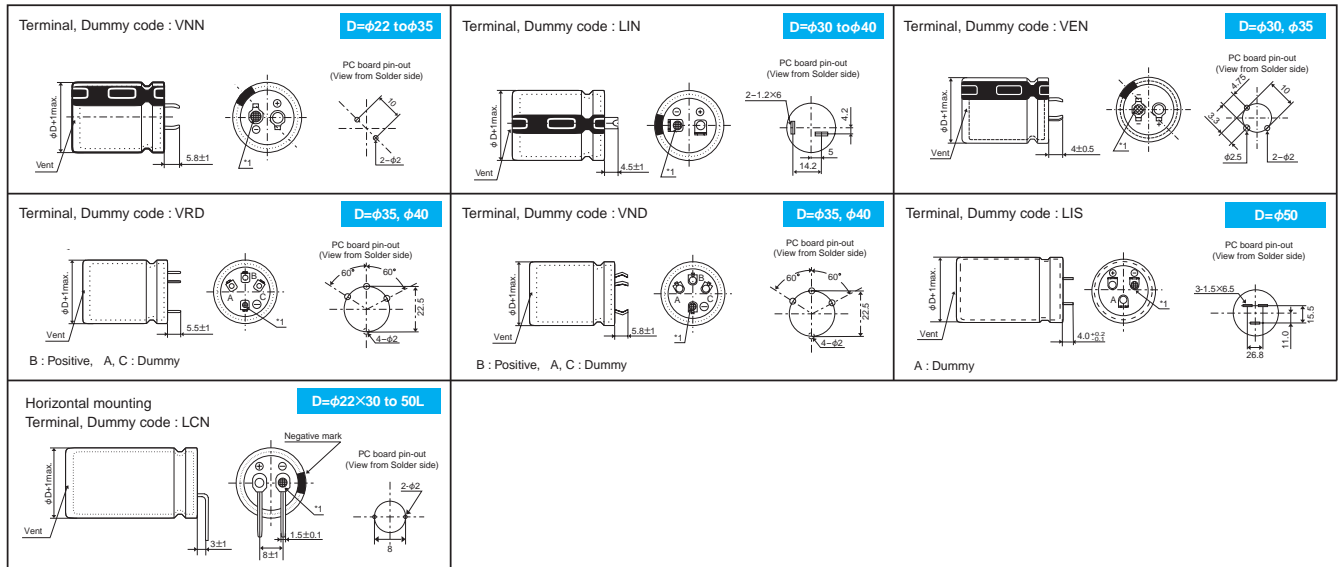

*1 Negative terminal : Mesh marking

*2 Use the dummy terminals for mechanical support only.

The dummy terminals must not be connected to any circuit trace on PC board, be sure to electrically isolate from the negative and the positive terminals.

SMR Series

- Endurance with ripple current : 2,000 hours at 85°C
- Downsized and high ripple current from SMQ series
- Non solvent resistant type
- RoHS2 Compliant

SMR

↑
Downsized
Higher ripple
SMQ



SPECIFICATIONS

Items	Characteristics		
Category	-25 to +85°C		
Temperature Range	-25 to +85°C		
Rated Voltage Range	400 to 450V _{dc}		
Capacitance Tolerance	±20% (M) (at 20°C, 120Hz)		
Leakage Current	I ≤ 3.0/CV Where, I : Max. leakage current (µA), C : Nominal capacitance (µF), V : Rated voltage (V) (at 20°C after 5 minutes)		
Dissipation Factor (tan δ)	Rated voltage (V _{dc})	400V	420 & 450V
	tan δ (Max.)	0.15	0.20
Low Temperature Characteristics (Max. Impedance Ratio)	Rated voltage (V _{dc})	400 to 450V	
	Z(-25°C)/Z(+20°C)	8	
Endurance	The following specifications shall be satisfied when the capacitors are restored to 20°C after subjected to DC voltage with the rated ripple current is applied (the peak voltage shall not exceed the rated voltage) for 2,000 hours at 85°C.		
	Capacitance change	≤ ±20% of the initial value	
	D. F. (tan δ)	≤ 200% of the initial specified value	
	Leakage current	≤ The initial specified value	
Shelf Life	The following specifications shall be satisfied when the capacitors are restored to 20°C after exposing them for 1,000 hours at 85°C without voltage applied. Before the measurement, the capacitor shall be preconditioned by applying voltage according to Item 4.1 of JIS C 5101-4.		
	Capacitance change	≤ ±15% of the initial value	
	D. F. (tan δ)	≤ 150% of the initial specified value	
	Leakage current	≤ The initial specified value	

DIMENSIONS [mm]

● Terminal Code : VS (φ22 to φ35) : Standard

● Terminal Code : LI (φ35)

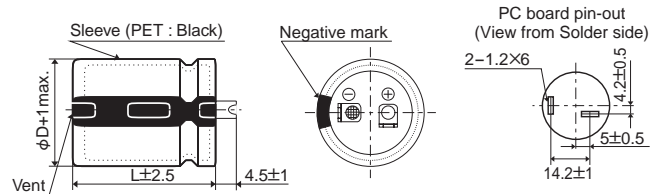
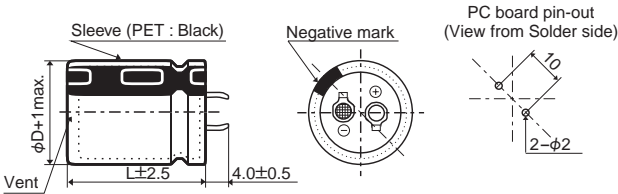

The standard design has no plastic disc.

PART NUMBERING SYSTEM

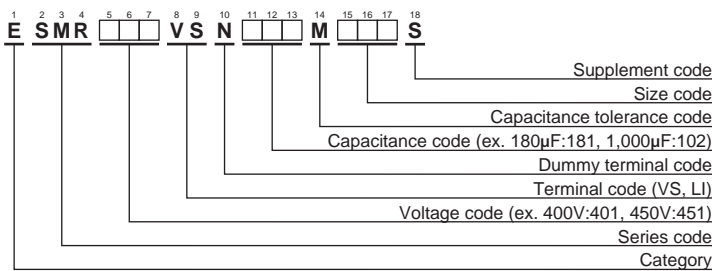

Please refer to "Product code guide (snap-in type)"



SMR Series

◆STANDARD RATINGS

WV (V _{dc})	Cap (μF)	Case size φD×L(mm)	tan δ	Rated ripple current (Arms/85°C, 120Hz)	Part No.	WV (V _{dc})	Cap (μF)	Case size φD×L(mm)	tan δ	Rated ripple current (Arms/85°C, 120Hz)	Part No.	
400	150	22 × 25	0.15	1.30	ESMR401VSN151MP25S	420	330	35 × 25	0.20	1.99	ESMR421VSN331MA25S	
	180	22 × 30	0.15	1.49	ESMR401VSN181MP30S		390	25.4 × 45	0.20	2.47	ESMR421VSN391MQ45S	
	220	22 × 35	0.15	1.69	ESMR401VSN221MP35S		390	30 × 35	0.20	2.32	ESMR421VSN391MR35S	
	220	25.4 × 25	0.15	1.65	ESMR401VSN221MQ25S		470	25.4 × 50	0.20	2.77	ESMR421VSN471MQ50S	
	270	22 × 40	0.15	1.90	ESMR401VSN271MP40S		470	30 × 40	0.20	2.61	ESMR421VSN471MR40S	
	270	25.4 × 30	0.15	1.88	ESMR401VSN271MQ30S		470	35 × 30	0.20	2.41	ESMR421VSN471MA30S	
	330	22 × 45	0.15	2.15	ESMR401VSN331MP45S		560	30 × 45	0.20	2.93	ESMR421VSN561MR45S	
	330	25.4 × 35	0.15	2.16	ESMR401VSN331MQ35S		560	35 × 35	0.20	2.67	ESMR421VSN561MA35S	
	330	30 × 25	0.15	2.10	ESMR401VSN331MR25S		680	30 × 50	0.20	3.28	ESMR421VSN681MR50S	
	390	22 × 50	0.15	2.40	ESMR401VSN391MP50S		680	35 × 40	0.20	3.11	ESMR421VSN681MA40S	
	390	25.4 × 40	0.15	2.40	ESMR401VSN391MQ40S		820	35 × 45	0.20	3.43	ESMR421VSN821MA45S	
	390	30 × 30	0.15	2.32	ESMR401VSN391MR30S		450	120	22 × 25	0.20	1.12	ESMR451VSN121MP25S
	390	35 × 25	0.15	2.05	ESMR401VSN391MA25S			150	22 × 30	0.20	1.32	ESMR451VSN151MP30S
	470	25.4 × 45	0.15	2.69	ESMR401VSN471MQ45S			180	22 × 35	0.20	1.49	ESMR451VSN181MP35S
	470	30 × 35	0.15	2.60	ESMR401VSN471MR35S			180	25.4 × 25	0.20	1.42	ESMR451VSN181MQ25S
	470	35 × 30	0.15	2.28	ESMR401VSN471MA30S			220	22 × 40	0.20	1.67	ESMR451VSN221MP40S
	560	30 × 40	0.15	2.92	ESMR401VSN561MR40S			220	25.4 × 30	0.20	1.66	ESMR451VSN221MQ30S
	560	35 × 30	0.15	2.48	ESMR401VSN561MA30S			220	30 × 25	0.20	1.68	ESMR451VSN221MR25S
	680	30 × 45	0.15	3.30	ESMR401VSN681MR45S			270	22 × 45	0.20	1.88	ESMR451VSN271MP45S
	680	35 × 35	0.15	2.79	ESMR401VSN681MA35S			270	25.4 × 35	0.20	1.87	ESMR451VSN271MQ35S
820	35 × 45	0.15	3.25	ESMR401VSN821MA45S	330	25.4 × 40		0.20	2.11	ESMR451VSN331MQ40S		
1,000	35 × 50	0.15	3.66	ESMR401VSN102MA50S	330	30 × 30		0.20	2.10	ESMR451VSN331MR30S		
420	120	22 × 25	0.20	1.15	ESMR421VSN121MP25S	330		35 × 25	0.20	2.10	ESMR451VSN331MA25S	
	180	22 × 30	0.20	1.48	ESMR421VSN181MP30S	390		25.4 × 50	0.20	2.37	ESMR451VSN391MQ50S	
	180	25.4 × 25	0.20	1.51	ESMR421VSN181MQ25S	390		30 × 35	0.20	2.32	ESMR451VSN391MR35S	
	220	22 × 35	0.20	1.68	ESMR421VSN221MP35S	390		35 × 30	0.20	2.32	ESMR451VSN391MA30S	
	220	25.4 × 30	0.20	1.71	ESMR421VSN221MQ30S	470		30 × 40	0.20	2.66	ESMR451VSN471MR40S	
	270	22 × 45	0.20	1.94	ESMR421VSN271MP45S	470		35 × 35	0.20	2.54	ESMR451VSN471MA35S	
	270	25.4 × 35	0.20	1.99	ESMR421VSN271MQ35S	560		30 × 45	0.20	2.93	ESMR451VSN561MR45S	
	270	30 × 25	0.20	1.87	ESMR421VSN271MR25S	560		35 × 40	0.20	2.87	ESMR451VSN561MA40S	
	330	22 × 50	0.20	2.20	ESMR421VSN331MP50S	680		35 × 45	0.20	3.21	ESMR451VSN681MA45S	
	330	25.4 × 40	0.20	2.24	ESMR421VSN331MQ40S	820	35 × 50	0.20	3.60	ESMR451VSN821MA50S		
	330	30 × 30	0.20	2.08	ESMR421VSN331MR30S							

◆RATED RIPPLE CURRENT MULTIPLIERS

●Frequency Multipliers

Frequency(Hz)	50	120	300	1k	10k	50k
400 to 450V _{dc}	0.77	1.00	1.16	1.30	1.41	1.43

The deterioration of aluminum electrolytic capacitors accelerates their life due to the internal heating produced by ripple current. For details, refer to Section "5-3 Ripple Current Effect on Lifetime" in the catalog, Technical Note.

SMQ Series

- Endurance with ripple current : 2,000 hours at 85°C
- Non solvent resistant type
- RoHS2 Compliant

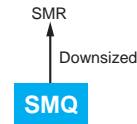

SPECIFICATIONS

Items	Characteristics			
Category	-25 to +85°C			
Temperature Range	-25 to +85°C			
Rated Voltage Range	160 to 450V _{dc}			
Capacitance Tolerance	±20% (M) (at 20°C, 120Hz)			
Leakage Current	I ≤ 3√CV Where, I : Max. leakage current (µA), C : Nominal capacitance (µF), V : Rated voltage (V) (at 20°C after 5 minutes)			
Dissipation Factor (tan δ)	Rated voltage (V _{dc})	160 to 250V	315 to 400V	420 & 450V
	tan δ (Max.)	0.15	0.15	0.20 (at 20°C, 120Hz)
Low Temperature Characteristics (Max. Impedance Ratio)	Rated voltage (V _{dc})	160 to 250V	315 to 400V	420 & 450V
	Z(-25°C)/Z(+20°C)	4	8	8 (at 120Hz)
Endurance	The following specifications shall be satisfied when the capacitors are restored to 20°C after subjected to DC voltage with the rated ripple current is applied (the peak voltage shall not exceed the rated voltage) for 2,000 hours at 85°C.			
	Capacitance change	≤ ±20% of the initial value		
	D. F. (tan δ)	≤ 200% of the initial specified value		
	Leakage current	≤ The initial specified value		
Shelf Life	The following specifications shall be satisfied when the capacitors are restored to 20°C after exposing them for 1,000 hours at 85°C without voltage applied. Before the measurement, the capacitor shall be preconditioned by applying voltage according to Item 4.1 of JIS C 5101-4.			
	Capacitance change	≤ ±15% of the initial value		
	D. F. (tan δ)	≤ 150% of the initial specified value		
	Leakage current	≤ The initial specified value		

DIMENSIONS [mm]

Terminal Code : VS (φ22 to φ35) : Standard

Terminal Code : LI (φ35)

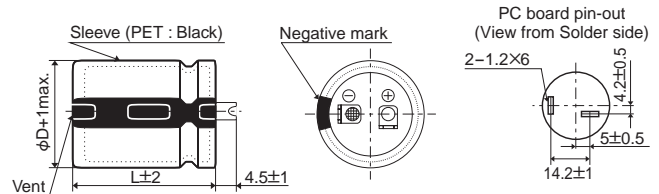
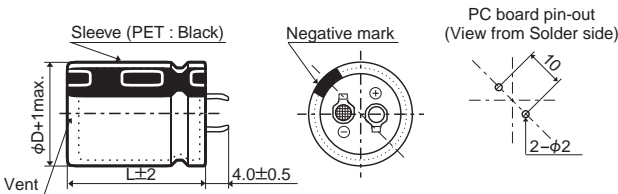

The standard design has no plastic disc.

PART NUMBERING SYSTEM

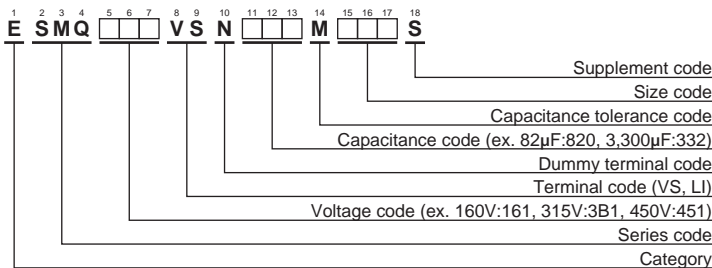

Please refer to "Product code guide (snap-in type)"



◆STANDARD RATINGS

WV (V _{dc})	Cap (μF)	Case size φD×L(mm)	tan δ	Rated ripple current (Arms/85°C, 120Hz)	Part No.	WV (V _{dc})	Cap (μF)	Case size φD×L(mm)	tan δ	Rated ripple current (Arms/85°C, 120Hz)	Part No.
160	560	22 × 25	0.15	2.25	ESMQ161VSN561MP25S	250	270	22 × 25	0.15	1.31	ESMQ251VSN271MP25S
	680	22 × 30	0.15	2.50	ESMQ161VSN681MP30S		330	22 × 30	0.15	1.75	ESMQ251VSN331MP30S
	820	22 × 35	0.15	2.75	ESMQ161VSN821MP35S		390	22 × 30	0.15	1.91	ESMQ251VSN391MP30S
	1,000	22 × 40	0.15	3.00	ESMQ161VSN102MP40S		390	25.4 × 25	0.15	1.91	ESMQ251VSN391MQ25S
	1,000	25.4 × 30	0.15	3.00	ESMQ161VSN102MQ30S		470	22 × 35	0.15	2.11	ESMQ251VSN471MP35S
	1,200	22 × 45	0.15	3.25	ESMQ161VSN122MP45S		470	25.4 × 30	0.15	2.11	ESMQ251VSN471MQ30S
	1,200	25.4 × 35	0.15	3.25	ESMQ161VSN122MQ35S		560	22 × 40	0.15	2.25	ESMQ251VSN561MP40S
	1,200	30 × 25	0.15	3.25	ESMQ161VSN122MR25S		560	25.4 × 30	0.15	2.25	ESMQ251VSN561MQ30S
	1,500	22 × 50	0.15	3.73	ESMQ161VSN152MP50S		560	30 × 25	0.15	2.25	ESMQ251VSN561MR25S
	1,500	25.4 × 40	0.15	3.73	ESMQ161VSN152MQ40S		680	22 × 45	0.15	2.50	ESMQ251VSN681MP45S
	1,500	30 × 30	0.15	3.73	ESMQ161VSN182MP30S		680	25.4 × 35	0.15	2.50	ESMQ251VSN681MQ35S
	1,500	35 × 25	0.15	3.73	ESMQ161VSN152MA25S		680	30 × 30	0.15	2.50	ESMQ251VSN681MR30S
	1,800	25.4 × 45	0.15	4.20	ESMQ161VSN182MQ45S		820	22 × 50	0.15	2.77	ESMQ251VSN821MP50S
	1,800	30 × 35	0.15	4.20	ESMQ161VSN182MR35S		820	25.4 × 40	0.15	2.77	ESMQ251VSN821MQ40S
	1,800	35 × 30	0.15	4.20	ESMQ161VSN182MA30S		820	30 × 30	0.15	2.77	ESMQ251VSN821MR30S
	2,200	30 × 40	0.15	4.78	ESMQ161VSN222MR40S		820	35 × 25	0.15	2.77	ESMQ251VSN821MA25S
	2,200	35 × 35	0.15	4.78	ESMQ161VSN222MA35S		1,000	25.4 × 45	0.15	3.32	ESMQ251VSN102MQ45S
	2,700	35 × 40	0.15	5.45	ESMQ161VSN272MA40S		1,000	30 × 35	0.15	3.32	ESMQ251VSN102MR35S
	3,300	35 × 45	0.15	5.75	ESMQ161VSN332MA45S		1,000	35 × 30	0.15	3.32	ESMQ251VSN102MA30S
	3,900	35 × 50	0.15	6.00	ESMQ161VSN392MA50S		1,200	30 × 40	0.15	3.53	ESMQ251VSN122MR40S
180	470	22 × 25	0.15	2.08	ESMQ181VSN471MP25S	1,200	35 × 35	0.15	3.53	ESMQ251VSN122MA35S	
	560	22 × 30	0.15	2.25	ESMQ181VSN561MP30S	1,500	30 × 50	0.15	4.04	ESMQ251VSN152MR50S	
	680	22 × 30	0.15	2.50	ESMQ181VSN681MP30S	1,500	35 × 40	0.15	4.04	ESMQ251VSN152MA40S	
	680	25.4 × 25	0.15	2.50	ESMQ181VSN681MQ25S	1,800	35 × 45	0.15	4.55	ESMQ251VSN182MA45S	
	820	22 × 35	0.15	2.75	ESMQ181VSN821MP35S	315	180	22 × 25	0.15	1.21	ESMQ315VSN181MP25S
	820	25.4 × 30	0.15	2.75	ESMQ181VSN821MQ30S		220	22 × 30	0.15	1.41	ESMQ315VSN221MP30S
	1,000	22 × 45	0.15	3.00	ESMQ181VSN102MP45S		270	22 × 30	0.15	1.60	ESMQ315VSN271MP30S
	1,000	25.4 × 35	0.15	3.00	ESMQ181VSN102MQ35S		330	22 × 40	0.15	1.82	ESMQ315VSN331MP40S
	1,000	30 × 25	0.15	3.00	ESMQ181VSN102MR25S		330	25.4 × 30	0.15	1.82	ESMQ315VSN331MQ30S
	1,200	22 × 50	0.15	3.31	ESMQ181VSN122MP50S		330	30 × 25	0.15	1.82	ESMQ315VSN331MR25S
	1,200	25.4 × 40	0.15	3.31	ESMQ181VSN122MQ40S		390	22 × 45	0.15	2.01	ESMQ315VSN391MP45S
	1,200	30 × 30	0.15	3.31	ESMQ181VSN122MR30S		390	25.4 × 35	0.15	2.01	ESMQ315VSN391MQ35S
	1,200	35 × 25	0.15	3.31	ESMQ181VSN122MA25S		390	30 × 30	0.15	2.01	ESMQ315VSN391MR30S
	1,500	25.4 × 45	0.15	3.83	ESMQ181VSN152MQ45S		470	22 × 50	0.15	2.27	ESMQ315VSN471MP50S
	1,500	30 × 35	0.15	3.83	ESMQ181VSN152MR35S		470	25.4 × 40	0.15	2.27	ESMQ315VSN471MQ40S
	1,500	35 × 30	0.15	3.83	ESMQ181VSN152MA30S		470	30 × 30	0.15	2.27	ESMQ315VSN471MR30S
	1,800	25.4 × 50	0.15	4.32	ESMQ181VSN182MQ50S		470	35 × 25	0.15	2.27	ESMQ315VSN471MA25S
	1,800	30 × 40	0.15	4.32	ESMQ181VSN182MR40S		560	25.4 × 45	0.15	2.56	ESMQ315VSN561MQ45S
	1,800	35 × 30	0.15	4.32	ESMQ181VSN182MA30S		560	30 × 35	0.15	2.56	ESMQ315VSN561MP35S
	2,200	30 × 45	0.15	4.92	ESMQ181VSN222MR45S		560	35 × 30	0.15	2.56	ESMQ315VSN561MA30S
2,200	35 × 40	0.15	4.92	ESMQ181VSN222MA40S	680		30 × 40	0.15	2.87	ESMQ315VSN681MR40S	
2,700	35 × 45	0.15	5.52	ESMQ181VSN272MA45S	680		35 × 35	0.15	2.87	ESMQ315VSN681MA35S	
3,300	35 × 50	0.15	5.75	ESMQ181VSN332MA50S	820		30 × 45	0.15	3.25	ESMQ315VSN821MP45S	
200	390	22 × 25	0.15	1.68	ESMQ201VSN391MP25S		820	35 × 40	0.15	3.25	ESMQ315VSN821MA40S
	470	22 × 30	0.15	1.85	ESMQ201VSN471MP30S	1,000	30 × 50	0.15	3.63	ESMQ315VSN102MR50S	
	560	22 × 30	0.15	2.43	ESMQ201VSN561MP30S	1,000	35 × 45	0.15	3.63	ESMQ315VSN102MA45S	
	560	25.4 × 25	0.15	2.43	ESMQ201VSN561MQ25S	350	150	22 × 25	0.15	1.12	ESMQ351VSN151MP25S
	680	22 × 35	0.15	2.68	ESMQ201VSN681MP35S		180	22 × 30	0.15	1.22	ESMQ351VSN181MP30S
	680	25.4 × 30	0.15	2.68	ESMQ201VSN681MQ30S		220	22 × 35	0.15	1.44	ESMQ351VSN221MP35S
	820	22 × 40	0.15	2.93	ESMQ201VSN821MP40S		270	22 × 40	0.15	1.66	ESMQ351VSN271MP40S
	820	25.4 × 30	0.15	2.93	ESMQ201VSN821MQ30S		270	25.4 × 30	0.15	1.66	ESMQ351VSN271MQ30S
	820	30 × 25	0.15	2.93	ESMQ201VSN821MR25S		330	22 × 45	0.15	1.88	ESMQ351VSN331MP45S
	1,000	22 × 45	0.15	3.25	ESMQ201VSN102MP45S		330	25.4 × 35	0.15	1.88	ESMQ351VSN331MQ35S
	1,000	25.4 × 35	0.15	3.25	ESMQ201VSN102MQ35S		390	22 × 50	0.15	2.06	ESMQ351VSN391MP50S
	1,000	30 × 30	0.15	3.25	ESMQ201VSN102MR30S		390	25.4 × 40	0.15	2.06	ESMQ351VSN391MQ40S
	1,000	35 × 25	0.15	3.25	ESMQ201VSN102MA25S		390	30 × 30	0.15	2.06	ESMQ351VSN391MR30S
	1,200	25.4 × 40	0.15	3.50	ESMQ201VSN122MQ40S		390	35 × 25	0.15	2.06	ESMQ351VSN391MA25S
	1,200	30 × 30	0.15	3.50	ESMQ201VSN122MR30S		470	25.4 × 45	0.15	2.40	ESMQ351VSN471MQ45S
	1,200	35 × 30	0.15	3.50	ESMQ201VSN122MA30S		470	30 × 35	0.15	2.40	ESMQ351VSN471MR35S
	1,500	25.4 × 50	0.15	3.87	ESMQ201VSN152MQ50S		470	35 × 30	0.15	2.40	ESMQ351VSN471MA30S
	1,500	30 × 35	0.15	3.87	ESMQ201VSN152MR35S		560	25.4 × 50	0.15	2.60	ESMQ351VSN561MQ50S
	1,500	35 × 30	0.15	3.87	ESMQ201VSN152MA30S		560	30 × 40	0.15	2.60	ESMQ351VSN561MR40S
	1,800	30 × 45	0.15	4.32	ESMQ201VSN182MR45S		560	35 × 30	0.15	2.60	ESMQ351VSN561MA30S
1,800	35 × 35	0.15	4.32	ESMQ201VSN182MA35S	680		30 × 45	0.15	2.96	ESMQ351VSN681MR45S	
2,200	30 × 50	0.15	4.92	ESMQ201VSN222MR50S	680		35 × 35	0.15	2.96	ESMQ351VSN681MA35S	
2,200	35 × 40	0.15	4.92	ESMQ201VSN222MA40S	820		30 × 50	0.15	3.25	ESMQ351VSN821MR50S	
2,700	35 × 50	0.15	5.45	ESMQ201VSN272MA50S	820	35 × 45	0.15	3.25	ESMQ351VSN821MA45S		

Product specifications in this catalog are subject to change without notice. Request our product specifications before purchase and/or use. Please use our products based on the information contained in this catalog and product specifications.



◆STANDARD RATINGS

WV (V _{dc})	Cap (μF)	Case size φD×L(mm)	tan δ	Rated ripple current (Arms/85°C, 120Hz)	Part No.	WV (V _{dc})	Cap (μF)	Case size φD×L(mm)	tan δ	Rated ripple current (Arms/85°C, 120Hz)	Part No.	
350	1,000	35 × 50	0.15	3.54	ESMQ351VSN102MA50S	420	270	30 × 30	0.20	1.94	ESMQ421VSN271MR30S	
	120	22 × 25	0.15	1.02	ESMQ401VSN121MP25S		330	25.4 × 45	0.20	2.17	ESMQ421VSN331MQ45S	
	150	22 × 30	0.15	1.16	ESMQ401VSN151MP30S		330	30 × 35	0.20	2.17	ESMQ421VSN331MR35S	
	180	22 × 35	0.15	1.44	ESMQ401VSN181MP35S		330	35 × 30	0.20	2.17	ESMQ421VSN331MA30S	
	220	22 × 40	0.15	1.49	ESMQ401VSN221MP40S		390	25.4 × 50	0.20	2.27	ESMQ421VSN391MQ50S	
	220	25.4 × 30	0.15	1.49	ESMQ401VSN221MQ30S		390	30 × 35	0.20	2.27	ESMQ421VSN391MR35S	
	270	22 × 45	0.15	1.67	ESMQ401VSN271MP45S		390	35 × 30	0.20	2.27	ESMQ421VSN391MA30S	
	270	25.4 × 35	0.15	1.67	ESMQ401VSN271MQ35S		470	30 × 40	0.20	2.61	ESMQ421VSN471MR40S	
	270	30 × 25	0.15	1.67	ESMQ401VSN271MR25S		470	35 × 35	0.20	2.61	ESMQ421VSN471MA35S	
	330	22 × 50	0.15	1.90	ESMQ401VSN331MP50S		560	30 × 50	0.20	2.82	ESMQ421VSN561MR50S	
	330	25.4 × 40	0.15	1.90	ESMQ401VSN331MP40S		560	35 × 40	0.20	2.82	ESMQ421VSN561MA40S	
	330	30 × 30	0.15	1.90	ESMQ401VSN331MR30S		680	35 × 45	0.20	3.11	ESMQ421VSN681MA45S	
	330	35 × 25	0.15	1.90	ESMQ401VSN331MA25S		450	82	22 × 25	0.20	0.83	ESMQ451VSN820MP25S
	390	25.4 × 45	0.15	2.13	ESMQ401VSN391MQ45S			100	22 × 25	0.20	0.93	ESMQ451VSN101MP25S
	390	30 × 35	0.15	2.13	ESMQ401VSN391MP35S			120	22 × 30	0.20	1.04	ESMQ451VSN121MP30S
	390	35 × 30	0.15	2.13	ESMQ401VSN391MA30S			150	22 × 35	0.20	1.19	ESMQ451VSN151MP35S
470	25.4 × 50	0.15	2.39	ESMQ401VSN471MQ50S	150	25.4 × 25		0.20	1.19	ESMQ451VSN151MQ25S		
470	30 × 40	0.15	2.39	ESMQ401VSN471MR40S	180	22 × 40		0.20	1.35	ESMQ451VSN181MP40S		
470	35 × 30	0.15	2.39	ESMQ401VSN471MA30S	180	25.4 × 30		0.20	1.35	ESMQ451VSN181MQ30S		
560	30 × 45	0.15	2.69	ESMQ401VSN561MR45S	220	22 × 45		0.20	1.55	ESMQ451VSN221MP45S		
560	35 × 35	0.15	2.69	ESMQ401VSN561MA35S	220	25.4 × 40		0.20	1.55	ESMQ451VSN221MQ40S		
680	30 × 50	0.15	2.96	ESMQ401VSN681MR50S	220	30 × 30		0.20	1.55	ESMQ451VSN221MR30S		
680	35 × 40	0.15	2.96	ESMQ401VSN681MA40S	220	35 × 25		0.20	1.55	ESMQ451VSN221MA25S		
820	35 × 45	0.15	3.25	ESMQ401VSN821MA45S	270	22 × 50		0.20	1.78	ESMQ451VSN271MP50S		
400	100	22 × 25	0.20	0.97	ESMQ421VSN101MP25S	270		25.4 × 40	0.20	1.78	ESMQ451VSN271MQ40S	
	120	22 × 25	0.20	1.08	ESMQ421VSN121MP25S	270		30 × 30	0.20	1.78	ESMQ451VSN271MR30S	
	150	22 × 30	0.20	1.30	ESMQ421VSN151MP30S	330		25.4 × 50	0.20	2.01	ESMQ451VSN331MQ50S	
	150	25.4 × 25	0.20	1.30	ESMQ421VSN151MQ25S	330		30 × 40	0.20	2.01	ESMQ451VSN331MR40S	
	180	22 × 35	0.20	1.48	ESMQ421VSN181MP35S	330	35 × 30	0.20	2.01	ESMQ451VSN331MA30S		
	180	25.4 × 30	0.20	1.48	ESMQ421VSN181MQ30S	390	30 × 40	0.20	2.24	ESMQ451VSN391MR40S		
	220	22 × 40	0.20	1.65	ESMQ421VSN221MP40S	390	35 × 35	0.20	2.24	ESMQ451VSN391MA35S		
	220	25.4 × 35	0.20	1.65	ESMQ421VSN221MQ35S	470	30 × 45	0.20	2.53	ESMQ451VSN471MR45S		
	220	30 × 25	0.20	1.65	ESMQ421VSN221MR25S	470	35 × 40	0.20	2.53	ESMQ451VSN471MA40S		
	270	22 × 50	0.20	1.94	ESMQ421VSN271MP50S	560	30 × 50	0.20	2.82	ESMQ451VSN561MR50S		
	270	25.4 × 35	0.20	1.94	ESMQ421VSN271MQ35S	560	35 × 45	0.20	2.82	ESMQ451VSN561MA45S		

◆RATED RIPPLE CURRENT MULTIPLIERS

●Frequency Multipliers

Frequency(Hz)	50	120	300	1k	10k	50k
160 to 250V _{dc}	0.81	1.00	1.17	1.32	1.45	1.50
315 to 450V _{dc}	0.77	1.00	1.16	1.30	1.41	1.43

The deterioration of aluminum electrolytic capacitors accelerates their life due to the internal heating produced by ripple current. For details, refer to Section "5-3 Ripple Current Effect on Lifetime" in the catalog, Technical Note.

KHV New!
Series

- The KMR series has been improved to have a higher capacitance and ripple current.
- Endurance with ripple current : 2,000 hours at 105°C
- Rated voltage range : 350 to 400V_{dc}, Capacitance range : 160 to 1,610µF
- For inverter control, switching power supplies
- Non solvent resistant type
- RoHS2 Compliant
- The logo mark printed on the sleeve will be changed.

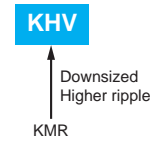

◆ SPECIFICATIONS

Items	Characteristics	
Category	-40 to +105°C	
Temperature Range	-40 to +105°C	
Rated Voltage Range	350 to 400V _{dc}	
Capacitance Tolerance	±20% (M) (at 20°C, 120Hz)	
Leakage Current	I ≤ 3√CV Where, I : Max. leakage current (µA), C : Nominal capacitance (µF), V : Rated voltage (V) (at 20°C after 5 minutes)	
Dissipation Factor (tan δ)	Rated voltage (V _{dc})	350 to 400V
	tan δ (Max.)	0.15 (at 20°C, 120Hz)
Low Temperature Characteristics (Max. Impedance Ratio)	Rated voltage (V _{dc})	350 to 400V
	Z(-25°C)/Z(+20°C)	5
	Z(-40°C)/Z(+20°C)	20 (at 120Hz)
Endurance	The following specifications shall be satisfied when the capacitors are restored to 20°C after subjected to DC voltage with the rated ripple current is applied (the peak voltage shall not exceed the rated voltage) for 2,000 hours at 105°C.	
	Capacitance change	≤ ±20% of the initial value
	D.F. (tan δ)	≤ 200% of the initial specified value
	Leakage current	≤ The initial specified value
Shelf Life	The following specifications shall be satisfied when the capacitors are restored to 20°C after exposing them for 1,000 hours at 105°C without voltage applied. Before the measurement, the capacitor shall be preconditioned by applying voltage according to Item 4.1 of JIS C 5101-4.	
	Capacitance change	≤ ±15% of the initial value
	D.F. (tan δ)	≤ 150% of the initial specified value
	Leakage current	≤ The initial specified value

◆ DIMENSIONS [mm]

• Terminal Code : VS (φ22 to φ35) : Standard

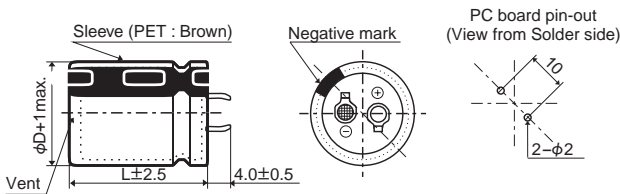

• Terminal Code : LI (φ30, φ35)

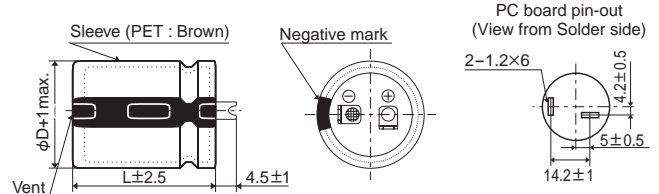

The standard design has no plastic disc.

◆ PART NUMBERING SYSTEM

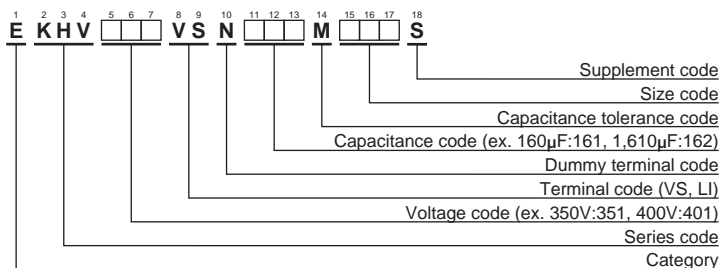

Please refer to "Product code guide (snap-in type)"

◆ STANDARD RATINGS

WV (V _{dc})	Cap (μF)	Case size φD×L(mm)	tan δ	Rated ripple current (Arms/105°C, 120Hz)	Part No.	WV (V _{dc})	Cap (μF)	Case size φD×L(mm)	tan δ	Rated ripple current (Arms/105°C, 120Hz)	Part No.	
350	180	22 × 25	0.15	1.43	EKHV351VSN181MP25S	375	580	30 × 35	0.15	2.70	EKHV3H1VSN581MR35S	
	240	22 × 30	0.15	1.73	EKHV351VSN241MP30S		600	25.4 × 50	0.15	2.95	EKHV3H1VSN601MQ50S	
	260	25.4 × 25	0.15	1.72	EKHV351VSN261MQ25S		610	35 × 30	0.15	2.51	EKHV3H1VSN611MA30S	
	290	22 × 35	0.15	1.95	EKHV351VSN291MP35S		670	25.4 × 55	0.15	3.17	EKHV3H1VSN671MQ55S	
	330	25.4 × 30	0.15	1.99	EKHV351VSN331MQ30S		690	30 × 40	0.15	3.03	EKHV3H1VSN691MR40S	
	350	22 × 40	0.15	2.19	EKHV351VSN351MP40S		740	25.4 × 60	0.15	3.39	EKHV3H1VSN741MQ60S	
	390	30 × 25	0.15	2.14	EKHV351VSN391MR25S		760	35 × 35	0.15	2.85	EKHV3H1VSN761MA35S	
	400	22 × 45	0.15	2.39	EKHV351VSN401MP45S		800	30 × 45	0.15	3.34	EKHV3H1VSN801MR45S	
	410	25.4 × 35	0.15	2.31	EKHV351VSN411MQ35S		910	30 × 50	0.15	3.63	EKHV3H1VSN911MR50S	
	460	22 × 50	0.15	2.62	EKHV351VSN461MP50S		910	35 × 40	0.15	3.22	EKHV3H1VSN911MA40S	
	490	25.4 × 40	0.15	2.57	EKHV351VSN491MQ40S		1,010	30 × 55	0.15	3.90	EKHV3H1VSN102MR55S	
	500	35 × 25	0.15	2.24	EKHV351VSN501MA25S		1,060	35 × 45	0.15	3.57	EKHV3H1VSN1A2MA45S	
	510	22 × 55	0.15	2.81	EKHV351VSN511MP55S		1,120	30 × 60	0.15	4.18	EKHV3H1VSN112MR60S	
	510	30 × 30	0.15	2.47	EKHV351VSN511MR30S		1,200	35 × 50	0.15	3.88	EKHV3H1VSN122MA50S	
	560	25.4 × 45	0.15	2.81	EKHV351VSN561MQ45S		1,350	35 × 55	0.15	4.20	EKHV3H1VSN1D2MA55S	
	570	22 × 60	0.15	3.02	EKHV351VSN571MP60S		1,500	35 × 60	0.15	4.51	EKHV3H1VSN152MA60S	
	620	30 × 35	0.15	2.79	EKHV351VSN621MR35S		400	160	22 × 25	0.15	1.35	EKHV401VSN161MP25S
	640	25.4 × 50	0.15	3.05	EKHV351VSN641MQ50S			200	22 × 30	0.15	1.58	EKHV401VSN201MP30S
	660	35 × 30	0.15	2.62	EKHV351VSN661MA30S			220	25.4 × 25	0.15	1.58	EKHV401VSN221MQ25S
	720	25.4 × 55	0.15	3.29	EKHV351VSN721MQ55S			250	22 × 35	0.15	1.81	EKHV401VSN251MP35S
	740	30 × 40	0.15	3.14	EKHV351VSN741MR40S			290	25.4 × 30	0.15	1.86	EKHV401VSN291MQ30S
	790	25.4 × 60	0.15	3.50	EKHV351VSN791MQ60S			300	22 × 40	0.15	2.03	EKHV401VSN301MP40S
	820	35 × 35	0.15	2.96	EKHV351VSN821MA35S			340	30 × 25	0.15	1.99	EKHV401VSN341MR25S
	860	30 × 45	0.15	3.47	EKHV351VSN861MR45S			350	22 × 45	0.15	2.23	EKHV401VSN351MP45S
970	30 × 50	0.15	3.74	EKHV351VSN971MR50S	350	25.4 × 35		0.15	2.13	EKHV401VSN351MQ35S		
980	35 × 40	0.15	3.34	EKHV351VSN981MA40S	390	22 × 50		0.15	2.41	EKHV401VSN391MP50S		
1,090	30 × 55	0.15	4.05	EKHV351VSN112MR55S	420	25.4 × 40		0.15	2.38	EKHV401VSN421MQ40S		
1,130	35 × 45	0.15	3.69	EKHV351VSN1B2MA45S	430	35 × 25		0.15	2.08	EKHV401VSN431MA25S		
1,210	30 × 60	0.15	4.34	EKHV351VSN122MR60S	440	22 × 55		0.15	2.61	EKHV401VSN441MP55S		
1,290	35 × 50	0.15	4.02	EKHV351VSN132MA50S	440	30 × 30		0.15	2.29	EKHV401VSN441MR30S		
1,450	35 × 55	0.15	4.35	EKHV351VSN1E2MA55S	480	25.4 × 45		0.15	2.60	EKHV401VSN481MQ45S		
1,610	35 × 60	0.15	4.67	EKHV351VSN162MA60S	490	22 × 60		0.15	2.80	EKHV401VSN491MP60S		
375	170	22 × 25	0.15	1.39	EKHV3H1VSN171MP25S	540		30 × 35	0.15	2.60	EKHV401VSN541MR35S	
	220	22 × 30	0.15	1.66	EKHV3H1VSN221MP30S	550		25.4 × 50	0.15	2.83	EKHV401VSN551MQ50S	
	240	25.4 × 25	0.15	1.65	EKHV3H1VSN241MQ25S	570		35 × 30	0.15	2.43	EKHV401VSN571MA30S	
	270	22 × 35	0.15	1.88	EKHV3H1VSN271MP35S	620		25.4 × 55	0.15	3.05	EKHV401VSN621MQ55S	
	310	25.4 × 30	0.15	1.92	EKHV3H1VSN311MQ30S	640		30 × 40	0.15	2.92	EKHV401VSN641MR40S	
	320	22 × 40	0.15	2.09	EKHV3H1VSN321MP40S	680		25.4 × 60	0.15	3.25	EKHV401VSN681MQ60S	
	370	30 × 25	0.15	2.08	EKHV3H1VSN371MR25S	700		35 × 35	0.15	2.73	EKHV401VSN701MA35S	
	380	22 × 45	0.15	2.33	EKHV3H1VSN381MP45S	740		30 × 45	0.15	3.22	EKHV401VSN741MR45S	
	380	25.4 × 35	0.15	2.22	EKHV3H1VSN381MQ35S	840	30 × 50	0.15	3.48	EKHV401VSN841MR50S		
	430	22 × 50	0.15	2.53	EKHV3H1VSN431MP50S	840	35 × 40	0.15	3.10	EKHV401VSN841MA40S		
	450	25.4 × 40	0.15	2.47	EKHV3H1VSN451MQ40S	940	30 × 55	0.15	3.76	EKHV401VSN941MR55S		
	470	30 × 30	0.15	2.37	EKHV3H1VSN471MR30S	980	35 × 45	0.15	3.43	EKHV401VSN981MA45S		
	470	35 × 25	0.15	2.17	EKHV3H1VSN471MA25S	1,040	30 × 60	0.15	4.03	EKHV401VSN1A2MR60S		
	480	22 × 55	0.15	2.72	EKHV3H1VSN481MP55S	1,110	35 × 50	0.15	3.73	EKHV401VSN112MA50S		
	520	25.4 × 45	0.15	2.70	EKHV3H1VSN521MQ45S	1,250	35 × 55	0.15	4.04	EKHV401VSN1C2MA55S		
	530	22 × 60	0.15	2.91	EKHV3H1VSN531MP60S	1,380	35 × 60	0.15	4.32	EKHV401VSN142MA60S		



◆ HIGHER RIPPLE CURRENT RATINGS

WV (V _{dc})	Cap (μF)	Case size φD×L(mm)	tan δ	Rated ripple current (Arms/105°C, 120Hz)	Part No.	WV (V _{dc})	Cap (μF)	Case size φD×L(mm)	tan δ	Rated ripple current (Arms/105°C, 120Hz)	Part No.	
350	350	30 × 25	0.15	2.50	EKHV351VSN351MR25S	375	840	30 × 50	0.15	4.31	EKHV3H1VSN841MR50S	
	460	30 × 30	0.15	2.90	EKHV351VSN461MR30S		870	35 × 40	0.15	4.17	EKHV3H1VSN871MA40S	
	480	35 × 25	0.15	2.90	EKHV351VSN481MA25S		940	30 × 55	0.15	4.65	EKHV3H1VSN941MR55S	
	570	30 × 35	0.15	3.31	EKHV351VSN571MR35S		1,010	35 × 45	0.15	4.61	EKHV3H1VSN102MA45S	
	630	35 × 30	0.15	3.38	EKHV351VSN631MA30S		1,050	30 × 60	0.15	5.01	EKHV3H1VSN1A2MR60S	
	680	30 × 40	0.15	3.72	EKHV351VSN681MR40S		1,150	35 × 50	0.15	5.03	EKHV3H1VSN1B2MA50S	
	780	35 × 35	0.15	3.82	EKHV351VSN781MA35S		1,290	35 × 55	0.15	5.43	EKHV3H1VSN132MA55S	
	790	30 × 45	0.15	4.11	EKHV351VSN791MR45S		1,430	35 × 60	0.15	5.83	EKHV3H1VSN1E2MA60S	
	900	30 × 50	0.15	4.46	EKHV351VSN901MR50S		400	300	30 × 25	0.15	2.32	EKHV401VSN301MR25S
	930	35 × 40	0.15	4.31	EKHV351VSN931MA40S			400	30 × 30	0.15	2.71	EKHV401VSN401MR30S
	1,010	30 × 55	0.15	4.82	EKHV351VSN102MR55S			410	35 × 25	0.15	2.68	EKHV401VSN411MA25S
	1,080	35 × 45	0.15	4.77	EKHV351VSN112MA45S			490	30 × 35	0.15	3.07	EKHV401VSN491MR35S
	1,120	30 × 60	0.15	5.17	EKHV351VSN112MR60S			540	35 × 30	0.15	3.13	EKHV401VSN541MA30S
	1,230	35 × 50	0.15	5.20	EKHV351VSN1C2MA50S			590	30 × 40	0.15	3.46	EKHV401VSN591MR40S
	1,390	35 × 55	0.15	5.64	EKHV351VSN142MA55S			670	35 × 35	0.15	3.54	EKHV401VSN671MA35S
1,540	35 × 60	0.15	6.05	EKHV351VSN1F2MA60S	680	30 × 45		0.15	3.81	EKHV401VSN681MR45S		
375	330	30 × 25	0.15	2.43	EKHV3H1VSN331MR25S	780		30 × 50	0.15	4.15	EKHV401VSN781MR50S	
	430	30 × 30	0.15	2.81	EKHV3H1VSN431MR30S	800		35 × 40	0.15	4.00	EKHV401VSN801MA40S	
	450	35 × 25	0.15	2.81	EKHV3H1VSN451MA25S	870		30 × 55	0.15	4.47	EKHV401VSN871MR55S	
	530	30 × 35	0.15	3.19	EKHV3H1VSN531MR35S	930		35 × 45	0.15	4.43	EKHV401VSN931MA45S	
	590	35 × 30	0.15	3.27	EKHV3H1VSN591MA30S	970		30 × 60	0.15	4.81	EKHV401VSN971MR60S	
	630	30 × 40	0.15	3.58	EKHV3H1VSN631MR40S	1,060		35 × 50	0.15	4.82	EKHV401VSN1A2MA50S	
	730	35 × 35	0.15	3.70	EKHV3H1VSN731MA35S	1,190		35 × 55	0.15	5.22	EKHV401VSN122MA55S	
	740	30 × 45	0.15	3.98	EKHV3H1VSN741MR45S	1,320	35 × 60	0.15	5.60	EKHV401VSN132MA60S		

◆ RATED RIPPLE CURRENT MULTIPLIERS

● Frequency Multipliers

Frequency(Hz)	50	120	300	1k	10k	50k
350 to 450V _{dc}	0.70	1.00	1.10	1.17	1.25	1.31

The deterioration of aluminum electrolytic capacitors accelerates their life due to the internal heating produced by ripple current. For details, refer to Section "5-3 Ripple Current Effect on Lifetime" in the catalog, Technical Note.

KHE Series

- Upgraded capacitance rating
- Endurance with ripple current : 2,000 hours at 105°C
- Rated voltage range : 400 to 450V_{dc}, Capacitance range : 210 to 1,500μF
- Non solvent resistant type
- RoHS2 Compliant

KHE

↓
Downsized
KMZ



◆ SPECIFICATIONS

Items	Characteristics	
Category	-40 to +105°C	
Temperature Range		
Rated Voltage Range	400 to 450V _{dc}	
Capacitance Tolerance	±20% (M) (at 20°C, 120Hz)	
Leakage Current	$I \leq 3\sqrt{CV}$ Where, I : Max. leakage current (μA), C : Nominal capacitance (μF), V : Rated voltage (V) (at 20°C after 5 minutes)	
Dissipation Factor (tan δ)	Rated voltage (V _{dc})	400 to 450V
	tan δ (Max.)	0.20 (at 20°C, 120Hz)
Low Temperature Characteristics (Max. Impedance Ratio)	Rated voltage (V _{dc})	400 to 450V
	Z(-25°C)/Z(+20°C)	8 (at 120Hz)
Endurance	The following specifications shall be satisfied when the capacitors are restored to 20°C after subjected to DC voltage with the rated ripple current is applied (the peak voltage shall not exceed the rated voltage) for 2,000 hours at 105°C.	
	Capacitance change	≤ ±20% of the initial value
	D.F. (tan δ)	≤ 200% of the initial specified value
	Leakage current	≤ The initial specified value
Shelf Life	The following specifications shall be satisfied when the capacitors are restored to 20°C after exposing them for 1,000 hours at 105°C without voltage applied. Before the measurement, the capacitor shall be preconditioned by applying voltage according to Item 4.1 of JIS C 5101-4.	
	Capacitance change	≤ ±15% of the initial value
	D.F. (tan δ)	≤ 150% of the initial specified value
	Leakage current	≤ The initial specified value

◆ DIMENSIONS [mm]

● Terminal Code : VS (φ25.4 to φ35) : Standard

● Terminal Code : LI (φ30, φ35)

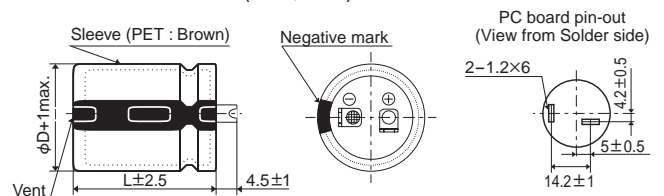
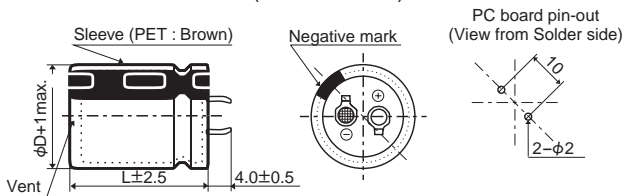

The standard design has no plastic disc.

◆ PART NUMBERING SYSTEM

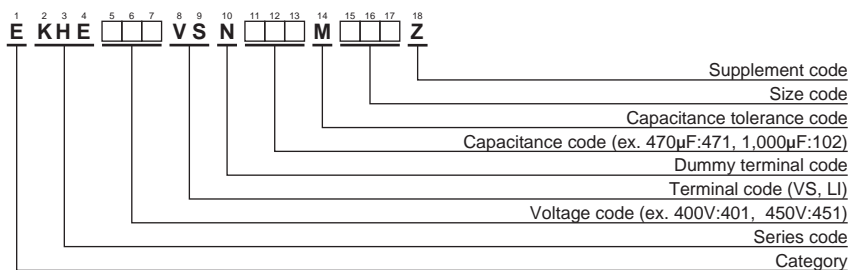

Please refer to "Product code guide (snap-in type)"



KHE Series

◆ **STANDARD RATINGS**

WV (V _{dc})	Cap (μF)	Case size φD×L(mm)	tan δ	Rated ripple current (Arms/105°C, 120Hz)	Part No.	WV (V _{dc})	Cap (μF)	Case size φD×L(mm)	tan δ	Rated ripple current (Arms/105°C, 120Hz)	Part No.	
400	240	25.4 × 25	0.20	1.17	EKHE401VSN241MQ25Z	420	670	30 × 40	0.20	2.15	EKHE421VSN671MR40Z	
	310	25.4 × 30	0.20	1.37	EKHE401VSN311MQ30Z		720	25.4 × 60	0.20	2.42	EKHE421VSN721MQ60Z	
	370	30 × 25	0.20	1.50	EKHE401VSN371MR25Z		730	35 × 35	0.20	2.00	EKHE421VSN731MA35Z	
	390	25.4 × 35	0.20	1.60	EKHE401VSN391MQ35Z		770	30 × 45	0.20	2.36	EKHE421VSN771MR45Z	
	460	25.4 × 40	0.20	1.77	EKHE401VSN461MQ40Z		870	35 × 40	0.20	2.26	EKHE421VSN871MA40Z	
	470	35 × 25	0.20	1.55	EKHE401VSN471MA25Z		880	30 × 50	0.20	2.57	EKHE421VSN881MR50Z	
	480	30 × 30	0.20	1.73	EKHE401VSN481MR30Z		980	30 × 55	0.20	2.76	EKHE421VSN981MR55Z	
	530	25.4 × 45	0.20	1.94	EKHE401VSN531MQ45Z		1,010	35 × 45	0.20	2.49	EKHE421VSN102MA45Z	
	590	30 × 35	0.20	1.96	EKHE401VSN591MR35Z		1,080	30 × 60	0.20	2.96	EKHE421VSN112MR60Z	
	600	25.4 × 50	0.20	2.10	EKHE401VSN601MQ50Z		1,150	35 × 50	0.20	2.71	EKHE421VSN112B2MA50Z	
	620	35 × 30	0.20	1.81	EKHE401VSN621MA30Z		1,290	35 × 55	0.20	2.90	EKHE421VSN132MA55Z	
	680	25.4 × 55	0.20	2.30	EKHE401VSN681MQ55Z		1,430	35 × 60	0.20	3.07	EKHE421VSN1E2MA60Z	
	700	30 × 40	0.20	2.20	EKHE401VSN701MR40Z		450	210	25.4 × 25	0.20	1.10	EKHE451VSN211MQ25Z
	750	25.4 × 60	0.20	2.47	EKHE401VSN751MQ60Z			270	25.4 × 30	0.20	1.28	EKHE451VSN271MQ30Z
	760	35 × 35	0.20	2.04	EKHE401VSN761MA35Z			320	30 × 25	0.20	1.39	EKHE451VSN321MR25Z
	810	30 × 45	0.20	2.42	EKHE401VSN811MR45Z			330	25.4 × 35	0.20	1.48	EKHE451VSN331MQ35Z
	910	35 × 40	0.20	2.31	EKHE401VSN911MA40Z			400	25.4 × 40	0.20	1.65	EKHE451VSN401MQ40Z
	930	30 × 50	0.20	2.64	EKHE401VSN931MR50Z			400	35 × 25	0.20	1.43	EKHE451VSN401MA25Z
	1,030	30 × 55	0.20	2.83	EKHE401VSN1A2MR55Z			410	30 × 30	0.20	1.59	EKHE451VSN411MR30Z
	1,060	35 × 45	0.20	2.55	EKHE401VSN1A2MA45Z			460	25.4 × 45	0.20	1.81	EKHE451VSN461MQ45Z
1,140	30 × 60	0.20	3.04	EKHE401VSN1B2MR60Z	510	30 × 35		0.20	1.82	EKHE451VSN511MR35Z		
1,210	35 × 50	0.20	2.78	EKHE401VSN122MA50Z	520	25.4 × 50		0.20	1.95	EKHE451VSN521MQ50Z		
1,350	35 × 55	0.20	2.97	EKHE401VSN1D2MA55Z	530	35 × 30		0.20	1.67	EKHE451VSN531MA30Z		
1,500	35 × 60	0.20	3.15	EKHE401VSN152MA60Z	580	25.4 × 55		0.20	2.13	EKHE451VSN581MQ55Z		
420	230	25.4 × 25	0.20	1.15	EKHE421VSN231MQ25Z	600		30 × 40	0.20	2.03	EKHE451VSN601MR40Z	
	300	25.4 × 30	0.20	1.35	EKHE421VSN301MQ30Z	640		25.4 × 60	0.20	2.28	EKHE451VSN641MQ60Z	
	350	30 × 25	0.20	1.46	EKHE421VSN351MR25Z	660		35 × 35	0.20	1.90	EKHE451VSN661MA35Z	
	370	25.4 × 35	0.20	1.56	EKHE421VSN371MQ35Z	690		30 × 45	0.20	2.23	EKHE451VSN691MR45Z	
	440	25.4 × 40	0.20	1.74	EKHE421VSN441MQ40Z	780		35 × 40	0.20	2.14	EKHE451VSN781MA40Z	
	440	35 × 25	0.20	1.51	EKHE421VSN441MA25Z	790		30 × 50	0.20	2.43	EKHE451VSN791MR50Z	
	460	30 × 30	0.20	1.68	EKHE421VSN461MR30Z	890		30 × 55	0.20	2.63	EKHE451VSN891MR55Z	
	510	25.4 × 45	0.20	1.90	EKHE421VSN511MQ45Z	910		35 × 45	0.20	2.36	EKHE451VSN911MA45Z	
	560	30 × 35	0.20	1.91	EKHE421VSN561MR35Z	1,000	30 × 60	0.20	2.83	EKHE451VSN102MR60Z		
	570	25.4 × 50	0.20	2.05	EKHE421VSN571MQ50Z	1,040	35 × 50	0.20	2.58	EKHE451VSN1A2MA50Z		
	580	35 × 30	0.20	1.75	EKHE421VSN581MA30Z	1,160	35 × 55	0.20	2.75	EKHE451VSN1B2MA55Z		
	640	25.4 × 55	0.20	2.23	EKHE421VSN641MQ55Z	1,290	35 × 60	0.20	2.92	EKHE451VSN132MA60Z		

◆ **RATED RIPPLE CURRENT MULTIPLIERS**

● Frequency Multipliers

Frequency(Hz)	50	120	300	1k	10k	50k
Multipliers	0.77	1.00	1.10	1.21	1.32	1.33

The deterioration of aluminum electrolytic capacitors accelerates their life due to the internal heating produced by ripple current. For details, refer to Section "5-3 Ripple Current Effect on Lifetime" in the catalog, Technical Note.

KMZ Series

- The lower temperature range of the category temperature range has been expanded.
- Downsized from KMW series
- Endurance with ripple current : 2,000 hours at 105°C
- Rated voltage range : 420 & 450V_{dc}, Capacitance range : 120 to 820μF
- Non solvent resistant type
- RoHS2 Compliant

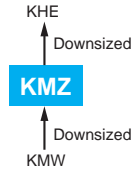

SPECIFICATIONS

Items	Characteristics	
Category Temperature Range	-40 to +105°C	
Rated Voltage Range	420 & 450V _{dc}	
Capacitance Tolerance	±20% (M) (at 20°C, 120Hz)	
Leakage Current	I ≤ 3/CV Where, I : Max. leakage current (μA), C : Nominal capacitance (μF), V : Rated voltage (V) (at 20°C after 5 minutes)	
Dissipation Factor (tan δ)	Rated voltage (V _{dc})	420 & 450V
	tan δ (Max.)	0.20 (at 20°C, 120Hz)
Low Temperature Characteristics (Max. Impedance Ratio)	Rated voltage (V _{dc})	420 & 450V
	Z(-25°C)/Z(+20°C)	8 (at 120Hz)
Endurance	The following specifications shall be satisfied when the capacitors are restored to 20°C after subjected to DC voltage with the rated ripple current is applied (the peak voltage shall not exceed the rated voltage) for 2,000 hours at 105°C.	
	Capacitance change	≤ ±20% of the initial value
	D.F. (tan δ)	≤ 200% of the initial specified value
	Leakage current	≤ The initial specified value
Shelf Life	The following specifications shall be satisfied when the capacitors are restored to 20°C after exposing them for 1,000 hours at 105°C without voltage applied. Before the measurement, the capacitor shall be preconditioned by applying voltage according to Item 4.1 of JIS C 5101-4.	
	Capacitance change	≤ ±15% of the initial value
	D.F. (tan δ)	≤ 150% of the initial specified value
	Leakage current	≤ The initial specified value

DIMENSIONS [mm]

- Terminal Code : VS (φ22 to φ30) : Standard

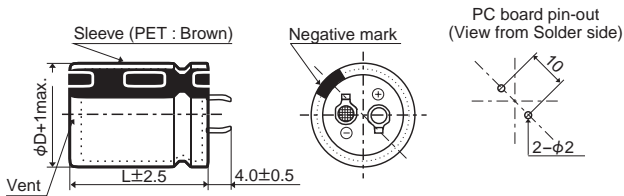

The standard design has no plastic disc.

PART NUMBERING SYSTEM

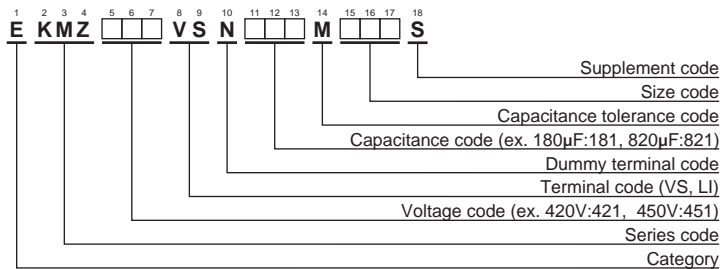

Please refer to "Product code guide (snap-in type)"



KMZ Series

◆STANDARD RATINGS

WV (V _{dc})	Cap (μF)	Case size φD×L(mm)	tan δ	Rated ripple current (Arms/105°C, 120Hz)	Part No.	WV (V _{dc})	Cap (μF)	Case size φD×L(mm)	tan δ	Rated ripple current (Arms/105°C, 120Hz)	Part No.
420	150	22 × 25	0.20	0.87	EKMZ421VSN151MP25S	450	120	22 × 25	0.20	0.78	EKMZ451VSN121MP25S
	180	22 × 30	0.20	1.00	EKMZ421VSN181MP30S		180	22 × 30	0.20	1.00	EKMZ451VSN181MP30S
	180	25.4 × 25	0.20	1.02	EKMZ421VSN181MQ25S		180	25.4 × 25	0.20	1.02	EKMZ451VSN181MQ25S
	220	22 × 35	0.20	1.13	EKMZ421VSN221MP35S		220	22 × 35	0.20	1.13	EKMZ451VSN221MP35S
	270	22 × 40	0.20	1.27	EKMZ421VSN271MP40S		220	25.4 × 30	0.20	1.16	EKMZ451VSN221MQ30S
	270	25.4 × 30	0.20	1.28	EKMZ421VSN271MQ30S		270	22 × 45	0.20	1.30	EKMZ451VSN271MP45S
	270	30 × 25	0.20	1.28	EKMZ421VSN271MR25S		270	25.4 × 35	0.20	1.34	EKMZ451VSN271MQ35S
	330	22 × 45	0.20	1.44	EKMZ421VSN331MP45S		270	30 × 25	0.20	1.28	EKMZ451VSN271MR25S
	330	25.4 × 35	0.20	1.48	EKMZ421VSN331MQ35S		330	22 × 50	0.20	1.47	EKMZ451VSN331MP50S
	390	22 × 55	0.20	1.63	EKMZ421VSN391MP55S		330	25.4 × 40	0.20	1.51	EKMZ451VSN331MQ40S
	390	25.4 × 40	0.20	1.64	EKMZ421VSN391MQ40S		330	30 × 30	0.20	1.43	EKMZ451VSN331MR30S
	390	30 × 30	0.20	1.55	EKMZ421VSN391MR30S		390	22 × 55	0.20	1.63	EKMZ451VSN391MP55S
	470	25.4 × 50	0.20	1.86	EKMZ421VSN471MQ50S		390	25.4 × 45	0.20	1.67	EKMZ451VSN391MQ45S
	470	30 × 35	0.20	1.74	EKMZ421VSN471MR35S		390	30 × 35	0.20	1.59	EKMZ451VSN391MR35S
	560	25.4 × 55	0.20	2.09	EKMZ421VSN561MQ55S		470	25.4 × 55	0.20	1.91	EKMZ451VSN471MQ55S
	560	30 × 40	0.20	1.96	EKMZ421VSN561MR40S		470	30 × 40	0.20	1.79	EKMZ451VSN471MR40S
680	30 × 50	0.20	2.25	EKMZ421VSN681MR50S	560	25.4 × 60	0.20	2.13	EKMZ451VSN561MQ60S		
820	30 × 55	0.20	2.52	EKMZ421VSN821MR55S	560	30 × 45	0.20	2.01	EKMZ451VSN561MR45S		
						680	30 × 50	0.20	2.25	EKMZ451VSN681MR50S	
						820	30 × 60	0.20	2.56	EKMZ451VSN821MR60S	

◆RATED RIPPLE CURRENT MULTIPLIERS

⊙ Frequency Multipliers

Frequency(Hz)	50	120	300	1k	10k	50k
Multipliers	0.77	1.00	1.16	1.30	1.41	1.43

The deterioration of aluminum electrolytic capacitors accelerates their life due to the internal heating produced by ripple current. For details, refer to Section "5-3 Ripple Current Effect on Lifetime" in the catalog, Technical Note.

KMW Series

- Downsized from KMR series
- Endurance with ripple current : 2,000 hours at 105°C
- Rated voltage range : 400 to 450V_{dc}, Capacitance range : 120 to 1,000μF
- Non solvent resistant type
- RoHS2 Compliant

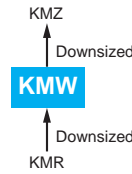

SPECIFICATIONS

Items	Characteristics		
Category	-25 to +105°C		
Temperature Range	-25 to +105°C		
Rated Voltage Range	400 to 450V _{dc}		
Capacitance Tolerance	±20% (M) (at 20°C, 120Hz)		
Leakage Current	I ≤ 3√CV Where, I : Max. leakage current (μA), C : Nominal capacitance (μF), V : Rated voltage (V) (at 20°C after 5 minutes)		
Dissipation Factor (tan δ)	Rated voltage (V _{dc})	400V	420 & 450V
	tan δ (Max.)	0.15	0.20 (at 20°C, 120Hz)
Low Temperature Characteristics (Max. Impedance Ratio)	Rated voltage (V _{dc})	400 to 450V	
	Z(-25°C)/Z(+20°C)	8 (at 120Hz)	
Endurance	The following specifications shall be satisfied when the capacitors are restored to 20°C after subjected to DC voltage with the rated ripple current is applied (the peak voltage shall not exceed the rated voltage) for 2,000 hours at 105°C.		
	Capacitance change	≤ ±20% of the initial value	
	D.F. (tan δ)	≤ 200% of the initial specified value	
	Leakage current	≤ The initial specified value	
Shelf Life	The following specifications shall be satisfied when the capacitors are restored to 20°C after exposing them for 1,000 hours at 105°C without voltage applied. Before the measurement, the capacitor shall be preconditioned by applying voltage according to Item 4.1 of JIS C 5101-4.		
	Capacitance change	≤ ±15% of the initial value	
	D.F. (tan δ)	≤ 150% of the initial specified value	
	Leakage current	≤ The initial specified value	

DIMENSIONS [mm]

● Terminal Code : VS (φ22 to φ35) : Standard

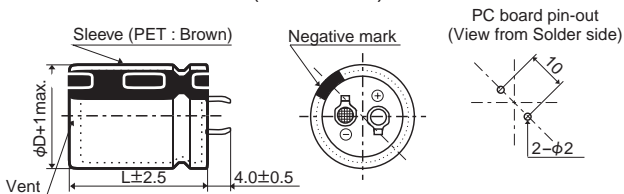

● Terminal Code : LI (φ35)

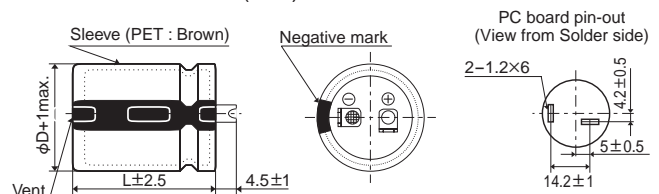

The standard design has no plastic disc.

PART NUMBERING SYSTEM

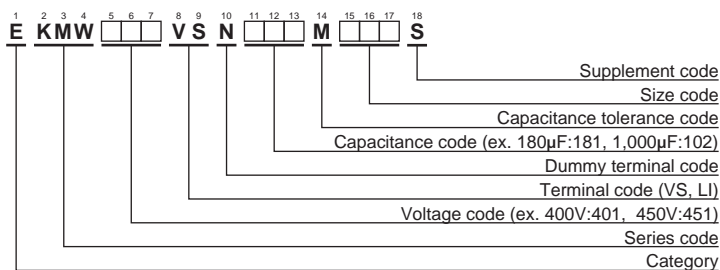

Please refer to "Product code guide (snap-in type)"



KMW Series

◆STANDARD RATINGS

WV (V _{dc})	Cap (μF)	Case size φD×L(mm)	tan δ	Rated ripple current (Arms/105°C, 120Hz)	Part No.	WV (V _{dc})	Cap (μF)	Case size φD×L(mm)	tan δ	Rated ripple current (Arms/105°C, 120Hz)	Part No.
400	150	22 × 25	0.15	0.91	EKMW401VSN151MP25S	420	330	35 × 25	0.20	1.38	EKMW421VSN331MA25S
	180	22 × 30	0.15	1.04	EKMW401VSN181MP30S		390	25.4 × 45	0.20	1.67	EKMW421VSN391MQ45S
	220	22 × 35	0.15	1.18	EKMW401VSN221MP35S		390	25.4 × 50	0.20	1.70	EKMW421VSN391MQ50S
	220	25.4 × 25	0.15	1.15	EKMW401VSN221MQ25S		390	30 × 35	0.20	1.59	EKMW421VSN391MR35S
	270	25.4 × 30	0.15	1.31	EKMW401VSN271MQ30S		470	30 × 40	0.20	1.79	EKMW421VSN471MR40S
	330	22 × 45	0.15	1.50	EKMW401VSN331MP45S		470	35 × 30	0.20	1.67	EKMW421VSN471MA30S
	330	25.4 × 35	0.15	1.51	EKMW401VSN331MQ35S		560	30 × 45	0.20	2.01	EKMW421VSN561MR45S
	330	30 × 25	0.15	1.46	EKMW401VSN331MR25S		560	35 × 35	0.20	1.85	EKMW421VSN561MA35S
	390	22 × 50	0.15	1.67	EKMW401VSN391MP50S		680	35 × 40	0.20	2.11	EKMW421VSN681MA40S
	390	25.4 × 40	0.15	1.67	EKMW401VSN391MQ40S		450	120	22 × 25	0.20	0.78
	390	30 × 30	0.15	1.61	EKMW401VSN391MR30S	150		22 × 30	0.20	0.91	EKMW451VSN151MP30S
	390	35 × 25	0.15	1.40	EKMW401VSN391MA25S	150		25.4 × 25	0.20	0.93	EKMW451VSN151MQ25S
	470	25.4 × 45	0.15	1.87	EKMW401VSN471MQ45S	180		22 × 35	0.20	1.02	EKMW451VSN181MP35S
	470	30 × 35	0.15	1.81	EKMW401VSN471MR35S	180		25.4 × 30	0.20	1.05	EKMW451VSN181MQ30S
	560	30 × 40	0.15	2.03	EKMW401VSN561MR40S	220		22 × 40	0.20	1.15	EKMW451VSN221MP40S
	560	35 × 30	0.15	1.70	EKMW401VSN561MA30S	220		25.4 × 35	0.20	1.21	EKMW451VSN221MQ35S
	680	30 × 45	0.15	2.29	EKMW401VSN681MR45S	220		30 × 25	0.20	1.15	EKMW451VSN221MR25S
	680	30 × 50	0.15	2.33	EKMW401VSN681MR50S	270		22 × 50	0.20	1.36	EKMW451VSN271MP50S
	680	35 × 35	0.15	1.90	EKMW401VSN681MA35S	270		25.4 × 40	0.20	1.36	EKMW451VSN271MQ40S
	820	35 × 40	0.15	2.16	EKMW401VSN821MA40S	270	30 × 30	0.20	1.29	EKMW451VSN271MR30S	
1,000	35 × 50	0.15	2.50	EKMW401VSN102MA50S	330	25.4 × 45	0.20	1.54	EKMW451VSN331MQ45S		
420	120	22 × 25	0.20	0.78	EKMW421VSN121MP25S	330	30 × 35	0.20	1.46	EKMW451VSN331MR35S	
	150	22 × 30	0.20	0.91	EKMW421VSN151MP30S	390	25.4 × 50	0.20	1.70	EKMW451VSN391MQ50S	
	180	25.4 × 25	0.20	1.02	EKMW421VSN181MQ25S	390	30 × 40	0.20	1.63	EKMW451VSN391MR40S	
	220	25.4 × 30	0.20	1.16	EKMW421VSN221MQ30S	390	35 × 30	0.20	1.52	EKMW451VSN391MA30S	
	270	22 × 45	0.20	1.30	EKMW421VSN271MP45S	470	30 × 45	0.20	1.85	EKMW451VSN471MR45S	
	270	25.4 × 35	0.20	1.34	EKMW421VSN271MQ35S	470	35 × 35	0.20	1.77	EKMW451VSN471MA35S	
	270	30 × 25	0.20	1.28	EKMW421VSN271MR25S	560	30 × 50	0.20	2.04	EKMW451VSN561MR50S	
	330	22 × 50	0.20	1.47	EKMW421VSN331MP50S	560	35 × 40	0.20	2.02	EKMW451VSN561MA40S	
	330	25.4 × 40	0.20	1.51	EKMW421VSN331MQ40S	680	35 × 45	0.20	2.16	EKMW451VSN681MA45S	
	330	30 × 30	0.20	1.43	EKMW421VSN331MR30S	820	35 × 50	0.20	2.42	EKMW451VSN821MA50S	

◆RATED RIPPLE CURRENT MULTIPLIERS

● Frequency Multipliers

Frequency(Hz)	50	120	300	1k	10k	50k
400 to 450V _{dc}	0.77	1.00	1.16	1.30	1.41	1.43

The deterioration of aluminum electrolytic capacitors accelerates their life due to the internal heating produced by ripple current. For details, refer to Section "5-3 Ripple Current Effect on Lifetime" in the catalog, Technical Note.

KMR Series

- Downsized 5mm in height from current snap-ins KMQ series
- Max. 50% up ripple current than same case size of KMQ series
- Endurance with ripple current : 2,000 hours at 105°C
- Rated voltage range : 160 to 450V_{dc}, Capacitance range : 100 to 3,300μF
- For inverter control, switching power supplies
- Non solvent resistant type
- RoHS2 Compliant

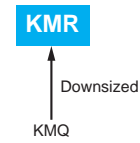

◆ SPECIFICATIONS

Items	Characteristics			
Category	-25 to +105°C			
Temperature Range	-25 to +105°C			
Rated Voltage Range	160 to 450V _{dc}			
Capacitance Tolerance	±20% (M) (at 20°C, 120Hz)			
Leakage Current	I ≤ 3√CV Where, I : Max. leakage current (μA), C : Nominal capacitance (μF), V : Rated voltage (V) (at 20°C after 5 minutes)			
Dissipation Factor (tan δ)	Rated voltage (V _{dc})	160 to 250V	315 to 400V	420 & 450V
	tan δ (Max.)	0.15	0.15	0.20
Low Temperature Characteristics (Max. Impedance Ratio)	Rated voltage (V _{dc})	160 to 250V	315 to 400V	420 & 450V
	Z(-25°C)/Z(+20°C)	4	8	8
Endurance	The following specifications shall be satisfied when the capacitors are restored to 20°C after subjected to DC voltage with the rated ripple current is applied (the peak voltage shall not exceed the rated voltage) for 2,000 hours at 105°C.			
	Capacitance change	≤ ±20% of the initial value		
	D.F. (tan δ)	≤ 200% of the initial specified value		
	Leakage current	≤ The initial specified value		
Shelf Life	The following specifications shall be satisfied when the capacitors are restored to 20°C after exposing them for 1,000 hours at 105°C without voltage applied. Before the measurement, the capacitor shall be preconditioned by applying voltage according to Item 4.1 of JIS C 5101-4.			
	Capacitance change	≤ ±15% of the initial value		
	D.F. (tan δ)	≤ 150% of the initial specified value		
	Leakage current	≤ The initial specified value		

◆ DIMENSIONS [mm]

● Terminal Code : VS (φ22 to φ35) : Standard

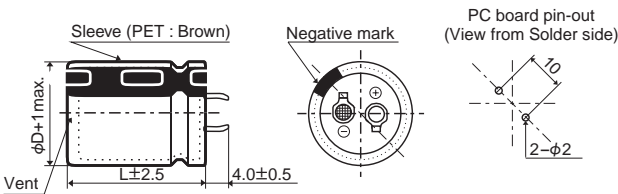

● Terminal Code : LI (φ35)

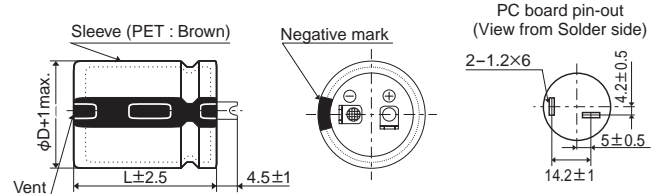

The standard design has no plastic disc.

◆ PART NUMBERING SYSTEM

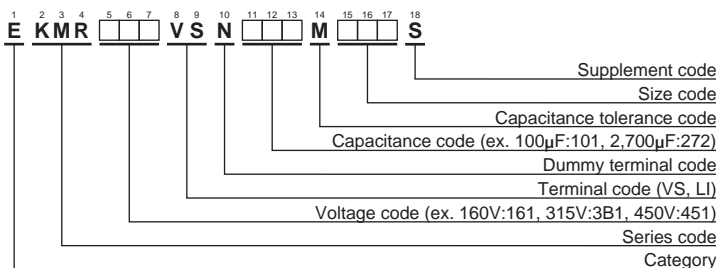

Please refer to "Product code guide (snap-in type)"



◆ STANDARD RATINGS

WV (V _{dc})	Cap (μF)	Case size φD×L(mm)	Rated ripple current (Arms/105°C,120Hz)	Part No.	WV (V _{dc})	Cap (μF)	Case size φD×L(mm)	Rated ripple current (Arms/105°C,120Hz)	Part No.
160	560	22 × 25	1.58	EKMR161VSN561MP25S	250	330	22 × 25	1.21	EKMR251VSN331MP25S
	680	22 × 30	1.83	EKMR161VSN681MP30S		390	22 × 30	1.38	EKMR251VSN391MP30S
	820	22 × 35	2.06	EKMR161VSN821MP35S		470	22 × 35	1.56	EKMR251VSN471MP35S
	820	25.4 × 25	1.89	EKMR161VSN821MQ25S		560	22 × 40	1.74	EKMR251VSN561MP40S
	1,000	22 × 40	2.33	EKMR161VSN102MP40S		560	25.4 × 30	1.61	EKMR251VSN561MQ30S
	1,000	25.4 × 30	2.15	EKMR161VSN102MQ30S		560	30 × 25	1.42	EKMR251VSN561MR25S
	1,000	30 × 25	1.90	EKMR161VSN102MR25S		680	22 × 45	1.97	EKMR251VSN681MP45S
	1,200	22 × 45	2.61	EKMR161VSN122MP45S		680	25.4 × 35	1.85	EKMR251VSN681MQ35S
	1,200	22 × 50	2.69	EKMR161VSN122MP50S		820	25.4 × 40	2.08	EKMR251VSN821MQ40S
	1,200	25.4 × 35	2.45	EKMR161VSN122MQ35S		820	25.4 × 45	2.13	EKMR251VSN821MQ45S
	1,500	25.4 × 40	2.82	EKMR161VSN152MQ40S		820	30 × 30	1.77	EKMR251VSN821MP30S
	1,500	25.4 × 45	2.88	EKMR161VSN152MQ45S		820	35 × 25	1.60	EKMR251VSN821MA25S
	1,500	30 × 30	2.39	EKMR161VSN152MR30S		1,000	25.4 × 50	2.40	EKMR251VSN102MQ50S
	1,500	35 × 25	2.17	EKMR161VSN152MA25S		1,000	30 × 35	2.03	EKMR251VSN102MR35S
	1,800	25.4 × 50	3.22	EKMR161VSN182MQ50S		1,200	30 × 40	2.31	EKMR251VSN122MR40S
	1,800	30 × 35	2.73	EKMR161VSN182MR35S		1,200	30 × 45	2.38	EKMR251VSN122MR45S
	1,800	30 × 40	2.82	EKMR161VSN182MR40S		1,200	35 × 35	2.06	EKMR251VSN122MA35S
	1,800	35 × 30	2.47	EKMR161VSN182MA30S		1,500	30 × 50	2.73	EKMR251VSN152MR50S
	2,200	30 × 45	3.23	EKMR161VSN222MR45S		1,500	35 × 40	2.41	EKMR251VSN152MA40S
	2,200	35 × 35	2.79	EKMR161VSN222MA35S		1,800	35 × 45	2.72	EKMR251VSN182MA45S
2,700	30 × 50	3.66	EKMR161VSN272MR50S	2,200	35 × 50	3.10	EKMR251VSN222MA50S		
2,700	35 × 40	3.23	EKMR161VSN272MA40S	315	180	22 × 25	0.91	EKMR3B1VSN181MP25S	
3,300	35 × 45	3.68	EKMR161VSN332MA45S		220	22 × 30	1.06	EKMR3B1VSN221MP30S	
180	470	22 × 25	1.45		EKMR181VSN471MP25S	270	22 × 35	1.20	EKMR3B1VSN271MP35S
	560	22 × 30	1.66		EKMR181VSN561MP30S	270	25.4 × 25	1.15	EKMR3B1VSN271MQ25S
	680	22 × 35	1.87		EKMR181VSN681MP35S	330	22 × 40	1.37	EKMR3B1VSN331MP40S
	680	25.4 × 25	1.72		EKMR181VSN681MQ25S	330	25.4 × 30	1.30	EKMR3B1VSN331MQ30S
	820	22 × 40	2.11		EKMR181VSN821MP40S	390	22 × 45	1.52	EKMR3B1VSN391MP45S
	820	25.4 × 30	1.94		EKMR181VSN821MQ30S	390	25.4 × 35	1.48	EKMR3B1VSN391MQ35S
	1,000	22 × 45	2.38		EKMR181VSN102MP45S	390	30 × 25	1.39	EKMR3B1VSN391MR25S
	1,000	25.4 × 35	2.24		EKMR181VSN102MQ35S	470	22 × 50	1.72	EKMR3B1VSN471MP50S
	1,000	30 × 25	1.90		EKMR181VSN102MR25S	470	25.4 × 40	1.67	EKMR3B1VSN471MQ40S
	1,200	22 × 50	2.69		EKMR181VSN122MP50S	470	30 × 30	1.57	EKMR3B1VSN471MR30S
	1,200	25.4 × 40	2.52	EKMR181VSN122MQ40S	470	35 × 25	1.52	EKMR3B1VSN471MA25S	
	1,200	30 × 30	2.14	EKMR181VSN122MR30S	560	25.4 × 45	1.86	EKMR3B1VSN561MQ45S	
	1,200	35 × 25	1.94	EKMR181VSN122MA25S	560	30 × 35	1.78	EKMR3B1VSN561MR35S	
	1,500	25.4 × 45	2.88	EKMR181VSN152MQ45S	680	25.4 × 50	2.10	EKMR3B1VSN681MQ50S	
	1,500	25.4 × 50	2.94	EKMR181VSN152MQ50S	680	30 × 40	2.03	EKMR3B1VSN681MR40S	
	1,500	30 × 35	2.49	EKMR181VSN152MR35S	680	35 × 30	1.90	EKMR3B1VSN681MA30S	
1,800	30 × 40	2.82	EKMR181VSN182MR40S	820	30 × 45	2.31	EKMR3B1VSN821MR45S		
1,800	35 × 30	2.47	EKMR181VSN182MA30S	820	35 × 35	2.13	EKMR3B1VSN821MA35S		
2,200	30 × 45	3.23	EKMR181VSN222MR45S	1,000	30 × 50	2.61	EKMR3B1VSN102MR50S		
2,200	30 × 50	3.31	EKMR181VSN222MR50S	1,000	35 × 40	2.46	EKMR3B1VSN102MA40S		
2,200	35 × 35	2.79	EKMR181VSN222MA35S	1,200	35 × 45	2.78	EKMR3B1VSN122MA45S		
2,200	35 × 40	2.92	EKMR181VSN222MA40S	1,200	35 × 50	2.86	EKMR3B1VSN122MA50S		
2,700	35 × 45	3.33	EKMR181VSN272MA45S	350	150	22 × 25	0.84	EKMR351VSN151MP25S	
200	560	22 × 30	1.66		EKMR201VSN561MP30S	220	22 × 30	1.06	EKMR351VSN221MP30S
	560	25.4 × 25	1.56		EKMR201VSN561MQ25S	220	25.4 × 25	1.04	EKMR351VSN221MQ25S
	680	22 × 35	1.87		EKMR201VSN681MP35S	270	22 × 35	1.20	EKMR351VSN271MP35S
	680	25.4 × 30	1.77		EKMR201VSN681MQ30S	270	25.4 × 30	1.18	EKMR351VSN271MQ30S
	820	22 × 40	2.11		EKMR201VSN821MP40S	330	22 × 40	1.37	EKMR351VSN331MP40S
	820	25.4 × 35	2.03		EKMR201VSN821MQ35S	330	22 × 45	1.40	EKMR351VSN331MP45S
	820	30 × 25	1.72		EKMR201VSN821MR25S	330	25.4 × 35	1.36	EKMR351VSN331MQ35S
	1,000	22 × 50	2.45		EKMR201VSN102MP50S	330	30 × 25	1.28	EKMR351VSN331MR25S
	1,000	25.4 × 40	2.30		EKMR201VSN102MQ40S	390	22 × 50	1.56	EKMR351VSN391MP50S
	1,000	30 × 30	1.95		EKMR201VSN102MR30S	390	25.4 × 40	1.52	EKMR351VSN391MQ40S
	1,200	25.4 × 45	2.58		EKMR201VSN122MQ45S	390	30 × 30	1.43	EKMR351VSN391MR30S
	1,200	30 × 35	2.23		EKMR201VSN122MR35S	390	35 × 25	1.38	EKMR351VSN391MA25S
	1,200	35 × 25	1.94		EKMR201VSN122MA25S	470	25.4 × 45	1.71	EKMR351VSN471MQ45S
	1,500	25.4 × 50	2.94		EKMR201VSN152MQ50S	560	25.4 × 50	1.90	EKMR351VSN561MQ50S
	1,500	30 × 40	2.58		EKMR201VSN152MR40S	560	30 × 35	1.78	EKMR351VSN561MR35S
	1,500	35 × 30	2.25		EKMR201VSN152MA30S	560	30 × 40	1.84	EKMR351VSN561MR40S
	1,800	30 × 45	2.92		EKMR201VSN182MR45S	560	35 × 30	1.72	EKMR351VSN561MA30S
	1,800	35 × 35	2.53	EKMR201VSN182MA35S	680	30 × 45	2.10	EKMR351VSN681MR45S	
	2,200	30 × 50	3.31	EKMR201VSN222MR50S	680	35 × 35	1.94	EKMR351VSN681MA35S	
	2,200	35 × 40	2.92	EKMR201VSN222MA40S	820	30 × 50	2.36	EKMR351VSN821MR50S	
2,700	35 × 45	3.33	EKMR201VSN272MA45S						

Product specifications in this catalog are subject to change without notice. Request our product specifications before purchase and/or use. Please use our products based on the information contained in this catalog and product specifications.



◆STANDARD RATINGS

WV (V _{dc})	Cap (μF)	Case size φD×L(mm)	Rated ripple current (Arms/105°C, 120Hz)	Part No.	WV (V _{dc})	Cap (μF)	Case size φD×L(mm)	Rated ripple current (Arms/105°C, 120Hz)	Part No.
350	820	35 × 40	2.23	EKMR351VSN821MA40S	420	270	25.4 × 40	1.32	EKMR421VSN271MQ40S
	1,000	35 × 45	2.54	EKMR351VSN102MA45S		270	30 × 30	1.26	EKMR421VSN271MR30S
	1,200	35 × 50	2.86	EKMR351VSN122MA50S		270	35 × 25	1.26	EKMR421VSN271MA25S
400	120	22 × 25	0.75	EKMR401VSN121MP25S		330	25.4 × 45	1.49	EKMR421VSN331MQ45S
	180	22 × 30	0.96	EKMR401VSN181MP30S		330	30 × 35	1.45	EKMR421VSN331MR35S
	180	25.4 × 25	0.94	EKMR401VSN181MQ25S		390	25.4 × 50	1.66	EKMR421VSN391MQ50S
	220	22 × 35	1.09	EKMR401VSN221MP35S		390	30 × 40	1.63	EKMR421VSN391MR40S
	220	25.4 × 30	1.07	EKMR401VSN221MQ30S		390	35 × 30	1.58	EKMR421VSN391MA30S
	270	22 × 40	1.24	EKMR401VSN271MP40S		470	30 × 45	1.85	EKMR421VSN471MR45S
	270	22 × 45	1.26	EKMR401VSN271MP45S		470	35 × 35	1.77	EKMR421VSN471MA35S
	270	25.4 × 35	1.23	EKMR401VSN271MQ35S		560	30 × 50	2.07	EKMR421VSN561MR50S
	270	30 × 25	1.16	EKMR401VSN271MR25S		560	35 × 40	2.02	EKMR421VSN561MA40S
	330	22 × 50	1.44	EKMR401VSN331MP50S		680	35 × 45	2.29	EKMR421VSN681MA45S
	330	25.4 × 40	1.40	EKMR401VSN331MQ40S		820	35 × 50	2.59	EKMR421VSN821MA50S
	330	30 × 30	1.31	EKMR401VSN331MR30S		450	100	22 × 25	0.71
	330	35 × 25	1.27	EKMR401VSN331MA25S	120		22 × 30	0.82	EKMR451VSN121MP30S
	390	25.4 × 45	1.55	EKMR401VSN391MQ45S	150		22 × 35	0.94	EKMR451VSN151MP35S
	390	30 × 35	1.49	EKMR401VSN391MR35S	150		25.4 × 25	0.89	EKMR451VSN151MQ25S
	470	25.4 × 50	1.74	EKMR401VSN471MQ50S	180		22 × 40	1.05	EKMR451VSN181MP40S
	470	30 × 40	1.69	EKMR401VSN471MR40S	180		25.4 × 30	1.00	EKMR451VSN181MQ30S
	470	35 × 30	1.58	EKMR401VSN471MA30S	220		22 × 45	1.19	EKMR451VSN221MP45S
	560	30 × 45	1.91	EKMR401VSN561MR45S	220		25.4 × 35	1.16	EKMR451VSN221MQ35S
	560	35 × 35	1.76	EKMR401VSN561MA35S	220		30 × 25	1.11	EKMR451VSN221MR25S
	680	30 × 50	2.15	EKMR401VSN681MR50S	270		22 × 50	1.36	EKMR451VSN271MP50S
680	35 × 40	2.03	EKMR401VSN681MA40S	270	25.4 × 40		1.32	EKMR451VSN271MQ40S	
820	35 × 45	2.30	EKMR401VSN821MA45S	270	25.4 × 45		1.35	EKMR451VSN271MQ45S	
820	35 × 50	2.37	EKMR401VSN821MA50S	270	30 × 30		1.26	EKMR451VSN271MR30S	
1,000	35 × 50	2.50	EKMR401VSN102MA50S	270	35 × 25		1.26	EKMR451VSN271MA25S	
420	120	22 × 25	0.78	EKMR421VSN121MP25S	330		25.4 × 50	1.52	EKMR451VSN331MQ50S
	150	22 × 30	0.91	EKMR421VSN151MP30S	330		30 × 35	1.45	EKMR451VSN331MR35S
	150	25.4 × 25	0.89	EKMR421VSN151MQ25S	330		35 × 30	1.45	EKMR451VSN331MA30S
	180	22 × 35	1.03	EKMR421VSN181MP35S	390		30 × 40	1.63	EKMR451VSN391MR40S
	180	25.4 × 30	1.00	EKMR421VSN181MQ30S	470	30 × 45	1.85	EKMR451VSN471MR45S	
	220	22 × 40	1.16	EKMR421VSN221MP40S	470	30 × 50	1.90	EKMR451VSN471MR50S	
	220	22 × 45	1.19	EKMR421VSN221MP45S	470	35 × 35	1.77	EKMR451VSN471MA35S	
	220	25.4 × 35	1.16	EKMR421VSN221MQ35S	560	35 × 40	2.02	EKMR451VSN561MA40S	
	220	30 × 25	1.11	EKMR421VSN221MR25S	560	35 × 45	2.08	EKMR451VSN561MA45S	
	270	22 × 50	1.36	EKMR421VSN271MP50S	680	35 × 50	2.36	EKMR451VSN681MA50S	

◆RATED RIPPLE CURRENT MULTIPLIERS

● Frequency Multipliers

Frequency(Hz)	50	120	300	1k	10k	50k
160 to 250V _{dc}	0.81	1.00	1.17	1.32	1.45	1.50
315 to 450V _{dc}	0.77	1.00	1.16	1.30	1.41	1.43

The deterioration of aluminum electrolytic capacitors accelerates their life due to the internal heating produced by ripple current. For details, refer to Section "5-3 Ripple Current Effect on Lifetime" in the catalog, Technical Note.

KMQ Series

- Endurance with ripple current : 2,000 hours at 105°C
- Non solvent resistant type
- RoHS2 Compliant

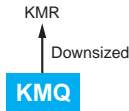

SPECIFICATIONS

Items	Characteristics							
Category	-40 to +105°C (35&50V _{dc}), -25 to +105°C (160 to 450V _{dc})							
Temperature Range								
Rated Voltage Range	35&50V _{dc} , 160 to 450V _{dc}							
Capacitance Tolerance	±20% (M) (at 20°C, 120Hz)							
Leakage Current	I ≤ 3√CV Where, I : Max. leakage current (µA), C : Nominal capacitance (µF), V : Rated voltage (V) (at 20°C after 5 minutes)							
Dissipation Factor (tan δ)	Rated voltage (V _{dc})	35V	50V	160 to 250V	315 to 400V	420 & 450V		
	Nominal capacitance (µF)	10,000>C	C ≥ 10,000	10,000>C	C ≥ 10,000	—	—	—
	tan δ (Max.)	0.30	0.35	0.25	0.30	0.15	0.15	0.20
Low Temperature Characteristics (Max. Impedance Ratio)	Rated voltage (V _{dc})	35&50V	160 to 250V	315 to 450V				
	Z(-25°C)/Z(+20°C)	4	4	8				
	Z(-40°C)/Z(+20°C)	10	—	—				
Endurance	The following specifications shall be satisfied when the capacitors are restored to 20°C after subjected to DC voltage with the rated ripple current is applied (the peak voltage shall not exceed the rated voltage) for 2,000 hours at 105°C.							
	Capacitance change	≤ ±20% of the initial value						
	D.F. (tan δ)	≤ 200% of the initial specified value						
	Leakage current	≤ The initial specified value						
Shelf Life	The following specifications shall be satisfied when the capacitors are restored to 20°C after exposing them for 1,000 hours at 105°C without voltage applied. Before the measurement, the capacitor shall be preconditioned by applying voltage according to Item 4.1 of JIS C 5101-4.							
	Capacitance change	≤ ±15% of the initial value						
	D.F. (tan δ)	≤ 150% of the initial specified value						
	Leakage current	≤ The initial specified value						

DIMENSIONS [mm]

Terminal Code : VS (φ22 to φ35) : Standard

Terminal Code : LI (φ35)

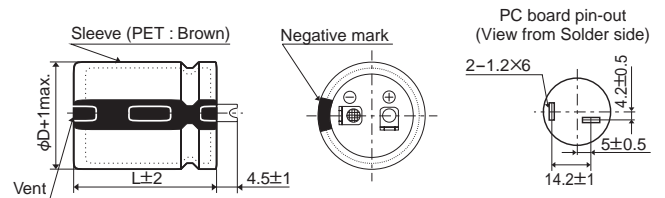
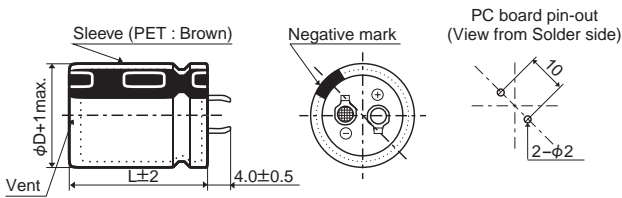

The standard design has no plastic disc.

PART NUMBERING SYSTEM

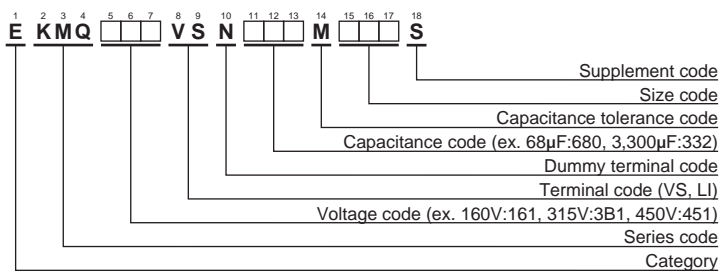

Please refer to "Product code guide (snap-in type)"

◆ STANDARD RATINGS

WV (V _{dc})	Cap (μF)	Case size φD×L(mm)	tan δ	Rated ripple current (Arms/105°C, 120Hz)	Part No.	WV (V _{dc})	Cap (μF)	Case size φD×L(mm)	tan δ	Rated ripple current (Arms/105°C, 120Hz)	Part No.	
35	4,700	22 × 25	0.30	1.87	EKMQ350VSN472MP25S	160	1,800	30 × 40	0.15	2.70	EKMQ161VSN182MR40S	
	5,600	22 × 25	0.30	2.04	EKMQ350VSN562MP25S		1,800	35 × 30	0.15	2.70	EKMQ161VSN182MA30S	
	5,600	25.4 × 25	0.30	2.00	EKMQ350VSN562MQ25S		2,200	30 × 45	0.15	2.90	EKMQ161VSN222MR45S	
	6,800	22 × 30	0.30	2.36	EKMQ350VSN682MP30S		2,200	35 × 35	0.15	2.90	EKMQ161VSN222MA35S	
	6,800	25.4 × 25	0.30	2.21	EKMQ350VSN682MQ25S		2,700	30 × 50	0.15	3.10	EKMQ161VSN272MR50S	
	8,200	22 × 35	0.30	2.65	EKMQ350VSN822MP35S		2,700	35 × 40	0.15	3.10	EKMQ161VSN272MA40S	
	8,200	25.4 × 30	0.30	2.49	EKMQ350VSN822MQ30S		3,300	35 × 50	0.15	3.30	EKMQ161VSN332MA50S	
	8,200	30 × 25	0.30	2.62	EKMQ350VSN822MR25S		180	390	22 × 25	0.15	1.30	EKMQ181VSN391MP25S
	10,000	22 × 40	0.35	3.00	EKMQ350VSN103MP40S			470	22 × 30	0.15	1.40	EKMQ181VSN471MP30S
	10,000	25.4 × 35	0.35	2.88	EKMQ350VSN103MQ35S			560	22 × 30	0.15	1.50	EKMQ181VSN561MP30S
	10,000	30 × 25	0.35	2.90	EKMQ350VSN103MR25S			560	25.4 × 25	0.15	1.50	EKMQ181VSN102MR25S
	12,000	22 × 50	0.35	3.47	EKMQ350VSN123MP50S			680	22 × 35	0.15	1.70	EKMQ181VSN681MP35S
	12,000	25.4 × 35	0.35	3.15	EKMQ350VSN123MQ35S			680	25.4 × 30	0.15	1.70	EKMQ181VSN681MQ30S
	12,000	30 × 30	0.35	3.25	EKMQ350VSN123MR30S			820	22 × 40	0.15	2.00	EKMQ181VSN821MP40S
	12,000	35 × 25	0.35	3.20	EKMQ350VSN123MA25S			820	25.4 × 30	0.15	2.00	EKMQ181VSN102MR30S
	15,000	25.4 × 40	0.35	3.61	EKMQ350VSN153MQ40S			820	30 × 25	0.15	2.00	EKMQ181VSN821MR25S
	15,000	30 × 35	0.35	3.78	EKMQ350VSN153MR35S			1,000	22 × 45	0.15	2.20	EKMQ181VSN102MP45S
	15,000	35 × 25	0.35	3.60	EKMQ350VSN153MA25S			1,000	25.4 × 40	0.15	2.20	EKMQ181VSN102MQ40S
	18,000	25.4 × 50	0.35	4.14	EKMQ350VSN183MQ50S			1,000	30 × 30	0.15	2.20	EKMQ181VSN102MR30S
	18,000	30 × 40	0.35	4.30	EKMQ350VSN183MR40S			1,000	35 × 25	0.15	2.20	EKMQ181VSN102MA25S
18,000	35 × 30	0.35	4.10	EKMQ350VSN183MA30S	1,200	25.4 × 45		0.15	2.30	EKMQ181VSN122MQ45S		
22,000	30 × 50	0.35	5.00	EKMQ350VSN223MR50S	1,200	30 × 35		0.15	2.30	EKMQ181VSN122MR35S		
22,000	35 × 35	0.35	4.64	EKMQ350VSN223MA35S	1,200	35 × 30		0.15	2.30	EKMQ181VSN122MA30S		
27,000	35 × 40	0.35	5.37	EKMQ350VSN273MA40S	1,500	25.4 × 50		0.15	2.50	EKMQ181VSN152MQ50S		
33,000	35 × 50	0.35	6.00	EKMQ350VSN333MA50S	1,500	30 × 40		0.15	2.50	EKMQ181VSN152MR40S		
50	2,700	22 × 25	0.25	1.65	EKMQ500VSN272MP25S	1,500		35 × 30	0.15	2.50	EKMQ181VSN152MA30S	
	3,300	22 × 30	0.25	1.92	EKMQ500VSN332MP30S	1,800		30 × 45	0.15	2.70	EKMQ181VSN182MR45S	
	3,300	25.4 × 25	0.25	1.76	EKMQ500VSN332MQ25S	1,800	35 × 35	0.15	2.70	EKMQ181VSN182MA35S		
	3,900	22 × 30	0.25	2.08	EKMQ500VSN392MP30S	2,200	30 × 50	0.15	2.90	EKMQ181VSN222MR50S		
	3,900	25.4 × 25	0.25	2.04	EKMQ500VSN392MQ25S	2,200	35 × 40	0.15	2.90	EKMQ181VSN222MA40S		
	4,700	22 × 35	0.25	2.43	EKMQ500VSN472MP35S	2,700	35 × 50	0.15	3.10	EKMQ181VSN272MA50S		
	4,700	25.4 × 30	0.25	2.50	EKMQ500VSN472MQ30S	200	390	22 × 25	0.15	1.31	EKMQ201VSN391MP25S	
	4,700	30 × 25	0.25	2.29	EKMQ500VSN472MR25S		470	22 × 30	0.15	1.45	EKMQ201VSN471MP30S	
	5,600	22 × 40	0.25	2.63	EKMQ500VSN562MP40S		560	22 × 30	0.15	1.67	EKMQ201VSN561MP30S	
	5,600	25.4 × 35	0.25	2.61	EKMQ500VSN562MQ35S		560	25.4 × 25	0.15	1.67	EKMQ201VSN561MQ25S	
	5,600	30 × 25	0.25	2.80	EKMQ500VSN562MR25S		680	22 × 40	0.15	1.75	EKMQ201VSN681MP40S	
	6,800	22 × 50	0.25	3.05	EKMQ500VSN682MP50S		680	25.4 × 30	0.15	1.75	EKMQ201VSN681MQ30S	
	6,800	25.4 × 40	0.25	2.94	EKMQ500VSN682MQ40S		820	22 × 45	0.15	2.04	EKMQ201VSN821MP45S	
	6,800	30 × 30	0.25	3.30	EKMQ500VSN682MR30S		820	25.4 × 35	0.15	2.04	EKMQ201VSN821MQ35S	
	6,800	35 × 25	0.25	2.77	EKMQ500VSN682MA25S		820	30 × 25	0.15	2.04	EKMQ201VSN821MR25S	
	8,200	25.4 × 45	0.25	3.60	EKMQ500VSN822MQ45S		1,000	22 × 50	0.15	2.30	EKMQ201VSN102MP50S	
	8,200	30 × 35	0.25	3.60	EKMQ500VSN822MR35S		1,000	25.4 × 45	0.15	2.30	EKMQ201VSN102MQ45S	
	8,200	35 × 30	0.25	3.60	EKMQ500VSN822MA30S		1,000	30 × 30	0.15	2.30	EKMQ201VSN102MR30S	
	10,000	25.4 × 50	0.30	4.00	EKMQ500VSN103MQ50S		1,000	35 × 25	0.15	2.30	EKMQ201VSN102MA25S	
	10,000	30 × 40	0.30	4.00	EKMQ500VSN103MR40S		1,200	25.4 × 50	0.15	2.65	EKMQ201VSN122MQ50S	
10,000	35 × 30	0.30	4.00	EKMQ500VSN103MA30S	1,200		30 × 35	0.15	2.65	EKMQ201VSN122MR35S		
12,000	30 × 50	0.30	4.29	EKMQ500VSN123MR50S	1,200		35 × 30	0.15	2.65	EKMQ201VSN122MA30S		
12,000	35 × 35	0.30	4.37	EKMQ500VSN123MA35S	1,500		30 × 40	0.15	2.80	EKMQ201VSN152MR40S		
15,000	35 × 40	0.30	4.50	EKMQ500VSN153MA40S	1,500		35 × 30	0.15	2.80	EKMQ201VSN152MA30S		
18,000	35 × 50	0.30	5.30	EKMQ500VSN183MA50S	1,800		30 × 45	0.15	3.08	EKMQ201VSN182MR45S		
160	470	22 × 25	0.15	1.40	EKMQ161VSN471MP25S		1,800	35 × 40	0.15	3.08	EKMQ201VSN182MA40S	
	560	22 × 30	0.15	1.50	EKMQ161VSN561MP30S	2,200	35 × 45	0.15	3.48	EKMQ201VSN222MA45S		
	680	22 × 30	0.15	1.70	EKMQ161VSN681MP30S	250	220	22 × 25	0.15	1.00	EKMQ251VSN221MP25S	
	680	25.4 × 25	0.15	1.70	EKMQ161VSN681MQ25S		270	22 × 25	0.15	1.10	EKMQ251VSN271MP25S	
	820	22 × 35	0.15	2.00	EKMQ161VSN821MP35S		330	22 × 30	0.15	1.20	EKMQ251VSN331MP30S	
	820	25.4 × 30	0.15	2.00	EKMQ161VSN821MQ30S		330	25.4 × 25	0.15	1.20	EKMQ251VSN331MQ25S	
	820	30 × 25	0.15	2.00	EKMQ161VSN821MR25S		390	22 × 35	0.15	1.30	EKMQ251VSN391MP35S	
	1,000	22 × 40	0.15	2.20	EKMQ161VSN102MP40S		390	25.4 × 25	0.15	1.30	EKMQ251VSN391MQ25S	
	1,000	25.4 × 35	0.15	2.20	EKMQ161VSN102MQ35S		470	22 × 40	0.15	1.40	EKMQ251VSN471MP40S	
	1,000	30 × 25	0.15	2.20	EKMQ161VSN102MR25S		470	25.4 × 30	0.15	1.40	EKMQ251VSN471MQ30S	
	1,200	25.4 × 40	0.15	2.30	EKMQ161VSN122MQ40S		470	30 × 25	0.15	1.40	EKMQ251VSN471MR25S	
	1,200	30 × 30	0.15	2.30	EKMQ161VSN122MR30S		560	22 × 45	0.15	1.50	EKMQ251VSN561MP45S	
	1,200	35 × 25	0.15	2.30	EKMQ161VSN122MA25S		560	25.4 × 35	0.15	1.50	EKMQ251VSN561MQ35S	
	1,500	25.4 × 45	0.15	2.50	EKMQ161VSN152MQ45S		560	30 × 25	0.15	1.50	EKMQ251VSN561MR25S	
	1,500	30 × 35	0.15	2.50	EKMQ161VSN152MR35S		680	22 × 50	0.15	1.70	EKMQ251VSN681MP50S	
	1,500	35 × 30	0.15	2.50	EKMQ161VSN152MA30S		680	25.4 × 40	0.15	1.70	EKMQ251VSN681MQ40S	
	1,800	25.4 × 50	0.15	2.70	EKMQ161VSN182MQ50S		680	30 × 30	0.15	1.70	EKMQ251VSN681MR30S	

◆ STANDARD RATINGS

WV (V _{dc})	Cap (μF)	Case size φD×L(mm)	tan δ	Rated ripple current (Arms/105°C, 120Hz)	Part No.	WV (V _{dc})	Cap (μF)	Case size φD×L(mm)	tan δ	Rated ripple current (Arms/105°C, 120Hz)	Part No.
250	680	35 × 25	0.15	1.70	EKMQ251VSN681MA25S	400	270	25.4 × 40	0.15	1.22	EKMQ401VSN271MQ40S
	820	25.4 × 45	0.15	2.00	EKMQ251VSN821MQ45S		270	30 × 30	0.15	1.22	EKMQ401VSN271MR30S
	820	30 × 35	0.15	2.00	EKMQ251VSN821MR35S		270	35 × 25	0.15	1.22	EKMQ401VSN271MA25S
	820	35 × 30	0.15	2.00	EKMQ251VSN821MA30S		330	25.4 × 45	0.15	1.44	EKMQ401VSN331MQ45S
	1,000	30 × 40	0.15	2.20	EKMQ251VSN102MR40S		330	30 × 35	0.15	1.44	EKMQ401VSN331MR35S
	1,000	35 × 30	0.15	2.20	EKMQ251VSN102MA30S		330	35 × 30	0.15	1.44	EKMQ401VSN331MA30S
	1,200	30 × 45	0.15	2.30	EKMQ251VSN122MR45S		390	25.4 × 50	0.15	1.55	EKMQ401VSN391MQ50S
	1,200	35 × 35	0.15	2.30	EKMQ251VSN122MA35S		390	30 × 40	0.15	1.55	EKMQ401VSN391MR40S
	1,500	35 × 45	0.15	2.50	EKMQ251VSN152MA45S		390	35 × 30	0.15	1.55	EKMQ401VSN391MA30S
	1,800	35 × 50	0.15	2.70	EKMQ251VSN182MA50S		470	30 × 45	0.15	1.68	EKMQ401VSN471MR45S
315	150	22 × 25	0.15	0.82	EKMQ3B1VSN151MP25S	470	35 × 35	0.15	1.68	EKMQ401VSN471MA35S	
	180	22 × 30	0.15	0.90	EKMQ3B1VSN181MP30S	560	30 × 50	0.15	1.90	EKMQ401VSN561MR50S	
	220	22 × 30	0.15	1.00	EKMQ3B1VSN221MP30S	560	35 × 40	0.15	1.90	EKMQ401VSN561MA40S	
	220	25.4 × 25	0.15	1.00	EKMQ3B1VSN221MQ25S	680	35 × 45	0.15	2.12	EKMQ401VSN681MA45S	
	270	22 × 35	0.15	1.10	EKMQ3B1VSN271MP35S	82	22 × 25	0.20	0.64	EKMQ421VSN820MP25S	
	270	25.4 × 30	0.15	1.10	EKMQ3B1VSN271MQ30S	100	22 × 25	0.20	0.66	EKMQ421VSN101MP25S	
	330	22 × 45	0.15	1.20	EKMQ3B1VSN331MP45S	100	25.4 × 25	0.20	0.66	EKMQ421VSN101MQ25S	
	330	25.4 × 35	0.15	1.20	EKMQ3B1VSN331MQ35S	120	22 × 30	0.20	0.81	EKMQ421VSN121MP30S	
	330	30 × 25	0.15	1.20	EKMQ3B1VSN331MR25S	120	25.4 × 25	0.20	0.81	EKMQ421VSN121MQ25S	
	390	22 × 45	0.15	1.30	EKMQ3B1VSN391MP45S	150	22 × 35	0.20	0.84	EKMQ421VSN151MP35S	
	390	25.4 × 40	0.15	1.30	EKMQ3B1VSN391MQ40S	150	25.4 × 30	0.20	0.84	EKMQ421VSN151MQ30S	
	390	30 × 30	0.15	1.30	EKMQ3B1VSN391MR30S	150	30 × 25	0.20	0.84	EKMQ421VSN151MR25S	
	390	35 × 25	0.15	1.30	EKMQ3B1VSN391MA25S	180	22 × 40	0.20	0.91	EKMQ421VSN181MP40S	
	470	25.4 × 45	0.15	1.40	EKMQ3B1VSN471MQ45S	180	25.4 × 30	0.20	0.91	EKMQ421VSN181MQ30S	
	470	30 × 35	0.15	1.40	EKMQ3B1VSN471MR35S	180	30 × 25	0.20	0.91	EKMQ421VSN181MR25S	
	470	35 × 25	0.15	1.40	EKMQ3B1VSN471MA25S	220	22 × 45	0.20	1.05	EKMQ421VSN221MP45S	
	560	25.4 × 50	0.15	1.50	EKMQ3B1VSN561MQ50S	220	25.4 × 35	0.20	1.05	EKMQ421VSN221MQ35S	
	560	30 × 40	0.15	1.50	EKMQ3B1VSN561MR40S	220	30 × 30	0.20	1.05	EKMQ421VSN221MR30S	
	560	35 × 30	0.15	1.50	EKMQ3B1VSN561MA30S	220	35 × 25	0.20	1.05	EKMQ421VSN221MA25S	
	680	30 × 45	0.15	1.70	EKMQ3B1VSN681MR45S	270	25.4 × 40	0.20	1.25	EKMQ421VSN271MQ40S	
680	35 × 35	0.15	1.70	EKMQ3B1VSN681MA35S	270	30 × 30	0.20	1.25	EKMQ421VSN271MR30S		
820	30 × 50	0.15	2.00	EKMQ3B1VSN821MR50S	270	35 × 25	0.20	1.25	EKMQ421VSN271MA25S		
820	35 × 40	0.15	2.00	EKMQ3B1VSN821MA40S	330	25.4 × 50	0.20	1.42	EKMQ421VSN331MQ50S		
1,000	35 × 45	0.15	2.30	EKMQ3B1VSN102MA45S	330	30 × 35	0.20	1.42	EKMQ421VSN331MR35S		
350	120	22 × 25	0.15	0.75	EKMQ351VSN121MP25S	330	35 × 30	0.20	1.42	EKMQ421VSN331MA30S	
	150	22 × 30	0.15	0.82	EKMQ351VSN151MP30S	390	30 × 40	0.20	1.61	EKMQ421VSN391MR40S	
	180	22 × 30	0.15	0.90	EKMQ351VSN181MP30S	390	35 × 35	0.20	1.61	EKMQ421VSN391MA35S	
	180	25.4 × 25	0.15	0.90	EKMQ351VSN181MQ25S	470	30 × 45	0.20	1.86	EKMQ421VSN471MR45S	
	220	22 × 35	0.15	1.00	EKMQ351VSN221MP35S	470	35 × 40	0.20	1.86	EKMQ421VSN471MA40S	
	220	25.4 × 30	0.15	1.00	EKMQ351VSN221MQ30S	560	35 × 45	0.20	2.10	EKMQ421VSN561MA45S	
	270	22 × 40	0.15	1.10	EKMQ351VSN271MP40S	680	35 × 50	0.20	2.20	EKMQ421VSN681MA50S	
	270	25.4 × 30	0.15	1.10	EKMQ351VSN271MQ30S	68	22 × 25	0.20	0.50	EKMQ451VSN680MP25S	
	270	30 × 25	0.15	1.10	EKMQ351VSN271MR25S	82	22 × 30	0.20	0.56	EKMQ451VSN820MP30S	
	330	22 × 45	0.15	1.20	EKMQ351VSN331MP45S	100	22 × 30	0.20	0.64	EKMQ451VSN101MP30S	
	330	25.4 × 40	0.15	1.20	EKMQ351VSN331MQ40S	100	25.4 × 25	0.20	0.64	EKMQ451VSN101MQ25S	
	330	30 × 30	0.15	1.20	EKMQ351VSN331MR30S	120	22 × 35	0.20	0.72	EKMQ451VSN121MP35S	
	390	25.4 × 45	0.15	1.30	EKMQ351VSN391MQ45S	120	25.4 × 30	0.20	0.72	EKMQ451VSN121MQ30S	
	390	30 × 35	0.15	1.30	EKMQ351VSN391MR35S	150	22 × 40	0.20	0.79	EKMQ451VSN151MP40S	
	470	25.4 × 50	0.15	1.40	EKMQ351VSN471MQ50S	150	25.4 × 30	0.20	0.79	EKMQ451VSN151MQ30S	
	470	30 × 35	0.15	1.40	EKMQ351VSN471MR35S	150	30 × 25	0.20	0.79	EKMQ451VSN151MR25S	
	470	35 × 30	0.15	1.40	EKMQ351VSN471MA30S	180	22 × 45	0.20	0.87	EKMQ451VSN181MP45S	
	560	30 × 45	0.15	1.50	EKMQ351VSN561MR45S	180	25.4 × 40	0.20	0.87	EKMQ451VSN181MQ40S	
	560	35 × 35	0.15	1.50	EKMQ351VSN561MA35S	180	30 × 30	0.20	0.87	EKMQ451VSN181MR30S	
	680	30 × 50	0.15	1.70	EKMQ351VSN681MR50S	220	25.4 × 45	0.20	1.00	EKMQ451VSN221MQ45S	
680	35 × 40	0.15	1.70	EKMQ351VSN681MA40S	220	30 × 30	0.20	1.00	EKMQ451VSN221MR30S		
820	35 × 45	0.15	1.90	EKMQ351VSN821MA45S	220	35 × 25	0.20	1.00	EKMQ451VSN221MA25S		
400	100	22 × 25	0.15	0.70	EKMQ401VSN101MP25S	270	25.4 × 50	0.20	1.19	EKMQ451VSN271MQ50S	
	120	22 × 30	0.15	0.75	EKMQ401VSN121MP30S	270	30 × 40	0.20	1.19	EKMQ451VSN271MR40S	
	150	22 × 30	0.15	0.88	EKMQ401VSN151MP30S	270	35 × 30	0.20	1.19	EKMQ451VSN271MA30S	
	150	25.4 × 25	0.15	0.88	EKMQ401VSN151MQ25S	330	30 × 45	0.20	1.38	EKMQ451VSN331MR45S	
	180	22 × 35	0.15	0.95	EKMQ401VSN181MP35S	330	35 × 35	0.20	1.38	EKMQ451VSN331MA35S	
	180	25.4 × 30	0.15	0.95	EKMQ401VSN181MQ30S	390	30 × 50	0.20	1.55	EKMQ451VSN391MR50S	
	220	22 × 45	0.15	1.10	EKMQ401VSN221MP45S	390	35 × 40	0.20	1.55	EKMQ451VSN391MA40S	
	220	25.4 × 35	0.15	1.10	EKMQ401VSN221MQ35S	470	35 × 45	0.20	1.74	EKMQ451VSN471MA45S	
	220	30 × 25	0.15	1.10	EKMQ401VSN221MR25S	560	35 × 50	0.20	1.90	EKMQ451VSN561MA50S	
	270	22 × 50	0.15	1.22	EKMQ401VSN271MP50S						



KMQ Series

◆ RATED RIPPLE CURRENT MULTIPLIERS

● Frequency Multipliers

Frequency(Hz)	50	120	300	1k	10k	50k
35, 50V _{dc}	0.95	1.00	1.03	1.05	1.08	1.08
160 to 250V _{dc}	0.81	1.00	1.17	1.32	1.45	1.50
315 to 450V _{dc}	0.77	1.00	1.16	1.30	1.41	1.43

The deterioration of aluminum electrolytic capacitors accelerates their life due to the internal heating produced by ripple current. For details, refer to Section "5-3 Ripple Current Effect on Lifetime" in the catalog, Technical Note.

RLB Series

- Endurance with ripple current : 5,000 hours at 85°C
- High ripple current capability in a commercial frequency range
- High ripple current for inverter control like air conditioner
- Rated voltage range : 180 to 250Vdc, Capacitance range : 600 to 2,200μF
- Non solvent resistant type
- RoHS2 Compliant

RLB



SPECIFICATIONS

Items	Characteristics	
Category	-25 to +85°C	
Temperature Range		
Rated Voltage Range	180 to 250V	
Capacitance Tolerance	± 10% (K) (at 20°C, 120Hz)	
Leakage Current	I ≤ 3/CV Where, I : Max. leakage current (μA), C : Nominal capacitance (μF), V : Rated voltage (V) (at 20°C after 5 minutes)	
Dissipation Factor (tan δ)	Rated voltage (V _{dc})	180 to 250V
	tan δ (Max.)	0.15 (at 20°C, 120Hz)
Low Temperature Characteristics (Max. Impedance Ratio)	Rated voltage (V _{dc})	180 to 250V
	Z(-25°C)/Z(+20°C)	4 (at 120Hz)
Endurance	The following specifications shall be satisfied when the capacitors are restored to 20°C after subjected to DC voltage with the rated ripple current is applied (the peak voltage shall not exceed the rated voltage) for 5,000 hours at 85°C.	
	Capacitance change	≤ ±20% of the initial value
	D. F. (tan δ)	≤ 200% of the initial specified value
	Leakage current	≤ The initial specified value
Shelf Life	The following specifications shall be satisfied when the capacitors are restored to 20°C after exposing them for 1,000 hours at 85°C without voltage applied. Before the measurement, the capacitor shall be preconditioned by applying voltage according to Item 4.1 of JIS C 5101-4.	
	Capacitance change	≤ ± 15% of the initial value
	D. F. (tan δ)	≤ 150% of the initial specified value
	Leakage current	≤ The initial specified value

DIMENSIONS [mm]

● Terminal Code : LI (φ30, φ35) : Standard

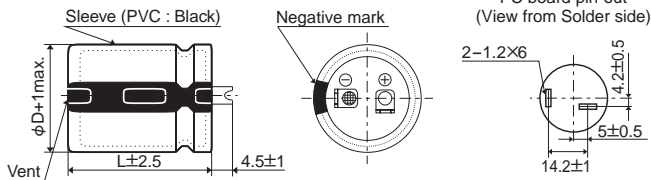

● Terminal Code : VS (φ30, φ35)

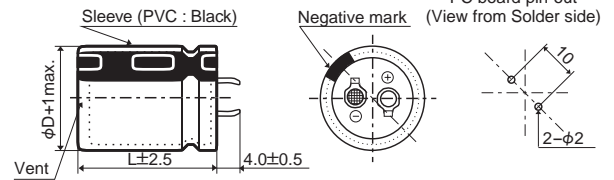

The standard design has no plastic disc.

PART NUMBERING SYSTEM

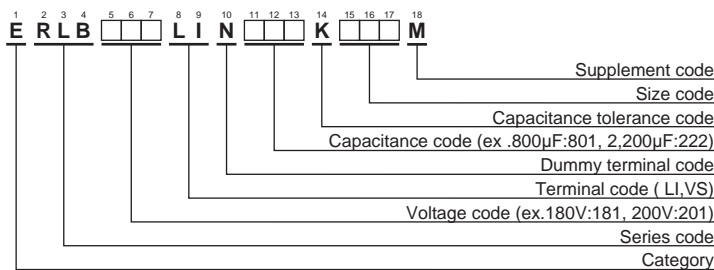

Please refer to "Product code guide (snap-in type)"



RLB Series

◆ STANDARD RATINGS

WV (V _{dc})	Cap (μF)	Case size φD×L(mm)	tan δ	Rated ripple current (Arms/85°C, 120Hz)	Part No.	WV (V _{dc})	Cap (μF)	Case size φD×L(mm)	tan δ	Rated ripple current (Arms/85°C, 120Hz)	Part No.	
180	900	30 × 35	0.15	4.66	ERLB181LIN901KR35M	210	1,400	30 × 55	0.15	6.31	ERLB211LIN142KR55M	
	1,100	30 × 40	0.15	5.17	ERLB181LIN112KR40M		1,500	35 × 45	0.15	6.21	ERLB211LIN152KA45M	
	1,300	30 × 45	0.15	5.64	ERLB181LIN132KR45M		1,700	35 × 50	0.15	6.82	ERLB211LIN172KA50M	
	1,500	30 × 50	0.15	6.07	ERLB181LIN152KR50M		2,000	35 × 55	0.15	7.62	ERLB211LIN202KA55M	
	200	1,500	35 × 40	0.15	5.75	ERLB181LIN152KA40M	220	700	30 × 35	0.15	4.27	ERLB221LIN701KR35M
		1,700	30 × 55	0.15	6.63	ERLB181LIN172KR55M		900	30 × 40	0.15	4.85	ERLB221LIN901KR40M
		1,800	35 × 45	0.15	6.37	ERLB181LIN182KA45M		1,000	30 × 45	0.15	5.19	ERLB221LIN102KR45M
		2,000	35 × 50	0.15	6.84	ERLB181LIN202KA50M		1,000	35 × 35	0.15	4.87	ERLB221LIN102KA35M
210		900	30 × 35	0.15	4.66	ERLB201LIN901KR35M		1,200	30 × 50	0.15	5.68	ERLB221LIN122KR50M
		1,000	30 × 40	0.15	5.01	ERLB201LIN102KR40M		1,200	35 × 40	0.15	5.44	ERLB221LIN122KA40M
		1,200	30 × 45	0.15	5.51	ERLB201LIN122KR45M		1,300	30 × 55	0.15	6.09	ERLB221LIN132KR55M
		1,200	35 × 35	0.15	5.14	ERLB201LIN122KA35M		1,400	35 × 45	0.15	5.96	ERLB221LIN142KA45M
		1,400	30 × 50	0.15	5.95	ERLB201LIN142KR50M	1,600	35 × 50	0.15	6.51	ERLB221LIN162KA50M	
		1,400	35 × 40	0.15	5.66	ERLB201LIN142KA40M	1,800	35 × 55	0.15	7.10	ERLB221LIN182KA55M	
	1,500	30 × 55	0.15	6.36	ERLB201LIN152KR55M	250	600	30 × 35	0.15	4.03	ERLB251LIN601KR35M	
	1,600	35 × 45	0.15	6.14	ERLB201LIN162KA45M		800	30 × 40	0.15	4.66	ERLB251LIN801KR40M	
1,900	35 × 50	0.15	6.82	ERLB201LIN192KA50M	900		30 × 45	0.15	5.01	ERLB251LIN901KR45M		
2,200	35 × 55	0.15	7.60	ERLB201LIN222KA55M	900		35 × 35	0.15	4.73	ERLB251LIN901KA35M		
210	800	30 × 35	0.15	4.48	ERLB211LIN801KR35M		1,000	30 × 50	0.15	5.32	ERLB251LIN102KR50M	
	900	30 × 40	0.15	4.86	ERLB211LIN901KR40M		1,100	35 × 40	0.15	5.33	ERLB251LIN112KA40M	
	1,100	30 × 45	0.15	5.39	ERLB211LIN112KR45M		1,200	30 × 55	0.15	5.96	ERLB251LIN122KR55M	
	1,100	35 × 35	0.15	5.06	ERLB211LIN112KA35M		1,200	35 × 45	0.15	5.68	ERLB251LIN122KA45M	
	1,200	30 × 50	0.15	5.71	ERLB211LIN122KR50M	1,400	35 × 50	0.15	6.25	ERLB251LIN142KA50M		
	1,300	35 × 40	0.15	5.65	ERLB211LIN132KA40M	1,600	35 × 55	0.15	6.87	ERLB251LIN162KA55M		

◆ RATED RIPPLE CURRENT MULTIPLIERS

● Frequency Multipliers

Frequency(Hz)	50	120	300	1k	10k	50k
180 to 250V _{dc}	0.70	1.00	1.17	1.32	1.45	1.50

The deterioration of aluminum electrolytic capacitors accelerates their life due to the internal heating produced by ripple current. For details, refer to Section "5-3 Ripple Current Effect on Lifetime" in the catalog, Technical Note.

RLA Series

- Endurance with ripple current : 3,000 hours at 85°C
- High ripple current capability in a commercial frequency range
- High ripple current for inverter control like air conditioner
- Rated voltage range : 180 to 250Vdc, Capacitance range : 600 to 2,200μF
- Non solvent resistant type
- RoHS2 Compliant

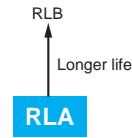

SPECIFICATIONS

Items	Characteristics	
Category	-25 to +85°C	
Temperature Range	-25 to +85°C	
Rated Voltage Range	180 to 250V	
Capacitance Tolerance	± 10% (K) (at 20°C, 120Hz)	
Leakage Current	I ≤ 3/CV Where, I : Max. leakage current (μA), C : Nominal capacitance (μF), V : Rated voltage (V) (at 20°C after 5 minutes)	
Dissipation Factor (tan δ)	Rated voltage (V _{dc})	180 to 250V
	tan δ (Max.)	0.15 (at 20°C, 120Hz)
Low Temperature Characteristics (Max. Impedance Ratio)	Rated voltage (V _{dc})	180 to 250V
	Z(-25°C)/Z(+20°C)	4 (at 120Hz)
Endurance	The following specifications shall be satisfied when the capacitors are restored to 20°C after subjected to DC voltage with the rated ripple current is applied (the peak voltage shall not exceed the rated voltage) for 3,000 hours at 85°C.	
	Capacitance change	≤ ±20% of the initial value
	D. F. (tan δ)	≤ 200% of the initial specified value
	Leakage current	≤ The initial specified value
Shelf Life	The following specifications shall be satisfied when the capacitors are restored to 20°C after exposing them for 1,000 hours at 85°C without voltage applied. Before the measurement, the capacitor shall be preconditioned by applying voltage according to Item 4.1 of JIS C 5101-4.	
	Capacitance change	≤ ± 15% of the initial value
	D. F. (tan δ)	≤ 150% of the initial specified value
	Leakage current	≤ The initial specified value

DIMENSIONS [mm]

● Terminal Code : LI (φ30, φ35) : Standard

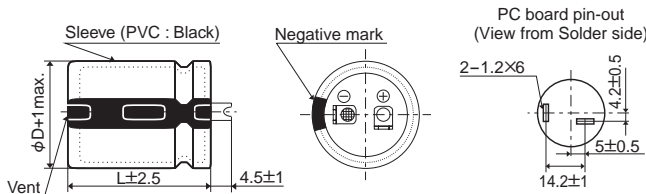

● Terminal Code : VS (φ30, φ35)

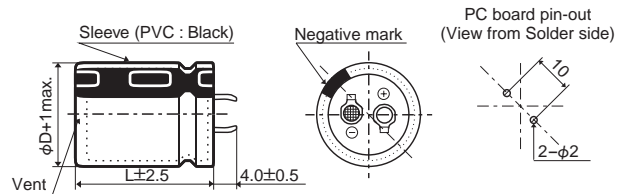

The standard design has no plastic disc.

PART NUMBERING SYSTEM

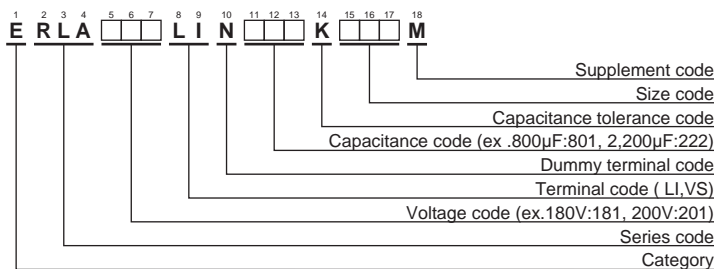

Please refer to "Product code guide (snap-in type)"



◆STANDARD RATINGS

WV (V _{dc})	Cap (μF)	Case size φD×L(mm)	tan δ	Rated ripple current (Arms/ 85°C, 120Hz)	Part No.	WV (V _{dc})	Cap (μF)	Case size φD×L(mm)	tan δ	Rated ripple current (Arms/ 85°C, 120Hz)	Part No.
180	900	30 × 35	0.15	4.66	ERLA181LIN901KR35M	210	1,400	30 × 55	0.15	6.31	ERLA211LIN142KR55M
	1,100	30 × 40	0.15	5.17	ERLA181LIN112KR40M		1,500	35 × 45	0.15	6.21	ERLA211LIN152KA45M
	1,300	30 × 45	0.15	5.64	ERLA181LIN132KR45M		1,700	35 × 50	0.15	6.82	ERLA211LIN172KA50M
	1,500	30 × 50	0.15	6.07	ERLA181LIN152KR50M		2,000	35 × 55	0.15	7.62	ERLA211LIN202KA55M
	1,500	35 × 40	0.15	5.75	ERLA181LIN152KA40M	220	700	30 × 35	0.15	4.27	ERLA221LIN701KR35M
	1,700	30 × 55	0.15	6.63	ERLA181LIN172KR55M		900	30 × 40	0.15	4.85	ERLA221LIN901KR40M
	1,800	35 × 45	0.15	6.37	ERLA181LIN182KA45M		1,000	30 × 45	0.15	5.19	ERLA221LIN102KR45M
	2,000	35 × 50	0.15	6.84	ERLA181LIN202KA50M		1,000	35 × 35	0.15	4.87	ERLA221LIN102KA35M
200	900	30 × 35	0.15	4.66	ERLA201LIN901KR35M		1,200	30 × 50	0.15	5.68	ERLA221LIN122KR50M
	1,000	30 × 40	0.15	5.01	ERLA201LIN102KR40M		1,200	35 × 40	0.15	5.44	ERLA221LIN122KA40M
	1,200	30 × 45	0.15	5.51	ERLA201LIN122KR45M		1,300	30 × 55	0.15	6.09	ERLA221LIN132KR55M
	1,200	35 × 35	0.15	5.14	ERLA201LIN122KA35M		1,400	35 × 45	0.15	5.96	ERLA221LIN142KA45M
	1,400	30 × 50	0.15	5.95	ERLA201LIN142KR50M	1,600	35 × 50	0.15	6.51	ERLA221LIN162KA50M	
	1,400	35 × 40	0.15	5.66	ERLA201LIN142KA40M	1,800	35 × 55	0.15	7.10	ERLA221LIN182KA55M	
	1,500	30 × 55	0.15	6.36	ERLA201LIN152KR55M	250	600	30 × 35	0.15	4.03	ERLA251LIN601KR35M
	1,600	35 × 45	0.15	6.14	ERLA201LIN162KA45M		800	30 × 40	0.15	4.66	ERLA251LIN801KR40M
1,900	35 × 50	0.15	6.82	ERLA201LIN192KA50M	900		30 × 45	0.15	5.01	ERLA251LIN901KR45M	
2,200	35 × 55	0.15	7.60	ERLA201LIN222KA55M	900		35 × 35	0.15	4.73	ERLA251LIN901KA35M	
210	800	30 × 35	0.15	4.48	ERLA211LIN801KR35M		1,000	30 × 50	0.15	5.32	ERLA251LIN102KR50M
	900	30 × 40	0.15	4.86	ERLA211LIN901KR40M		1,100	35 × 40	0.15	5.33	ERLA251LIN112KA40M
	1,100	30 × 45	0.15	5.39	ERLA211LIN112KR45M		1,200	30 × 55	0.15	5.96	ERLA251LIN122KR55M
	1,100	35 × 35	0.15	5.06	ERLA211LIN112KA35M		1,200	35 × 45	0.15	5.68	ERLA251LIN122KA45M
	1,200	30 × 50	0.15	5.71	ERLA211LIN122KR50M	1,400	35 × 50	0.15	6.25	ERLA251LIN142KA50M	
	1,300	35 × 40	0.15	5.65	ERLA211LIN132KA40M	1,600	35 × 55	0.15	6.87	ERLA251LIN162KA55M	

◆RATED RIPPLE CURRENT MULTIPLIERS

●Frequency Multipliers

Frequency(Hz)	50	120	300	1k	10k	50k
180 to 250V _{dc}	0.70	1.00	1.17	1.32	1.45	1.50

The deterioration of aluminum electrolytic capacitors accelerates their life due to the internal heating produced by ripple current. For details, refer to Section "5-3 Ripple Current Effect on Lifetime" in the catalog, Technical Note.

KLA Series

- Endurance with ripple current : 3,000 hours at 105°C
- High ripple current capability in a commercial frequency range
- High ripple current for inverter control like air conditioner
- Rated voltage range : 180 to 250V_{dc}, Capacitance range : 600 to 2,000μF
- Non solvent resistant type
- RoHS2 Compliant

KLA

Higher temperature
RLA



SPECIFICATIONS

Items	Characteristics	
Category	-40 to +105°C	
Temperature Range		
Rated Voltage Range	180 to 250V	
Capacitance Tolerance	± 10% (K) (at 20°C, 120Hz)	
Leakage Current	I ≤ 3/CV Where, I : Max. leakage current (μA), C : Nominal capacitance (μF), V : Rated voltage (V) (at 20°C after 5 minutes)	
Dissipation Factor (tan δ)	Rated voltage (V _{dc})	180 to 250V
	tan δ (Max.)	0.15 (at 20°C, 120Hz)
Low Temperature Characteristics (Max. Impedance Ratio)	Rated voltage (V _{dc})	180 to 250V
	Z(-40°C)/Z(+20°C)	4 (at 120Hz)
Endurance	The following specifications shall be satisfied when the capacitors are restored to 20°C after subjected to DC voltage with the rated ripple current is applied (the peak voltage shall not exceed the rated voltage) for 3,000 hours at 105°C.	
	Capacitance change	≤ ±20% of the initial value
	D. F. (tan δ)	≤ 200% of the initial specified value
	Leakage current	≤ The initial specified value
Shelf Life	The following specifications shall be satisfied when the capacitors are restored to 20°C after exposing them for 1,000 hours at 105°C without voltage applied. Before the measurement, the capacitor shall be preconditioned by applying voltage according to Item 4.1 of JIS C 5101-4.	
	Capacitance change	≤ ± 15% of the initial value
	D. F. (tan δ)	≤ 150% of the initial specified value
	Leakage current	≤ The initial specified value

DIMENSIONS [mm]

Terminal Code : LI (φ30, φ35) : Standard

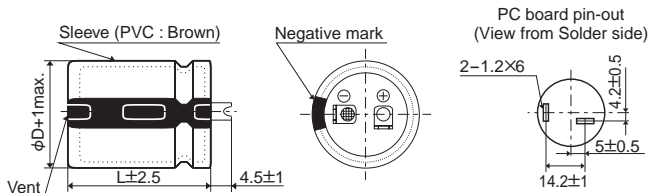

Terminal Code : VS (φ30, φ35)

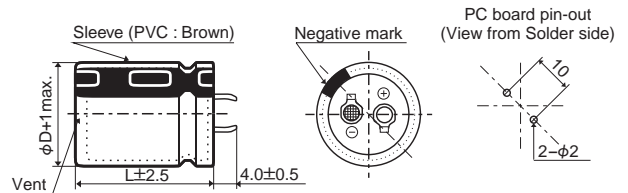

The standard design has no plastic disc.

PART NUMBERING SYSTEM

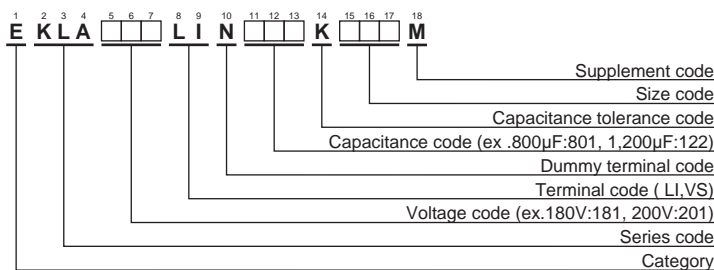

Please refer to "Product code guide (snap-in type)"



◆STANDARD RATINGS

WV (V _{dc})	Cap (μF)	Case size φD×L(mm)	tan δ	Rated ripple current (mA _{rms} /105°C, 120Hz)	Part No.	WV (V _{dc})	Cap (μF)	Case size φD×L(mm)	tan δ	Rated ripple current (mA _{rms} /105°C, 120Hz)	Part No.
180	900	30 × 35	0.15	3.76	EKLA181LIN901KR35M	210	1,400	30 × 54	0.15	5.09	EKLA211LIN142KR54M
	1,100	30 × 39	0.15	4.17	EKLA181LIN112KR39M		1,500	35 × 45	0.15	5.01	EKLA211LIN152KA45M
	1,300	30 × 45	0.15	4.55	EKLA181LIN132KR45M		1,700	35 × 51	0.15	5.50	EKLA211LIN172KA51M
	1,500	30 × 51	0.15	4.89	EKLA181LIN152KR51M		1,900	35 × 54	0.15	5.99	EKLA211LIN192KA54M
	1,500	35 × 39	0.15	4.64	EKLA181LIN152KA39M	220	700	30 × 35	0.15	3.44	EKLA221LIN701KR35M
	1,700	30 × 54	0.15	5.35	EKLA181LIN172KR54M		900	30 × 39	0.15	3.91	EKLA221LIN901KR39M
	1,800	35 × 45	0.15	5.14	EKLA181LIN182KA45M		1,000	30 × 45	0.15	4.18	EKLA221LIN102KR45M
	2,000	35 × 51	0.15	5.51	EKLA181LIN202KA51M		1,000	35 × 35	0.15	3.93	EKLA221LIN102KA35M
200	800	30 × 35	0.15	3.54	EKLA201LIN801KR35M		1,200	30 × 51	0.15	4.58	EKLA221LIN122KR51M
	1,000	30 × 39	0.15	4.04	EKLA201LIN102KR39M		1,200	35 × 39	0.15	4.39	EKLA221LIN122KA39M
	1,100	30 × 45	0.15	4.25	EKLA201LIN112KR45M		1,300	30 × 54	0.15	4.91	EKLA221LIN132KR54M
	1,100	35 × 35	0.15	3.97	EKLA201LIN112KA35M		1,400	35 × 45	0.15	4.81	EKLA221LIN142KA45M
	1,300	30 × 51	0.15	4.62	EKLA201LIN132KR51M	1,600	35 × 51	0.15	5.25	EKLA221LIN162KA51M	
	1,400	35 × 39	0.15	4.56	EKLA201LIN142KA39M	1,900	35 × 54	0.15	5.88	EKLA221LIN192KA54M	
	1,500	30 × 54	0.15	5.13	EKLA201LIN152KR54M	250	600	30 × 35	0.15	3.25	EKLA251LIN601KR35M
	1,600	35 × 45	0.15	4.95	EKLA201LIN162KA45M		700	30 × 39	0.15	3.51	EKLA251LIN701KR39M
1,800	35 × 51	0.15	5.35	EKLA201LIN182KA51M	900		30 × 45	0.15	4.04	EKLA251LIN901KR45M	
2,000	35 × 54	0.15	5.84	EKLA201LIN202KA54M	900		35 × 35	0.15	3.81	EKLA251LIN901KA35M	
210	700	30 × 35	0.15	3.38	EKLA211LIN701KR35M		1,000	30 × 51	0.15	4.29	EKLA251LIN102KR51M
	900	30 × 39	0.15	3.92	EKLA211LIN901KR39M		1,000	35 × 39	0.15	4.10	EKLA251LIN102KA39M
	1,000	35 × 35	0.15	3.89	EKLA211LIN102KA35M		1,100	30 × 54	0.15	4.60	EKLA251LIN112KR54M
	1,100	30 × 45	0.15	4.35	EKLA211LIN112KR45M		1,200	35 × 45	0.15	4.58	EKLA251LIN122KA45M
	1,200	30 × 51	0.15	4.60	EKLA211LIN122KR51M	1,400	35 × 51	0.15	5.04	EKLA251LIN142KA51M	
	1,300	35 × 39	0.15	4.56	EKLA211LIN132KA39M	1,600	35 × 54	0.15	5.54	EKLA251LIN162KA54M	

◆RATED RIPPLE CURRENT MULTIPLIERS

●Frequency Multipliers

Frequency(Hz)	50	120	300	1k	10k	50k
180 to 250V _{dc}	0.70	1.00	1.17	1.32	1.45	1.50

The deterioration of aluminum electrolytic capacitors accelerates their life due to the internal heating produced by ripple current. For details, refer to Section "5-3 Ripple Current Effect on Lifetime" in the catalog, Technical Note.

SMM Series

- Longer life from SMQ series
- Endurance with ripple current : 3,000 hours at 85°C
- Non solvent resistant type
- RoHS2 Compliant

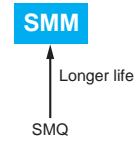

SPECIFICATIONS

Items	Characteristics		
Category	-25 to +85°C		
Temperature Range	-25 to +85°C		
Rated Voltage Range	160 to 450V _{dc}		
Capacitance Tolerance	±20% (M) (at 20°C, 120Hz)		
Leakage Current	I ≤ 3/√CV Where, I : Max. leakage current (µA), C : Nominal capacitance (µF), V : Rated voltage (V) (at 20°C after 5 minutes)		
Dissipation Factor (tan δ)	Rated voltage (V _{dc})	160 to 400V	420 & 450V
	tan δ (Max.)	0.15	0.20
Low Temperature Characteristics (Max. Impedance Ratio)	Rated voltage (V _{dc})	160 to 400V	420 & 450V
	Z(-25°C)/Z(+20°C)	4	8
Endurance	The following specifications shall be satisfied when the capacitors are restored to 20°C after subjected to DC voltage with the rated ripple current is applied (the peak voltage shall not exceed the rated voltage) for 3,000 hours at 85°C.		
	Capacitance change	≤ ±20% of the initial value	
	D.F. (tan δ)	≤ 200% of the initial specified value	
	Leakage current	≤ The initial specified value	
Shelf Life	The following specifications shall be satisfied when the capacitors are restored to 20°C after exposing them for 1,000 hours at 85°C without voltage applied. Before the measurement, the capacitor shall be preconditioned by applying voltage according to Item 4.1 of JIS C 5101-4.		
	Capacitance change	≤ ±15% of the initial value	
	D.F. (tan δ)	≤ 150% of the initial specified value	
	Leakage current	≤ The initial specified value	

DIMENSIONS [mm]

● Terminal Code : VS (φ22 to φ35) : Standard

● Terminal Code : LI (φ35)

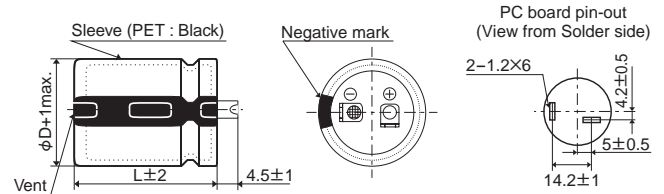
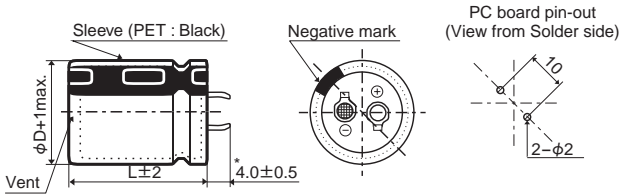

* φD=35mm : 3.5 ± 0.5mm

The standard design has no plastic disc.

PART NUMBERING SYSTEM

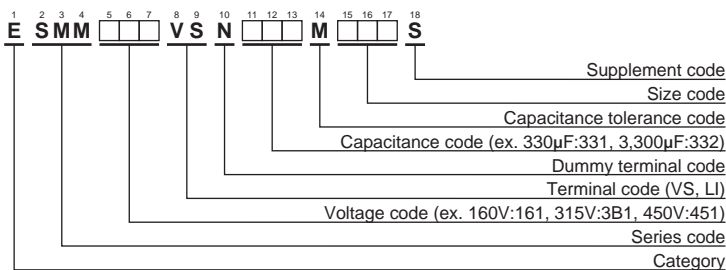

Please refer to "Product code guide (snap-in type)"

RATED RIPPLE CURRENT MULTIPLIERS

● Frequency Multipliers

Frequency(Hz)	50	120	300	1k	10k	50k
160 to 250V _{dc}	0.81	1.00	1.17	1.32	1.45	1.50
315 to 450V _{dc}	0.77	1.00	1.16	1.30	1.41	1.43

The deterioration of aluminum electrolytic capacitors accelerates their life due to the internal heating produced by ripple current. For details, refer to Section "5-3 Ripple Current Effect on Lifetime" in the catalog, Technical Note.

SMM Series

◆ STANDARD RATINGS

WV (V _{dc})	Cap (μF)	Case size φD×L(mm)	tan δ	Rated ripple current (Arms/85°C, 120Hz)	Part No.	WV (V _{dc})	Cap (μF)	Case size φD×L(mm)	tan δ	Rated ripple current (Arms/85°C, 120Hz)	Part No.
160	270	22 × 20	0.15	1.30	ESMM161VSN271MP20S	200	390	22 × 30	0.15	1.73	ESMM201VSN391MP30S
	390	22 × 25	0.15	1.63	ESMM161VSN391MP25S		390	25.4 × 25	0.15	1.71	ESMM201VSN391MQ25S
	390	25.4 × 20	0.15	1.62	ESMM161VSN391MQ20S		390	30 × 20	0.15	1.71	ESMM201VSN391MR20S
	470	22 × 30	0.15	1.86	ESMM161VSN471MP30S		470	22 × 30	0.15	1.97	ESMM201VSN471MP30S
	470	25.4 × 25	0.15	1.86	ESMM161VSN471MQ25S		470	25.4 × 25	0.15	1.95	ESMM201VSN471MQ25S
	560	22 × 30	0.15	2.15	ESMM161VSN561MP30S		470	30 × 20	0.15	1.88	ESMM201VSN471MR20S
	560	25.4 × 25	0.15	2.15	ESMM161VSN561MQ25S		560	22 × 35	0.15	2.18	ESMM201VSN561MP35S
	560	30 × 20	0.15	2.05	ESMM161VSN561MR20S		560	25.4 × 30	0.15	2.15	ESMM201VSN561MQ30S
	680	22 × 35	0.15	2.35	ESMM161VSN681MP35S		560	30 × 25	0.15	2.15	ESMM201VSN561MR25S
	680	25.4 × 30	0.15	2.33	ESMM161VSN681MQ30S		560	35 × 20	0.15	2.05	ESMM201VSN561MA20S
	680	30 × 25	0.15	2.33	ESMM161VSN681MR25S		680	22 × 40	0.15	2.48	ESMM201VSN681MP40S
	680	35 × 20	0.15	2.26	ESMM161VSN681MA20S		680	25.4 × 30	0.15	2.48	ESMM201VSN681MQ30S
	820	22 × 40	0.15	2.68	ESMM161VSN821MP40S		680	30 × 25	0.15	2.48	ESMM201VSN681MR25S
	820	25.4 × 30	0.15	2.65	ESMM161VSN821MQ30S		680	35 × 20	0.15	2.36	ESMM201VSN681MA20S
	820	30 × 25	0.15	2.64	ESMM161VSN821MR25S		820	22 × 45	0.15	2.81	ESMM201VSN821MP45S
	820	35 × 20	0.15	2.49	ESMM161VSN821MA20S		820	25.4 × 35	0.15	2.79	ESMM201VSN821MQ35S
	1,000	22 × 45	0.15	3.02	ESMM161VSN102MP45S		820	30 × 30	0.15	2.80	ESMM201VSN821MR30S
	1,000	25.4 × 35	0.15	3.00	ESMM161VSN102MQ35S		820	35 × 25	0.15	2.83	ESMM201VSN821MA25S
	1,000	30 × 30	0.15	2.96	ESMM161VSN102MR30S		1,000	22 × 50	0.15	3.28	ESMM201VSN102MP50S
	1,000	35 × 25	0.15	3.13	ESMM161VSN102MA25S		1,000	25.4 × 40	0.15	3.28	ESMM201VSN102MQ40S
	1,200	22 × 50	0.15	3.47	ESMM161VSN122MP50S		1,000	30 × 35	0.15	3.15	ESMM201VSN102MR35S
	1,200	25.4 × 40	0.15	3.43	ESMM161VSN122MQ40S		1,000	35 × 30	0.15	3.26	ESMM201VSN102MA30S
	1,200	30 × 30	0.15	3.41	ESMM161VSN122MR30S		1,200	25.4 × 45	0.15	3.61	ESMM201VSN122MQ45S
	1,200	35 × 25	0.15	3.40	ESMM161VSN122MA25S		1,200	30 × 35	0.15	3.61	ESMM201VSN122MR35S
	1,500	25.4 × 50	0.15	3.96	ESMM161VSN152MQ50S		1,200	35 × 30	0.15	3.57	ESMM201VSN122MA30S
	1,500	30 × 35	0.15	3.96	ESMM161VSN152MR35S		1,500	30 × 45	0.15	4.13	ESMM201VSN152MR45S
	1,500	35 × 30	0.15	3.94	ESMM161VSN152MA30S		1,500	35 × 35	0.15	4.06	ESMM201VSN152MA35S
	1,800	30 × 40	0.15	4.31	ESMM161VSN182MR40S		1,800	30 × 50	0.15	4.60	ESMM201VSN182MR50S
	1,800	35 × 35	0.15	4.28	ESMM161VSN182MA35S		1,800	35 × 40	0.15	4.59	ESMM201VSN182MA40S
	2,200	30 × 50	0.15	4.96	ESMM161VSN222MR50S		2,200	35 × 45	0.15	5.25	ESMM201VSN222MA45S
2,200	35 × 40	0.15	4.96	ESMM161VSN222MA40S	180	22 × 20	0.15	1.06	ESMM221VSN181MP20S		
2,700	35 × 45	0.15	5.57	ESMM161VSN272MA45S	270	22 × 25	0.15	1.47	ESMM221VSN271MP25S		
3,300	35 × 50	0.15	6.21	ESMM161VSN332MA50S	270	25.4 × 20	0.15	1.35	ESMM221VSN271MQ20S		
180	220	22 × 20	0.15	1.18	ESMM181VSN221MP20S	330	22 × 30	0.15	1.70	ESMM221VSN331MP30S	
	330	22 × 25	0.15	1.77	ESMM181VSN331MP25S	330	25.4 × 25	0.15	1.69	ESMM221VSN331MQ25S	
	330	25.4 × 20	0.15	1.49	ESMM181VSN331MQ20S	330	30 × 20	0.15	1.58	ESMM221VSN331MR20S	
	390	22 × 25	0.15	1.84	ESMM181VSN391MP25S	390	22 × 30	0.15	1.89	ESMM221VSN391MP30S	
	470	22 × 30	0.15	1.91	ESMM181VSN471MP30S	390	25.4 × 25	0.15	1.84	ESMM221VSN391MQ25S	
	470	25.4 × 25	0.15	2.08	ESMM181VSN471MQ25S	390	30 × 20	0.15	1.71	ESMM221VSN391MR20S	
	470	30 × 20	0.15	1.88	ESMM181VSN471MR20S	470	22 × 35	0.15	2.08	ESMM221VSN471MP35S	
	560	22 × 35	0.15	2.25	ESMM181VSN561MP35S	470	25.4 × 30	0.15	2.08	ESMM221VSN471MQ30S	
	560	25.4 × 25	0.15	2.25	ESMM181VSN561MQ25S	470	30 × 25	0.15	2.12	ESMM221VSN471MR25S	
	680	22 × 35	0.15	2.48	ESMM181VSN681MP35S	470	35 × 20	0.15	1.88	ESMM221VSN471MA20S	
	680	25.4 × 30	0.15	2.50	ESMM181VSN681MQ30S	560	22 × 40	0.15	2.33	ESMM221VSN561MP40S	
	680	30 × 25	0.15	2.46	ESMM181VSN681MR25S	560	25.4 × 35	0.15	2.38	ESMM221VSN561MQ35S	
	680	35 × 20	0.15	2.26	ESMM181VSN681MA20S	560	30 × 25	0.15	2.31	ESMM221VSN561MR25S	
	820	22 × 40	0.15	2.86	ESMM181VSN821MP40S	560	35 × 20	0.15	2.14	ESMM221VSN561MA20S	
	820	25.4 × 35	0.15	2.75	ESMM181VSN821MQ35S	680	22 × 45	0.15	2.63	ESMM221VSN681MP45S	
	820	30 × 25	0.15	2.69	ESMM181VSN821MR25S	680	25.4 × 35	0.15	2.68	ESMM221VSN681MQ35S	
	1,000	22 × 50	0.15	3.10	ESMM181VSN102MP50S	680	30 × 30	0.15	2.62	ESMM221VSN681MR30S	
	1,000	25.4 × 40	0.15	3.06	ESMM181VSN102MQ40S	680	35 × 25	0.15	2.58	ESMM221VSN681MA25S	
	1,000	30 × 30	0.15	3.10	ESMM181VSN102MR30S	820	25.4 × 45	0.15	3.01	ESMM221VSN821MQ45S	
	1,000	35 × 25	0.15	2.98	ESMM181VSN102MA25S	820	30 × 35	0.15	2.99	ESMM221VSN821MR35S	
	1,200	25.4 × 45	0.15	3.63	ESMM181VSN122MQ45S	820	35 × 30	0.15	2.79	ESMM221VSN821MA30S	
	1,200	30 × 35	0.15	3.55	ESMM181VSN122MR35S	1,000	25.4 × 50	0.15	3.40	ESMM221VSN102MQ50S	
	1,200	35 × 30	0.15	3.49	ESMM181VSN122MA30S	1,000	30 × 35	0.15	3.42	ESMM221VSN102MR35S	
	1,500	30 × 40	0.15	4.10	ESMM181VSN152MR40S	1,000	35 × 30	0.15	3.29	ESMM221VSN102MA30S	
1,500	35 × 35	0.15	4.02	ESMM181VSN152MA35S	1,200	30 × 40	0.15	3.88	ESMM221VSN122MR40S		
1,800	30 × 45	0.15	4.55	ESMM181VSN182MR45S	1,200	35 × 35	0.15	3.68	ESMM221VSN122MA35S		
1,800	35 × 35	0.15	4.54	ESMM181VSN182MA35S	1,500	30 × 50	0.15	4.44	ESMM221VSN152MR50S		
2,200	35 × 40	0.15	4.83	ESMM181VSN222MA40S	1,500	35 × 40	0.15	4.10	ESMM221VSN152MA40S		
2,700	35 × 50	0.15	5.30	ESMM181VSN272MA50S	1,800	35 × 45	0.15	4.52	ESMM221VSN182MA45S		
200	220	22 × 20	0.15	1.18	ESMM201VSN221MP20S	150	22 × 20	0.15	0.97	ESMM251VSN151MP20S	
	270	22 × 25	0.15	1.37	ESMM201VSN271MP25S	180	22 × 20	0.15	1.06	ESMM251VSN181MP20S	
	270	25.4 × 20	0.15	1.35	ESMM201VSN271MQ20S	220	22 × 25	0.15	1.24	ESMM251VSN221MP25S	
	330	22 × 25	0.15	1.51	ESMM201VSN331MP25S	220	25.4 × 20	0.15	1.22	ESMM251VSN221MQ20S	
	330	25.4 × 20	0.15	1.49	ESMM201VSN331MQ20S	270	22 × 25	0.15	1.50	ESMM251VSN271MP25S	

SMM Series

◆ STANDARD RATINGS

WV (V _{dc})	Cap (μF)	Case size φD×L(mm)	tan δ	Rated ripple current (Arms/85°C, 120Hz)	Part No.	WV (V _{dc})	Cap (μF)	Case size φD×L(mm)	tan δ	Rated ripple current (Arms/85°C, 120Hz)	Part No.
250	330	22 × 30	0.15	1.66	ESMM251VSN331MP30S	350	180	30 × 20	0.15	1.16	ESMM351VSN181MR20S
	330	25.4 × 25	0.15	1.61	ESMM251VSN331MQ25S		220	22 × 35	0.15	1.47	ESMM351VSN221MP35S
	330	30 × 20	0.15	1.58	ESMM251VSN331MR20S		220	25.4 × 30	0.15	1.53	ESMM351VSN221MQ30S
	390	22 × 35	0.15	1.88	ESMM251VSN391MP35S		220	30 × 25	0.15	1.54	ESMM351VSN221MR25S
	390	25.4 × 30	0.15	1.88	ESMM251VSN391MQ30S		220	35 × 20	0.15	1.29	ESMM351VSN221MA20S
	390	30 × 25	0.15	1.86	ESMM251VSN391MR25S		270	22 × 40	0.15	1.70	ESMM351VSN271MP40S
	390	35 × 20	0.15	1.71	ESMM251VSN391MA20S		270	25.4 × 35	0.15	1.73	ESMM351VSN271MQ35S
	470	22 × 35	0.15	2.15	ESMM251VSN471MP35S		270	30 × 25	0.15	1.80	ESMM351VSN271MR25S
	470	25.4 × 35	0.15	2.15	ESMM251VSN471MQ35S		270	35 × 20	0.15	1.49	ESMM351VSN271MA20S
	470	30 × 25	0.15	2.05	ESMM251VSN471MR25S		330	22 × 45	0.15	1.87	ESMM351VSN331MP45S
	470	35 × 20	0.15	1.88	ESMM251VSN471MA20S		330	25.4 × 35	0.15	1.97	ESMM351VSN331MQ35S
	560	22 × 40	0.15	2.48	ESMM251VSN561MP40S		330	30 × 30	0.15	2.03	ESMM351VSN331MR30S
	560	25.4 × 35	0.15	2.35	ESMM251VSN561MQ35S		330	35 × 25	0.15	1.80	ESMM351VSN331MA25S
	560	30 × 25	0.15	2.35	ESMM251VSN561MR25S		390	25.4 × 40	0.15	2.14	ESMM351VSN391MQ40S
	680	22 × 50	0.15	2.61	ESMM251VSN681MP50S		390	30 × 35	0.15	2.23	ESMM351VSN391MR35S
	680	25.4 × 40	0.15	2.67	ESMM251VSN681MQ40S		390	35 × 30	0.15	2.30	ESMM351VSN391MA30S
	680	30 × 30	0.15	2.71	ESMM251VSN681MR30S		470	25.4 × 50	0.15	2.55	ESMM351VSN471MQ50S
	680	35 × 25	0.15	2.58	ESMM251VSN681MA25S		470	30 × 35	0.15	2.53	ESMM351VSN471MR35S
	820	25.4 × 45	0.15	3.01	ESMM251VSN821MQ45S		470	35 × 30	0.15	2.55	ESMM351VSN471MA30S
	820	30 × 35	0.15	2.98	ESMM251VSN821MR35S		560	30 × 40	0.15	2.73	ESMM351VSN561MR40S
820	35 × 30	0.15	2.96	ESMM251VSN821MA30S	560	35 × 35	0.15	2.75	ESMM351VSN561MA35S		
1,000	30 × 40	0.15	3.56	ESMM251VSN102MR40S	680	30 × 50	0.15	3.15	ESMM351VSN681MR50S		
1,000	35 × 35	0.15	3.48	ESMM251VSN102MA35S	680	35 × 40	0.15	3.15	ESMM351VSN681MA40S		
1,200	30 × 45	0.15	3.99	ESMM251VSN122MR45S	820	35 × 45	0.15	3.47	ESMM351VSN821MA45S		
1,200	35 × 35	0.15	3.84	ESMM251VSN122MA35S	1,000	35 × 50	0.15	3.60	ESMM351VSN102MA50S		
1,500	35 × 40	0.15	4.33	ESMM251VSN152MA40S	400	68	22 × 20	0.15	0.65	ESMM401VSN680MP20S	
1,800	35 × 50	0.15	4.54	ESMM251VSN182MA50S		82	22 × 25	0.15	0.84	ESMM401VSN820MP25S	
315	100	22 × 20	0.15	0.79		ESMM3B1VSN101MP20S	82	25.4 × 20	0.15	0.74	ESMM401VSN820MQ20S
	120	25.4 × 20	0.15	0.90		ESMM3B1VSN121MQ20S	100	22 × 25	0.15	0.99	ESMM401VSN101MP25S
	150	22 × 25	0.15	1.06		ESMM3B1VSN151MP25S	100	25.4 × 20	0.15	0.82	ESMM401VSN101MQ20S
	150	25.4 × 20	0.15	1.00		ESMM3B1VSN151MQ20S	120	22 × 30	0.15	1.09	ESMM401VSN121MP30S
	180	22 × 30	0.15	1.29		ESMM3B1VSN181MP30S	120	25.4 × 25	0.15	1.13	ESMM401VSN121MQ25S
	180	25.4 × 25	0.15	1.38		ESMM3B1VSN181MQ25S	120	30 × 20	0.15	0.95	ESMM401VSN121MR20S
	180	30 × 20	0.15	1.16		ESMM3B1VSN181MR20S	150	22 × 35	0.15	1.24	ESMM401VSN151MP35S
	220	22 × 30	0.15	1.41		ESMM3B1VSN221MP30S	150	25.4 × 30	0.15	1.27	ESMM401VSN151MQ30S
	220	25.4 × 25	0.15	1.47		ESMM3B1VSN221MQ25S	150	30 × 25	0.15	1.20	ESMM401VSN151MR25S
	220	30 × 20	0.15	1.28		ESMM3B1VSN221MR20S	180	22 × 40	0.15	1.41	ESMM401VSN181MP40S
	270	22 × 35	0.15	1.68		ESMM3B1VSN271MP35S	180	25.4 × 30	0.15	1.44	ESMM401VSN181MQ30S
	270	25.4 × 30	0.15	1.70		ESMM3B1VSN271MQ30S	180	30 × 25	0.15	1.52	ESMM401VSN181MR25S
	270	30 × 25	0.15	1.55		ESMM3B1VSN271MR25S	180	35 × 20	0.15	1.16	ESMM401VSN181MA20S
	270	35 × 20	0.15	1.43		ESMM3B1VSN271MA20S	220	22 × 45	0.15	1.58	ESMM401VSN221MP45S
	330	22 × 40	0.15	1.91		ESMM3B1VSN331MP40S	220	25.4 × 35	0.15	1.64	ESMM401VSN221MQ35S
	330	25.4 × 35	0.15	1.94		ESMM3B1VSN331MQ35S	220	30 × 30	0.15	1.66	ESMM401VSN221MR30S
	330	30 × 25	0.15	1.98		ESMM3B1VSN331MR25S	220	35 × 25	0.15	1.47	ESMM401VSN221MA25S
	390	22 × 45	0.15	2.07		ESMM3B1VSN391MP45S	270	22 × 50	0.15	1.65	ESMM401VSN271MP50S
	390	25.4 × 40	0.15	2.11	ESMM3B1VSN391MQ40S	270	25.4 × 40	0.15	1.79	ESMM401VSN271MQ40S	
	390	30 × 30	0.15	2.15	ESMM3B1VSN391MR30S	270	30 × 30	0.15	1.82	ESMM401VSN271MR30S	
390	35 × 25	0.15	1.95	ESMM3B1VSN391MA25S	270	35 × 25	0.15	1.63	ESMM401VSN271MA25S		
470	25.4 × 45	0.15	2.31	ESMM3B1VSN471MQ45S	330	25.4 × 45	0.15	2.00	ESMM401VSN331MQ45S		
470	30 × 35	0.15	2.38	ESMM3B1VSN471MR35S	330	30 × 35	0.15	2.05	ESMM401VSN331MR35S		
470	35 × 30	0.15	2.46	ESMM3B1VSN471MA30S	330	35 × 30	0.15	2.05	ESMM401VSN331MA30S		
560	25.4 × 50	0.15	2.46	ESMM3B1VSN561MQ50S	390	25.4 × 50	0.15	2.12	ESMM401VSN391MQ50S		
560	30 × 35	0.15	2.63	ESMM3B1VSN561MR35S	390	30 × 40	0.15	2.26	ESMM401VSN391MR40S		
560	35 × 30	0.15	2.69	ESMM3B1VSN561MA30S	390	35 × 35	0.15	2.28	ESMM401VSN391MA35S		
680	30 × 45	0.15	2.82	ESMM3B1VSN681MR45S	470	30 × 45	0.15	2.51	ESMM401VSN471MR45S		
680	35 × 35	0.15	3.05	ESMM3B1VSN681MA35S	470	35 × 35	0.15	2.54	ESMM401VSN471MQ35S		
820	30 × 50	0.15	3.28	ESMM3B1VSN821MR50S	560	30 × 50	0.15	2.85	ESMM401VSN561MR50S		
820	35 × 40	0.15	3.45	ESMM3B1VSN821MA40S	560	35 × 40	0.15	2.85	ESMM401VSN561MA40S		
1,000	35 × 45	0.15	3.59	ESMM3B1VSN102MA45S	680	35 × 50	0.15	3.10	ESMM401VSN681MA50S		
350	82	22 × 20	0.15	0.72	ESMM351VSN820MP20S	420	47	22 × 20	0.20	0.54	ESMM421VSN820MP20S
	120	22 × 25	0.15	1.04	ESMM351VSN121MP25S		56	22 × 20	0.20	0.59	ESMM421VSN560MP20S
	120	25.4 × 20	0.15	0.90	ESMM351VSN121MQ20S		68	25.4 × 20	0.20	0.68	ESMM421VSN680MQ20S
	150	22 × 30	0.15	1.20	ESMM351VSN151MP30S		82	22 × 25	0.20	0.85	ESMM421VSN820MP25S
	150	25.4 × 25	0.15	1.22	ESMM351VSN151MQ25S		82	25.4 × 20	0.20	0.74	ESMM421VSN820MQ20S
	150	30 × 20	0.15	1.06	ESMM351VSN151MR20S		100	22 × 30	0.20	0.97	ESMM421VSN101MP30S
	180	22 × 30	0.15	1.34	ESMM351VSN181MP30S		100	25.4 × 25	0.20	0.98	ESMM421VSN101MQ25S
	180	25.4 × 25	0.15	1.37	ESMM351VSN181MQ25S		100	30 × 20	0.20	0.87	ESMM421VSN101MR20S

SMM Series

◆STANDARD RATINGS

WV (V _{dc})	Cap (μF)	Case size φD×L(mm)	tan δ	Rated ripple current (Arms/85°C, 120Hz)	Part No.	WV (V _{dc})	Cap (μF)	Case size φD×L(mm)	tan δ	Rated ripple current (Arms/85°C, 120Hz)	Part No.
420	120	22 × 30	0.20	1.07	ESMM421VSN121MP30S	450	82	25.4 × 20	0.20	0.74	ESMM451VSN820MQ20S
	120	25.4 × 25	0.20	1.08	ESMM421VSN121MQ25S		82	30 × 20	0.20	0.79	ESMM451VSN820MR20S
	120	30 × 20	0.20	0.95	ESMM421VSN121MR20S		100	22 × 30	0.20	0.95	ESMM451VSN101MP30S
	150	22 × 35	0.20	1.21	ESMM421VSN151MP35S		100	25.4 × 25	0.20	0.97	ESMM451VSN101MQ25S
	150	25.4 × 30	0.20	1.26	ESMM421VSN151MQ30S		100	30 × 20	0.20	0.87	ESMM451VSN101MR20S
	150	30 × 25	0.20	1.30	ESMM421VSN151MR25S		120	22 × 35	0.20	1.07	ESMM451VSN121MP35S
	150	35 × 20	0.20	1.11	ESMM421VSN151MA20S		120	25.4 × 30	0.20	1.09	ESMM451VSN121MQ30S
	180	22 × 40	0.20	1.33	ESMM421VSN181MP40S		120	30 × 25	0.20	1.12	ESMM451VSN121MR25S
	180	25.4 × 35	0.20	1.42	ESMM421VSN181MQ35S		120	35 × 20	0.20	0.99	ESMM451VSN121MA20S
	180	30 × 25	0.20	1.48	ESMM421VSN181MR25S		150	22 × 40	0.20	1.18	ESMM451VSN151MP40S
	180	35 × 20	0.20	1.16	ESMM421VSN181MA20S		150	25.4 × 30	0.20	1.25	ESMM451VSN151MQ30S
	220	22 × 45	0.20	1.55	ESMM421VSN221MP45S		150	30 × 25	0.20	1.29	ESMM451VSN151MR25S
	220	25.4 × 35	0.20	1.58	ESMM421VSN221MQ35S		150	35 × 20	0.20	1.06	ESMM451VSN151MA20S
	220	30 × 30	0.20	1.65	ESMM421VSN221MR30S		180	22 × 45	0.20	1.32	ESMM451VSN181MP45S
	220	35 × 25	0.20	1.47	ESMM421VSN221MA25S		180	25.4 × 35	0.20	1.40	ESMM451VSN181MQ35S
	270	25.4 × 40	0.20	1.74	ESMM421VSN271MQ40S		180	30 × 30	0.20	1.45	ESMM451VSN181MR30S
	270	30 × 35	0.20	1.90	ESMM421VSN271MR35S		180	35 × 25	0.20	1.33	ESMM451VSN181MA25S
	270	35 × 30	0.20	1.94	ESMM421VSN271MA30S		220	22 × 50	0.20	1.48	ESMM451VSN221MP50S
	330	25.4 × 50	0.20	2.20	ESMM421VSN331MQ50S		220	25.4 × 40	0.20	1.59	ESMM451VSN221MQ40S
	330	30 × 35	0.20	1.98	ESMM421VSN331MR35S		220	30 × 30	0.20	1.64	ESMM451VSN221MR30S
	330	35 × 35	0.20	2.17	ESMM421VSN331MA35S		220	35 × 25	0.20	1.66	ESMM451VSN221MA25S
	390	30 × 40	0.20	2.22	ESMM421VSN391MR40S		270	25.4 × 45	0.20	1.73	ESMM451VSN271MQ45S
	390	35 × 35	0.20	2.27	ESMM421VSN391MA35S		270	30 × 35	0.20	1.89	ESMM451VSN271MR35S
	470	30 × 45	0.20	2.50	ESMM421VSN471MR45S		270	35 × 30	0.20	1.90	ESMM451VSN271MA30S
470	35 × 40	0.20	2.61	ESMM421VSN471MA40S	330		25.4 × 50	0.20	2.12	ESMM451VSN331MQ50S	
560	35 × 45	0.20	2.95	ESMM421VSN561MA45S	330		30 × 40	0.20	2.12	ESMM451VSN331MR40S	
680	35 × 50	0.20	3.15	ESMM421VSN681MA50S	330		35 × 35	0.20	2.15	ESMM451VSN331MA35S	
450	47	22 × 20	0.20	0.54	ESMM451VSN470MP20S		390	30 × 45	0.20	2.35	ESMM451VSN391MR45S
	56	22 × 20	0.20	0.59	ESMM451VSN560MP20S		390	35 × 40	0.20	2.38	ESMM451VSN391MA40S
	68	22 × 25	0.20	0.71	ESMM451VSN680MP25S		470	30 × 50	0.20	2.65	ESMM451VSN471MR50S
	68	25.4 × 20	0.20	0.68	ESMM451VSN680MQ20S		470	35 × 45	0.20	2.68	ESMM451VSN471MA45S
	82	22 × 25	0.20	0.86	ESMM451VSN820MP25S		560	35 × 50	0.20	2.88	ESMM451VSN561MA50S

KRB Series

- Higher ripple current on high frequency band
- Endurance with high frequency ripple current : 3,000 hours at 105°C
- Rated voltage range : 400 to 450V_{dc}, Capacitance range : 90 to 340μF
- Ideal for high frequency drive power conversion system applications such as solar power conditioners
- Non solvent resistant type
- RoHS2 Compliant



SPECIFICATIONS

Items	Characteristics		
Category	-40 to +105°C		
Temperature Range	-40 to +105°C		
Rated Voltage Range	400 to 450V _{dc}		
Capacitance Tolerance	±20% (M) (at 20°C, 120Hz)		
Leakage Current	I ≤ 3/CV Where, I : Max. leakage current (μA), C : Nominal capacitance (μF), V : Rated voltage (V) (at 20°C after 5 minutes)		
Dissipation Factor (tan δ)	Rated voltage (V _{dc})	400V	420 & 450V
	tan δ (Max.)	0.15	0.20
Low Temperature Characteristics (Max. Impedance Ratio)	Rated voltage (V _{dc})	400V	420 & 450V
	Z(-25°C)/Z(+20°C)	3	8
	Z(-40°C)/Z(+20°C)	12	14
Endurance	The following specifications shall be satisfied when the capacitors are restored to 20°C after subjected to DC voltage with the rated ripple current is applied (the peak voltage shall not exceed the rated voltage) for 3,000 hours at 105°C.		
Shelf Life	Capacitance change	≤ ±20% of the initial value	
	D.F. (tan δ)	≤ 200% of the initial specified value	
	Leakage current	≤ The initial specified value	
Shelf Life	Capacitance change	≤ ±15% of the initial value	
	D.F. (tan δ)	≤ 150% of the initial specified value	
	Leakage current	≤ The initial specified value	

DIMENSIONS [mm]

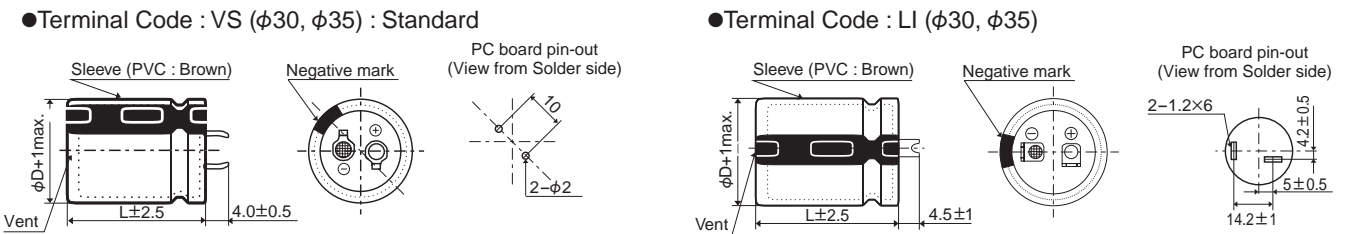

The standard design has no plastic disc.

PART NUMBERING SYSTEM

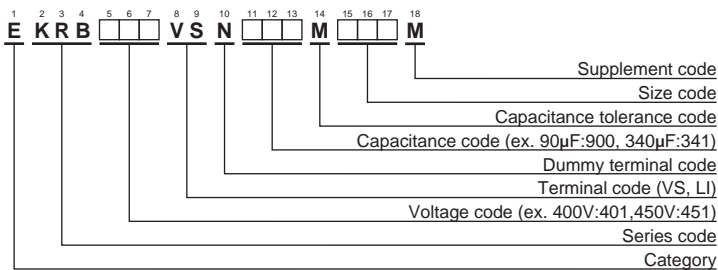

Please refer to "Product code guide (snap-in type)"



KRB Series

◆ STANDARD RATINGS

WV (V _{dc})	Cap (μF)	Case size φD×L(mm)	tan δ	Rated ripple current (Arms/105°C, 100kHz)	Part No.	WV (V _{dc})	Cap (μF)	Case size φD×L(mm)	tan δ	Rated ripple current (Arms/105°C, 100kHz)	Part No.
400	120	30 × 35	0.15	5.54	EKRB401VSN121MR35M	450	90	30 × 35	0.20	4.58	EKRB451VSN900MR35M
	150	30 × 41	0.15	5.69	EKRB401VSN151MR41M		110	30 × 41	0.20	4.91	EKRB451VSN111MR41M
	170	30 × 46	0.15	5.83	EKRB401VSN171MR46M		120	35 × 35	0.20	5.23	EKRB451VSN121MA35M
	170	35 × 35	0.15	5.87	EKRB401VSN171MA35M		130	30 × 46	0.20	5.15	EKRB451VSN131MR46M
	200	30 × 51	0.15	5.97	EKRB401VSN201MR51M		150	30 × 51	0.20	5.39	EKRB451VSN151MR51M
	210	35 × 41	0.15	6.10	EKRB401VSN211MA41M		160	30 × 54	0.20	5.54	EKRB451VSN161MR54M
	220	30 × 54	0.15	6.06	EKRB401VSN221MR54M		160	35 × 41	0.20	5.63	EKRB451VSN161MA41M
	240	30 × 59	0.15	6.20	EKRB401VSN241MR59M		180	30 × 59	0.20	5.78	EKRB451VSN181MR59M
	240	35 × 46	0.15	6.30	EKRB401VSN241MA46M		180	35 × 46	0.20	5.95	EKRB451VSN181MA46M
	280	35 × 51	0.15	6.45	EKRB401VSN281MA51M		210	35 × 51	0.20	6.28	EKRB451VSN211MA51M
	300	35 × 54	0.15	6.60	EKRB401VSN301MA54M		220	35 × 54	0.20	6.47	EKRB451VSN221MA54M
	340	35 × 59	0.15	6.85	EKRB401VSN341MA59M		250	35 × 59	0.20	6.72	EKRB451VSN251MA59M
420	100	30 × 35	0.20	4.58	EKRB421VSN101MR35M						
	130	30 × 41	0.20	4.91	EKRB421VSN131MR41M						
	140	30 × 46	0.20	5.15	EKRB421VSN141MR46M						
	140	35 × 35	0.20	5.23	EKRB421VSN141MA35M						
	170	30 × 51	0.20	5.39	EKRB421VSN171MR51M						
	180	30 × 54	0.20	5.54	EKRB421VSN181MR54M						
	180	35 × 41	0.20	5.63	EKRB421VSN181MA41M						
	200	30 × 59	0.20	5.78	EKRB421VSN201MR59M						
	210	35 × 46	0.20	5.95	EKRB421VSN211MA46M						
	240	35 × 51	0.20	6.28	EKRB421VSN241MA51M						
	260	35 × 54	0.20	6.47	EKRB421VSN261MA54M						
	290	35 × 59	0.20	6.72	EKRB421VSN291MA59M						

◆ RATED RIPPLE CURRENT MULTIPLIERS

● Frequency Multipliers

Frequency(Hz)	50	120	300	1k	10k	50k	100k
400 to 450V	0.22	0.33	0.49	0.73	1.00	1.00	1.00

The deterioration of aluminum electrolytic capacitors accelerates their life due to the internal heating produced by ripple current. For details, refer to Section "5-3 Ripple Current Effect on Lifetime" in the catalog, Technical Note.

KHJ Series

- Higher ripple current from KMT series
- Endurance with ripple current : 3,000 hours at 105°C
- Rated voltage range : 400 to 450V_{dc}, Capacitance range : 240 to 820μF
- For inverter control, switching power supplies
- Non solvent resistant type
- RoHS2 Compliant

KHJ

Higher ripple
KMT



SPECIFICATIONS

Items	Characteristics		
Category	-40 to +105°C		
Temperature Range	-40 to +105°C		
Rated Voltage Range	400 to 450V _{dc}		
Capacitance Tolerance	±20% (M) (at 20°C, 120Hz)		
Leakage Current	I ≤ 3/CV Where, I : Max. leakage current (μA), C : Nominal capacitance (μF), V : Rated voltage (V) (at 20°C after 5 minutes)		
Dissipation Factor (tan δ)	Rated voltage (V _{dc})	400V	420 & 450V
	tan δ (Max.)	0.15	0.20
Low Temperature Characteristics (Max. Impedance Ratio)	Rated voltage (V _{dc})	400V	420 & 450V
	Z(-25°C)/Z(+20°C)	3	8
	Z(-40°C)/Z(+20°C)	12	14
Endurance	The following specifications shall be satisfied when the capacitors are restored to 20°C after subjected to DC voltage with the rated ripple current is applied (the peak voltage shall not exceed the rated voltage) for 3,000 hours at 105°C.		
Shelf Life	Capacitance change	≤ ±20% of the initial value	
	D.F. (tan δ)	≤ 200% of the initial specified value	
	Leakage current	≤ The initial specified value	
Shelf Life	Capacitance change	≤ ±15% of the initial value	
	D.F. (tan δ)	≤ 150% of the initial specified value	
	Leakage current	≤ The initial specified value	

DIMENSIONS [mm]

Terminal Code : VS (φ30, φ35) : Standard

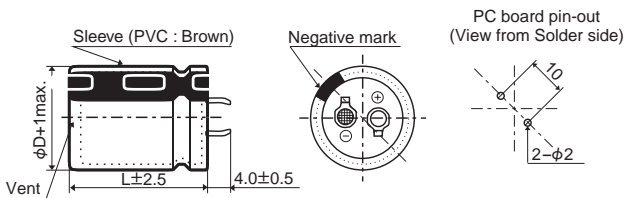

Terminal Code : LI (φ30, φ35)

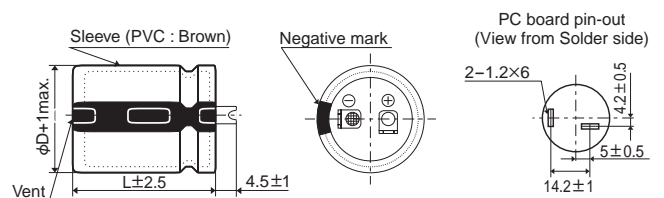

The standard design has no plastic disc.

PART NUMBERING SYSTEM

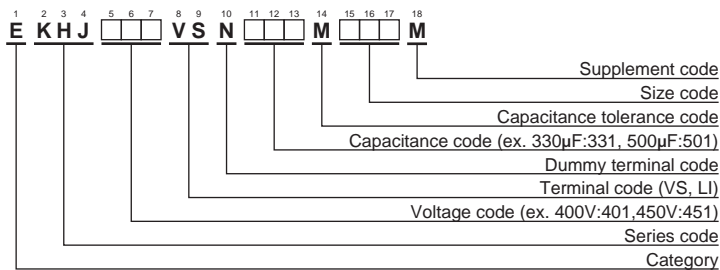

Please refer to "Product code guide (snap-in type)"



KHJ Series

◆STANDARD RATINGS

WV (V _{dc})	Cap (μF)	Case size φD×L(mm)	tan δ	Rated ripple current (Arms/105°C, 120Hz)	Part No.	WV (V _{dc})	Cap (μF)	Case size φD×L(mm)	tan δ	Rated ripple current (Arms/105°C, 120Hz)	Part No.
400	280	30 × 35	0.15	2.32	EKHJ401VSN281MR35M	420	440	35 × 41	0.20	2.99	EKHJ421VSN441MA41M
	360	30 × 41	0.15	2.71	EKHJ401VSN361MR41M		490	30 × 59	0.20	3.28	EKHJ421VSN491MR59M
	410	30 × 46	0.15	2.96	EKHJ401VSN411MR46M		500	35 × 46	0.20	3.27	EKHJ421VSN501MA46M
	410	35 × 35	0.15	2.96	EKHJ401VSN411MA35M		590	35 × 51	0.20	3.64	EKHJ421VSN591MA51M
	480	30 × 51	0.15	3.27	EKHJ401VSN481MR51M		630	35 × 54	0.20	3.80	EKHJ421VSN631MA54M
	510	35 × 41	0.15	3.43	EKHJ401VSN511MA41M		710	35 × 59	0.20	4.10	EKHJ421VSN711MA59M
	520	30 × 54	0.15	3.44	EKHJ401VSN521MR54M		450	240	30 × 35	0.20	2.12
	570	30 × 59	0.15	3.67	EKHJ401VSN571MR59M	290		30 × 41	0.20	2.35	EKHJ451VSN291MR41M
	580	35 × 46	0.15	3.75	EKHJ401VSN581MA46M	330		30 × 46	0.20	2.57	EKHJ451VSN331MR46M
	680	35 × 51	0.15	4.15	EKHJ401VSN681MA51M	330		35 × 35	0.20	2.50	EKHJ451VSN331MA35M
	740	35 × 54	0.15	4.38	EKHJ401VSN741MA54M	380		30 × 51	0.20	2.81	EKHJ451VSN381MR51M
820	35 × 59	0.15	4.69	EKHJ401VSN821MA59M	410	30 × 54		0.20	2.96	EKHJ451VSN411MR54M	
420	250	30 × 35	0.20	2.12	EKHJ421VSN251MR35M	410		35 × 41	0.20	2.89	EKHJ451VSN411MA41M
	310	30 × 41	0.20	2.43	EKHJ421VSN311MR41M	460		30 × 59	0.20	3.18	EKHJ451VSN461MR59M
	350	35 × 35	0.20	2.57	EKHJ421VSN351MA35M	460		35 × 46	0.20	3.14	EKHJ451VSN461MA46M
	360	30 × 46	0.20	2.68	EKHJ421VSN361MR46M	550		35 × 51	0.20	3.51	EKHJ451VSN551MA51M
	420	30 × 51	0.20	2.96	EKHJ421VSN421MR51M	590	35 × 54	0.20	3.68	EKHJ451VSN591MA54M	
	440	30 × 54	0.20	3.06	EKHJ421VSN441MR54M	660	35 × 59	0.20	3.95	EKHJ451VSN661MA59M	

◆RATED RIPPLE CURRENT MULTIPLIERS

● Frequency Multipliers

Frequency(Hz)	50	120	300	1k	10k	50k
400 to 450V	0.72	1.00	1.21	1.38	1.48	1.46

The deterioration of aluminum electrolytic capacitors accelerates their life due to the internal heating produced by ripple current. For details, refer to Section "5-3 Ripple Current Effect on Lifetime" in the catalog, Technical Note.

KMT Series

- Higher ripple current from KMS series
- Endurance with ripple current : 3,000 hours at 105°C
- Rated voltage range : 420, 450V_{dc}, Capacitance range : 82 to 680μF
- For inverter control, switching power supplies
- Non solvent resistant type
- RoHS2 Compliant

KMT

Higher ripple
KMS



SPECIFICATIONS

Items	Characteristics	
Category	-25 to +105°C	
Temperature Range		
Rated Voltage Range	420, 450V _{dc}	
Capacitance Tolerance	±20% (M) (at 20°C, 120Hz)	
Leakage Current	I ≤ 3/CV Where, I : Max. leakage current (μA), C : Nominal capacitance (μF), V : Rated voltage (V) (at 20°C after 5 minutes)	
Dissipation Factor (tan δ)	Rated voltage (V _{dc})	420 & 450V
	tan δ (Max.)	0.20 (at 20°C, 120Hz)
Low Temperature Characteristics (Max. Impedance Ratio)	Rated voltage (V _{dc})	420 & 450V
	Z(-25°C)/Z(+20°C)	8 (at 120Hz)
Endurance	The following specifications shall be satisfied when the capacitors are restored to 20°C after subjected to DC voltage with the rated ripple current is applied (the peak voltage shall not exceed the rated voltage) for 3,000 hours at 105°C.	
	Capacitance change	≤ ±20% of the initial value
	D.F. (tan δ)	≤ 200% of the initial specified value
	Leakage current	≤ The initial specified value
Shelf Life	The following specifications shall be satisfied when the capacitors are restored to 20°C after exposing them for 1,000 hours at 105°C without voltage applied. Before the measurement, the capacitor shall be preconditioned by applying voltage according to Item 4.1 of JIS C 5101-4.	
	Capacitance change	≤ ±15% of the initial value
	D.F. (tan δ)	≤ 150% of the initial specified value
	Leakage current	≤ The initial specified value

DIMENSIONS [mm]

Terminal Code : VS (φ22 to φ35) : Standard

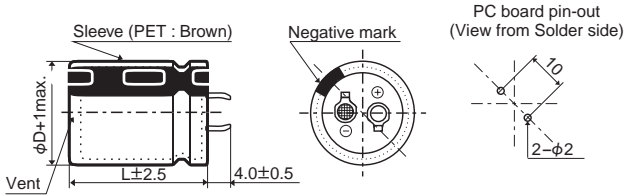

Terminal Code : LI (φ35)

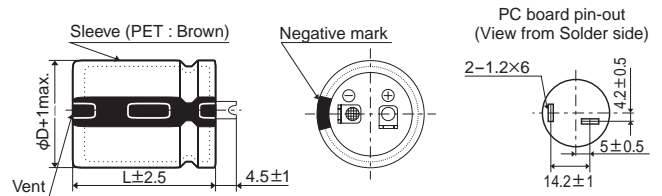

The standard design has no plastic disc.

PART NUMBERING SYSTEM

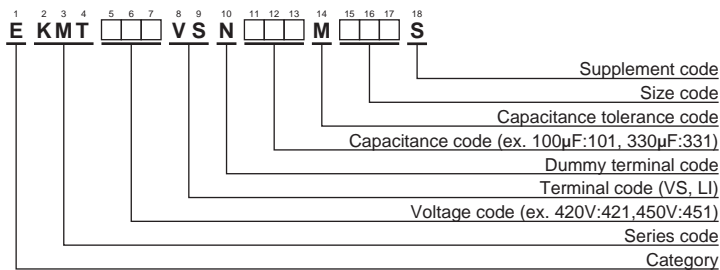

Please refer to "Product code guide (snap-in type)"



KMT Series

◆STANDARD RATINGS

WV (V _{dc})	Cap (μF)	Case size φD×L(mm)	tan δ	Rated ripple current (Arms/105°C, 120Hz)	Part No.	WV (V _{dc})	Cap (μF)	Case size φD×L(mm)	tan δ	Rated ripple current (Arms/105°C, 120Hz)	Part No.
420	100	22 × 25	0.20	0.89	EKMT421VSN101MP25S	450	82	22 × 25	0.20	0.81	EKMT451VSN820MP25S
	120	22 × 30	0.20	1.06	EKMT421VSN121MP30S		100	22 × 30	0.20	0.97	EKMT451VSN101MP30S
	120	25.4 × 25	0.20	1.09	EKMT421VSN121MQ25S		100	25.4 × 25	0.20	1.04	EKMT451VSN101MQ25S
	150	22 × 35	0.20	1.21	EKMT421VSN151MP35S		120	22 × 35	0.20	1.08	EKMT451VSN121MP35S
	180	22 × 40	0.20	1.34	EKMT421VSN181MP40S		150	22 × 40	0.20	1.22	EKMT451VSN151MP40S
	180	25.4 × 30	0.20	1.28	EKMT421VSN181MQ30S		150	25.4 × 35	0.20	1.31	EKMT451VSN151MQ35S
	180	30 × 25	0.20	1.42	EKMT421VSN181MR25S		150	30 × 25	0.20	1.31	EKMT451VSN151MR25S
	220	22 × 45	0.20	1.47	EKMT421VSN221MP45S		180	22 × 45	0.20	1.35	EKMT451VSN181MP45S
	220	22 × 50	0.20	1.60	EKMT421VSN221MP50S		180	22 × 50	0.20	1.42	EKMT451VSN181MP50S
	220	25.4 × 35	0.20	1.47	EKMT421VSN221MQ35S		180	25.4 × 40	0.20	1.35	EKMT451VSN181MQ40S
	220	30 × 30	0.20	1.64	EKMT421VSN221MR30S		180	30 × 30	0.20	1.49	EKMT451VSN181MR30S
	220	35 × 25	0.20	1.64	EKMT421VSN221MA25S		180	35 × 25	0.20	1.60	EKMT451VSN181MA25S
	270	25.4 × 40	0.20	1.63	EKMT421VSN271MQ40S		220	25.4 × 45	0.20	1.55	EKMT451VSN221MQ45S
	270	25.4 × 45	0.20	1.79	EKMT421VSN271MQ45S		220	30 × 35	0.20	1.71	EKMT451VSN221MR35S
	270	30 × 35	0.20	1.87	EKMT421VSN271MR35S		270	25.4 × 50	0.20	1.74	EKMT451VSN271MQ50S
	330	25.4 × 50	0.20	1.93	EKMT421VSN331MQ50S		270	30 × 40	0.20	1.90	EKMT451VSN271MR40S
	330	30 × 40	0.20	2.10	EKMT421VSN331MR40S		270	35 × 30	0.20	1.90	EKMT451VSN271MA30S
	330	35 × 30	0.20	2.05	EKMT421VSN331MA30S		330	30 × 45	0.20	2.20	EKMT451VSN331MR45S
	390	30 × 45	0.20	2.32	EKMT421VSN391MR45S		330	35 × 35	0.20	2.20	EKMT451VSN331MA35S
	390	35 × 35	0.20	2.32	EKMT421VSN391MA35S		390	30 × 50	0.20	2.40	EKMT451VSN391MR50S
470	30 × 50	0.20	2.51	EKMT421VSN471MR50S	390	35 × 40	0.20	2.42	EKMT451VSN391MA40S		
470	35 × 40	0.20	2.62	EKMT421VSN471MA40S	470	35 × 45	0.20	2.67	EKMT451VSN471MA45S		
560	35 × 45	0.20	2.88	EKMT421VSN561MA45S	560	35 × 50	0.20	2.85	EKMT451VSN561MA50S		
680	35 × 50	0.20	3.10	EKMT421VSN681MA50S							

◆RATED RIPPLE CURRENT MULTIPLIERS

●Frequency Multipliers

Frequency(Hz)	50	120	300	1k	10k	50k
420, 450V _{dc}	0.68	1.00	1.16	1.30	1.41	1.43

The deterioration of aluminum electrolytic capacitors accelerates their life due to the internal heating produced by ripple current. For details, refer to Section "5-3 Ripple Current Effect on Lifetime" in the catalog, Technical Note.

KHX Series New!

- The KMS series has been improved to have a higher capacitance and ripple current.
- Endurance with ripple current : 105°C 3,000 hours
- Rated voltage range : 350 to 400V
- Capacitance range : 150 to 1,570μF
- Suitable for use in switching power supply equipment and inverters.
- Non solvent resistant type
- The logo mark printed on the sleeve will be changed.
- RoHS2 Compliant

KHX
↑ Downsizing
Higher ripple
KMS



◆ SPECIFICATIONS

Items	Characteristics	
Category	-40 to +105°C	
Temperature Range	-40 to +105°C	
Rated Voltage Range	350 to 400V _{dc}	
Capacitance Tolerance	±20% (M) (at 20°C, 120Hz)	
Leakage Current	I ≤ 3√CV Where, I : Max. leakage current (μA), C : Nominal capacitance (μF), V : Rated voltage (V) (at 20°C after 5 minutes)	
Dissipation Factor (tan δ)	Rated voltage (V _{dc})	350 to 400V
	tan δ (Max.)	0.15 (at 20°C, 120Hz)
Low Temperature Characteristics (Max. Impedance Ratio)	Rated voltage (V _{dc})	350 to 400V
	Z(-25°C)/Z(+20°C)	5
	Z(-40°C)/Z(+20°C)	20 (at 120Hz)
Endurance	The following specifications shall be satisfied when the capacitors are restored to 20°C after subjected to DC voltage with the rated ripple current is applied (the peak voltage shall not exceed the rated voltage) for 3,000 hours at 105°C.	
	Capacitance change	≤ ±20% of the initial value
	D.F. (tan δ)	≤ 200% of the initial specified value
	Leakage current	≤ The initial specified value
Shelf Life	The following specifications shall be satisfied when the capacitors are restored to 20°C after exposing them for 1,000 hours at 105°C without voltage applied. Before the measurement, the capacitor shall be preconditioned by applying voltage according to Item 4.1 of JIS C 5101-4.	
	Capacitance change	≤ ±15% of the initial value
	D.F. (tan δ)	≤ 150% of the initial specified value
	Leakage current	≤ The initial specified value

◆ DIMENSIONS [mm]

● Terminal Code : VS (φ22 to φ35) : Standard

● Terminal Code : LI (φ30, φ35)

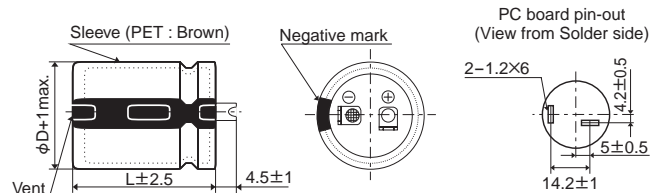
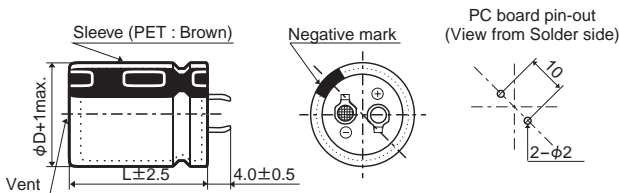

The standard design has no plastic disc.

◆ PART NUMBERING SYSTEM

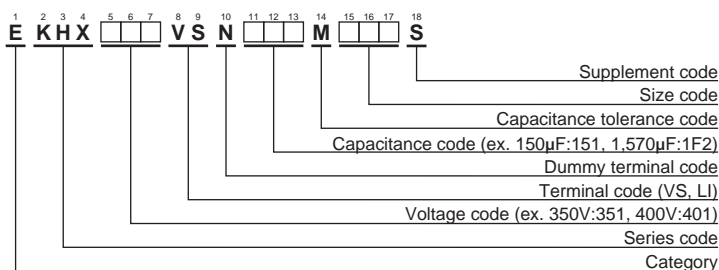

Please refer to "Product code guide (snap-in type)"



◆ **STANDARD RATINGS**

WV (V _{dc})	Cap (μF)	Case size φD×L(mm)	tan δ	Rated ripple current (Arms/105°C, 120Hz)	Part No.	WV (V _{dc})	Cap (μF)	Case size φD×L(mm)	tan δ	Rated ripple current (Arms/105°C, 120Hz)	Part No.	
350	180	22 × 25	0.15	1.43	EKHX351VSN181MP25S	375	560	30 × 35	0.15	2.65	EKHX3H1VSN561MR35S	
	230	22 × 30	0.15	1.70	EKHX351VSN231MP30S		570	25.4 × 50	0.15	2.88	EKHX3H1VSN571MQ50S	
	250	25.4 × 25	0.15	1.68	EKHX351VSN251MQ25S		590	35 × 30	0.15	2.47	EKHX3H1VSN591MA30S	
	290	22 × 35	0.15	1.95	EKHX351VSN291MP35S		640	25.4 × 55	0.15	3.10	EKHX3H1VSN641MQ55S	
	330	25.4 × 30	0.15	1.99	EKHX351VSN331MQ30S		660	30 × 40	0.15	2.96	EKHX3H1VSN661MR40S	
	340	22 × 40	0.15	2.16	EKHX351VSN341MP40S		710	25.4 × 60	0.15	3.32	EKHX3H1VSN711MQ60S	
	380	30 × 25	0.15	2.11	EKHX351VSN381MR25S		730	35 × 35	0.15	2.79	EKHX3H1VSN731MA35S	
	390	22 × 45	0.15	2.36	EKHX351VSN391MP45S		770	30 × 45	0.15	3.28	EKHX3H1VSN771MR45S	
	400	25.4 × 35	0.15	2.28	EKHX351VSN401MQ35S		870	30 × 50	0.15	3.54	EKHX3H1VSN871MR50S	
	450	22 × 50	0.15	2.59	EKHX351VSN451MP50S		870	35 × 40	0.15	3.15	EKHX3H1VSN871MA40S	
	480	25.4 × 40	0.15	2.55	EKHX351VSN481MQ40S		980	30 × 55	0.15	3.84	EKHX3H1VSN981MR55S	
	490	35 × 25	0.15	2.22	EKHX351VSN491MA25S		1,020	35 × 45	0.15	3.50	EKHX3H1VSN102MA45S	
	500	22 × 55	0.15	2.78	EKHX351VSN501MP55S		1,080	30 × 60	0.15	4.10	EKHX3H1VSN112MR60S	
	500	30 × 30	0.15	2.45	EKHX351VSN501MR30S		1,160	35 × 50	0.15	3.81	EKHX3H1VSN112MA50S	
	550	25.4 × 45	0.15	2.78	EKHX351VSN551MQ45S		1,300	35 × 55	0.15	4.12	EKHX3H1VSN132MA55S	
	560	22 × 60	0.15	3.00	EKHX351VSN561MP60S		1,440	35 × 60	0.15	4.42	EKHX3H1VSN1E2MA60S	
	610	30 × 35	0.15	2.77	EKHX351VSN611MR35S		400	150	22 × 25	0.15	1.31	EKHX401VSN151MP25S
	630	25.4 × 50	0.15	3.03	EKHX351VSN631MQ50S			200	22 × 30	0.15	1.58	EKHX401VSN201MP30S
	640	35 × 30	0.15	2.58	EKHX351VSN641MA30S			220	25.4 × 25	0.15	1.58	EKHX401VSN221MQ25S
	700	25.4 × 55	0.15	3.24	EKHX351VSN701MQ55S			250	22 × 35	0.15	1.81	EKHX401VSN251MP35S
	720	30 × 40	0.15	3.09	EKHX351VSN721MR40S			280	25.4 × 30	0.15	1.83	EKHX401VSN281MQ30S
	780	25.4 × 60	0.15	3.48	EKHX351VSN781MQ60S			290	22 × 40	0.15	1.99	EKHX401VSN291MP40S
	800	35 × 35	0.15	2.92	EKHX351VSN801MA35S			330	30 × 25	0.15	1.96	EKHX401VSN331MR25S
	840	30 × 45	0.15	3.43	EKHX351VSN841MR45S			340	22 × 45	0.15	2.20	EKHX401VSN341MP45S
950	30 × 50	0.15	3.70	EKHX351VSN951MR50S	340	25.4 × 35		0.15	2.10	EKHX401VSN341MQ35S		
950	35 × 40	0.15	3.29	EKHX351VSN951MA40S	390	22 × 50		0.15	2.41	EKHX401VSN391MP50S		
1,060	30 × 55	0.15	3.99	EKHX351VSN1A2MR55S	410	25.4 × 40		0.15	2.35	EKHX401VSN411MQ40S		
1,110	35 × 45	0.15	3.65	EKHX351VSN112MA45S	420	35 × 25		0.15	2.05	EKHX401VSN421MA25S		
1,180	30 × 60	0.15	4.29	EKHX351VSN122MR60S	430	22 × 55		0.15	2.58	EKHX401VSN431MP55S		
1,260	35 × 50	0.15	3.98	EKHX351VSN1C2MA50S	430	30 × 30		0.15	2.27	EKHX401VSN431MR30S		
1,420	35 × 55	0.15	4.31	EKHX351VSN142MA55S	470	25.4 × 45		0.15	2.57	EKHX401VSN471MQ45S		
1,570	35 × 60	0.15	4.61	EKHX351VSN1F2MA60S	480	22 × 60		0.15	2.77	EKHX401VSN481MP60S		
375	160	22 × 25	0.15	1.35	EKHX3H1VSN161MP25S	520		30 × 35	0.15	2.55	EKHX401VSN521MR35S	
	210	22 × 30	0.15	1.62	EKHX3H1VSN211MP30S	540		25.4 × 50	0.15	2.80	EKHX401VSN541MQ50S	
	230	25.4 × 25	0.15	1.61	EKHX3H1VSN231MQ25S	550		35 × 30	0.15	2.39	EKHX401VSN551MA30S	
	260	22 × 35	0.15	1.85	EKHX3H1VSN261MP35S	600		25.4 × 55	0.15	3.00	EKHX401VSN601MQ55S	
	300	25.4 × 30	0.15	1.89	EKHX3H1VSN301MQ30S	620		30 × 40	0.15	2.87	EKHX401VSN621MR40S	
	310	22 × 40	0.15	2.06	EKHX3H1VSN311MP40S	670		25.4 × 60	0.15	3.22	EKHX401VSN671MQ60S	
	350	30 × 25	0.15	2.02	EKHX3H1VSN351MR25S	690		35 × 35	0.15	2.71	EKHX401VSN691MA35S	
	360	22 × 45	0.15	2.26	EKHX3H1VSN361MP45S	720		30 × 45	0.15	3.17	EKHX401VSN721MR45S	
	370	25.4 × 35	0.15	2.19	EKHX3H1VSN371MQ35S	820	30 × 50	0.15	3.44	EKHX401VSN821MR50S		
	410	22 × 50	0.15	2.47	EKHX3H1VSN411MP50S	820	35 × 40	0.15	3.06	EKHX401VSN821MA40S		
	440	25.4 × 40	0.15	2.44	EKHX3H1VSN441MQ40S	920	30 × 55	0.15	3.72	EKHX401VSN921MR55S		
	450	30 × 30	0.15	2.32	EKHX3H1VSN451MR30S	950	35 × 45	0.15	3.38	EKHX401VSN951MA45S		
	450	35 × 25	0.15	2.12	EKHX3H1VSN451MA25S	1,010	30 × 60	0.15	3.97	EKHX401VSN102MR60S		
	460	22 × 55	0.15	2.67	EKHX3H1VSN461MP55S	1,090	35 × 50	0.15	3.70	EKHX401VSN112MA50S		
	500	25.4 × 45	0.15	2.65	EKHX3H1VSN501MQ45S	1,220	35 × 55	0.15	3.99	EKHX401VSN122MA55S		
	510	22 × 60	0.15	2.86	EKHX3H1VSN511MP60S	1,350	35 × 60	0.15	4.28	EKHX401VSN1D2MA60S		



◆ HIGHER RIPPLE CURRENT RATINGS

WV (V _{dc})	Cap (μF)	Case size φD×L(mm)	tan δ	Rated ripple current (Arms/105°C, 120Hz)	Part No.	WV (V _{dc})	Cap (μF)	Case size φD×L(mm)	tan δ	Rated ripple current (Arms/105°C, 120Hz)	Part No.	
350	340	30 × 25	0.15	2.47	EKHX351VSN341MR25S	375	810	30 × 50	0.15	4.23	EKHX3H1VSN811MR50S	
	450	30 × 30	0.15	2.87	EKHX351VSN451MR30S		830	35 × 40	0.15	4.07	EKHX3H1VSN831MA40S	
	470	35 × 25	0.15	2.87	EKHX351VSN471MA25S		910	30 × 55	0.15	4.57	EKHX3H1VSN911MR55S	
	560	30 × 35	0.15	3.28	EKHX351VSN561MR35S		970	35 × 45	0.15	4.52	EKHX3H1VSN971MA45S	
	620	35 × 30	0.15	3.36	EKHX351VSN621MA30S		1,010	30 × 60	0.15	4.91	EKHX3H1VSN102MR60S	
	670	30 × 40	0.15	3.69	EKHX351VSN671MR40S		1,110	35 × 50	0.15	4.94	EKHX3H1VSN112MA50S	
	760	35 × 35	0.15	3.77	EKHX351VSN761MA35S		1,240	35 × 55	0.15	5.33	EKHX3H1VSN1C2MA55S	
	770	30 × 45	0.15	4.06	EKHX351VSN771MR45S		1,380	35 × 60	0.15	5.72	EKHX3H1VSN142MA60S	
	880	30 × 50	0.15	4.41	EKHX351VSN881MR50S		400	290	30 × 25	0.15	2.28	EKHX401VSN291MR25S
	910	35 × 40	0.15	4.26	EKHX351VSN911MA40S			390	30 × 30	0.15	2.67	EKHX401VSN391MR30S
	990	30 × 55	0.15	4.77	EKHX351VSN991MR55S			400	35 × 25	0.15	2.65	EKHX401VSN401MA25S
	1,060	35 × 45	0.15	4.73	EKHX351VSN1A2MA45S			480	30 × 35	0.15	3.04	EKHX401VSN481MR35S
	1,100	30 × 60	0.15	5.12	EKHX351VSN112MR60S			530	35 × 30	0.15	3.10	EKHX401VSN531MA30S
	1,210	35 × 50	0.15	5.15	EKHX351VSN122MA50S			570	30 × 40	0.15	3.40	EKHX401VSN571MR40S
1,350	35 × 55	0.15	5.56	EKHX351VSN1D2MA55S	660	35 × 35		0.15	3.51	EKHX401VSN661MA35S		
1,500	35 × 60	0.15	5.97	EKHX351VSN152MA60S	670	30 × 45		0.15	3.78	EKHX401VSN671MR45S		
375	310	30 × 25	0.15	2.36	EKHX3H1VSN311MR25S	760		30 × 50	0.15	4.10	EKHX401VSN761MR50S	
	410	30 × 30	0.15	2.74	EKHX3H1VSN411MR30S	780		35 × 40	0.15	3.95	EKHX401VSN781MA40S	
	430	35 × 25	0.15	2.75	EKHX3H1VSN431MA25S	850		30 × 55	0.15	4.42	EKHX401VSN851MR55S	
	510	30 × 35	0.15	3.13	EKHX3H1VSN511MR35S	910		35 × 45	0.15	4.38	EKHX401VSN911MA45S	
	560	35 × 30	0.15	3.19	EKHX3H1VSN561MA30S	940		30 × 60	0.15	4.74	EKHX401VSN941MR60S	
	610	30 × 40	0.15	3.52	EKHX3H1VSN611MR40S	1,040		35 × 50	0.15	4.78	EKHX401VSN1A2MA50S	
	700	35 × 35	0.15	3.62	EKHX3H1VSN701MA35S	1,160	35 × 55	0.15	5.15	EKHX401VSN1B2MA55S		
	710	30 × 45	0.15	3.90	EKHX3H1VSN711MR45S	1,290	35 × 60	0.15	5.53	EKHX401VSN132MA60S		

◆ RATED RIPPLE CURRENT MULTIPLIERS

● Frequency Multipliers

Frequency(Hz)	50	120	300	1k	10k	50k
350 to 400V _{dc}	0.70	1.00	1.10	1.17	1.25	1.31

The deterioration of aluminum electrolytic capacitors accelerates their life due to the internal heating produced by ripple current. For details, refer to Section "5-3 Ripple Current Effect on Lifetime" in the catalog, Technical Note.

KHU Upgrade! Series

- Lineup of high withstand voltage products for server power supplies and solar power generation applications
- Endurance with ripple current : 3,000 hours at 105°C
- Rated voltage range:400 to 500V, Capacitance range:120 to 1,910μF
- Non solvent resistant type
- RoHS2 Compliant

KHU

↑ Downsizing

KHS

↑ Downsizing

KMS



◆ SPECIFICATIONS

Items	Characteristics	
Category	-40 to +105°C	
Temperature Range		
Rated Voltage Range	400 to 500V _{dc}	
Capacitance Tolerance	±20% (M) (at 20°C, 120Hz)	
Leakage Current	I ≤ 3/CV Where, I : Max. leakage current (μA), C : Nominal capacitance (μF), V : Rated voltage (V) (at 20°C after 5 minutes)	
Dissipation Factor (tan δ)	Rated voltage (V _{dc})	400 to 500V
	tan δ (Max.)	0.20 (at 20°C, 120Hz)
Low Temperature Characteristics (Max. Impedance Ratio)	Rated voltage (V _{dc})	400 to 500V
	Z(-25°C)/Z(+20°C)	8 (at 120Hz)
Endurance	The following specifications shall be satisfied when the capacitors are restored to 20°C after subjected to DC voltage with the rated ripple current is applied (the peak voltage shall not exceed the rated voltage) for 3,000 hours at 105°C.	
	Capacitance change	≤ ±20% of the initial value
	D.F. (tan δ)	≤ 200% of the initial specified value
	Leakage current	≤ The initial specified value
Shelf Life	The following specifications shall be satisfied when the capacitors are restored to 20°C after exposing them for 1,000 hours at 105°C without voltage applied. Before the measurement, the capacitor shall be preconditioned by applying voltage according to Item 4.1 of JIS C 5101-4.	
	Capacitance change	≤ ±15% of the initial value
	D.F. (tan δ)	≤ 150% of the initial specified value
	Leakage current	≤ The initial specified value

◆ DIMENSIONS [mm]

● Terminal Code : VS (φ25.4 to φ35) : Standard

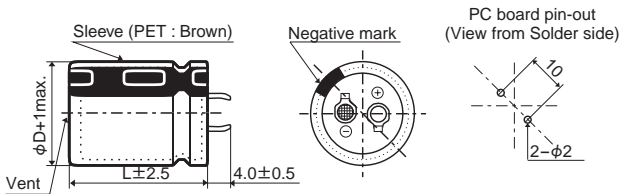

● Terminal Code : LI (φ30, φ35)

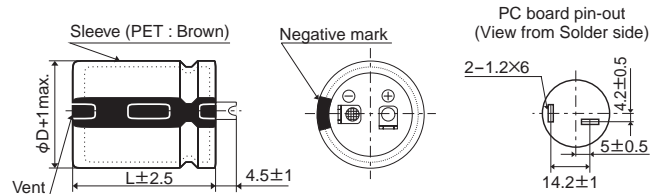

The standard design has no plastic disc.

◆ PART NUMBERING SYSTEM

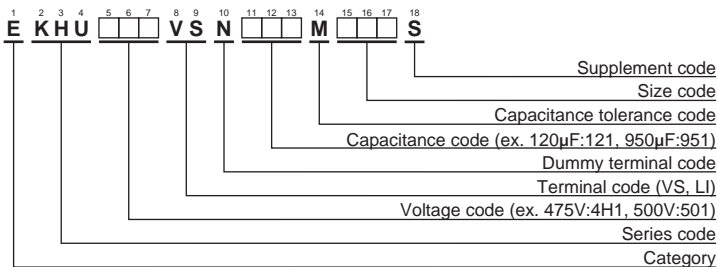

Please refer to "Product code guide (snap-in type)"



LARGE CAPACITANCE ALUMINUM ELECTROLYTIC CAPACITORS



◆STANDARD RATINGS

WV (V _{dc})	Cap (μF)	Case size φD×L(mm)	tan δ	Rated ripple current (Arms/105°C, 120Hz)	Part No.	WV (V _{dc})	Cap (μF)	Case size φD×L(mm)	tan δ	Rated ripple current (Arms/105°C, 120Hz)	Part No.	
400	240	25.4 × 25	0.20	1.17	EKHU401VSN241MQ25S	420	850	30 × 50	0.20	2.52	EKHU421VSN851MR50S	
	310	25.4 × 30	0.20	1.37	EKHU401VSN311MQ30S		850	35 × 40	0.20	2.23	EKHU421VSN851MA40S	
	360	30 × 25	0.20	1.48	EKHU401VSN361MR25S		960	30 × 55	0.20	2.73	EKHU421VSN961MR55S	
	380	25.4 × 35	0.20	1.58	EKHU401VSN381MQ35S		980	35 × 45	0.20	2.45	EKHU421VSN981MA45S	
	450	25.4 × 40	0.20	1.75	EKHU401VSN451MQ40S		1,040	30 × 60	0.20	2.90	EKHU421VSN1A2MR60S	
	460	35 × 25	0.20	1.53	EKHU401VSN461MA25S		1,100	30 × 65	0.20	3.04	EKHU421VSN112MR65S	
	470	30 × 30	0.20	1.71	EKHU401VSN471MR30S		1,120	35 × 50	0.20	2.68	EKHU421VSN1D2MR80S	
	520	25.4 × 45	0.20	1.92	EKHU401VSN521MQ45S		1,180	30 × 70	0.20	3.20	EKHU421VSN122MR70S	
	580	30 × 35	0.20	1.94	EKHU401VSN581MR35S		1,250	30 × 75	0.20	3.35	EKHU421VSN1C2MR75S	
	590	25.4 × 50	0.20	2.08	EKHU401VSN591MQ50S		1,260	35 × 55	0.20	2.86	EKHU421VSN1C2MA55S	
	600	35 × 30	0.20	1.78	EKHU401VSN601MA30S		1,340	30 × 80	0.20	3.52	EKHU421VSN1D2MR80S	
	660	25.4 × 55	0.20	2.24	EKHU401VSN661MQ55S		1,400	35 × 60	0.20	3.04	EKHU421VSN142MA60S	
	680	30 × 40	0.20	2.16	EKHU401VSN681MR40S		1,420	35 × 65	0.20	3.12	EKHU421VSN142MA65S	
	720	25.4 × 60	0.20	2.38	EKHU401VSN721MQ60S		1,550	35 × 70	0.20	3.32	EKHU421VSN1F2MA70S	
	750	35 × 35	0.20	2.02	EKHU401VSN751MR35S		1,680	35 × 75	0.20	3.51	EKHU421VSN172MA75S	
	790	30 × 45	0.20	2.39	EKHU401VSN791MR45S		1,810	35 × 80	0.20	3.71	EKHU421VSN182MA80S	
	890	35 × 40	0.20	2.28	EKHU401VSN891MA40S		450	200	25.4 × 25	0.20	1.07	EKHU451VSN201MQ25S
	900	30 × 50	0.20	2.60	EKHU401VSN901MR50S			260	25.4 × 30	0.20	1.25	EKHU451VSN261MQ30S
	1,010	30 × 55	0.20	2.80	EKHU401VSN101MR55S			310	30 × 25	0.20	1.37	EKHU451VSN311MR25S
	1,040	35 × 45	0.20	2.53	EKHU401VSN1A2MA45S			320	25.4 × 35	0.20	1.45	EKHU451VSN321MQ35S
1,090	30 × 60	0.20	2.97	EKHU401VSN112MR60S	390	25.4 × 40		0.20	1.63	EKHU451VSN391MQ40S		
1,160	30 × 65	0.20	3.12	EKHU401VSN1B2MR65S	390	35 × 25		0.20	1.41	EKHU451VSN391MA25S		
1,180	35 × 50	0.20	2.75	EKHU401VSN122MA50S	400	30 × 30		0.20	1.57	EKHU451VSN401MR30S		
1,240	30 × 70	0.20	3.28	EKHU401VSN1C2MR70S	450	25.4 × 45		0.20	1.79	EKHU451VSN451MQ45S		
1,310	30 × 75	0.20	3.43	EKHU401VSN132MR75S	490	30 × 35		0.20	1.78	EKHU451VSN491MR35S		
1,320	35 × 55	0.20	2.93	EKHU401VSN132MA55S	510	25.4 × 50		0.20	1.94	EKHU451VSN511MQ50S		
1,410	30 × 80	0.20	3.61	EKHU401VSN142MR80S	520	35 × 30		0.20	1.66	EKHU451VSN521MA30S		
1,470	35 × 60	0.20	3.11	EKHU401VSN1E2MA60S	570	25.4 × 55		0.20	2.08	EKHU451VSN571MQ55S		
1,500	35 × 65	0.20	3.21	EKHU401VSN152MA65S	590	30 × 40		0.20	2.02	EKHU451VSN591MR40S		
1,630	35 × 70	0.20	3.40	EKHU401VSN1G2MA70S	620	25.4 × 60		0.20	2.21	EKHU451VSN621MQ60S		
1,770	35 × 75	0.20	3.61	EKHU401VSN1H2MA75S	640	35 × 35		0.20	1.87	EKHU451VSN641MA35S		
1,910	35 × 80	0.20	3.81	EKHU401VSN192MA80S	680	30 × 45		0.20	2.22	EKHU451VSN681MR45S		
420	220	25.4 × 25	0.20	1.12	EKHU421VSN221MQ25S	770		30 × 50	0.20	2.40	EKHU451VSN771MR50S	
	290	25.4 × 30	0.20	1.32	EKHU421VSN291MQ30S	770		35 × 40	0.20	2.12	EKHU451VSN771MA40S	
	340	30 × 25	0.20	1.44	EKHU421VSN341MR25S	860		30 × 55	0.20	2.59	EKHU451VSN861MR55S	
	360	25.4 × 35	0.20	1.54	EKHU421VSN361MQ35S	890		35 × 45	0.20	2.34	EKHU451VSN891MA45S	
	430	25.4 × 40	0.20	1.72	EKHU421VSN431MQ40S	940	30 × 60	0.20	2.76	EKHU451VSN941MR60S		
	430	35 × 25	0.20	1.48	EKHU421VSN431MA25S	1,010	30 × 65	0.20	2.91	EKHU451VSN102MR65S		
	440	30 × 30	0.20	1.65	EKHU421VSN441MR30S	1,020	35 × 50	0.20	2.56	EKHU451VSN102MA50S		
	490	25.4 × 45	0.20	1.87	EKHU421VSN491MQ45S	1,080	30 × 70	0.20	3.06	EKHU451VSN112MR70S		
	550	30 × 35	0.20	1.89	EKHU421VSN551MR35S	1,140	30 × 75	0.20	3.20	EKHU451VSN1B2MR75S		
	560	25.4 × 50	0.20	2.03	EKHU421VSN561MQ50S	1,140	35 × 55	0.20	2.72	EKHU451VSN1B2MA55S		
	570	35 × 30	0.20	1.74	EKHU421VSN571MA30S	1,230	30 × 80	0.20	3.38	EKHU451VSN1C2MR80S		
	630	25.4 × 55	0.20	2.19	EKHU421VSN631MQ55S	1,260	35 × 60	0.20	2.88	EKHU451VSN1C2MA60S		
	650	30 × 40	0.20	2.12	EKHU421VSN651MR40S	1,300	35 × 65	0.20	2.98	EKHU451VSN132MA65S		
	680	25.4 × 60	0.20	2.31	EKHU421VSN681MQ60S	1,410	35 × 70	0.20	3.16	EKHU451VSN142MA70S		
	710	35 × 35	0.20	1.97	EKHU421VSN711MA35S	1,530	35 × 75	0.20	3.35	EKHU451VSN1F2MA75S		
	750	30 × 45	0.20	2.33	EKHU421VSN751MR45S	1,650	35 × 80	0.20	3.54	EKHU451VSN1G2MA80S		



LARGE CAPACITANCE ALUMINUM ELECTROLYTIC CAPACITORS

KHU Upgrade! Series

◆STANDARD RATINGS

WV (V _{dc})	Cap (μF)	Case size φD×L(mm)	tan δ	Rated ripple current (Arms/105°C, 120Hz)	Part No.	WV (V _{dc})	Cap (μF)	Case size φD×L(mm)	tan δ	Rated ripple current (Arms/105°C, 120Hz)	Part No.
475	160	25.4 × 25	0.20	1.07	EKHU4H1VSN161MQ25S	500	120	25.4 × 25	0.20	0.93	EKHU501VSN121MQ25S
	200	25.4 × 30	0.20	1.23	EKHU4H1VSN201MQ30S		170	25.4 × 30	0.20	1.13	EKHU501VSN171MQ30S
	240	30 × 25	0.20	1.38	EKHU4H1VSN241MR25S		190	30 × 25	0.20	1.23	EKHU501VSN191MR25S
	250	25.4 × 35	0.20	1.43	EKHU4H1VSN251MQ35S		210	25.4 × 35	0.20	1.31	EKHU501VSN211MQ35S
	280	35 × 25	0.20	1.48	EKHU4H1VSN281MA25S		250	25.4 × 40	0.20	1.46	EKHU501VSN251MQ40S
	300	25.4 × 40	0.20	1.60	EKHU4H1VSN301MQ40S		250	30 × 30	0.20	1.43	EKHU501VSN251MR30S
	310	30 × 30	0.20	1.59	EKHU4H1VSN311MR30S		260	35 × 25	0.20	1.43	EKHU501VSN261MA25S
	350	25.4 × 45	0.20	1.76	EKHU4H1VSN351MQ45S		300	25.4 × 45	0.20	1.63	EKHU501VSN301MQ45S
	380	30 × 35	0.20	1.80	EKHU4H1VSN381MR35S		320	30 × 35	0.20	1.65	EKHU501VSN321MR35S
	380	35 × 30	0.20	1.75	EKHU4H1VSN381MA30S		340	25.4 × 50	0.20	1.76	EKHU501VSN341MQ50S
	390	25.4 × 50	0.20	1.89	EKHU4H1VSN391MR50S		340	35 × 30	0.20	1.66	EKHU501VSN341MA30S
	440	25.4 × 55	0.20	2.04	EKHU4H1VSN441MQ55S		380	25.4 × 55	0.20	1.89	EKHU501VSN381MQ55S
	450	30 × 40	0.20	2.01	EKHU4H1VSN451MR40S		380	30 × 40	0.20	1.85	EKHU501VSN381MR40S
	480	35 × 35	0.20	2.00	EKHU4H1VSN481MA35S		430	25.4 × 60	0.20	2.05	EKHU501VSN431MQ60S
	490	25.4 × 60	0.20	2.19	EKHU4H1VSN491MQ60S		430	35 × 35	0.20	1.89	EKHU501VSN431MA35S
	520	30 × 45	0.20	2.22	EKHU4H1VSN521MR45S		450	30 × 45	0.20	2.07	EKHU501VSN451MR45S
	570	35 × 40	0.20	2.26	EKHU4H1VSN571MA40S		510	30 × 50	0.20	2.24	EKHU501VSN511MR50S
	590	30 × 50	0.20	2.41	EKHU4H1VSN591MR50S		520	35 × 40	0.20	2.16	EKHU501VSN521MA40S
	660	30 × 55	0.20	2.59	EKHU4H1VSN661MR55S		580	30 × 55	0.20	2.43	EKHU501VSN581MR55S
	660	35 × 45	0.20	2.49	EKHU4H1VSN661MA45S		600	35 × 45	0.20	2.37	EKHU501VSN601MA45S
	730	30 × 60	0.20	2.78	EKHU4H1VSN731MR60S		640	30 × 60	0.20	2.60	EKHU501VSN641MR60S
	750	30 × 65	0.20	2.87	EKHU4H1VSN751MR65S		680	30 × 65	0.20	2.73	EKHU501VSN681MR65S
	760	35 × 50	0.20	2.72	EKHU4H1VSN761MA50S		690	35 × 50	0.20	2.59	EKHU501VSN691MA50S
	820	30 × 70	0.20	3.05	EKHU4H1VSN821MR70S		750	30 × 70	0.20	2.92	EKHU501VSN751MR70S
860	35 × 55	0.20	2.96	EKHU4H1VSN861MA55S	780	35 × 55	0.20	2.82	EKHU501VSN781MA55S		
890	30 × 75	0.20	3.23	EKHU4H1VSN891MR75S	810	30 × 75	0.20	3.08	EKHU501VSN811MR75S		
950	35 × 60	0.20	3.16	EKHU4H1VSN951MA60S	860	35 × 60	0.20	3.01	EKHU501VSN861MA60S		
960	30 × 80	0.20	3.42	EKHU4H1VSN961MR80S	870	30 × 80	0.20	3.25	EKHU501VSN871MR80S		
1,010	35 × 65	0.20	3.32	EKHU4H1VSN102MA65S	920	35 × 65	0.20	3.17	EKHU501VSN921MA65S		
1,110	35 × 70	0.20	3.54	EKHU4H1VSN112MA70S	1,010	35 × 70	0.20	3.38	EKHU501VSN102MA70S		
1,200	35 × 75	0.20	3.75	EKHU4H1VSN122MA75S	1,090	35 × 75	0.20	3.58	EKHU501VSN112MA75S		
1,290	35 × 80	0.20	3.96	EKHU4H1VSN132MA80S	1,170	35 × 80	0.20	3.77	EKHU501VSN112MA80S		

◆RATED RIPPLE CURRENT MULTIPLIERS

● Frequency Multipliers

Frequency(Hz)	50	120	300	1k	10k	50k
400 to 450V _{dc}	0.77	1.00	1.10	1.21	1.32	1.33
475, 500V _{dc}	0.77	1.00	1.11	1.20	1.25	1.33

The deterioration of aluminum electrolytic capacitors accelerates their life due to the internal heating produced by ripple current. For details, refer to Section "5-3 Ripple Current Effect on Lifetime" in the catalog, Technical Note.

KHS Series

- For solar power generation
- Endurance with ripple current : 3,000 hours at 105°C
- Rated voltage range:450 to 500V, Capacitance range:68 to 1,000μF
- Non solvent resistant type
- RoHS2 Compliant

KHS

↑ Downsizing

KMS

↑ Downsizing

KMM



◆ SPECIFICATIONS

Items	Characteristics	
Category	-40 to +105°C (450, 475V _{dc}), -25 to +105°C (500V _{dc})	
Temperature Range		
Rated Voltage Range	450 to 500V _{dc}	
Capacitance Tolerance	±20% (M) (at 20°C, 120Hz)	
Leakage Current	I ≤ 3√CV Where, I : Max. leakage current (μA), C : Nominal capacitance (μF), V : Rated voltage (V) (at 20°C after 5 minutes)	
Dissipation Factor (tan δ)	Rated voltage (V _{dc})	450 to 500V
	tan δ (Max.)	0.20 (at 20°C, 120Hz)
Low Temperature Characteristics (Max. Impedance Ratio)	Rated voltage (V _{dc})	450 to 500V
	Z(-25°C)/Z(+20°C)	8 (at 120Hz)
Endurance	The following specifications shall be satisfied when the capacitors are restored to 20°C after subjected to DC voltage with the rated ripple current is applied (the peak voltage shall not exceed the rated voltage) for 3,000 hours at 105°C.	
	Capacitance change	≤ ±20% of the initial value
	D.F. (tan δ)	≤ 200% of the initial specified value (500V _{dc} : ≤ 250%)
	Leakage current	≤ The initial specified value
Shelf Life	The following specifications shall be satisfied when the capacitors are restored to 20°C after exposing them for 1,000 hours at 105°C without voltage applied. Before the measurement, the capacitor shall be preconditioned by applying voltage according to Item 4.1 of JIS C 5101-4.	
	Capacitance change	≤ ±15% of the initial value
	D.F. (tan δ)	≤ 150% of the initial specified value
	Leakage current	≤ The initial specified value

◆ DIMENSIONS [mm]

● Terminal Code : VS (φ22 to φ35) : Standard

● Terminal Code : LI (φ35)

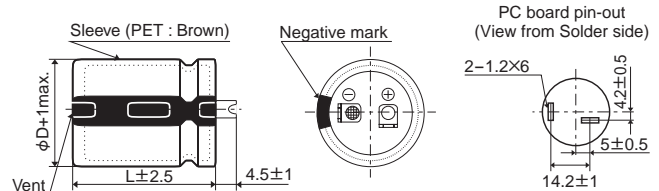
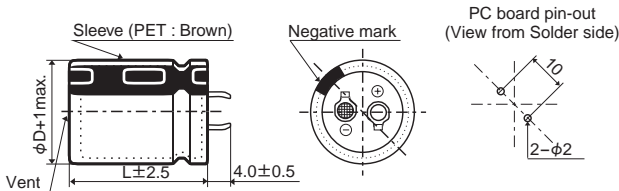

The standard design has no plastic disc.

◆ PART NUMBERING SYSTEM

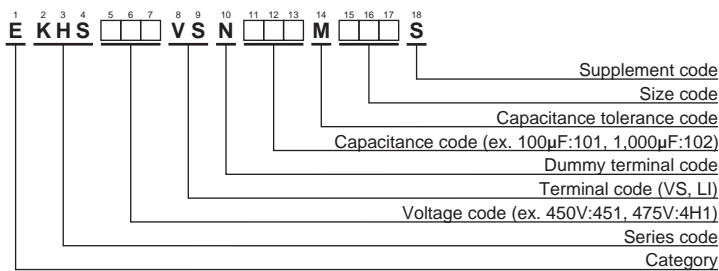

Please refer to "Product code guide (snap-in type)"



◆STANDARD RATINGS

WV (V _{dc})	Cap (μF)	Case size φD×L(mm)	tan δ	Rated ripple current (Arms/105°C, 120Hz)	Part No.	WV (V _{dc})	Cap (μF)	Case size φD×L(mm)	tan δ	Rated ripple current (Arms/105°C, 120Hz)	Part No.
450	100	22 × 25	0.20	0.71	EKHS451VSN101MP25S	475	330	30 × 35	0.20	1.53	EKHS4H1VSN331MR35S
	150	22 × 30	0.20	0.91	EKHS451VSN151MP30S		350	25.4 × 50	0.20	1.63	EKHS4H1VSN351MQ50S
	180	22 × 35	0.20	1.02	EKHS451VSN181MP35S		360	35 × 30	0.20	1.56	EKHS4H1VSN361MA30S
	180	22 × 40	0.20	1.04	EKHS451VSN181MP40S		390	30 × 40	0.20	1.71	EKHS4H1VSN391MR40S
	180	25.4 × 25	0.20	1.02	EKHS451VSN181MQ25S		400	25.4 × 55	0.20	1.77	EKHS4H1VSN401MQ55S
	220	22 × 45	0.20	1.17	EKHS451VSN221MP45S		440	25.4 × 60	0.20	1.89	EKHS4H1VSN441MQ60S
	220	25.4 × 30	0.20	1.16	EKHS451VSN221MQ30S		440	35 × 35	0.20	1.75	EKHS4H1VSN441MA35S
	270	22 × 50	0.20	1.33	EKHS451VSN271MP50S		450	30 × 45	0.20	1.89	EKHS4H1VSN451MR45S
	270	25.4 × 35	0.20	1.34	EKHS451VSN271MQ35S		510	30 × 50	0.20	2.04	EKHS4H1VSN511MR50S
	270	30 × 25	0.20	1.28	EKHS451VSN271MR25S		530	35 × 40	0.20	1.99	EKHS4H1VSN531MA40S
	270	35 × 25	0.20	1.24	EKHS451VSN271MA25S		560	35 × 50	0.20	2.13	EKHS4H1VSN561MA50S
	330	22 × 60	0.20	1.54	EKHS451VSN331MP60S		570	30 × 55	0.20	2.20	EKHS4H1VSN571MR55S
	330	25.4 × 40	0.20	1.51	EKHS451VSN331MQ40S		610	35 × 45	0.20	2.18	EKHS4H1VSN611MA45S
	330	30 × 30	0.20	1.43	EKHS451VSN331MR30S		640	30 × 60	0.20	2.38	EKHS4H1VSN641MR60S
	390	25.4 × 45	0.20	1.67	EKHS451VSN391MQ45S		700	35 × 50	0.20	2.39	EKHS4H1VSN701MA50S
	390	30 × 35	0.20	1.59	EKHS451VSN391MR35S		790	35 × 55	0.20	2.59	EKHS4H1VSN791MA55S
	390	35 × 30	0.20	1.52	EKHS451VSN391MA30S		870	35 × 60	0.20	2.77	EKHS4H1VSN871MA60S
	470	25.4 × 50	0.20	1.86	EKHS451VSN471MQ50S		68	22 × 25	0.20	0.61	EKHS501VSN680MP25S
	470	30 × 40	0.20	1.79	EKHS451VSN471MR40S		82	22 × 30	0.20	0.70	EKHS501VSN820MP30S
	470	35 × 35	0.20	1.69	EKHS451VSN471MA35S		82	25.4 × 25	0.20	0.72	EKHS501VSN820MQ25S
	560	25.4 × 60	0.20	2.09	EKHS451VSN561MQ60S		100	22 × 35	0.20	0.79	EKHS501VSN101MP35S
	560	30 × 45	0.20	2.01	EKHS451VSN561MR45S		120	22 × 40	0.20	0.89	EKHS501VSN121MP40S
	560	35 × 40	0.20	1.95	EKHS451VSN561MA40S		120	25.4 × 30	0.20	0.89	EKHS501VSN121MQ30S
	680	30 × 50	0.20	2.25	EKHS451VSN681MR50S		120	30 × 25	0.20	0.90	EKHS501VSN121MR25S
	680	35 × 45	0.20	2.16	EKHS451VSN681MA45S		150	22 × 45	0.20	1.01	EKHS501VSN151MP45S
	680	35 × 50	0.20	2.22	EKHS451VSN681MA50S		150	25.4 × 35	0.20	1.04	EKHS501VSN151MQ35S
	820	30 × 60	0.20	2.56	EKHS451VSN821MR60S		180	22 × 50	0.20	1.13	EKHS501VSN181MP50S
	820	35 × 55	0.20	2.47	EKHS451VSN821MA55S		180	25.4 × 40	0.20	1.16	EKHS501VSN181MQ40S
1,000	35 × 60	0.20	2.78	EKHS451VSN102MA60S	180	25.4 × 45	0.20	1.18	EKHS501VSN181MQ45S		
475	100	22 × 25	0.20	0.76	EKHS4H1VSN101MP25S	180	30 × 30	0.20	1.11	EKHS501VSN181MR30S	
	130	22 × 30	0.20	0.90	EKHS4H1VSN131MP30S	180	35 × 25	0.20	1.08	EKHS501VSN181MA25S	
	140	25.4 × 25	0.20	0.91	EKHS4H1VSN141MQ25S	220	22 × 60	0.20	1.31	EKHS501VSN221MP60S	
	160	22 × 35	0.20	1.03	EKHS4H1VSN161MP35S	220	25.4 × 50	0.20	1.33	EKHS501VSN221MQ50S	
	180	25.4 × 30	0.20	1.06	EKHS4H1VSN181MQ30S	220	30 × 35	0.20	1.26	EKHS501VSN221MR35S	
	190	22 × 40	0.20	1.14	EKHS4H1VSN191MP40S	220	35 × 30	0.20	1.22	EKHS501VSN221MA30S	
	200	30 × 25	0.20	1.15	EKHS4H1VSN201MR25S	270	25.4 × 60	0.20	1.51	EKHS501VSN271MQ60S	
	220	22 × 45	0.20	1.25	EKHS4H1VSN221MP45S	270	30 × 40	0.20	1.44	EKHS501VSN271MR40S	
	230	25.4 × 35	0.20	1.25	EKHS4H1VSN231MQ35S	270	30 × 45	0.20	1.47	EKHS501VSN271MR45S	
	250	22 × 50	0.20	1.37	EKHS4H1VSN251MP50S	270	35 × 35	0.20	1.37	EKHS501VSN271MA35S	
	270	25.4 × 40	0.20	1.38	EKHS4H1VSN271MQ40S	330	30 × 50	0.20	1.66	EKHS501VSN331MR50S	
	270	30 × 30	0.20	1.35	EKHS4H1VSN271MR30S	330	35 × 40	0.20	1.57	EKHS501VSN331MA40S	
	270	35 × 25	0.20	1.33	EKHS4H1VSN271MA25S	390	30 × 60	0.20	1.87	EKHS501VSN391MR60S	
	290	22 × 55	0.20	1.50	EKHS4H1VSN291MP55S	390	35 × 45	0.20	1.74	EKHS501VSN391MA45S	
	310	25.4 × 45	0.20	1.51	EKHS4H1VSN311MQ45S	470	35 × 50	0.20	1.95	EKHS501VSN471MA50S	
	320	22 × 60	0.20	1.60	EKHS4H1VSN321MP60S	560	35 × 60	0.20	2.22	EKHS501VSN561MA60S	

◆RATED RIPPLE CURRENT MULTIPLIERS

●Frequency Multipliers

Frequency(Hz)	50	120	300	1k	10k	50k
450V _{dc}	0.77	1.00	1.16	1.30	1.41	1.43
475V _{dc}	0.77	1.00	1.11	1.20	1.25	1.33
500V _{dc}	0.70	1.00	1.16	1.30	1.41	1.43

The deterioration of aluminum electrolytic capacitors accelerates their life due to the internal heating produced by ripple current. For details, refer to Section "5-3 Ripple Current Effect on Lifetime" in the catalog, Technical Note.

KMS Series

- The lower temperature range of the category temperature range has been expanded.
- For solar power generation
- Endurance with ripple current : 105°C 3,000 hours
- Rated voltage range : 160 to 600V
- Capacitance range : 47 to 3,300μF
- Non solvent resistant type
- RoHS2 Compliant

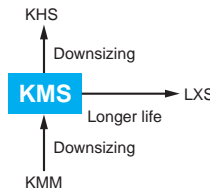

600V Lineup!



◆ SPECIFICATIONS

Items	Characteristics		
Category Temperature Range	-40 to +105°C(160 to 500V _{dc}) -25 to +105°C(550 to 600V _{dc})		
Rated Voltage Range	160 to 600V _{dc}		
Capacitance Tolerance	±20% (M) (at 20°C, 120Hz)		
Leakage Current	I ≤ 3√CV Where, I : Max. leakage current (μA), C : Nominal capacitance (μF), V : Rated voltage (V) (at 20°C after 5 minutes)		
Dissipation Factor (tan δ)	Rated voltage (V _{dc})	160 to 400V	420 to 600V
	tan δ (Max.)	0.15	0.20
Low Temperature Characteristics (Max. Impedance Ratio)	Rated voltage (V _{dc})	160 to 400V	420 to 600V
	Z(-25°C)/Z(+20°C)	4	8
Endurance	The following specifications shall be satisfied when the capacitors are restored to 20°C after subjected to DC voltage with the rated ripple current is applied (the peak voltage shall not exceed the rated voltage) for 3,000 hours at 105°C.		
	Capacitance change	≤ ±20% of the initial value	
	D.F. (tan δ)	≤ 200% of the initial specified value (600V _{dc} : ≤ 300%)	
	Leakage current	≤ The initial specified value	
Shelf Life	The following specifications shall be satisfied when the capacitors are restored to 20°C after exposing them for 1,000 hours at 105°C without voltage applied. Before the measurement, the capacitor shall be preconditioned by applying voltage according to Item 4.1 of JIS C 5101-4.		
	Capacitance change	≤ ±15% of the initial value	
	D.F. (tan δ)	≤ 150% of the initial specified value	
	Leakage current	≤ The initial specified value	

◆ DIMENSIONS [mm]

● Terminal Code : VS (φ22 to φ35) : Standard

● Terminal Code : LI (φ35)

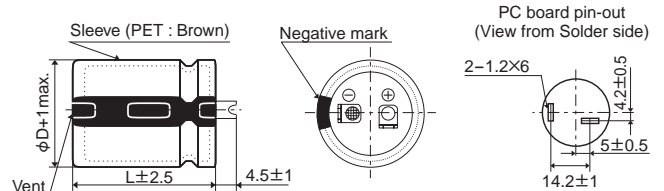
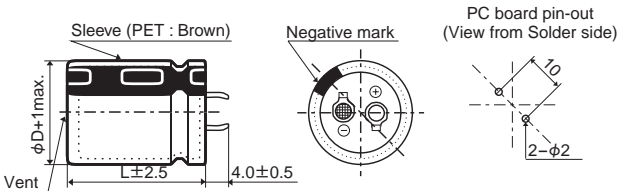

The standard design has no plastic disc.

◆ PART NUMBERING SYSTEM

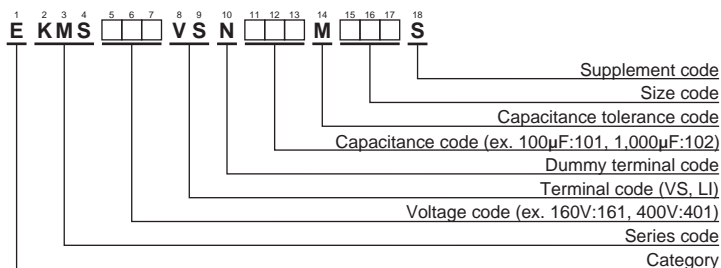

Please refer to "Product code guide (snap-in type)"

◆ STANDARD RATINGS

WV (V _{dc})	Cap (μF)	Case size φD×L(mm)	tan δ	Rated ripple current (Arms/105°C, 120Hz)	Part No.	WV (V _{dc})	Cap (μF)	Case size φD×L(mm)	tan δ	Rated ripple current (Arms/105°C, 120Hz)	Part No.
160	470	22 × 25	0.15	1.47	EKMS161VSN471MP25S	200	1,800	30 × 45	0.15	3.66	EKMS201VSN182MR45S
	680	22 × 30	0.15	1.86	EKMS161VSN681MP30S		1,800	30 × 50	0.15	3.72	EKMS201VSN182MR50S
	680	25.4 × 25	0.15	1.84	EKMS161VSN681MQ25S		1,800	35 × 40	0.15	3.81	EKMS201VSN182MA40S
	820	22 × 35	0.15	2.09	EKMS161VSN821MP35S		2,200	35 × 45	0.15	4.32	EKMS201VSN222MA45S
	820	25.4 × 30	0.15	2.08	EKMS161VSN821MQ30S		2,700	35 × 50	0.15	4.88	EKMS201VSN272MA50S
	1,000	22 × 40	0.15	2.35	EKMS161VSN102MP40S		250	270	22 × 25	0.15	1.11
	1,000	22 × 45	0.15	2.40	EKMS161VSN102MP45S	330		22 × 30	0.15	1.29	EKMS251VSN331MP30S
	1,000	25.4 × 35	0.15	2.40	EKMS161VSN102MQ35S	390		22 × 35	0.15	1.44	EKMS251VSN391MP35S
	1,000	30 × 25	0.15	2.50	EKMS161VSN102MR25S	390		25.4 × 25	0.15	1.40	EKMS251VSN391MQ25S
	1,200	22 × 50	0.15	2.69	EKMS161VSN122MP50S	470		22 × 40	0.15	1.61	EKMS251VSN471MP40S
	1,200	25.4 × 40	0.15	2.68	EKMS161VSN122MQ40S	470		25.4 × 30	0.15	1.57	EKMS251VSN471MQ30S
	1,200	30 × 30	0.15	2.77	EKMS161VSN122MR30S	560		22 × 45	0.15	1.79	EKMS251VSN561MP45S
	1,200	35 × 25	0.15	2.91	EKMS161VSN122MA25S	560		25.4 × 35	0.15	1.79	EKMS251VSN561MQ35S
	1,500	25.4 × 45	0.15	3.05	EKMS161VSN152MQ45S	560		30 × 25	0.15	1.87	EKMS251VSN561MR25S
	1,500	30 × 35	0.15	3.17	EKMS161VSN152MR35S	680		22 × 50	0.15	2.02	EKMS251VSN681MP50S
	1,800	25.4 × 50	0.15	3.40	EKMS161VSN182MQ50S	680		25.4 × 40	0.15	2.02	EKMS251VSN681MQ40S
	1,800	30 × 40	0.15	3.57	EKMS161VSN182MR40S	680		30 × 30	0.15	2.08	EKMS251VSN681MR30S
	1,800	35 × 30	0.15	3.62	EKMS161VSN182MA30S	680		35 × 25	0.15	2.19	EKMS251VSN681MA25S
	2,200	30 × 45	0.15	4.05	EKMS161VSN222MR45S	820		25.4 × 45	0.15	2.26	EKMS251VSN821MQ45S
	2,200	35 × 35	0.15	4.07	EKMS161VSN222MA35S	820		30 × 35	0.15	2.34	EKMS251VSN821MR35S
	2,700	30 × 50	0.15	4.56	EKMS161VSN272MR50S	1,000	25.4 × 50	0.15	2.53	EKMS251VSN102MQ50S	
2,700	35 × 40	0.15	4.67	EKMS161VSN272MA40S	1,000	30 × 40	0.15	2.66	EKMS251VSN102MR40S		
2,700	35 × 45	0.15	4.78	EKMS161VSN272MA45S	1,000	35 × 30	0.15	2.70	EKMS251VSN102MA30S		
3,300	35 × 50	0.15	5.40	EKMS161VSN332MA50S	1,200	30 × 45	0.15	2.99	EKMS251VSN122MR45S		
180	390	22 × 25	0.15	1.34	EKMS181VSN391MP25S	1,200	30 × 50	0.15	3.04	EKMS251VSN122MR50S	
	560	22 × 30	0.15	1.68	EKMS181VSN561MP30S	1,200	35 × 35	0.15	3.00	EKMS251VSN122MA35S	
	560	25.4 × 25	0.15	1.67	EKMS181VSN561MQ25S	1,500	35 × 40	0.15	3.48	EKMS251VSN152MA40S	
	680	22 × 35	0.15	1.90	EKMS181VSN681MP35S	1,500	35 × 45	0.15	3.56	EKMS251VSN152MA45S	
	820	22 × 40	0.15	2.13	EKMS181VSN821MP40S	1,800	35 × 50	0.15	3.98	EKMS251VSN182MA50S	
	820	25.4 × 30	0.15	2.08	EKMS181VSN821MQ30S	315	180	22 × 25	0.15	0.95	EKMS3B1VSN181MP25S
	820	30 × 25	0.15	2.26	EKMS181VSN821MR25S		220	22 × 30	0.15	1.10	EKMS3B1VSN221MP30S
	1,000	22 × 45	0.15	2.40	EKMS181VSN102MP45S		220	25.4 × 25	0.15	1.10	EKMS3B1VSN221MQ25S
	1,000	22 × 50	0.15	2.45	EKMS181VSN102MP50S		270	22 × 35	0.15	1.24	EKMS3B1VSN271MP35S
	1,000	25.4 × 35	0.15	2.40	EKMS181VSN102MQ35S		330	22 × 40	0.15	1.40	EKMS3B1VSN331MP40S
	1,000	25.4 × 40	0.15	2.45	EKMS181VSN102MQ40S		330	25.4 × 30	0.15	1.38	EKMS3B1VSN331MQ30S
	1,000	30 × 30	0.15	2.52	EKMS181VSN102MR30S		330	30 × 25	0.15	1.43	EKMS3B1VSN331MR25S
	1,200	25.4 × 45	0.15	2.73	EKMS181VSN122MQ45S		390	22 × 45	0.15	1.56	EKMS3B1VSN391MP45S
	1,200	30 × 35	0.15	2.83	EKMS181VSN122MR35S		390	22 × 50	0.15	1.59	EKMS3B1VSN391MP50S
	1,200	35 × 25	0.15	2.91	EKMS181VSN122MA25S		390	25.4 × 35	0.15	1.57	EKMS3B1VSN391MQ35S
	1,500	25.4 × 50	0.15	3.10	EKMS181VSN152MQ50S		470	25.4 × 40	0.15	1.76	EKMS3B1VSN471MQ40S
	1,500	30 × 40	0.15	3.26	EKMS181VSN152MR40S		470	30 × 30	0.15	1.73	EKMS3B1VSN471MR30S
	1,500	35 × 30	0.15	3.31	EKMS181VSN152MA30S		470	35 × 25	0.15	1.82	EKMS3B1VSN471MA25S
	1,800	30 × 45	0.15	3.66	EKMS181VSN182MR45S		560	25.4 × 45	0.15	1.96	EKMS3B1VSN561MQ45S
	1,800	35 × 35	0.15	3.68	EKMS181VSN182MA35S		560	25.4 × 50	0.15	1.99	EKMS3B1VSN561MQ50S
	2,200	30 × 50	0.15	4.11	EKMS181VSN222MR50S	560	30 × 35	0.15	1.93	EKMS3B1VSN561MR35S	
2,200	35 × 40	0.15	4.22	EKMS181VSN222MA40S	560	35 × 30	0.15	2.02	EKMS3B1VSN561MA30S		
2,700	35 × 45	0.15	4.78	EKMS181VSN272MA45S	680	30 × 40	0.15	2.19	EKMS3B1VSN681MR40S		
2,700	35 × 50	0.15	4.88	EKMS181VSN272MA50S	680	35 × 35	0.15	2.26	EKMS3B1VSN681MA35S		
200	390	22 × 25	0.15	1.34	EKMS201VSN391MP25S	820	30 × 45	0.15	2.47	EKMS3B1VSN821MR45S	
	470	22 × 30	0.15	1.54	EKMS201VSN471MP30S	820	30 × 50	0.15	2.51	EKMS3B1VSN821MR50S	
	560	22 × 35	0.15	1.72	EKMS201VSN561MP35S	820	35 × 40	0.15	2.57	EKMS3B1VSN821MA40S	
	560	25.4 × 25	0.15	1.67	EKMS201VSN561MQ25S	1,000	35 × 45	0.15	2.91	EKMS3B1VSN102MA45S	
	680	22 × 40	0.15	1.94	EKMS201VSN681MP40S	1,200	35 × 50	0.15	3.25	EKMS3B1VSN122MA50S	
	680	25.4 × 30	0.15	1.89	EKMS201VSN681MQ30S	400	120	22 × 25	0.15	0.77	EKMS401VSN121MP25S
	820	22 × 45	0.15	2.17	EKMS201VSN821MP45S		150	22 × 30	0.15	0.90	EKMS401VSN151MP30S
	820	25.4 × 35	0.15	2.17	EKMS201VSN821MQ35S		180	22 × 35	0.15	1.02	EKMS401VSN181MP35S
	820	30 × 25	0.15	2.26	EKMS201VSN821MR25S		180	25.4 × 25	0.15	0.99	EKMS401VSN181MQ25S
	1,000	22 × 50	0.15	2.45	EKMS201VSN102MP50S		220	22 × 40	0.15	1.15	EKMS401VSN221MP40S
	1,000	25.4 × 40	0.15	2.45	EKMS201VSN102MQ40S		220	25.4 × 30	0.15	1.13	EKMS401VSN221MQ30S
	1,000	30 × 30	0.15	2.52	EKMS201VSN102MR30S		270	22 × 45	0.15	1.29	EKMS401VSN271MP45S
	1,000	35 × 25	0.15	2.66	EKMS201VSN102MA25S		270	25.4 × 35	0.15	1.30	EKMS401VSN271MQ35S
	1,200	25.4 × 45	0.15	2.73	EKMS201VSN122MQ45S		270	30 × 25	0.15	1.29	EKMS401VSN271MR25S
	1,200	25.4 × 50	0.15	2.78	EKMS201VSN122MQ50S		330	22 × 50	0.15	1.47	EKMS401VSN331MP50S
	1,200	30 × 35	0.15	2.83	EKMS201VSN122MR35S		330	25.4 × 40	0.15	1.47	EKMS401VSN331MQ40S
	1,200	35 × 30	0.15	2.96	EKMS201VSN122MA30S		330	30 × 30	0.15	1.45	EKMS401VSN331MR30S
	1,500	30 × 40	0.15	3.26	EKMS201VSN152MR40S		330	35 × 25	0.15	1.52	EKMS401VSN331MA25S
	1,500	35 × 35	0.15	3.36	EKMS201VSN152MA35S		390	25.4 × 45	0.15	1.63	EKMS401VSN391MQ45S

◆STANDARD RATINGS

WV (V _{dc})	Cap (μF)	Case size φD×L(mm)	tan δ	Rated ripple current (Arms/105°C, 120Hz)	Part No.	WV (V _{dc})	Cap (μF)	Case size φD×L(mm)	tan δ	Rated ripple current (Arms/105°C, 120Hz)	Part No.
400	390	25.4 × 50	0.15	1.66	EKMS401VSN391MQ50S	500	47	22 × 25	0.20	0.51	EKMS501VSN470MP25S
	390	30 × 35	0.15	1.61	EKMS401VSN391MR35S		56	22 × 30	0.20	0.58	EKMS501VSN560MP30S
	470	30 × 40	0.15	1.82	EKMS401VSN471MR40S		68	25.4 × 25	0.20	0.65	EKMS501VSN680MQ25S
	470	35 × 30	0.15	1.85	EKMS401VSN471MA30S		82	22 × 35	0.20	0.72	EKMS501VSN820MP35S
	560	30 × 45	0.15	2.04	EKMS401VSN561MR45S		82	25.4 × 30	0.20	0.74	EKMS501VSN820MQ30S
	560	30 × 50	0.15	2.07	EKMS401VSN561MR50S		100	22 × 45	0.20	0.83	EKMS501VSN101MP45S
	560	35 × 35	0.15	2.05	EKMS401VSN561MA35S		100	30 × 25	0.20	0.82	EKMS501VSN101MR25S
	680	35 × 40	0.15	2.34	EKMS401VSN681MA40S		120	22 × 50	0.20	0.93	EKMS501VSN121MP50S
	680	35 × 45	0.15	2.40	EKMS401VSN681MA45S		120	25.4 × 35	0.20	0.93	EKMS501VSN121MQ35S
	820	35 × 50	0.15	2.69	EKMS401VSN821MA50S		120	30 × 30	0.20	0.91	EKMS501VSN121MR30S
420	100	22 × 25	0.20	0.70	EKMS421VSN121MP25S	150	25.4 × 45	0.20	1.08	EKMS501VSN151MQ45S	
	120	22 × 30	0.20	0.81	EKMS421VSN121MP30S	150	30 × 35	0.20	1.04	EKMS501VSN151MR35S	
	120	25.4 × 25	0.20	0.81	EKMS421VSN121MQ25S	150	35 × 25	0.20	0.99	EKMS501VSN151MA25S	
	150	22 × 35	0.20	0.93	EKMS421VSN151MP35S	180	25.4 × 50	0.20	1.20	EKMS501VSN181MQ50S	
	180	22 × 40	0.20	1.04	EKMS421VSN181MP40S	180	30 × 40	0.20	1.17	EKMS501VSN181MR40S	
	180	25.4 × 30	0.20	1.02	EKMS421VSN181MQ30S	180	35 × 30	0.20	1.10	EKMS501VSN181MA30S	
	180	30 × 25	0.20	1.06	EKMS421VSN181MR25S	220	30 × 45	0.20	1.33	EKMS501VSN221MR45S	
	220	22 × 45	0.20	1.17	EKMS421VSN221MP45S	220	35 × 35	0.20	1.23	EKMS501VSN221MA35S	
	220	22 × 50	0.20	1.20	EKMS421VSN221MP50S	270	30 × 50	0.20	1.50	EKMS501VSN271MR50S	
	220	25.4 × 35	0.20	1.18	EKMS421VSN221MQ35S	270	35 × 40	0.20	1.42	EKMS501VSN271MA40S	
	220	30 × 30	0.20	1.18	EKMS421VSN221MR30S	330	35 × 45	0.20	1.60	EKMS501VSN331MA45S	
	270	25.4 × 40	0.20	1.33	EKMS421VSN271MQ40S	390	35 × 50	0.20	1.78	EKMS501VSN391MA50S	
	270	25.4 × 45	0.20	1.36	EKMS421VSN271MQ45S	470	35 × 60	0.20	2.03	EKMS501VSN471MA60S	
	270	35 × 25	0.20	1.38	EKMS421VSN271MA25S	550	82	22 × 35	0.20	0.72	EKMS551VSN820MP35S
	330	25.4 × 50	0.20	1.52	EKMS421VSN331MQ50S		82	25.4 × 30	0.20	0.74	EKMS551VSN820MQ30S
	330	30 × 35	0.20	1.48	EKMS421VSN331MR35S		100	22 × 45	0.20	0.83	EKMS551VSN101MP45S
	330	30 × 40	0.20	1.52	EKMS421VSN331MR40S		100	25.4 × 35	0.20	0.85	EKMS551VSN101MQ35S
	330	35 × 30	0.20	1.55	EKMS421VSN331MA30S		100	30 × 25	0.20	0.82	EKMS551VSN101MR25S
	390	30 × 45	0.20	1.70	EKMS421VSN391MR45S		120	22 × 50	0.20	0.93	EKMS551VSN121MP50S
	390	35 × 35	0.20	1.71	EKMS421VSN391MA35S		120	25.4 × 40	0.20	0.95	EKMS551VSN121MQ40S
470	30 × 50	0.20	1.90	EKMS421VSN471MR50S	120		30 × 30	0.20	0.91	EKMS551VSN121MR30S	
470	35 × 40	0.20	1.95	EKMS421VSN471MA40S	120		35 × 25	0.20	0.88	EKMS551VSN121MA25S	
560	35 × 45	0.20	2.17	EKMS421VSN561MA45S	150		25.4 × 45	0.20	1.08	EKMS551VSN151MQ45S	
680	35 × 50	0.20	2.45	EKMS421VSN681MA50S	150		30 × 35	0.20	1.04	EKMS551VSN151MR35S	
450	82	22 × 25	0.20	0.64	EKMS451VSN820MP25S		180	25.4 × 50	0.20	1.20	EKMS551VSN181MQ50S
	120	22 × 30	0.20	0.81	EKMS451VSN121MP30S		180	30 × 40	0.20	1.17	EKMS551VSN181MR40S
	120	22 × 35	0.20	0.83	EKMS451VSN121MP35S		180	35 × 30	0.20	1.10	EKMS551VSN181MA30S
	120	25.4 × 25	0.20	0.81	EKMS451VSN121MQ25S		220	30 × 45	0.20	1.33	EKMS551VSN221MR45S
	150	22 × 40	0.20	0.94	EKMS451VSN151MP40S		220	35 × 35	0.20	1.23	EKMS551VSN221MA35S
	150	25.4 × 30	0.20	0.93	EKMS451VSN151MQ30S		270	30 × 50	0.20	1.50	EKMS551VSN271MR50S
	180	22 × 45	0.20	1.06	EKMS451VSN181MP45S		270	35 × 40	0.20	1.42	EKMS551VSN271MA40S
	180	25.4 × 35	0.20	1.06	EKMS451VSN181MQ35S		330	35 × 45	0.20	1.60	EKMS551VSN331MA45S
	180	30 × 25	0.20	1.06	EKMS451VSN181MR25S		330	35 × 50	0.20	1.64	EKMS551VSN331MA50S
	220	22 × 50	0.20	1.20	EKMS451VSN221MP50S	470	35 × 60	0.20	2.03	EKMS551VSN471MA60S	
	220	25.4 × 40	0.20	1.20	EKMS451VSN221MQ40S	600	100	30 × 30	0.20	0.83	EKMS601VSN101MR30S
	220	30 × 30	0.20	1.18	EKMS451VSN221MR30S		100	35 × 25	0.20	0.85	EKMS601VSN101MA25S
	220	35 × 25	0.20	1.24	EKMS451VSN221MA25S		120	30 × 35	0.20	0.93	EKMS601VSN121MR35S
	270	25.4 × 45	0.20	1.36	EKMS451VSN271MQ45S		150	30 × 40	0.20	1.07	EKMS601VSN151MR40S
	270	25.4 × 50	0.20	1.38	EKMS451VSN271MQ50S		150	35 × 30	0.20	1.06	EKMS601VSN151MA30S
	270	30 × 35	0.20	1.34	EKMS451VSN271MR35S		180	30 × 45	0.20	1.20	EKMS601VSN181MR45S
	270	35 × 30	0.20	1.40	EKMS451VSN271MA30S		180	30 × 50	0.20	1.22	EKMS601VSN181MR50S
	330	30 × 40	0.20	1.52	EKMS451VSN331MR40S		180	35 × 35	0.20	1.18	EKMS601VSN181MA35S
	390	30 × 45	0.20	1.70	EKMS451VSN391MR45S		220	30 × 60	0.20	1.40	EKMS601VSN221MR60S
	390	30 × 50	0.20	1.73	EKMS451VSN391MR50S		220	35 × 40	0.20	1.35	EKMS601VSN221MA40S
390	35 × 35	0.20	1.71	EKMS451VSN391MA35S	220	35 × 45	0.20	1.38	EKMS601VSN221MA45S		
470	35 × 40	0.20	1.95	EKMS451VSN471MA40S	270	35 × 50	0.20	1.56	EKMS601VSN271MA50S		
470	35 × 45	0.20	1.99	EKMS451VSN471MA45S	330	35 × 60	0.20	1.79	EKMS601VSN331MA60S		
560	35 × 50	0.20	2.22	EKMS451VSN561MA50S							

◆RATED RIPPLE CURRENT MULTIPLIERS

●Frequency Multipliers

Frequency(Hz)	50	120	300	1k	10k	50k
160 to 250V _{dc}	0.81	1.00	1.17	1.32	1.45	1.50
315 to 450V _{dc}	0.77	1.00	1.16	1.30	1.41	1.43
500 to 600V _{dc}	0.70	1.00	1.16	1.30	1.41	1.43

The deterioration of aluminum electrolytic capacitors accelerates their life due to the internal heating produced by ripple current. For details, refer to Section "5-3 Ripple Current Effect on Lifetime" in the catalog, Technical Note.

KMM Series

- Longer life from KMQ series
- Endurance with ripple current : 2,000 to 3,000 hours at 105°C
- Non solvent resistant type
- RoHS2 Compliant

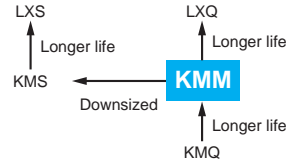

SPECIFICATIONS

Items	Characteristics		
Category	-25 to +105°C		
Temperature Range	-25 to +105°C		
Rated Voltage Range	160 to 450V _{dc}		
Capacitance Tolerance	±20% (M) (at 20°C, 120Hz)		
Leakage Current	I ≤ 3√CV Where, I : Max. leakage current (µA), C : Nominal capacitance (µF), V : Rated voltage (V) (at 20°C after 5 minutes)		
Dissipation Factor (tan δ)	Rated voltage (V _{dc})	160 to 400V	420 & 450V
	tan δ (Max.)	0.15	0.20
Low Temperature Characteristics (Max. Impedance Ratio)	Rated voltage (V _{dc})	160 to 400V	420 & 450V
	Z(-25°C)/Z(+20°C)	4	8
Endurance	The following specifications shall be satisfied when the capacitors are restored to 20°C after subjected to DC voltage with the rated ripple current is applied (the peak voltage shall not exceed the rated voltage) for 3,000 hours at 105°C.		
	Capacitance change	≤ ±20% of the initial value	
	D.F. (tan δ)	≤ 200% of the initial specified value	
	Leakage current	≤ The initial specified value	
Shelf Life	The following specifications shall be satisfied when the capacitors are restored to 20°C after exposing them for 1,000 hours at 105°C without voltage applied. Before the measurement, the capacitor shall be preconditioned by applying voltage according to Item 4.1 of JIS C 5101-4.		
	Capacitance change	≤ ±15% of the initial value	
	D.F. (tan δ)	≤ 150% of the initial specified value	
	Leakage current	≤ The initial specified value	

DIMENSIONS [mm]

● Terminal Code : VS (φ 22 to φ 35) : Standard

● Terminal Code : LI (φ 30, φ 35)

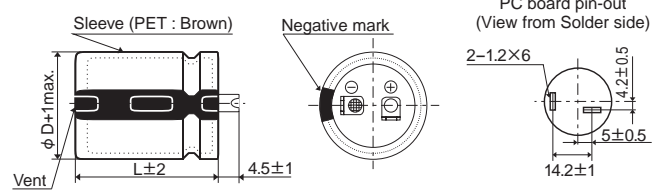
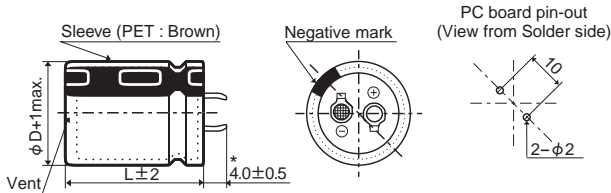

* φD=35mm : 3.5±0.5mm

The standard design has no plastic disc.

PART NUMBERING SYSTEM

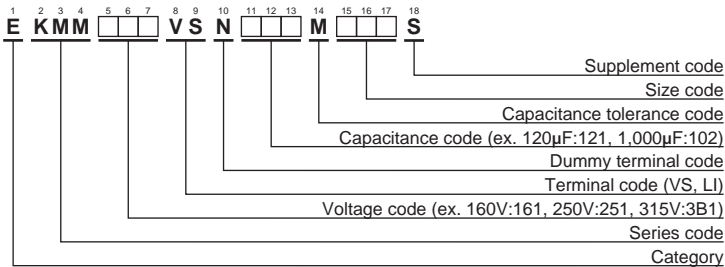

Please refer to "Product code guide (snap-in type)"

◆ STANDARD RATINGS

WV (V _{dc})	Cap (μF)	Case size φD×L(mm)	tan δ	Rated ripple current (Arms/105°C, 120Hz)	Part No.	WV (V _{dc})	Cap (μF)	Case size φD×L(mm)	tan δ	Rated ripple current (Arms/105°C, 120Hz)	Part No.	
160	220	22 × 20	0.15	0.81	EKMM161VSN221MP20S	180	1,200	25.4 × 50	0.15	2.55	EKMM181VSN122MQ50S	
	270	25.4 × 20	0.15	0.98	EKMM161VSN271MQ20S		1,200	30 × 40	0.15	2.55	EKMM181VSN122MR40S	
	330	22 × 25	0.15	1.20	EKMM161VSN331MP25S		1,200	35 × 30	0.15	2.55	EKMM181VSN122MA30S	
	330	25.4 × 20	0.15	1.02	EKMM161VSN331MQ20S		1,500	30 × 45	0.15	2.90	EKMM181VSN152MR45S	
	390	22 × 25	0.15	1.30	EKMM161VSN391MP25S		1,500	35 × 35	0.15	2.90	EKMM181VSN152MA35S	
	390	25.4 × 25	0.15	1.26	EKMM161VSN391MQ25S		1,800	30 × 60	0.15	3.49	EKMM181VSN182MR60S	
	390	30 × 20	0.15	1.25	EKMM161VSN391MR20S		1,800	35 × 40	0.15	3.30	EKMM181VSN182MA40S	
	470	22 × 30	0.15	1.55	EKMM161VSN471MP30S		2,200	35 × 50	0.15	3.65	EKMM181VSN222MA50S	
	470	25.4 × 25	0.15	1.55	EKMM161VSN471MQ25S		2,700	35 × 60	0.15	4.19	EKMM181VSN272MA60S	
	470	30 × 20	0.15	1.30	EKMM161VSN471MR20S		200	150	22 × 20	0.15	0.73	EKMM201VSN151MP20S
	560	22 × 35	0.15	1.67	EKMM161VSN561MP35S			180	22 × 20	0.15	0.80	EKMM201VSN181MP20S
	560	25.4 × 30	0.15	1.67	EKMM161VSN561MQ30S			220	25.4 × 20	0.15	0.85	EKMM201VSN221MQ20S
	560	30 × 25	0.15	1.67	EKMM161VSN561MR25S	270		22 × 25	0.15	1.10	EKMM201VSN271MP25S	
	560	35 × 20	0.15	1.46	EKMM161VSN561MA20S	270		30 × 20	0.15	1.05	EKMM201VSN271MR20S	
	680	22 × 40	0.15	1.82	EKMM161VSN681MP40S	330		22 × 30	0.15	1.25	EKMM201VSN331MP30S	
	680	25.4 × 30	0.15	1.82	EKMM161VSN681MQ30S	330		25.4 × 25	0.15	1.25	EKMM201VSN331MQ25S	
	680	30 × 25	0.15	1.82	EKMM161VSN681MR25S	330		30 × 20	0.15	1.10	EKMM201VSN331MR20S	
	680	35 × 20	0.15	1.51	EKMM161VSN681MA20S	390		22 × 30	0.15	1.35	EKMM201VSN391MP30S	
	820	22 × 45	0.15	2.04	EKMM161VSN821MP45S	390		25.4 × 25	0.15	1.35	EKMM201VSN391MQ25S	
	820	25.4 × 35	0.15	2.04	EKMM161VSN821MQ35S	390		35 × 20	0.15	1.30	EKMM201VSN391MA20S	
	820	30 × 30	0.15	2.04	EKMM161VSN821MR30S	470		22 × 35	0.15	1.50	EKMM201VSN471MP35S	
	820	35 × 25	0.15	2.04	EKMM161VSN821MA25S	470		25.4 × 30	0.15	1.50	EKMM201VSN471MQ30S	
	1,000	22 × 50	0.15	2.25	EKMM161VSN102MP50S	470		30 × 25	0.15	1.50	EKMM201VSN471MR25S	
	1,000	25.4 × 40	0.15	2.25	EKMM161VSN102MQ40S	470		35 × 20	0.15	1.41	EKMM201VSN471MA20S	
	1,000	30 × 30	0.15	2.25	EKMM161VSN102MR30S	560		22 × 40	0.15	1.67	EKMM201VSN561MP40S	
	1,000	35 × 25	0.15	2.25	EKMM161VSN102MA25S	560		25.4 × 30	0.15	1.67	EKMM201VSN561MQ30S	
	1,200	25.4 × 45	0.15	2.49	EKMM161VSN122MQ45S	560		30 × 25	0.15	1.67	EKMM201VSN561MR25S	
	1,200	30 × 35	0.15	2.49	EKMM161VSN122MR35S	680	22 × 45	0.15	1.78	EKMM201VSN681MP45S		
	1,200	35 × 30	0.15	2.49	EKMM161VSN122MA30S	680	25.4 × 35	0.15	1.78	EKMM201VSN681MQ35S		
	1,500	25.4 × 60	0.15	2.97	EKMM161VSN152MQ60S	680	30 × 30	0.15	1.78	EKMM201VSN681MR30S		
	1,500	30 × 40	0.15	2.84	EKMM161VSN152MR40S	680	35 × 25	0.15	1.78	EKMM201VSN681MA25S		
	1,500	35 × 30	0.15	2.84	EKMM161VSN152MA30S	820	25.4 × 45	0.15	2.04	EKMM201VSN821MQ45S		
	1,800	30 × 45	0.15	3.32	EKMM161VSN182MR45S	820	30 × 30	0.15	2.04	EKMM201VSN821MR30S		
1,800	35 × 35	0.15	3.00	EKMM161VSN182MA35S	820	35 × 25	0.15	2.04	EKMM201VSN821MA25S			
2,200	30 × 60	0.15	3.86	EKMM161VSN222MR60S	1,000	25.4 × 50	0.15	2.30	EKMM201VSN102MQ50S			
2,200	35 × 45	0.15	3.50	EKMM161VSN222MA45S	1,000	30 × 35	0.15	2.30	EKMM201VSN102MR35S			
2,700	35 × 50	0.15	4.00	EKMM161VSN272MA50S	1,000	35 × 30	0.15	2.30	EKMM201VSN102MA30S			
3,300	35 × 60	0.15	4.63	EKMM161VSN332MA60S	1,200	25.4 × 60	0.15	2.66	EKMM201VSN122MQ60S			
180	180	22 × 20	0.15	0.80	EKMM181VSN181MP20S	1,200	30 × 40	0.15	2.65	EKMM201VSN122MR40S		
	220	25.4 × 20	0.15	0.90	EKMM181VSN221MQ20S	1,200	35 × 35	0.15	2.65	EKMM201VSN122MA35S		
	270	22 × 25	0.15	1.00	EKMM181VSN271MP25S	1,500	30 × 50	0.15	3.08	EKMM201VSN152MR50S		
	270	25.4 × 20	0.15	0.95	EKMM181VSN271MQ20S	1,500	35 × 40	0.15	3.08	EKMM201VSN152MA40S		
	330	22 × 25	0.15	1.20	EKMM181VSN331MP25S	1,800	30 × 60	0.15	3.49	EKMM201VSN182MR60S		
	330	25.4 × 25	0.15	1.16	EKMM181VSN331MQ25S	1,800	35 × 45	0.15	3.48	EKMM201VSN182MA45S		
	330	30 × 20	0.15	1.15	EKMM181VSN331MR20S	2,200	35 × 50	0.15	3.78	EKMM201VSN222MA50S		
	390	22 × 30	0.15	1.35	EKMM181VSN391MP30S	220	150	22 × 20	0.15	0.67	EKMM221VSN151MP20S	
	390	25.4 × 25	0.15	1.35	EKMM181VSN391MQ25S		180	25.4 × 20	0.15	0.76	EKMM221VSN181MP20S	
	390	30 × 20	0.15	1.20	EKMM181VSN391MR20S		220	22 × 25	0.15	1.00	EKMM221VSN221MP25S	
	470	22 × 35	0.15	1.50	EKMM181VSN471MP35S		220	25.4 × 20	0.15	0.84	EKMM221VSN221MQ20S	
	470	25.4 × 30	0.15	1.50	EKMM181VSN471MQ30S		270	22 × 30	0.15	1.15	EKMM221VSN271MP30S	
	470	30 × 25	0.15	1.50	EKMM181VSN471MR25S		270	25.4 × 25	0.15	1.08	EKMM221VSN271MQ25S	
	470	35 × 20	0.15	1.36	EKMM181VSN471MA20S		270	30 × 20	0.15	0.98	EKMM221VSN271MR20S	
	560	22 × 40	0.15	1.67	EKMM181VSN561MP40S		330	22 × 35	0.15	1.25	EKMM221VSN331MP35S	
	560	25.4 × 30	0.15	1.67	EKMM181VSN561MQ30S		330	25.4 × 25	0.15	1.25	EKMM221VSN331MQ25S	
	560	30 × 25	0.15	1.67	EKMM181VSN561MR25S		330	35 × 20	0.15	1.13	EKMM221VSN331MA20S	
	560	35 × 20	0.15	1.43	EKMM181VSN561MA20S		390	22 × 35	0.15	1.40	EKMM221VSN391MP35S	
	680	22 × 45	0.15	1.78	EKMM181VSN681MP45S		390	25.4 × 30	0.15	1.40	EKMM221VSN391MQ30S	
	680	25.4 × 35	0.15	1.78	EKMM181VSN681MQ35S		390	30 × 25	0.15	1.36	EKMM221VSN391MR25S	
	680	30 × 30	0.15	1.78	EKMM181VSN681MR30S		390	35 × 20	0.15	1.23	EKMM221VSN391MA20S	
	680	35 × 25	0.15	1.83	EKMM181VSN681MA25S		470	22 × 40	0.15	1.51	EKMM221VSN471MP40S	
	820	22 × 50	0.15	2.04	EKMM181VSN821MP50S		470	25.4 × 35	0.15	1.54	EKMM221VSN471MQ35S	
	820	25.4 × 40	0.15	2.04	EKMM181VSN821MQ40S		470	30 × 25	0.15	1.50	EKMM221VSN471MR25S	
	820	30 × 30	0.15	2.04	EKMM181VSN821MR30S		560	22 × 45	0.15	1.70	EKMM221VSN561MP45S	
	820	35 × 25	0.15	2.04	EKMM181VSN821MA25S	560	25.4 × 40	0.15	1.72	EKMM221VSN561MQ40S		
	1,000	25.4 × 45	0.15	2.30	EKMM181VSN102MQ45S	560	30 × 30	0.15	1.70	EKMM221VSN561MR30S		
	1,000	30 × 35	0.15	2.30	EKMM181VSN102MR35S	560	35 × 25	0.15	1.71	EKMM221VSN561MA25S		
	1,000	35 × 30	0.15	2.30	EKMM181VSN102MA30S	680	25.4 × 45	0.15	1.94	EKMM221VSN681MQ45S		

◆ STANDARD RATINGS

WV (V _{dc})	Cap (μF)	Case size φD×L(mm)	tan δ	Rated ripple current (Arms/105°C, 120Hz)	Part No.	WV (V _{dc})	Cap (μF)	Case size φD×L(mm)	tan δ	Rated ripple current (Arms/105°C, 120Hz)	Part No.
220	680	30 × 35	0.15	1.93	EKMM221VSN681MR35S	315	220	25.4 × 30	0.15	1.04	EKMM3B1VSN221MQ30S
	680	35 × 25	0.15	1.89	EKMM221VSN681MA25S		220	30 × 25	0.15	1.04	EKMM3B1VSN221MR25S
	820	25.4 × 50	0.15	2.18	EKMM221VSN821MQ50S		220	35 × 20	0.15	0.90	EKMM3B1VSN221MA20S
	820	30 × 40	0.15	2.19	EKMM221VSN821MR40S		270	22 × 45	0.15	1.16	EKMM3B1VSN271MP45S
	820	35 × 30	0.15	2.16	EKMM221VSN821MA30S		270	25.4 × 35	0.15	1.16	EKMM3B1VSN271MQ35S
	1,000	25.4 × 60	0.15	2.54	EKMM221VSN102MQ60S		270	30 × 25	0.15	1.16	EKMM3B1VSN271MR25S
	1,000	30 × 45	0.15	2.50	EKMM221VSN102MR45S		270	35 × 25	0.15	1.15	EKMM3B1VSN271MA25S
	1,000	35 × 35	0.15	2.44	EKMM221VSN102MA35S		330	22 × 50	0.15	1.33	EKMM3B1VSN331MP50S
	1,200	30 × 50	0.15	2.81	EKMM221VSN122MR50S		330	25.4 × 40	0.15	1.33	EKMM3B1VSN331MQ40S
	1,200	35 × 40	0.15	2.79	EKMM221VSN122MA40S		330	30 × 30	0.15	1.33	EKMM3B1VSN331MR30S
	1,500	30 × 60	0.15	3.30	EKMM221VSN152MR60S		330	35 × 25	0.15	1.33	EKMM3B1VSN331MA25S
	1,500	35 × 45	0.15	3.22	EKMM221VSN152MA45S		390	25.4 × 45	0.15	1.47	EKMM3B1VSN391MQ45S
	1,800	35 × 50	0.15	3.63	EKMM221VSN182MA50S		390	30 × 35	0.15	1.47	EKMM3B1VSN391MR35S
	2,200	35 × 60	0.15	4.23	EKMM221VSN222MA60S		390	35 × 30	0.15	1.47	EKMM3B1VSN391MA30S
250	120	22 × 20	0.15	0.60	EKMM251VSN121MP20S	470	25.4 × 50	0.15	1.70	EKMM3B1VSN471MA25S	
	150	25.4 × 20	0.15	0.74	EKMM251VSN151MQ20S	470	30 × 40	0.15	1.70	EKMM3B1VSN471MR40S	
	180	22 × 25	0.15	0.78	EKMM251VSN181MP25S	470	35 × 30	0.15	1.70	EKMM3B1VSN471MA30S	
	180	25.4 × 20	0.15	0.75	EKMM251VSN181MQ20S	560	30 × 45	0.15	2.05	EKMM3B1VSN561MR45S	
	220	22 × 25	0.15	1.00	EKMM251VSN221MP25S	560	35 × 35	0.15	2.05	EKMM3B1VSN561MA35S	
	220	25.4 × 25	0.15	0.95	EKMM251VSN221MQ25S	680	30 × 50	0.15	2.17	EKMM3B1VSN681MR50S	
	220	30 × 20	0.15	0.95	EKMM251VSN221MR20S	680	35 × 40	0.15	2.17	EKMM3B1VSN681MA40S	
	270	22 × 30	0.15	1.18	EKMM251VSN271MP30S	820	35 × 45	0.15	2.20	EKMM3B1VSN821MA45S	
	270	25.4 × 25	0.15	1.18	EKMM251VSN271MQ25S	1,000	35 × 60	0.15	2.55	EKMM3B1VSN102MA60S	
	270	30 × 20	0.15	1.00	EKMM251VSN271MR20S	350	56	22 × 20	0.15	0.41	EKMM351VSN560MP20S
	330	22 × 35	0.15	1.30	EKMM251VSN331MP35S		68	25.4 × 20	0.15	0.46	EKMM351VSN680MQ20S
	330	25.4 × 30	0.15	1.30	EKMM251VSN331MQ30S		82	22 × 25	0.15	0.55	EKMM351VSN820MP25S
	330	30 × 25	0.15	1.30	EKMM251VSN331MR25S		82	25.4 × 20	0.15	0.51	EKMM351VSN820MQ20S
	330	35 × 20	0.15	1.16	EKMM251VSN331MA20S		100	22 × 25	0.15	0.69	EKMM351VSN101MP25S
	390	22 × 40	0.15	1.49	EKMM251VSN391MP40S		100	30 × 20	0.15	0.60	EKMM351VSN101MR20S
	390	25.4 × 35	0.15	1.49	EKMM251VSN391MQ35S		120	22 × 30	0.15	0.75	EKMM351VSN121MP30S
	390	30 × 25	0.15	1.49	EKMM251VSN391MR25S		120	25.4 × 25	0.15	0.75	EKMM351VSN121MQ25S
	470	22 × 45	0.15	1.65	EKMM251VSN471MP45S		120	30 × 20	0.15	0.65	EKMM351VSN121MR20S
	470	25.4 × 35	0.15	1.65	EKMM251VSN471MQ35S		150	22 × 35	0.15	0.82	EKMM351VSN151MP35S
	470	30 × 30	0.15	1.65	EKMM251VSN471MR30S		150	25.4 × 30	0.15	0.83	EKMM351VSN151MQ30S
	470	35 × 25	0.15	1.65	EKMM251VSN471MA25S		150	30 × 25	0.15	0.82	EKMM351VSN151MR25S
	560	22 × 50	0.15	1.67	EKMM251VSN561MP50S		150	35 × 20	0.15	0.76	EKMM351VSN151MA20S
	560	25.4 × 40	0.15	1.80	EKMM251VSN561MQ40S		180	22 × 40	0.15	0.92	EKMM351VSN181MP40S
	560	30 × 30	0.15	1.80	EKMM251VSN561MR30S		180	25.4 × 30	0.15	0.92	EKMM351VSN181MQ30S
	560	35 × 25	0.15	1.80	EKMM251VSN561MA25S		180	30 × 25	0.15	0.90	EKMM351VSN181MR25S
	680	25.4 × 50	0.15	2.00	EKMM251VSN681MQ50S		220	22 × 45	0.15	1.05	EKMM351VSN221MP45S
	680	30 × 35	0.15	2.00	EKMM251VSN681MR35S		220	25.4 × 35	0.15	1.04	EKMM351VSN221MQ35S
	680	35 × 30	0.15	2.00	EKMM251VSN681MA30S		220	30 × 30	0.15	1.02	EKMM351VSN221MR30S
820	25.4 × 60	0.15	2.20	EKMM251VSN821MQ60S	220		35 × 25	0.15	1.04	EKMM351VSN221MA25S	
820	30 × 40	0.15	2.30	EKMM251VSN821MR40S	270		22 × 50	0.15	1.16	EKMM351VSN271MP50S	
820	35 × 35	0.15	2.30	EKMM251VSN821MA35S	270		25.4 × 40	0.15	1.18	EKMM351VSN271MQ40S	
1,000	30 × 50	0.15	2.47	EKMM251VSN102MR50S	270		30 × 30	0.15	1.17	EKMM351VSN271MR30S	
1,000	35 × 40	0.15	2.47	EKMM251VSN102MA40S	270		35 × 25	0.15	1.20	EKMM351VSN271MA25S	
1,200	30 × 60	0.15	2.85	EKMM251VSN122MR60S	330		25.4 × 45	0.15	1.29	EKMM351VSN331MQ45S	
1,200	35 × 45	0.15	2.60	EKMM251VSN122MA45S	330		30 × 35	0.15	1.34	EKMM351VSN331MR35S	
1,500	35 × 50	0.15	3.00	EKMM251VSN152MA50S	330		35 × 30	0.15	1.22	EKMM351VSN331MA30S	
1,800	35 × 60	0.15	3.42	EKMM251VSN182MA60S	390		25.4 × 50	0.15	1.51	EKMM351VSN391MQ50S	
315	68	22 × 20	0.15	0.45	EKMM3B1VSN680MP20S	390	30 × 40	0.15	1.51	EKMM351VSN391MR40S	
	82	22 × 20	0.15	0.47	EKMM3B1VSN820MP20S	390	35 × 35	0.15	1.47	EKMM351VSN391MA35S	
	100	22 × 25	0.15	0.61	EKMM3B1VSN101MP25S	470	25.4 × 60	0.15	1.66	EKMM351VSN471MQ60S	
	100	25.4 × 20	0.15	0.56	EKMM3B1VSN101MQ20S	470	30 × 45	0.15	1.65	EKMM351VSN471MR45S	
	120	22 × 25	0.15	0.75	EKMM3B1VSN121MP25S	470	35 × 35	0.15	1.69	EKMM351VSN471MA35S	
	120	25.4 × 20	0.15	0.62	EKMM3B1VSN121MQ20S	560	30 × 50	0.15	1.85	EKMM351VSN561MR50S	
	120	30 × 20	0.15	0.65	EKMM3B1VSN121MR20S	560	35 × 40	0.15	1.90	EKMM351VSN561MA40S	
	150	22 × 30	0.15	0.82	EKMM3B1VSN151MP30S	680	30 × 60	0.15	2.15	EKMM351VSN681MR60S	
	150	25.4 × 25	0.15	0.82	EKMM3B1VSN151MQ25S	680	35 × 50	0.15	1.99	EKMM351VSN681MA50S	
	150	30 × 20	0.15	0.70	EKMM3B1VSN151MR20S	820	35 × 60	0.15	2.31	EKMM351VSN821MA60S	
	150	35 × 20	0.15	0.76	EKMM3B1VSN151MA20S	400	47	22 × 20	0.15	0.37	EKMM401VSN470MP20S
	180	22 × 35	0.15	0.92	EKMM3B1VSN181MP35S		56	25.4 × 20	0.15	0.42	EKMM401VSN560MQ20S
	180	25.4 × 25	0.15	0.92	EKMM3B1VSN181MQ25S		68	22 × 25	0.15	0.50	EKMM401VSN680MP25S
	180	30 × 25	0.15	0.90	EKMM3B1VSN181MR25S		68	25.4 × 20	0.15	0.46	EKMM401VSN680MQ20S
180	35 × 20	0.15	0.85	EKMM3B1VSN181MA20S	82		22 × 25	0.15	0.64	EKMM401VSN820MP25S	
220	22 × 40	0.15	1.04	EKMM3B1VSN221MP40S	82		30 × 20	0.15	0.55	EKMM401VSN820MR20S	

KMM Series

◆ STANDARD RATINGS

WV (V _{dc})	Cap (μF)	Case size φD×L(mm)	tan δ	Rated ripple current (Arms/105°C, 120Hz)	Part No.	WV (V _{dc})	Cap (μF)	Case size φD×L(mm)	tan δ	Rated ripple current (Arms/105°C, 120Hz)	Part No.	
400	100	22 × 30	0.15	0.70	EKMM401VSN101MP30S	420	180	25.4 × 35	0.20	0.95	EKMM421VSN181MQ35S	
	100	25.4 × 25	0.15	0.70	EKMM401VSN101MQ25S		180	30 × 30	0.20	0.95	EKMM421VSN181MR30S	
	100	30 × 20	0.15	0.60	EKMM401VSN101MR20S		180	35 × 25	0.20	0.94	EKMM421VSN181MA25S	
	120	22 × 35	0.15	0.75	EKMM401VSN121MP35S		220	22 × 50	0.20	1.10	EKMM421VSN221MP50S	
	120	25.4 × 25	0.15	0.75	EKMM401VSN121MQ25S		220	25.4 × 45	0.20	1.10	EKMM421VSN221MQ45S	
	120	30 × 25	0.15	0.73	EKMM401VSN121MR25S		220	30 × 35	0.20	1.10	EKMM421VSN221MR35S	
	120	35 × 20	0.15	0.75	EKMM401VSN121MA20S		220	35 × 25	0.20	1.10	EKMM421VSN221MA25S	
	150	22 × 40	0.15	0.88	EKMM401VSN151MP40S		270	25.4 × 50	0.20	1.22	EKMM421VSN271MQ50S	
	150	25.4 × 30	0.15	0.88	EKMM401VSN151MQ30S		270	30 × 40	0.20	1.22	EKMM421VSN271MR40S	
	150	30 × 25	0.15	0.88	EKMM401VSN151MR25S		270	35 × 30	0.20	1.22	EKMM421VSN271MA30S	
	150	35 × 20	0.15	0.80	EKMM401VSN151MA20S		330	25.4 × 60	0.20	1.41	EKMM421VSN331MQ60S	
	180	22 × 45	0.15	0.98	EKMM401VSN181MP45S		330	30 × 45	0.20	1.45	EKMM421VSN331MR45S	
	180	25.4 × 35	0.15	0.98	EKMM401VSN181MQ35S		330	35 × 35	0.20	1.45	EKMM421VSN331MA35S	
	180	30 × 30	0.15	0.98	EKMM401VSN181MR30S		390	30 × 50	0.20	1.55	EKMM421VSN391MR50S	
	180	35 × 25	0.15	0.98	EKMM401VSN181MA25S		390	35 × 40	0.20	1.55	EKMM421VSN391MA40S	
	220	22 × 50	0.15	1.10	EKMM401VSN221MP50S		470	30 × 60	0.20	1.79	EKMM421VSN471MR60S	
	220	25.4 × 40	0.15	1.10	EKMM401VSN221MQ40S		470	35 × 45	0.20	1.90	EKMM421VSN471MA45S	
	220	30 × 30	0.15	1.10	EKMM401VSN221MR30S		560	35 × 50	0.20	2.15	EKMM421VSN561MA50S	
	220	35 × 25	0.15	1.10	EKMM401VSN221MA25S		680	35 × 60	0.20	2.27	EKMM421VSN681MA60S	
	270	25.4 × 45	0.15	1.22	EKMM401VSN271MQ45S		450	56	22 × 25	0.20	0.40	EKMM451VSN560MP25S
	270	30 × 35	0.15	1.22	EKMM401VSN271MR35S			68	22 × 30	0.20	0.53	EKMM451VSN680MP30S
	270	35 × 30	0.15	1.22	EKMM401VSN271MA30S			68	25.4 × 25	0.20	0.50	EKMM451VSN680MQ25S
	330	25.4 × 50	0.15	1.44	EKMM401VSN331MQ50S			82	22 × 30	0.20	0.64	EKMM451VSN820MP30S
	330	30 × 40	0.15	1.44	EKMM401VSN331MR40S			82	25.4 × 25	0.20	0.64	EKMM451VSN820MQ25S
	330	35 × 30	0.15	1.44	EKMM401VSN331MA30S			100	22 × 35	0.20	0.69	EKMM451VSN101MP35S
	390	25.4 × 60	0.15	1.51	EKMM401VSN391MQ60S			100	25.4 × 30	0.20	0.69	EKMM451VSN101MQ30S
	390	30 × 45	0.15	1.60	EKMM401VSN391MR45S			100	30 × 25	0.20	0.64	EKMM451VSN101MR25S
	390	35 × 35	0.15	1.60	EKMM401VSN391MA35S			120	22 × 40	0.20	0.80	EKMM451VSN121MP40S
470	30 × 50	0.15	1.90	EKMM401VSN471MR50S	120	25.4 × 30		0.20	0.80	EKMM451VSN121MQ30S		
470	35 × 40	0.15	1.90	EKMM401VSN471MA40S	120	30 × 25		0.20	0.80	EKMM451VSN121MR25S		
560	30 × 60	0.15	2.10	EKMM401VSN561MR60S	120	35 × 25		0.20	0.73	EKMM451VSN121MA25S		
560	35 × 45	0.15	2.12	EKMM401VSN561MA45S	150	22 × 45		0.20	0.88	EKMM451VSN151MP45S		
680	35 × 60	0.15	2.27	EKMM401VSN681MA60S	150	25.4 × 35		0.20	0.88	EKMM451VSN151MQ35S		
420	47	22 × 20	0.20	0.37	EKMM421VSN470MP20S	150		30 × 30	0.20	0.88	EKMM451VSN151MR30S	
	56	25.4 × 20	0.20	0.42	EKMM421VSN560MQ20S	150		35 × 25	0.20	0.75	EKMM451VSN151MA25S	
	68	22 × 25	0.20	0.50	EKMM421VSN680MP25S	180		22 × 50	0.20	1.00	EKMM451VSN181MP50S	
	68	25.4 × 20	0.20	0.46	EKMM421VSN680MQ20S	180		25.4 × 40	0.20	1.00	EKMM451VSN181MQ40S	
	82	22 × 25	0.20	0.64	EKMM421VSN820MP25S	180		30 × 30	0.20	1.00	EKMM451VSN181MR30S	
	82	25.4 × 25	0.20	0.58	EKMM421VSN820MQ25S	220		25.4 × 45	0.20	1.12	EKMM451VSN221MQ45S	
	82	30 × 20	0.20	0.53	EKMM421VSN820MR20S	220		30 × 35	0.20	1.12	EKMM451VSN221MR35S	
	100	22 × 30	0.20	0.70	EKMM421VSN101MP30S	220		35 × 30	0.20	1.12	EKMM451VSN221MA30S	
	100	25.4 × 25	0.20	0.70	EKMM421VSN101MQ25S	270		25.4 × 60	0.20	1.18	EKMM451VSN271MQ60S	
	100	30 × 20	0.20	0.59	EKMM421VSN101MR20S	270		30 × 40	0.20	1.28	EKMM451VSN271MR40S	
	120	22 × 35	0.20	0.75	EKMM421VSN121MP35S	270		35 × 35	0.20	1.28	EKMM451VSN271MA35S	
	120	25.4 × 30	0.20	0.75	EKMM421VSN121MQ30S	330		30 × 50	0.20	1.45	EKMM451VSN331MR50S	
	120	30 × 25	0.20	0.73	EKMM421VSN121MR25S	330		35 × 40	0.20	1.45	EKMM451VSN331MA40S	
	120	35 × 20	0.20	0.67	EKMM421VSN121MA20S	390		30 × 60	0.20	1.51	EKMM451VSN391MR60S	
	150	22 × 40	0.20	0.88	EKMM421VSN151MP40S	390	35 × 40	0.20	1.55	EKMM451VSN391MA40S		
	150	25.4 × 35	0.20	0.88	EKMM421VSN151MQ35S	470	35 × 50	0.20	1.85	EKMM451VSN471MA50S		
	150	30 × 25	0.20	0.88	EKMM421VSN151MR25S	560	35 × 60	0.20	1.91	EKMM451VSN561MA60S		
	180	22 × 45	0.20	0.95	EKMM421VSN181MP45S							

◆ RATED RIPPLE CURRENT MULTIPLIERS

● Frequency Multipliers

Frequency(Hz)	50	120	300	1k	10k	50k
160 to 250V _{dc}	0.81	1.00	1.17	1.32	1.45	1.50
315 to 450V _{dc}	0.77	1.00	1.16	1.30	1.41	1.43

The deterioration of aluminum electrolytic capacitors accelerates their life due to the internal heating produced by ripple current. For details, refer to Section "5-3 Ripple Current Effect on Lifetime" in the catalog, Technical Note.

SMH Series

- Endurance with ripple current : 2,000 hours at 85°C
- Non solvent resistant type
- RoHS2 Compliant

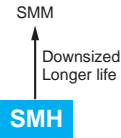

◆ SPECIFICATIONS

Items	Characteristics										
Category	-40 to +85°C										
Temperature Range	-40 to +85°C										
Rated Voltage Range	6.3 to 100V _{dc}										
Capacitance Tolerance	±20% (M) (at 20°C, 120Hz)										
Leakage Current	I=0.02CV or 3mA, whichever is smaller. Where, I : Max. leakage current (μA), C : Nominal capacitance (μF), V : Rated voltage (V) (at 20°C after 5 minutes)										
Dissipation Factor (tan δ)	Rated voltage (V _{dc})	6.3V	10V	16V	25V	35V	50V	63V	80V	100V	
	tan δ (Max.)	0.60	0.50	0.40	0.30	0.25	0.20	0.15	0.15	0.15	(at 20°C, 120Hz)
Low Temperature Characteristics (Max. Impedance Ratio)	Rated voltage (V _{dc})	6.3V	10V	16V	25V	35V	50V	63V	80V	100V	
	Z(-25°C)/Z(+20°C)	4	4	4	3	3	2	2	2	2	
	Z(-40°C)/Z(+20°C)	15	15	15	10	8	6	6	5	5	(at 120Hz)
Endurance	The following specifications shall be satisfied when the capacitors are restored to 20°C after subjected to DC voltage with the rated ripple current is applied (the peak voltage shall not exceed the rated voltage) for 2,000 hours at 85°C.										
	Capacitance change	≤ ±20% of the initial value									
	D.F. (tan δ)	≤ 200% of the initial specified value									
	Leakage current	≤ The initial specified value									
Shelf Life	The following specifications shall be satisfied when the capacitors are restored to 20°C after exposing them for 1,000 hours at 85°C without voltage applied. Before the measurement, the capacitor shall be preconditioned by applying voltage according to Item 4.1 of JIS C 5101-4.										
	Capacitance change	≤ ±20% of the initial value									
	D.F. (tan δ)	≤ 150% of the initial specified value									
	Leakage current	≤ The initial specified value									

◆ DIMENSIONS [mm]

● Terminal Code : VS (φ22 to φ35) : Standard

● Terminal Code : LI (φ35)

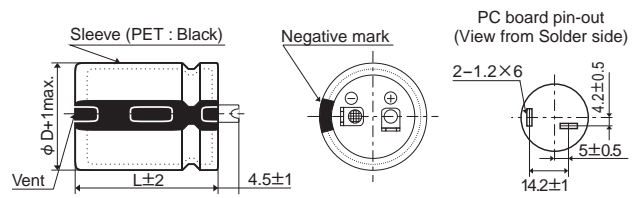
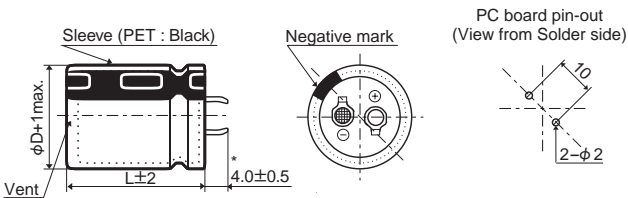

*φD=35mm : 3.5±0.5mm

The standard design has no plastic disc.

◆ PART NUMBERING SYSTEM

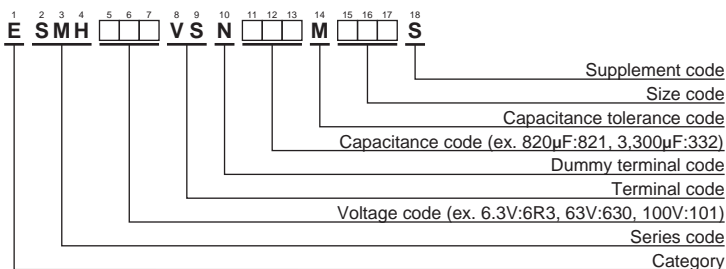

Please refer to "Product code guide (snap-in type)"

◆ STANDARD RATINGS

WV (V _{dc})	Cap (μF)	Case size φD×L(mm)	tan δ	Rated ripple current (Arms/85°C, 120Hz)	Part No.	WV (V _{dc})	Cap (μF)	Case size φD×L(mm)	tan δ	Rated ripple current (Arms/85°C, 120Hz)	Part No.		
6.3	15,000	22 × 25	0.60	2.44	ESMH6R3VSN153MP25S	16	27,000	25.4 × 45	0.40	4.72	ESMH160VSN273MQ45S		
	18,000	22 × 30	0.60	2.67	ESMH6R3VSN183MP30S		27,000	30 × 35	0.40	4.82	ESMH160VSN273MR35S		
	18,000	25.4 × 25	0.60	2.70	ESMH6R3VSN183MQ25S		27,000	35 × 30	0.40	4.65	ESMH160VSN273MA30S		
	22,000	22 × 30	0.60	3.06	ESMH6R3VSN223MP30S		33,000	25.4 × 50	0.40	5.33	ESMH160VSN333MQ50S		
	22,000	25.4 × 25	0.60	3.07	ESMH6R3VSN223MQ25S		33,000	30 × 40	0.40	5.36	ESMH160VSN333MR40S		
	27,000	22 × 35	0.60	3.49	ESMH6R3VSN273MP35S		33,000	35 × 30	0.40	5.15	ESMH160VSN333MA30S		
	27,000	25.4 × 30	0.60	3.52	ESMH6R3VSN273MQ30S		39,000	30 × 45	0.40	6.01	ESMH160VSN393MR45S		
	27,000	30 × 25	0.60	3.57	ESMH6R3VSN273MR25S		39,000	35 × 35	0.40	5.95	ESMH160VSN393MA35S		
	33,000	22 × 40	0.60	3.97	ESMH6R3VSN333MP40S		47,000	30 × 50	0.40	6.79	ESMH160VSN473MR50S		
	33,000	25.4 × 35	0.60	4.02	ESMH6R3VSN333MQ35S		47,000	35 × 40	0.40	6.76	ESMH160VSN473MA40S		
	33,000	30 × 25	0.60	3.95	ESMH6R3VSN333MQ25S		56,000	35 × 45	0.40	7.62	ESMH160VSN563MA45S		
	39,000	22 × 50	0.60	4.55	ESMH6R3VSN393MP50S		68,000	35 × 50	0.40	8.63	ESMH160VSN683MA50S		
	39,000	25.4 × 40	0.60	4.50	ESMH6R3VSN393MQ40S		25	5,600	22 × 25	0.30	2.21	ESMH250VSN562MP25S	
	39,000	30 × 30	0.60	4.45	ESMH6R3VSN393MR30S			6,800	22 × 30	0.30	2.40	ESMH250VSN682MP30S	
	39,000	35 × 25	0.60	4.51	ESMH6R3VSN393MA25S			6,800	25.4 × 25	0.30	2.56	ESMH250VSN682MQ25S	
	47,000	25.4 × 45	0.60	5.09	ESMH6R3VSN473MQ45S			8,200	22 × 35	0.30	2.72	ESMH250VSN822MP35S	
	47,000	30 × 35	0.60	5.06	ESMH6R3VSN473MR35S			8,200	25.4 × 25	0.30	2.80	ESMH250VSN822MQ25S	
	47,000	35 × 30	0.60	5.01	ESMH6R3VSN473MA30S			10,000	22 × 40	0.30	3.09	ESMH250VSN103MP40S	
	56,000	25.4 × 50	0.60	5.71	ESMH6R3VSN563MQ50S			10,000	25.4 × 30	0.30	3.12	ESMH250VSN103MR30S	
	56,000	30 × 40	0.60	5.70	ESMH6R3VSN563MR40S			10,000	30 × 25	0.30	3.21	ESMH250VSN103MR25S	
	56,000	35 × 30	0.60	5.77	ESMH6R3VSN563MA30S			12,000	22 × 45	0.30	3.48	ESMH250VSN123MP45S	
	68,000	30 × 45	0.60	6.48	ESMH6R3VSN683MR45S			12,000	25.4 × 35	0.30	3.43	ESMH250VSN123MQ35S	
	68,000	35 × 35	0.60	6.42	ESMH6R3VSN683MA35S			12,000	30 × 30	0.30	3.86	ESMH250VSN123MR30S	
	82,000	30 × 50	0.60	7.32	ESMH6R3VSN823MR50S			12,000	35 × 25	0.30	3.54	ESMH250VSN123MA25S	
	82,000	35 × 40	0.60	7.29	ESMH6R3VSN823MA40S			15,000	22 × 50	0.30	4.00	ESMH250VSN153MP50S	
	100,000	35 × 45	0.60	8.31	ESMH6R3VSN104MA45S			15,000	25.4 × 40	0.30	3.95	ESMH250VSN153MQ40S	
	10	12,000	22 × 25	0.50	2.39			ESMH100VSN123MP25S	15,000	30 × 30	0.30	4.00	ESMH250VSN153MR30S
		15,000	22 × 30	0.50	2.76			ESMH100VSN153MP30S	15,000	35 × 25	0.30	3.95	ESMH250VSN153MA25S
15,000		25.4 × 25	0.50	2.77	ESMH100VSN153MQ25S	18,000		25.4 × 45	0.30	4.45	ESMH250VSN183MQ45S		
18,000		22 × 35	0.50	3.12	ESMH100VSN183MP35S	18,000		30 × 35	0.30	4.46	ESMH250VSN183MR35S		
18,000		25.4 × 25	0.50	3.04	ESMH100VSN183MQ25S	18,000		35 × 30	0.30	4.63	ESMH250VSN183MA30S		
22,000		22 × 40	0.50	3.55	ESMH100VSN223MP40S	22,000		25.4 × 50	0.30	5.02	ESMH250VSN223MQ50S		
22,000		25.4 × 30	0.50	3.48	ESMH100VSN223MQ30S	22,000		30 × 45	0.30	5.21	ESMH250VSN223MR45S		
22,000		30 × 25	0.50	3.53	ESMH100VSN223MR25S	22,000		35 × 35	0.30	5.16	ESMH250VSN223MA35S		
27,000		22 × 45	0.50	4.04	ESMH100VSN273MP45S	27,000		30 × 50	0.30	5.94	ESMH250VSN273MR50S		
27,000		25.4 × 35	0.50	3.98	ESMH100VSN273MQ35S	27,000		35 × 40	0.30	5.92	ESMH250VSN273MA40S		
27,000		30 × 30	0.50	3.73	ESMH100VSN273MR30S	33,000		35 × 45	0.30	6.75	ESMH250VSN333MA45S		
27,000		35 × 25	0.50	3.73	ESMH100VSN273MA25S	39,000		35 × 50	0.30	7.56	ESMH250VSN393MA50S		
33,000		22 × 50	0.50	4.58	ESMH100VSN333MP50S	35		3,900	22 × 25	0.25	2.22	ESMH350VSN392MP25S	
33,000		25.4 × 40	0.50	4.54	ESMH100VSN333MQ40S			4,700	22 × 30	0.25	2.41	ESMH350VSN472MP30S	
33,000		30 × 30	0.50	4.13	ESMH100VSN333MR30S		4,700	25.4 × 25	0.25	2.42	ESMH350VSN472MQ25S		
33,000		35 × 25	0.50	4.13	ESMH100VSN333MA25S		5,600	22 × 35	0.25	2.75	ESMH350VSN562MP35S		
39,000		25.4 × 45	0.50	5.08	ESMH100VSN393MQ45S		5,600	25.4 × 25	0.25	2.64	ESMH350VSN562MQ25S		
39,000		30 × 35	0.50	5.05	ESMH100VSN393MR35S		6,800	22 × 40	0.25	2.80	ESMH350VSN682MP40S		
39,000		35 × 30	0.50	4.80	ESMH100VSN393MA30S		6,800	25.4 × 30	0.25	2.74	ESMH350VSN682MQ30S		
47,000		25.4 × 50	0.50	5.73	ESMH100VSN473MQ50S		6,800	30 × 25	0.25	2.97	ESMH350VSN682MR25S		
47,000		30 × 40	0.50	5.72	ESMH100VSN473MR40S		8,200	22 × 45	0.25	3.47	ESMH350VSN822MP45S		
47,000		35 × 30	0.50	5.27	ESMH100VSN473MA30S		8,200	25.4 × 35	0.25	3.10	ESMH350VSN822MQ35S		
56,000		30 × 45	0.50	6.44	ESMH100VSN563MR45S		8,200	30 × 30	0.25	3.13	ESMH350VSN822MR30S		
56,000		35 × 35	0.50	6.38	ESMH100VSN563MA35S		8,200	35 × 25	0.25	2.73	ESMH350VSN822MA25S		
68,000		30 × 50	0.50	7.27	ESMH100VSN683MR50S		10,000	22 × 50	0.25	3.57	ESMH350VSN103MP50S		
68,000		35 × 40	0.50	7.27	ESMH100VSN683MA40S		10,000	25.4 × 40	0.25	3.53	ESMH350VSN103MQ40S		
82,000		35 × 50	0.50	8.49	ESMH100VSN823MA50S		10,000	30 × 30	0.25	3.46	ESMH350VSN103MR30S		
16		8,200	22 × 25	0.40	2.51		ESMH160VSN822MP25S	10,000	35 × 25	0.25	3.02	ESMH350VSN103MA25S	
	10,000	22 × 25	0.40	2.77	ESMH160VSN103MP25S		12,000	25.4 × 45	0.25	3.98	ESMH350VSN123MQ45S		
	12,000	22 × 30	0.40	2.86	ESMH160VSN123MP30S		12,000	30 × 35	0.25	4.01	ESMH350VSN123MR35S		
	12,000	25.4 × 25	0.40	2.95	ESMH160VSN123MQ25S		12,000	35 × 30	0.25	4.42	ESMH350VSN123MA30S		
	15,000	22 × 35	0.40	3.29	ESMH160VSN153MP35S		15,000	25.4 × 50	0.25	4.54	ESMH350VSN153MQ50S		
	15,000	25.4 × 30	0.40	3.46	ESMH160VSN153MQ30S		15,000	30 × 40	0.25	4.52	ESMH350VSN153MR40S		
	15,000	30 × 25	0.40	3.66	ESMH160VSN153MR25S		15,000	35 × 35	0.25	5.01	ESMH350VSN153MA35S		
	18,000	22 × 40	0.40	3.72	ESMH160VSN183MP40S		18,000	30 × 45	0.25	4.71	ESMH350VSN183MR45S		
	18,000	25.4 × 35	0.40	3.98	ESMH160VSN183MQ35S		18,000	35 × 40	0.25	5.54	ESMH350VSN183MA40S		
	18,000	30 × 25	0.40	4.00	ESMH160VSN183MR25S		22,000	30 × 50	0.25	5.33	ESMH350VSN223MR50S		
	22,000	22 × 50	0.40	4.37	ESMH160VSN223MP50S		22,000	35 × 45	0.25	6.04	ESMH350VSN223MA45S		
	22,000	25.4 × 40	0.40	4.26	ESMH160VSN223MQ40S		27,000	35 × 50	0.25	6.89	ESMH350VSN273MA50S		
	22,000	30 × 30	0.40	4.21	ESMH160VSN223MR30S		50	2,200	22 × 25	0.20	1.91	ESMH500VSN222MP25S	
	22,000	35 × 25	0.40	4.15	ESMH160VSN223MA25S	3,300		22 × 30	0.20	2.37	ESMH500VSN332MP30S		

◆ STANDARD RATINGS

WV (V _{dc})	Cap (μF)	Case size φD×L(mm)	tan δ	Rated ripple current (Arms/85°C, 120Hz)	Part No.	WV (V _{dc})	Cap (μF)	Case size φD×L(mm)	tan δ	Rated ripple current (Arms/85°C, 120Hz)	Part No.
50	3,300	25.4 × 25	0.20	2.38	ESMH500VSN332MQ25S	80	1,200	22 × 25	0.15	1.69	ESMH800VSN122MP25S
	3,900	22 × 35	0.20	2.65	ESMH500VSN392MP35S		1,500	22 × 25	0.15	1.88	ESMH800VSN152MP25S
	3,900	25.4 × 30	0.20	2.68	ESMH500VSN392MQ30S		1,800	22 × 30	0.15	2.14	ESMH800VSN182MP30S
	3,900	30 × 25	0.20	2.55	ESMH500VSN392MR25S		1,800	25.4 × 25	0.15	2.26	ESMH800VSN182MQ25S
	4,700	22 × 40	0.20	2.99	ESMH500VSN472MP40S		2,200	22 × 35	0.15	2.44	ESMH800VSN222MP35S
	4,700	25.4 × 35	0.20	3.03	ESMH500VSN472MQ35S		2,200	25.4 × 30	0.15	2.46	ESMH800VSN222MQ30S
	4,700	30 × 25	0.20	2.81	ESMH500VSN472MR25S		2,200	30 × 25	0.15	2.49	ESMH800VSN222MR25S
	5,600	22 × 45	0.20	3.36	ESMH500VSN562MP45S		2,700	22 × 40	0.15	2.78	ESMH800VSN272MP40S
	5,600	25.4 × 35	0.20	3.31	ESMH500VSN562MQ35S		2,700	25.4 × 35	0.15	2.81	ESMH800VSN272MQ35S
	5,600	30 × 30	0.20	3.37	ESMH500VSN562MR30S		2,700	30 × 25	0.15	2.75	ESMH800VSN272MR25S
	5,600	35 × 25	0.20	3.42	ESMH500VSN562MA25S		3,300	22 × 45	0.15	3.16	ESMH800VSN332MP45S
	6,800	22 × 50	0.20	3.81	ESMH500VSN682MP50S		3,300	25.4 × 40	0.15	3.21	ESMH800VSN332MQ40S
	6,800	25.4 × 40	0.20	3.81	ESMH500VSN682MQ40S		3,300	30 × 30	0.15	3.17	ESMH800VSN332MR30S
	6,800	30 × 35	0.20	3.85	ESMH500VSN682MR35S		3,300	35 × 25	0.15	3.21	ESMH800VSN332MA25S
	6,800	35 × 30	0.20	3.85	ESMH500VSN682MA30S		3,900	22 × 50	0.15	3.52	ESMH800VSN392MP50S
	8,200	25.4 × 50	0.20	4.37	ESMH500VSN822MQ50S		3,900	25.4 × 45	0.15	3.59	ESMH800VSN392MQ45S
	8,200	30 × 40	0.20	4.36	ESMH500VSN822MR40S		3,900	30 × 35	0.15	3.57	ESMH800VSN392MR35S
	8,200	35 × 30	0.20	4.41	ESMH500VSN822MA30S		3,900	35 × 25	0.15	3.50	ESMH800VSN392MA25S
10,000	30 × 45	0.20	4.97	ESMH500VSN103MR45S	4,700	25.4 × 50	0.15	4.05	ESMH800VSN472MQ50S		
10,000	35 × 35	0.20	4.92	ESMH500VSN103MA35S	4,700	30 × 40	0.15	4.05	ESMH800VSN472MR40S		
12,000	30 × 50	0.20	5.60	ESMH500VSN123MR50S	4,700	35 × 30	0.15	4.09	ESMH800VSN472MA30S		
12,000	35 × 40	0.20	5.58	ESMH500VSN123MA40S	5,600	30 × 45	0.15	4.55	ESMH800VSN562MR45S		
15,000	35 × 45	0.20	6.44	ESMH500VSN153MA45S	5,600	35 × 35	0.15	4.51	ESMH800VSN562MA35S		
18,000	35 × 50	0.20	6.71	ESMH500VSN183MA50S	6,800	30 × 50	0.15	5.16	ESMH800VSN682MR50S		
63	1,800	22 × 25	0.15	1.82	ESMH630VSN182MP25S	6,800	35 × 40	0.15	5.14	ESMH800VSN682MA40S	
	2,200	22 × 30	0.15	2.31	ESMH630VSN222MP30S	8,200	35 × 45	0.15	5.83	ESMH800VSN822MA45S	
	2,200	25.4 × 25	0.15	2.30	ESMH630VSN222MQ25S	10,000	35 × 50	0.15	6.63	ESMH800VSN103MA50S	
	2,700	22 × 35	0.15	2.40	ESMH630VSN272MP35S	100	820	22 × 25	0.15	1.86	ESMH101VSN821MP25S
	2,700	25.4 × 25	0.15	2.40	ESMH630VSN272MQ25S		1,200	22 × 30	0.15	2.09	ESMH101VSN122MP30S
	3,300	22 × 35	0.15	2.62	ESMH630VSN332MP35S		1,200	25.4 × 25	0.15	2.10	ESMH101VSN122MQ25S
	3,300	25.4 × 30	0.15	2.64	ESMH630VSN332MQ30S		1,500	22 × 35	0.15	2.41	ESMH101VSN152MP35S
	3,300	30 × 25	0.15	2.78	ESMH630VSN332MR25S		1,500	25.4 × 30	0.15	2.43	ESMH101VSN152MQ30S
	3,900	22 × 40	0.15	2.93	ESMH630VSN392MP40S		1,500	30 × 25	0.15	2.46	ESMH101VSN152MR25S
	3,900	25.4 × 35	0.15	2.97	ESMH630VSN392MQ35S		1,800	22 × 40	0.15	2.71	ESMH101VSN182MP40S
	3,900	30 × 30	0.15	3.00	ESMH630VSN392MR30S		1,800	25.4 × 35	0.15	2.75	ESMH101VSN182MQ35S
	3,900	35 × 25	0.15	3.00	ESMH630VSN392MA25S		1,800	30 × 25	0.15	2.72	ESMH101VSN182MR25S
	4,700	22 × 50	0.15	3.39	ESMH630VSN472MP50S		2,200	22 × 45	0.15	3.08	ESMH101VSN222MP45S
	4,700	25.4 × 40	0.15	3.36	ESMH630VSN472MQ40S		2,200	25.4 × 40	0.15	3.13	ESMH101VSN222MQ40S
	4,700	30 × 30	0.15	3.32	ESMH630VSN472MR30S		2,200	30 × 30	0.15	3.09	ESMH101VSN222MR30S
	4,700	35 × 25	0.15	3.36	ESMH630VSN472MA25S		2,200	35 × 25	0.15	3.14	ESMH101VSN222MA25S
	5,600	25.4 × 45	0.15	3.77	ESMH630VSN562MQ45S		2,700	22 × 50	0.15	3.53	ESMH101VSN272MP50S
	5,600	30 × 35	0.15	3.75	ESMH630VSN562MR35S		2,700	25.4 × 45	0.15	3.57	ESMH101VSN272MQ45S
5,600	35 × 30	0.15	3.76	ESMH630VSN562MA30S	2,700		30 × 35	0.15	3.55	ESMH101VSN272MR35S	
6,800	25.4 × 50	0.15	4.27	ESMH630VSN682MQ50S	2,700		35 × 30	0.15	3.71	ESMH101VSN272MA30S	
6,800	30 × 40	0.15	4.27	ESMH630VSN682MR40S	3,300		25.4 × 50	0.15	4.06	ESMH101VSN332MQ50S	
6,800	35 × 30	0.15	4.15	ESMH630VSN682MA30S	3,300	30 × 40	0.15	4.05	ESMH101VSN332MR40S		
8,200	30 × 45	0.15	4.83	ESMH630VSN822MR45S	3,300	35 × 30	0.15	4.05	ESMH101VSN332MA30S		
8,200	35 × 35	0.15	4.79	ESMH630VSN822MA35S	3,900	30 × 45	0.15	4.54	ESMH101VSN392MR45S		
10,000	30 × 50	0.15	5.49	ESMH630VSN103MR50S	3,900	35 × 35	0.15	4.49	ESMH101VSN392MA35S		
10,000	35 × 40	0.15	5.47	ESMH630VSN103MA40S	4,700	30 × 50	0.15	5.13	ESMH101VSN472MR50S		
12,000	35 × 45	0.15	6.19	ESMH630VSN123MA45S	4,700	35 × 40	0.15	5.11	ESMH101VSN472MA40S		
					5,600	35 × 45	0.15	5.75	ESMH101VSN562MA45S		
					6,800	35 × 50	0.15	6.50	ESMH101VSN682MA50S		

*For the rated voltage ≥ 160V_{dc}, please use SMQ series

◆ RATED RIPPLE CURRENT MULTIPLIERS

● Frequency Multipliers

Frequency(Hz)	50	120	300	1k	10k	50k
6.3 to 50V _{dc}	0.95	1.00	1.03	1.05	1.08	1.08
63 to 100V _{dc}	0.92	1.00	1.07	1.13	1.19	1.20

The deterioration of aluminum electrolytic capacitors accelerates their life due to the internal heating produced by ripple current. For details, refer to Section "5-3 Ripple Current Effect on Lifetime" in the catalog, Technical Note.

KMH Series

- Endurance with ripple current : 2,000 hours at 105°C
- Non solvent resistant type
- RoHS2 Compliant

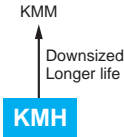

◆ SPECIFICATIONS

Items	Characteristics										
Category	-40 to +105°C										
Temperature Range	-40 to +105°C										
Rated Voltage Range	6.3 to 100V _{dc}										
Capacitance Tolerance	±20% (M) (at 20°C, 120Hz)										
Leakage Current	I=0.02CV or 3mA, whichever is smaller Where, I : Max. leakage current (µA), C : Nominal capacitance (µF), V : Rated voltage (V) (at 20°C after 5 minutes)										
Dissipation Factor (tan δ)	Rated voltage (V _{dc})	6.3V	10V	16V	25V	35V	50V	63V	80V	100V	
	tan δ (Max.)	0.60	0.50	0.40	0.30	0.25	0.20	0.15	0.15	0.15	(at 20°C, 120Hz)
Low Temperature Characteristics (Max. Impedance Ratio)	Rated voltage (V _{dc})	6.3V	10V	16V	25V	35V	50V	63V	80V	100V	
	Z(-25°C)/Z(+20°C)	4	4	4	3	3	2	2	2	2	
	Z(-40°C)/Z(+20°C)	15	15	15	10	8	6	6	5	5	(at 120Hz)
Endurance	The following specifications shall be satisfied when the capacitors are restored to 20°C after subjected to DC voltage with the rated ripple current is applied (the peak voltage shall not exceed the rated voltage) for 2,000 hours at 105°C										
	Capacitance change	≤ ±20% of the initial value									
	D.F. (tan δ)	≤ 200% of the initial specified value									
	Leakage current	≤ The initial specified value									
Shelf Life	The following specifications shall be satisfied when the capacitors are restored to 20°C after exposing them for 1,000 hours at 105°C without voltage applied. Before the measurement, the capacitor shall be preconditioned by applying voltage according to Item 4.1 of JIS C 5101-4.										
	Capacitance change	≤ ±20% of the initial value									
	D.F. (tan δ)	≤ 150% of the initial specified value									
	Leakage current	≤ The initial specified value									

◆ DIMENSIONS [mm]

● Terminal Code : VS (φ22 to φ35) : Standard

● Terminal Code : LI (φ35)

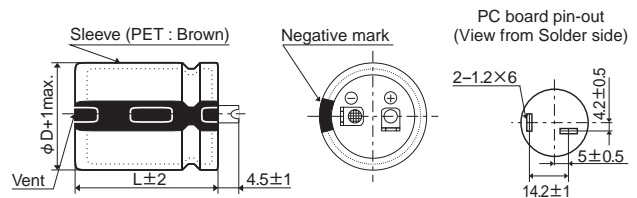
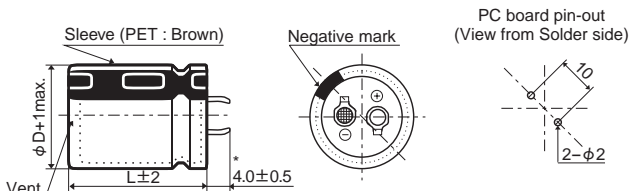

* φD=35mm : 3.5±0.5mm

The standard design has no plastic disc.

◆ PART NUMBERING SYSTEM

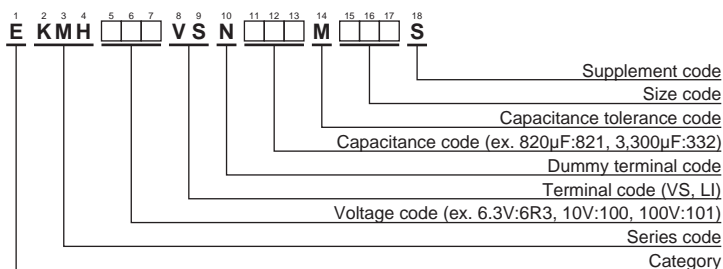

Please refer to "Product code guide (snap-in type)"

◆ STANDARD RATINGS

WV (V _{dc})	Cap (μF)	Case size φD×L(mm)	tan δ	Rated ripple current (Arms/105°C, 120Hz)	Part No.	WV (V _{dc})	Cap (μF)	Case size φD×L(mm)	tan δ	Rated ripple current (Arms/105°C, 120Hz)	Part No.	
6.3	12,000	22 × 25	0.60	1.54	EKMH6R3VSN123MP25S	16	27,000	35 × 30	0.40	3.45	EKMH160VSN273MA30S	
	15,000	22 × 25	0.60	1.72	EKMH6R3VSN153MP25S		33,000	30 × 45	0.40	4.30	EKMH160VSN333MR45S	
	18,000	22 × 30	0.60	1.95	EKMH6R3VSN183MP30S		33,000	35 × 35	0.40	4.26	EKMH160VSN333MA35S	
	18,000	25.4 × 25	0.60	1.96	EKMH6R3VSN183MQ25S		39,000	30 × 50	0.40	4.81	EKMH160VSN393MR50S	
	22,000	22 × 35	0.60	2.23	EKMH6R3VSN223MP35S		39,000	35 × 40	0.40	4.79	EKMH160VSN393MA40S	
	22,000	25.4 × 30	0.60	2.25	EKMH6R3VSN223MQ30S		47,000	35 × 45	0.40	5.43	EKMH160VSN473MA45S	
	22,000	30 × 25	0.60	2.28	EKMH6R3VSN223MR25S		25	4,700	22 × 25	0.30	1.50	EKMH250VSN472MP25S
	27,000	22 × 40	0.60	2.54	EKMH6R3VSN273MP40S			5,600	22 × 25	0.30	1.63	EKMH250VSN562MP25S
	27,000	25.4 × 35	0.60	2.57	EKMH6R3VSN273MQ35S	6,800		22 × 30	0.30	1.86	EKMH250VSN682MP30S	
	27,000	30 × 25	0.60	2.52	EKMH6R3VSN273MR25S	6,800		25.4 × 25	0.30	1.87	EKMH250VSN682MQ25S	
	33,000	22 × 45	0.60	2.88	EKMH6R3VSN333MP45S	8,200		22 × 35	0.30	2.11	EKMH250VSN822MP35S	
	33,000	25.4 × 40	0.60	2.93	EKMH6R3VSN333MQ40S	8,200		25.4 × 30	0.30	2.12	EKMH250VSN822MQ30S	
	33,000	30 × 30	0.60	2.89	EKMH6R3VSN333MR30S	8,200		30 × 25	0.30	2.15	EKMH250VSN822MR25S	
	33,000	35 × 25	0.60	2.93	EKMH6R3VSN333MA25S	10,000		22 × 40	0.30	2.39	EKMH250VSN103MP40S	
	39,000	25.4 × 40	0.60	3.18	EKMH6R3VSN393MQ40S	10,000		25.4 × 35	0.30	2.42	EKMH250VSN103MR35S	
	39,000	30 × 35	0.60	3.26	EKMH6R3VSN393MR35S	10,000		30 × 25	0.30	2.37	EKMH250VSN103MR25S	
	39,000	35 × 30	0.60	3.40	EKMH6R3VSN393MA30S	12,000		22 × 45	0.30	2.69	EKMH250VSN123MP45S	
	47,000	25.4 × 50	0.60	3.69	EKMH6R3VSN473MQ50S	12,000		25.4 × 40	0.30	2.74	EKMH250VSN123MQ40S	
	47,000	30 × 40	0.60	3.69	EKMH6R3VSN473MR40S	12,000		30 × 30	0.30	2.70	EKMH250VSN123MR30S	
	47,000	35 × 30	0.60	3.73	EKMH6R3VSN473MA30S	12,000		35 × 25	0.30	2.74	EKMH250VSN123MA25S	
	56,000	30 × 45	0.60	4.16	EKMH6R3VSN563MR45S	15,000		25.4 × 45	0.30	3.15	EKMH250VSN153MQ45S	
	56,000	35 × 35	0.60	4.12	EKMH6R3VSN563MA35S	15,000		30 × 35	0.30	3.13	EKMH250VSN153MR35S	
	68,000	30 × 50	0.60	4.71	EKMH6R3VSN683MR50S	15,000		35 × 30	0.30	3.27	EKMH250VSN153MA30S	
	68,000	35 × 40	0.60	4.69	EKMH6R3VSN683MA40S	18,000		25.4 × 50	0.30	3.54	EKMH250VSN183MQ50S	
82,000	35 × 45	0.60	5.32	EKMH6R3VSN823MA45S	18,000	30 × 40		0.30	3.54	EKMH250VSN183MR40S		
10	10,000	22 × 25	0.50	1.55	EKMH100VSN103MP25S	18,000		35 × 30	0.30	3.58	EKMH250VSN183MA30S	
	12,000	22 × 30	0.50	1.77	EKMH100VSN123MP30S	22,000		30 × 45	0.30	4.04	EKMH250VSN223MR45S	
	15,000	22 × 30	0.50	1.97	EKMH100VSN153MP30S	22,000		35 × 35	0.30	3.64	EKMH250VSN223MA35S	
	15,000	25.4 × 25	0.50	1.96	EKMH100VSN153MQ25S	27,000		35 × 45	0.30	4.73	EKMH250VSN273MA45S	
	18,000	22 × 35	0.50	2.21	EKMH100VSN183MP35S	33,000		35 × 50	0.30	5.39	EKMH250VSN333MA50S	
	18,000	25.4 × 30	0.50	2.23	EKMH100VSN183MQ30S	35	3,300	22 × 25	0.25	1.40	EKMH350VSN332MP25S	
	22,000	22 × 40	0.50	2.51	EKMH100VSN223MP40S		3,900	22 × 30	0.25	1.57	EKMH350VSN392MP30S	
	22,000	25.4 × 35	0.50	2.54	EKMH100VSN223MQ35S		4,700	22 × 30	0.25	1.72	EKMH350VSN472MP30S	
	22,000	30 × 25	0.50	2.40	EKMH100VSN223MR25S		4,700	25.4 × 25	0.25	1.80	EKMH350VSN472MQ25S	
	27,000	22 × 50	0.50	2.93	EKMH100VSN273MP50S		5,600	22 × 35	0.25	1.95	EKMH350VSN562MP35S	
	27,000	25.4 × 40	0.50	2.90	EKMH100VSN273MQ40S		5,600	25.4 × 30	0.25	1.96	EKMH350VSN562MQ30S	
	27,000	30 × 30	0.50	2.87	EKMH100VSN273MR30S		5,600	30 × 25	0.25	1.99	EKMH350VSN562MR25S	
	27,000	35 × 25	0.50	2.73	EKMH100VSN273MA25S		6,800	22 × 40	0.25	2.20	EKMH350VSN682MP40S	
	33,000	25.4 × 45	0.50	3.30	EKMH100VSN333MQ45S		6,800	25.4 × 35	0.25	2.23	EKMH350VSN682MQ35S	
	33,000	30 × 35	0.50	3.28	EKMH100VSN333MR35S		6,800	30 × 25	0.25	2.19	EKMH350VSN682MR25S	
	33,000	35 × 30	0.50	3.16	EKMH100VSN333MA30S		8,200	22 × 50	0.25	2.55	EKMH350VSN822MP50S	
	39,000	25.4 × 50	0.50	3.68	EKMH100VSN393MQ50S		8,200	25.4 × 40	0.25	2.53	EKMH350VSN822MQ40S	
	39,000	30 × 40	0.50	3.69	EKMH100VSN393MR40S		8,200	30 × 30	0.25	2.75	EKMH350VSN822MR30S	
	39,000	35 × 30	0.50	3.43	EKMH100VSN393MA30S		8,200	35 × 25	0.25	2.75	EKMH350VSN822MA25S	
	47,000	30 × 45	0.50	4.17	EKMH100VSN473MR45S		10,000	25.4 × 45	0.25	2.87	EKMH350VSN103MQ45S	
	47,000	35 × 35	0.50	3.76	EKMH100VSN473MA35S		10,000	30 × 35	0.25	2.90	EKMH350VSN103MR35S	
	56,000	30 × 50	0.50	4.68	EKMH100VSN563MR50S		10,000	35 × 30	0.25	2.91	EKMH350VSN103MA30S	
	56,000	35 × 40	0.50	4.67	EKMH100VSN563MA40S		12,000	25.4 × 50	0.25	3.24	EKMH350VSN123MQ50S	
	68,000	35 × 50	0.50	5.46	EKMH100VSN683MA50S		12,000	30 × 40	0.25	3.23	EKMH350VSN123MR40S	
16	6,800	22 × 25	0.40	1.57	EKMH160VSN682MP25S		12,000	35 × 30	0.25	2.99	EKMH350VSN123MA30S	
	10,000	22 × 30	0.40	1.97	EKMH160VSN103MP30S		15,000	30 × 45	0.25	3.72	EKMH350VSN153MR45S	
	10,000	25.4 × 25	0.40	1.97	EKMH160VSN103MQ25S		15,000	35 × 35	0.25	3.67	EKMH350VSN153MA35S	
	12,000	22 × 35	0.40	2.22	EKMH160VSN123MP35S		18,000	35 × 40	0.25	4.37	EKMH350VSN183MA40S	
	12,000	25.4 × 30	0.40	2.24	EKMH160VSN123MQ30S		22,000	35 × 50	0.25	4.92	EKMH350VSN223MA50S	
	12,000	30 × 25	0.40	2.45	EKMH160VSN123MR25S	50	1,800	22 × 25	0.20	1.33	EKMH500VSN182MP25S	
	15,000	22 × 40	0.40	2.55	EKMH160VSN153MP40S		2,700	22 × 30	0.20	1.69	EKMH500VSN272MP30S	
	15,000	25.4 × 35	0.40	2.58	EKMH160VSN153MQ35S		2,700	25.4 × 25	0.20	1.70	EKMH500VSN272MQ25S	
	15,000	30 × 25	0.40	2.52	EKMH160VSN153MR25S		3,300	22 × 35	0.20	1.93	EKMH500VSN332MP35S	
	18,000	22 × 45	0.40	2.87	EKMH160VSN183MP45S		3,300	25.4 × 30	0.20	1.85	EKMH500VSN332MQ30S	
	18,000	25.4 × 40	0.40	2.92	EKMH160VSN183MQ40S		3,900	22 × 40	0.20	2.16	EKMH500VSN392MP40S	
	18,000	30 × 30	0.40	2.88	EKMH160VSN183MR30S		3,900	25.4 × 35	0.20	2.18	EKMH500VSN392MQ35S	
	18,000	35 × 25	0.40	2.92	EKMH160VSN183MA25S		3,900	30 × 25	0.20	1.95	EKMH500VSN392MR25S	
	22,000	25.4 × 45	0.40	3.32	EKMH160VSN223MQ45S		4,700	22 × 45	0.20	2.43	EKMH500VSN472MP45S	
	22,000	30 × 35	0.40	3.29	EKMH160VSN223MR35S		4,700	25.4 × 35	0.20	2.39	EKMH500VSN472MQ35S	
	22,000	35 × 25	0.40	3.23	EKMH160VSN223MA25S		4,700	30 × 30	0.20	2.25	EKMH500VSN472MR30S	
	27,000	25.4 × 50	0.40	3.78	EKMH160VSN273MQ50S		4,700	35 × 25	0.20	2.48	EKMH500VSN472MA25S	
	27,000	30 × 40	0.40	3.77	EKMH160VSN273MR40S		5,600	22 × 50	0.20	2.75	EKMH500VSN562MP50S	



◆STANDARD RATINGS

WV (V _{dc})	Cap (μF)	Case size φD×L(mm)	tan δ	Rated ripple current (Arms/105°C, 120Hz)	Part No.	WV (V _{dc})	Cap (μF)	Case size φD×L(mm)	tan δ	Rated ripple current (Arms/105°C, 120Hz)	Part No.
50	5,600	25.4 × 40	0.20	2.70	EKMH500VSN562MQ40S	80	1,800	25.4 × 30	0.15	1.76	EKMH800VSN182MQ30S
	5,600	30 × 35	0.20	2.76	EKMH500VSN562MR35S		1,800	30 × 25	0.15	1.65	EKMH800VSN182MR25S
	5,600	35 × 25	0.20	2.70	EKMH500VSN562MA25S		2,200	22 × 45	0.15	2.04	EKMH800VSN222MP45S
	6,800	25.4 × 50	0.20	3.30	EKMH500VSN682MQ50S		2,200	25.4 × 35	0.15	2.01	EKMH800VSN222MQ35S
	6,800	30 × 40	0.20	3.30	EKMH500VSN682MR40S		2,200	30 × 30	0.15	2.05	EKMH800VSN222MR30S
	6,800	35 × 30	0.20	3.25	EKMH500VSN682MA30S		2,200	35 × 25	0.15	2.07	EKMH800VSN222MA25S
	8,200	30 × 45	0.20	3.60	EKMH500VSN822MR45S		2,700	25.4 × 45	0.15	2.36	EKMH800VSN272MQ45S
	8,200	35 × 35	0.20	3.55	EKMH500VSN822MA35S		2,700	30 × 35	0.15	2.35	EKMH800VSN272MR35S
	10,000	30 × 50	0.20	4.04	EKMH500VSN103MR50S		2,700	35 × 25	0.15	2.29	EKMH800VSN272MA25S
	10,000	35 × 40	0.20	4.03	EKMH500VSN103MA40S		3,300	25.4 × 50	0.15	2.68	EKMH800VSN332MQ50S
12,000	35 × 45	0.20	4.55	EKMH500VSN123MA45S	3,300	30 × 40	0.15	2.68	EKMH800VSN332MP40S		
63	1,200	22 × 25	0.15	1.19	EKMH630VSN122MP25S	3,300	35 × 30	0.15	2.45	EKMH800VSN332MA30S	
	1,500	22 × 25	0.15	1.33	EKMH630VSN152MP25S	3,900	30 × 45	0.15	3.00	EKMH800VSN392MR45S	
	1,800	22 × 30	0.15	1.51	EKMH630VSN182MP30S	3,900	35 × 35	0.15	2.98	EKMH800VSN392MA35S	
	1,800	25.4 × 25	0.15	1.52	EKMH630VSN182MQ25S	4,700	30 × 50	0.15	3.39	EKMH800VSN472MR50S	
	2,200	22 × 35	0.15	1.73	EKMH630VSN222MP35S	4,700	35 × 40	0.15	3.38	EKMH800VSN472MA40S	
	2,200	25.4 × 30	0.15	1.74	EKMH630VSN222MQ30S	5,600	35 × 45	0.15	3.80	EKMH800VSN562MA45S	
	2,700	22 × 40	0.15	1.97	EKMH630VSN272MP40S	6,800	35 × 50	0.15	3.90	EKMH800VSN682MA50S	
	2,700	25.4 × 35	0.15	1.99	EKMH630VSN272MQ35S	100	560	22 × 25	0.15	1.05	EKMH101VSN561MP25S
	2,700	30 × 25	0.15	1.76	EKMH630VSN272MR25S		820	22 × 30	0.15	1.32	EKMH101VSN821MP30S
	3,300	22 × 50	0.15	2.29	EKMH630VSN332MP50S		820	25.4 × 25	0.15	1.33	EKMH101VSN821MQ25S
	3,300	25.4 × 40	0.15	2.27	EKMH630VSN332MQ40S		1,000	22 × 35	0.15	1.50	EKMH101VSN102MP35S
	3,300	30 × 30	0.15	2.24	EKMH630VSN332MR30S		1,000	25.4 × 30	0.15	1.51	EKMH101VSN102MQ30S
	3,300	35 × 25	0.15	2.06	EKMH630VSN332MA25S		1,200	22 × 40	0.15	1.69	EKMH101VSN122MP40S
	3,900	25.4 × 45	0.15	2.54	EKMH630VSN392MQ45S		1,200	25.4 × 35	0.15	1.71	EKMH101VSN122MQ35S
	3,900	30 × 35	0.15	2.55	EKMH630VSN392MR35S		1,200	30 × 25	0.15	1.68	EKMH101VSN122MR25S
	3,900	35 × 25	0.15	2.24	EKMH630VSN392MA25S		1,500	22 × 45	0.15	1.94	EKMH101VSN152MP45S
	4,700	25.4 × 50	0.15	2.86	EKMH630VSN472MQ50S		1,500	25.4 × 40	0.15	1.98	EKMH101VSN152MQ40S
	4,700	30 × 40	0.15	2.86	EKMH630VSN472MR40S		1,500	30 × 30	0.15	1.95	EKMH101VSN152MR30S
	4,700	35 × 30	0.15	2.79	EKMH630VSN472MA30S		1,500	35 × 25	0.15	1.98	EKMH101VSN152MA25S
	5,600	30 × 45	0.15	3.22	EKMH630VSN562MR45S		1,800	25.4 × 45	0.15	2.23	EKMH101VSN182MQ45S
5,600	35 × 35	0.15	3.19	EKMH630VSN562MA35S	1,800		30 × 35	0.15	2.50	EKMH101VSN182MR35S	
6,800	30 × 50	0.15	3.65	EKMH630VSN682MR50S	1,800		35 × 25	0.15	2.17	EKMH101VSN182MA25S	
6,800	35 × 40	0.15	3.64	EKMH630VSN682MA40S	2,200		25.4 × 50	0.15	2.53	EKMH101VSN222MQ50S	
8,200	35 × 45	0.15	3.90	EKMH630VSN822MR45S	2,200		30 × 40	0.15	2.70	EKMH101VSN222MR40S	
10,000	35 × 50	0.15	4.40	EKMH630VSN103MA50S	2,200		35 × 30	0.15	2.50	EKMH101VSN222MA30S	
80	820	22 × 25	0.15	1.11	EKMH800VSN821MP25S		2,700	30 × 45	0.15	2.88	EKMH101VSN272MR45S
	1,000	22 × 25	0.15	1.22	EKMH800VSN102MP25S		2,700	35 × 35	0.15	2.86	EKMH101VSN272MA35S
	1,200	22 × 30	0.15	1.38	EKMH800VSN122MP30S	3,300	30 × 50	0.15	3.28	EKMH101VSN332MR50S	
	1,200	25.4 × 25	0.15	1.39	EKMH800VSN122MQ25S	3,300	35 × 40	0.15	3.27	EKMH101VSN332MA40S	
	1,500	22 × 35	0.15	1.59	EKMH800VSN152MP35S	3,900	35 × 45	0.15	3.67	EKMH101VSN392MA45S	
	1,500	25.4 × 30	0.15	1.61	EKMH800VSN152MQ30S	4,700	35 × 50	0.15	3.80	EKMH101VSN472MA50S	
	1,800	22 × 40	0.15	1.80	EKMH800VSN182MP40S						

*For the rated voltage ≥ 160V_{dc}, please use KMR and KMQ series.

◆RATED RIPPLE CURRENT MULTIPLIERS

●Frequency Multipliers

Frequency(Hz)	50	120	300	1k	10k	50k
6.3 to 50V _{dc}	0.95	1.00	1.03	1.05	1.08	1.08
63 to 100V _{dc}	0.92	1.00	1.07	1.13	1.19	1.20

The deterioration of aluminum electrolytic capacitors accelerates their life due to the internal heating produced by ripple current. For details, refer to Section "5-3 Ripple Current Effect on Lifetime" in the catalog, Technical Note.

TXH Series

- Endurance with ripple current : 10,000 hours at 105°C
- Non solvent resistant type
- RoHS2 Compliant

TXH

↑ Longer life
LXM



◆ SPECIFICATIONS

Items	Characteristics		
Category	-25 to +105°C		
Temperature Range	-25 to +105°C		
Rated Voltage Range	200 to 450V _{dc}		
Capacitance Tolerance	±20% (M) (at 20°C, 120Hz)		
Leakage Current	I ≤ 3√CV Where, I : Max. leakage current (µA), C : Nominal capacitance (µF), V : Rated voltage (V) (at 20°C after 5 minutes)		
Dissipation Factor (tan δ)	Rated voltage (V _{dc})	200 to 400V	450V
	tan δ (Max.)	0.15	0.20
Low Temperature Characteristics (Max. Impedance Ratio)	Rated voltage (V _{dc})	200 to 400V	450V
	Z (-25°C)/Z (+20°C)	4	8
Endurance	The following specifications shall be satisfied when the capacitors are restored to 20°C after subjected to DC voltage with the rated ripple current is applied (the peak voltage shall not exceed the rated voltage) for 10,000 hours at 105°C.		
	Capacitance change	≤ ±20% of the initial value	
	D.F. (tan δ)	≤ 200% of the initial specified value	
	Leakage current	≤ The initial specified value	
Shelf Life	The following specifications shall be satisfied when the capacitors are restored to 20°C after exposing them for 1,000 hours at 105°C without voltage applied. Before the measurement, the capacitor shall be preconditioned by applying voltage according to Item 4.1 of JIS C 5101-4.		
	Capacitance change	≤ ±15% of the initial value	
	D.F. (tan δ)	≤ 150% of the initial specified value	
	Leakage current	≤ The initial specified value	

◆ DIMENSIONS [mm]

● Terminal Code : VS (φ30 to φ40) : Standard

● Terminal Code : LI (φ35, φ40)

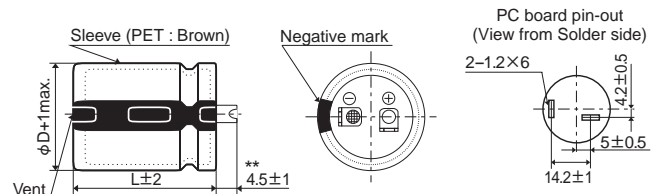
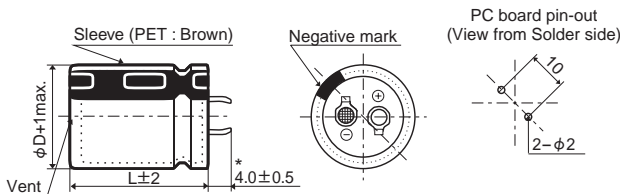

* φD=40mm : 3.5±0.5mm

** φD=40mm : 4.0±1

The standard design has no plastic disc.

◆ PART NUMBERING SYSTEM

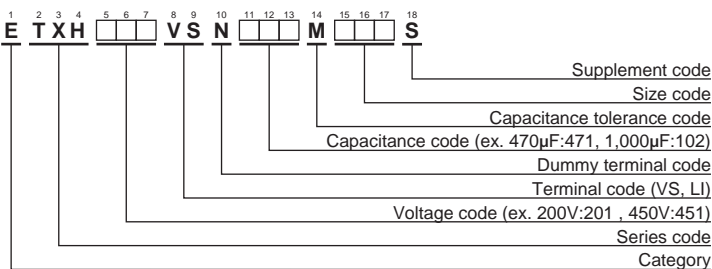

Please refer to "Product code guide (snap-in type)"

◆STANDARD RATINGS

WV (V _{dc})	Cap (μF)	Case size φD×L(mm)	tan δ	Rated ripple current (Arms/105°C, 120Hz)	Part No.	WV (V _{dc})	Cap (μF)	Case size φD×L(mm)	tan δ	Rated ripple current (Arms/105°C, 120Hz)	Part No.
200	560	30 × 30	0.15	1.50	ETXH201VSN561MR30S	400	220	30 × 35	0.15	1.00	ETXH401VSN221MR35S
	680	30 × 35	0.15	1.70	ETXH201VSN681MR35S		270	30 × 40	0.15	1.15	ETXH401VSN271MR40S
	820	30 × 40	0.15	2.00	ETXH201VSN821MR40S		270	35 × 30	0.15	1.13	ETXH401VSN271MA30S
	820	35 × 30	0.15	2.00	ETXH201VSN821MA30S		330	30 × 45	0.15	1.29	ETXH401VSN331MR45S
	1,000	30 × 45	0.15	2.20	ETXH201VSN102MR45S		330	35 × 35	0.15	1.26	ETXH401VSN331MA35S
	1,000	35 × 35	0.15	2.20	ETXH201VSN102MA35S		330	40 × 30	0.15	1.28	ETXH401VSN331MB30S
	1,000	40 × 30	0.15	2.17	ETXH201VSN102MB30S		390	30 × 50	0.15	1.44	ETXH401VSN391MR50S
	1,200	35 × 40	0.15	2.40	ETXH201VSN122MA40S		390	35 × 40	0.15	1.43	ETXH401VSN391MA40S
	1,200	40 × 35	0.15	2.45	ETXH201VSN122MB35S		470	35 × 45	0.15	1.60	ETXH401VSN471MA45S
	1,500	35 × 50	0.15	2.81	ETXH201VSN152MA50S		470	40 × 35	0.15	1.58	ETXH401VSN471MB35S
	1,500	40 × 40	0.15	2.79	ETXH201VSN152MB40S		560	35 × 50	0.15	1.79	ETXH401VSN561MA50S
	1,800	40 × 50	0.15	3.24	ETXH201VSN182MB50S		560	40 × 40	0.15	1.78	ETXH401VSN561MB40S
250	390	30 × 30	0.15	1.30	ETXH251VSN391MR30S	680	40 × 50	0.15	2.05	ETXH401VSN681MB50S	
	470	30 × 35	0.15	1.42	ETXH251VSN471MR35S	820	40 × 60	0.15	2.36	ETXH401VSN821MB60S	
	560	35 × 30	0.15	1.58	ETXH251VSN561MA30S	450	220	30 × 40	0.20	1.04	ETXH451VSN221MR40S
	680	30 × 45	0.15	1.80	ETXH251VSN681MR45S		220	35 × 30	0.20	1.02	ETXH451VSN221MA30S
	680	35 × 35	0.15	1.76	ETXH251VSN681MA35S		270	30 × 45	0.20	1.19	ETXH451VSN271MR45S
	820	30 × 50	0.15	2.03	ETXH251VSN821MR50S		270	35 × 35	0.20	1.16	ETXH451VSN271MA35S
	820	35 × 40	0.15	2.01	ETXH251VSN821MA40S		330	30 × 50	0.20	1.33	ETXH451VSN331MR50S
	820	40 × 30	0.15	1.96	ETXH251VSN821MB30S		330	35 × 40	0.20	1.32	ETXH451VSN331MA40S
	1,000	35 × 45	0.15	2.30	ETXH251VSN102MA45S		390	35 × 45	0.20	1.48	ETXH451VSN391MA45S
	1,000	40 × 35	0.15	2.27	ETXH251VSN102MB35S		470	35 × 50	0.20	1.64	ETXH451VSN471MA50S
	1,200	35 × 50	0.15	2.55	ETXH251VSN122MA50S		560	40 × 60	0.20	1.98	ETXH451VSN561MB60S
	1,200	40 × 40	0.15	2.53	ETXH251VSN122MB40S						
1,500	40 × 50	0.15	2.96	ETXH251VSN152MB50S							
1,800	40 × 60	0.15	3.39	ETXH251VSN182MB60S							

◆RATED RIPPLE CURRENT MULTIPLIERS

● Frequency Multipliers

Frequency(Hz)	50	120	300	1k	10k	50k
200, 250V _{dc}	0.81	1.00	1.17	1.32	1.45	1.50
400, 450V _{dc}	0.77	1.00	1.16	1.30	1.41	1.43

The deterioration of aluminum electrolytic capacitors accelerates their life due to the internal heating produced by ripple current. For details, refer to Section "5-3 Ripple Current Effect on Lifetime" in the catalog, Technical Note.



LXM Series

- Endurance with ripple current : 7,000 hours at 105°C
- Non solvent resistant type
- RoHS2 Compliant

LXM

Longer life

LXQ



SPECIFICATIONS

Items	Characteristics		
Category	-25 to +105°C		
Temperature Range	-25 to +105°C		
Rated Voltage Range	160 to 450V _{dc}		
Capacitance Tolerance	±20% (M) (at 20°C, 120Hz)		
Leakage Current	I ≤ 3√CV Where, I : Max. leakage current (μA), C : Nominal capacitance (μF), V : Rated voltage (V) (at 20°C after 5 minutes)		
Dissipation Factor (tan δ)	Rated voltage (V _{dc})	160 to 400V	420 & 450V
	tan δ (Max.)	0.15	0.20
Low Temperature Characteristics (Max. Impedance Ratio)	Rated voltage (V _{dc})	160 to 400V	420 & 450V
	Z (-25°C)/Z (+20°C)	4	8
Endurance	The following specifications shall be satisfied when the capacitors are restored to 20°C after subjected to DC voltage with the rated ripple current is applied (the peak voltage shall not exceed the rated voltage) for 7,000 hours at 105°C.		
	Capacitance change	≤ ±20% of the initial value	
	D.F. (tan δ)	≤ 250% of the initial specified value	
	Leakage current	≤ The initial specified value	
Shelf Life	The following specifications shall be satisfied when the capacitors are restored to 20°C after exposing them for 1,000 hours at 105°C without voltage applied. Before the measurement, the capacitor shall be preconditioned by applying voltage according to Item 4.1 of JIS C 5101-4.		
	Capacitance change	≤ ±15% of the initial value	
	D.F. (tan δ)	≤ 150% of the initial specified value	
	Leakage current	≤ The initial specified value	

DIMENSIONS [mm]

Terminal Code : VS (φ22 to φ35) : Standard

Terminal Code : LI (φ35)

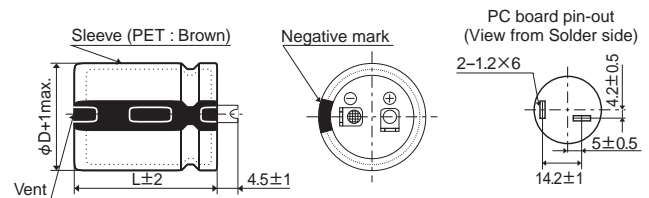
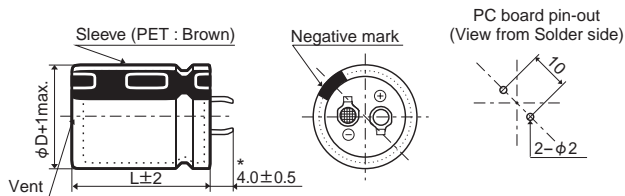

* φD=35mm : 3.5±0.5mm

The standard design has no plastic disc.

PART NUMBERING SYSTEM

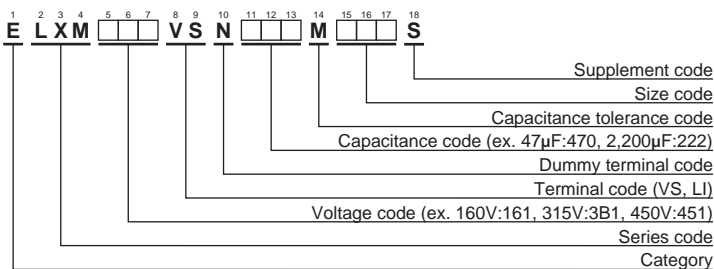

Please refer to "Product code guide (snap-in type)"

◆ STANDARD RATINGS

WV (V _{dc})	Cap (μF)	Case size φD×L(mm)	tan δ	Rated ripple current (Arms/105°C, 120Hz)	Part No.	WV (V _{dc})	Cap (μF)	Case size φD×L(mm)	tan δ	Rated ripple current (Arms/105°C, 120Hz)	Part No.
160	330	22 × 25	0.15	1.11	ELXM161VSN331MP25S	220	220	22 × 25	0.15	0.90	ELXM221VSN221MP25S
	390	22 × 30	0.15	1.26	ELXM161VSN391MP30S		270	22 × 30	0.15	1.05	ELXM221VSN271MP30S
	470	22 × 30	0.15	1.39	ELXM161VSN471MP30S		330	22 × 35	0.15	1.19	ELXM221VSN331MP35S
	470	25.4 × 25	0.15	1.38	ELXM161VSN471MQ25S		330	25.4 × 25	0.15	1.16	ELXM221VSN331MQ25S
	560	22 × 35	0.15	1.55	ELXM161VSN561MP35S		390	22 × 40	0.15	1.33	ELXM221VSN391MP40S
	560	25.4 × 30	0.15	1.55	ELXM161VSN561MQ30S		390	25.4 × 30	0.15	1.29	ELXM221VSN391MQ30S
	680	22 × 40	0.15	1.75	ELXM161VSN681MP40S		470	22 × 45	0.15	1.49	ELXM221VSN471MP45S
	680	25.4 × 35	0.15	1.78	ELXM161VSN681MQ35S		470	25.4 × 35	0.15	1.48	ELXM221VSN471MQ35S
	680	30 × 25	0.15	1.74	ELXM161VSN681MR25S		470	30 × 25	0.15	1.45	ELXM221VSN471MR25S
	820	22 × 50	0.15	1.97	ELXM161VSN821MP50S		560	22 × 50	0.15	1.63	ELXM221VSN561MP50S
	820	25.4 × 40	0.15	2.01	ELXM161VSN821MQ40S		560	25.4 × 40	0.15	1.71	ELXM221VSN561MQ40S
	820	30 × 30	0.15	1.96	ELXM161VSN821MR30S		560	30 × 30	0.15	1.62	ELXM221VSN561MR30S
	1,000	25.4 × 45	0.15	2.27	ELXM161VSN102MQ45S		680	25.4 × 45	0.15	1.87	ELXM221VSN681MQ45S
	1,000	30 × 35	0.15	2.26	ELXM161VSN102MR35S		680	30 × 35	0.15	1.86	ELXM221VSN681MR35S
	1,200	25.4 × 50	0.15	2.54	ELXM161VSN122MQ50S		820	25.4 × 50	0.15	2.10	ELXM221VSN821MQ50S
	1,200	30 × 40	0.15	2.56	ELXM161VSN122MR40S		820	30 × 40	0.15	2.12	ELXM221VSN821MR40S
	1,200	35 × 30	0.15	2.52	ELXM161VSN122MA30S		820	35 × 30	0.15	2.08	ELXM221VSN821MA30S
	1,500	30 × 45	0.15	2.96	ELXM161VSN152MR45S		1,000	30 × 50	0.15	2.48	ELXM221VSN102MR50S
	1,500	35 × 35	0.15	2.89	ELXM161VSN152MA35S		1,000	35 × 40	0.15	2.46	ELXM221VSN102MA40S
	1,800	30 × 50	0.15	3.32	ELXM161VSN182MR50S		1,200	35 × 45	0.15	2.78	ELXM221VSN122MA45S
1,800	35 × 40	0.15	3.30	ELXM161VSN182MA40S	1,500	35 × 50	0.15	3.20	ELXM221VSN152MA50S		
2,200	35 × 50	0.15	3.87	ELXM161VSN222MA50S	180	22 × 25	0.15	0.82	ELXM251VSN181MP25S		
180	270	22 × 25	0.15	1.00	ELXM181VSN271MP25S	220	22 × 30	0.15	0.95	ELXM251VSN221MP30S	
	330	22 × 30	0.15	1.16	ELXM181VSN331MP30S	270	22 × 35	0.15	1.08	ELXM251VSN271MP35S	
	390	22 × 30	0.15	1.26	ELXM181VSN391MP30S	270	25.4 × 25	0.15	1.05	ELXM251VSN271MQ25S	
	390	25.4 × 25	0.15	1.26	ELXM181VSN391MQ25S	330	22 × 40	0.15	1.22	ELXM251VSN331MP40S	
	470	22 × 35	0.15	1.42	ELXM181VSN471MP35S	330	25.4 × 30	0.15	1.19	ELXM251VSN331MQ30S	
	470	25.4 × 30	0.15	1.42	ELXM181VSN471MQ30S	390	22 × 45	0.15	1.36	ELXM251VSN391MP45S	
	560	22 × 40	0.15	1.59	ELXM181VSN561MP40S	390	25.4 × 35	0.15	1.35	ELXM251VSN391MQ35S	
	560	25.4 × 30	0.15	1.55	ELXM181VSN561MQ30S	390	30 × 25	0.15	1.32	ELXM251VSN391MR25S	
	560	30 × 25	0.15	1.58	ELXM181VSN561MR25S	470	22 × 50	0.15	1.49	ELXM251VSN471MP50S	
	680	22 × 45	0.15	1.79	ELXM181VSN681MP45S	470	25.4 × 40	0.15	1.52	ELXM251VSN471MQ40S	
	680	25.4 × 35	0.15	1.78	ELXM181VSN681MQ35S	470	30 × 30	0.15	1.49	ELXM251VSN471MR30S	
	680	30 × 30	0.15	1.79	ELXM181VSN681MR30S	560	25.4 × 45	0.15	1.70	ELXM251VSN561MQ45S	
	820	25.4 × 40	0.15	2.01	ELXM181VSN821MQ40S	560	30 × 35	0.15	1.69	ELXM251VSN561MR35S	
	820	30 × 35	0.15	2.04	ELXM181VSN821MR35S	680	25.4 × 50	0.15	1.91	ELXM251VSN681MQ50S	
	1,000	25.4 × 50	0.15	2.32	ELXM181VSN102MQ50S	680	30 × 40	0.15	1.93	ELXM251VSN681MR40S	
	1,000	30 × 35	0.15	2.26	ELXM181VSN102MR35S	680	35 × 30	0.15	1.90	ELXM251VSN681MA30S	
	1,000	35 × 30	0.15	2.30	ELXM181VSN102MA30S	820	30 × 45	0.15	2.19	ELXM251VSN821MP45S	
	1,200	30 × 45	0.15	2.65	ELXM181VSN122MR45S	820	35 × 35	0.15	2.13	ELXM251VSN821MA35S	
	1,200	35 × 35	0.15	2.58	ELXM181VSN122MA35S	1,000	35 × 40	0.15	2.46	ELXM251VSN102MA40S	
	1,500	30 × 50	0.15	3.03	ELXM181VSN152MR50S	1,200	35 × 50	0.15	2.86	ELXM251VSN122MA50S	
1,500	35 × 40	0.15	3.01	ELXM181VSN152MA40S	100	22 × 25	0.15	0.67	ELXM3B1VSN101MP25S		
1,800	35 × 45	0.15	3.41	ELXM181VSN182MA45S	120	22 × 30	0.15	0.77	ELXM3B1VSN121MP30S		
2,200	35 × 50	0.15	3.87	ELXM181VSN222MA50S	150	22 × 30	0.15	0.86	ELXM3B1VSN151MP30S		
200	220	22 × 25	0.15	0.90	ELXM201VSN221MP25S	150	25.4 × 25	0.15	0.85	ELXM3B1VSN151MQ25S	
	270	22 × 30	0.15	1.05	ELXM201VSN271MP30S	180	22 × 35	0.15	0.96	ELXM3B1VSN181MP35S	
	330	22 × 30	0.15	1.16	ELXM201VSN331MP30S	180	25.4 × 30	0.15	0.96	ELXM3B1VSN181MQ30S	
	330	25.4 × 25	0.15	1.16	ELXM201VSN331MQ25S	220	22 × 40	0.15	1.09	ELXM3B1VSN221MP40S	
	390	22 × 35	0.15	1.29	ELXM201VSN391MP35S	220	25.4 × 30	0.15	1.06	ELXM3B1VSN221MQ30S	
	390	25.4 × 30	0.15	1.29	ELXM201VSN391MQ30S	220	30 × 25	0.15	1.08	ELXM3B1VSN221MR25S	
	470	22 × 40	0.15	1.46	ELXM201VSN471MP40S	270	22 × 45	0.15	1.24	ELXM3B1VSN271MP45S	
	470	25.4 × 30	0.15	1.42	ELXM201VSN471MQ30S	270	25.4 × 35	0.15	1.23	ELXM3B1VSN271MQ35S	
	470	30 × 25	0.15	1.45	ELXM201VSN471MR25S	270	30 × 30	0.15	1.23	ELXM3B1VSN271MR30S	
	560	22 × 45	0.15	1.63	ELXM201VSN561MP45S	330	25.4 × 40	0.15	1.40	ELXM3B1VSN331MQ40S	
	560	25.4 × 35	0.15	1.62	ELXM201VSN561MQ35S	330	30 × 35	0.15	1.42	ELXM3B1VSN331MR35S	
	560	30 × 30	0.15	1.62	ELXM201VSN561MR30S	330	35 × 30	0.15	1.45	ELXM3B1VSN331MA30S	
	680	25.4 × 40	0.15	1.83	ELXM201VSN681MQ40S	390	25.4 × 50	0.15	1.59	ELXM3B1VSN391MQ50S	
	680	30 × 30	0.15	1.79	ELXM201VSN681MR30S	390	30 × 35	0.15	1.54	ELXM3B1VSN391MR35S	
	820	25.4 × 45	0.15	2.06	ELXM201VSN821MQ45S	390	35 × 30	0.15	1.57	ELXM3B1VSN391MA30S	
	820	30 × 35	0.15	2.04	ELXM201VSN821MR35S	470	30 × 45	0.15	1.81	ELXM3B1VSN471MR45S	
	1,000	30 × 45	0.15	2.42	ELXM201VSN102MR45S	470	35 × 35	0.15	1.77	ELXM3B1VSN471MA35S	
	1,000	35 × 30	0.15	2.30	ELXM201VSN102MA30S	560	30 × 50	0.15	2.03	ELXM3B1VSN561MR50S	
	1,200	30 × 50	0.15	2.71	ELXM201VSN122MR50S	560	35 × 40	0.15	2.02	ELXM3B1VSN561MA40S	
	1,200	35 × 40	0.15	2.70	ELXM201VSN122MA40S	680	35 × 45	0.15	2.29	ELXM3B1VSN681MA45S	
1,500	35 × 45	0.15	3.11	ELXM201VSN152MA45S	820	35 × 50	0.15	2.59	ELXM3B1VSN821MA50S		
1,800	35 × 50	0.15	3.50	ELXM201VSN182MA50S							



◆STANDARD RATINGS

WV (V _{dc})	Cap (μF)	Case size φD×L(mm)	tan δ	Rated ripple current (Arms/105°C, 120Hz)	Part No.	WV (V _{dc})	Cap (μF)	Case size φD×L(mm)	tan δ	Rated ripple current (Arms/105°C, 120Hz)	Part No.
350	100	22 × 25	0.15	0.67	ELXM351VSN101MP25S	420	56	22 × 25	0.20	0.50	ELXM421VSN560MP25S
	120	22 × 30	0.15	0.77	ELXM351VSN121MP30S		68	22 × 30	0.20	0.58	ELXM421VSN680MP30S
	120	25.4 × 25	0.15	0.76	ELXM351VSN121MQ25S		82	22 × 30	0.20	0.63	ELXM421VSN820MP30S
	150	22 × 35	0.15	0.88	ELXM351VSN151MP35S		82	25.4 × 25	0.20	0.63	ELXM421VSN820MQ25S
	150	25.4 × 30	0.15	0.88	ELXM351VSN151MQ30S		100	22 × 35	0.20	0.72	ELXM421VSN101MP35S
	180	22 × 40	0.15	0.99	ELXM351VSN181MP40S		100	25.4 × 30	0.20	0.72	ELXM421VSN101MQ30S
	180	25.4 × 30	0.15	0.96	ELXM351VSN181MQ30S		120	22 × 40	0.20	0.81	ELXM421VSN121MP40S
	180	30 × 25	0.15	0.98	ELXM351VSN181MR25S		120	25.4 × 30	0.20	0.79	ELXM421VSN121MQ30S
	220	22 × 45	0.15	1.12	ELXM351VSN221MP45S		120	30 × 25	0.20	0.80	ELXM421VSN121MR25S
	220	25.4 × 35	0.15	1.11	ELXM351VSN221MQ35S		150	22 × 45	0.20	0.92	ELXM421VSN151MP45S
	220	30 × 30	0.15	1.11	ELXM351VSN221MR30S		150	25.4 × 35	0.20	0.92	ELXM421VSN151MQ35S
	270	25.4 × 40	0.15	1.26	ELXM351VSN271MQ40S		150	30 × 30	0.20	0.92	ELXM421VSN151MR30S
	270	30 × 35	0.15	1.28	ELXM351VSN271MR35S		180	25.4 × 40	0.20	1.03	ELXM421VSN181MQ40S
	330	25.4 × 45	0.15	1.40	ELXM351VSN331MQ45S		180	30 × 35	0.20	1.05	ELXM421VSN181MR35S
	330	30 × 35	0.15	1.42	ELXM351VSN331MR35S		220	25.4 × 50	0.20	1.19	ELXM421VSN221MQ50S
	330	35 × 30	0.15	1.45	ELXM351VSN331MA30S		220	30 × 35	0.20	1.16	ELXM421VSN221MR35S
	390	30 × 40	0.15	1.60	ELXM351VSN391MR40S		220	35 × 30	0.20	1.18	ELXM421VSN221MA30S
	390	35 × 35	0.15	1.61	ELXM351VSN391MA35S		270	30 × 45	0.20	1.38	ELXM421VSN271MR45S
	470	30 × 50	0.15	1.86	ELXM351VSN471MR50S		270	35 × 35	0.20	1.34	ELXM421VSN271MA35S
	470	35 × 40	0.15	1.85	ELXM351VSN471MA40S		330	30 × 50	0.20	1.56	ELXM421VSN331MR50S
560	35 × 40	0.15	2.02	ELXM351VSN561MA40S	330	35 × 40	0.20	1.55	ELXM421VSN331MA40S		
680	35 × 50	0.15	2.36	ELXM351VSN681MA50S	390	35 × 45	0.20	1.74	ELXM421VSN391MA45S		
400	68	22 × 25	0.15	0.55	ELXM401VSN680MP25S	470	35 × 50	0.20	1.96	ELXM421VSN471MA50S	
	82	22 × 30	0.15	0.63	ELXM401VSN820MP30S	450	47	22 × 25	0.20	0.46	ELXM451VSN470MP25S
	100	22 × 30	0.15	0.70	ELXM401VSN101MP30S		56	22 × 30	0.20	0.52	ELXM451VSN560MP30S
	100	25.4 × 25	0.15	0.70	ELXM401VSN101MQ25S		68	22 × 30	0.20	0.58	ELXM451VSN680MP30S
	120	22 × 35	0.15	0.79	ELXM401VSN121MP35S		68	25.4 × 25	0.20	0.58	ELXM451VSN680MQ25S
	120	25.4 × 30	0.15	0.79	ELXM401VSN121MQ30S		82	22 × 35	0.20	0.65	ELXM451VSN820MP35S
	150	22 × 40	0.15	0.90	ELXM401VSN151MP40S		82	25.4 × 30	0.20	0.65	ELXM451VSN820MQ30S
	150	25.4 × 30	0.15	0.88	ELXM401VSN151MQ30S		100	22 × 40	0.20	0.74	ELXM451VSN101MP40S
	150	30 × 25	0.15	0.90	ELXM401VSN151MR25S		100	25.4 × 30	0.20	0.72	ELXM451VSN101MQ30S
	180	22 × 45	0.15	0.99	ELXM401VSN181MP45S		100	30 × 25	0.20	0.73	ELXM451VSN101MR25S
	180	25.4 × 35	0.15	1.01	ELXM401VSN181MQ35S		120	22 × 45	0.20	0.83	ELXM451VSN121MP45S
	180	30 × 30	0.15	1.01	ELXM401VSN181MR30S		120	25.4 × 35	0.20	0.82	ELXM451VSN121MQ35S
	220	25.4 × 40	0.15	1.14	ELXM401VSN221MQ40S		120	30 × 30	0.20	0.82	ELXM451VSN121MR30S
	220	30 × 35	0.15	1.16	ELXM401VSN221MR35S		150	25.4 × 40	0.20	0.94	ELXM451VSN151MQ40S
	270	25.4 × 50	0.15	1.32	ELXM401VSN271MQ50S		150	30 × 35	0.20	0.96	ELXM451VSN151MR35S
	270	30 × 40	0.15	1.33	ELXM401VSN271MR40S		180	25.4 × 45	0.20	1.06	ELXM451VSN181MQ45S
	270	35 × 30	0.15	1.31	ELXM401VSN271MA30S		180	30 × 35	0.20	1.05	ELXM451VSN181MR35S
	330	30 × 45	0.15	1.52	ELXM401VSN331MR45S		180	35 × 30	0.20	1.07	ELXM451VSN181MA30S
	330	35 × 35	0.15	1.48	ELXM401VSN331MA35S		220	30 × 40	0.20	1.20	ELXM451VSN221MR40S
	390	30 × 50	0.15	1.69	ELXM401VSN391MR50S		220	35 × 35	0.20	1.21	ELXM451VSN221MA35S
390	35 × 40	0.15	1.68	ELXM401VSN391MA40S	270		30 × 50	0.20	1.41	ELXM451VSN271MR50S	
470	35 × 45	0.15	1.91	ELXM401VSN471MA45S	270	35 × 40	0.20	1.40	ELXM451VSN271MA40S		
560	35 × 50	0.15	2.14	ELXM401VSN561MA50S	330	35 × 45	0.20	1.60	ELXM451VSN331MA45S		
					390	35 × 50	0.20	1.79	ELXM451VSN391MA50S		

◆RATED RIPPLE CURRENT MULTIPLIERS

● Frequency Multipliers

Frequency(Hz)	50	120	300	1k	10k	50k
160 to 250V _{dc}	0.81	1.00	1.17	1.32	1.45	1.50
315 to 450V _{dc}	0.77	1.00	1.16	1.30	1.41	1.43

The deterioration of aluminum electrolytic capacitors accelerates their life due to the internal heating produced by ripple current. For details, refer to Section "5-3 Ripple Current Effect on Lifetime" in the catalog, Technical Note.

LRB Series

- Higher ripple current on high frequency band
- Endurance with high frequency ripple current : 5,000 hours at 105°C
- Rated voltage range : 400 to 450V_{dc}, Capacitance range : 85 to 330μF
- Ideal for high frequency drive power conversion system applications such as solar power conditioners
- Non solvent resistant type
- RoHS2 Compliant



SPECIFICATIONS

Items	Characteristics		
Category	-40 to +105°C		
Temperature Range			
Rated Voltage Range	400 to 450V _{dc}		
Capacitance Tolerance	±20% (M) (at 20°C, 120Hz)		
Leakage Current	I ≤ 3/CV Where, I : Max. leakage current (μA), C : Nominal capacitance (μF), V : Rated voltage (V) (at 20°C after 5 minutes)		
Dissipation Factor (tan δ)	Rated voltage (V _{dc})	400V	420 & 450V
	tan δ (Max.)	0.15	0.20
	(at 20°C, 120Hz)		
Low Temperature Characteristics (Max. Impedance Ratio)	Rated voltage (V _{dc})	400V	420 & 450V
	Z(-25°C)/Z(+20°C)	3	8
	Z(-40°C)/Z(+20°C)	12	14
	(at 120Hz)		
Endurance	The following specifications shall be satisfied when the capacitors are restored to 20°C after subjected to DC voltage with the rated ripple current is applied (the peak voltage shall not exceed the rated voltage) for 5,000 hours at 105°C.		
	Capacitance change	≤ ±20% of the initial value	
	D.F. (tan δ)	≤ 200% of the initial specified value	
	Leakage current	≤ The initial specified value	
Shelf Life	The following specifications shall be satisfied when the capacitors are restored to 20°C after exposing them for 1,000 hours at 105°C without voltage applied. Before the measurement, the capacitor shall be preconditioned by applying voltage according to Item 4.1 of JIS C 5101-4.		
	Capacitance change	≤ ±15% of the initial value	
	D.F. (tan δ)	≤ 150% of the initial specified value	
	Leakage current	≤ The initial specified value	

DIMENSIONS [mm]

Terminal Code : VS (φ30, φ35) : Standard

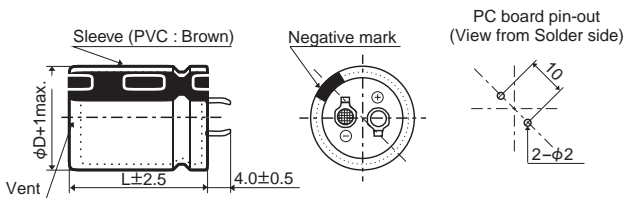

The standard design has no plastic disc.

Terminal Code : LI (φ30, φ35)

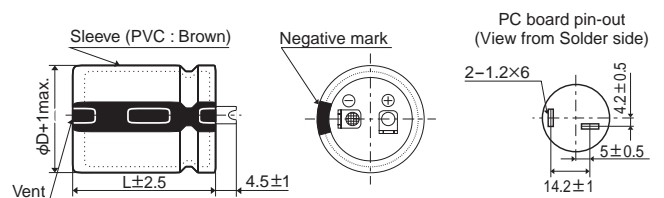

PART NUMBERING SYSTEM

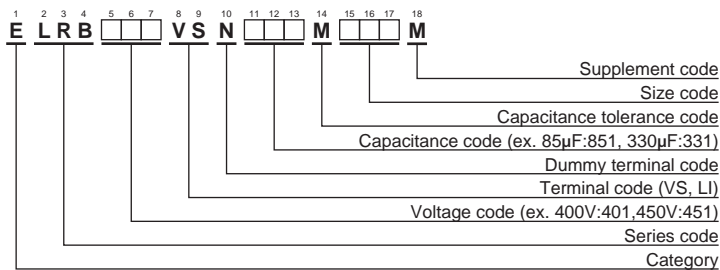

Please refer to "Product code guide (snap-in type)"



LRB Series

◆ STANDARD RATINGS

WV (V _{dc})	Cap (μF)	Case size φD×L(mm)	tan δ	Rated ripple current (Arms/105°C, 100kHz)	Part No.	WV (V _{dc})	Cap (μF)	Case size φD×L(mm)	tan δ	Rated ripple current (Arms/105°C, 100kHz)	Part No.
400	120	30 × 35	0.15	5.54	ELRB401VSN121MR35M	450	85	30 × 35	0.20	4.58	ELRB451VSN850MR35M
	150	30 × 41	0.15	5.69	ELRB401VSN151MR41M		110	30 × 41	0.20	4.91	ELRB451VSN111MR41M
	170	30 × 46	0.15	5.83	ELRB401VSN171MR46M		120	30 × 46	0.20	5.15	ELRB451VSN121MR46M
	170	35 × 35	0.15	5.87	ELRB401VSN171MA35M		120	35 × 35	0.20	5.23	ELRB451VSN121MA35M
	190	30 × 51	0.15	5.97	ELRB401VSN191MR51M		140	30 × 51	0.20	5.39	ELRB451VSN141MR51M
	210	30 × 54	0.15	6.06	ELRB401VSN211MR54M		150	30 × 54	0.20	5.54	ELRB451VSN151MR54M
	210	35 × 41	0.15	6.10	ELRB401VSN211MA41M		150	35 × 41	0.20	5.63	ELRB451VSN151MA41M
	230	30 × 59	0.15	6.20	ELRB401VSN231MR59M		170	30 × 59	0.20	5.78	ELRB451VSN171MR59M
	230	35 × 46	0.15	6.30	ELRB401VSN231MA46M		170	35 × 46	0.20	5.95	ELRB451VSN171MA46M
	270	35 × 51	0.15	6.45	ELRB401VSN271MA51M		200	35 × 51	0.20	6.28	ELRB451VSN201MA51M
	290	35 × 54	0.15	6.60	ELRB401VSN291MA54M		210	35 × 54	0.20	6.47	ELRB451VSN211MA54M
	330	35 × 59	0.15	6.85	ELRB401VSN331MA59M		240	35 × 59	0.20	6.72	ELRB451VSN241MA59M
	420	100	30 × 35	0.20	4.58		ELRB421VSN101MR35M				
120		30 × 41	0.20	4.91	ELRB421VSN121MR41M						
140		30 × 46	0.20	5.15	ELRB421VSN141MR46M						
140		35 × 35	0.20	5.23	ELRB421VSN141MA35M						
160		30 × 51	0.20	5.39	ELRB421VSN161MR51M						
170		30 × 54	0.20	5.54	ELRB421VSN171MR54M						
170		35 × 41	0.20	5.63	ELRB421VSN171MA41M						
190		30 × 59	0.20	5.78	ELRB421VSN191MR59M						
200		35 × 46	0.20	5.95	ELRB421VSN201MA46M						
230		35 × 51	0.20	6.28	ELRB421VSN231MA51M						
250		35 × 54	0.20	6.47	ELRB421VSN251MA54M						
280	35 × 59	0.20	6.72	ELRB421VSN281MA59M							

◆ RATED RIPPLE CURRENT MULTIPLIERS

● Frequency Multipliers

Frequency(Hz)	50	120	300	1k	10k	50k	100k
400 to 450V	0.22	0.33	0.49	0.73	1.00	1.00	1.00

The deterioration of aluminum electrolytic capacitors accelerates their life due to the internal heating produced by ripple current. For details, refer to Section "5-3 Ripple Current Effect on Lifetime" in the catalog, Technical Note.

LHX New! Series

- The LXS series has been improved to have a higher capacitance and ripple current.
- Endurance with ripple current : 5,000 hours at 105°C
- Rated voltage range : 350 to 400V, Capacitance range: 190 to 1,530μF
- Suitable for use in switching power supply equipment and inverters.
- Non solvent resistant type
- The logo mark printed on the sleeve will be changed.
- RoHS2 Compliant

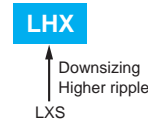

◆ SPECIFICATIONS

Items	Characteristics	
Category	-40 to +105°C	
Temperature Range	350 to 400V _{dc}	
Rated Voltage Range	±20% (M) (at 20°C, 120Hz)	
Capacitance Tolerance	I ≤ 3√CV Where, I : Max. leakage current (μA), C : Nominal capacitance (μF), V : Rated voltage (V) (at 20°C after 5 minutes)	
Leakage Current	Rated voltage (V _{dc})	350 to 400V
Dissipation Factor (tan δ)	tan δ (Max.)	0.15 (at 20°C, 120Hz)
	Rated voltage (V _{dc})	350 to 400V
Low Temperature Characteristics (Max. Impedance Ratio)	Z(-25°C)/Z(+20°C)	5
	Z(-40°C)/Z(+20°C)	20
	(at 120Hz)	
Endurance	The following specifications shall be satisfied when the capacitors are restored to 20°C after subjected to DC voltage with the rated ripple current is applied (the peak voltage shall not exceed the rated voltage) for 5,000 hours at 105°C.	
	Capacitance change	≤ ±20% of the initial value
	D.F. (tan δ)	≤ 200% of the initial specified value
	Leakage current	≤ The initial specified value
Shelf Life	The following specifications shall be satisfied when the capacitors are restored to 20°C after exposing them for 1,000 hours at 105°C without voltage applied. Before the measurement, the capacitor shall be preconditioned by applying voltage according to Item 4.1 of JIS C 5101-4.	
	Capacitance change	≤ ±15% of the initial value
	D.F. (tan δ)	≤ 150% of the initial specified value
	Leakage current	≤ The initial specified value

◆ DIMENSIONS [mm]

● Terminal Code : VS (φ22 to φ35) : Standard

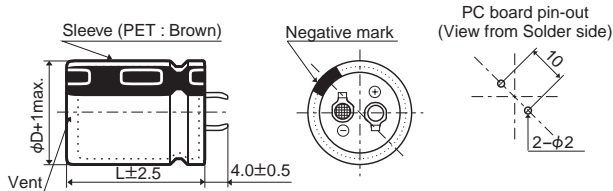

● Terminal Code : LI (φ30, φ35)

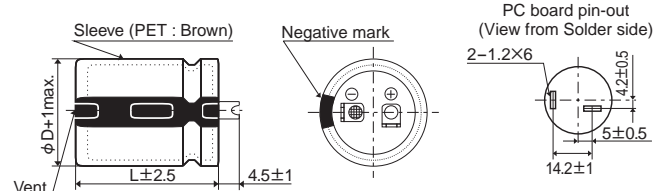

The standard design has no plastic disc.

◆ PART NUMBERING SYSTEM

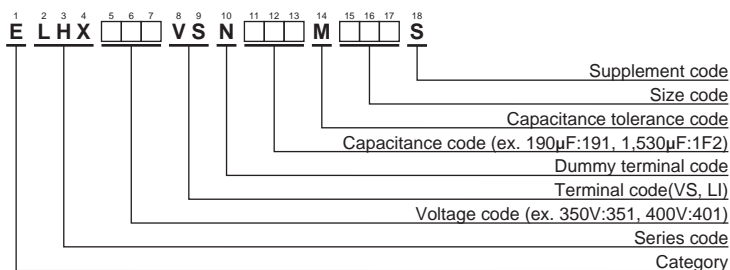

Please refer to "Product code guide (snap-in type)"



◆ **STANDARD RATINGS**

WV (V _{dc})	Cap (μF)	Case size φD×L(mm)	tan δ	Rated ripple current (Arms/105°C, 120Hz)	Part No.	WV (V _{dc})	Cap (μF)	Case size φD×L(mm)	tan δ	Rated ripple current (Arms/105°C, 120Hz)	Part No.	
350	230	22 × 30	0.15	1.70	ELHX351VSN231MP30S	375	560	25.4 × 50	0.15	2.85	ELHX3H1VSN561MQ50S	
	280	22 × 35	0.15	1.92	ELHX351VSN281MP35S		580	35 × 30	0.15	2.45	ELHX3H1VSN581MA30S	
	320	25.4 × 30	0.15	1.95	ELHX351VSN321MQ30S		630	25.4 × 55	0.15	3.07	ELHX3H1VSN631MQ55S	
	330	22 × 40	0.15	2.13	ELHX351VSN331MP40S		650	30 × 40	0.15	2.94	ELHX3H1VSN651MR40S	
	370	30 × 25	0.15	2.08	ELHX351VSN371MR25S		700	25.4 × 60	0.15	3.30	ELHX3H1VSN701MQ60S	
	380	22 × 45	0.15	2.33	ELHX351VSN381MP45S		720	35 × 35	0.15	2.77	ELHX3H1VSN721MA35S	
	390	25.4 × 35	0.15	2.25	ELHX351VSN391MQ35S		750	30 × 45	0.15	3.24	ELHX3H1VSN751MR45S	
	440	22 × 50	0.15	2.56	ELHX351VSN441MP50S		850	30 × 50	0.15	3.50	ELHX3H1VSN851MR50S	
	460	25.4 × 40	0.15	2.49	ELHX351VSN461MQ40S		860	35 × 40	0.15	3.13	ELHX3H1VSN861MA40S	
	480	30 × 30	0.15	2.40	ELHX351VSN481MR30S		960	30 × 55	0.15	3.80	ELHX3H1VSN961MR55S	
	480	35 × 25	0.15	2.19	ELHX351VSN481MA25S		1,000	35 × 45	0.15	3.47	ELHX3H1VSN102MA45S	
	490	22 × 55	0.15	2.75	ELHX351VSN491MP55S		1,060	30 × 60	0.15	4.07	ELHX3H1VSN1A2MR60S	
	540	22 × 60	0.15	2.94	ELHX351VSN541MP60S		1,140	35 × 50	0.15	3.78	ELHX3H1VSN1B2MA50S	
	540	25.4 × 45	0.15	2.76	ELHX351VSN541MQ45S		1,280	35 × 55	0.15	4.09	ELHX3H1VSN132MA55S	
	590	30 × 35	0.15	2.72	ELHX351VSN591MR35S		1,410	35 × 60	0.15	4.37	ELHX3H1VSN142MA60S	
	610	25.4 × 50	0.15	2.98	ELHX351VSN611MQ50S		400	190	22 × 30	0.15	1.54	ELHX401VSN191MP30S
	630	35 × 30	0.15	2.56	ELHX351VSN631MA30S			240	22 × 35	0.15	1.78	ELHX401VSN241MP35S
	680	25.4 × 55	0.15	3.19	ELHX351VSN681MQ55S			270	25.4 × 30	0.15	1.80	ELHX401VSN271MQ30S
	710	30 × 40	0.15	3.07	ELHX351VSN711MR40S			290	22 × 40	0.15	1.99	ELHX401VSN291MP40S
	760	25.4 × 60	0.15	3.43	ELHX351VSN761MQ60S			320	30 × 25	0.15	1.93	ELHX401VSN321MR25S
	780	35 × 35	0.15	2.89	ELHX351VSN781MA35S			330	22 × 45	0.15	2.17	ELHX401VSN331MP45S
	820	30 × 45	0.15	3.38	ELHX351VSN821MR45S			340	25.4 × 35	0.15	2.10	ELHX401VSN341MQ35S
	930	30 × 50	0.15	3.67	ELHX351VSN931MR50S			380	22 × 50	0.15	2.38	ELHX401VSN381MP50S
	930	35 × 40	0.15	3.26	ELHX351VSN931MA40S			400	25.4 × 40	0.15	2.33	ELHX401VSN401MQ40S
	1,040	30 × 55	0.15	3.95	ELHX351VSN1A2MR55S			410	35 × 25	0.15	2.03	ELHX401VSN411MA25S
1,080	35 × 45	0.15	3.60	ELHX351VSN112MA45S	420	22 × 55		0.15	2.55	ELHX401VSN421MP55S		
1,150	30 × 60	0.15	4.24	ELHX351VSN1B2MR60S	420	30 × 30		0.15	2.24	ELHX401VSN421MR30S		
1,230	35 × 50	0.15	3.93	ELHX351VSN1C2MA50S	460	25.4 × 45		0.15	2.54	ELHX401VSN461MQ45S		
1,380	35 × 55	0.15	4.25	ELHX351VSN142MA55S	470	22 × 60		0.15	2.74	ELHX401VSN471MP60S		
1,530	35 × 60	0.15	4.55	ELHX351VSN1F2MA60S	510	30 × 35		0.15	2.53	ELHX401VSN511MR35S		
375	210	22 × 30	0.15	1.62	ELHX3H1VSN211MP30S	530		25.4 × 50	0.15	2.77	ELHX401VSN531MQ50S	
	260	22 × 35	0.15	1.85	ELHX3H1VSN261MP35S	540		35 × 30	0.15	2.37	ELHX401VSN541MA30S	
	290	25.4 × 30	0.15	1.86	ELHX3H1VSN291MQ30S	590		25.4 × 55	0.15	2.97	ELHX401VSN591MQ55S	
	310	22 × 40	0.15	2.06	ELHX3H1VSN311MP40S	610		30 × 40	0.15	2.85	ELHX401VSN611MR40S	
	350	22 × 45	0.15	2.23	ELHX3H1VSN351MP45S	650		25.4 × 60	0.15	3.18	ELHX401VSN651MQ60S	
	350	30 × 25	0.15	2.02	ELHX3H1VSN351MR25S	670		35 × 35	0.15	2.68	ELHX401VSN671MA35S	
	360	25.4 × 35	0.15	2.16	ELHX3H1VSN361MQ35S	700		30 × 45	0.15	3.13	ELHX401VSN701MR45S	
	400	22 × 50	0.15	2.44	ELHX3H1VSN401MP50S	800		30 × 50	0.15	3.40	ELHX401VSN801MR50S	
	430	25.4 × 40	0.15	2.41	ELHX3H1VSN431MQ40S	800		35 × 40	0.15	3.02	ELHX401VSN801MA40S	
	440	35 × 25	0.15	2.10	ELHX3H1VSN441MA25S	900		30 × 55	0.15	3.68	ELHX401VSN901MR55S	
	450	22 × 55	0.15	2.64	ELHX3H1VSN451MP55S	930	35 × 45	0.15	3.34	ELHX401VSN931MA45S		
	450	30 × 30	0.15	2.32	ELHX3H1VSN451MR30S	990	30 × 60	0.15	3.93	ELHX401VSN991MR60S		
	500	22 × 60	0.15	2.83	ELHX3H1VSN501MP60S	1,060	35 × 50	0.15	3.65	ELHX401VSN1A2MA50S		
	500	25.4 × 45	0.15	2.65	ELHX3H1VSN501MQ45S	1,190	35 × 55	0.15	3.94	ELHX401VSN122MA55S		
	550	30 × 35	0.15	2.63	ELHX3H1VSN551MR35S	1,320	35 × 60	0.15	4.23	ELHX401VSN132MA60S		



◆ HIGHER RIPPLE CURRENT RATINGS

WV (V _{dc})	Cap (μF)	Case size φD×L(mm)	tan δ	Rated ripple current (Arms/105°C, 120Hz)	Part No.	WV (V _{dc})	Cap (μF)	Case size φD×L(mm)	tan δ	Rated ripple current (Arms/105°C, 120Hz)	Part No.	
350	330	30 × 25	0.15	2.43	ELHX351VSN331MR25S	375	790	30 × 50	0.15	4.18	ELHX3H1VSN791MR50S	
	440	30 × 30	0.15	2.84	ELHX351VSN441MR30S		820	35 × 40	0.15	4.05	ELHX3H1VSN821MA40S	
	460	35 × 25	0.15	2.84	ELHX351VSN461MA25S		890	30 × 55	0.15	4.52	ELHX3H1VSN891MR55S	
	540	30 × 35	0.15	3.22	ELHX351VSN541MR35S		950	35 × 45	0.15	4.47	ELHX3H1VSN951MA45S	
	600	35 × 30	0.15	3.30	ELHX351VSN601MA30S		990	30 × 60	0.15	4.86	ELHX3H1VSN991MR60S	
	650	30 × 40	0.15	3.64	ELHX351VSN651MR40S		1,080	35 × 50	0.15	4.87	ELHX3H1VSN112MA50S	
	740	35 × 35	0.15	3.72	ELHX351VSN741MA35S		1,220	35 × 55	0.15	5.28	ELHX3H1VSN122MA55S	
	750	30 × 45	0.15	4.00	ELHX351VSN751MR45S		1,350	35 × 60	0.15	5.66	ELHX3H1VSN1D2MA60S	
	860	30 × 50	0.15	4.36	ELHX351VSN861MR50S		400	290	30 × 25	0.15	2.28	ELHX401VSN291MR25S
	890	35 × 40	0.15	4.22	ELHX351VSN891MA40S			380	30 × 30	0.15	2.64	ELHX401VSN381MR30S
	970	30 × 55	0.15	4.72	ELHX351VSN971MR55S			390	35 × 25	0.15	2.62	ELHX401VSN391MA25S
	1,030	35 × 45	0.15	4.66	ELHX351VSN1A2MA45S			470	30 × 35	0.15	3.00	ELHX401VSN471MR35S
	1,070	30 × 60	0.15	5.05	ELHX351VSN1A2MR60S			520	35 × 30	0.15	3.07	ELHX401VSN521MA30S
	1,180	35 × 50	0.15	5.09	ELHX351VSN122MA50S			560	30 × 40	0.15	3.37	ELHX401VSN561MR40S
1,320	35 × 55	0.15	5.50	ELHX351VSN132MA55S	640	35 × 35		0.15	3.46	ELHX401VSN641MA35S		
1,460	35 × 60	0.15	5.89	ELHX351VSN1E2MA60S	650	30 × 45		0.15	3.73	ELHX401VSN651MR45S		
375	310	30 × 25	0.15	2.36	ELHX3H1VSN311MR25S	740		30 × 50	0.15	4.04	ELHX401VSN741MR50S	
	400	30 × 30	0.15	2.71	ELHX3H1VSN401MR30S	770		35 × 40	0.15	3.92	ELHX401VSN771MA40S	
	420	35 × 25	0.15	2.72	ELHX3H1VSN421MA25S	830		30 × 55	0.15	4.37	ELHX401VSN831MR55S	
	500	30 × 35	0.15	3.10	ELHX3H1VSN501MR35S	890		35 × 45	0.15	4.33	ELHX401VSN891MA45S	
	550	35 × 30	0.15	3.16	ELHX3H1VSN551MA30S	920		30 × 60	0.15	4.69	ELHX401VSN921MR60S	
	600	30 × 40	0.15	3.49	ELHX3H1VSN601MR40S	1,020		35 × 50	0.15	4.73	ELHX401VSN102MA50S	
	690	35 × 35	0.15	3.59	ELHX3H1VSN691MA35S	1,140	35 × 55	0.15	5.11	ELHX401VSN1B2MA55S		
	700	30 × 45	0.15	3.87	ELHX3H1VSN701MR45S	1,260	35 × 60	0.15	5.47	ELHX401VSN1C2MA60S		

◆ RATED RIPPLE CURRENT MULTIPLIERS

● Frequency Multipliers

Frequency(Hz)	50	120	300	1k	10k	50k
350 to 400V _{dc}	0.70	1.00	1.10	1.17	1.25	1.31

The deterioration of aluminum electrolytic capacitors accelerates their life due to the internal heating produced by ripple current. For details, refer to Section "5-3 Ripple Current Effect on Lifetime" in the catalog, Technical Note.

LHJ Series

- Higher ripple current from LXS series
- Endurance with ripple current : 5,000 hours at 105°C
- Rated voltage range : 400 to 450V_{dc}, Capacitance range : 220 to 810μF
- For inverter control, switching power supplies
- Non solvent resistant type
- RoHS2 Compliant

LHJ

Higher ripple
LXS



SPECIFICATIONS

Items	Characteristics		
Category	-40 to +105°C		
Temperature Range	-40 to +105°C		
Rated Voltage Range	400 to 450V _{dc}		
Capacitance Tolerance	±20% (M) (at 20°C, 120Hz)		
Leakage Current	I ≤ 3/CV Where, I : Max. leakage current (μA), C : Nominal capacitance (μF), V : Rated voltage (V) (at 20°C after 5 minutes)		
Dissipation Factor (tan δ)	Rated voltage (V _{dc})	400V	420 & 450V
	tan δ (Max.)	0.15	0.20
Low Temperature Characteristics (Max. Impedance Ratio)	Rated voltage (V _{dc})	400V	420 & 450V
	Z(-25°C)/Z(+20°C)	3	8
	Z(-40°C)/Z(+20°C)	12	14
Endurance	The following specifications shall be satisfied when the capacitors are restored to 20°C after subjected to DC voltage with the rated ripple current is applied (the peak voltage shall not exceed the rated voltage) for 5,000 hours at 105°C.		
Shelf Life	Capacitance change	≤ ±20% of the initial value	
	D.F. (tan δ)	≤ 200% of the initial specified value	
	Leakage current	≤ The initial specified value	
Shelf Life	Capacitance change	≤ ±15% of the initial value	
	D.F. (tan δ)	≤ 150% of the initial specified value	
	Leakage current	≤ The initial specified value	

DIMENSIONS [mm]

Terminal Code : VS (φ30, φ35) : Standard

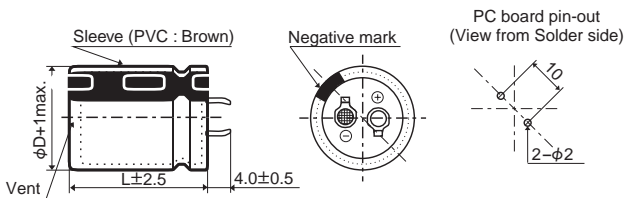

The standard design has no plastic disc.

Terminal Code : LI (φ30, φ35)

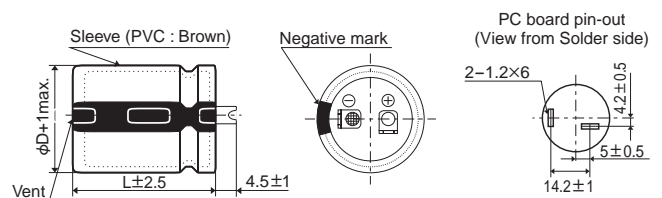

PART NUMBERING SYSTEM

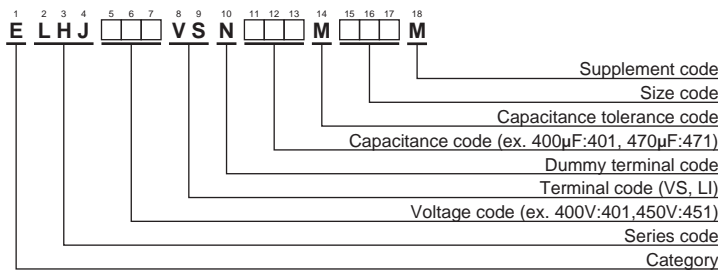

Please refer to "Product code guide (snap-in type)"



◆STANDARD RATINGS

WV (V _{dc})	Cap (μF)	Case size φD×L(mm)	tan δ	Rated ripple current (Arms/105°C, 120Hz)	Part No.	WV (V _{dc})	Cap (μF)	Case size φD×L(mm)	tan δ	Rated ripple current (Arms/105°C, 120Hz)	Part No.	
400	280	30 × 35	0.15	2.31	ELHJ401VSN281MR35M	420	440	30 × 54	0.20	3.06	ELHJ421VSN441MR54M	
	350	30 × 41	0.15	2.67	ELHJ401VSN351MR41M		490	30 × 59	0.20	3.28	ELHJ421VSN491MR59M	
	400	30 × 46	0.15	2.92	ELHJ401VSN401MR46M		490	35 × 46	0.20	3.22	ELHJ421VSN491MA46M	
	400	35 × 35	0.15	2.92	ELHJ401VSN401MA35M		580	35 × 51	0.20	3.60	ELHJ421VSN581MA51M	
	470	30 × 51	0.15	3.23	ELHJ401VSN471MR51M		620	35 × 54	0.20	3.76	ELHJ421VSN621MA54M	
	500	35 × 41	0.15	3.39	ELHJ401VSN501MA41M		700	35 × 59	0.20	4.06	ELHJ421VSN701MA59M	
	510	30 × 54	0.15	3.41	ELHJ401VSN511MR54M		450	220	30 × 35	0.20	1.98	ELHJ451VSN221MR35M
	570	30 × 59	0.15	3.66	ELHJ401VSN571MR59M			280	30 × 41	0.20	2.31	ELHJ451VSN281MR41M
	570	35 × 46	0.15	3.70	ELHJ401VSN571MA46M			310	30 × 46	0.20	2.48	ELHJ451VSN311MR46M
	670	35 × 51	0.15	4.12	ELHJ401VSN671MA51M			320	35 × 35	0.20	2.45	ELHJ451VSN321MA35M
	720	35 × 54	0.15	4.32	ELHJ401VSN721MA54M			370	30 × 51	0.20	2.77	ELHJ451VSN371MR51M
	810	35 × 59	0.15	4.66	ELHJ401VSN811MA59M			400	30 × 54	0.20	2.91	ELHJ451VSN401MR54M
420	240	30 × 35	0.20	2.07	ELHJ421VSN241MR35M	400		35 × 41	0.20	2.85	ELHJ451VSN401MA41M	
	300	30 × 41	0.20	2.39	ELHJ421VSN301MR41M	450		30 × 59	0.20	3.14	ELHJ451VSN451MR59M	
	340	30 × 46	0.20	2.60	ELHJ421VSN341MR46M	450		35 × 46	0.20	3.09	ELHJ451VSN451MA46M	
	350	35 × 35	0.20	2.57	ELHJ421VSN351MA35M	530		35 × 51	0.20	3.44	ELHJ451VSN531MA51M	
	410	30 × 51	0.20	2.92	ELHJ421VSN411MR51M	570		35 × 54	0.20	3.61	ELHJ451VSN571MA54M	
	430	35 × 41	0.20	2.95	ELHJ421VSN431MA41M	640		35 × 59	0.20	3.89	ELHJ451VSN641MA59M	

◆RATED RIPPLE CURRENT MULTIPLIERS

● Frequency Multipliers

Frequency(Hz)	50	120	300	1k	10k	50k
400 to 450V	0.72	1.00	1.21	1.38	1.48	1.46

The deterioration of aluminum electrolytic capacitors accelerates their life due to the internal heating produced by ripple current. For details, refer to Section "5-3 Ripple Current Effect on Lifetime" in the catalog, Technical Note.



LARGE CAPACITANCE ALUMINUM ELECTROLYTIC CAPACITORS

LHU Series Upgrade!

- Lineup of high withstand voltage products for server power supplies and solar power generation applications
- Endurance with ripple current : 5,000 hours at 105°C
- Rated voltage range: 400 to 500V, Capacitance range: 120 to 1,910μF
- Non solvent resistant type
- RoHS2 Compliant

LHU

↑ Downsizing

LHS

↑ Downsizing

LXS



◆ SPECIFICATIONS

Items	Characteristics	
Category	-40 to +105°C	
Temperature Range		
Rated Voltage Range	400 to 500V _{dc}	
Capacitance Tolerance	±20% (M) (at 20°C, 120Hz)	
Leakage Current	I ≤ 3/CV Where, I : Max. leakage current (μA), C : Nominal capacitance (μF), V : Rated voltage (V) (at 20°C after 5 minutes)	
Dissipation Factor (tan δ)	Rated voltage (V _{dc})	400 to 500V
	tan δ (Max.)	0.20 (at 20°C, 120Hz)
Low Temperature Characteristics (Max. Impedance Ratio)	Rated voltage (V _{dc})	400 to 500V
	Z(-25°C)/Z(+20°C)	8 (at 120Hz)
Endurance	The following specifications shall be satisfied when the capacitors are restored to 20°C after subjected to DC voltage with the rated ripple current is applied (the peak voltage shall not exceed the rated voltage) for 5,000 hours at 105°C.	
	Capacitance change	≤ ±20% of the initial value
	D.F. (tan δ)	≤ 200% of the initial specified value
	Leakage current	≤ The initial specified value
Shelf Life	The following specifications shall be satisfied when the capacitors are restored to 20°C after exposing them for 1,000 hours at 105°C without voltage applied. Before the measurement, the capacitor shall be preconditioned by applying voltage according to Item 4.1 of JIS C 5101-4.	
	Capacitance change	≤ ±15% of the initial value
	D.F. (tan δ)	≤ 150% of the initial specified value
	Leakage current	≤ The initial specified value

◆ DIMENSIONS [mm]

● Terminal Code : VS (φ25.4 to φ35) : Standard

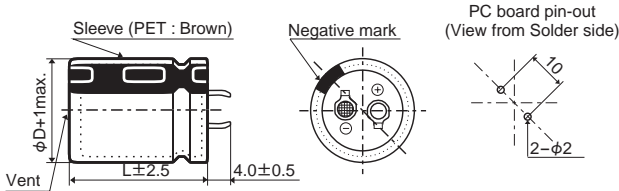

● Terminal Code : LI (φ30, φ35)

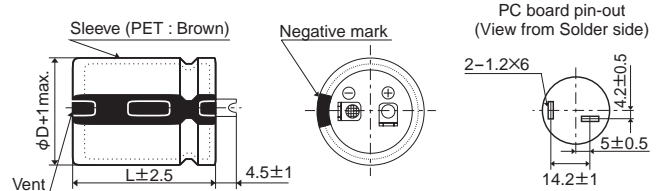

The standard design has no plastic disc.

◆ PART NUMBERING SYSTEM

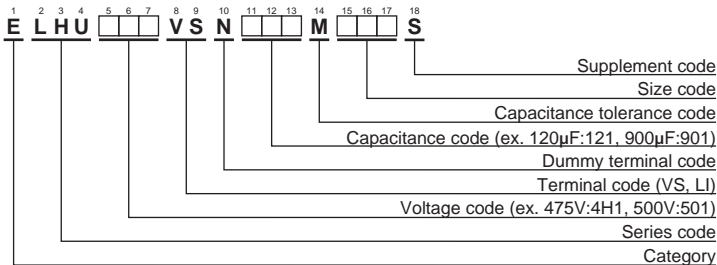

Please refer to "Product code guide (snap-in type)"



LARGE CAPACITANCE ALUMINUM ELECTROLYTIC CAPACITORS



◆STANDARD RATINGS

WV (V _{dc})	Cap (μF)	Case size φD×L(mm)	tan δ	Rated ripple current (Arms/105°C, 120Hz)	Part No.	WV (V _{dc})	Cap (μF)	Case size φD×L(mm)	tan δ	Rated ripple current (Arms/105°C, 120Hz)	Part No.	
400	380	25.4 × 35	0.20	1.58	ELHU401VSN381MQ35S	420	960	30 × 55	0.20	2.73	ELHU421VSN961MR55S	
	450	25.4 × 40	0.20	1.75	ELHU401VSN451MQ40S		980	35 × 45	0.20	2.45	ELHU421VSN981MA45S	
	460	35 × 25	0.20	1.53	ELHU401VSN461MA25S		1,040	30 × 60	0.20	2.90	ELHU421VSN1A2MR60S	
	470	30 × 30	0.20	1.71	ELHU401VSN471MR30S		1,100	30 × 65	0.20	3.04	ELHU421VSN112MR65S	
	520	25.4 × 45	0.20	1.92	ELHU401VSN521MQ45S		1,120	35 × 50	0.20	2.68	ELHU421VSN112MA50S	
	580	30 × 35	0.20	1.94	ELHU401VSN581MR35S		1,180	30 × 70	0.20	3.20	ELHU421VSN122MR70S	
	590	25.4 × 50	0.20	2.08	ELHU401VSN591MQ50S		1,250	30 × 75	0.20	3.35	ELHU421VSN1C2MR75S	
	600	35 × 30	0.20	1.78	ELHU401VSN601MA30S		1,260	35 × 55	0.20	2.86	ELHU421VSN1C2MA55S	
	660	25.4 × 55	0.20	2.24	ELHU401VSN661MQ55S		1,340	30 × 80	0.20	3.52	ELHU421VSN1D2MR80S	
	680	30 × 40	0.20	2.16	ELHU401VSN681MR40S		1,400	35 × 60	0.20	3.04	ELHU421VSN142MA60S	
	720	25.4 × 60	0.20	2.38	ELHU401VSN721MQ60S		1,420	35 × 65	0.20	3.12	ELHU421VSN1A2MR65S	
	750	35 × 35	0.20	2.02	ELHU401VSN751MA35S		1,550	35 × 70	0.20	3.32	ELHU421VSN1F2MA70S	
	790	30 × 45	0.20	2.39	ELHU401VSN791MR45S		1,680	35 × 75	0.20	3.51	ELHU421VSN172MA75S	
	890	35 × 40	0.20	2.28	ELHU401VSN891MA40S		1,810	35 × 80	0.20	3.71	ELHU421VSN182MA80S	
	900	30 × 50	0.20	2.60	ELHU401VSN901MR50S		450	320	25.4 × 35	0.20	1.45	ELHU451VSN321MQ35S
	1,010	30 × 55	0.20	2.80	ELHU401VSN102MR55S			390	25.4 × 40	0.20	1.63	ELHU451VSN391MQ40S
	1,040	35 × 45	0.20	2.53	ELHU401VSN1A2MA45S			390	35 × 25	0.20	1.41	ELHU451VSN391MA25S
	1,090	30 × 60	0.20	2.97	ELHU401VSN112MR60S			400	30 × 30	0.20	1.57	ELHU451VSN401MR30S
	1,160	30 × 65	0.20	3.12	ELHU401VSN1B2MR65S			450	25.4 × 45	0.20	1.79	ELHU451VSN1451MQ45S
	1,180	35 × 50	0.20	2.75	ELHU401VSN122MA50S			490	30 × 35	0.20	1.78	ELHU451VSN491MR35S
1,240	30 × 70	0.20	3.28	ELHU401VSN1C2MR70S	510	25.4 × 50		0.20	1.94	ELHU451VSN511MQ50S		
1,310	30 × 75	0.20	3.43	ELHU401VSN132MR75S	520	35 × 30		0.20	1.66	ELHU451VSN521MA30S		
1,320	35 × 55	0.20	2.93	ELHU401VSN132MA55S	570	25.4 × 55		0.20	2.08	ELHU451VSN571MQ55S		
1,410	30 × 80	0.20	3.61	ELHU401VSN142MR80S	590	30 × 40		0.20	2.02	ELHU451VSN591MR40S		
1,470	35 × 60	0.20	3.11	ELHU401VSN1E2MA60S	620	25.4 × 60		0.20	2.21	ELHU451VSN621MQ60S		
1,500	35 × 65	0.20	3.21	ELHU401VSN152MA65S	640	35 × 35		0.20	1.87	ELHU451VSN641MA35S		
1,630	35 × 70	0.20	3.40	ELHU401VSN1G2MA70S	680	30 × 45		0.20	2.22	ELHU451VSN681MR45S		
1,770	35 × 75	0.20	3.61	ELHU401VSN1H2MA75S	770	30 × 50		0.20	2.40	ELHU451VSN771MR50S		
1,910	35 × 80	0.20	3.81	ELHU401VSN192MA80S	770	35 × 40		0.20	2.12	ELHU451VSN771MA40S		
420	360	25.4 × 35	0.20	1.54	ELHU421VSN361MQ35S	860		30 × 55	0.20	2.59	ELHU451VSN861MR55S	
	430	25.4 × 40	0.20	1.72	ELHU421VSN431MQ40S	890		35 × 45	0.20	2.34	ELHU451VSN891MA45S	
	430	35 × 25	0.20	1.48	ELHU421VSN431MA25S	940		30 × 60	0.20	2.76	ELHU451VSN941MR60S	
	440	30 × 30	0.20	1.65	ELHU421VSN441MR30S	1,010		30 × 65	0.20	2.91	ELHU451VSN102MR65S	
	490	25.4 × 45	0.20	1.87	ELHU421VSN491MQ45S	1,020		35 × 50	0.20	2.56	ELHU451VSN102MA50S	
	550	30 × 35	0.20	1.89	ELHU421VSN551MR35S	1,080	30 × 70	0.20	3.06	ELHU451VSN112MR70S		
	560	25.4 × 50	0.20	2.03	ELHU421VSN561MQ50S	1,140	30 × 75	0.20	3.20	ELHU451VSN1B2MR75S		
	570	35 × 30	0.20	1.74	ELHU421VSN571MA30S	1,140	35 × 55	0.20	2.72	ELHU451VSN1B2MA55S		
	630	25.4 × 55	0.20	2.19	ELHU421VSN631MQ55S	1,230	30 × 80	0.20	3.38	ELHU451VSN1C2MR80S		
	650	30 × 40	0.20	2.12	ELHU421VSN651MR40S	1,260	35 × 60	0.20	2.88	ELHU451VSN1C2MA60S		
	680	25.4 × 60	0.20	2.31	ELHU421VSN681MQ60S	1,300	35 × 65	0.20	2.98	ELHU451VSN132MA65S		
	710	35 × 35	0.20	1.97	ELHU421VSN711MA35S	1,410	35 × 70	0.20	3.16	ELHU451VSN142MA70S		
	750	30 × 45	0.20	2.33	ELHU421VSN751MR45S	1,530	35 × 75	0.20	3.35	ELHU451VSN1F2MA75S		
	850	30 × 50	0.20	2.52	ELHU421VSN851MR50S	1,650	35 × 80	0.20	3.54	ELHU451VSN1G2MA80S		
	850	35 × 40	0.20	2.23	ELHU421VSN851MA40S							



LARGE CAPACITANCE ALUMINUM ELECTROLYTIC CAPACITORS



◆STANDARD RATINGS

WV (V _{dc})	Cap (μF)	Case size φD×L(mm)	tan δ	Rated ripple current (Arms/105°C, 120Hz)	Part No.	WV (V _{dc})	Cap (μF)	Case size φD×L(mm)	tan δ	Rated ripple current (Arms/105°C, 120Hz)	Part No.
475	150	25.4 × 25	0.20	1.03	ELHU4H1VSN151MQ25S	500	120	25.4 × 25	0.20	0.93	ELHU501VSN121MQ25S
	190	25.4 × 30	0.20	1.20	ELHU4H1VSN191MQ30S		160	25.4 × 30	0.20	1.10	ELHU501VSN161MQ30S
	220	30 × 25	0.20	1.32	ELHU4H1VSN221MR25S		180	30 × 25	0.20	1.20	ELHU501VSN181MR25S
	240	25.4 × 35	0.20	1.40	ELHU4H1VSN241MQ35S		200	25.4 × 35	0.20	1.28	ELHU501VSN201MQ35S
	270	35 × 25	0.20	1.48	ELHU4H1VSN271MA25S		240	25.4 × 40	0.20	1.43	ELHU501VSN241MQ40S
	280	25.4 × 40	0.20	1.54	ELHU4H1VSN281MQ40S		240	30 × 30	0.20	1.40	ELHU501VSN241MR30S
	290	30 × 30	0.20	1.54	ELHU4H1VSN291MR30S		240	35 × 25	0.20	1.37	ELHU501VSN241MA25S
	330	25.4 × 45	0.20	1.71	ELHU4H1VSN331MQ45S		280	25.4 × 45	0.20	1.57	ELHU501VSN281MQ45S
	360	30 × 35	0.20	1.75	ELHU4H1VSN361MR35S		300	30 × 35	0.20	1.60	ELHU501VSN301MR35S
	360	35 × 30	0.20	1.71	ELHU4H1VSN361MA30S		320	25.4 × 50	0.20	1.71	ELHU501VSN321MQ50S
	370	25.4 × 50	0.20	1.84	ELHU4H1VSN371MR50S		330	35 × 30	0.20	1.63	ELHU501VSN331MA30S
	420	25.4 × 55	0.20	1.99	ELHU4H1VSN421MQ55S		370	25.4 × 55	0.20	1.87	ELHU501VSN371MQ55S
	420	30 × 40	0.20	1.95	ELHU4H1VSN421MR40S		370	30 × 40	0.20	1.83	ELHU501VSN371MR40S
	450	35 × 35	0.20	1.94	ELHU4H1VSN451MA35S		410	25.4 × 60	0.20	2.00	ELHU501VSN411MQ60S
	460	25.4 × 60	0.20	2.12	ELHU4H1VSN461MQ60S		410	35 × 35	0.20	1.85	ELHU501VSN411MA35S
	490	30 × 45	0.20	2.16	ELHU4H1VSN491MR45S		430	30 × 45	0.20	2.02	ELHU501VSN431MR45S
	540	35 × 40	0.20	2.20	ELHU4H1VSN541MA40S		490	30 × 50	0.20	2.19	ELHU501VSN491MR50S
	560	30 × 50	0.20	2.34	ELHU4H1VSN561MR50S		490	35 × 40	0.20	2.09	ELHU501VSN491MA40S
	620	30 × 55	0.20	2.51	ELHU4H1VSN621MR55S		550	30 × 55	0.20	2.37	ELHU501VSN551MR55S
	630	35 × 45	0.20	2.43	ELHU4H1VSN631MA45S		580	35 × 45	0.20	2.33	ELHU501VSN581MA45S
	690	30 × 60	0.20	2.70	ELHU4H1VSN691MR60S		610	30 × 60	0.20	2.54	ELHU501VSN611MR60S
	710	30 × 65	0.20	2.79	ELHU4H1VSN711MR65S		650	30 × 65	0.20	2.67	ELHU501VSN651MR65S
	720	35 × 50	0.20	2.65	ELHU4H1VSN721MA50S		660	35 × 50	0.20	2.54	ELHU501VSN661MA50S
	770	30 × 70	0.20	2.96	ELHU4H1VSN771MR70S		710	30 × 70	0.20	2.84	ELHU501VSN711MR70S
810	35 × 55	0.20	2.87	ELHU4H1VSN811MA55S	740	35 × 55	0.20	2.74	ELHU501VSN741MA55S		
840	30 × 75	0.20	3.14	ELHU4H1VSN841MR75S	770	30 × 75	0.20	3.01	ELHU501VSN771MR75S		
900	30 × 80	0.20	3.31	ELHU4H1VSN901MR80S	830	30 × 80	0.20	3.18	ELHU501VSN831MR80S		
900	35 × 60	0.20	3.08	ELHU4H1VSN901MA60S	830	35 × 60	0.20	2.95	ELHU501VSN831MA60S		
960	35 × 65	0.20	3.24	ELHU4H1VSN961MA65S	880	35 × 65	0.20	3.10	ELHU501VSN881MA65S		
1,040	35 × 70	0.20	3.43	ELHU4H1VSN1A2MA70S	960	35 × 70	0.20	3.29	ELHU501VSN961MA70S		
1,130	35 × 75	0.20	3.64	ELHU4H1VSN1B2MA75S	1,040	35 × 75	0.20	3.49	ELHU501VSN1A2MA75S		
1,220	35 × 80	0.20	3.85	ELHU4H1VSN122MA80S	1,120	35 × 80	0.20	3.69	ELHU501VSN112MA80S		

◆RATED RIPPLE CURRENT MULTIPLIERS

● Frequency Multipliers

Frequency(Hz)	50	120	300	1k	10k	50k
400 to 450V _{dc}	0.77	1.00	1.10	1.21	1.32	1.33
475, 500V _{dc}	0.77	1.00	1.11	1.20	1.25	1.33

The deterioration of aluminum electrolytic capacitors accelerates their life due to the internal heating produced by ripple current. For details, refer to Section "5-3 Ripple Current Effect on Lifetime" in the catalog, Technical Note.

LHS Series

- The lower temperature range of the category temperature range has been expanded.
- For solar power generation
- Endurance with ripple current : 5,000 hours at 105°C
- Rated voltage range : 450 to 500V
- For inverter control, switching power supplies
- Non solvent resistant type
- RoHS2 Compliant

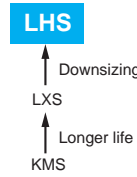

500V Lineup!



SPECIFICATIONS

Items	Characteristics	
Category Temperature Range	-40 to +105°C	
Rated Voltage Range	450 to 500V _{dc}	
Capacitance Tolerance	±20% (M) (at 20°C, 120Hz)	
Leakage Current	I ≤ 3√CV Where, I : Max. leakage current (µA), C : Nominal capacitance (µF), V : Rated voltage (V) (at 20°C after 5 minutes)	
Dissipation Factor (tan δ)	Rated voltage (V _{dc})	450 to 500V
	tan δ (Max.)	0.20 (at 20°C, 120Hz)
Low Temperature Characteristics (Max. Impedance Ratio)	Rated voltage (V _{dc})	450 to 500V
	Z(-25°C)/Z(+20°C)	8 (at 120Hz)
Endurance	The following specifications shall be satisfied when the capacitors are restored to 20°C after subjected to DC voltage with the rated ripple current is applied (the peak voltage shall not exceed the rated voltage) for 5,000 hours at 105°C.	
	Capacitance change	≤ ±20% of the initial value
	D.F. (tan δ)	≤ 200% of the initial specified value (475, 500V _{dc} : ≤ 250%)
	Leakage current	≤ The initial specified value
Shelf Life	The following specifications shall be satisfied when the capacitors are restored to 20°C after exposing them for 1,000 hours at 105°C without voltage applied. Before the measurement, the capacitor shall be preconditioned by applying voltage according to Item 4.1 of JIS C 5101-4.	
	Capacitance change	≤ ±15% of the initial value
	D.F. (tan δ)	≤ 150% of the initial specified value
	Leakage current	≤ The initial specified value

DIMENSIONS [mm]

● Terminal Code : VS (φ22 to φ35) : Standard

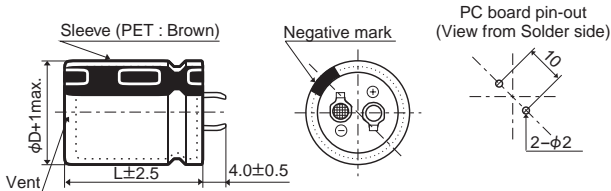

● Terminal Code : LI (φ30, φ35)

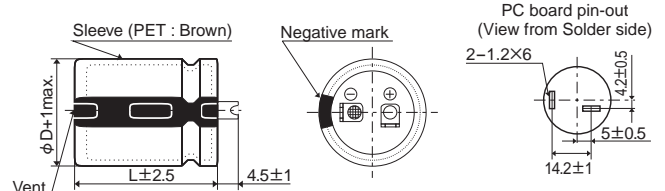

The standard design has no plastic disc.

PART NUMBERING SYSTEM

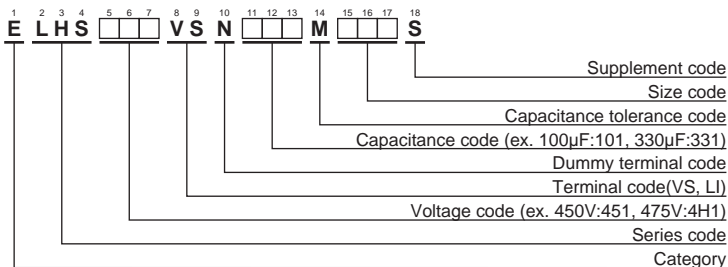

Please refer to "Product code guide (snap-in type)"



LHS Series

◆ STANDARD RATINGS

WV (V _{dc})	Cap (μF)	Case size φD×L(mm)	tan δ	Rated ripple current (Arms/105°C, 120Hz)	Part No.	WV (V _{dc})	Cap (μF)	Case size φD×L(mm)	tan δ	Rated ripple current (Arms/105°C, 120Hz)	Part No.	
450	100	22 × 25	0.20	0.71	ELHS451VSN101MP25S	475	150	30 × 25	0.20	1.01	ELHS4H1VSN151MR25S	
	120	22 × 30	0.20	0.81	ELHS451VSN121MP30S		180	30 × 30	0.20	1.11	ELHS4H1VSN181MR30S	
	150	22 × 35	0.20	0.93	ELHS451VSN151MP35S		180	35 × 25	0.20	1.08	ELHS4H1VSN181MA25S	
	150	25.4 × 25	0.20	0.93	ELHS451VSN151MQ25S		220	30 × 35	0.20	1.26	ELHS4H1VSN221MR35S	
	180	22 × 40	0.20	1.04	ELHS451VSN181MP40S		270	30 × 40	0.20	1.44	ELHS4H1VSN271MR40S	
	180	25.4 × 30	0.20	1.05	ELHS451VSN181MQ30S		270	35 × 30	0.20	1.35	ELHS4H1VSN271MA30S	
	220	22 × 45	0.20	1.17	ELHS451VSN221MP45S		330	30 × 45	0.20	1.63	ELHS4H1VSN331MR45S	
	220	25.4 × 35	0.20	1.21	ELHS451VSN221MQ35S		330	35 × 35	0.20	1.51	ELHS4H1VSN331MA35S	
	220	30 × 25	0.20	1.15	ELHS451VSN221MR25S		390	30 × 50	0.20	1.80	ELHS4H1VSN391MR50S	
	270	22 × 50	0.20	1.33	ELHS451VSN271MP50S		390	35 × 40	0.20	1.70	ELHS4H1VSN391MA40S	
	270	25.4 × 40	0.20	1.36	ELHS451VSN271MQ40S		470	30 × 60	0.20	2.05	ELHS4H1VSN471MR60S	
	270	30 × 30	0.20	1.29	ELHS451VSN271MR30S		470	35 × 45	0.20	1.91	ELHS4H1VSN471MA45S	
	270	35 × 25	0.20	1.25	ELHS451VSN271MA25S		470	35 × 50	0.20	1.95	ELHS4H1VSN471MA50S	
	330	22 × 60	0.20	1.54	ELHS451VSN331MP60S		560	35 × 60	0.20	2.21	ELHS4H1VSN561MA60S	
	330	25.4 × 45	0.20	1.54	ELHS451VSN331MQ45S		500	120	30 × 25	0.20	0.90	ELHS501VSN121MR25S
	330	25.4 × 50	0.20	1.56	ELHS451VSN331MQ50S			150	30 × 30	0.20	1.02	ELHS501VSN151MR30S
	330	30 × 35	0.20	1.46	ELHS451VSN331MR35S			150	35 × 25	0.20	0.99	ELHS501VSN151MA25S
	330	35 × 30	0.20	1.41	ELHS451VSN331MA30S			180	30 × 35	0.20	1.14	ELHS501VSN181MR35S
	390	25.4 × 60	0.20	1.74	ELHS451VSN391MQ60S			220	30 × 40	0.20	1.30	ELHS501VSN221MR40S
	390	30 × 40	0.20	1.63	ELHS451VSN391MR40S			220	35 × 30	0.20	1.22	ELHS501VSN221MA30S
	470	30 × 45	0.20	1.84	ELHS451VSN471MR45S			270	30 × 45	0.20	1.47	ELHS501VSN271MR45S
	470	30 × 50	0.20	1.87	ELHS451VSN471MR50S			270	35 × 35	0.20	1.37	ELHS501VSN271MA35S
	470	35 × 35	0.20	1.71	ELHS451VSN471MA35S			330	30 × 50	0.20	1.66	ELHS501VSN331MR50S
	560	35 × 40	0.20	1.95	ELHS451VSN561MA40S			330	35 × 40	0.20	1.57	ELHS501VSN331MA40S
560	35 × 45	0.20	1.99	ELHS451VSN561MA45S	390	30 × 60		0.20	1.87	ELHS501VSN391MR60S		
680	30 × 60	0.20	2.33	ELHS451VSN681MR60S	390	35 × 45		0.20	1.74	ELHS501VSN391MA45S		
680	35 × 50	0.20	2.22	ELHS451VSN681MA50S	470	35 × 50		0.20	1.95	ELHS501VSN471MA50S		
820	35 × 60	0.20	2.52	ELHS451VSN821MA60S	560	35 × 60		0.20	2.21	ELHS501VSN561MA60S		

◆ RATED RIPPLE CURRENT MULTIPLIERS

● Frequency Multipliers

Frequency(Hz)	50	120	300	1k	10k	50k
450V _{dc}	0.77	1.00	1.16	1.30	1.41	1.43
475, 500V _{dc}	0.70	1.00	1.16	1.30	1.41	1.43

The deterioration of aluminum electrolytic capacitors accelerates their life due to the internal heating produced by ripple current. For details, refer to Section "5-3 Ripple Current Effect on Lifetime" in the catalog, Technical Note.

LXS Series

- For solar power generation
- Endurance with ripple current : 5,000 hours at 105°C
- Rated voltage range : 160 to 600V
- Downsized from LXQ series
- Non solvent resistant type
- RoHS2 Compliant

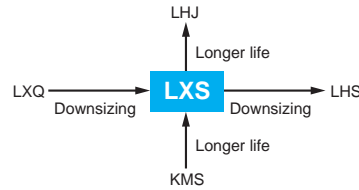

SPECIFICATIONS

Items	Characteristics		
Category	-25 to +105°C		
Temperature Range	-25 to +105°C		
Rated Voltage Range	160 to 600V _{dc}		
Capacitance Tolerance	±20% (M) (at 20°C, 120Hz)		
Leakage Current	I ≤ 3/CV Where, I : Max. leakage current (µA), C : Nominal capacitance (µF), V : Rated voltage (V) (at 20°C after 5 minutes)		
Dissipation Factor (tan δ)	Rated voltage (V _{dc})	160 to 400V	420 to 600V
	tan δ (Max.)	0.15	0.20
Low Temperature Characteristics (Max. Impedance Ratio)	Rated voltage (V _{dc})	160 to 400V	420 to 600V
	Z(-25°C)/Z(+20°C)	4	8
Endurance	The following specifications shall be satisfied when the capacitors are restored to 20°C after subjected to DC voltage with the rated ripple current is applied (the peak voltage shall not exceed the rated voltage) for 5,000 hours at 105°C.		
	Capacitance change	≤ ±20% of the initial value	
	D.F. (tan δ)	≤ 200% of the initial specified value (500V _{dc} : ≤ 250%, 550, 600V _{dc} : ≤ 300%)	
	Leakage current	≤ The initial specified value	
Shelf Life	The following specifications shall be satisfied when the capacitors are restored to 20°C after exposing them for 1,000 hours at 105°C without voltage applied. Before the measurement, the capacitor shall be preconditioned by applying voltage according to Item 4.1 of JIS C 5101-4.		
	Capacitance change	≤ ±15% of the initial value	
	D.F. (tan δ)	≤ 150% of the initial specified value	
	Leakage current	≤ The initial specified value	

DIMENSIONS [mm]

• Terminal Code : VS (φ22 to φ35) : Standard

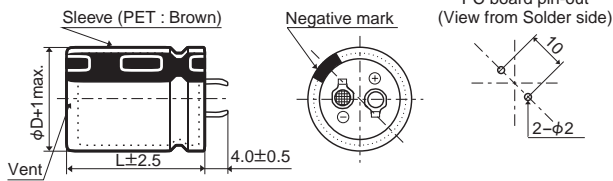

• Terminal Code : LI (φ30, φ35)

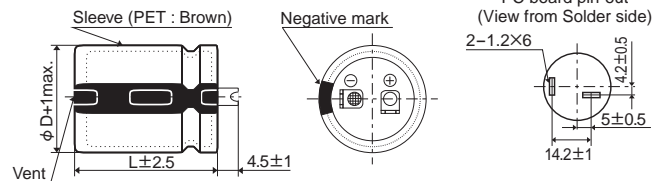

The standard design has no plastic disc.

PART NUMBERING SYSTEM

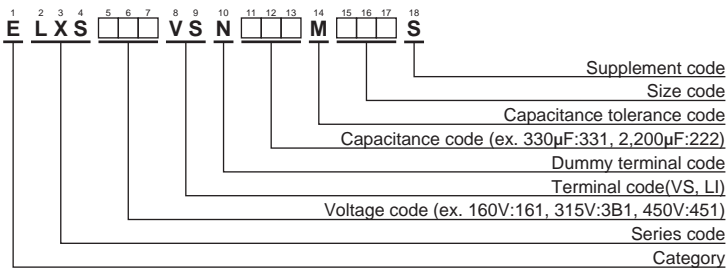

Please refer to "Product code guide (snap-in type)"

◆ STANDARD RATINGS

WV (V _{dc})	Cap (μF)	Case size φD×L(mm)	tan δ	Rated ripple current (Arms/105°C, 120Hz)	Part No.	WV (V _{dc})	Cap (μF)	Case size φD×L(mm)	tan δ	Rated ripple current (Arms/105°C, 120Hz)	Part No.
160	470	22 × 25	0.15	1.47	ELXS161VSN471MP25S	200	1,500	35 × 35	0.15	3.36	ELXS201VSN152MA35S
	680	22 × 30	0.15	1.86	ELXS161VSN681MP30S		1,800	30 × 50	0.15	3.72	ELXS201VSN182MR50S
	680	25.4 × 25	0.15	1.84	ELXS161VSN681MQ25S		1,800	35 × 40	0.15	3.81	ELXS201VSN182MA40S
	820	22 × 35	0.15	2.09	ELXS161VSN821MP35S		2,200	35 × 45	0.15	4.32	ELXS201VSN222MA45S
	820	25.4 × 30	0.15	2.08	ELXS161VSN821MQ30S		2,700	35 × 50	0.15	4.88	ELXS201VSN272MA50S
	1,000	22 × 40	0.15	2.35	ELXS161VSN102MP40S		270	22 × 25	0.15	1.11	ELXS251VSN271MP25S
	1,000	22 × 45	0.15	2.40	ELXS161VSN102MP45S		330	22 × 30	0.15	1.29	ELXS251VSN331MP30S
	1,000	25.4 × 35	0.15	2.40	ELXS161VSN102MQ35S		390	22 × 35	0.15	1.44	ELXS251VSN391MP35S
	1,000	30 × 25	0.15	2.50	ELXS161VSN102MR25S		390	25.4 × 25	0.15	1.40	ELXS251VSN391MQ25S
	1,200	22 × 50	0.15	2.69	ELXS161VSN122MP50S		470	22 × 40	0.15	1.61	ELXS251VSN471MP40S
	1,200	25.4 × 40	0.15	2.68	ELXS161VSN122MQ40S	470	25.4 × 30	0.15	1.57	ELXS251VSN471MQ30S	
	1,200	30 × 30	0.15	2.77	ELXS161VSN122MR30S	560	22 × 45	0.15	1.79	ELXS251VSN561MP45S	
	1,200	35 × 25	0.15	2.91	ELXS161VSN122MA25S	560	25.4 × 35	0.15	1.79	ELXS251VSN561MQ35S	
	1,500	25.4 × 45	0.15	3.05	ELXS161VSN152MQ45S	560	30 × 25	0.15	1.87	ELXS251VSN561MR25S	
	1,500	30 × 35	0.15	3.17	ELXS161VSN152MR35S	680	22 × 50	0.15	2.02	ELXS251VSN681MP50S	
	1,800	25.4 × 50	0.15	3.40	ELXS161VSN182MQ50S	680	25.4 × 40	0.15	2.02	ELXS251VSN681MQ40S	
	1,800	30 × 40	0.15	3.57	ELXS161VSN182MR40S	680	30 × 30	0.15	2.08	ELXS251VSN681MR30S	
	1,800	35 × 30	0.15	3.62	ELXS161VSN182MA30S	680	35 × 25	0.15	2.19	ELXS251VSN681MA25S	
	2,200	30 × 45	0.15	4.05	ELXS161VSN222MR45S	820	25.4 × 45	0.15	2.26	ELXS251VSN821MQ45S	
	2,200	30 × 50	0.15	4.11	ELXS161VSN222MR50S	820	25.4 × 50	0.15	2.29	ELXS251VSN821MQ50S	
2,200	35 × 35	0.15	4.07	ELXS161VSN222MA35S	820	30 × 35	0.15	2.34	ELXS251VSN821MR35S		
2,700	35 × 40	0.15	4.67	ELXS161VSN272MA40S	820	35 × 30	0.15	2.45	ELXS251VSN821MA30S		
2,700	35 × 45	0.15	4.78	ELXS161VSN272MA45S	1,000	30 × 40	0.15	2.66	ELXS251VSN102MR40S		
3,300	35 × 50	0.15	5.40	ELXS161VSN332MA50S	1,200	30 × 45	0.15	2.99	ELXS251VSN122MR45S		
180	390	22 × 25	0.15	1.34	ELXS181VSN391MP25S	1,200	30 × 50	0.15	3.04	ELXS251VSN122MR50S	
	560	22 × 30	0.15	1.68	ELXS181VSN561MP30S	1,200	35 × 35	0.15	3.00	ELXS251VSN122MA35S	
	560	25.4 × 25	0.15	1.67	ELXS181VSN561MQ25S	1,200	35 × 40	0.15	3.11	ELXS251VSN122MA40S	
	680	22 × 35	0.15	1.90	ELXS181VSN681MP35S	1,500	35 × 45	0.15	3.56	ELXS251VSN152MA45S	
	820	22 × 40	0.15	2.13	ELXS181VSN821MP40S	1,800	35 × 50	0.15	3.98	ELXS251VSN182MA50S	
	820	25.4 × 30	0.15	2.08	ELXS181VSN821MQ30S	180	22 × 25	0.15	0.95	ELXS3B1VSN181MP25S	
	820	25.4 × 35	0.15	2.17	ELXS181VSN821MQ35S	220	22 × 30	0.15	1.10	ELXS3B1VSN221MP30S	
	820	30 × 25	0.15	2.26	ELXS181VSN821MR25S	220	25.4 × 25	0.15	1.10	ELXS3B1VSN221MQ25S	
	1,000	22 × 45	0.15	2.40	ELXS181VSN102MP45S	270	22 × 35	0.15	1.24	ELXS3B1VSN271MP35S	
	1,000	22 × 50	0.15	2.45	ELXS181VSN102MP50S	270	25.4 × 30	0.15	1.25	ELXS3B1VSN271MQ30S	
	1,000	25.4 × 40	0.15	2.45	ELXS181VSN102MQ40S	330	22 × 40	0.15	1.40	ELXS3B1VSN331MP40S	
	1,000	30 × 30	0.15	2.52	ELXS181VSN102MR30S	330	30 × 25	0.15	1.43	ELXS3B1VSN331MR25S	
	1,000	35 × 25	0.15	2.66	ELXS181VSN102MA25S	390	22 × 45	0.15	1.56	ELXS3B1VSN391MP45S	
	1,200	25.4 × 45	0.15	2.73	ELXS181VSN122MQ45S	390	22 × 50	0.15	1.59	ELXS3B1VSN391MP50S	
	1,200	30 × 35	0.15	2.83	ELXS181VSN122MR35S	390	25.4 × 35	0.15	1.57	ELXS3B1VSN391MQ35S	
	1,500	25.4 × 50	0.15	3.10	ELXS181VSN152MQ50S	470	25.4 × 40	0.15	1.76	ELXS3B1VSN471MQ40S	
	1,500	30 × 40	0.15	3.26	ELXS181VSN152MR40S	470	25.4 × 45	0.15	1.79	ELXS3B1VSN471MQ45S	
	1,500	35 × 30	0.15	3.31	ELXS181VSN152MA30S	470	30 × 30	0.15	1.73	ELXS3B1VSN471MR30S	
	1,800	30 × 45	0.15	3.66	ELXS181VSN182MR45S	470	35 × 25	0.15	1.82	ELXS3B1VSN471MA25S	
	1,800	35 × 35	0.15	3.68	ELXS181VSN182MA35S	560	25.4 × 50	0.15	1.99	ELXS3B1VSN561MQ50S	
2,200	30 × 50	0.15	4.11	ELXS181VSN222MR50S	560	30 × 35	0.15	1.93	ELXS3B1VSN561MR35S		
2,200	35 × 40	0.15	4.22	ELXS181VSN222MA40S	560	35 × 30	0.15	2.02	ELXS3B1VSN561MA30S		
2,200	35 × 45	0.15	4.32	ELXS181VSN222MA45S	680	30 × 40	0.15	2.19	ELXS3B1VSN681MR40S		
2,700	35 × 50	0.15	4.88	ELXS181VSN272MA50S	680	30 × 45	0.15	2.25	ELXS3B1VSN681MR45S		
200	390	22 × 25	0.15	1.34	ELXS201VSN391MP25S	680	35 × 35	0.15	2.26	ELXS3B1VSN681MA35S	
	470	22 × 30	0.15	1.54	ELXS201VSN471MP30S	820	30 × 50	0.15	2.51	ELXS3B1VSN821MR50S	
	560	22 × 35	0.15	1.72	ELXS201VSN561MP35S	820	35 × 40	0.15	2.57	ELXS3B1VSN821MA40S	
	560	25.4 × 25	0.15	1.67	ELXS201VSN561MQ25S	1,000	35 × 45	0.15	2.91	ELXS3B1VSN102MA45S	
	680	22 × 40	0.15	1.94	ELXS201VSN681MP40S	1,200	35 × 50	0.15	3.25	ELXS3B1VSN122MA50S	
	680	25.4 × 30	0.15	1.89	ELXS201VSN681MQ30S	120	22 × 25	0.15	0.77	ELXS401VSN121MP25S	
	680	30 × 25	0.15	2.06	ELXS201VSN681MR25S	150	22 × 30	0.15	0.90	ELXS401VSN151MP30S	
	820	22 × 45	0.15	2.17	ELXS201VSN821MP45S	180	22 × 35	0.15	1.02	ELXS401VSN181MP35S	
	820	25.4 × 35	0.15	2.17	ELXS201VSN821MQ35S	180	25.4 × 25	0.15	0.99	ELXS401VSN181MQ25S	
	1,000	22 × 50	0.15	2.45	ELXS201VSN102MP50S	220	22 × 40	0.15	1.15	ELXS401VSN221MP40S	
	1,000	25.4 × 40	0.15	2.45	ELXS201VSN102MQ40S	220	25.4 × 30	0.15	1.13	ELXS401VSN221MQ30S	
	1,000	30 × 30	0.15	2.52	ELXS201VSN102MR30S	220	30 × 25	0.15	1.17	ELXS401VSN221MR25S	
	1,000	35 × 25	0.15	2.66	ELXS201VSN102MA25S	270	22 × 45	0.15	1.29	ELXS401VSN271MP45S	
	1,200	25.4 × 45	0.15	2.73	ELXS201VSN122MQ45S	270	22 × 50	0.15	1.32	ELXS401VSN271MP50S	
	1,200	25.4 × 50	0.15	2.78	ELXS201VSN122MQ50S	270	25.4 × 35	0.15	1.30	ELXS401VSN271MQ35S	
	1,200	30 × 35	0.15	2.83	ELXS201VSN122MR35S	330	25.4 × 40	0.15	1.47	ELXS401VSN331MQ40S	
	1,200	35 × 30	0.15	2.96	ELXS201VSN122MA30S	330	30 × 30	0.15	1.45	ELXS401VSN331MR30S	
	1,500	30 × 40	0.15	3.26	ELXS201VSN152MR40S	330	35 × 25	0.15	1.52	ELXS401VSN331MA25S	
	1,500	30 × 45	0.15	3.34	ELXS201VSN152MR45S	390	25.4 × 45	0.15	1.63	ELXS401VSN391MQ45S	



LXS Series

◆STANDARD RATINGS

WV (V _{dc})	Cap (μF)	Case size φD×L(mm)	tan δ	Rated ripple current (Arms/105°C, 120Hz)	Part No.	WV (V _{dc})	Cap (μF)	Case size φD×L(mm)	tan δ	Rated ripple current (Arms/105°C, 120Hz)	Part No.
400	390	25.4 × 50	0.15	1.66	ELXS401VSN391MQ50S	450	220	30 × 30	0.20	1.18	ELXS451VSN221MR30S
	390	30 × 35	0.15	1.61	ELXS401VSN391MR35S		220	35 × 25	0.20	1.24	ELXS451VSN221MA25S
	390	35 × 30	0.15	1.68	ELXS401VSN391MA30S		270	25.4 × 45	0.20	1.36	ELXS451VSN271MQ45S
	470	30 × 40	0.15	1.82	ELXS401VSN471MR40S		270	25.4 × 50	0.20	1.38	ELXS451VSN271MQ50S
	470	35 × 35	0.15	1.88	ELXS401VSN471MA35S		270	30 × 35	0.20	1.34	ELXS451VSN271MR35S
	560	30 × 45	0.15	2.04	ELXS401VSN561MR45S		270	35 × 30	0.20	1.40	ELXS451VSN271MA30S
	560	30 × 50	0.15	2.07	ELXS401VSN561MR50S		330	30 × 40	0.20	1.52	ELXS451VSN331MR40S
	560	35 × 40	0.15	2.13	ELXS401VSN561MA40S		390	30 × 45	0.20	1.70	ELXS451VSN391MR45S
	680	35 × 45	0.15	2.40	ELXS401VSN681MA45S		390	30 × 50	0.20	1.73	ELXS451VSN391MR50S
	820	35 × 50	0.15	2.69	ELXS401VSN821MA50S		390	35 × 35	0.20	1.71	ELXS451VSN391MA35S
420	100	22 × 25	0.20	0.70	ELXS421VSN101MP25S	470	35 × 40	0.20	1.95	ELXS451VSN471MR40S	
	120	22 × 30	0.20	0.81	ELXS421VSN121MP30S	470	35 × 45	0.20	1.99	ELXS451VSN471MA45S	
	120	25.4 × 25	0.20	0.81	ELXS421VSN121MQ25S	560	35 × 50	0.20	2.22	ELXS451VSN561MA50S	
	150	22 × 35	0.20	0.93	ELXS421VSN151MP35S	100	30 × 25	0.20	0.82	ELXS501VSN101MR25S	
	180	22 × 40	0.20	1.04	ELXS421VSN181MP40S	120	30 × 30	0.20	0.91	ELXS501VSN121MR30S	
	180	25.4 × 30	0.20	1.02	ELXS421VSN181MQ30S	120	35 × 25	0.20	0.88	ELXS501VSN121MA25S	
	180	30 × 25	0.20	1.06	ELXS421VSN181MR25S	150	30 × 35	0.20	1.04	ELXS501VSN151MR35S	
	220	22 × 45	0.20	1.17	ELXS421VSN221MP45S	180	30 × 40	0.20	1.17	ELXS501VSN181MR40S	
	220	22 × 50	0.20	1.20	ELXS421VSN221MP50S	180	35 × 30	0.20	1.10	ELXS501VSN181MA30S	
	220	25.4 × 35	0.20	1.18	ELXS421VSN221MQ35S	220	30 × 45	0.20	1.33	ELXS501VSN221MR45S	
	270	25.4 × 40	0.20	1.33	ELXS421VSN271MQ40S	220	35 × 35	0.20	1.23	ELXS501VSN221MA35S	
	270	25.4 × 45	0.20	1.36	ELXS421VSN271MQ45S	270	30 × 50	0.20	1.50	ELXS501VSN271MR50S	
	270	30 × 30	0.20	1.31	ELXS421VSN271MR30S	270	35 × 40	0.20	1.42	ELXS501VSN271MA40S	
	270	35 × 25	0.20	1.38	ELXS421VSN271MA25S	330	35 × 45	0.20	1.60	ELXS501VSN331MA45S	
	330	25.4 × 50	0.20	1.52	ELXS421VSN331MQ50S	390	35 × 50	0.20	1.78	ELXS501VSN391MA50S	
	330	30 × 35	0.20	1.48	ELXS421VSN331MR35S	470	35 × 60	0.20	2.03	ELXS501VSN471MA60S	
	330	35 × 30	0.20	1.55	ELXS421VSN331MA30S	120	30 × 30	0.20	0.91	ELXS551VSN121MR30S	
	390	30 × 40	0.20	1.66	ELXS421VSN391MR40S	150	30 × 35	0.20	1.04	ELXS551VSN151MR35S	
	390	30 × 45	0.20	1.70	ELXS421VSN391MR45S	180	30 × 40	0.20	1.17	ELXS551VSN181MR40S	
	390	35 × 35	0.20	1.71	ELXS421VSN391MA35S	180	35 × 30	0.20	1.10	ELXS551VSN181MA30S	
470	30 × 50	0.20	1.90	ELXS421VSN471MR50S	220	30 × 50	0.20	1.35	ELXS551VSN221MR50S		
470	35 × 40	0.20	1.95	ELXS421VSN471MA40S	220	35 × 40	0.20	1.28	ELXS551VSN221MA40S		
560	35 × 45	0.20	2.17	ELXS421VSN561MA45S	270	35 × 45	0.20	1.45	ELXS551VSN271MA45S		
680	35 × 50	0.20	2.45	ELXS421VSN681MA50S	330	35 × 50	0.20	1.64	ELXS551VSN331MA50S		
450	82	22 × 25	0.20	0.64	ELXS451VSN820MP25S	390	35 × 60	0.20	1.85	ELXS551VSN391MA60S	
	120	22 × 30	0.20	0.81	ELXS451VSN121MP30S	120	30 × 40	0.20	0.96	ELXS601VSN121MR40S	
	120	22 × 35	0.20	0.83	ELXS451VSN121MP35S	120	35 × 30	0.20	0.95	ELXS601VSN121MA30S	
	120	25.4 × 25	0.20	0.81	ELXS451VSN121MQ25S	150	30 × 45	0.20	1.10	ELXS601VSN151MR45S	
	150	22 × 40	0.20	0.94	ELXS451VSN151MP40S	150	35 × 35	0.20	1.07	ELXS601VSN151MA35S	
	150	25.4 × 30	0.20	0.93	ELXS451VSN151MQ30S	180	30 × 50	0.20	1.22	ELXS601VSN181MR50S	
	180	22 × 45	0.20	1.06	ELXS451VSN181MP45S	180	35 × 40	0.20	1.22	ELXS601VSN181MA40S	
	180	25.4 × 35	0.20	1.06	ELXS451VSN181MQ35S	220	30 × 60	0.20	1.40	ELXS601VSN221MR60S	
	180	30 × 25	0.20	1.06	ELXS451VSN181MR25S	220	35 × 45	0.20	1.38	ELXS601VSN221MA45S	
	220	22 × 50	0.20	1.20	ELXS451VSN221MP50S	270	35 × 50	0.20	1.56	ELXS601VSN271MA50S	
220	25.4 × 40	0.20	1.20	ELXS451VSN221MQ40S	330	35 × 60	0.20	1.79	ELXS601VSN331MA60S		

◆RATED RIPPLE CURRENT MULTIPLIERS

●Frequency Multipliers

Frequency(Hz)	50	120	300	1k	10k	50k
160 to 250V _{dc}	0.81	1.00	1.17	1.32	1.45	1.50
315 to 450V _{dc}	0.77	1.00	1.16	1.30	1.41	1.43
500 to 600V _{dc}	0.70	1.00	1.16	1.30	1.41	1.43

The deterioration of aluminum electrolytic capacitors accelerates their life due to the internal heating produced by ripple current. For details, refer to Section "5-3 Ripple Current Effect on Lifetime" in the catalog, Technical Note.

LXQ Series

- Endurance with ripple current : 5,000 hours at 105°C
- Downsized and higher ripple version of LXG series
- Non solvent resistant type
- RoHS2 Compliant

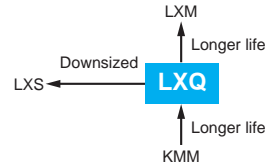

SPECIFICATIONS

Items	Characteristics		
Category	-25 to +105°C		
Temperature Range	-25 to +105°C		
Rated Voltage Range	160 to 450V _{dc}		
Capacitance Tolerance	±20% (M) (at 20°C, 120Hz)		
Leakage Current	I ≤ 3/CV Where, I : Max. leakage current (µA), C : Nominal capacitance (µF), V : Rated voltage (V) (at 20°C after 5 minutes)		
Dissipation Factor (tan δ)	Rated voltage (V _{dc})	160 to 400V	420 & 450V
	tan δ (Max.)	0.15	0.20
Low Temperature Characteristics (Max. Impedance Ratio)	Rated voltage (V _{dc})	160 to 400V	420 & 450V
	Z(-25°C)/Z(+20°C)	4	8
Endurance	The following specifications shall be satisfied when the capacitors are restored to 20°C after subjected to DC voltage with the rated ripple current is applied (the peak voltage shall not exceed the rated voltage) for 5,000 hours at 105°C.		
	Capacitance change	≤ ±20% of the initial value	
	D.F. (tan δ)	≤ 200% of the initial specified value	
	Leakage current	≤ The initial specified value	
Shelf Life	The following specifications shall be satisfied when the capacitors are restored to 20°C after exposing them for 1,000 hours at 105°C without voltage applied. Before the measurement, the capacitor shall be preconditioned by applying voltage according to Item 4.1 of JIS C 5101-4.		
	Capacitance change	≤ ±15% of the initial value	
	D.F. (tan δ)	≤ 150% of the initial specified value	
	Leakage current	≤ The initial specified value	

DIMENSIONS [mm]

Terminal Code : VS (φ22 to φ35) : Standard

Terminal Code : LI (φ30, φ35)

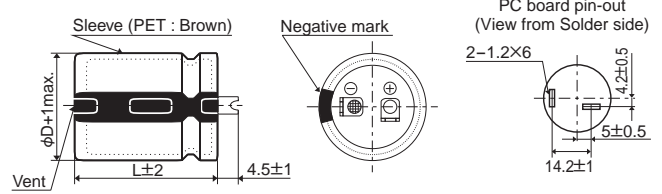
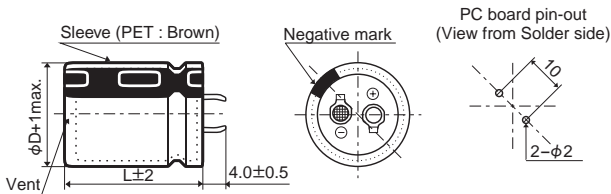

The standard design has no plastic disc.

PART NUMBERING SYSTEM

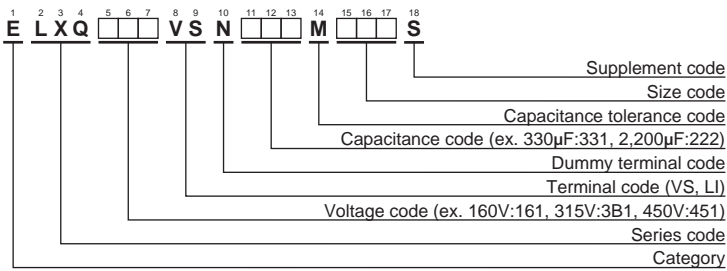

Please refer to "Product code guide (snap-in type)"

◆ STANDARD RATINGS

WV (V _{dc})	Cap (μF)	Case size φD×L(mm)	tan δ	Rated ripple current (Arms/105°C, 120Hz)	Part No.	WV (V _{dc})	Cap (μF)	Case size φD×L(mm)	tan δ	Rated ripple current (Arms/105°C, 120Hz)	Part No.
160	390	22 × 25	0.15	1.32	ELXQ161VSN391MP25S	200	1,200	30 × 50	0.15	2.88	ELXQ201VSN122MR50S
	560	22 × 30	0.15	1.66	ELXQ161VSN561MP30S		1,200	35 × 35	0.15	2.88	ELXQ201VSN122MA35S
	560	25.4 × 25	0.15	1.68	ELXQ161VSN561MQ25S		1,500	35 × 40	0.15	3.34	ELXQ201VSN152MA40S
	680	22 × 35	0.15	1.87	ELXQ161VSN681MP35S		1,800	35 × 45	0.15	3.74	ELXQ201VSN182MA45S
	680	25.4 × 30	0.15	1.88	ELXQ161VSN681MQ30S		1,800	35 × 50	0.15	3.82	ELXQ201VSN182MA50S
	680	30 × 25	0.15	1.96	ELXQ161VSN681MR25S		270	22 × 25	0.15	1.10	ELXQ221VSN271MP25S
	820	22 × 40	0.15	2.09	ELXQ161VSN821MP40S		330	22 × 30	0.15	1.19	ELXQ221VSN331MP30S
	1,000	22 × 45	0.15	2.36	ELXQ161VSN102MP45S		390	25.4 × 25	0.15	1.39	ELXQ221VSN391MQ25S
	1,000	22 × 50	0.15	2.41	ELXQ161VSN102MP50S		470	22 × 35	0.15	1.55	ELXQ221VSN471MP35S
	1,000	25.4 × 35	0.15	2.38	ELXQ161VSN102MQ35S		470	25.4 × 30	0.15	1.56	ELXQ221VSN471MQ30S
	1,000	30 × 30	0.15	2.40	ELXQ161VSN102MR30S		470	30 × 25	0.15	1.63	ELXQ221VSN471MR25S
	1,000	35 × 25	0.15	2.55	ELXQ161VSN102MA25S		560	22 × 40	0.15	1.73	ELXQ221VSN561MP40S
	1,200	25.4 × 40	0.15	2.66	ELXQ161VSN122MQ40S		560	30 × 30	0.15	1.79	ELXQ221VSN561MR30S
	1,200	25.4 × 45	0.15	2.71	ELXQ161VSN122MQ45S		680	22 × 45	0.15	1.94	ELXQ221VSN681MP45S
	1,200	30 × 35	0.15	2.69	ELXQ161VSN122MR35S		680	22 × 50	0.15	1.99	ELXQ221VSN681MQ50S
	1,200	30 × 40	0.15	2.77	ELXQ161VSN122MR40S	680	25.4 × 35	0.15	1.96	ELXQ221VSN681MQ35S	
	1,200	35 × 30	0.15	2.86	ELXQ161VSN122MA30S	680	30 × 35	0.15	2.02	ELXQ221VSN681MR35S	
	1,500	25.4 × 50	0.15	3.08	ELXQ161VSN152MQ50S	680	35 × 25	0.15	2.10	ELXQ221VSN681MA25S	
	1,500	30 × 45	0.15	3.17	ELXQ161VSN152MR45S	820	25.4 × 40	0.15	2.20	ELXQ221VSN821MQ40S	
	1,500	35 × 35	0.15	3.22	ELXQ161VSN152MA35S	820	25.4 × 45	0.15	2.24	ELXQ221VSN821MQ45S	
	1,800	30 × 50	0.15	3.53	ELXQ161VSN182MR50S	820	30 × 40	0.15	2.29	ELXQ221VSN821MR40S	
1,800	35 × 40	0.15	3.66	ELXQ161VSN182MA40S	820	35 × 30	0.15	2.36	ELXQ221VSN821MA30S		
2,200	35 × 45	0.15	4.14	ELXQ161VSN222MA45S	1,000	25.4 × 50	0.15	2.51	ELXQ221VSN102MQ50S		
2,700	35 × 50	0.15	4.68	ELXQ161VSN272MA50S	1,000	30 × 45	0.15	2.59	ELXQ221VSN102MR45S		
180	330	22 × 25	0.15	1.21	ELXQ181VSN331MP25S	1,000	35 × 35	0.15	2.63	ELXQ221VSN102MA35S	
	470	22 × 30	0.15	1.52	ELXQ181VSN471MP30S	1,200	30 × 50	0.15	2.88	ELXQ221VSN122MR50S	
	470	25.4 × 25	0.15	1.52	ELXQ181VSN471MQ25S	1,200	35 × 40	0.15	2.98	ELXQ221VSN122MA40S	
	560	22 × 35	0.15	1.70	ELXQ181VSN561MP35S	1,500	35 × 45	0.15	3.41	ELXQ221VSN152MA45S	
	560	30 × 25	0.15	1.78	ELXQ181VSN561MR25S	1,800	35 × 50	0.15	3.82	ELXQ221VSN182MA50S	
	680	22 × 40	0.15	1.91	ELXQ181VSN681MP40S	220	22 × 25	0.15	1.01	ELXQ251VSN221MP25S	
	680	25.4 × 30	0.15	1.88	ELXQ181VSN681MQ30S	270	22 × 30	0.15	1.20	ELXQ251VSN271MP30S	
	820	22 × 45	0.15	1.99	ELXQ181VSN821MP45S	330	25.4 × 25	0.15	1.32	ELXQ251VSN331MQ25S	
	820	25.4 × 35	0.15	2.16	ELXQ181VSN821MQ35S	390	22 × 35	0.15	1.44	ELXQ251VSN391MP35S	
	820	30 × 30	0.15	2.17	ELXQ181VSN821MR30S	390	25.4 × 30	0.15	1.43	ELXQ251VSN391MQ30S	
	820	35 × 25	0.15	2.31	ELXQ181VSN821MA25S	390	30 × 25	0.15	1.51	ELXQ251VSN391MR25S	
	1,000	22 × 50	0.15	2.25	ELXQ181VSN102MP50S	470	22 × 40	0.15	1.62	ELXQ251VSN471MP40S	
	1,000	25.4 × 40	0.15	2.43	ELXQ181VSN102MQ40S	560	22 × 45	0.15	1.80	ELXQ251VSN561MP45S	
	1,000	25.4 × 45	0.15	2.47	ELXQ181VSN102MQ45S	560	22 × 50	0.15	1.84	ELXQ251VSN561MP50S	
	1,000	30 × 35	0.15	2.46	ELXQ181VSN102MR35S	560	25.4 × 35	0.15	1.78	ELXQ251VSN561MQ35S	
	1,200	25.4 × 50	0.15	2.75	ELXQ181VSN122MQ50S	560	30 × 30	0.15	1.83	ELXQ251VSN561MR30S	
	1,200	30 × 40	0.15	2.77	ELXQ181VSN122MR40S	560	35 × 25	0.15	1.91	ELXQ251VSN561MA25S	
	1,200	35 × 30	0.15	2.86	ELXQ181VSN122MA30S	680	25.4 × 40	0.15	2.00	ELXQ251VSN681MQ40S	
	1,500	30 × 45	0.15	3.17	ELXQ181VSN152MR45S	680	25.4 × 45	0.15	2.04	ELXQ251VSN681MQ45S	
	1,500	30 × 50	0.15	3.22	ELXQ181VSN152MR50S	680	30 × 35	0.15	2.06	ELXQ251VSN681MR35S	
	1,500	35 × 35	0.15	3.22	ELXQ181VSN152MA35S	680	35 × 30	0.15	2.15	ELXQ251VSN681MA30S	
1,800	35 × 40	0.15	3.66	ELXQ181VSN182MA40S	820	25.4 × 50	0.15	2.28	ELXQ251VSN821MQ50S		
1,800	35 × 45	0.15	3.74	ELXQ181VSN182MA45S	820	30 × 40	0.15	2.33	ELXQ251VSN821MQ40S		
2,200	35 × 50	0.15	4.22	ELXQ181VSN222MA50S	820	30 × 45	0.15	2.39	ELXQ251VSN821MR45S		
200	270	22 × 25	0.15	1.10	ELXQ201VSN271MP25S	820	35 × 35	0.15	2.38	ELXQ251VSN821MA35S	
	390	22 × 30	0.15	1.38	ELXQ201VSN391MP30S	1,000	30 × 50	0.15	2.68	ELXQ251VSN102MR50S	
	390	25.4 × 25	0.15	1.39	ELXQ201VSN391MQ25S	1,000	35 × 40	0.15	2.72	ELXQ251VSN102MA40S	
	470	22 × 35	0.15	1.55	ELXQ201VSN471MP35S	1,200	35 × 45	0.15	3.05	ELXQ251VSN122MA45S	
	560	22 × 40	0.15	1.73	ELXQ201VSN561MP40S	1,500	35 × 50	0.15	3.49	ELXQ251VSN152MA50S	
	560	25.4 × 30	0.15	1.71	ELXQ201VSN561MQ30S	150	22 × 25	0.15	0.80	ELXQ3B1VSN151MP25S	
	560	30 × 25	0.15	1.78	ELXQ201VSN561MR25S	180	22 × 30	0.15	0.92	ELXQ3B1VSN181MP30S	
	680	22 × 45	0.15	1.81	ELXQ201VSN681MP45S	180	25.4 × 25	0.15	0.94	ELXQ3B1VSN181MQ25S	
	680	25.4 × 35	0.15	1.87	ELXQ201VSN681MQ35S	220	22 × 35	0.15	1.04	ELXQ3B1VSN221MP35S	
	680	30 × 30	0.15	1.98	ELXQ201VSN681MR30S	220	30 × 25	0.15	1.17	ELXQ3B1VSN221MR25S	
	680	35 × 25	0.15	2.10	ELXQ201VSN681MA25S	270	22 × 40	0.15	1.18	ELXQ3B1VSN271MP40S	
	820	22 × 50	0.15	2.18	ELXQ201VSN821MP50S	270	25.4 × 30	0.15	1.19	ELXQ3B1VSN271MQ30S	
	820	25.4 × 40	0.15	2.09	ELXQ201VSN821MQ40S	330	22 × 45	0.15	1.33	ELXQ3B1VSN331MP45S	
	820	30 × 35	0.15	2.22	ELXQ201VSN821MR35S	330	25.4 × 35	0.15	1.37	ELXQ3B1VSN331MQ35S	
	1,000	25.4 × 45	0.15	2.35	ELXQ201VSN102MQ45S	330	30 × 30	0.15	1.40	ELXQ3B1VSN331MR30S	
	1,000	25.4 × 50	0.15	2.39	ELXQ201VSN102MQ50S	330	35 × 25	0.15	1.49	ELXQ3B1VSN331MA25S	
	1,000	30 × 40	0.15	2.53	ELXQ201VSN102MR40S	390	22 × 50	0.15	1.48	ELXQ3B1VSN391MP50S	
	1,000	35 × 30	0.15	2.61	ELXQ201VSN102MA30S	390	25.4 × 40	0.15	1.52	ELXQ3B1VSN391MQ40S	
	1,200	30 × 45	0.15	2.84	ELXQ201VSN122MR45S	470	25.4 × 45	0.15	1.70	ELXQ3B1VSN471MQ45S	



◆ **STANDARD RATINGS**

WV (V _{dc})	Cap (μF)	Case size φD×L(mm)	tan δ	Rated ripple current (Arms/105°C, 120Hz)	Part No.	WV (V _{dc})	Cap (μF)	Case size φD×L(mm)	tan δ	Rated ripple current (Arms/105°C, 120Hz)	Part No.	
315	470	30 × 35	0.15	1.71	ELXQ3B1VSN471MR35S	400	470	30 × 45	0.15	1.81	ELXQ401VSN471MR45S	
	470	35 × 30	0.15	1.82	ELXQ3B1VSN471MA30S		470	30 × 50	0.15	1.84	ELXQ401VSN471MR50S	
	560	25.4 × 50	0.15	1.88	ELXQ3B1VSN561MQ50S		470	35 × 40	0.15	1.90	ELXQ401VSN471MA40S	
	560	30 × 40	0.15	1.92	ELXQ3B1VSN561MR40S		560	35 × 45	0.15	2.12	ELXQ401VSN561MA45S	
	560	30 × 45	0.15	1.97	ELXQ3B1VSN561MR45S		680	35 × 50	0.15	2.39	ELXQ401VSN681MA50S	
	560	35 × 35	0.15	2.00	ELXQ3B1VSN561MA35S		420	100	22 × 25	0.20	0.66	ELXQ421VSN101MP25S
	680	30 × 50	0.15	2.21	ELXQ3B1VSN681MR50S			120	22 × 30	0.20	0.75	ELXQ421VSN121MP30S
	680	35 × 40	0.15	2.29	ELXQ3B1VSN681MA40S			120	25.4 × 25	0.20	0.77	ELXQ421VSN121MQ25S
	820	35 × 45	0.15	2.57	ELXQ3B1VSN821MA45S			150	22 × 35	0.20	0.86	ELXQ421VSN151MP35S
	1,000	35 × 50	0.15	2.89	ELXQ3B1VSN102MA50S			180	22 × 40	0.20	0.96	ELXQ421VSN181MP40S
350	120	22 × 25	0.15	0.72	ELXQ351VSN121MP25S	180		22 × 45	0.20	0.98	ELXQ421VSN181MP45S	
	150	22 × 30	0.15	0.84	ELXQ351VSN151MP30S	180		25.4 × 30	0.20	0.97	ELXQ421VSN181MQ30S	
	180	25.4 × 25	0.15	0.94	ELXQ351VSN181MQ25S	180		25.4 × 35	0.20	1.01	ELXQ421VSN181MQ35S	
	220	22 × 35	0.15	1.04	ELXQ351VSN221MP35S	180		30 × 25	0.20	1.02	ELXQ421VSN181MR25S	
	220	22 × 40	0.15	1.06	ELXQ351VSN221MP40S	220		22 × 50	0.20	1.11	ELXQ421VSN221MP50S	
	220	25.4 × 30	0.15	1.07	ELXQ351VSN221MQ30S	220		25.4 × 40	0.20	1.14	ELXQ421VSN221MQ40S	
	220	30 × 25	0.15	1.13	ELXQ351VSN221MR25S	220		30 × 30	0.20	1.14	ELXQ421VSN221MR30S	
	270	22 × 45	0.15	1.20	ELXQ351VSN271MP45S	220		35 × 25	0.20	1.22	ELXQ421VSN221MA25S	
	270	25.4 × 35	0.15	1.24	ELXQ351VSN271MQ35S	270		25.4 × 45	0.20	1.29	ELXQ421VSN271MQ45S	
	270	30 × 30	0.15	1.27	ELXQ351VSN271MR30S	270		30 × 35	0.20	1.30	ELXQ421VSN271MR35S	
	270	35 × 25	0.15	1.35	ELXQ351VSN271MA25S	270		35 × 30	0.20	1.38	ELXQ421VSN271MA30S	
	330	22 × 50	0.15	1.36	ELXQ351VSN331MP50S	330		25.4 × 50	0.20	1.44	ELXQ421VSN331MQ50S	
	330	25.4 × 40	0.15	1.39	ELXQ351VSN331MQ40S	330		30 × 40	0.20	1.48	ELXQ421VSN331MP40S	
	330	30 × 35	0.15	1.43	ELXQ351VSN331MR35S	330		35 × 35	0.20	1.54	ELXQ421VSN331MA35S	
	390	25.4 × 45	0.15	1.55	ELXQ351VSN391MQ45S	390		30 × 45	0.20	1.64	ELXQ421VSN391MR45S	
	390	30 × 40	0.15	1.60	ELXQ351VSN391MR40S	390	35 × 40	0.20	1.73	ELXQ421VSN391MA40S		
	390	35 × 30	0.15	1.66	ELXQ351VSN391MA30S	470	30 × 50	0.20	1.84	ELXQ421VSN471MR50S		
	470	25.4 × 50	0.15	1.72	ELXQ351VSN471MQ50S	470	35 × 45	0.20	1.94	ELXQ421VSN471MA45S		
	470	30 × 45	0.15	1.81	ELXQ351VSN471MR45S	560	35 × 50	0.20	2.17	ELXQ421VSN561MA50S		
	470	35 × 35	0.15	1.83	ELXQ351VSN471MA35S	450	82	22 × 25	0.20	0.59	ELXQ451VSN820MP25S	
560	30 × 50	0.15	2.00	ELXQ351VSN561MR50S	100		22 × 30	0.20	0.69	ELXQ451VSN101MP30S		
560	35 × 40	0.15	2.07	ELXQ351VSN561MA40S	100		25.4 × 25	0.20	0.70	ELXQ451VSN101MQ25S		
680	35 × 45	0.15	2.34	ELXQ351VSN681MA45S	120		22 × 35	0.20	0.77	ELXQ451VSN121MP35S		
820	35 × 50	0.15	2.62	ELXQ351VSN821MA50S	150		22 × 40	0.20	0.88	ELXQ451VSN151MP40S		
400	100	22 × 25	0.15	0.66	ELXQ401VSN101MP25S		150	22 × 45	0.20	0.90	ELXQ451VSN151MP45S	
	120	22 × 30	0.15	0.75	ELXQ401VSN121MP30S		150	25.4 × 30	0.20	0.88	ELXQ451VSN151MQ30S	
	150	22 × 35	0.15	0.86	ELXQ401VSN151MP35S		150	25.4 × 35	0.20	0.92	ELXQ451VSN151MQ35S	
	150	25.4 × 25	0.15	0.86	ELXQ401VSN151MQ25S		150	30 × 25	0.20	0.93	ELXQ451VSN151MR25S	
	180	22 × 40	0.15	0.96	ELXQ401VSN181MP40S		180	22 × 50	0.20	1.01	ELXQ451VSN181MP50S	
	180	25.4 × 30	0.15	0.97	ELXQ401VSN181MQ30S		180	25.4 × 40	0.20	1.03	ELXQ451VSN181MQ40S	
	180	30 × 25	0.15	1.02	ELXQ401VSN181MR25S		180	30 × 30	0.20	1.03	ELXQ451VSN181MR30S	
	220	22 × 45	0.15	1.09	ELXQ401VSN221MP45S		180	35 × 25	0.20	1.10	ELXQ451VSN181MA25S	
	220	25.4 × 35	0.15	1.12	ELXQ401VSN221MQ35S		220	25.4 × 45	0.20	1.16	ELXQ451VSN221MQ45S	
	220	35 × 25	0.15	1.22	ELXQ401VSN221MA25S		220	30 × 35	0.20	1.17	ELXQ451VSN221MR35S	
	270	22 × 50	0.15	1.23	ELXQ401VSN271MP50S		220	35 × 30	0.20	1.24	ELXQ451VSN221MA30S	
	270	25.4 × 40	0.15	1.26	ELXQ401VSN271MQ40S		270	25.4 × 50	0.20	1.31	ELXQ451VSN271MQ50S	
	270	25.4 × 45	0.15	1.29	ELXQ401VSN271MQ45S		270	30 × 40	0.20	1.33	ELXQ451VSN271MR40S	
	270	30 × 30	0.15	1.27	ELXQ401VSN271MR30S		270	35 × 35	0.20	1.39	ELXQ451VSN271MA35S	
	330	25.4 × 50	0.15	1.44	ELXQ401VSN331MQ50S		330	30 × 45	0.20	1.51	ELXQ451VSN331MR45S	
	330	30 × 35	0.15	1.43	ELXQ401VSN331MR35S	390	30 × 50	0.20	1.67	ELXQ451VSN391MR50S		
	330	35 × 30	0.15	1.52	ELXQ401VSN331MA30S	390	35 × 40	0.20	1.73	ELXQ451VSN391MA40S		
	390	30 × 40	0.15	1.60	ELXQ401VSN391MR40S	390	35 × 45	0.20	1.77	ELXQ451VSN391MA45S		
	390	35 × 35	0.15	1.67	ELXQ401VSN391MA35S	470	35 × 50	0.20	1.98	ELXQ451VSN471MA50S		

◆ **RATED RIPPLE CURRENT MULTIPLIERS**

● Frequency Multipliers

Frequency(Hz)	50	120	300	1k	10k	50k
160 to 250V _{dc}	0.81	1.00	1.17	1.32	1.45	1.50
315 to 450V _{dc}	0.77	1.00	1.16	1.30	1.41	1.43

The deterioration of aluminum electrolytic capacitors accelerates their life due to the internal heating produced by ripple current. For details, refer to Section "5-3 Ripple Current Effect on Lifetime" in the catalog, Technical Note.

LXG Series

- Endurance with ripple current : 5,000 hours at 105°C
- Non solvent resistant type
- RoHS2 Compliant

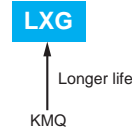

SPECIFICATIONS

Items	Characteristics
Category	
Temperature Range	-40 to +105°C
Rated Voltage Range	10 to 100V _{dc}
Capacitance Tolerance	±20% (M) (at 20°C, 120Hz)
Leakage Current	I=0.02CV or 3mA, whichever is smaller. Where, I : Max. leakage current (µA), C : Nominal capacitance (µF), V : Rated voltage (V) (at 20°C after 5 minutes)
Dissipation Factor (tan δ)	Rated voltage (V _{dc}) 10V 16V 25V 35V 50V 63V 80 & 100V tan δ (Max.) 0.60 0.45 0.30 0.25 0.20 0.15 0.15 (at 20°C, 120Hz)
Low Temperature Characteristics (Max. Impedance Ratio)	Capacitance change : Capacitance at the lowest operating temperature shall not be less than 70% of the 20°C value. Rated voltage (V _{dc}) 10V 16V 25V 35V 50V 63V 80 & 100V Z(-25°C)/Z(+20°C) 4 4 3 3 2 2 2 Z(-40°C)/Z(+20°C) 15 15 10 8 6 6 5 (at 120Hz)
Endurance	The following specifications shall be satisfied when the capacitors are restored to 20°C after subjected to DC voltage with rated ripple current is applied (the peak voltage shall not exceed the rated voltage) for 5,000 hours at 105°C. Capacitance change ≤ ±25% of the initial value D.F. (tan δ) ≤ 250% of the initial specified value Leakage current ≤ The initial specified value
Shelf Life	The following specifications shall be satisfied when the capacitors are restored to 20°C after exposing them for 500 hours at 105°C without voltage applied. Before the measurement, the capacitor shall be preconditioned by applying voltage according to Item 4.1 of JIS C 5101-4. Capacitance change ≤ ±20% of the initial value D.F. (tan δ) ≤ 150% of the initial specified value Leakage current ≤ The initial specified value

DIMENSIONS [mm]

Terminal Code : VS (φ22 to φ35) : Standard

Terminal Code : LI (φ35)

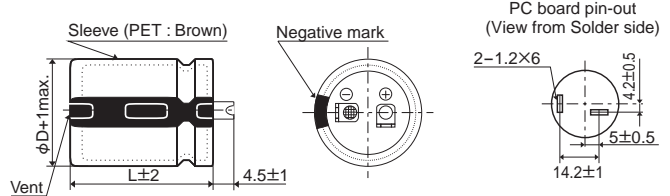
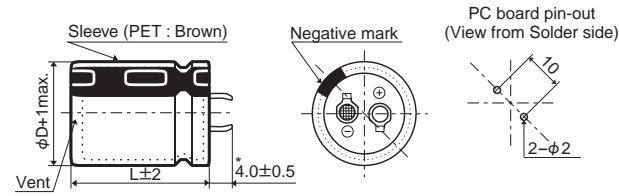

*φD=35mm : 3.5±0.5mm

The standard design has no plastic disc.

PART NUMBERING SYSTEM

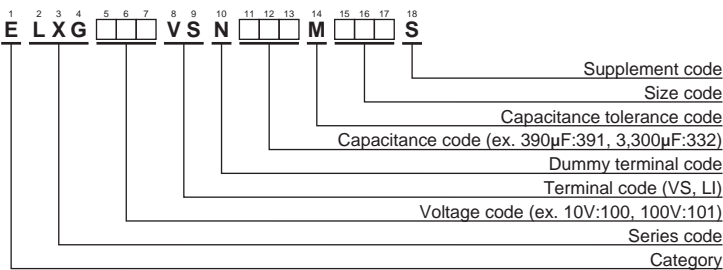

Please refer to "Product code guide (snap-in type)"

RATED RIPPLE CURRENT MULTIPLIERS

Frequency Multipliers

Frequency(Hz)	50	120	300	1k	10k	50k
10 to 50V _{dc}	0.95	1.00	1.03	1.05	1.08	1.08
63 to 100V _{dc}	0.92	1.00	1.07	1.13	1.19	1.20

The deterioration of aluminum electrolytic capacitors accelerates their life due to the internal heating produced by ripple current. For details, refer to Section "5-3 Ripple Current Effect on Lifetime" in the catalog, Technical Note.



◆STANDARD RATINGS

WV (V _{dc})	Cap (μF)	Case size φD×L(mm)	tan δ	Rated ripple current (Arms/105°C, 120Hz)	Part No.	WV (V _{dc})	Cap (μF)	Case size φD×L(mm)	tan δ	Rated ripple current (Arms/105°C, 120Hz)	Part No.	
10	6,800	22 × 25	0.60	1.30	ELXG100VSN682MP25S	35	5,600	25.4 × 35	0.25	1.98	ELXG350VSN562MQ35S	
	10,000	22 × 30	0.60	1.65	ELXG100VSN103MP30S		5,600	30 × 30	0.25	1.98	ELXG350VSN562MR30S	
	10,000	25.4 × 25	0.60	1.64	ELXG100VSN103MQ25S		5,600	35 × 25	0.25	2.03	ELXG350VSN562MA25S	
	12,000	22 × 35	0.60	1.85	ELXG100VSN123MP35S		6,800	22 × 50	0.25	2.26	ELXG350VSN682MP50S	
	12,000	25.4 × 30	0.60	1.85	ELXG100VSN123MQ30S		6,800	25.4 × 40	0.25	2.24	ELXG350VSN682MQ40S	
	12,000	30 × 25	0.60	1.89	ELXG100VSN123MR25S		8,200	25.4 × 50	0.25	2.57	ELXG350VSN822MQ50S	
	15,000	22 × 40	0.60	2.12	ELXG100VSN153MP40S		8,200	30 × 35	0.25	2.50	ELXG350VSN822MR35S	
	15,000	25.4 × 35	0.60	2.16	ELXG100VSN153MQ35S		8,200	35 × 30	0.25	2.55	ELXG350VSN822MA30S	
	18,000	22 × 50	0.60	2.45	ELXG100VSN183MP50S		10,000	30 × 40	0.25	2.86	ELXG350VSN103MR40S	
	18,000	25.4 × 40	0.60	2.43	ELXG100VSN183MQ40S		10,000	35 × 35	0.25	2.88	ELXG350VSN103MA35S	
	18,000	30 × 30	0.60	2.37	ELXG100VSN183MR30S		12,000	30 × 50	0.25	3.32	ELXG350VSN123MR50S	
	18,000	35 × 25	0.60	2.42	ELXG100VSN183MA25S		12,000	35 × 40	0.25	3.30	ELXG350VSN123MA40S	
	22,000	30 × 35	0.60	2.73	ELXG100VSN223MR35S		18,000	35 × 50	0.25	4.29	ELXG350VSN183MA50S	
	22,000	35 × 30	0.60	2.79	ELXG100VSN223MA30S		50	1,500	22 × 25	0.20	1.02	ELXG500VSN152MP25S
	27,000	25.4 × 50	0.60	3.11	ELXG100VSN273MQ50S			1,800	22 × 30	0.20	1.17	ELXG500VSN182MP30S
	27,000	30 × 40	0.60	3.13	ELXG100VSN273MR40S			1,800	25.4 × 25	0.20	1.17	ELXG500VSN182MQ25S
	33,000	35 × 35	0.60	3.49	ELXG100VSN333MA35S			2,200	22 × 35	0.20	1.33	ELXG500VSN222MP35S
	39,000	30 × 50	0.60	3.99	ELXG100VSN393MR50S			2,700	22 × 40	0.20	1.51	ELXG500VSN272MP40S
	39,000	35 × 40	0.60	3.96	ELXG100VSN393MA40S			2,700	25.4 × 30	0.20	1.47	ELXG500VSN272MQ30S
	47,000	35 × 50	0.60	4.62	ELXG100VSN473MA50S			2,700	30 × 25	0.20	1.50	ELXG500VSN272MR25S
16	5,600	22 × 25	0.45	1.44	ELXG160VSN562MP25S	3,300		25.4 × 35	0.20	1.70	ELXG500VSN332MQ35S	
	6,800	22 × 30	0.45	1.66	ELXG160VSN682MP30S	3,300		30 × 30	0.20	1.70	ELXG500VSN332MR30S	
	6,800	25.4 × 25	0.45	1.66	ELXG160VSN682MQ25S	3,300		35 × 25	0.20	1.74	ELXG500VSN332MA25S	
	8,200	22 × 35	0.45	1.87	ELXG160VSN822MP35S	3,900		22 × 50	0.20	1.91	ELXG500VSN392MP50S	
	10,000	22 × 40	0.45	2.12	ELXG160VSN103MP40S	3,900		25.4 × 40	0.20	1.89	ELXG500VSN392MQ40S	
	10,000	25.4 × 30	0.45	2.07	ELXG160VSN103MQ30S	4,700		30 × 35	0.20	2.11	ELXG500VSN472MR35S	
	10,000	30 × 25	0.45	2.11	ELXG160VSN103MR25S	4,700		35 × 30	0.20	2.16	ELXG500VSN472MA30S	
	12,000	25.4 × 35	0.45	2.37	ELXG160VSN123MQ35S	5,600		25.4 × 50	0.20	2.38	ELXG500VSN562MQ50S	
	12,000	30 × 30	0.45	2.37	ELXG160VSN123MR30S	5,600		30 × 40	0.20	2.39	ELXG500VSN562MR40S	
	12,000	35 × 25	0.45	2.42	ELXG160VSN123MA25S	5,600		35 × 35	0.20	2.41	ELXG500VSN562MA35S	
	15,000	22 × 50	0.45	2.74	ELXG160VSN153MP50S	6,800		30 × 50	0.20	2.79	ELXG500VSN682MR50S	
	15,000	25.4 × 40	0.45	2.71	ELXG160VSN153MQ40S	6,800		35 × 40	0.20	2.78	ELXG500VSN682MA40S	
	18,000	25.4 × 50	0.45	3.11	ELXG160VSN183MQ50S	10,000		35 × 50	0.20	3.57	ELXG500VSN103MA50S	
	18,000	30 × 35	0.45	3.02	ELXG160VSN183MR35S	1,000	22 × 25	0.15	1.00	ELXG630VSN102MP25S		
	18,000	35 × 30	0.45	3.09	ELXG160VSN183MA30S	1,200	22 × 30	0.15	1.15	ELXG630VSN122MP30S		
	22,000	30 × 40	0.45	3.46	ELXG160VSN223MR40S	1,200	25.4 × 25	0.15	1.15	ELXG630VSN122MQ25S		
	22,000	35 × 35	0.45	3.49	ELXG160VSN223MA35S	1,500	22 × 35	0.15	1.32	ELXG630VSN152MP35S		
	27,000	30 × 50	0.45	4.07	ELXG160VSN273MR50S	1,800	22 × 40	0.15	1.49	ELXG630VSN182MP40S		
	27,000	35 × 40	0.45	4.04	ELXG160VSN273MA40S	1,800	25.4 × 30	0.15	1.45	ELXG630VSN182MQ30S		
	39,000	35 × 50	0.45	5.16	ELXG160VSN393MA50S	1,800	30 × 25	0.15	1.48	ELXG630VSN182MR25S		
25	3,900	22 × 25	0.30	1.31	ELXG250VSN392MP25S	2,200	25.4 × 35	0.15	1.67	ELXG630VSN222MQ35S		
	4,700	22 × 30	0.30	1.51	ELXG250VSN472MP30S	2,200	30 × 30	0.15	1.68	ELXG630VSN222MR30S		
	4,700	25.4 × 25	0.30	1.51	ELXG250VSN472MQ25S	2,200	35 × 25	0.15	1.71	ELXG630VSN222MA25S		
	5,600	22 × 35	0.30	1.70	ELXG250VSN562MP35S	2,700	22 × 50	0.15	1.92	ELXG630VSN272MP50S		
	6,800	22 × 40	0.30	1.92	ELXG250VSN682MP40S	2,700	25.4 × 40	0.15	1.90	ELXG630VSN272MQ40S		
	6,800	25.4 × 30	0.30	1.87	ELXG250VSN682MQ30S	2,700	30 × 35	0.15	1.93	ELXG630VSN272MR35S		
	6,800	30 × 25	0.30	1.90	ELXG250VSN682MR25S	3,300	25.4 × 50	0.15	2.20	ELXG630VSN332MQ50S		
	8,200	25.4 × 35	0.30	2.14	ELXG250VSN822MQ35S	3,300	35 × 30	0.15	2.18	ELXG630VSN332MA30S		
	8,200	30 × 30	0.30	2.15	ELXG250VSN822MR30S	3,900	30 × 40	0.15	2.41	ELXG630VSN392MR40S		
	8,200	35 × 25	0.30	2.19	ELXG250VSN822MA25S	3,900	35 × 35	0.15	2.43	ELXG630VSN392MA35S		
	10,000	22 × 50	0.30	2.45	ELXG250VSN103MP50S	4,700	30 × 50	0.15	2.80	ELXG630VSN472MR50S		
	10,000	25.4 × 40	0.30	2.43	ELXG250VSN103MQ40S	4,700	35 × 40	0.15	2.78	ELXG630VSN472MA40S		
	12,000	25.4 × 50	0.30	2.78	ELXG250VSN123MQ50S	6,800	35 × 50	0.15	3.55	ELXG630VSN682MA50S		
	12,000	30 × 35	0.30	2.70	ELXG250VSN123MR35S	80	680	22 × 25	0.15	0.97	ELXG800VSN681MP25S	
	12,000	35 × 30	0.30	2.76	ELXG250VSN123MA30S		820	22 × 30	0.15	1.12	ELXG800VSN821MP30S	
	15,000	30 × 40	0.30	3.13	ELXG250VSN153MR40S		1,000	22 × 35	0.15	1.27	ELXG800VSN102MP35S	
	15,000	35 × 35	0.30	3.16	ELXG250VSN153MA35S		1,000	25.4 × 25	0.15	1.23	ELXG800VSN102MQ25S	
	18,000	30 × 50	0.30	3.64	ELXG250VSN183MR50S		1,200	22 × 40	0.15	1.42	ELXG800VSN122MP40S	
	18,000	35 × 40	0.30	3.61	ELXG250VSN183MA40S		1,200	25.4 × 30	0.15	1.39	ELXG800VSN122MQ30S	
	27,000	35 × 50	0.30	4.70	ELXG250VSN273MA50S		1,200	30 × 25	0.15	1.41	ELXG800VSN122MR25S	
35	2,200	22 × 25	0.25	1.10	ELXG350VSN222MP25S		1,500	25.4 × 35	0.15	1.62	ELXG800VSN152MQ35S	
	3,300	22 × 30	0.25	1.42	ELXG350VSN332MP30S		1,800	22 × 50	0.15	1.84	ELXG800VSN182MP50S	
	3,300	25.4 × 25	0.25	1.41	ELXG350VSN332MQ25S		1,800	25.4 × 40	0.15	1.82	ELXG800VSN182MQ40S	
	3,900	22 × 35	0.25	1.58	ELXG350VSN392MP35S		1,800	30 × 30	0.15	1.78	ELXG800VSN182MR30S	
	3,900	25.4 × 30	0.25	1.58	ELXG350VSN392MQ30S		1,800	35 × 25	0.15	1.82	ELXG800VSN182MA25S	
	4,700	22 × 40	0.25	1.78	ELXG350VSN472MP40S		2,200	25.4 × 50	0.15	2.11	ELXG800VSN222MQ50S	
	4,700	30 × 25	0.25	1.77	ELXG350VSN472MR25S		2,200	30 × 35	0.15	2.05	ELXG800VSN222MR35S	



◆STANDARD RATINGS

WV (V _{dc})	Cap (μF)	Case size φD×L(mm)	tan δ	Rated ripple current (Arms/105°C, 120Hz)	Part No.	WV (V _{dc})	Cap (μF)	Case size φD×L(mm)	tan δ	Rated ripple current (Arms/105°C, 120Hz)	Part No.
80	2,200	35 × 30	0.15	2.09	ELXG800VSN222MA30S	100	1,000	25.4 × 35	0.15	1.41	ELXG101VSN102MQ35S
	2,700	30 × 40	0.15	2.35	ELXG800VSN272MR40S		1,000	30 × 30	0.15	1.42	ELXG101VSN102MR30S
	2,700	35 × 35	0.15	2.37	ELXG800VSN272MA35S		1,000	35 × 25	0.15	1.45	ELXG101VSN102MA25S
	3,300	30 × 50	0.15	2.75	ELXG800VSN332MR50S		1,200	22 × 50	0.15	1.60	ELXG101VSN122MP50S
	3,300	35 × 40	0.15	2.73	ELXG800VSN332MA40S		1,200	25.4 × 40	0.15	1.59	ELXG101VSN122MQ40S
	4,700	35 × 50	0.15	3.46	ELXG800VSN472MA50S		1,200	30 × 35	0.15	1.61	ELXG101VSN122MR35S
100	390	22 × 25	0.15	0.78	ELXG101VSN391MP25S		1,500	25.4 × 50	0.15	1.86	ELXG101VSN152MQ50S
	560	22 × 30	0.15	0.99	ELXG101VSN561MP30S		1,500	30 × 40	0.15	1.87	ELXG101VSN152MR40S
	560	25.4 × 25	0.15	0.98	ELXG101VSN561MQ25S		1,500	35 × 30	0.15	1.85	ELXG101VSN152MA30S
	680	22 × 35	0.15	1.12	ELXG101VSN681MP35S		1,800	35 × 35	0.15	2.07	ELXG101VSN182MA35S
	820	22 × 40	0.15	1.26	ELXG101VSN821MP40S		2,200	30 × 50	0.15	2.40	ELXG101VSN222MR50S
	820	25.4 × 30	0.15	1.23	ELXG101VSN821MQ30S		2,200	35 × 40	0.15	2.39	ELXG101VSN222MA40S
	820	30 × 25	0.15	1.25	ELXG101VSN821MR25S		2,700	35 × 50	0.15	2.81	ELXG101VSN272MA50S

◆MAXIMUM IMPEDANCE [mΩ/20°C, 30kHz]

Case size φD×L(mm)	V _{dc}		
	10 to 63	80	100
22×25	120	150	
22×30	100	120	
22×35	80	95	
22×40	70	80	
22×50	50	60	
25.4×25	90	110	
25.4×30	70	85	
25.4×35	60	70	
25.4×40	50	60	
25.4×50	40	45	
30×25	70	80	
30×30	50	60	
30×35	40	50	
30×40	35	40	
30×50	25	30	
35×25	65	70	
35×30	45	50	
35×35	38	40	
35×40	30	30	
35×50	23	25	

LVA Series

- Designed for automotive application (including On Board Charger) by high vibration resistance structure.
- Endurance with ripple current : 5,000 hours at 105°C
- Rated voltage range : 450V_{dc}, Capacitance range : 150 to 890μF
- Non solvent resistant type
- RoHS2 Compliant
- AEC-Q200 compliant : Please contact Chemi-Con for more details, test data, information.



SPECIFICATIONS

Items	Characteristics	
Category	-40 to +105°C	
Temperature Range		
Rated Voltage Range	450V _{dc}	
Capacitance Tolerance	±20% (M) (at 20°C, 120Hz)	
Leakage Current	I ≤ 3/CV Where, I : Max. leakage current (μA), C : Nominal capacitance (μF), V : Rated voltage (V) (at 20°C after 5 minutes)	
Dissipation Factor (tan δ)	Rated voltage (V _{dc})	450V
	tan δ (Max.)	0.20 (at 20°C, 120Hz)
Low Temperature Characteristics (Max. Impedance Ratio)	Rated voltage (V _{dc})	450V
	Z(-25°C)/Z(+20°C)	8 (at 120Hz)
Endurance	The following specifications shall be satisfied when the capacitors are restored to 20°C after subjected to DC voltage with the rated ripple current is applied (the peak voltage shall not exceed the rated voltage) for 5,000 hours at 105°C.	
	Capacitance change	≤ ±20% of the initial value
	D.F. (tan δ)	≤ 200% of the initial specified value
	Leakage current	≤ The initial specified value
Shelf Life	The following specifications shall be satisfied when the capacitors are restored to 20°C after exposing them for 1,000 hours at 105°C without voltage applied. Before the measurement, the capacitor shall be preconditioned by applying voltage according to Item 4.1 of JIS C 5101-4.	
	Capacitance change	≤ ±15% of the initial value
	D.F. (tan δ)	≤ 150% of the initial specified value
	Leakage current	≤ The initial specified value
Vibration	The following specifications shall be satisfied when the capacitors are restored to 20°C after subjected to vibration test (vibration profile shown below) at room temperature (15 to 35°C).	
	Capacitance change	≤ ±5% of the initial value
	D.F. (tan δ)	≤ The initial specified value
	Leakage current	≤ The initial specified value
	Vibration profile	
	Vibration frequency range	10 to 2,000Hz
	Acceleration	49m/s ² (5G)
	Sweep rate	10 to 2,000 to 10Hz 20 minutes
	Direction and period of motion	4 hours in each of 3 mutually perpendicular directions (total of 12 hours)
	Fixation	Securely attach the main body using a fixing tool. Please contact us for details.

DIMENSIONS [mm]

Terminal Code : VS (φ25.4 to φ35) : Standard

Terminal Code : LI (φ30, φ35)

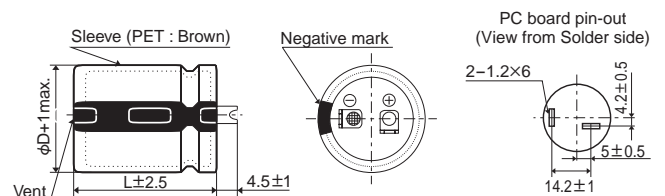
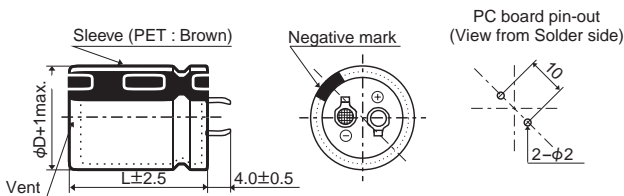

The standard design has no plastic disc.

PART NUMBERING SYSTEM

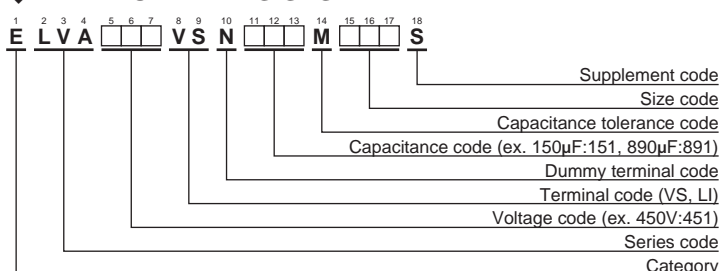

Please refer to "Product code guide (snap-in type)"



LVA Series

◆ STANDARD RATINGS

WV (V _{dc})	Cap (μF)	Case size φD×L(mm)	tan δ	Rated ripple current (Arms/105°C, 120Hz)	Part No.	WV (V _{dc})	Cap (μF)	Case size φD×L(mm)	tan δ	Rated ripple current (Arms/105°C, 120Hz)	Part No.
450	150	25.4 × 25	0.20	0.93	ELVA451VSN151MQ25S	450	410	30 × 40	0.20	1.67	ELVA451VSN411MR40S
	190	25.4 × 30	0.20	1.07	ELVA451VSN191MQ30S		440	35 × 35	0.20	1.64	ELVA451VSN441MA35S
	210	30 × 25	0.20	1.13	ELVA451VSN211MR25S		450	25.4 × 60	0.20	1.91	ELVA451VSN451MQ60S
	230	25.4 × 35	0.20	1.23	ELVA451VSN231MQ35S		470	30 × 45	0.20	1.84	ELVA451VSN471MR45S
	260	35 × 25	0.20	1.22	ELVA451VSN261MA25S		530	35 × 40	0.20	1.86	ELVA451VSN531MA40S
	280	25.4 × 40	0.20	1.39	ELVA451VSN281MQ40S		540	30 × 50	0.20	2.00	ELVA451VSN541MR50S
	280	30 × 30	0.20	1.31	ELVA451VSN281MR30S		600	30 × 55	0.20	2.15	ELVA451VSN601MR55S
	320	25.4 × 45	0.20	1.51	ELVA451VSN321MQ45S		620	35 × 45	0.20	2.06	ELVA451VSN621MA45S
	340	30 × 35	0.20	1.48	ELVA451VSN341MR35S		660	30 × 60	0.20	2.30	ELVA451VSN661MR60S
	350	35 × 30	0.20	1.44	ELVA451VSN351MA30S		710	35 × 50	0.20	2.25	ELVA451VSN711MA50S
	360	25.4 × 50	0.20	1.63	ELVA451VSN361MQ50S		800	35 × 55	0.20	2.44	ELVA451VSN801MA55S
	410	25.4 × 55	0.20	1.79	ELVA451VSN411MQ55S		890	35 × 60	0.20	2.62	ELVA451VSN891MA60S

◆ RATED RIPPLE CURRENT MULTIPLIERS

● Frequency Multipliers

Frequency(Hz)	50	120	300	1k	10k	50k
450V	0.77	1.00	1.16	1.30	1.41	1.43

The deterioration of aluminum electrolytic capacitors accelerates their life due to the internal heating produced by ripple current. For details, refer to Section "5-3 Ripple Current Effect on Lifetime" in the catalog, Technical Note.



KVB Series

- Designed for automotive application (including On Board Charger) by high vibration resistance structure.
- Endurance with ripple current : 3,000 hours at 105°C
- Rated voltage range : 450V_{dc}, Capacitance range : 150 to 920μF
- Non solvent resistant type
- RoHS2 Compliant
- AEC-Q200 compliant : Please contact Chemi-Con for more details, test data, information.



◆ SPECIFICATIONS

Items	Characteristics	
Category	-40 to +105°C	
Temperature Range		
Rated Voltage Range	450V _{dc}	
Capacitance Tolerance	±20% (M) (at 20°C, 120Hz)	
Leakage Current	I ≤ 3/CV Where, I : Max. leakage current (μA), C : Nominal capacitance (μF), V : Rated voltage (V) (at 20°C after 5 minutes)	
Dissipation Factor (tan δ)	Rated voltage (V _{dc})	450V
	tan δ (Max.)	0.20 (at 20°C, 120Hz)
Low Temperature Characteristics (Max. Impedance Ratio)	Rated voltage (V _{dc})	450V
	Z(-25°C)/Z(+20°C)	8 (at 120Hz)
Endurance	The following specifications shall be satisfied when the capacitors are restored to 20°C after subjected to DC voltage with the rated ripple current is applied (the peak voltage shall not exceed the rated voltage) for 3,000 hours at 105°C.	
	Capacitance change	≤ ±20% of the initial value
	D.F. (tan δ)	≤ 200% of the initial specified value
Shelf Life	The following specifications shall be satisfied when the capacitors are restored to 20°C after exposing them for 1,000 hours at 105°C without voltage applied. Before the measurement, the capacitor shall be preconditioned by applying voltage according to Item 4.1 of JIS C 5101-4.	
	Capacitance change	≤ ±15% of the initial value
	D.F. (tan δ)	≤ 150% of the initial specified value
Vibration	The following specifications shall be satisfied when the capacitors are restored to 20°C after subjected to vibration test (vibration profile shown below) at room temperature (15 to 35°C).	
	Capacitance change	≤ ±5% of the initial value
	D.F. (tan δ)	≤ The initial specified value
	Leakage current	≤ The initial specified value
	Vibration profile	
	Vibration frequency range	10 to 2,000Hz
	Acceleration	49m/s ² (5G)
	Sweep rate	10 to 2,000 to 10Hz 20 minutes
	Direction and period of motion	4 hours in each of 3 mutually perpendicular directions (total of 12 hours)
	Fixation	Securely attach the main body using a fixing tool. Please contact us for details.

◆ DIMENSIONS [mm]

● Terminal Code : VS (φ25.4 to φ35) : Standard

● Terminal Code : LI (φ30, φ35)

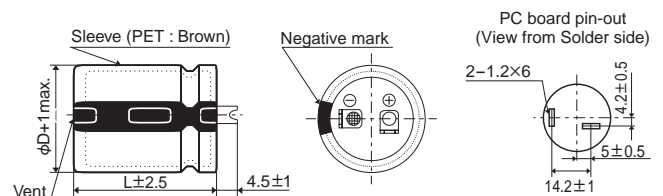
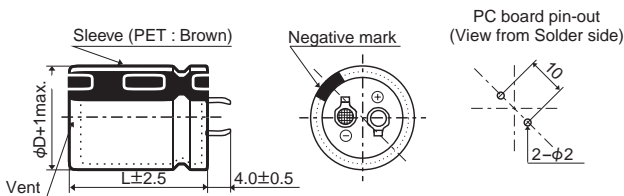

The standard design has no plastic disc.

◆ PART NUMBERING SYSTEM

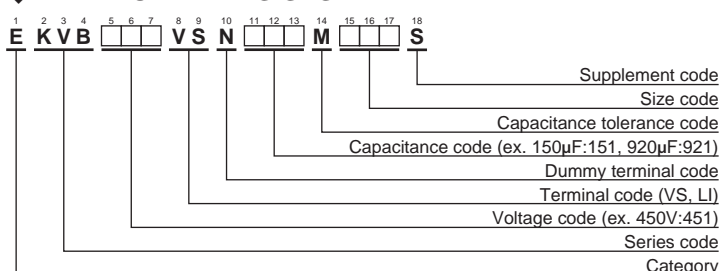

Please refer to "Product code guide (snap-in type)"



KVB Series

◆STANDARD RATINGS

WV (V _{dc})	Cap (μF)	Case size φD×L(mm)	tan δ	Rated ripple current (Arms/105°C, 120Hz)	Part No.	WV (V _{dc})	Cap (μF)	Case size φD×L(mm)	tan δ	Rated ripple current (Arms/105°C, 120Hz)	Part No.
450	150	25.4 × 25	0.20	0.93	EKVB451VSN151MQ25S	450	420	30 × 40	0.20	1.69	EKVB451VSN421MR40S
	200	25.4 × 30	0.20	1.10	EKVB451VSN201MQ30S		460	35 × 35	0.20	1.67	EKVB451VSN461MA35S
	220	30 × 25	0.20	1.15	EKVB451VSN221MR25S		470	25.4 × 60	0.20	1.96	EKVB451VSN471MQ60S
	240	25.4 × 35	0.20	1.26	EKVB451VSN241MQ35S		490	30 × 45	0.20	1.88	EKVB451VSN491MR45S
	270	35 × 25	0.20	1.24	EKVB451VSN271MA25S		550	35 × 40	0.20	1.90	EKVB451VSN551MA40S
	290	25.4 × 40	0.20	1.41	EKVB451VSN291MQ40S		560	30 × 50	0.20	2.04	EKVB451VSN561MR50S
	290	30 × 30	0.20	1.34	EKVB451VSN291MR30S		620	30 × 55	0.20	2.19	EKVB451VSN621MR55S
	330	25.4 × 45	0.20	1.54	EKVB451VSN331MQ45S		650	35 × 45	0.20	2.11	EKVB451VSN651MA45S
	350	30 × 35	0.20	1.50	EKVB451VSN351MR35S		690	30 × 60	0.20	2.35	EKVB451VSN691MR60S
	370	35 × 30	0.20	1.48	EKVB451VSN371MA30S		740	35 × 50	0.20	2.30	EKVB451VSN741MA50S
	380	25.4 × 50	0.20	1.67	EKVB451VSN381MQ50S		830	35 × 55	0.20	2.48	EKVB451VSN831MA55S
	420	25.4 × 55	0.20	1.81	EKVB451VSN421MQ55S		920	35 × 60	0.20	2.66	EKVB451VSN921MA60S

◆RATED RIPPLE CURRENT MULTIPLIERS

●Frequency Multipliers

Frequency(Hz)	50	120	300	1k	10k	50k
450V	0.77	1.00	1.16	1.30	1.41	1.43

The deterioration of aluminum electrolytic capacitors accelerates their life due to the internal heating produced by ripple current. For details, refer to Section "5-3 Ripple Current Effect on Lifetime" in the catalog, Technical Note.



KVA Series

- Designed for automotive application (including On Board Charger) by high vibration resistance structure.
- Endurance with ripple current : 2,000 hours at 105°C
- Rated voltage range : 450V_{dc}, Capacitance range : 160 to 970μF
- Non solvent resistant type
- RoHS2 Compliant
- AEC-Q200 compliant : Please contact Chemi-Con for more details, test data, information.



◆ SPECIFICATIONS

Items	Characteristics	
Category	-40 to +105°C	
Temperature Range		
Rated Voltage Range	450V _{dc}	
Capacitance Tolerance	±20% (M) (at 20°C, 120Hz)	
Leakage Current	I ≤ 3/CV Where, I : Max. leakage current (μA), C : Nominal capacitance (μF), V : Rated voltage (V) (at 20°C after 5 minutes)	
Dissipation Factor (tan δ)	Rated voltage (V _{dc})	450V
	tan δ (Max.)	0.20 (at 20°C, 120Hz)
Low Temperature Characteristics (Max. Impedance Ratio)	Rated voltage (V _{dc})	450V
	Z(-25°C)/Z(+20°C)	8 (at 120Hz)
Endurance	The following specifications shall be satisfied when the capacitors are restored to 20°C after subjected to DC voltage with the rated ripple current is applied (the peak voltage shall not exceed the rated voltage) for 2,000 hours at 105°C.	
	Capacitance change	≤ ±20% of the initial value
	D.F. (tan δ)	≤ 200% of the initial specified value
Shelf Life	The following specifications shall be satisfied when the capacitors are restored to 20°C after exposing them for 1,000 hours at 105°C without voltage applied. Before the measurement, the capacitor shall be preconditioned by applying voltage according to Item 4.1 of JIS C 5101-4.	
	Capacitance change	≤ ±15% of the initial value
	D.F. (tan δ)	≤ 150% of the initial specified value
Vibration	The following specifications shall be satisfied when the capacitors are restored to 20°C after subjected to vibration test (vibration profile shown below) at room temperature (15 to 35°C).	
	Capacitance change	≤ ±5% of the initial value
	D.F. (tan δ)	≤ The initial specified value
	Leakage current	≤ The initial specified value
	Vibration profile	
	Vibration frequency range	10 to 2,000Hz
	Acceleration	49m/s ² (5G)
	Sweep rate	10 to 2,000 to 10Hz 20 minutes
	Direction and period of motion	4 hours in each of 3 mutually perpendicular directions (total of 12 hours)
	Fixation	Securely attach the main body using a fixing tool. Please contact us for details.

◆ DIMENSIONS [mm]

● Terminal Code : VS (φ25.4 to φ35) : Standard

● Terminal Code : LI (φ30, φ35)

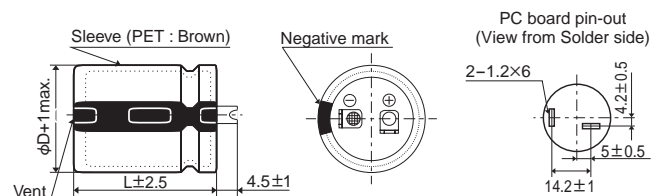
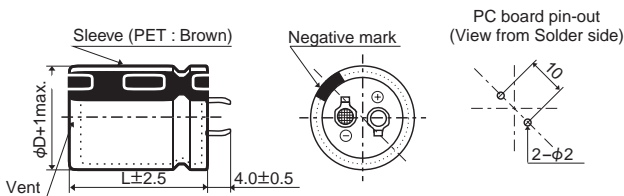

The standard design has no plastic disc.

◆ PART NUMBERING SYSTEM

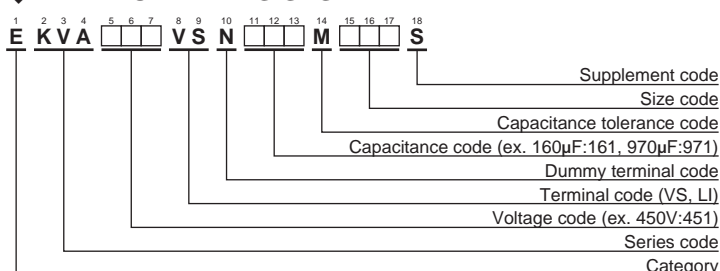

Please refer to "Product code guide (snap-in type)"

◆ STANDARD RATINGS

WV (V _{dc})	Cap (μF)	Case size φD×L(mm)	tan δ	Rated ripple current (Arms/105°C, 120Hz)	Part No.	WV (V _{dc})	Cap (μF)	Case size φD×L(mm)	tan δ	Rated ripple current (Arms/105°C, 120Hz)	Part No.
450	160	25.4 × 25	0.20	0.96	EKVA451VSN161MQ25S	450	450	25.4 × 55	0.20	1.87	EKVA451VSN451MQ55S
	210	25.4 × 30	0.20	1.13	EKVA451VSN211MQ30S		480	35 × 35	0.20	1.71	EKVA451VSN481MA35S
	230	30 × 25	0.20	1.18	EKVA451VSN231MR25S		490	25.4 × 60	0.20	2.00	EKVA451VSN491MQ60S
	250	25.4 × 35	0.20	1.29	EKVA451VSN251MQ35S		510	30 × 45	0.20	1.91	EKVA451VSN511MR45S
	290	35 × 25	0.20	1.29	EKVA451VSN291MA25S		580	30 × 50	0.20	2.08	EKVA451VSN581MR50S
	300	25.4 × 40	0.20	1.44	EKVA451VSN301MQ40S		580	35 × 40	0.20	1.95	EKVA451VSN581MA40S
	300	30 × 30	0.20	1.36	EKVA451VSN301MR30S		650	30 × 55	0.20	2.24	EKVA451VSN651MR55S
	350	25.4 × 45	0.20	1.58	EKVA451VSN351MQ45S		680	35 × 45	0.20	2.16	EKVA451VSN681MA45S
	370	30 × 35	0.20	1.55	EKVA451VSN371MR35S		730	30 × 60	0.20	2.42	EKVA451VSN731MR60S
	390	35 × 30	0.20	1.52	EKVA451VSN391MA30S		780	35 × 50	0.20	2.36	EKVA451VSN781MA50S
	400	25.4 × 50	0.20	1.72	EKVA451VSN401MQ50S		880	35 × 55	0.20	2.56	EKVA451VSN881MA55S
440	30 × 40	0.20	1.73	EKVA451VSN441MR40S	970	35 × 60	0.20	2.73	EKVA451VSN971MA60S		

◆ RATED RIPPLE CURRENT MULTIPLIERS

● Frequency Multipliers

Frequency(Hz)	50	120	300	1k	10k	50k
450V	0.77	1.00	1.16	1.30	1.41	1.43

The deterioration of aluminum electrolytic capacitors accelerates their life due to the internal heating produced by ripple current. For details, refer to Section "5-3 Ripple Current Effect on Lifetime" in the catalog, Technical Note.

GXA Series

- Endurance with ripple current : 3,000 hours at 125°C
- Rated voltage range : 400 & 450V_{dc}, Capacitance range : 220 to 820μF
- Suitable for the communication infrastructure power supply and other high temperature applications.
- Non solvent resistant type
- RoHS2 Compliant



SPECIFICATIONS

Items	Characteristics	
Category	-40 to +125°C	
Temperature Range		
Rated Voltage Range	400 & 450V _{dc}	
Capacitance Tolerance	±20% (M) (at 20°C, 120Hz)	
Leakage Current	I ≤ 3/CV Where, I : Max. leakage current (μA), C : Nominal capacitance (μF), V : Rated voltage (V) (at 20°C after 5 minutes)	
Dissipation Factor (tan δ)	Rated voltage (V _{dc})	400 & 450V
	tan δ (Max.)	0.20 (at 20°C, 120Hz)
Low Temperature Characteristics (Max. Impedance Ratio)	Rated voltage (V _{dc})	400 & 450V
	Z(-25°C)/Z(+20°C)	8 (at 120Hz)
Endurance	The following specifications shall be satisfied when the capacitors are restored to 20°C after subjected to DC voltage with the rated ripple current is applied (the peak voltage shall not exceed the rated voltage) for 3,000 hours at 125°C.	
	Capacitance change	≤ ±20% of the initial value
	D.F. (tan δ)	≤ 200% of the initial specified value
	Leakage current	≤ The initial specified value
Shelf Life	The following specifications shall be satisfied when the capacitors are restored to 20°C after exposing them for 1,000 hours at 125°C without voltage applied. Before the measurement, the capacitor shall be preconditioned by applying voltage according to Item 4.1 of JIS C 5101-4.	
	Capacitance change	≤ ±15% of the initial value
	D.F. (tan δ)	≤ 150% of the initial specified value
	Leakage current	≤ The initial specified value

DIMENSIONS [mm]

- Terminal Code : VS (φ30, φ35) : Standard

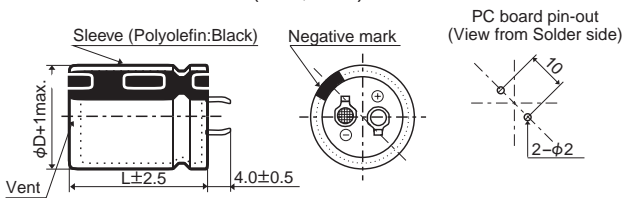

- Terminal Code : LI (φ35)

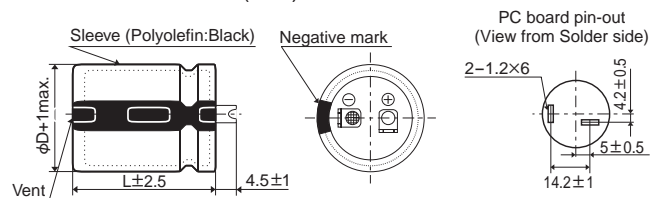

The standard design has no plastic disc.

PART NUMBERING SYSTEM

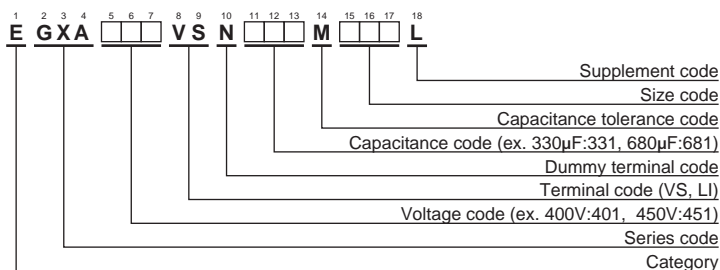

Please refer to "Product code guide (snap-in type)"



GXA Series

◆STANDARD RATINGS

WV (V _{dc})	Cap (μF)	Case size φD×L(mm)	tan δ	Rated ripple current (Arms/125°C, 120Hz)	Part No.	WV (V _{dc})	Cap (μF)	Case size φD×L(mm)	tan δ	Rated ripple current (Arms/125°C, 120Hz)	Part No.
400	270	30 × 30	0.20	1.24	EGXA401VSN271MR30L	450	220	30 × 30	0.20	1.12	EGXA451VSN221MR30L
	330	30 × 35	0.20	1.41	EGXA401VSN331MR35L		270	30 × 35	0.20	1.27	EGXA451VSN271MR35L
	330	35 × 30	0.20	1.48	EGXA401VSN331MA30L		270	30 × 40	0.20	1.31	EGXA451VSN271MR40L
	390	30 × 40	0.20	1.57	EGXA401VSN391MR40L		270	35 × 30	0.20	1.34	EGXA451VSN271MA30L
	390	30 × 45	0.20	1.61	EGXA401VSN391MR45L		330	30 × 45	0.20	1.48	EGXA451VSN331MR45L
	390	35 × 35	0.20	1.64	EGXA401VSN391MA35L		330	35 × 35	0.20	1.51	EGXA451VSN331MA35L
	470	30 × 50	0.20	1.80	EGXA401VSN471MR50L		390	30 × 50	0.20	1.64	EGXA451VSN391MR50L
	470	35 × 40	0.20	1.86	EGXA401VSN471MA40L		390	35 × 40	0.20	1.70	EGXA451VSN391MA40L
	560	30 × 55	0.20	2.01	EGXA401VSN561MR55L		470	30 × 55	0.20	1.84	EGXA451VSN471MR55L
	560	30 × 60	0.20	2.04	EGXA401VSN561MR60L		470	30 × 60	0.20	1.87	EGXA451VSN471MR60L
	560	35 × 45	0.20	2.08	EGXA401VSN561MA45L		470	35 × 45	0.20	1.91	EGXA451VSN471MA45L
	680	35 × 50	0.20	2.34	EGXA401VSN681MA50L		560	35 × 50	0.20	2.13	EGXA451VSN561MA50L
	680	35 × 55	0.20	2.39	EGXA401VSN681MA55L		560	35 × 55	0.20	2.17	EGXA451VSN561MA55L
820	35 × 60	0.20	2.67	EGXA401VSN821MA60L	680	35 × 60	0.20	2.43	EGXA451VSN681MA60L		

◆RATED RIPPLE CURRENT MULTIPLIERS

● Frequency Multipliers

Frequency(Hz)	50	120	300	1k	10k	50k
400 & 450V _{dc}	0.77	1.00	1.16	1.30	1.41	1.43

The deterioration of aluminum electrolytic capacitors accelerates their life due to the internal heating produced by ripple current. For details, refer to Section "5-3 Ripple Current Effect on Lifetime" in the catalog, Technical Note.



CHA Series

- Doesn't spark with DC over voltage
- Downsized from current KLG series
- Endurance with ripple current : 2,000 hours at 105°C
- Non solvent resistant type
- RoHS2 Compliant



SPECIFICATIONS

Items	Characteristics	
Category	-25 to +105°C	
Temperature Range	-25 to +105°C	
Rated Voltage Range	200 to 450V _{dc}	
Capacitance Tolerance	±20% (M) (at 20°C, 120Hz)	
Leakage Current	I ≤ 3√CV Where, I : Max. leakage current (μA), C : Nominal capacitance (μF), V : Rated voltage (V _{dc}) (at 20°C after 5 minutes)	
Dissipation Factor (tan δ)	200V _{dc} : 0.15 max. (0.20 max. for φD=35mm) 400V _{dc} : 0.15 max. (at 20°C, 120Hz)	
Low Temperature Characteristics (Max.Impedance Ratio)	Rated Voltage (V _{dc})	200 to 450V Z(-25°C) / Z(+20°C) : 4 (at 120Hz)
ESL	50nH max. (at 20°C, 1MHz)	
Endurance	The following specifications shall be satisfied when the capacitors are restored to 20°C after subjected to DC voltage with the rated ripple current is applied (the peak voltage shall not exceed the rated voltage) for 2,000 hours at 105°C.	
	Capacitance change	≤ ±20% of the initial value
	D.F. (tan δ)	≤ 200% of the initial specified value
	Leakage current	≤ The initial specified value
Shelf Life	The following specifications shall be satisfied when the capacitors are restored to 20°C after exposing them for 1,000 hours at 105°C without voltage applied. Before the measurement, the capacitor shall be preconditioned by applying voltage according to Item 4.1 of JIS C 5101-4.	
	Capacitance change	≤ ±15% of the initial value
	D.F. (tan δ)	≤ 150% of the initial specified value
	Leakage current	≤ The initial specified value

DIMENSIONS [mm]

- Terminal Code : VS (φ22 to φ35)

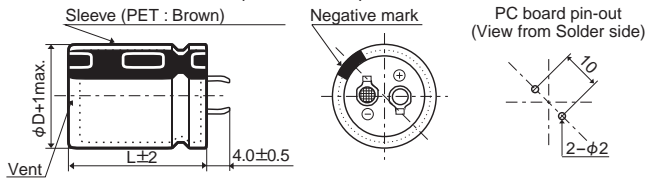

The standard design has no plastic disc.

PART NUMBERING SYSTEM

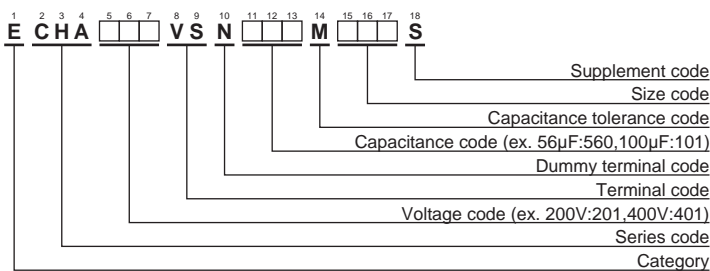

Please refer to "Product code guide (snap-in type)"

RATED RIPPLE CURRENT MULTIPLIERS

- Frequency Multipliers

Rated Voltage(V _{dc})	Frequency(Hz)					
	50	120	300	1k	10k	50k
200, 250	0.81	1.00	1.17	1.32	1.45	1.50
400, 450	0.77	1.00	1.16	1.30	1.41	1.43

The deterioration of aluminum electrolytic capacitors accelerates their life due to the internal heating produced by ripple current. For details, refer to Section "5-3 Ripple Current Effect on Lifetime" in the catalog, Technical Note.

◆STANDARD RATINGS

WV (V _{dc})	Cap (μF)	Case size φD×L(mm)	tan δ	Rated ripple current (Arms/105°C, 120Hz)	Part No.	WV (V _{dc})	Cap (μF)	Case size φD×L(mm)	tan δ	Rated ripple current (Arms/105°C, 120Hz)	Part No.	
200	180	22 × 20	0.15	0.82	ECHA201VSN181MP20S	250	680	35 × 30	0.20	2.19	ECHA251VSN681MA30S	
	220	22 × 20	0.15	0.90	ECHA201VSN221MP20S		820	30 × 45	0.15	2.39	ECHA251VSN821MR45S	
	270	22 × 25	0.15	1.02	ECHA201VSN271MP25S		820	35 × 35	0.20	2.42	ECHA251VSN821MA35S	
	330	22 × 30	0.15	1.20	ECHA201VSN331MP30S		400	56	22 × 20	0.15	0.45	ECHA401VSN560MP20S
	330	25.4 × 25	0.15	1.20	ECHA201VSN331MQ25S			68	22 × 20	0.15	0.51	ECHA401VSN680MP20S
	390	22 × 30	0.15	1.35	ECHA201VSN391MP30S			82	22 × 25	0.15	0.58	ECHA401VSN820MP25S
	390	25.4 × 25	0.15	1.35	ECHA201VSN391MQ25S			100	22 × 25	0.15	0.66	ECHA401VSN101MP35S
	470	22 × 35	0.15	1.45	ECHA201VSN471MP35S			100	25.4 × 25	0.15	0.66	ECHA401VSN101MQ25S
	470	25.4 × 30	0.15	1.45	ECHA201VSN471MQ30S			120	22 × 30	0.15	0.76	ECHA401VSN121MP30S
	470	30 × 25	0.15	1.47	ECHA201VSN471MR25S			120	25.4 × 25	0.15	0.76	ECHA401VSN121MQ25S
	560	22 × 40	0.15	1.62	ECHA201VSN561MP40S			150	22 × 35	0.15	0.85	ECHA401VSN151MP35S
	560	25.4 × 30	0.15	1.60	ECHA201VSN561MQ30S			150	25.4 × 30	0.15	0.85	ECHA401VSN151MQ30S
	560	30 × 25	0.15	1.60	ECHA201VSN561MR25S			150	30 × 25	0.15	0.85	ECHA401VSN151MR25S
	680	25.4 × 35	0.15	1.82	ECHA201VSN681MQ35S			180	22 × 40	0.15	0.94	ECHA401VSN181MP40S
	680	30 × 30	0.15	1.81	ECHA201VSN681MR30S			180	25.4 × 35	0.15	0.95	ECHA401VSN181MQ35S
	680	35 × 25	0.20	1.86	ECHA201VSN681MA25S			180	30 × 25	0.15	0.95	ECHA401VSN181MR25S
	820	25.4 × 45	0.15	2.11	ECHA201VSN821MQ45S			220	25.4 × 35	0.15	1.24	ECHA401VSN221MQ35S
	820	30 × 35	0.15	2.11	ECHA201VSN821MR35S			220	30 × 30	0.15	1.24	ECHA401VSN221MR30S
	820	35 × 25	0.20	2.11	ECHA201VSN821MA25S			220	35 × 25	0.15	1.24	ECHA401VSN221MA25S
	1,000	30 × 35	0.15	2.40	ECHA201VSN102MR35S			270	25.4 × 45	0.15	1.30	ECHA401VSN271MQ45S
1,000	35 × 30	0.20	2.40	ECHA201VSN102MA30S	270	30 × 35		0.15	1.30	ECHA401VSN271MR35S		
1,200	30 × 45	0.15	2.69	ECHA201VSN122MR45S	270	35 × 25		0.15	1.30	ECHA401VSN271MA25S		
1,200	35 × 35	0.20	2.65	ECHA201VSN122MA35S	330	30 × 35		0.15	1.45	ECHA401VSN331MR35S		
1,500	35 × 45	0.20	2.96	ECHA201VSN152MA45S	330	30 × 40	0.15	1.47	ECHA401VSN331MR40S			
250	120	22 × 20	0.15	0.68	ECHA251VSN121MP20S	330	35 × 30	0.15	1.47	ECHA401VSN331MA30S		
	180	22 × 25	0.15	0.87	ECHA251VSN181MP25S	390	30 × 40	0.15	1.60	ECHA401VSN391MR40S		
	180	25.4 × 20	0.15	0.93	ECHA251VSN181MQ20S	390	35 × 35	0.15	1.61	ECHA401VSN391MA35S		
	220	22 × 30	0.15	1.00	ECHA251VSN221MP30S	470	35 × 40	0.15	1.84	ECHA401VSN471MA40S		
	270	22 × 35	0.15	1.14	ECHA251VSN271MP35S	450	82	25.4 × 25	0.20	0.61	ECHA451VSN820MQ25S	
	270	25.4 × 25	0.15	1.13	ECHA251VSN271MQ25S		120	25.4 × 30	0.20	0.76	ECHA451VSN121MQ30S	
	270	30 × 20	0.15	1.25	ECHA251VSN271MR20S		120	30 × 25	0.20	0.77	ECHA451VSN121MR25S	
	330	22 × 40	0.15	1.28	ECHA251VSN331MP40S		150	25.4 × 35	0.20	0.88	ECHA451VSN151MQ35S	
	330	25.4 × 30	0.15	1.29	ECHA251VSN331MQ30S		180	25.4 × 40	0.20	0.99	ECHA451VSN181MQ40S	
	390	22 × 45	0.15	1.42	ECHA251VSN391MP45S		180	30 × 30	0.20	0.97	ECHA451VSN181MR30S	
	390	25.4 × 35	0.15	1.46	ECHA251VSN391MQ35S		180	30 × 35	0.20	1.00	ECHA451VSN181MR35S	
	390	30 × 25	0.15	1.52	ECHA251VSN391MR25S		220	30 × 35	0.20	1.30	ECHA451VSN221MR35S	
	390	35 × 20	0.20	1.62	ECHA251VSN391MA20S		220	35 × 25	0.20	1.20	ECHA451VSN221MA25S	
	470	25.4 × 40	0.15	1.64	ECHA251VSN471MQ40S		270	30 × 35	0.20	1.22	ECHA451VSN271MR35S	
	470	30 × 30	0.15	1.67	ECHA251VSN471MR30S		270	30 × 40	0.20	1.28	ECHA451VSN271MR40S	
	560	25.4 × 45	0.15	1.82	ECHA251VSN561MQ45S		270	35 × 30	0.20	1.30	ECHA451VSN271MA30S	
	560	30 × 35	0.15	1.87	ECHA251VSN561MR35S		330	35 × 35	0.20	1.40	ECHA451VSN331MA35S	
	560	35 × 25	0.20	1.99	ECHA251VSN561MA25S		390	35 × 40	0.20	1.60	ECHA451VSN391MA40S	
	680	30 × 40	0.15	2.12	ECHA251VSN681MR40S		420	35 × 50	0.20	1.56	ECHA451VSN421MA50S	

◆DC OVERVOLTAGE TEST CONDITIONS

The vent will operate and the capacitor shall become an open circuit without burning materials when the following test DC voltage is applied.

●Test DC voltage

Rated Voltage	Nominal Capacitance	Current Limit	Test Voltage
200V _{dc}	<330μF	4A	300/375V _{dc}
	330μF ≤ C < 470μF	5A	
	≥ 470μF	7A	
250V _{dc}	<330μF	4A	350/450V _{dc}
	330μF ≤ C < 470μF	5A	
	≥ 470μF	7A	
400V _{dc}	<100μF	2A	500/600V _{dc}
	100μF ≤ C < 220μF	4A	
	≥ 220μF	7A	
450V _{dc}	<100μF	2A	550/675V _{dc}
	100μF ≤ C < 220μF	4A	
	≥ 220μF	7A	

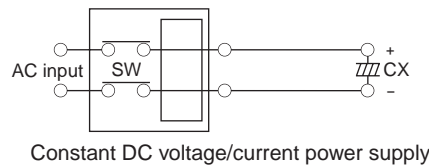
●Test Circuit

KMV Series



- For frequently change of regenerative voltage from AC servo amplifier and inverter control
- Ideal use to power supply, specially power source with turn on and off frequently and highly voltage fluctuation
- Improved the resistance for charge and discharge from same dimension of KMQ series
- Endurance with ripple current : 3,000 hours at 105°C
- Rated voltage range : 350 to 450V_{dc}, Capacitance 82 to 1,200µF
- Non solvent resistant type
- RoHS2 Compliant

◆ SPECIFICATIONS

Items	Characteristics		
Category	-25 to +105°C		
Temperature Range	-25 to +105°C		
Rated Voltage Range	350 to 450V _{dc}		
Capacitance Tolerance	±20% (M) (at 20°C, 120Hz)		
Leakage Current	$I \leq 3\sqrt{CV}$ Where, I : Max. leakage current (µA), C : Nominal capacitance (µF), V : Rated voltage (V) (at 20°C after 5 minutes)		
Dissipation Factor (tan δ)	Rated voltage (V _{dc})	350 & 400V	420 & 450V
	tan δ (Max.)	0.15	0.20
Low Temperature Characteristics (Max. Impedance Ratio)	Rated voltage (V _{dc})	350 to 450V	
	Z(-25°C)/Z(+20°C)	8	
Charge and Discharge	The following specifications shall be satisfied when the capacitors are restored to 20°C after subjected to charge and discharge test with the voltage waveform shown below at room temperature (15 to 35°C).		
	Capacitance change	≤ ±20% of the initial value	
	D.F. (tan δ)	≤200% of the initial specified value	
	Leakage current	≤The initial specified value	
	Frequency	6Hz	
	Number of cycles	50 million times	
	Voltage waveform		
Endurance	The following specifications shall be satisfied when the capacitors are restored to 20°C after subjected to DC voltage with the rated ripple current is applied (the peak voltage shall not exceed the rated voltage) for 3,000 hours at 105°C.		
	Capacitance change	≤ ±20% of the initial value	
	D.F. (tan δ)	≤200% of the initial specified value	
	Leakage current	≤The initial specified value	
Shelf Life	The following specifications shall be satisfied when the capacitors are restored to 20°C after exposing them for 1,000 hours at 105°C without voltage applied. Before the measurement, the capacitor shall be preconditioned by applying voltage according to Item 4.1 of JIS C 5101-4.		
	Capacitance change	≤ ±15% of the initial value	
	D.F. (tan δ)	≤150% of the initial specified value	
	Leakage current	≤The initial specified value	

*Please consult with us about charge and discharge conditions.

◆ DIMENSIONS [mm]

● Terminal Code : VS (φ22 to φ35) : Standard

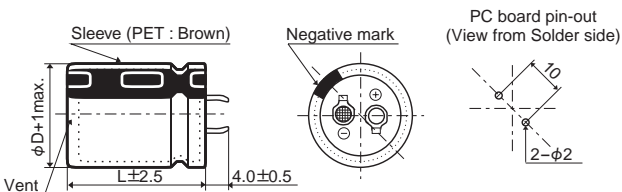

● Terminal Code : LI (φ35)

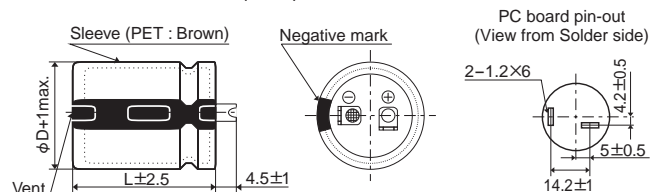

No plastic disk is the standard design.

KMV Series

◆PART NUMBERING SYSTEM

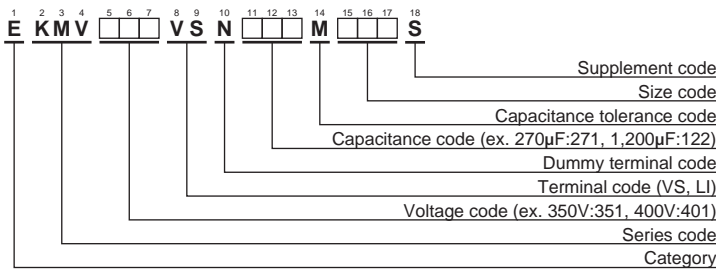

Please refer to "Product code guide (snap-in type)"

◆STANDARD RATINGS

WV (V _{dc})	Cap (μF)	Case size φD×L(mm)	Rated ripple current (Arms/105°C, 120Hz)	Effective value of charge and discharge current (Arms/6Hz)	Part No.	WV (V _{dc})	Cap (μF)	Case size φD×L(mm)	Rated ripple current (Arms/105°C, 120Hz)	Effective value of charge and discharge current (Arms/6Hz)	Part No.
350	120	22 × 25	0.74	0.42	EKMV351VSN121MP25S	420	82	22 × 25	0.64	0.34	EKMV421VSN820MP25S
	150	22 × 30	0.87	0.49	EKMV351VSN151MP30S		120	22 × 30	0.81	0.44	EKMV421VSN121MP30S
	180	25.4 × 25	0.92	0.54	EKMV351VSN181MQ25S		120	25.4 × 25	0.81	0.44	EKMV421VSN121MQ25S
	220	22 × 35	1.08	0.60	EKMV351VSN221MP35S		150	22 × 35	0.93	0.50	EKMV421VSN151MP35S
	220	22 × 40	1.10	0.62	EKMV351VSN221MP40S		150	25.4 × 30	0.93	0.50	EKMV421VSN151MQ30S
	220	25.4 × 30	1.05	0.61	EKMV351VSN221MQ30S		180	22 × 40	1.04	0.56	EKMV421VSN181MP40S
	270	22 × 45	1.24	0.71	EKMV351VSN271MP45S		180	22 × 45	1.06	0.58	EKMV421VSN181MP45S
	270	25.4 × 35	1.21	0.70	EKMV351VSN271MQ35S		180	25.4 × 35	1.06	0.58	EKMV421VSN181MQ35S
	270	30 × 25	1.15	0.68	EKMV351VSN271MR25S		180	30 × 25	1.02	0.56	EKMV421VSN181MR25S
	330	22 × 50	1.41	0.80	EKMV351VSN331MP50S		220	22 × 50	1.20	0.66	EKMV421VSN221MP50S
	330	25.4 × 40	1.37	0.80	EKMV351VSN331MQ40S		220	25.4 × 40	1.20	0.65	EKMV421VSN221MQ40S
	330	30 × 30	1.29	0.77	EKMV351VSN331MR30S		220	30 × 30	1.14	0.63	EKMV421VSN221MR30S
	330	35 × 25	1.31	0.78	EKMV351VSN331MA25S		270	25.4 × 45	1.36	0.74	EKMV421VSN271MQ45S
	390	25.4 × 45	1.51	0.89	EKMV351VSN391MQ45S		270	30 × 35	1.29	0.73	EKMV421VSN271MR35S
	390	30 × 35	1.44	0.88	EKMV351VSN391MR35S		270	35 × 25	1.26	0.71	EKMV421VSN271MA25S
	470	25.4 × 50	1.69	0.99	EKMV351VSN471MQ50S		330	25.4 × 50	1.52	0.83	EKMV421VSN331MQ50S
	470	30 × 40	1.62	1.00	EKMV351VSN471MR40S		330	30 × 40	1.47	0.84	EKMV421VSN331MR40S
	470	35 × 30	1.61	0.97	EKMV351VSN471MA30S		330	35 × 30	1.42	0.82	EKMV421VSN331MA30S
	560	30 × 45	1.82	1.12	EKMV351VSN561MR45S		390	30 × 45	1.64	0.94	EKMV421VSN391MR45S
	560	35 × 35	1.77	1.08	EKMV351VSN561MA35S		390	35 × 35	1.56	0.91	EKMV421VSN391MA35S
680	30 × 50	2.04	1.27	EKMV351VSN681MR50S	470	30 × 50	1.83	1.06	EKMV421VSN471MR50S		
680	35 × 40	2.02	1.25	EKMV351VSN681MA40S	470	35 × 40	1.78	1.05	EKMV421VSN471MA40S		
820	35 × 45	2.27	1.41	EKMV351VSN821MA45S	560	35 × 45	1.98	1.18	EKMV421VSN561MA45S		
820	35 × 50	2.32	1.46	EKMV351VSN821MA50S	680	35 × 50	2.23	1.34	EKMV421VSN681MA50S		
1,200	35 × 60	2.88	1.84	EKMV351VSN122MA60S	820	35 × 60	2.52	1.55	EKMV421VSN821MA60S		
400	100	22 × 25	0.69	0.38	EKMV401VSN101MP25S	450	82	22 × 25	0.64	0.34	EKMV451VSN820MP25S
	120	22 × 30	0.79	0.44	EKMV401VSN121MP30S		100	22 × 30	0.72	0.40	EKMV451VSN101MP30S
	150	25.4 × 25	0.87	0.49	EKMV401VSN151MQ25S		100	25.4 × 25	0.72	0.40	EKMV451VSN101MQ25S
	180	22 × 35	0.99	0.55	EKMV401VSN181MP35S		120	22 × 35	0.81	0.45	EKMV451VSN121MP35S
	180	22 × 40	1.01	0.56	EKMV401VSN181MP40S		150	22 × 40	0.93	0.51	EKMV451VSN151MP40S
	180	25.4 × 30	0.98	0.55	EKMV401VSN181MQ30S		150	25.4 × 30	0.91	0.50	EKMV451VSN151MQ30S
	220	22 × 45	1.14	0.64	EKMV401VSN221MP45S		150	30 × 25	0.90	0.51	EKMV451VSN151MR25S
	220	25.4 × 35	1.13	0.63	EKMV401VSN221MQ35S		180	22 × 45	1.03	0.58	EKMV451VSN181MP45S
	220	30 × 25	1.10	0.61	EKMV401VSN221MR25S		180	22 × 50	1.06	0.59	EKMV451VSN181MP50S
	270	22 × 50	1.30	0.73	EKMV401VSN271MP50S		180	25.4 × 35	1.04	0.57	EKMV451VSN181MQ35S
	270	25.4 × 40	1.28	0.72	EKMV401VSN271MQ40S		220	25.4 × 40	1.18	0.65	EKMV451VSN221MQ40S
	270	30 × 30	1.22	0.70	EKMV401VSN271MR30S		220	25.4 × 45	1.20	0.67	EKMV451VSN221MQ45S
	270	35 × 25	1.26	0.71	EKMV401VSN271MA25S		220	30 × 30	1.10	0.63	EKMV451VSN221MR30S
	330	25.4 × 45	1.44	0.82	EKMV401VSN331MQ45S		220	35 × 25	1.12	0.64	EKMV451VSN221MA25S
	330	30 × 35	1.38	0.81	EKMV401VSN331MR35S		270	25.4 × 50	1.35	0.75	EKMV451VSN271MQ50S
	390	25.4 × 50	1.59	0.91	EKMV401VSN391MQ50S		270	30 × 35	1.25	0.73	EKMV451VSN271MR35S
	390	30 × 40	1.55	0.91	EKMV401VSN391MR40S		270	35 × 30	1.27	0.74	EKMV451VSN271MA30S
	390	35 × 30	1.55	0.89	EKMV401VSN391MA30S		330	30 × 40	1.42	0.84	EKMV451VSN331MR40S
	470	30 × 45	1.74	1.03	EKMV401VSN471MR45S		330	30 × 45	1.46	0.87	EKMV451VSN331MR45S
	470	35 × 35	1.71	1.00	EKMV401VSN471MA35S		330	35 × 35	1.41	0.84	EKMV451VSN331MA35S
560	30 × 50	1.93	1.15	EKMV401VSN561MR50S	390	30 × 50	1.61	0.97	EKMV451VSN391MR50S		
560	35 × 40	1.94	1.14	EKMV401VSN561MA40S	390	35 × 40	1.59	0.96	EKMV451VSN391MA40S		
680	35 × 45	2.19	1.29	EKMV401VSN681MA45S	470	35 × 45	1.79	1.08	EKMV451VSN471MA45S		
820	35 × 50	2.45	1.44	EKMV401VSN821MA50S	560	35 × 50	2.00	1.22	EKMV451VSN561MA50S		
1,000	35 × 60	2.79	1.70	EKMV401VSN102MA60S	680	35 × 60	2.26	1.42	EKMV451VSN681MA60S		



KMV Series

◆ RATED RIPPLE CURRENT MULTIPLIERS

● Frequency Multipliers

Frequency(Hz)	50	120	300	1k	10k	50k
Coefficient	0.77	1.00	1.16	1.30	1.41	1.43

The deterioration of aluminum electrolytic capacitors accelerates their life due to the internal heating produced by ripple current. For details, refer to Section "5-3 Ripple Current Effect on Lifetime" in the catalog, Technical Note.

CHEMI-CON PART NUMBERING SYSTEM

Product code guide (Screw mount terminal type)

(Example : KMH series, 400V-3,300 μ F, ϕ 63.5 \times 120L, Without mounting clamp)



Please refer to the following table

Contents	Code	Series	Code	Type	Code	Tol.(%)	Code	Sleeve Material	Plastic disk	Code
Polar	E	KMH	KMH	Screw terminal	LG	± 20	M	PVC	Provided	U

1	2	3	4	5	6	7	8	9	10	11	12	13	14	15	16	17	18
E	K	M	H	4	0	1	L	G	N	3	3	2	M	D	C	0	U
Category	Series code			Voltage code			Terminal code	Mounting clamp code	Capacitance code			Capacitance tolerance	Size code		Supplement code		

Voltage(V)	Code
10	100
25	250
100	101
250	251
315	3B1
525	5C1
⋮	⋮

Type	Code
	B
	C
Without clamp	N

Cap.(μ F)	Code
100	101
470	471
1,000	102
4,700	472
10,000	103
47,000	473
100,000	104
⋮	⋮

ϕ D(mm)	Code
35	A
50	C
63.5	D
76.2	E
89	F
100	G

L(mm)	Code
50	50
55	55
60	60
65	65
75	75
80	80
85	85
90	90
95	95
96	96
100	A0
105	A5
110	B0
115	B5
120	C0
125	C5
130	D0
140	E0
145	E5
155	F5
170	H0
190	K0
210	M0
220	N0
250	R0
270	T0

*Refer to the appendix (Part number) for codes not listed here.



SME Series

- Endurance with ripple current : 2,000 hours at 85°C
- RoHS2 Compliant



◆ SPECIFICATIONS

Items	Characteristics						
Category	-40 to +85°C (10 to 100V _{dc})						
Temperature Range	-40 to +85°C (10 to 100V _{dc})						
Rated Voltage Range	10 to 100V _{dc}						
Capacitance Tolerance	±20% (M) (at 20°C, 120Hz)						
Leakage Current	I=0.02CV or 5mA, whichever is smaller. Where, I : Max. leakage current (μA), C : Nominal capacitance (μF), V : Rated voltage (V) (at 20°C after 5 minutes)						
Dissipation Factor (tan δ)	Shall not exceed the values shown in the STANDARD RATINGS (at 20°C, 120Hz)						
Low Temperature Characteristics	Capacitance change C(-25°C)/C(+20°C)≥0.7 (at 120Hz)						
Insulation Resistance	When measured between the terminals that are connected to each other and to the mounting clamp on the insulating sleeve covering the case by using an insulation resistance meter of 500V _{dc} , the insulation resistance shall not be less than 100MΩ.						
Insulation Withstanding Voltage	When a voltage of 2,000V _{ac} is applied for 1 minute between the terminals that are connected to each other and to the mounting clamp on the insulating sleeve covering the case, there shall not be electrical damage.						
Endurance	The following specifications shall be satisfied when the capacitors are restored to 20°C after subjected to DC voltage with the rated ripple current is applied (the peak voltage shall not exceed the rated voltage) for 2,000 hours at 85°C. <table border="1"> <tr> <td>Capacitance change</td> <td>≤ ±20% of the initial value</td> </tr> <tr> <td>D.F. (tan δ)</td> <td>≤ 200% of the initial specified value</td> </tr> <tr> <td>Leakage current</td> <td>≤ The initial specified value</td> </tr> </table>	Capacitance change	≤ ±20% of the initial value	D.F. (tan δ)	≤ 200% of the initial specified value	Leakage current	≤ The initial specified value
Capacitance change	≤ ±20% of the initial value						
D.F. (tan δ)	≤ 200% of the initial specified value						
Leakage current	≤ The initial specified value						
Shelf Life	The following specifications shall be satisfied when the capacitors are restored to 20°C after exposing them for 500 hours at 85°C without voltage applied. Before the measurement, the capacitor shall be preconditioned by applying voltage according to Item 4.1 of JIS C 5101-4. <table border="1"> <tr> <td>Capacitance change</td> <td>≤ ±20% of the initial value</td> </tr> <tr> <td>D.F. (tan δ)</td> <td>≤ 150% of the initial specified value</td> </tr> <tr> <td>Leakage current</td> <td>≤ The initial specified value</td> </tr> </table>	Capacitance change	≤ ±20% of the initial value	D.F. (tan δ)	≤ 150% of the initial specified value	Leakage current	≤ The initial specified value
Capacitance change	≤ ±20% of the initial value						
D.F. (tan δ)	≤ 150% of the initial specified value						
Leakage current	≤ The initial specified value						

◆ DIMENSIONS (Screw-Mount) [mm]

● Terminal Code : LG

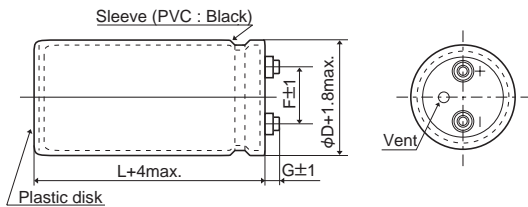

φ35 to φ63.5 : G=6
 φ76.2 & φ89 : G=5

<Screw specifications>

Plus hexagon-headed screw :M5×0.8×10
 Maximum screw tightening torque :3.23Nm

* The screw and the mounting clamp are separately supplied and not attached to the product.

● Mounting Clamp Code : B

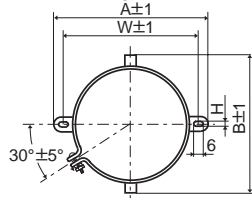

φD	A	B	W	H	F
35	58.0	44.0	48.0	3.5	12.7
50	78.0	64.0	68.0	4.5	22.4
63.5	90.0	76.0	80.0	4.5	28.0
76.2	104.5	90.0	93.5	4.5	31.5

● Mounting Clamp Code : C

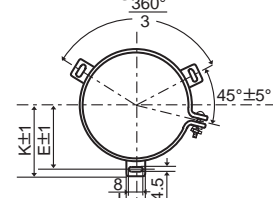

φD	E	K	J	F
50	32.5	37.0	14.0	22.4
63.5	38.1	43.5	14.0	28.0
76.2	44.5	50.0	14.0	31.5
89	50.8	56.5	16.0	31.5

◆ PART NUMBERING SYSTEM

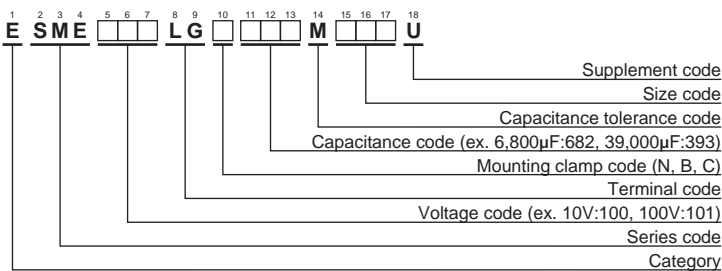

Please refer to "Product code guide (screw-mount terminal type)"



SME Series

◆ STANDARD RATINGS

WV (V _{dc})	Cap (μF)	Case size φD×L(mm)	tan δ	Rated ripple current (Arms/85°C, 120Hz)	Part No.	WV (V _{dc})	Cap (μF)	Case size φD×L(mm)	tan δ	Rated ripple current (Arms/85°C, 120Hz)	Part No.
10	39,000	35 × 50	0.60	4.70	ESME100LGB393MA50U	50	10,000	35 × 50	0.25	4.10	ESME500LGB103MA50U
	82,000	35 × 80	0.60	7.40	ESME100LGB823MA80U		18,000	35 × 80	0.25	5.20	ESME500LGB183MA80U
	100,000	35 × 100	0.70	8.00	ESME100LGB104MAA0U		22,000	35 × 100	0.30	5.90	ESME500LGB223MAA0U
	120,000	35 × 120	0.70	9.40	ESME100LGB124MAC0U		27,000	35 × 120	0.35	6.60	ESME500LGB273MAC0U
	150,000	50 × 80	0.90	9.80	ESME100LGC154MC80U		39,000	50 × 80	0.40	7.40	ESME500LGC393MC80U
	220,000	50 × 100	1.00	12.1	ESME100LGC224MCA0U		56,000	50 × 100	0.40	9.80	ESME500LGC563MCA0U
	270,000	50 × 120	1.20	13.6	ESME100LGC274MCC0U		68,000	50 × 120	0.45	11.1	ESME500LGC683MCC0U
	390,000	63.5 × 100	1.50	15.3	ESME100LGC394MDA0U		82,000	63.5 × 100	0.50	12.2	ESME500LGC823MDA0U
	470,000	63.5 × 120	2.00	16.0	ESME100LGC474MDC0U		120,000	63.5 × 120	0.50	16.0	ESME500LGC124MDC0U
	560,000	76.2 × 100	2.50	17.3	ESME100LGC564MEA0U		150,000	76.2 × 120	0.60	18.1	ESME500LGC154MEC0U
680,000	76.2 × 120	3.00	18.7	ESME100LGC684MEC0U	180,000	76.2 × 140	0.70	19.5	ESME500LGC184MEE0U		
16	27,000	35 × 50	0.45	4.20	ESME160LGB273MA50U	270,000	89 × 140	0.80	24.6	ESME500LGC274MFE0U	
	56,000	35 × 80	0.60	6.50	ESME160LGB563MA80U	63	5,600	35 × 50	0.20	3.00	ESME630LGB562MA50U
	82,000	35 × 100	0.70	8.00	ESME160LGB823MAA0U		10,000	35 × 80	0.25	4.00	ESME630LGB103MA80U
	100,000	35 × 120	0.70	9.60	ESME160LGB104MAC0U		15,000	35 × 100	0.25	5.30	ESME630LGB153MAA0U
	120,000	50 × 80	0.80	9.60	ESME160LGC124MC80U		18,000	35 × 120	0.25	6.20	ESME630LGB183MAC0U
	150,000	50 × 100	0.90	11.2	ESME160LGC154MCA0U		22,000	50 × 80	0.30	6.50	ESME630LGC223MC80U
	220,000	50 × 120	1.00	14.2	ESME160LGC224MCC0U		33,000	50 × 100	0.35	8.10	ESME630LGC333MCA0U
	270,000	63.5 × 100	1.20	15.3	ESME160LGC274MDA0U		39,000	50 × 120	0.35	9.60	ESME630LGC393MCC0U
	330,000	63.5 × 120	1.30	17.1	ESME160LGC334MDC0U		47,000	63.5 × 100	0.40	10.2	ESME630LGC473MDA0U
	390,000	76.2 × 100	1.60	18.0	ESME160LGC394MEA0U		68,000	63.5 × 120	0.40	13.3	ESME630LGC683MDC0U
470,000	76.2 × 120	1.80	19.3	ESME160LGC474MEC0U	100,000		76.2 × 120	0.45	17.1	ESME630LGC104MEC0U	
560,000	76.2 × 140	2.00	20.7	ESME160LGC564MEE0U	120,000	76.2 × 140	0.50	19.0	ESME630LGC124MEE0U		
25	18,000	35 × 50	0.35	4.00	ESME250LGB183MA50U	150,000	89 × 140	0.55	22.0	ESME630LGC154MFE0U	
	39,000	35 × 80	0.40	6.20	ESME250LGB393MA80U	80	3,300	35 × 50	0.15	2.50	ESME800LGB332MA50U
	47,000	35 × 100	0.40	7.40	ESME250LGB473MAA0U		6,800	35 × 80	0.20	3.70	ESME800LGB682MA80U
	56,000	35 × 120	0.45	8.30	ESME250LGB563MAC0U		10,000	35 × 100	0.20	4.90	ESME800LGB103MAA0U
	82,000	50 × 80	0.50	9.70	ESME250LGC823MC80U		12,000	35 × 120	0.20	5.40	ESME800LGB123MAC0U
	100,000	50 × 100	0.60	10.8	ESME250LGC104MCA0U		15,000	50 × 80	0.25	6.00	ESME800LGC153MC80U
	120,000	50 × 120	0.60	12.8	ESME250LGC124MCC0U		22,000	50 × 100	0.30	7.10	ESME800LGC223MCA0U
	180,000	63.5 × 100	0.75	14.7	ESME250LGC184MDA0U		27,000	50 × 120	0.30	8.60	ESME800LGC273MCC0U
	220,000	63.5 × 120	0.80	16.8	ESME250LGC224MDC0U		33,000	63.5 × 100	0.35	9.30	ESME800LGC333MDA0U
	270,000	76.2 × 100	0.90	18.3	ESME250LGC274MEA0U		47,000	63.5 × 120	0.35	12.0	ESME800LGC473MDC0U
330,000	76.2 × 120	1.00	20.7	ESME250LGC334MEC0U	68,000		76.2 × 120	0.35	15.4	ESME800LGC683MEC0U	
390,000	76.2 × 140	1.20	22.1	ESME250LGC394MEE0U	82,000	76.2 × 140	0.35	18.1	ESME800LGC823MEE0U		
560,000	89 × 140	1.50	25.8	ESME250LGC564MFE0U	100,000	89 × 140	0.40	21.0	ESME800LGC104MFE0U		
35	15,000	35 × 50	0.30	3.90	ESME350LGB153MA50U	100	2,200	35 × 50	0.10	2.50	ESME101LGB222MA50U
	33,000	35 × 80	0.40	6.00	ESME350LGB333MA80U		4,700	35 × 80	0.15	3.40	ESME101LGB472MA80U
	39,000	35 × 100	0.40	7.00	ESME350LGB393MAA0U		6,800	35 × 100	0.15	4.20	ESME101LGB682MAA0U
	47,000	35 × 120	0.45	8.00	ESME350LGB473MAC0U		8,200	35 × 120	0.15	5.00	ESME101LGB822MAC0U
	68,000	50 × 80	0.50	9.00	ESME350LGC683MC80U		10,000	50 × 80	0.20	5.20	ESME101LGC103MC80U
	82,000	50 × 100	0.55	10.3	ESME350LGC823MCA0U		18,000	50 × 120	0.20	8.10	ESME101LGC183MCC0U
	120,000	50 × 120	0.60	12.8	ESME350LGC124MCC0U		22,000	63.5 × 100	0.25	8.60	ESME101LGC223MDA0U
	150,000	63.5 × 100	0.70	14.0	ESME350LGC154MDA0U		27,000	63.5 × 120	0.25	10.3	ESME101LGC273MDC0U
	180,000	63.5 × 120	0.70	16.6	ESME350LGC184MDC0U		33,000	76.2 × 100	0.25	11.1	ESME101LGC333MEA0U
	220,000	76.2 × 100	0.75	17.3	ESME350LGC224MEA0U		39,000	76.2 × 120	0.25	12.4	ESME101LGC393MEC0U
270,000	76.2 × 120	0.80	19.8	ESME350LGC274MEC0U	47,000	76.2 × 140	0.25	14.3	ESME101LGC473MEE0U		
330,000	76.2 × 140	0.90	22.5	ESME350LGC334MEE0U	68,000	89 × 140	0.30	18.0	ESME101LGC683MFE0U		
470,000	89 × 140	1.00	28.3	ESME350LGC474MFE0U							

◆ RATED RIPPLE CURRENT MULTIPLIERS

● Frequency Multipliers

Rated voltage (V _{dc})	Case diameter (mm)	Frequency (Hz)					
		50	120	300	1k	10k	50k
10 to 50	φ35 to φ89	0.95	1.00	1.03	1.05	1.09	1.12
63 & 80	φ35	0.90	1.00	1.06	1.10	1.18	1.22
	φ50 to φ89	0.95	1.00	1.03	1.05	1.09	1.12
100	φ35	0.82	1.00	1.12	1.22	1.30	1.33
	φ50	0.90	1.00	1.06	1.10	1.18	1.22
	φ63.5 to φ89	0.95	1.00	1.03	1.05	1.09	1.12

The deterioration of aluminum electrolytic capacitors accelerates their life due to the internal heating produced by ripple current. For details, refer to Section "5-3 Ripple Current Effect on Lifetime" in the catalog, Technical Note.

KMQ Series

- Endurance with ripple current : 2,000 hours at 105°C
- Downsized and high ripple current from KMH series
- RoHS2 Compliant

KMQ

↑
Downsized
Higher ripple
KMH



SPECIFICATIONS

Items	Characteristics						
Category	-25 to +105°C						
Temperature Range							
Rated Voltage Range	315 to 450V _{dc}						
Capacitance Tolerance	±20% (M) (at 20°C, 120Hz)						
Leakage Current	I=0.02CV or 5mA, whichever is smaller. Where, I : Max. leakage current (μA), C : Nominal capacitance (μF), V : Rated voltage (V) (at 20°C after 5 minutes)						
Dissipation Factor (tan δ)	Shall not exceed the values shown in the STANDARD RATINGS (at 20°C, 120Hz)						
Low Temperature Characteristics	Capacitance change $C(-25^{\circ}\text{C})/C(+20^{\circ}\text{C}) \geq 0.7$ (at 120Hz)						
Insulation Resistance	When measured between the terminals that are connected to each other and to the mounting clamp on the insulating sleeve covering the case by using an insulation resistance meter of 500V _{dc} , the insulation resistance shall not be less than 100MΩ.						
Insulation Withstanding Voltage	When a voltage of 2,000V _{ac} is applied for 1 minute between the terminals that are connected to each other and to the mounting clamp on the insulating sleeve covering the case, there shall not be electrical damage.						
Endurance	The following specifications shall be satisfied when the capacitors are restored to 20°C after subjected to DC voltage with the rated ripple current is applied (the peak voltage shall not exceed the rated voltage) for 2,000 hours at 105°C. <table border="1"> <tr> <td>Capacitance change</td> <td>≤ ±20% of the initial value</td> </tr> <tr> <td>D.F. (tan δ)</td> <td>≤ 200% of the initial specified value</td> </tr> <tr> <td>Leakage current</td> <td>≤ The initial specified value</td> </tr> </table>	Capacitance change	≤ ±20% of the initial value	D.F. (tan δ)	≤ 200% of the initial specified value	Leakage current	≤ The initial specified value
Capacitance change	≤ ±20% of the initial value						
D.F. (tan δ)	≤ 200% of the initial specified value						
Leakage current	≤ The initial specified value						
Shelf Life	The following specifications shall be satisfied when the capacitors are restored to 20°C after exposing them for 500 hours at 105°C without voltage applied. Before the measurement, the capacitor shall be preconditioned by applying voltage according to Item 4.1 of JIS C 5101-4. <table border="1"> <tr> <td>Capacitance change</td> <td>≤ ±20% of the initial value</td> </tr> <tr> <td>D.F. (tan δ)</td> <td>≤ 200% of the initial specified value</td> </tr> <tr> <td>Leakage current</td> <td>≤ The initial specified value</td> </tr> </table>	Capacitance change	≤ ±20% of the initial value	D.F. (tan δ)	≤ 200% of the initial specified value	Leakage current	≤ The initial specified value
Capacitance change	≤ ±20% of the initial value						
D.F. (tan δ)	≤ 200% of the initial specified value						
Leakage current	≤ The initial specified value						

DIMENSIONS (Screw-Mount) [mm]

Terminal Code : LG

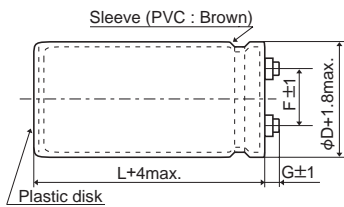

φ35 to φ63.5 : G=6
φ76.2 & φ89 : G=5

<Screw specifications>

Plus hexagon-headed screw : M5×0.8×10

Maximum screw tightening torque : 3.23Nm

* The screw and the mounting clamp are separately supplied and not attached to the product.

Mounting Clamp Code : B

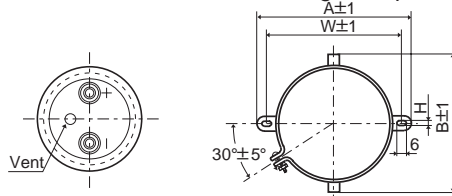

φD	A	B	W	H	F
35	58.0	44.0	48.0	3.5	12.7
50	78.0	64.0	68.0	4.5	22.4
63.5	90.0	76.0	80.0	4.5	28.0
76.2	104.5	90.0	93.5	4.5	31.5

Mounting Clamp Code : C

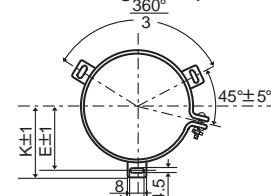

φD	E	K	J	F
50	32.5	37.0	14.0	22.4
63.5	38.1	43.5	14.0	28.0
76.2	44.5	50.0	14.0	31.5
89	50.8	56.5	16.0	31.5

PART NUMBERING SYSTEM

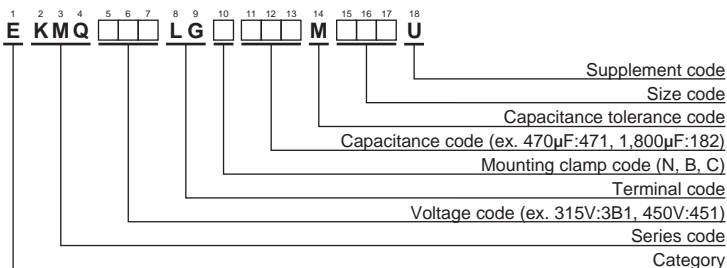

Please refer to "Product code guide (screw-mount terminal type)"



KMQ Series

◆STANDARD RATINGS

WV (V _{dc})	Cap (μF)	Case size φD×L(mm)	tan δ	Rated ripple current (Arms/105°C, 120Hz)	Part No.	WV (V _{dc})	Cap (μF)	Case size φD×L(mm)	tan δ	Rated ripple current (Arms/105°C, 120Hz)	Part No.
315	560	35 × 55	0.10	2.4	EKMQ3B1LGB561MA55U	400	390	35 × 55	0.10	2.0	EKMQ401LGB391MA55U
	680	35 × 65	0.15	2.9	EKMQ3B1LGB681MA65U		470	35 × 60	0.10	2.3	EKMQ401LGB471MA60U
	820	35 × 75	0.15	3.3	EKMQ3B1LGB821MA75U		560	35 × 70	0.15	2.7	EKMQ401LGB561MA70U
	1,000	35 × 80	0.15	3.8	EKMQ3B1LGB102MA80U		680	35 × 80	0.15	3.1	EKMQ401LGB681MA80U
	1,200	35 × 100	0.15	4.5	EKMQ3B1LGB122MAA0U		820	35 × 90	0.15	3.6	EKMQ401LGB821MA90U
	1,500	50 × 70	0.15	5.4	EKMQ3B1LGC152MC70U		1,000	50 × 65	0.15	4.2	EKMQ401LGC102MC65U
	1,800	50 × 75	0.15	6.0	EKMQ3B1LGC182MC75U		1,200	50 × 75	0.15	4.9	EKMQ401LGC122MC75U
	2,200	50 × 90	0.15	7.2	EKMQ3B1LGC222MC90U		1,500	50 × 85	0.15	5.8	EKMQ401LGC152MC85U
	2,700	50 × 100	0.15	8.4	EKMQ3B1LGC272MCA0U		2,200	63.5 × 85	0.15	8.1	EKMQ401LGC222MD85U
	3,300	63.5 × 85	0.15	9.9	EKMQ3B1LGC332MD85U		3,300	63.5 × 105	0.15	10.8	EKMQ401LGC332MDA5U
	3,900	63.5 × 96	0.15	11.3	EKMQ3B1LGC392MD96U		4,700	76.2 × 105	0.15	14.3	EKMQ401LGC472MEA5U
	4,700	76.2 × 85	0.15	13.1	EKMQ3B1LGC472ME85U		5,600	89 × 96	0.15	13.9	EKMQ401LGC562MF96U
	5,600	76.2 × 96	0.15	15.0	EKMQ3B1LGC562ME96U		6,800	89 × 115	0.15	16.6	EKMQ401LGC682MFB5U
	6,800	76.2 × 110	0.15	17.6	EKMQ3B1LGC682MEB0U		8,200	89 × 130	0.15	19.2	EKMQ401LGC822MFD0U
8,200	89 × 100	0.15	17.2	EKMQ3B1LGC822MFA0U	450	330	35 × 55	0.10	1.8	EKMQ451LGB331MA55U	
10,000	89 × 115	0.15	20.1	EKMQ3B1LGC103MFB5U		390	35 × 65	0.10	2.2	EKMQ451LGB391MA65U	
350	470	35 × 55	0.10	2.2		EKMQ351LGB471MA55U	470	35 × 75	0.10	2.5	EKMQ451LGB471MA75U
	560	35 × 60	0.10	2.5		EKMQ351LGB561MA60U	560	35 × 80	0.15	2.8	EKMQ451LGB561MA80U
	680	35 × 70	0.15	2.9		EKMQ351LGB681MA70U	680	35 × 100	0.15	3.5	EKMQ451LGB681MAA0U
	820	35 × 80	0.15	3.4		EKMQ351LGB821MA80U	820	35 × 110	0.15	4.1	EKMQ451LGB821MAB0U
	1,000	35 × 90	0.15	4.0		EKMQ351LGB102MA90U	1,000	50 × 80	0.15	4.6	EKMQ451LGC102MC80U
	1,200	50 × 65	0.15	4.6		EKMQ351LGC122MC65U	1,200	50 × 90	0.15	5.3	EKMQ451LGC122MC90U
	1,500	50 × 75	0.15	5.5		EKMQ351LGC152MC75U	1,500	50 × 105	0.15	6.4	EKMQ451LGC152MCA5U
	1,800	50 × 85	0.15	6.4		EKMQ351LGC182MC85U	2,200	63.5 × 96	0.15	8.5	EKMQ451LGC222MD96U
	2,200	50 × 100	0.15	7.6		EKMQ351LGC222MCA0U	3,300	63.5 × 130	0.15	11.9	EKMQ451LGC332MDD0U
	2,700	63.5 × 85	0.15	9.0		EKMQ351LGC272MD85U	4,700	76.2 × 130	0.15	15.7	EKMQ451LGC472MED0U
	3,900	76.2 × 80	0.15	11.7		EKMQ351LGC392ME80U	5,600	76.2 × 155	0.15	18.5	EKMQ451LGC562MEF5U
	5,600	76.2 × 105	0.15	15.6		EKMQ351LGC562MEA5U	5,600	89 × 120	0.15	15.3	EKMQ451LGC562MFC0U
	6,800	76.2 × 125	0.15	18.6	EKMQ351LGC682MEC5U	6,800	89 × 140	0.15	18.0	EKMQ451LGC682MFE0U	
	8,200	89 × 115	0.15	18.2	EKMQ351LGC822MFB5U	8,200	89 × 170	0.15	21.6	EKMQ451LGC822MFH0U	

◆RATED RIPPLE CURRENT MULTIPLIERS

● Frequency Multipliers

Frequency (Hz)	50	120	300	1k	3k
φ 35, 50	0.70	1.00	1.30	1.70	1.80
φ 63.5 to 89	0.80	1.00	1.10	1.15	1.15

The deterioration of aluminum electrolytic capacitors accelerates their life due to the internal heating produced by ripple current. For details, refer to Section "5-3 Ripple Current Effect on Lifetime" in the catalog, Technical Note.

KMH Series

- Endurance with ripple current : 2,000 hours at 105°C
- RoHS2 Compliant

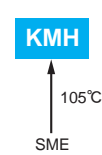

SPECIFICATIONS

Items	Characteristics						
Category	-40 to +105°C (10 to 100V _{dc}) -25 to +105°C (160 to 400V _{dc})						
Temperature Range							
Rated Voltage Range	10 to 400V _{dc}						
Capacitance Tolerance	±20% (M) (at 20°C, 120Hz)						
Leakage Current	I=0.02CV or 5mA, whichever is smaller. Where, I : Max. leakage current (μA), C : Nominal capacitance (μF), V : Rated voltage (V) (at 20°C after 5 minutes)						
Dissipation Factor (tan δ)	Shall not exceed the values shown in the STANDARD RATINGS (at 20°C, 120Hz)						
Low Temperature Characteristics	Capacitance change 10 to 100V _{dc} : C(-40°C)/C(+20°C) ≥ 0.6 160 to 400V _{dc} : C(-25°C)/C(+20°C) ≥ 0.7 (at 120Hz)						
Insulation Resistance	When measured between the terminals that are connected to each other and to the mounting clamp on the insulating sleeve covering the case by using an insulation resistance meter of 500V _{dc} , the insulation resistance shall not be less than 100MΩ.						
Insulation Withstanding Voltage	When a voltage of 2,000V _{ac} is applied for 1 minute between the terminals that are connected to each other and to the mounting clamp on the insulating sleeve covering the case, there shall not be electrical damage.						
Endurance	The following specifications shall be satisfied when the capacitors are restored to 20°C after subjected to DC voltage with the rated ripple current is applied (the peak voltage shall not exceed the rated voltage) for 2,000 hours at 105°C. <table border="1"> <tr> <td>Capacitance change</td> <td>≤ ±20% of the initial value</td> </tr> <tr> <td>D.F. (tan δ)</td> <td>≤ 200% of the initial specified value</td> </tr> <tr> <td>Leakage current</td> <td>≤ The initial specified value</td> </tr> </table>	Capacitance change	≤ ±20% of the initial value	D.F. (tan δ)	≤ 200% of the initial specified value	Leakage current	≤ The initial specified value
Capacitance change	≤ ±20% of the initial value						
D.F. (tan δ)	≤ 200% of the initial specified value						
Leakage current	≤ The initial specified value						
Shelf Life	The following specifications shall be satisfied when the capacitors are restored to 20°C after exposing them for 500 hours at 105°C without voltage applied. Before the measurement, the capacitor shall be preconditioned by applying voltage according to Item 4.1 of JIS C 5101-4. <table border="1"> <tr> <td>Capacitance change</td> <td>≤ ±20% of the initial value</td> </tr> <tr> <td>D.F. (tan δ)</td> <td>≤ 200% of the initial specified value</td> </tr> <tr> <td>Leakage current</td> <td>≤ The initial specified value</td> </tr> </table>	Capacitance change	≤ ±20% of the initial value	D.F. (tan δ)	≤ 200% of the initial specified value	Leakage current	≤ The initial specified value
Capacitance change	≤ ±20% of the initial value						
D.F. (tan δ)	≤ 200% of the initial specified value						
Leakage current	≤ The initial specified value						

DIMENSIONS (Screw-Mount) [mm]

Terminal Code : LG

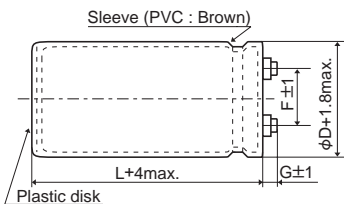

φ35 to φ63.5 : G=6
φ76.2 & φ89 : G=5

<Screw specifications>

Plus hexagon-headed screw : M5×0.8×10

Maximum screw tightening torque : 3.23Nm

* The screw and the mounting clamp are separately supplied and not attached to the product.

Mounting Clamp Code : B

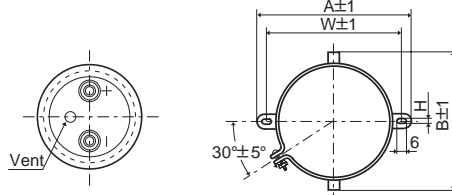

φD	A	B	W	H	F
35	58.0	44.0	48.0	3.5	12.7
50	78.0	64.0	68.0	4.5	22.4
63.5	90.0	76.0	80.0	4.5	28.0
76.2	104.5	90.0	93.5	4.5	31.5

Mounting Clamp Code : C

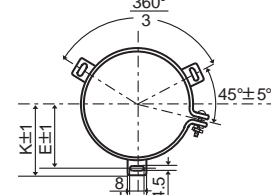

φD	E	K	J	F
50	32.5	37.0	14.0	22.4
63.5	38.1	43.5	14.0	28.0
76.2	44.5	50.0	14.0	31.5
89	50.8	56.5	16.0	31.5

PART NUMBERING SYSTEM

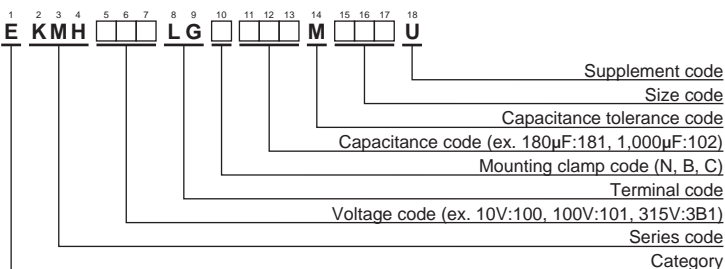

Please refer to "Product code guide (screw-mount terminal type)"



◆ **STANDARD RATINGS**

WV (V _{dc})	Cap (μF)	Case size φD×L(mm)	tan δ	Rated ripple current (Arms/105°C, 120Hz)	Part No.	WV (V _{dc})	Cap (μF)	Case size φD×L(mm)	tan δ	Rated ripple current (Arms/105°C, 120Hz)	Part No.	
10	27,000	35 × 50	0.45	4.90	EKMH100LGB273MA50U	35	56,000	50 × 100	0.40	11.4	EKMH350LGC563MCA0U	
	33,000	35 × 50	0.50	5.10	EKMH100LGB333MA50U		68,000	50 × 120	0.40	13.6	EKMH350LGC683MCC0U	
	39,000	35 × 60	0.50	5.90	EKMH100LGB393MA60U		82,000	63.5 × 100	0.45	14.8	EKMH350LGC823MDA0U	
	47,000	35 × 80	0.50	7.10	EKMH100LGB473MA80U		100,000	63.5 × 120	0.45	17.6	EKMH350LGC104MDC0U	
	56,000	35 × 80	0.60	7.10	EKMH100LGB563MA80U		120,000	63.5 × 120	0.55	17.6	EKMH350LGC124MDC0U	
	68,000	35 × 100	0.60	8.50	EKMH100LGB683MAA0U		150,000	76.2 × 120	0.65	19.8	EKMH350LGC154MEC0U	
	82,000	35 × 100	0.65	8.90	EKMH100LGB823MAA0U		180,000	76.2 × 120	0.80	19.8	EKMH350LGC184MEC0U	
	100,000	35 × 120	0.65	10.7	EKMH100LGB104MAC0U		220,000	76.2 × 140	0.80	23.4	EKMH350LGC224MEE0U	
	120,000	50 × 80	0.75	11.0	EKMH100LGC124MC80U		270,000	89 × 140	1.00	25.5	EKMH350LGC274MFE0U	
	150,000	50 × 100	0.80	13.2	EKMH100LGC154MCA0U		50	3,900	35 × 50	0.20	2.80	EKMH500LGB392MA50U
	180,000	50 × 120	0.80	15.7	EKMH100LGC184MCC0U			4,700	35 × 50	0.20	3.10	EKMH500LGB223MA50U
	220,000	50 × 120	0.85	16.8	EKMH100LGC224MCC0U			5,600	35 × 50	0.20	3.30	EKMH500LGB562MA50U
	270,000	63.5 × 120	1.00	19.6	EKMH100LGC274MDC0U			6,800	35 × 50	0.25	3.30	EKMH500LGB682MA50U
	330,000	63.5 × 120	1.20	19.7	EKMH100LGC334MDC0U			8,200	35 × 60	0.25	3.80	EKMH500LGB822MA60U
	390,000	76.2 × 120	1.50	21.3	EKMH100LGC394MCC0U			10,000	35 × 80	0.25	4.60	EKMH500LGB223MAC0U
	470,000	76.2 × 120	1.80	21.4	EKMH100LGC474MEC0U			12,000	35 × 80	0.25	5.10	EKMH500LGB123MA80U
560,000	76.2 × 140	2.00	23.6	EKMH100LGC564MEE0U	15,000	35 × 80		0.25	5.70	EKMH500LGB153MA80U		
680,000	89 × 140	2.40	26.0	EKMH100LGC684MFE0U	18,000	35 × 100		0.25	6.70	EKMH500LGB183MAA0U		
16	18,000	35 × 50	0.40	4.20	EKMH160LGB183MA50U	22,000		35 × 120	0.25	8.10	EKMH500LGB473MCC0U	
	22,000	35 × 50	0.40	4.70	EKMH160LGB223MA50U	27,000		50 × 80	0.25	9.10	EKMH500LGC273MC80U	
	27,000	35 × 60	0.40	5.50	EKMH160LGB273MA60U	33,000		50 × 100	0.25	11.1	EKMH500LGC333MCA0U	
	33,000	35 × 60	0.45	5.70	EKMH160LGB333MA60U	39,000		50 × 120	0.25	13.1	EKMH500LGC393MCC0U	
	39,000	35 × 80	0.45	6.80	EKMH160LGB393MA80U	47,000		50 × 120	0.30	13.9	EKMH500LGC473MCC0U	
	47,000	35 × 80	0.50	7.10	EKMH160LGB473MA80U	56,000		63.5 × 100	0.35	13.9	EKMH500LGC563MDA0U	
	56,000	35 × 100	0.50	8.40	EKMH160LGB563MAA0U	68,000		63.5 × 120	0.35	16.6	EKMH500LGC683MDC0U	
	68,000	35 × 100	0.55	8.80	EKMH160LGB683MAA0U	82,000	76.2 × 120	0.40	18.9	EKMH500LGC823MEC0U		
	82,000	50 × 80	0.55	10.7	EKMH160LGC823MC80U	100,000	76.2 × 120	0.45	19.5	EKMH500LGC104MEC0U		
	100,000	50 × 80	0.65	10.8	EKMH160LGC104MC80U	120,000	76.2 × 120	0.55	19.5	EKMH500LGC124MEC0U		
	120,000	50 × 100	0.65	13.1	EKMH160LGC124MCA0U	150,000	89 × 140	0.60	23.9	EKMH500LGC154MFE0U		
	150,000	50 × 120	0.70	15.3	EKMH160LGC154MCC0U	180,000	89 × 140	0.75	23.9	EKMH500LGC184MFE0U		
	180,000	50 × 120	0.80	15.7	EKMH160LGC184MCC0U	63	2,700	35 × 50	0.20	2.30	EKMH630LGB223MA50U	
	220,000	63.5 × 120	0.85	19.2	EKMH160LGC224MDC0U		3,300	35 × 50	0.20	2.50	EKMH630LGB332MA50U	
	270,000	63.5 × 120	1.00	19.6	EKMH160LGC274MDC0U		3,900	35 × 50	0.20	2.80	EKMH630LGB392MA50U	
	330,000	76.2 × 120	1.30	21.1	EKMH160LGC334MEC0U		4,700	35 × 50	0.20	3.10	EKMH630LGB472MA50U	
390,000	76.2 × 120	1.50	21.3	EKMH160LGC394MCC0U	5,600		35 × 60	0.20	3.50	EKMH630LGB562MA60U		
470,000	76.2 × 140	1.60	24.2	EKMH160LGC474MEE0U	6,800		35 × 60	0.20	3.90	EKMH630LGB682MA60U		
560,000	89 × 140	2.00	28.1	EKMH160LGC564MFE0U	8,200		35 × 80	0.20	4.70	EKMH630LGB822MA80U		
680,000	89 × 140	2.40	28.5	EKMH160LGC684MFE0U	10,000		35 × 80	0.25	4.70	EKMH630LGB103MA80U		
25	12,000	35 × 50	0.35	3.70	EKMH250LGB123MA50U		12,000	35 × 100	0.25	5.50	EKMH630LGB123MAA0U	
	15,000	35 × 50	0.35	4.10	EKMH250LGB153MA50U		15,000	35 × 120	0.25	6.60	EKMH630LGB153MAC0U	
	18,000	35 × 60	0.35	4.80	EKMH250LGB183MA60U		18,000	50 × 80	0.25	7.40	EKMH630LGC183MC80U	
	22,000	35 × 60	0.35	5.30	EKMH250LGB223MA60U		22,000	50 × 100	0.25	9.00	EKMH630LGC223MCA0U	
	27,000	35 × 80	0.35	6.40	EKMH250LGB273MA80U		27,000	50 × 120	0.25	10.9	EKMH630LGC273MCC0U	
	33,000	35 × 80	0.40	6.70	EKMH250LGB333MA80U		33,000	50 × 120	0.25	12.0	EKMH630LGC333MCC0U	
	39,000	35 × 100	0.40	7.80	EKMH250LGB393MAA0U		39,000	63.5 × 100	0.30	12.5	EKMH630LGC393MDA0U	
	47,000	35 × 120	0.40	9.30	EKMH250LGB473MAC0U		47,000	63.5 × 120	0.30	14.9	EKMH630LGC473MDC0U	
	56,000	50 × 80	0.45	9.70	EKMH250LGC563MCA0U	56,000	63.5 × 120	0.30	16.3	EKMH630LGC563MDC0U		
	68,000	50 × 100	0.45	11.2	EKMH250LGC683MCA0U	68,000	76.2 × 120	0.35	18.4	EKMH630LGC683MEC0U		
	82,000	50 × 100	0.50	11.2	EKMH250LGC823MCA0U	82,000	76.2 × 140	0.40	20.0	EKMH630LGC823MEE0U		
	100,000	50 × 120	0.50	14.8	EKMH250LGC104MCC0U	100,000	76.2 × 140	0.50	20.0	EKMH630LGC104MEE0U		
	120,000	63.5 × 100	0.65	14.9	EKMH250LGC124MDA0U	120,000	89 × 140	0.60	21.8	EKMH630LGC124MFE0U		
	150,000	63.5 × 120	0.65	17.9	EKMH250LGC154MDC0U	80	2,200	35 × 50	0.15	2.40	EKMH800LGB222MA50U	
	180,000	63.5 × 120	0.80	17.9	EKMH250LGC184MDC0U		2,700	35 × 50	0.15	2.70	EKMH800LGB272MA50U	
	220,000	76.2 × 120	0.85	21.3	EKMH250LGC224MEC0U		3,300	35 × 50	0.15	3.00	EKMH800LGB332MA50U	
270,000	76.2 × 120	1.00	21.7	EKMH250LGC274MEC0U	3,900		35 × 60	0.15	3.40	EKMH800LGB392MA60U		
330,000	76.2 × 140	1.20	23.4	EKMH250LGC334MEE0U	4,700		35 × 60	0.15	3.70	EKMH800LGB472MA60U		
390,000	89 × 140	1.50	24.9	EKMH250LGC394MFE0U	5,600		35 × 80	0.15	4.50	EKMH800LGB562MA80U		
35	8,200	35 × 50	0.30	3.30	EKMH350LGB822MA50U		6,800	35 × 80	0.15	4.90	EKMH800LGB682MA80U	
	10,000	35 × 50	0.30	3.60	EKMH350LGB103MA50U		8,200	35 × 100	0.20	5.10	EKMH800LGB822MAA0U	
	12,000	35 × 60	0.30	4.20	EKMH350LGB123MA60U		10,000	35 × 120	0.20	6.10	EKMH800LGB103MAC0U	
	15,000	35 × 60	0.30	4.70	EKMH350LGB153MA60U		12,000	50 × 80	0.20	6.70	EKMH800LGC123MC80U	
	18,000	35 × 80	0.30	5.70	EKMH350LGB183MA80U		15,000	50 × 100	0.20	8.30	EKMH800LGC153MCA0U	
	22,000	35 × 80	0.30	6.30	EKMH350LGB223MA80U		18,000	50 × 120	0.20	9.90	EKMH800LGC183MCC0U	
	27,000	35 × 100	0.30	7.50	EKMH350LGB273MAA0U		22,000	50 × 120	0.20	11.0	EKMH800LGC223MCC0U	
	33,000	35 × 120	0.30	9.00	EKMH350LGB333MAC0U		27,000	63.5 × 100	0.25	11.4	EKMH800LGC273MDA0U	
	39,000	50 × 80	0.35	9.20	EKMH350LGC393MC80U		33,000	76.2 × 100	0.25	13.9	EKMH800LGC333MEA0U	
	47,000	50 × 100	0.35	11.2	EKMH350LGC473MCA0U		39,000	76.2 × 100	0.30	13.9	EKMH800LGC393MEA0U	

Product specifications in this catalog are subject to change without notice. Request our product specifications before purchase and/or use. Please use our products based on the information contained in this catalog and product specifications.



◆ **STANDARD RATINGS**

WV (V _{dc})	Cap (μF)	Case size φD×L(mm)	tan δ	Rated ripple current (Arms/105°C, 120Hz)	Part No.	WV (V _{dc})	Cap (μF)	Case size φD×L(mm)	tan δ	Rated ripple current (Arms/105°C, 120Hz)	Part No.
80	47,000	76.2 × 120	0.30	16.5	EKMH800LGC473MEC0U	250	330	35 × 50	0.15	0.90	EKMH251LGB331MA50U
	56,000	76.2 × 120	0.30	18.1	EKMH800LGC563MEC0U		390	35 × 50	0.15	1.00	EKMH251LGB391MA50U
	68,000	76.2 × 140	0.35	19.7	EKMH800LGC683MEE0U		470	35 × 50	0.15	1.10	EKMH251LGB471MA50U
	82,000	89 × 140	0.40	22.1	EKMH800LGC823MFE0U		560	35 × 50	0.15	1.20	EKMH251LGB561MA50U
100	1,800	35 × 50	0.10	2.70	EKMH101LGB182MA50U	680	35 × 60	0.15	1.40	EKMH251LGB681MA60U	
	2,200	35 × 50	0.10	3.00	EKMH101LGB222MA50U	820	35 × 80	0.15	1.60	EKMH251LGB821MA80U	
	2,700	35 × 60	0.10	3.50	EKMH101LGB272MA60U	1,000	35 × 80	0.20	1.60	EKMH251LGB102MA80U	
	3,300	35 × 80	0.10	4.20	EKMH101LGB332MA80U	1,200	35 × 80	0.20	1.80	EKMH251LGB122MA80U	
	3,900	35 × 80	0.12	4.20	EKMH101LGB392MA80U	1,500	35 × 100	0.20	2.10	EKMH251LGB152MAA0U	
	4,700	35 × 100	0.12	5.00	EKMH101LGB472MAA0U	1,800	35 × 120	0.20	2.50	EKMH251LGB182MAC0U	
	5,600	35 × 100	0.12	5.40	EKMH101LGB562MAA0U	2,200	50 × 80	0.20	2.90	EKMH251LGB102MA80U	
	6,800	35 × 120	0.15	5.80	EKMH101LGB682MAC0U	2,700	50 × 100	0.20	3.50	EKMH251LGC272MCA0U	
	8,200	50 × 80	0.15	6.40	EKMH101LGC822MC80U	3,300	50 × 120	0.20	4.20	EKMH251LGC332MCC0U	
	10,000	50 × 100	0.15	7.80	EKMH101LGC103MCA0U	3,900	50 × 120	0.20	4.60	EKMH251LGC392MCC0U	
	12,000	50 × 120	0.15	9.30	EKMH101LGC123MCC0U	10,000	63.5 × 120	0.20	5.70	EKMH251LGC472MCA0U	
	15,000	50 × 120	0.15	10.4	EKMH101LGC153MCC0U	5,600	63.5 × 120	0.20	6.30	EKMH251LGC562MDC0U	
	18,000	63.5 × 100	0.20	10.4	EKMH101LGC183MDA0U	6,800	76.2 × 120	0.20	7.70	EKMH251LGC682MEC0U	
	22,000	63.5 × 120	0.20	12.5	EKMH101LGC223MDC0U	8,200	76.2 × 120	0.20	8.40	EKMH251LGC822MEC0U	
	27,000	76.2 × 120	0.25	13.7	EKMH101LGC273MEC0U	10,000	76.2 × 140	0.20	10.0	EKMH251LGC103MEE0U	
	33,000	76.2 × 120	0.25	15.2	EKMH101LGC333MEC0U	12,000	89 × 140	0.20	11.9	EKMH251LGC123MFE0U	
39,000	76.2 × 140	0.30	16.1	EKMH101LGC393MEE0U	315	180	35 × 50	0.10	0.80	EKMH315LGB181MA50U	
47,000	89 × 140	0.30	19.3	EKMH101LGC473MFE0U		220	35 × 50	0.10	0.90	EKMH315LGB221MA50U	
56,000	89 × 140	0.30	21.1	EKMH101LGC563MFE0U		270	35 × 50	0.10	1.00	EKMH315LGB271MA50U	
160	560	35 × 50	0.15	1.20		EKMH161LGB561MA50U	330	35 × 50	0.10	1.10	EKMH315LGB331MA50U
	680	35 × 50	0.15	1.30		EKMH161LGB681MA50U	390	35 × 50	0.10	1.20	EKMH315LGB391MA50U
	820	35 × 50	0.15	1.40		EKMH161LGB821MA50U	470	35 × 60	0.10	1.40	EKMH315LGB471MA60U
	1,000	35 × 50	0.15	1.60		EKMH161LGB102MA50U	560	35 × 60	0.10	1.50	EKMH315LGB561MA60U
	1,200	35 × 60	0.15	1.90		EKMH161LGB122MA60U	680	35 × 80	0.10	1.70	EKMH315LGB681MA80U
	1,500	35 × 60	0.15	2.10		EKMH161LGB152MA60U	820	35 × 80	0.15	1.70	EKMH315LGB821MA80U
	1,800	35 × 80	0.15	2.50		EKMH161LGB182MA80U	1,000	35 × 100	0.15	2.00	EKMH315LGB102MAA0U
	2,200	35 × 80	0.15	2.80		EKMH161LGB222MA80U	1,200	35 × 120	0.15	2.40	EKMH315LGB122MAC0U
	2,700	35 × 100	0.15	3.30		EKMH161LGB272MAA0U	1,500	50 × 80	0.15	2.70	EKMH315LGC152MC80U
	3,300	35 × 120	0.15	3.80		EKMH161LGB332MAC0U	1,800	50 × 100	0.15	3.30	EKMH315LGC182MCA0U
	3,900	50 × 80	0.20	3.80		EKMH161LGC392MC80U	2,200	50 × 120	0.15	4.00	EKMH315LGC222MCC0U
	4,700	50 × 100	0.20	4.60		EKMH161LGC472MCA0U	2,700	50 × 120	0.15	4.40	EKMH315LGC272MCC0U
	5,600	50 × 100	0.20	5.10		EKMH161LGC562MCA0U	3,300	63.5 × 100	0.15	5.10	EKMH315LGC332MDA0U
	6,800	50 × 120	0.20	6.10	EKMH161LGC682MCC0U	3,900	63.5 × 120	0.15	6.00	EKMH315LGC392MDC0U	
	8,200	63.5 × 100	0.20	7.00	EKMH161LGC822MDA0U	4,700	76.2 × 100	0.15	6.80	EKMH315LGC472MEA0U	
	10,000	63.5 × 120	0.20	8.40	EKMH161LGC103MDC0U	5,600	76.2 × 120	0.15	8.00	EKMH315LGC562MCC0U	
12,000	76.2 × 100	0.20	9.40	EKMH161LGC123MEA0U	6,800	76.2 × 130	0.15	9.20	EKMH315LGC682MED0U		
15,000	76.2 × 120	0.20	11.4	EKMH161LGC153MEC0U	8,200	89 × 140	0.15	11.4	EKMH315LGC822MFE0U		
18,000	76.2 × 140	0.20	13.4	EKMH161LGC183MEE0U	10,000	89 × 140	0.15	12.6	EKMH315LGC103MFE0U		
22,000	89 × 140	0.25	14.5	EKMH161LGC223MFE0U	350	180	35 × 50	0.10	0.80	EKMH351LGB181MA50U	
27,000	89 × 140	0.25	16.0	EKMH161LGC273MFE0U		220	35 × 50	0.10	0.90	EKMH351LGB221MA50U	
200	330	35 × 50	0.15	0.90		EKMH201LGB331MA50U	270	35 × 50	0.10	1.00	EKMH351LGB271MA50U
	390	35 × 50	0.15	1.00		EKMH201LGB391MA50U	330	35 × 50	0.10	1.10	EKMH351LGB331MA50U
	470	35 × 50	0.15	1.10		EKMH201LGB471MA50U	390	35 × 60	0.10	1.30	EKMH351LGB391MA60U
	560	35 × 50	0.15	1.20		EKMH201LGB561MA50U	470	35 × 60	0.10	1.40	EKMH351LGB471MA60U
	680	35 × 50	0.15	1.30		EKMH201LGB681MA50U	560	35 × 80	0.10	1.60	EKMH351LGB561MA80U
	820	35 × 50	0.15	1.40		EKMH201LGB821MA50U	680	35 × 80	0.15	1.60	EKMH351LGB681MA80U
	1,000	35 × 60	0.15	1.70		EKMH201LGB102MA60U	820	35 × 100	0.15	1.80	EKMH351LGB821MAA0U
	1,200	35 × 60	0.15	1.90		EKMH201LGB122MA60U	1,000	35 × 120	0.15	2.20	EKMH351LGB102MAC0U
	1,500	35 × 80	0.15	2.30		EKMH201LGB152MA80U	1,200	50 × 80	0.15	2.40	EKMH351LGC122MC80U
	1,800	35 × 80	0.15	2.50		EKMH201LGB182MA80U	1,500	50 × 100	0.15	3.00	EKMH351LGC152MCA0U
	2,200	35 × 100	0.15	3.00		EKMH201LGB222MAA0U	1,800	50 × 120	0.15	3.60	EKMH351LGC182MCC0U
	2,700	35 × 120	0.15	3.60		EKMH201LGB272MAC0U	2,200	50 × 120	0.15	4.00	EKMH351LGC222MCC0U
	3,300	50 × 80	0.15	4.10		EKMH201LGC332MC80U	2,700	63.5 × 100	0.15	4.60	EKMH351LGC272MDA0U
	3,900	50 × 100	0.15	4.90		EKMH201LGC392MCA0U	3,900	76.2 × 120	0.15	6.70	EKMH351LGC392MEC0U
	4,700	63.5 × 100	0.20	5.30	EKMH201LGC472MDA0U	5,600	76.2 × 130	0.15	8.30	EKMH351LGC562MED0U	
	5,600	63.5 × 100	0.20	5.80	EKMH201LGC562MDA0U	6,800	76.2 × 140	0.15	9.50	EKMH351LGC682MEE0U	
6,800	63.5 × 120	0.20	6.90	EKMH201LGC682MDC0U	8,200	89 × 140	0.15	11.4	EKMH351LGC822MFE0U		
8,200	63.5 × 120	0.20	7.60	EKMH201LGC822MDC0U	400	180	35 × 50	0.10	0.80	EKMH401LGB181MA50U	
10,000	76.2 × 120	0.20	9.30	EKMH201LGC103MEC0U		220	35 × 50	0.10	0.90	EKMH401LGB221MA50U	
12,000	76.2 × 120	0.20	10.2	EKMH201LGC123MEC0U		270	35 × 50	0.10	1.00	EKMH401LGB271MA50U	
15,000	76.2 × 140	0.20	12.2	EKMH201LGC153MEE0U		330	35 × 60	0.10	1.20	EKMH401LGB331MA60U	
18,000	89 × 140	0.25	13.1	EKMH201LGC183MFE0U		390	35 × 60	0.10	1.30	EKMH401LGB391MA60U	
250	270	35 × 50	0.15	0.80		EKMH251LGB271MA50U	470	35 × 80	0.10	1.40	EKMH401LGB471MA80U

Product specifications in this catalog are subject to change without notice. Request our product specifications before purchase and/or use. Please use our products based on the information contained in this catalog and product specifications.



KMHSeries

◆ **STANDARD RATINGS**

WV (V _{dc})	Cap (μF)	Case size φD×L(mm)	tan δ	Rated ripple current (Arms/105°C, 120Hz)	Part No.	WV (V _{dc})	Cap (μF)	Case size φD×L(mm)	tan δ	Rated ripple current (Arms/105°C, 120Hz)	Part No.
400	560	35 × 80	0.15	1.40	EKMH401LGB561MA80U	400	2,200	63.5 × 100	0.15	4.20	EKMH401LGC222MDA0U
	680	35 × 100	0.15	1.70	EKMH401LGB681MAA0U		3,300	63.5 × 120	0.15	5.50	EKMH401LGC332MDC0U
	820	35 × 120	0.15	2.00	EKMH401LGB821MAC0U		4,700	76.2 × 130	0.15	7.60	EKMH401LGC472MED0U
	1,000	50 × 80	0.15	2.20	EKMH401LGC102MC80U		5,600	89 × 140	0.15	9.40	EKMH401LGC562MFE0U
	1,200	50 × 100	0.15	2.70	EKMH401LGC122MCA0U		6,800	89 × 140	0.15	10.4	EKMH401LGC682MFE0U
	1,500	50 × 120	0.15	3.30	EKMH401LGC152MCC0U						

◆ **RATED RIPPLE CURRENT MULTIPLIERS**

● Frequency Multipliers

Rated voltage (V _{dc})	Case diameter (mm)	Frequency (Hz)					
		50	120	300	1k	10k	50k
10 to 50	φ35 to φ89	0.95	1.00	1.03	1.05	1.09	1.12
63 & 80	φ35	0.90	1.00	1.06	1.10	1.18	1.22
	φ50 to φ89	0.95	1.00	1.03	1.05	1.09	1.12
100	φ35	0.82	1.00	1.12	1.22	1.30	1.33
	φ50	0.90	1.00	1.06	1.10	1.18	1.22
	φ63.5 to φ89	0.95	1.00	1.03	1.05	1.09	1.12
160 to 250	φ35	0.80	1.00	1.19	1.34	1.46	1.52
	φ50 & φ63.5	0.81	1.00	1.14	1.26	1.36	1.41
	φ76.2 & φ89	0.82	1.00	1.12	1.22	1.30	1.33
315 to 400	φ35 to φ89	0.80	1.00	1.19	1.34	1.46	1.52

The deterioration of aluminum electrolytic capacitors accelerates their life due to the internal heating produced by ripple current. For details, refer to Section "5-3 Ripple Current Effect on Lifetime" in the catalog, Technical Note.

RWX Series

- Higher capacitance than RWF series.
- Endurance with ripple current : 5,000 hours at 85°C
- Suitable for UPS devices and servo press machines where higher capacitance is required.
- RoHS2 compliant

RWX

Higher capacitance
↑
RWF



SPECIFICATIONS

Items	Characteristics						
Category							
Temperature Range	-40 to +85°C						
Rated Voltage Range	400 & 450V _{dc}						
Capacitance Tolerance	±20% (M) (at 20°C, 120Hz)						
Leakage Current	I=0.01CV or 7mA, whichever is smaller. Where, I : Max. leakage current (μA), C : Nominal capacitance (μF), V : Rated voltage (V) (at 20°C after 5 minutes)						
Dissipation Factor (tan δ)	0.25 max. (at 20°C, 120Hz)						
Low Temperature Characteristics	Capacitance change $C(-25°C)/C(+20°C) \geq 0.7$ (at 120Hz)						
Insulation Resistance	When measured between the terminals that are connected to each other and to the mounting clamp on the insulating sleeve covering the case by using an insulation resistance meter of 500V _{dc} , the insulation resistance shall not be less than 100MΩ.						
Insulation Withstanding Voltage	When a voltage of 2,000V _{ac} is applied for 1 minute between the terminals that are connected to each other and to the mounting clamp on the insulating sleeve covering the case, there shall not be electrical damage.						
Endurance	The following specifications shall be satisfied when the capacitors are restored to 20°C after subjected to DC voltage with the rated ripple current is applied (the peak voltage shall not exceed the rated voltage) for 5,000 hours at 85°C. <table border="1"> <tr> <td>Capacitance change</td> <td>≤ ±20% of the initial value</td> </tr> <tr> <td>D.F. (tan δ)</td> <td>≤ 200% of the initial specified value</td> </tr> <tr> <td>Leakage current</td> <td>≤ The initial specified value</td> </tr> </table>	Capacitance change	≤ ±20% of the initial value	D.F. (tan δ)	≤ 200% of the initial specified value	Leakage current	≤ The initial specified value
Capacitance change	≤ ±20% of the initial value						
D.F. (tan δ)	≤ 200% of the initial specified value						
Leakage current	≤ The initial specified value						
Shelf Life	The following specifications shall be satisfied when the capacitors are restored to 20°C after exposing them for 500 hours at 85°C without voltage applied. Before the measurement, the capacitor shall be preconditioned by applying voltage according to Item 4.1 of JIS C 5101-4. <table border="1"> <tr> <td>Capacitance change</td> <td>≤ ±20% of the initial value</td> </tr> <tr> <td>D.F. (tan δ)</td> <td>≤ 200% of the initial specified value</td> </tr> <tr> <td>Leakage current</td> <td>≤ The initial specified value</td> </tr> </table>	Capacitance change	≤ ±20% of the initial value	D.F. (tan δ)	≤ 200% of the initial specified value	Leakage current	≤ The initial specified value
Capacitance change	≤ ±20% of the initial value						
D.F. (tan δ)	≤ 200% of the initial specified value						
Leakage current	≤ The initial specified value						

DIMENSIONS (Screw-Mount) [mm]

Terminal Code : LG

Mounting Clamp Code : B

Mounting Clamp Code : C : Standard

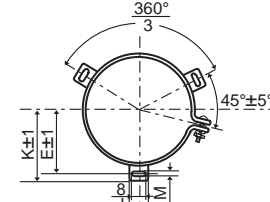
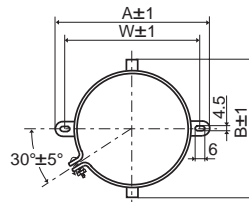
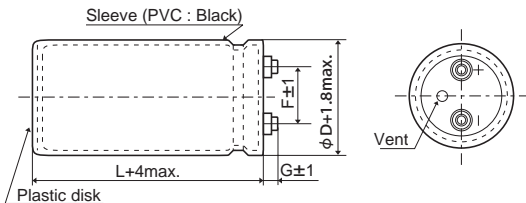

φD	A	B	W	F
63.5	90.0	76.0	80.0	28.0
76.2	104.5	90.0	93.5	31.5

φD	E	K	M	F	J
63.5	38.1	43.5	4.5	28.0	14.0
76.2	44.5	50.0	4.5	31.5	14.0
89	50.8	56.5	4.5	31.5	16.0
100	56.5	63.4	5.5	41.5	18.0

- φ 63.5 : G=6
- φ 76.2 & φ 89 : G=5
- φ 100 : G=10

<Screw specifications>

to φ89 Plus hexagon-headed screw :M5×0.8×10
Maximum screw tightening torque :3.23Nm

φ100 Cross-recessed head (phillips) screw : M8×1.25×16
Spring washer, Washer
Maximum screw tightening torque :6.31Nm

* The screw and the mounting clamp are separately supplied and not attached to the product.

PART NUMBERING SYSTEM

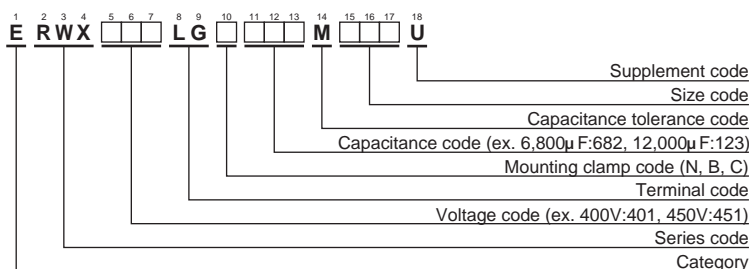

Please refer to "Product code guide (screw-mount terminal type)"



RWX Series

◆STANDARD RATINGS

WV (V _{dc})	Cap (μF)	Case size φD×L(mm)	tan δ	Rated ripple current (Arms/85°C,120Hz)	Part No.
400	2,200	63.5×60	0.25	5.2	ERWX401LGC222MD60U
	2,700	63.5×70	0.25	6.1	ERWX401LGC272MD70U
	3,300	63.5×80	0.25	7.2	ERWX401LGC332MD80U
	3,900	63.5×90	0.25	8.2	ERWX401LGC392MD90U
	4,700	63.5×100	0.25	9.4	ERWX401LGC472MDA0U
	5,600	63.5×115	0.25	10.0	ERWX401LGC562MDB5U
	6,800	63.5×135	0.25	11.9	ERWX401LGC682MDD5U
	8,200	63.5×155	0.25	13.1	ERWX401LGC822MDF5U
	8,200	76.2×115	0.25	12.7	ERWX401LGC822MEB5U
	10,000	76.2×135	0.25	15.0	ERWX401LGC103MED5U
	12,000	76.2×155	0.25	16.8	ERWX401LGC123MEF5U
	15,000	89×145	0.25	16.9	ERWX401LGC153MFE5U
	18,000	89×165	0.25	19.1	ERWX401LGC183MFG5U
	20,000	89×205	0.25	22.1	ERWX401LGC203MFL5U
	20,000	100×165	0.25	21.5	ERWX401LGC203MGG5U
	25,000	100×205	0.25	25.8	ERWX401LGC253MGL5U
30,000	100×240	0.25	30.0	ERWX401LGC303MGQ0U	
34,000	100×270	0.25	33.1	ERWX401LGC343MGT0U	

WV (V _{dc})	Cap (μF)	Case size φD×L(mm)	tan δ	Rated ripple current (Arms/85°C,120Hz)	Part No.
450	2,200	63.5×70	0.25	5.3	ERWX451LGC222MD70U
	2,700	63.5×80	0.25	6.2	ERWX451LGC272MD80U
	3,300	63.5×90	0.25	7.3	ERWX451LGC332MD90U
	3,900	63.5×100	0.25	8.3	ERWX451LGC392MDA0U
	4,700	63.5×115	0.25	9.6	ERWX451LGC472MDB5U
	5,600	63.5×130	0.25	10.3	ERWX451LGC562MDD0U
	6,800	63.5×155	0.25	12.3	ERWX451LGC682MDF5U
	6,800	76.2×115	0.25	11.9	ERWX451LGC682MEB5U
	8,200	76.2×130	0.25	12.9	ERWX451LGC822MED0U
	10,000	76.2×155	0.25	15.4	ERWX451LGC103MEF5U
	10,000	89×120	0.25	12.7	ERWX451LGC103MFC0U
	12,000	89×135	0.25	14.1	ERWX451LGC123MFD5U
	15,000	89×165	0.25	17.2	ERWX451LGC153MFG5U
	18,000	89×200	0.25	20.1	ERWX451LGC183MFL0U
	20,000	100×200	0.25	22.6	ERWX451LGC203MGL0U
	25,000	100×240	0.25	26.8	ERWX451LGC253MGQ0U
29,000	100×270	0.25	29.9	ERWX451LGC293MGT0U	

◆RATED RIPPLE CURRENT MULTIPLIERS

● Frequency Multipliers

Frequency (Hz)	50	120	300	1k	3k
Coefficient	0.8	1.0	1.1	1.2	1.2

The deterioration of aluminum electrolytic capacitors accelerates their life due to the internal heating produced by ripple current. For details, refer to Section "5-3 Ripple Current Effect on Lifetime" in the catalog, Technical Note.

Also, for the RWX series capacitors, using them at operating voltage less than their rated voltage can extend their lifetime. For details, please contact a representative of Nippon Chemi-Con.

RWK Series

- Downsized and high ripple current from RWH series
- Endurance with ripple current : 5,000 hours at 85°C
- RoHS2 Compliant

RWK

↑
Downsized
RWH



◆ SPECIFICATIONS

Items	Characteristics						
Category	-40 to +85°C						
Temperature Range							
Rated Voltage Range	350 to 450V _{dc}						
Capacitance Tolerance	±20% (M) (at 20°C, 120Hz)						
Leakage Current	I=0.02CV or 5mA, whichever is smaller. Where, I : Max. leakage current (μA), C : Nominal capacitance (μF), V : Rated voltage (V) (at 20°C after 5 minutes)						
Dissipation Factor (tan δ)	0.15 max. (at 20°C, 120Hz)						
Low Temperature Characteristics	Capacitance change $C(-25^{\circ}\text{C})/C(+20^{\circ}\text{C}) \geq 0.7$ (at 120Hz)						
Insulation Resistance	When measured between the terminals that are connected to each other and to the mounting clamp on the insulating sleeve covering the case by using an insulation resistance meter of 500V _{dc} , the insulation resistance shall not be less than 100MΩ.						
Insulation Withstanding Voltage	When a voltage of 2,000V _{ac} is applied for 1 minute between the terminals that are connected to each other and to the mounting clamp on the insulating sleeve covering the case, there shall not be electrical damage.						
Endurance	The following specifications shall be satisfied when the capacitors are restored to 20°C after subjected to DC voltage with the rated ripple current is applied (the peak voltage shall not exceed the rated voltage) for 5,000 hours at 85°C. <table border="1" style="width: 100%; border-collapse: collapse;"> <tr> <td>Capacitance change</td> <td>≤ ±20% of the initial value</td> </tr> <tr> <td>D.F. (tan δ)</td> <td>≤ 200% of the initial specified value</td> </tr> <tr> <td>Leakage current</td> <td>≤ The initial specified value</td> </tr> </table>	Capacitance change	≤ ±20% of the initial value	D.F. (tan δ)	≤ 200% of the initial specified value	Leakage current	≤ The initial specified value
Capacitance change	≤ ±20% of the initial value						
D.F. (tan δ)	≤ 200% of the initial specified value						
Leakage current	≤ The initial specified value						
Shelf Life	The following specifications shall be satisfied when the capacitors are restored to 20°C after exposing them for 500 hours at 85°C without voltage applied. Before the measurement, the capacitor shall be preconditioned by applying voltage according to Item 4.1 of JIS C 5101-4. <table border="1" style="width: 100%; border-collapse: collapse;"> <tr> <td>Capacitance change</td> <td>≤ ±20% of the initial value</td> </tr> <tr> <td>D.F. (tan δ)</td> <td>≤ 200% of the initial specified value</td> </tr> <tr> <td>Leakage current</td> <td>≤ The initial specified value</td> </tr> </table>	Capacitance change	≤ ±20% of the initial value	D.F. (tan δ)	≤ 200% of the initial specified value	Leakage current	≤ The initial specified value
Capacitance change	≤ ±20% of the initial value						
D.F. (tan δ)	≤ 200% of the initial specified value						
Leakage current	≤ The initial specified value						

◆ DIMENSIONS (Screw-Mount) [mm]

● Terminal Code : LG

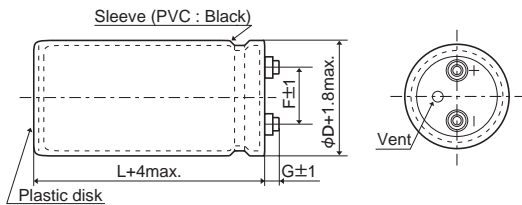

φ63.5, φ76.2 : G=6
φ89 : G=4

● Mounting Clamp Code : B

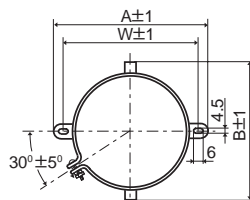

φD	A	B	W	F
63.5	90.0	76.0	80.0	28.0
76.2	104.5	90.0	93.5	31.5

● Mounting Clamp Code : C

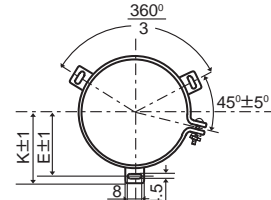

φD	E	K	F	J
63.5	38.1	43.5	28.0	14.0
76.2	44.5	50.0	31.5	14.0
89	50.8	56.5	31.5	16.0

<Screw specifications>

Plus hexagon-headed screw :M5×0.8×10

Maximum screw tightening torque :3.23Nm

* The screw and the mounting clamp are separately supplied and not attached to the product.

◆ PART NUMBERING SYSTEM

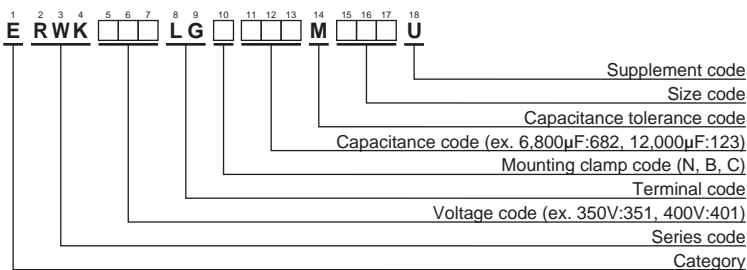

Please refer to "Product code guide (screw-mount terminal type)"



RWK Series

◆STANDARD RATINGS

WV (V _{dc})	Cap (μF)	Case size φD×L(mm)	tan δ	Rated ripple current (Arms/85°C, 120Hz)	Part No.
350	3,900	63.5 × 105	0.15	18.1	ERWK351LGC392MDA5U
	4,700	63.5 × 125	0.15	21.5	ERWK351LGC472MDC5U
	5,600	63.5 × 145	0.15	25.0	ERWK351LGC562MDE5U
	5,600	76.2 × 105	0.15	23.5	ERWK351LGC562MEA5U
	6,800	63.5 × 185	0.15	30.8	ERWK351LGC682MDJ5U
	6,800	76.2 × 125	0.15	27.9	ERWK351LGC682MEC5U
	8,200	76.2 × 145	0.15	32.7	ERWK351LGC822MEE5U
	10,000	76.2 × 185	0.15	40.3	ERWK351LGC103MEJ5U
	10,000	89 × 130	0.15	34.4	ERWK351LGC103MFD0U
375	12,000	89 × 150	0.15	40.1	ERWK351LGC123MFF0U
	3,300	63.5 × 105	0.15	16.6	ERWK3H1LGC332MDA5U
	3,900	63.5 × 125	0.15	19.4	ERWK3H1LGC392MDC5U
	4,700	63.5 × 145	0.15	22.8	ERWK3H1LGC472MDE5U
	4,700	76.2 × 105	0.15	21.4	ERWK3H1LGC472MEA5U
	5,600	76.2 × 125	0.15	25.2	ERWK3H1LGC562MEC5U
	6,800	63.5 × 185	0.15	30.7	ERWK3H1LGC682MDJ5U
	6,800	76.2 × 145	0.15	29.6	ERWK3H1LGC682MEE5U
	6,800	89 × 110	0.15	26.3	ERWK3H1LGC682MFB0U
	8,200	89 × 130	0.15	31.0	ERWK3H1LGC822MFD0U
	10,000	76.2 × 185	0.15	40.0	ERWK3H1LGC103MEJ5U
	10,000	89 × 150	0.15	36.4	ERWK3H1LGC103MFF0U
12,000	89 × 190	0.15	44.3	ERWK3H1LGC123MFK0U	

WV (V _{dc})	Cap (μF)	Case size φD×L(mm)	tan δ	Rated ripple current (Arms/85°C, 120Hz)	Part No.
400	3,300	63.5 × 105	0.15	16.6	ERWK401LGC332MDA5U
	3,900	63.5 × 125	0.15	19.4	ERWK401LGC392MDC5U
	4,700	63.5 × 145	0.15	22.8	ERWK401LGC472MDE5U
	4,700	76.2 × 105	0.15	21.4	ERWK401LGC472MEA5U
	5,600	76.2 × 125	0.15	25.2	ERWK401LGC562MEC5U
	6,800	76.2 × 145	0.15	29.6	ERWK401LGC682MEE5U
	8,200	89 × 130	0.15	31.0	ERWK401LGC822MFD0U
	10,000	89 × 150	0.15	36.9	ERWK401LGC103MFF0U
	12,000	89 × 190	0.15	44.3	ERWK401LGC123MFK0U
450	2,700	63.5 × 105	0.15	15.0	ERWK451LGC272MDA5U
	3,300	63.5 × 125	0.15	18.0	ERWK451LGC332MDC5U
	3,900	63.5 × 145	0.15	20.9	ERWK451LGC392MDE5U
	3,900	76.2 × 105	0.15	19.6	ERWK451LGC392MEA5U
	4,700	63.5 × 185	0.15	25.6	ERWK451LGC472MDJ5U
	4,700	76.2 × 125	0.15	23.2	ERWK451LGC472MEC5U
	5,600	76.2 × 145	0.15	27.0	ERWK451LGC562MEE5U
	6,800	89 × 130	0.15	28.3	ERWK451LGC682MFD0U
	8,200	89 × 150	0.15	33.1	ERWK451LGC822MFF0U
	10,000	89 × 190	0.15	40.6	ERWK451LGC103MFK0U

◆RATED RIPPLE CURRENT MULTIPLIERS

● Frequency Multipliers

Frequency (Hz)	50	120	300	1k	3k
Coefficient	0.8	1.0	1.1	1.3	1.4

The deterioration of aluminum electrolytic capacitors accelerates their life due to the internal heating produced by ripple current. For details, refer to Section "5-3 Ripple Current Effect on Lifetime" in the catalog, Technical Note.

Also, for the RWK series capacitors, using them at operating voltage less than their rated voltage can extend their lifetime. For details, please contact a representative of Nippon Chemi-Con.

RWH Series

- Downsized and high ripple current from RWF series
- Endurance with ripple current : 5,000 hours at 85°C
- RoHS2 Compliant

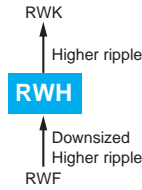

◆ SPECIFICATIONS

Items	Characteristics								
Category									
Temperature Range	-25 to +85°C								
Rated Voltage Range	350 to 450V _{dc}								
Capacitance Tolerance	±20% (M) (at 20°C, 120Hz)								
Leakage Current	I=0.02CV or 5mA, whichever is smaller. Where, I : Max. leakage current (μA), C : Nominal capacitance (μF), V : Rated voltage (V) (at 20°C after 5 minutes)								
Dissipation Factor (tan δ)	0.25 max. (at 20°C, 120Hz)								
Low Temperature Characteristics	Capacitance change $C(-25^{\circ}\text{C})/C(+20^{\circ}\text{C}) \geq 0.7$ (at 120Hz)								
Insulation Resistance	When measured between the terminals that are connected to each other and to the mounting clamp on the insulating sleeve covering the case by using an insulation resistance meter of 500V _{dc} , the insulation resistance shall not be less than 100MΩ.								
Insulation Withstanding Voltage	When a voltage of 2,000V _{ac} is applied for 1 minute between the terminals that are connected to each other and to the mounting clamp on the insulating sleeve covering the case, there shall not be electrical damage.								
Endurance	The following specifications shall be satisfied when the capacitors are restored to 20°C after subjected to DC voltage with the rated ripple current is applied (the peak voltage shall not exceed the rated voltage) for 5,000 hours at 85°C. <table border="1" style="width: 100%; border-collapse: collapse;"> <tr> <td>Capacitance change</td> <td>≤ ±20% of the initial value</td> </tr> <tr> <td>D.F. (tan δ)</td> <td>≤ 200% of the initial specified value</td> </tr> <tr> <td>Leakage current</td> <td>≤ The initial specified value</td> </tr> </table>	Capacitance change	≤ ±20% of the initial value	D.F. (tan δ)	≤ 200% of the initial specified value	Leakage current	≤ The initial specified value		
Capacitance change	≤ ±20% of the initial value								
D.F. (tan δ)	≤ 200% of the initial specified value								
Leakage current	≤ The initial specified value								
Useful life	The following specifications shall be satisfied when the capacitors are restored to 20°C after subjected to DC voltage with the rated ripple current is applied (the peak voltage shall not exceed the rated voltage) for 8,000 hours at 85°C. <table border="1" style="width: 100%; border-collapse: collapse;"> <tr> <td>Capacitance change</td> <td>≤ ±30% of the initial value</td> </tr> <tr> <td>D.F. (tan δ)</td> <td>≤ 300% of the initial specified value</td> </tr> <tr> <td>Leakage current</td> <td>≤ The initial specified value</td> </tr> <tr> <td>Failure rate</td> <td>≤ 1%</td> </tr> </table>	Capacitance change	≤ ±30% of the initial value	D.F. (tan δ)	≤ 300% of the initial specified value	Leakage current	≤ The initial specified value	Failure rate	≤ 1%
Capacitance change	≤ ±30% of the initial value								
D.F. (tan δ)	≤ 300% of the initial specified value								
Leakage current	≤ The initial specified value								
Failure rate	≤ 1%								
Shelf Life	The following specifications shall be satisfied when the capacitors are restored to 20°C after exposing them for 500 hours at 85°C without voltage applied. Before the measurement, the capacitor shall be preconditioned by applying voltage according to Item 4.1 of JIS C 5101-4. <table border="1" style="width: 100%; border-collapse: collapse;"> <tr> <td>Capacitance change</td> <td>≤ ±20% of the initial value</td> </tr> <tr> <td>D.F. (tan δ)</td> <td>≤ 200% of the initial specified value</td> </tr> <tr> <td>Leakage current</td> <td>≤ The initial specified value</td> </tr> </table>	Capacitance change	≤ ±20% of the initial value	D.F. (tan δ)	≤ 200% of the initial specified value	Leakage current	≤ The initial specified value		
Capacitance change	≤ ±20% of the initial value								
D.F. (tan δ)	≤ 200% of the initial specified value								
Leakage current	≤ The initial specified value								

◆ DIMENSIONS (Screw-Mount) [mm]

● Terminal Code : LG

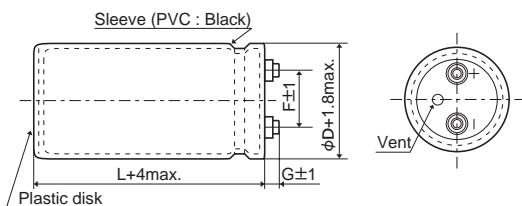

φ63.5, φ76.2 : G=6
φ89 : G=4

● Mounting Clamp Code : B

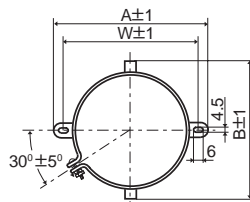

φD	A	B	W	F
63.5	90.0	76.0	80.0	28.0
76.2	104.5	90.0	93.5	31.5

● Mounting Clamp Code : C

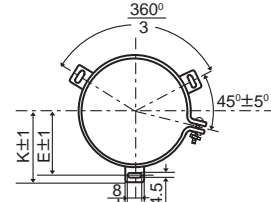

φD	E	K	F	J
63.5	38.1	43.5	28.0	14.0
76.2	44.5	50.0	31.5	14.0
89	50.8	56.5	31.5	16.0

<Screw specifications>

Plus hexagon-headed screw : M5×0.8×10

Maximum screw tightening torque : 3.23Nm

* The screw and the mounting clamp are separately supplied and not attached to the product.

◆ PART NUMBERING SYSTEM

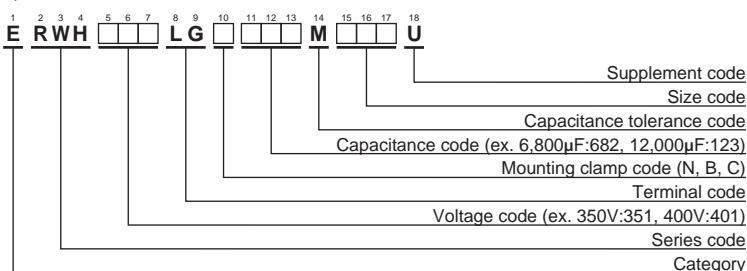

Please refer to "Product code guide (screw-mount terminal type)"



RWH Series

◆ **STANDARD RATINGS**

WV (V _{dc})	Cap (μF)	Case size φD×L(mm)	tan δ	Rated ripple current (Arms/85°C, 120Hz)	Part No.	WV (V _{dc})	Cap (μF)	Case size φD×L(mm)	tan δ	Rated ripple current (Arms/85°C, 120Hz)	Part No.	
350	4,700	63.5 × 105	0.25	16.3	ERWH351LGC472MDA5U	400	8,200	76.2 × 135	0.25	26.5	ERWH401LGC822MED5U	
	5,600	63.5 × 125	0.25	19.2	ERWH351LGC562MDC5U		10,000	76.2 × 160	0.25	31.6	ERWH401LGC103MEG0U	
	6,800	63.5 × 145	0.25	22.6	ERWH351LGC682MDE5U		10,000	89 × 130	0.25	28.3	ERWH401LGC103MFD0U	
	6,800	76.2 × 105	0.25	21.7	ERWH351LGC682MEA5U		12,000	89 × 150	0.25	33.0	ERWH401LGC123MFF0U	
	8,200	63.5 × 165	0.25	26.3	ERWH351LGC822MDG5U		15,000	89 × 180	0.25	39.9	ERWH401LGC153MFJ0U	
	8,200	76.2 × 120	0.25	25.2	ERWH351LGC822MEC0U		450	3,300	63.5 × 105	0.25	13.6	ERWH451LGC332MDA5U
	10,000	76.2 × 140	0.25	29.8	ERWH351LGC103MEE0U			3,900	63.5 × 125	0.25	16.0	ERWH451LGC392MDC5U
	12,000	76.2 × 165	0.25	35.1	ERWH351LGC123MEG5U			4,700	63.5 × 145	0.25	18.7	ERWH451LGC472MDE5U
	15,000	89 × 155	0.25	37.5	ERWH351LGC153MFF5U			4,700	76.2 × 105	0.25	18.0	ERWH451LGC472MEA5U
18,000	89 × 180	0.25	43.8	ERWH351LGC183MFJ0U	5,600	63.5 × 165		0.25	21.7	ERWH451LGC562MDG5U		
400	3,900	63.5 × 100	0.25	14.5	ERWH401LGC392MDA0U	5,600		76.2 × 120	0.25	20.8	ERWH451LGC562MEC0U	
	4,700	63.5 × 120	0.25	17.2	ERWH401LGC472MDC0U	6,800		76.2 × 140	0.25	24.5	ERWH451LGC682MEE0U	
	5,600	63.5 × 135	0.25	19.8	ERWH401LGC562MDD5U	8,200		76.2 × 165	0.25	29.0	ERWH451LGC822MEG5U	
	5,600	76.2 × 105	0.25	19.7	ERWH401LGC562MEA5U	8,200		89 × 135	0.25	26.1	ERWH451LGC822MFD5U	
	6,800	63.5 × 160	0.25	23.5	ERWH401LGC682MDG0U	10,000	89 × 155	0.25	30.5	ERWH451LGC103MFF5U		
	6,800	76.2 × 115	0.25	22.5	ERWH401LGC682MEB5U	12,000	89 × 190	0.25	36.6	ERWH451LGC123MFK0U		

◆ **RATED RIPPLE CURRENT MULTIPLIERS**

● Frequency Multipliers

Frequency (Hz)	50	120	300	1k	3k
Coefficient	0.8	1.0	1.1	1.3	1.4

The deterioration of aluminum electrolytic capacitors accelerates their life due to the internal heating produced by ripple current. For details, refer to Section "5-3 Ripple Current Effect on Lifetime" in the catalog, Technical Note.

Also, for the RWH series capacitors, using them at operating voltage less than their rated voltage can extend their lifetime. For details, please contact a representative of Nippon Chemi-Con.

◆ **USEFUL LIFE**

Useful life depending on the ambient temperature Tx under ripple current operating conditions

Io : Rated ripple current (Arms/85°C, 120Hz)
Ix : Operating ripple current (Arms/120Hz)

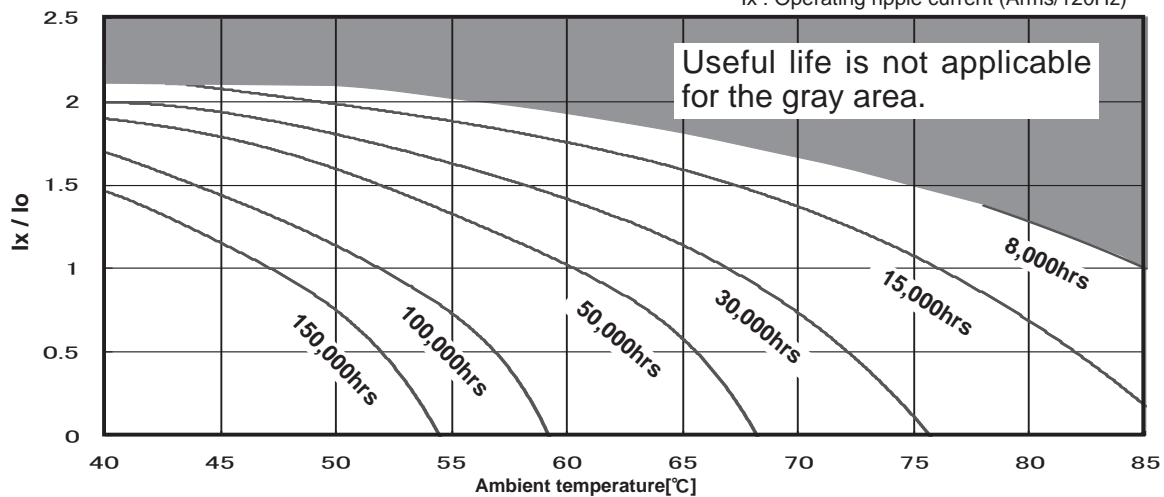

◆ **Warning !**

Useful life shall indicate the end of the life time without exceeding the specified failure rate. It's generally known that Aluminum Electrolytic Capacitors have wear-out failure mode with gradual deterioration of the electrical parameters and should have large number of the failure rate at the end of life. The useful life time is specified by a certain failure rate. It's not a guaranteed specification.

Generally the maximum life time is 15 years (131,000hours) considering sealing material deteriorate. When a longer life time is required for your application, please consult us.

RWF Series

- High ripple capability
- Endurance with ripple current : 5,000 hours at 85°C
- Wide range of case sizes from $\phi 50$ to $\phi 100$
- RoHS2 Compliant

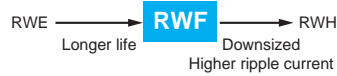

SPECIFICATIONS

Items	Characteristics						
Category							
Temperature Range	-25 to +85°C						
Rated Voltage Range	350 to 450V _{dc}						
Capacitance Tolerance	±20% (M) (at 20°C, 120Hz)						
Leakage Current	I=0.02CV or 5mA, whichever is smaller. Where, I : Max. leakage current (μA), C : Nominal capacitance (μF), V : Rated voltage (V) (at 20°C after 5 minutes)						
Dissipation Factor (tan δ)	0.25 max. (at 20°C, 120Hz)						
Low Temperature Characteristics	Capacitance change $C(-25°C)/C(+20°C) \geq 0.7$ (at 120Hz)						
Insulation Resistance	When measured between the terminals that are connected to each other and to the mounting clamp on the insulating sleeve covering the case by using an insulation resistance meter of 500V _{dc} , the insulation resistance shall not be less than 100MΩ.						
Insulation Withstanding Voltage	When a voltage of 2,000V _{ac} is applied for 1 minute between the terminals that are connected to each other and to the mounting clamp on the insulating sleeve covering the case, there shall not be electrical damage.						
Endurance	The following specifications shall be satisfied when the capacitors are restored to 20°C after subjected to DC voltage with the rated ripple current is applied (the peak voltage shall not exceed the rated voltage) for 5,000 hours at 85°C. <table border="1" style="width:100%; border-collapse: collapse;"> <tr> <td>Capacitance change</td> <td>≤ ±20% of the initial value</td> </tr> <tr> <td>D.F. (tan δ)</td> <td>≤ 200% of the initial specified value</td> </tr> <tr> <td>Leakage current</td> <td>≤ The initial specified value</td> </tr> </table>	Capacitance change	≤ ±20% of the initial value	D.F. (tan δ)	≤ 200% of the initial specified value	Leakage current	≤ The initial specified value
Capacitance change	≤ ±20% of the initial value						
D.F. (tan δ)	≤ 200% of the initial specified value						
Leakage current	≤ The initial specified value						
Shelf Life	The following specifications shall be satisfied when the capacitors are restored to 20°C after exposing them for 500 hours at 85°C without voltage applied. Before the measurement, the capacitor shall be preconditioned by applying voltage according to Item 4.1 of JIS C 5101-4. <table border="1" style="width:100%; border-collapse: collapse;"> <tr> <td>Capacitance change</td> <td>≤ ±20% of the initial value</td> </tr> <tr> <td>D.F. (tan δ)</td> <td>≤ 200% of the initial specified value</td> </tr> <tr> <td>Leakage current</td> <td>≤ The initial specified value</td> </tr> </table>	Capacitance change	≤ ±20% of the initial value	D.F. (tan δ)	≤ 200% of the initial specified value	Leakage current	≤ The initial specified value
Capacitance change	≤ ±20% of the initial value						
D.F. (tan δ)	≤ 200% of the initial specified value						
Leakage current	≤ The initial specified value						

DIMENSIONS (Screw-Mount) [mm]

● Terminal Code : LG

● Mounting Clamp Code : B

● Mounting Clamp Code : C

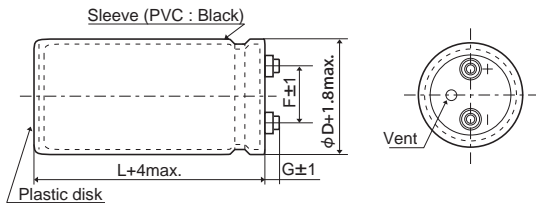

- φ50 & φ63.5 : G=6
- φ76.2 & φ89 : G=5
- φ100 : G=10

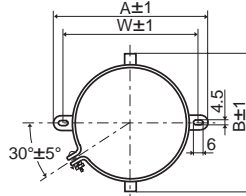

φD	A	B	W	F
50	78.0	64.0	68.0	22.4
63.5	90.0	76.0	80.0	28.0
76.2	104.5	90.0	93.5	31.5

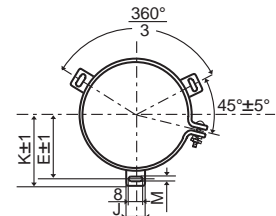

φD	E	K	M	F	J
50	32.5	37.0	4.5	22.4	14.0
63.5	38.1	43.5	4.5	28.0	14.0
76.2	44.5	50.0	4.5	31.5	14.0
89	50.8	56.5	4.5	31.5	16.0
100	56.5	63.4	5.5	41.5	18.0

<Screw specifications>

to φ89 Plus hexagon-headed screw :M5×0.8×10
Maximum screw tightening torque :3.23Nm

φ100 Cross-recessed head (phillips) screw : M8×1.25×16
Spring washer,Washer
Maximum screw tightening torque :6.31Nm

* The screw and the mounting clamp are separately supplied and not attached to the product.

PART NUMBERING SYSTEM

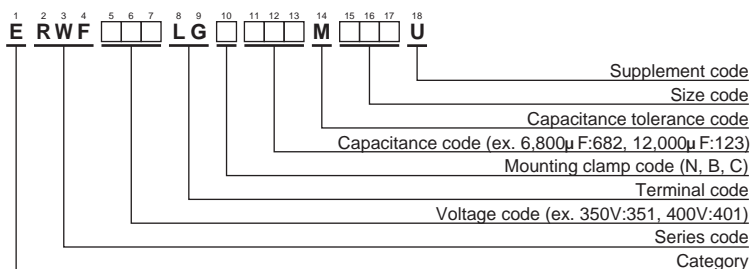

Please refer to "Product code guide (screw-mount terminal type)"



RWF Series

◆ **STANDARD RATINGS**

WV (V _{dc})	Cap (μF)	Case size φD×L(mm)	tan δ	Rated ripple current (Arms/ 85°C, 120Hz)	Part No.	WV (V _{dc})	Cap (μF)	Case size φD×L(mm)	tan δ	Rated ripple current (Arms/ 85°C, 120Hz)	Part No.	
350	1,200	50 × 60	0.25	4.90	ERWF351LGC122MC60U	400	5,600	63.5 × 190	0.25	18.2	ERWF401LGC562MDK0U	
	1,800	50 × 75	0.25	6.50	ERWF351LGC182MC75U		5,600	76.2 × 130	0.25	16.9	ERWF401LGC562MED0U	
	2,200	50 × 85	0.25	7.50	ERWF351LGC222MC85U		6,800	76.2 × 155	0.25	20.2	ERWF401LGC682MEF5U	
	2,200	50 × 96	0.25	7.70	ERWF351LGC222MC96U		8,200	76.2 × 170	0.25	22.8	ERWF401LGC822MEH0U	
	2,700	50 × 115	0.25	9.30	ERWF351LGC272MCB5U		10,000	89 × 155	0.25	26.6	ERWF401LGC103MFF5U	
	3,300	50 × 130	0.25	10.8	ERWF351LGC332MCD0U		12,000	89 × 170	0.25	30.0	ERWF401LGC123MFH0U	
	3,900	63.5 × 115	0.25	12.1	ERWF351LGC392MDB5U		15,000	100 × 190	0.25	33.7	ERWF401LGC153MGK0U	
	4,700	63.5 × 130	0.25	14.0	ERWF351LGC472MDD0U		18,000	100 × 220	0.25	37.4	ERWF401LGC183MGN0U	
	5,600	63.5 × 155	0.25	16.6	ERWF351LGC562MDF5U		450	820	50 × 60	0.25	4.00	ERWF451LGC821MC60U
	5,600	76.2 × 115	0.25	16.1	ERWF351LGC562MEB5U			1,000	50 × 75	0.25	4.80	ERWF451LGC102MC75U
	6,800	63.5 × 190	0.25	20.0	ERWF351LGC682MDK0U			1,200	50 × 85	0.25	5.60	ERWF451LGC122MC85U
	6,800	76.2 × 130	0.25	18.6	ERWF351LGC682MED0U			1,200	50 × 96	0.25	5.70	ERWF451LGC122MC96U
	8,200	76.2 × 155	0.25	22.2	ERWF351LGC822MEF5U			1,500	50 × 96	0.25	6.30	ERWF451LGC152MC96U
	10,000	76.2 × 170	0.25	25.2	ERWF351LGC103MEH0U			1,800	50 × 115	0.25	7.60	ERWF451LGC182MCB5U
	12,000	89 × 155	0.25	29.1	ERWF351LGC123MFF5U			2,200	50 × 130	0.25	8.80	ERWF451LGC222MGR0U
	15,000	89 × 190	0.25	35.7	ERWF351LGC153MFK0U			2,700	63.5 × 115	0.25	10.1	ERWF451LGC272MDB5U
18,000	100 × 190	0.25	36.9	ERWF351LGC183MGK0U	3,300	63.5 × 130		0.25	11.7	ERWF451LGC332MDD0U		
22,000	100 × 250	0.25	46.1	ERWF351LGC223MGR0U	3,900	63.5 × 155		0.25	13.8	ERWF451LGC392MDF5U		
400	1,000	50 × 60	0.25	4.40	ERWF401LGC102MC60U	3,900		76.2 × 115	0.25	13.4	ERWF451LGC392MEB5U	
	1,500	50 × 75	0.25	5.90	ERWF401LGC152MC75U	4,700		63.5 × 190	0.25	16.7	ERWF451LGC472MDK0U	
	1,800	50 × 85	0.25	6.80	ERWF401LGC182MC85U	4,700		76.2 × 130	0.25	15.5	ERWF451LGC472MED0U	
	1,800	50 × 96	0.25	7.00	ERWF401LGC182MC96U	5,600		76.2 × 155	0.25	18.3	ERWF451LGC562MEF5U	
	2,200	50 × 105	0.25	8.00	ERWF401LGC222MCA5U	6,800		76.2 × 170	0.25	20.7	ERWF451LGC682MEH0U	
	2,700	50 × 130	0.25	9.80	ERWF401LGC272MCD0U	8,200		89 × 155	0.25	24.1	ERWF451LGC822MFF5U	
	3,300	63.5 × 115	0.25	11.1	ERWF401LGC332MDB5U	10,000	89 × 170	0.25	27.8	ERWF451LGC103MFH0U		
	3,900	63.5 × 130	0.25	12.7	ERWF401LGC392MDD0U	12,000	100 × 190	0.25	29.3	ERWF451LGC123MGK0U		
	4,700	63.5 × 155	0.25	15.2	ERWF401LGC472MDF5U	15,000	100 × 250	0.25	37.0	ERWF451LGC153MGR0U		
	4,700	76.2 × 115	0.25	14.7	ERWF401LGC472MEB5U							

◆ **RATED RIPPLE CURRENT MULTIPLIERS**

● Frequency Multipliers

Frequency (Hz)	50	120	300	1k	3k
Coefficient	0.8	1.0	1.1	1.3	1.4

The deterioration of aluminum electrolytic capacitors accelerates their life due to the internal heating produced by ripple current. For details, refer to Section "5-3 Ripple Current Effect on Lifetime" in the catalog, Technical Note.

Also, for the RWF series capacitors, using them at operating voltage less than their rated voltage can extend their lifetime. For details, please contact a representative of Nippon Chemi-Con.



RWU Series

- Higher capacitance than RWE series.
- Endurance with ripple current: 2,000 hours at 85°C
- Suitable for UPS devices and servo press machines where higher capacitance is required.
- RoHS2 compliant

RWU

Higher capacitance
RWE



SPECIFICATIONS

Items	Characteristics
Category	
Temperature Range	-40 to +85°C
Rated Voltage Range	400 & 450V _{dc}
Capacitance Tolerance	±20% (M) (at 20°C, 120Hz)
Leakage Current	I=0.01CV or 7mA, whichever is smaller. Where, I : Max. leakage current (μA), C : Nominal capacitance (μF), V : Rated voltage (V) (at 20°C after 5 minutes)
Dissipation Factor (tan δ)	0.25 max. (at 20°C, 120Hz)
Low Temperature Characteristics	Capacitance change $C(-25°C)/C(+20°C) \geq 0.7$ (at 120Hz)
Insulation Resistance	When measured between the terminals that are connected to each other and to the mounting clamp on the insulating sleeve covering the case by using an insulation resistance meter of 500V _{dc} , the insulation resistance shall not be less than 100MΩ.
Insulation Withstanding Voltage	When a voltage of 2,000V _{ac} is applied for 1 minute between the terminals that are connected to each other and to the mounting clamp on the insulating sleeve covering the case, there shall not be electrical damage.
Endurance	The following specifications shall be satisfied when the capacitors are restored to 20°C after subjected to DC voltage with the rated ripple current is applied (the peak voltage shall not exceed the rated voltage) for 2,000 hours at 85°C.
	Capacitance change $\leq \pm 20\%$ of the initial value
	D.F. (tan δ) $\leq 200\%$ of the initial specified value
	Leakage current \leq The initial specified value
Shelf Life	The following specifications shall be satisfied when the capacitors are restored to 20°C after exposing them for 500 hours at 85°C without voltage applied. Before the measurement, the capacitor shall be preconditioned by applying voltage according to Item 4.1 of JIS C 5101-4.
	Capacitance change $\leq \pm 20\%$ of the initial value
	D.F. (tan δ) $\leq 200\%$ of the initial specified value
	Leakage current \leq The initial specified value

DIMENSIONS (Screw-Mount) [mm]

Terminal Code : LG

Mounting Clamp Code : B

Mounting Clamp Code : C : Standard

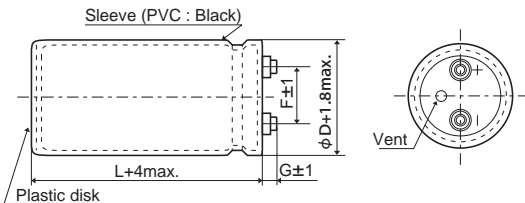

- φ 63.5 : G=6
- φ 76.2 & φ 89 : G=5
- φ 100 : G=10

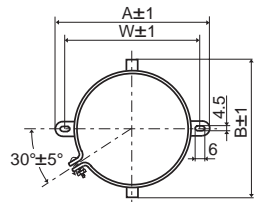

φD	A	B	W	F
63.5	90.0	76.0	80.0	28.0
76.2	104.5	90.0	93.5	31.5

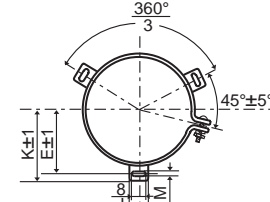

φD	E	K	M	F	J
63.5	38.1	43.5	4.5	28.0	14.0
76.2	44.5	50.0	4.5	31.5	14.0
89	50.8	56.5	4.5	31.5	16.0
100	56.5	63.4	5.5	41.5	18.0

<Screw specifications>

to φ89 Plus hexagon-headed screw :M5×0.8×10
Maximum screw tightening torque :3.23Nm

φ100 Cross-recessed head (phillips) screw : M8×1.25×16
Spring washer, Washer
Maximum screw tightening torque :6.31Nm

* The screw and the mounting clamp are separately supplied and not attached to the product.

PART NUMBERING SYSTEM

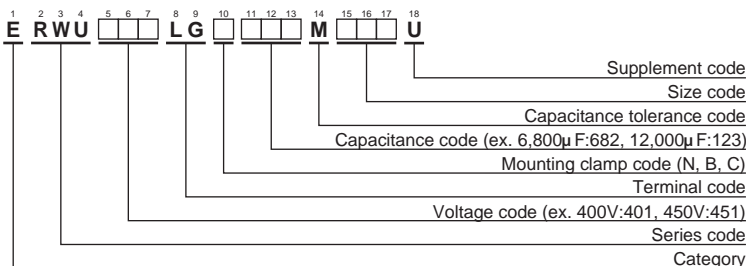

Please refer to "Product code guide (screw-mount terminal type)"



RWU Series

◆ **STANDARD RATINGS**

WV (V _{dc})	Cap (μF)	Case size φD×L(mm)	tan δ	Rated ripple current (Arms/85°C,120Hz)	Part No.
400	2,200	63.5×60	0.25	5.2	ERWU401LGC222MD60U
	2,700	63.5×70	0.25	6.1	ERWU401LGC272MD70U
	3,300	63.5×80	0.25	7.2	ERWU401LGC332MD80U
	3,900	63.5×85	0.25	8.0	ERWU401LGC392MD85U
	4,700	63.5×100	0.25	9.4	ERWU401LGC472MDA0U
	5,600	63.5×115	0.25	10.0	ERWU401LGC562MDB5U
	6,800	63.5×130	0.25	11.7	ERWU401LGC682MDD0U
	8,200	63.5×155	0.25	13.1	ERWU401LGC822MDF5U
	8,200	76.2×110	0.25	12.5	ERWU401LGC822MEB0U
	10,000	76.2×130	0.25	14.8	ERWU401LGC103MED0U
	12,000	76.2×150	0.25	16.6	ERWU401LGC123MEF0U
	15,000	89×140	0.25	16.6	ERWU401LGC153MFE0U
	18,000	89×165	0.25	19.1	ERWU401LGC183MFG5U
	20,000	89×200	0.25	21.9	ERWU401LGC203MFL0U
	20,000	100×160	0.25	21.2	ERWU401LGC203MGG0U
	25,000	100×210	0.25	26.1	ERWU401LGC253MGM0U
30,000	100×235	0.25	29.7	ERWU401LGC303MGP5U	
35,000	100×270	0.25	33.8	ERWU401LGC353MGT0U	

WV (V _{dc})	Cap (μF)	Case size φD×L(mm)	tan δ	Rated ripple current (Arms/85°C,120Hz)	Part No.
450	2,200	63.5×70	0.25	5.3	ERWU451LGC222MD70U
	2,700	63.5×75	0.25	6.1	ERWU451LGC272MD75U
	3,300	63.5×90	0.25	7.3	ERWU451LGC332MD90U
	3,900	63.5×100	0.25	8.3	ERWU451LGC392MDA0U
	4,700	63.5×115	0.25	9.6	ERWU451LGC472MDB5U
	5,600	63.5×130	0.25	10.3	ERWU451LGC562MDD0U
	6,800	63.5×150	0.25	12.1	ERWU451LGC682MDF0U
	8,200	76.2×130	0.25	12.9	ERWU451LGC822MED0U
	10,000	76.2×150	0.25	15.1	ERWU451LGC103MEF0U
	12,000	76.2×175	0.25	17.1	ERWU451LGC123MEH5U
	12,000	89×135	0.25	14.1	ERWU451LGC123MFD5U
	15,000	89×160	0.25	17.0	ERWU451LGC153MFG0U
	18,000	89×205	0.25	20.3	ERWU451LGC183MFL5U
	20,000	89×230	0.25	22.5	ERWU451LGC203MFP0U
	25,000	100×230	0.25	26.1	ERWU451LGC253MGP0U
	30,000	100×270	0.25	30.5	ERWU451LGC303MGT0U

◆ **RATED RIPPLE CURRENT MULTIPLIERS**

● Frequency Multipliers

Frequency (Hz)	50	120	300	1k	3k
Coefficient	0.8	1.0	1.1	1.2	1.2

The deterioration of aluminum electrolytic capacitors accelerates their life due to the internal heating produced by ripple current. For details, refer to Section "5-3 Ripple Current Effect on Lifetime" in the catalog, Technical Note.

Also, for the RWU series capacitors, using them at operating voltage less than their rated voltage can extend their lifetime. For details, please contact a representative of Nippon Chemi-Con.

RWJ Series

- Downsized and high ripple current from RWR series
- Endurance with ripple current : 2,000 hours at 85°C
- RoHS2 Compliant

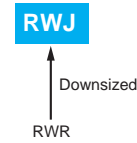

◆ SPECIFICATIONS

Items	Characteristics						
Category							
Temperature Range	-40 to +85°C						
Rated Voltage Range	350 to 450V _{dc}						
Capacitance Tolerance	±20% (M) (at 20°C, 120Hz)						
Leakage Current	I=0.02CV or 5mA, whichever is smaller. Where, I : Max. leakage current (μA), C : Nominal capacitance (μF), V : Rated voltage (V) (at 20°C after 5 minutes)						
Dissipation Factor (tan δ)	0.15 max. (at 20°C, 120Hz)						
Low Temperature Characteristics	Capacitance change $C(-25^{\circ}\text{C})/C(+20^{\circ}\text{C}) \geq 0.7$ (at 120Hz)						
Insulation Resistance	When measured between the terminals that are connected to each other and to the mounting clamp on the insulating sleeve covering the case by using an insulation resistance meter of 500V _{dc} , the insulation resistance shall not be less than 100MΩ.						
Insulation Withstanding Voltage	When a voltage of 2,000V _{ac} is applied for 1 minute between the terminals that are connected to each other and to the mounting clamp on the insulating sleeve covering the case, there shall not be electrical damage.						
Endurance	The following specifications shall be satisfied when the capacitors are restored to 20°C after subjected to DC voltage with the rated ripple current is applied (the peak voltage shall not exceed the rated voltage) for 2,000 hours at 85°C. <table border="1" style="width: 100%; border-collapse: collapse;"> <tr> <td>Capacitance change</td> <td>≤ ±20% of the initial value</td> </tr> <tr> <td>D.F. (tan δ)</td> <td>≤ 200% of the initial specified value</td> </tr> <tr> <td>Leakage current</td> <td>≤ The initial specified value</td> </tr> </table>	Capacitance change	≤ ±20% of the initial value	D.F. (tan δ)	≤ 200% of the initial specified value	Leakage current	≤ The initial specified value
Capacitance change	≤ ±20% of the initial value						
D.F. (tan δ)	≤ 200% of the initial specified value						
Leakage current	≤ The initial specified value						
Shelf Life	The following specifications shall be satisfied when the capacitors are restored to 20°C after exposing them for 500 hours at 85°C without voltage applied. Before the measurement, the capacitor shall be preconditioned by applying voltage according to Item 4.1 of JIS C 5101-4. <table border="1" style="width: 100%; border-collapse: collapse;"> <tr> <td>Capacitance change</td> <td>≤ ±20% of the initial value</td> </tr> <tr> <td>D.F. (tan δ)</td> <td>≤ 200% of the initial specified value</td> </tr> <tr> <td>Leakage current</td> <td>≤ The initial specified value</td> </tr> </table>	Capacitance change	≤ ±20% of the initial value	D.F. (tan δ)	≤ 200% of the initial specified value	Leakage current	≤ The initial specified value
Capacitance change	≤ ±20% of the initial value						
D.F. (tan δ)	≤ 200% of the initial specified value						
Leakage current	≤ The initial specified value						

◆ DIMENSIONS (Screw-Mount) [mm]

● Terminal Code : LG

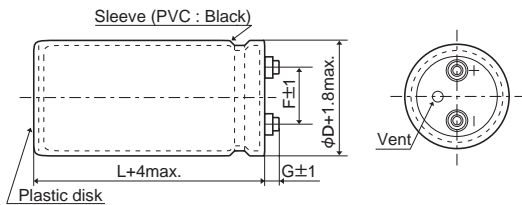

φ63.5, φ76.2 : G=6
φ89 : G=4

● Mounting Clamp Code : B

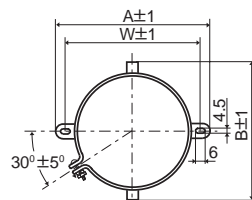

φD	A	B	W	F
63.5	90.0	76.0	80.0	28.0
76.2	104.5	90.0	93.5	31.5

● Mounting Clamp Code : C

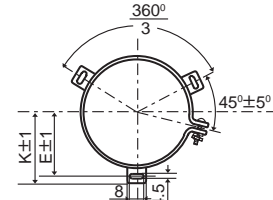

φD	E	K	F	J
63.5	38.1	43.5	28.0	14.0
76.2	44.5	50.0	31.5	14.0
89	50.8	56.5	31.5	16.0

<Screw specifications>

Plus hexagon-headed screw :M5×0.8×10

Maximum screw tightening torque :3.23Nm

* The screw and the mounting clamp are separately supplied and not attached to the product.

◆ PART NUMBERING SYSTEM

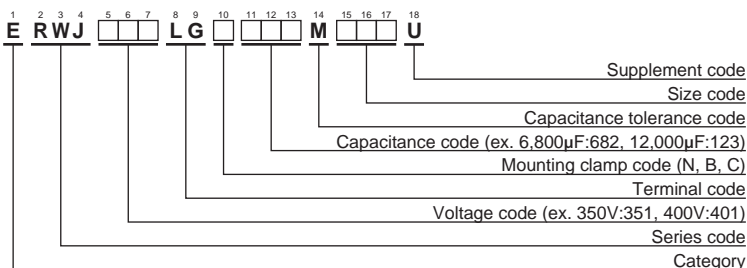

Please refer to "Product code guide (screw-mount terminal type)"



RWJ Series

◆STANDARD RATINGS

WV (V _{dc})	Cap (μF)	Case size φD×L(mm)	tan δ	Rated ripple current (Arms/85°C, 120Hz)	Part No.	WV (V _{dc})	Cap (μF)	Case size φD×L(mm)	tan δ	Rated ripple current (Arms/85°C, 120Hz)	Part No.
350	3,900	63.5 × 105	0.15	18.1	ERWJ351LGC392MDA5U	400	3,300	63.5 × 105	0.15	16.6	ERWJ401LGC332MDA5U
	4,700	63.5 × 125	0.15	21.5	ERWJ351LGC472MDC5U		3,900	63.5 × 125	0.15	19.4	ERWJ401LGC392MDC5U
	5,600	63.5 × 145	0.15	25.0	ERWJ351LGC562MDE5U		4,700	63.5 × 145	0.15	22.8	ERWJ401LGC472MDE5U
	5,600	76.2 × 105	0.15	23.5	ERWJ351LGC562MEA5U		4,700	76.2 × 105	0.15	21.4	ERWJ401LGC472MEA5U
	6,800	63.5 × 185	0.15	30.8	ERWJ351LGC682MDJ5U		5,600	76.2 × 125	0.15	25.2	ERWJ401LGC562MEC5U
	6,800	76.2 × 125	0.15	27.9	ERWJ351LGC682MEC5U		6,800	76.2 × 145	0.15	29.6	ERWJ401LGC682MEE5U
	8,200	76.2 × 145	0.15	32.7	ERWJ351LGC822MEE5U		6,800	89 × 110	0.15	26.3	ERWJ401LGC682MFB0U
	10,000	76.2 × 185	0.15	40.3	ERWJ351LGC103MEJ5U		8,200	89 × 130	0.15	31.0	ERWJ401LGC822MFD0U
	10,000	89 × 130	0.15	34.4	ERWJ351LGC103MFD0U		10,000	89 × 150	0.15	36.5	ERWJ401LGC103MFF0U
12,000	89 × 150	0.15	40.1	ERWJ351LGC123MFF0U	12,000	89 × 190	0.15	44.3	ERWJ401LGC123MFK0U		
375	3,300	63.5 × 105	0.15	16.6	ERWJ3H1LGC332MDA5U	450	2,700	63.5 × 105	0.15	15.0	ERWJ451LGC272MDA5U
	4,700	63.5 × 145	0.15	22.8	ERWJ3H1LGC472MDE5U		3,300	63.5 × 125	0.15	18.0	ERWJ451LGC332MDC5U
	4,700	76.2 × 105	0.15	21.4	ERWJ3H1LGC472MEA5U		3,900	63.5 × 145	0.15	20.9	ERWJ451LGC392MDE5U
	6,800	63.5 × 185	0.15	30.7	ERWJ3H1LGC682MDJ5U		3,900	76.2 × 105	0.15	19.6	ERWJ451LGC392MEA5U
	6,800	89 × 110	0.15	26.3	ERWJ3H1LGC682MFB0U		4,700	63.5 × 185	0.15	25.6	ERWJ451LGC472MDJ5U
	8,200	89 × 130	0.15	31.0	ERWJ3H1LGC822MFD0U		4,700	76.2 × 125	0.15	23.2	ERWJ451LGC472MEC5U
	10,000	76.2 × 185	0.15	40.0	ERWJ3H1LGC103MEJ5U		5,600	76.2 × 145	0.15	27.0	ERWJ451LGC562MEE5U
	10,000	89 × 150	0.15	36.4	ERWJ3H1LGC103MFF0U		5,600	89 × 110	0.15	24.0	ERWJ451LGC562MFB0U
	12,000	89 × 190	0.15	44.3	ERWJ3H1LGC123MFK0U		6,800	89 × 130	0.15	28.3	ERWJ451LGC682MFD0U
						8,200	89 × 150	0.15	33.1	ERWJ451LGC822MFF0U	
						10,000	89 × 190	0.15	40.6	ERWJ451LGC103MFK0U	

◆RATED RIPPLE CURRENT MULTIPLIERS

● Frequency Multipliers

Frequency (Hz)	50	120	300	1k	3k
Coefficient	0.8	1.0	1.1	1.3	1.4

The deterioration of aluminum electrolytic capacitors accelerates their life due to the internal heating produced by ripple current. For details, refer to Section "5-3 Ripple Current Effect on Lifetime" in the catalog, Technical Note.

Also, for the RWJ series capacitors, using them at operating voltage less than their rated voltage can extend their lifetime. For details, please contact a representative of Nippon Chemi-Con.

RWR Series

- Downsized and high ripple current from RWQ series
- Endurance with ripple current : 2,000 hours at 85°C
- RoHS2 Compliant

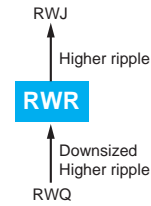

◆ SPECIFICATIONS

Items	Characteristics								
Category									
Temperature Range	-25 to +85°C								
Rated Voltage Range	350 to 450V _{dc}								
Capacitance Tolerance	±20% (M) (at 20°C, 120Hz)								
Leakage Current	I=0.02CV or 5mA, whichever is smaller. Where, I : Max. leakage current (µA), C : Nominal capacitance (µF), V : Rated voltage (V) (at 20°C after 5 minutes)								
Dissipation Factor (tan δ)	0.25 max. (at 20°C, 120Hz)								
Low Temperature Characteristics	Capacitance change $C(-25^{\circ}\text{C})/C(+20^{\circ}\text{C}) \geq 0.7$ (at 120Hz)								
Insulation Resistance	When measured between the terminals that are connected to each other and to the mounting clamp on the insulating sleeve covering the case by using an insulation resistance meter of 500V _{dc} , the insulation resistance shall not be less than 100MΩ.								
Insulation Withstanding Voltage	When a voltage of 2,000V _{ac} is applied for 1 minute between the terminals that are connected to each other and to the mounting clamp on the insulating sleeve covering the case, there shall not be electrical damage.								
Endurance	The following specifications shall be satisfied when the capacitors are restored to 20°C after subjected to DC voltage with the rated ripple current is applied (the peak voltage shall not exceed the rated voltage) for 2,000 hours at 85°C. <table border="1" style="width: 100%; border-collapse: collapse;"> <tr> <td>Capacitance change</td> <td>≤ ±20% of the initial value</td> </tr> <tr> <td>D.F. (tan δ)</td> <td>≤ 300% of the initial specified value</td> </tr> <tr> <td>Leakage current</td> <td>≤ The initial specified value</td> </tr> </table>	Capacitance change	≤ ±20% of the initial value	D.F. (tan δ)	≤ 300% of the initial specified value	Leakage current	≤ The initial specified value		
Capacitance change	≤ ±20% of the initial value								
D.F. (tan δ)	≤ 300% of the initial specified value								
Leakage current	≤ The initial specified value								
Useful life	The following specifications shall be satisfied when the capacitors are restored to 20°C after subjected to DC voltage with the rated ripple current is applied (the peak voltage shall not exceed the rated voltage) for 5,000 hours at 85°C. <table border="1" style="width: 100%; border-collapse: collapse;"> <tr> <td>Capacitance change</td> <td>≤ ±30% of the initial value</td> </tr> <tr> <td>D.F. (tan δ)</td> <td>≤ 300% of the initial specified value</td> </tr> <tr> <td>Leakage current</td> <td>≤ The initial specified value</td> </tr> <tr> <td>Failure rate</td> <td>≤ 1%</td> </tr> </table>	Capacitance change	≤ ±30% of the initial value	D.F. (tan δ)	≤ 300% of the initial specified value	Leakage current	≤ The initial specified value	Failure rate	≤ 1%
Capacitance change	≤ ±30% of the initial value								
D.F. (tan δ)	≤ 300% of the initial specified value								
Leakage current	≤ The initial specified value								
Failure rate	≤ 1%								
Shelf Life	The following specifications shall be satisfied when the capacitors are restored to 20°C after exposing them for 500 hours at 85°C without voltage applied. Before the measurement, the capacitor shall be preconditioned by applying voltage according to Item 4.1 of JIS C 5101-4. <table border="1" style="width: 100%; border-collapse: collapse;"> <tr> <td>Capacitance change</td> <td>≤ ±20% of the initial value</td> </tr> <tr> <td>D.F. (tan δ)</td> <td>≤ 300% of the initial specified value</td> </tr> <tr> <td>Leakage current</td> <td>≤ The initial specified value</td> </tr> </table>	Capacitance change	≤ ±20% of the initial value	D.F. (tan δ)	≤ 300% of the initial specified value	Leakage current	≤ The initial specified value		
Capacitance change	≤ ±20% of the initial value								
D.F. (tan δ)	≤ 300% of the initial specified value								
Leakage current	≤ The initial specified value								

◆ DIMENSIONS (Screw-Mount) [mm]

● Terminal Code : LG

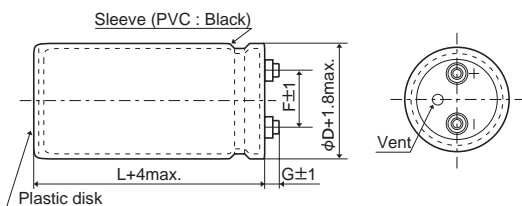

φ63.5, φ76.2 : G=6
φ89 : G=4

● Mounting Clamp Code : B

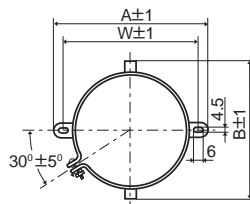

φD	A	B	W	F
63.5	90.0	76.0	80.0	28.0
76.2	104.5	90.0	93.5	31.5

● Mounting Clamp Code : C

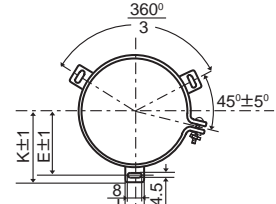

φD	E	K	F	J
63.5	38.1	43.5	28.0	14.0
76.2	44.5	50.0	31.5	14.0
89	50.8	56.5	31.5	16.0

<Screw specifications>

Plus hexagon-headed screw : M5×0.8×10

Maximum screw tightening torque : 3.23Nm

* The screw and the mounting clamp are separately supplied and not attached to the product.

◆ PART NUMBERING SYSTEM

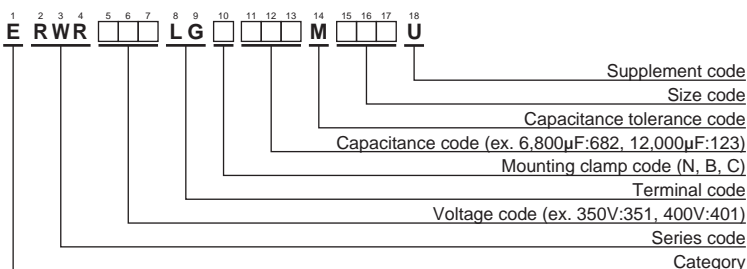

Please refer to "Product code guide (screw-mount terminal type)"



RWRSeries

◆ **STANDARD RATINGS**

WV (V _{dc})	Cap (μF)	Case size φD×L(mm)	tan δ	Rated ripple current (Arms/85°C, 120Hz)	Part No.	WV (V _{dc})	Cap (μF)	Case size φD×L(mm)	tan δ	Rated ripple current (Arms/85°C, 120Hz)	Part No.	
350	3,900	63.5 × 100	0.25	13.7	ERWR351LGC392MDA0U	400	6,800	76.2 × 110	0.25	20.9	ERWR401LGC682MEB0U	
	4,700	63.5 × 100	0.25	15.1	ERWR351LGC472MDA0U		8,200	76.2 × 130	0.25	24.7	ERWR401LGC822MED0U	
	5,600	63.5 × 115	0.25	17.5	ERWR351LGC562MDB5U		10,000	89 × 125	0.25	26.4	ERWR401LGC103MFC5U	
	5,600	76.2 × 100	0.25	18.2	ERWR351LGC562MEA0U		12,000	89 × 145	0.25	30.8	ERWR401LGC123MFE5U	
	6,800	76.2 × 100	0.25	20.1	ERWR351LGC682MEA0U		450	2,700	63.5 × 100	0.25	11.4	ERWR451LGC272MDA0U
	8,200	76.2 × 115	0.25	23.4	ERWR351LGC822MEB5U			3,300	63.5 × 105	0.25	12.9	ERWR451LGC332MDA5U
	10,000	76.2 × 135	0.25	27.7	ERWR351LGC103MED5U			3,900	63.5 × 115	0.25	14.6	ERWR451LGC392MDB5U
	12,000	89 × 125	0.25	28.9	ERWR351LGC123MFC5U			3,900	76.2 × 100	0.25	15.2	ERWR451LGC392MEA0U
15,000	89 × 150	0.25	34.9	ERWR351LGC153MFF0U	4,700	63.5 × 135		0.25	17.2	ERWR451LGC472MDD5U		
400	3,300	63.5 × 100	0.25	12.6	ERWR401LGC332MDA0U	4,700		76.2 × 105	0.25	17.0	ERWR451LGC472MEA5U	
	3,900	63.5 × 100	0.25	13.7	ERWR401LGC392MDA0U	5,600		76.2 × 115	0.25	19.3	ERWR451LGC562MEB5U	
	4,700	63.5 × 115	0.25	16.0	ERWR401LGC472MDB5U	6,800		76.2 × 135	0.25	22.8	ERWR451LGC682MED5U	
	4,700	76.2 × 100	0.25	16.7	ERWR401LGC472MEA0U	8,200	89 × 125	0.25	23.9	ERWR451LGC822MFC5U		
	5,600	63.5 × 130	0.25	18.4	ERWR401LGC562MDD0U	10,000	89 × 150	0.25	28.5	ERWR451LGC103MFF0U		

◆ **RATED RIPPLE CURRENT MULTIPLIERS**

● Frequency Multipliers

Frequency (Hz)	50	120	300	1k	3k
Coefficient	0.8	1.0	1.1	1.3	1.4

The deterioration of aluminum electrolytic capacitors accelerates their life due to the internal heating produced by ripple current. For details, refer to Section "5-3 Ripple Current Effect on Lifetime" in the catalog, Technical Note.

Also, for the RWR series capacitors, using them at operating voltage less than their rated voltage can extend their lifetime. For details, please contact a representative of Nippon Chemi-Con.

◆ **USEFUL LIFE**

Useful life depending on the ambient temperature Tx under ripple current operating conditions

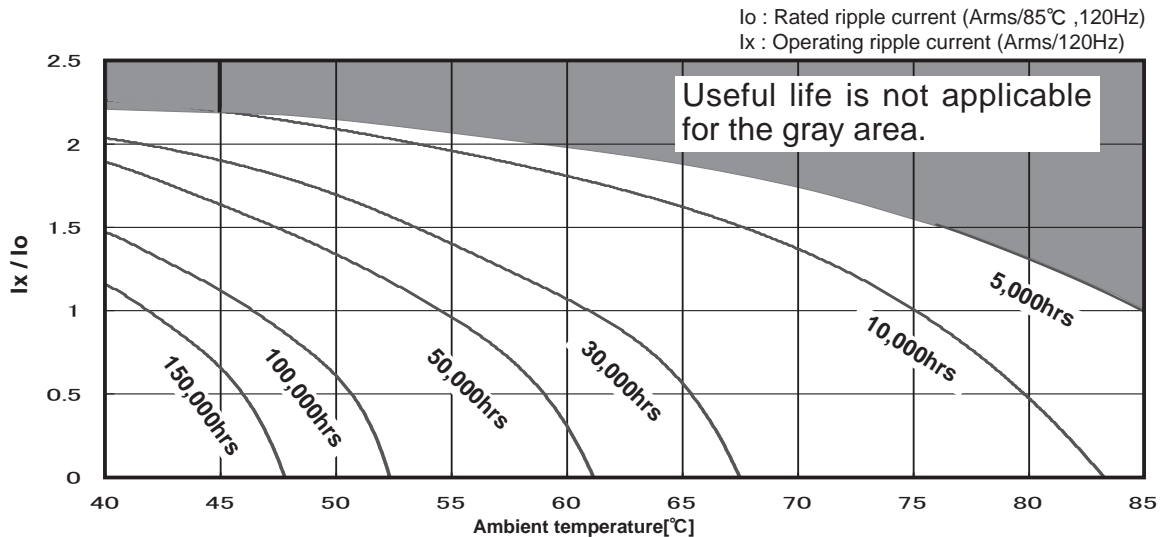

◆ **Warning !**

Useful life shall indicate the end of the life time without exceeding the specified failure rate. It's generally known that Aluminum Electrolytic Capacitors have wear-out failure mode with gradual deterioration of the electrical parameters and should have large number of the failure rate at the end of life. The useful life time is specified by a certain failure rate. It's not a guaranteed specification.

Generally the maximum life time is 15 years (131,000hours) considering sealing material deteriorate. When a longer life time is required for your application, please consult us.



RWQ Series

- Downsized and high ripple current from RWE series
- Endurance with ripple current : 2,000 hours at 85°C
- RoHS2 Compliant

RWQ

Downsized

RWE



SPECIFICATIONS

Items	Characteristics		
Category	-25 to +85°C		
Temperature Range	-25 to +85°C		
Rated Voltage Range	350 to 550V _{dc}		
Capacitance Tolerance	±20% (M) (at 20°C, 120Hz)		
Leakage Current	I=0.02CV or 5mA, whichever is smaller. Where, I : Max. leakage current (μA), C : Nominal capacitance (μF), V : Rated voltage (V _{dc}) (at 20°C after 5 minutes)		
Dissipation Factor (tan δ)	0.25 max. (at 20°C, 120Hz)		
Low Temperature Characteristics	Rated voltage (V _{dc})	350 to 450V	500 to 550V
	C(-25°C) / C(+20°C)	≥0.7	≥0.6
Insulation Resistance	When measured between the terminals shorted each other and the mounting clamp on the insulating sleeve covering the case by using an insulation resistance meter of 500V _{dc} , the insulation resistance shall not be less than 100MΩ.		
Insulation Withstanding Voltage	When a voltage of 2,000V _{ac} is applied for 1 minute between the terminals shorted each other and the mounting clamp on the insulating sleeve covering the case, there shall not be electrical damage.		
Endurance	The following specifications shall be satisfied when the capacitors are restored to 20°C after subjected to DC voltage with the rated ripple current is applied (the peak voltage shall not exceed the rated voltage) for 2,000 hours at 85°C.		
	Capacitance change	≤ ±20% of the initial value	
	D.F. (tan δ)	≤300% of the initial specified value	
	Leakage current	≤The initial specified value	
Shelf Life	The following specifications shall be satisfied when the capacitors are restored to 20°C after exposing them for 500 hours at 85°C without voltage applied. Before the measurement, the capacitor shall be preconditioned by applying voltage according to Item 4.1 of JISC 5101-4.		
	Capacitance change	≤ ±20% of the initial value	
	D.F. (tan δ)	≤300% of the initial specified value	
	Leakage current	≤The initial specified value	

DIMENSIONS (Screw-Mount) [mm]

● Terminal Code : LG

● Mounting Clamp Code : B

● Mounting Clamp Code : C

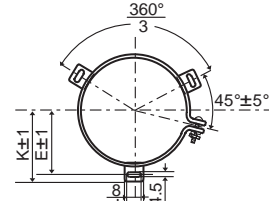
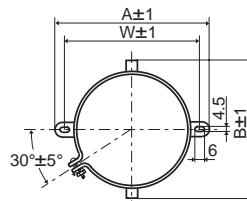
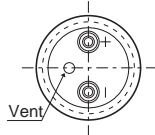
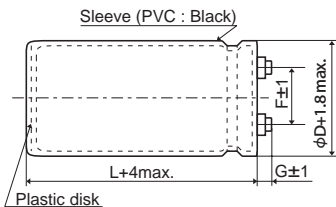

φ50 & φ63.5 : G=6
φ76.2 & φ89 : G=5

φD	A	B	W	F
50	78.0	64.0	68.0	22.4
63.5	90.0	76.0	80.0	28.0
76.2	104.5	90.0	93.5	31.5

φD	E	K	F	J
50	32.5	37.0	22.4	14.0
63.5	38.1	43.5	28.0	14.0
76.2	44.5	50.0	31.5	14.0
89	50.8	56.5	31.5	16.0

<Screw specifications>

Plus hexagon-headed screw :M5×0.8×10

Maximum screw tightening torque :3.23Nm

* The screw and the mounting clamp are separately supplied and not attached to the product.

PART NUMBERING SYSTEM

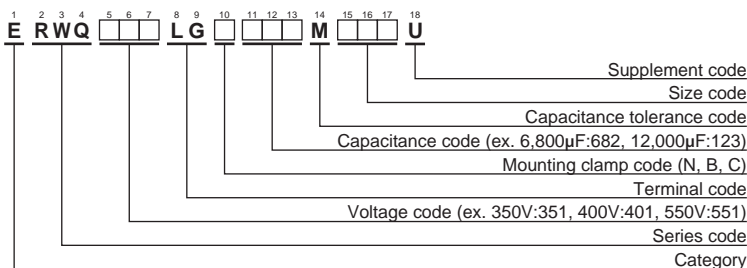

Please refer to "Product code guide (screw-mount terminal type)"



◆ **STANDARD RATINGS**

WV (V _{dc})	Cap (μF)	Case size φD×L(mm)	tan δ	Rated ripple current (Arms/85°C, 120Hz)	Part No.	WV (V _{dc})	Cap (μF)	Case size φD×L(mm)	tan δ	Rated ripple current (Arms/85°C, 120Hz)	Part No.
350	1,500	50 × 65	0.25	5.09	ERWQ351LGC152MC65U	500	470	50 × 60	0.25	2.17	ERWQ501LGC471MC60U
	1,800	50 × 75	0.25	5.93	ERWQ351LGC182MC75U		680	50 × 65	0.25	2.70	ERWQ501LGC681MC65U
	2,200	50 × 96	0.25	7.30	ERWQ351LGC222MC96U		820	50 × 75	0.25	3.15	ERWQ501LGC821MC75U
	2,700	50 × 115	0.25	8.76	ERWQ351LGC272MCB5U		1,000	50 × 85	0.25	3.67	ERWQ501LGC102MC85U
	3,300	63.5 × 85	0.25	9.71	ERWQ351LGC332MD85U		1,200	50 × 96	0.25	4.22	ERWQ501LGC122MC96U
	3,900	50 × 130	0.25	11.1	ERWQ351LGC392MCD0U		1,500	50 × 115	0.25	5.14	ERWQ501LGC152MCB5U
	3,900	63.5 × 96	0.25	11.1	ERWQ351LGC392MD96U		1,500	63.5 × 96	0.25	5.42	ERWQ501LGC152MD96U
	4,700	63.5 × 115	0.25	13.2	ERWQ351LGC472MDB5U		1,800	50 × 130	0.25	5.95	ERWQ501LGC182MCD0U
	5,600	63.5 × 130	0.25	15.2	ERWQ351LGC562MDD0U		1,800	63.5 × 96	0.25	5.94	ERWQ501LGC182MD96U
	5,600	76.2 × 96	0.25	14.3	ERWQ351LGC562ME96U		2,200	63.5 × 115	0.25	7.10	ERWQ501LGC222MDB5U
	6,800	76.2 × 115	0.25	17.0	ERWQ351LGC682MEB5U		2,200	76.2 × 96	0.25	7.30	ERWQ501LGC222ME96U
	8,200	76.2 × 130	0.25	19.6	ERWQ351LGC822MED0U		2,700	63.5 × 130	0.25	8.31	ERWQ501LGC272MDD0U
	10,000	76.2 × 155	0.25	23.4	ERWQ351LGC103MEF5U		3,300	76.2 × 115	0.25	9.65	ERWQ501LGC332MEB5U
12,000	89 × 130	0.25	24.1	ERWQ351LGC123MFD0U	3,900	76.2 × 130	0.25	11.1	ERWQ501LGC392MED0U		
15,000	89 × 155	0.25	29.1	ERWQ351LGC153MFF5U	4,700	76.2 × 155	0.25	13.1	ERWQ501LGC472MEF5U		
400	1,200	50 × 65	0.25	4.55	ERWQ401LGC122MC65U	550	390	50 × 60	0.25	1.98	ERWQ551LGC391MC60U
	1,500	50 × 75	0.25	5.41	ERWQ401LGC152MC75U		560	50 × 65	0.25	2.45	ERWQ551LGC561MC65U
	1,800	50 × 85	0.25	6.26	ERWQ401LGC182MC85U		680	50 × 75	0.25	2.87	ERWQ551LGC681MC75U
	2,200	50 × 96	0.25	7.30	ERWQ401LGC222MC96U		820	50 × 85	0.25	3.32	ERWQ551LGC821MC85U
	2,700	50 × 115	0.25	8.76	ERWQ401LGC272MCB5U		1,200	50 × 115	0.25	4.60	ERWQ551LGC122MCB5U
	3,300	63.5 × 96	0.25	10.2	ERWQ401LGC332MD96U		1,500	63.5 × 96	0.25	5.42	ERWQ551LGC152MD96U
	3,900	63.5 × 115	0.25	12.0	ERWQ401LGC392MDB5U		1,800	76.2 × 80	0.25	6.12	ERWQ551LGC182ME80U
	4,700	63.5 × 130	0.25	13.9	ERWQ401LGC472MDD0U		2,200	76.2 × 96	0.25	7.30	ERWQ551LGC222ME96U
	4,700	76.2 × 96	0.25	13.1	ERWQ401LGC472ME96U		2,700	76.2 × 115	0.25	8.73	ERWQ551LGC272MEB5U
	5,600	63.5 × 155	0.25	16.5	ERWQ401LGC562MDF5U		3,300	76.2 × 130	0.25	10.2	ERWQ551LGC332MED0U
	6,800	76.2 × 115	0.25	17.0	ERWQ401LGC682MEB5U		5,600	89 × 155	0.25	14.5	ERWQ551LGC562MFF5U
	8,200	76.2 × 155	0.25	21.2	ERWQ401LGC822MEF5U						
	10,000	89 × 130	0.25	22.0	ERWQ401LGC103MFD0U						
12,000	89 × 155	0.25	26.0	ERWQ401LGC123MFF5U							
450	1,000	50 × 70	0.25	3.87	ERWQ451LGC102MC70U						
	1,200	50 × 75	0.25	4.36	ERWQ451LGC122MC75U						
	1,500	50 × 90	0.25	5.28	ERWQ451LGC152MC90U						
	1,800	50 × 96	0.25	5.95	ERWQ451LGC182MC96U						
	2,200	50 × 130	0.25	7.54	ERWQ451LGC222MCD0U						
	2,700	63.5 × 96	0.25	8.34	ERWQ451LGC272MD96U						
	3,300	63.5 × 115	0.25	9.97	ERWQ451LGC332MDB5U						
	3,900	63.5 × 130	0.25	11.4	ERWQ451LGC392MDD0U						
	3,900	76.2 × 96	0.25	11.1	ERWQ451LGC392ME96U						
	4,700	63.5 × 155	0.25	13.6	ERWQ451LGC472MDF5U						
	4,700	76.2 × 115	0.25	13.2	ERWQ451LGC472MEB5U						
	5,600	76.2 × 130	0.25	15.2	ERWQ451LGC562MED0U						
	6,800	76.2 × 155	0.25	18.1	ERWQ451LGC682MEF5U						
8,200	89 × 130	0.25	19.2	ERWQ451LGC822MFD0U							

◆ **RATED RIPPLE CURRENT MULTIPLIERS**

● Frequency Multipliers

Frequency (Hz)	50	120	300	1k	3k
Coefficient	0.8	1.0	1.1	1.3	1.4

The deterioration of aluminum electrolytic capacitors accelerates their life due to the internal heating produced by ripple current. For details, refer to Section "5-3 Ripple Current Effect on Lifetime" in the catalog, Technical Note.

Also, for the RWQ series capacitors, using them at operating voltage less than their rated voltage can extend their lifetime. For the details, please contact a representative of Nippon Chemi-Con.

RWE Series

- Endurance with ripple current : 85°C 2,000 hours
- RoHS2 Compliant

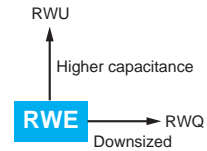

SPECIFICATIONS

Items	Characteristics			
Category	-25 to +85°C			
Temperature Range	-25 to +85°C			
Rated Voltage Range	350 to 450V _{dc}			
Capacitance Tolerance	±20% (M) (at 20°C, 120Hz)			
Leakage Current	I=0.02CV or 5mA, whichever is smaller. Where, I : Max. leakage current (μA), C : Nominal capacitance (μF), V : Rated voltage (V) (at 20°C after 5 minutes)			
Dissipation Factor (tan δ)	0.25 max. (at 20°C, 120Hz)			
Low Temperature Characteristics	Capacitance change	Rated Voltage (V _{dc})	350 to 450V	(at 120Hz)
		C(-25°C)/C(+20°C)	≥0.7	
Insulation Resistance	When measured between the terminals that are connected to each other and to the mounting clamp on the insulating sleeve covering the case by using an insulation resistance meter of 500V _{dc} , the insulation resistance shall not be less than 100MΩ.			
Insulation Withstanding Voltage	When a voltage of 2,000V _{ac} is applied for 1 minute between the terminals that are connected to each other and to the mounting clamp on the insulating sleeve covering the case, there shall not be electrical damage.			
Endurance	The following specifications shall be satisfied when the capacitors are restored to 20°C after subjected to DC voltage with the rated ripple current is applied (the peak voltage shall not exceed the rated voltage) for 2,000 hours at 85°C.			
	Capacitance change	≤ ±20% of the initial value		
	D.F. (tan δ)	≤ 300% of the initial specified value		
	Leakage current	≤ The initial specified value		
Shelf Life	The following specifications shall be satisfied when the capacitors are restored to 20°C after exposing them for 500 hours at 85°C without voltage applied. Before the measurement, the capacitor shall be preconditioned by applying voltage according to Item 4.1 of JIS C 5101-4.			
	Capacitance change	≤ ±20% of the initial value		
	D.F. (tan δ)	≤ 300% of the initial specified value		
	Leakage current	≤ The initial specified value		

DIMENSIONS (Screw-Mount) [mm]

Terminal Code : LG

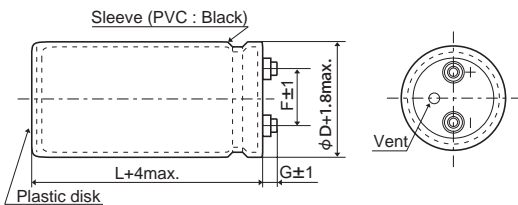

φ35 to φ63.5 : G=6
φ76.2 & φ89 : G=5

Mounting Clamp Code : B

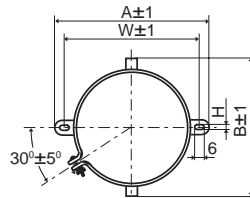

φD	A	B	W	H	F
35	58.0	44.0	48.0	3.5	12.7
50	78.0	64.0	68.0	4.5	22.4
63.5	90.0	76.0	80.0	4.5	28.0
76.2	104.5	90.0	93.5	4.5	31.5

Mounting Clamp Code : C

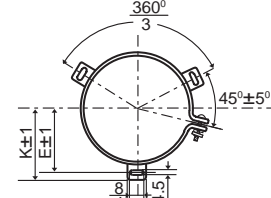

φD	E	K	F	J
50	32.5	37.0	22.4	14.0
63.5	38.1	43.5	28.0	14.0
76.2	44.5	50.0	31.5	14.0
89	50.8	56.5	31.5	16.0

<Screw specifications>

Plus hexagon-headed screw : M5×0.8×10

Maximum screw tightening torque : 3.23Nm

* The screw and the mounting clamp are separately supplied and not attached to the product.

PART NUMBERING SYSTEM

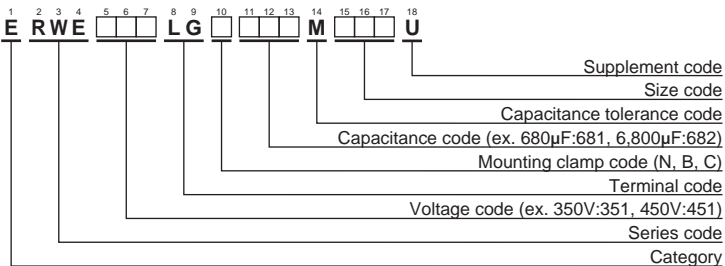

Please refer to "Product code guide (screw-mount terminal type)"



RWE Series

◆STANDARD RATINGS

WV (V _{dc})	Cap (μF)	Case size φD×L(mm)	tan δ	Rated ripple current (Arms/85°C, 120Hz)	Part No.
350	390	35 × 50	0.25	1.90	ERWE351LGB391MA50U
	680	35 × 80	0.25	2.90	ERWE351LGB681MA80U
	1,000	35 × 100	0.25	3.80	ERWE351LGB102MAA0U
	1,200	35 × 120	0.25	4.20	ERWE351LGB122MAC0U
	1,500	50 × 75	0.25	4.70	ERWE351LGC152MC75U
	2,200	50 × 96	0.25	6.30	ERWE351LGC222MC96U
	3,300	50 × 130	0.25	8.80	ERWE351LGC332MCD0U
	3,300	63.5 × 96	0.25	8.80	ERWE351LGC332MD96U
	3,900	63.5 × 115	0.25	10.3	ERWE351LGC392MDB5U
	4,700	63.5 × 130	0.25	12.0	ERWE351LGC472MDD0U
	4,700	76.2 × 96	0.25	11.7	ERWE351LGC472ME96U
	5,600	76.2 × 115	0.25	12.6	ERWE351LGC562MEB5U
	6,800	76.2 × 130	0.25	15.9	ERWE351LGC682MED0U
	8,200	76.2 × 155	0.25	19.0	ERWE351LGC822MEF5U
	12,000	89 × 155	0.25	22.5	ERWE351LGC123MFF5U
400	330	35 × 50	0.25	1.70	ERWE401LGB331MA50U
	560	35 × 80	0.25	2.70	ERWE401LGB561MA80U
	820	35 × 100	0.25	3.40	ERWE401LGB821MAA0U
	1,000	35 × 120	0.25	3.90	ERWE401LGB102MAC0U
	1,200	50 × 75	0.25	4.20	ERWE401LGC122MC75U
	1,800	50 × 96	0.25	5.70	ERWE401LGC182MC96U
	2,200	50 × 130	0.25	7.20	ERWE401LGC222MCD0U
	2,700	63.5 × 96	0.25	7.90	ERWE401LGC272MD96U
	3,300	63.5 × 115	0.25	9.50	ERWE401LGC332MDB5U
	3,900	63.5 × 130	0.25	10.9	ERWE401LGC392MDD0U
	3,900	76.2 × 96	0.25	10.6	ERWE401LGC392ME96U
	4,700	76.2 × 115	0.25	12.6	ERWE401LGC472MEB5U
	5,600	76.2 × 130	0.25	14.5	ERWE401LGC562MED0U
	6,800	76.2 × 155	0.25	17.3	ERWE401LGC682MEF5U
	10,000	89 × 155	0.25	20.5	ERWE401LGC103MFF5U

WV (V _{dc})	Cap (μF)	Case size φD×L(mm)	tan δ	Rated ripple current (Arms/85°C, 120Hz)	Part No.
450	270	35 × 50	0.25	1.60	ERWE451LGB271MA50U
	470	35 × 80	0.25	2.40	ERWE451LGB471MA80U
	680	35 × 100	0.25	3.10	ERWE451LGB681MAA0U
	820	35 × 120	0.25	3.50	ERWE451LGB821MAC0U
	1,000	50 × 75	0.25	3.90	ERWE451LGC102MC75U
	1,200	50 × 96	0.25	4.70	ERWE451LGC122MC96U
	1,500	50 × 115	0.25	5.60	ERWE451LGC152MCB5U
	1,800	50 × 130	0.25	6.50	ERWE451LGC182MCD0U
	2,200	63.5 × 96	0.25	7.20	ERWE451LGC222MD96U
	2,700	63.5 × 115	0.25	8.60	ERWE451LGC272MDB5U
	3,300	63.5 × 130	0.25	10.0	ERWE451LGC332MDD0U
	3,300	76.2 × 96	0.25	9.80	ERWE451LGC332ME96U
	3,900	76.2 × 115	0.25	11.5	ERWE451LGC392MEB5U
	4,700	76.2 × 130	0.25	13.3	ERWE451LGC472MED0U
	5,600	76.2 × 155	0.25	15.7	ERWE451LGC562MEF5U
8,200	89 × 155	0.25	18.6	ERWE451LGC822MFF5U	

◆RATED RIPPLE CURRENT MULTIPLIERS

● Frequency Multipliers

Frequency (Hz)	50	120	300	1k	3k
Coefficient	0.8	1.0	1.1	1.3	1.4

The deterioration of aluminum electrolytic capacitors accelerates their life due to the internal heating produced by ripple current. For details, refer to Section "5-3 Ripple Current Effect on Lifetime" in the catalog, Technical Note.

Also, for the RWE series capacitors, using them at operating voltage less than their rated voltage can extend their lifetime. For details, please contact a representative of Nippon Chemi-Con.

RWL Series

- High ripple capability
- For train systems and high power consuming inverter circuits
- Endurance with ripple current : 20,000 hours at 85°C
- RoHS2 Compliant

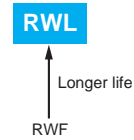

SPECIFICATIONS

Items	Characteristics
Category	
Temperature Range	-25 to +85°C
Rated Voltage Range	350 to 450V _{dc}
Capacitance Tolerance	±20% (M) (at 20°C, 120Hz)
Leakage Current	I=0.02CV or 5mA, whichever is smaller. Where, I : Max. leakage current (μA), C : Nominal capacitance (μF), V : Rated voltage (V) (at 20°C after 5 minutes)
Dissipation Factor (tan δ)	0.25 max. (at 20°C, 120Hz)
Low Temperature Characteristics	Capacitance change $C(-25°C)/C(+20°C) \geq 0.7$ (at 120Hz)
Insulation Resistance	When measured between the terminals that are connected to each other and to the mounting clamp on the insulating sleeve covering the case by using an insulation resistance meter of 500V _{dc} , the insulation resistance shall not be less than 100MΩ.
Insulation Withstanding Voltage	When a voltage of 2,000V _{ac} is applied for 1 minute between the terminals that are connected to each other and to the mounting clamp on the insulating sleeve covering the case, there shall not be electrical damage.
Endurance	The following specifications shall be satisfied when the capacitors are restored to 20°C after subjected to DC voltage with the rated ripple current is applied (the peak voltage shall not exceed the rated voltage) for 20,000 hours at 85°C.
	Capacitance change $\leq \pm 30\%$ of the initial value
	D.F. (tan δ) $\leq 300\%$ of the initial specified value
	Leakage current \leq The initial specified value
Shelf Life	The following specifications shall be satisfied when the capacitors are restored to 20°C after exposing them for 500 hours at 85°C without voltage applied. Before the measurement, the capacitor shall be preconditioned by applying voltage according to Item 4.1 of JIS C 5101-4.
	Capacitance change $\leq \pm 20\%$ of the initial value
	D.F. (tan δ) $\leq 300\%$ of the initial specified value
	Leakage current \leq The initial specified value

DIMENSIONS (Screw-Mount) [mm]

● Terminal Code : LG

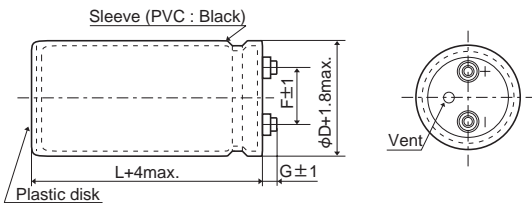

φ63.5 : G=6
φ76.2 & φ89 : G=5

● Mounting Clamp Code : B

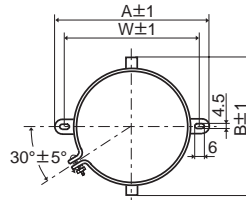

φD	A	B	W	F
63.5	90.0	76.0	80.0	28.0
76.2	104.5	90.0	93.5	31.5

● Mounting Clamp Code : C

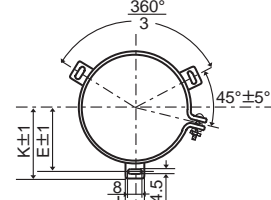

φD	E	K	F	J
63.5	38.1	43.5	28.0	14.0
76.2	44.5	50.0	31.5	14.0
89	50.8	56.5	31.5	16.0

<Screw specifications>

Plus hexagon-headed screw : M5x0.8x10

Maximum screw tightening torque : 3.23Nm

* The screw and the mounting clamp are separately supplied and not attached to the product.

PART NUMBERING SYSTEM

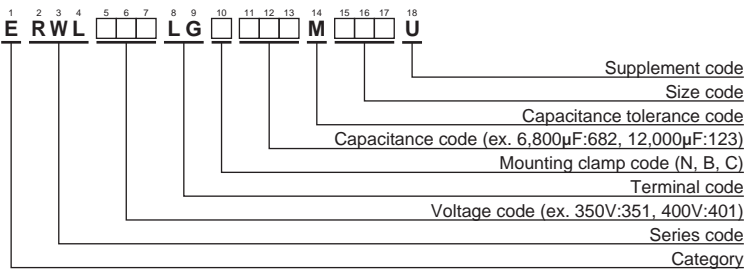

Please refer to "Product code guide (screw-mount terminal type)"



RWL Series

◆STANDARD RATINGS

WV (V _{dc})	Cap (μF)	Case size φD×L(mm)	tan δ	Rated ripple current (Arms/85°C, 120Hz)	Part No.	WV (V _{dc})	Cap (μF)	Case size φD×L(mm)	tan δ	Rated ripple current (Arms/85°C, 120Hz)	Part No.	
350	3,300	63.5 × 115	0.25	11.1	ERWL351LGC332MDB5U	400	5,600	63.5 × 190	0.25	18.2	ERWL401LGC562MDK0U	
	3,900	63.5 × 130	0.25	12.8	ERWL351LGC392MDD0U		5,600	76.2 × 155	0.25	18.3	ERWL401LGC562MEF5U	
	4,700	63.5 × 155	0.25	15.2	ERWL351LGC472MDF5U		6,800	76.2 × 170	0.25	21.0	ERWL401LGC682MEH0U	
	4,700	76.2 × 115	0.25	14.7	ERWL351LGC472MEB5U		8,200	89 × 155	0.25	24.1	ERWL401LGC822MFF5U	
	5,600	63.5 × 170	0.25	17.3	ERWL351LGC562MDH0U		10,000	89 × 190	0.25	29.1	ERWL401LGC103MFK0U	
	5,600	76.2 × 130	0.25	16.9	ERWL351LGC562MED0U		450	2,200	63.5 × 115	0.25	9.10	ERWL451LGC222MDB5U
	6,800	63.5 × 190	0.25	20.0	ERWL351LGC682MDK0U			2,700	63.5 × 130	0.25	10.6	ERWL451LGC272MDD0U
	6,800	76.2 × 155	0.25	20.2	ERWL351LGC682MEF5U			2,700	76.2 × 115	0.25	11.2	ERWL451LGC272MEB5U
	8,200	76.2 × 170	0.25	23.1	ERWL351LGC822MEH0U			3,300	63.5 × 155	0.25	12.7	ERWL451LGC332MDF5U
	10,000	89 × 155	0.25	26.6	ERWL351LGC103MFF5U			3,300	76.2 × 130	0.25	13.0	ERWL451LGC332MED0U
12,000	89 × 190	0.25	32.0	ERWL351LGC123MFK0U	3,900	63.5 × 170		0.25	14.4	ERWL451LGC392MDH0U		
400	2,700	63.5 × 115	0.25	10.1	ERWL401LGC272MDB5U	4,700		76.2 × 155	0.25	16.7	ERWL451LGC472MEF5U	
	3,300	63.5 × 130	0.25	11.7	ERWL401LGC332MDD0U	5,600		76.2 × 190	0.25	20.1	ERWL451LGC562MEK0U	
	3,900	63.5 × 155	0.25	13.8	ERWL401LGC392MDF5U	5,600		89 × 155	0.25	19.9	ERWL451LGC562MFF5U	
	3,900	76.2 × 115	0.25	14.7	ERWL401LGC392MEB5U	6,800		89 × 170	0.25	23.0	ERWL451LGC682MFH0U	
	4,700	63.5 × 170	0.25	15.8	ERWL401LGC472MDH0U	8,200	89 × 190	0.25	26.4	ERWL451LGC822MFK0U		
	4,700	76.2 × 130	0.25	15.5	ERWL401LGC472MED0U							

◆RATED RIPPLE CURRENT MULTIPLIERS

●Frequency Multipliers

Frequency (Hz)	50	120	300	1k	3k
Coefficient	0.8	1.0	1.1	1.3	1.4

The deterioration of aluminum electrolytic capacitors accelerates their life due to the internal heating produced by ripple current. For details, refer to Section "5-3 Ripple Current Effect on Lifetime" in the catalog, Technical Note.

Also, for RWL series capacitors, using them at operating voltage less than their rated voltage can extend their lifetime. For details, please contact a representative of Nippon Chemi-Con.

RHB Series

- Realized higher voltage than RWE series. (575 to 700V_{dc})
- Endurance with ripple current : 2,000 hours at 85°C
- Suitable for X-ray and welder power supply where high energy is required
- RoHS2 Compliant

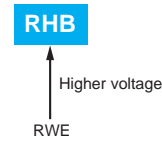

SPECIFICATIONS

Items	Characteristics						
Category							
Temperature Range	-25 to +85°C						
Rated Voltage Range	575 to 700V _{dc}						
Capacitance Tolerance	±20% (M) (at 20°C, 120Hz)						
Leakage Current	I=0.02CV or 5mA, whichever is smaller. Where, I : Max. leakage current (μA), C : Nominal capacitance (μF), V : Rated voltage (V) (at 20°C after 5 minutes)						
Dissipation Factor (tan δ)	0.25 max. (at 20°C, 120Hz)						
Low Temperature Characteristics	Capacitance change $C(-25°C)/C(+20°C) \geq 0.6$ (at 120Hz)						
Insulation Resistance	When measured between the terminals that are connected to each other and to the mounting clamp on the insulating sleeve covering the case by using an insulation resistance meter of 500V _{dc} , the insulation resistance shall not be less than 100MΩ.						
Insulation Withstanding Voltage	When a voltage of 2,000V _{ac} is applied for 1 minute between the terminals that are connected to each other and to the mounting clamp on the insulating sleeve covering the case, there shall not be electrical damage.						
Endurance	The following specifications shall be satisfied when the capacitors are restored to 20°C after subjected to DC voltage with the rated ripple current is applied (the peak voltage shall not exceed the rated voltage) for 2,000 hours at 85°C. <table border="1" style="width:100%; margin-top:5px;"> <tr> <td>Capacitance change</td> <td>≤ ±20% of the initial value</td> </tr> <tr> <td>D.F. (tan δ)</td> <td>≤200% of the initial specified value</td> </tr> <tr> <td>Leakage current</td> <td>≤The initial specified value</td> </tr> </table>	Capacitance change	≤ ±20% of the initial value	D.F. (tan δ)	≤200% of the initial specified value	Leakage current	≤The initial specified value
Capacitance change	≤ ±20% of the initial value						
D.F. (tan δ)	≤200% of the initial specified value						
Leakage current	≤The initial specified value						
Shelf Life	The following specifications shall be satisfied when the capacitors are restored to 20°C after exposing them for 500 hours at 85°C without voltage applied. Before the measurement, the capacitor shall be preconditioned by applying voltage according to Item 4.1 of JIS C 5101-4. <table border="1" style="width:100%; margin-top:5px;"> <tr> <td>Capacitance change</td> <td>≤ ±20% of the initial value</td> </tr> <tr> <td>D.F. (tan δ)</td> <td>≤200% of the initial specified value</td> </tr> <tr> <td>Leakage current</td> <td>≤The initial specified value</td> </tr> </table>	Capacitance change	≤ ±20% of the initial value	D.F. (tan δ)	≤200% of the initial specified value	Leakage current	≤The initial specified value
Capacitance change	≤ ±20% of the initial value						
D.F. (tan δ)	≤200% of the initial specified value						
Leakage current	≤The initial specified value						

DIMENSIONS (Screw-Mount) [mm]

● Terminal Code : LG

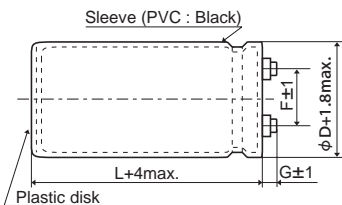

φ 63.5 : G=6
φ 76.2 & φ 89 : G=5

● Mounting Clamp Code : B

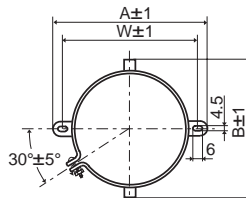

φD	A	B	W	F
63.5	90.0	76.0	80.0	28.0
76.2	104.5	90.0	93.5	31.5

● Mounting Clamp Code : C

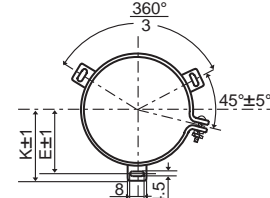

φD	E	K	F	J
63.5	38.1	43.5	28.0	14.0
76.2	44.5	50.0	31.5	14.0
89	50.8	56.5	31.5	16.0

<Screw specifications>

to φ89 Plus hexagon-headed screw :M5X0.8X10
Maximum screw tightening torque :3.23Nm

* The screw and the mounting clamp are separately supplied and not attached to the product.

PART NUMBERING SYSTEM

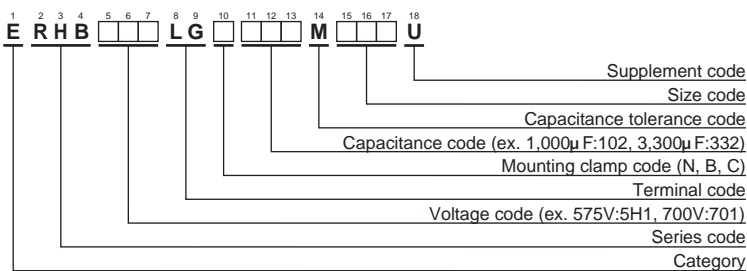

Please refer to "Product code guide (screw-mount terminal type)"



RHBSeries

◆ **STANDARD RATINGS**

WV (V _{dc})	Cap (μF)	Case size φD×L(mm)	tan δ	Rated ripple current (Arms/85°C,120Hz)	Part No.	WV (V _{dc})	Cap (μF)	Case size φD×L(mm)	tan δ	Rated ripple current (Arms/85°C,120Hz)	Part No.	
575	1,000	63.5×70	0.25	3.80	ERHB5H1LGC102MD70U	630	1,500	76.2×85	0.25	5.60	ERHB631LGC152ME85U	
	1,200	63.5×80	0.25	4.40	ERHB5H1LGC122MD80U		1,800	63.5×125	0.25	6.60	ERHB631LGC182MDC5U	
	1,500	63.5×95	0.25	5.30	ERHB5H1LGC152MD95U		1,800	76.2×95	0.25	6.40	ERHB631LGC182ME95U	
	1,500	76.2×70	0.25	5.20	ERHB5H1LGC152ME70U		1,800	89×85	0.25	5.70	ERHB631LGC182MF85U	
	1,800	63.5×100	0.25	5.90	ERHB5H1LGC182MDA0U		2,200	76.2×115	0.25	7.80	ERHB631LGC222MEB5U	
	1,800	76.2×80	0.25	6.00	ERHB5H1LGC182ME80U		2,200	89×90	0.25	6.50	ERHB631LGC222MF90U	
	2,200	63.5×120	0.25	7.10	ERHB5H1LGC222MDC0U		2,700	76.2×130	0.25	9.10	ERHB631LGC272MED0U	
	2,200	76.2×95	0.25	7.20	ERHB5H1LGC222ME95U		2,700	89×100	0.25	7.40	ERHB631LGC272MFA0U	
	2,700	76.2×105	0.25	8.30	ERHB5H1LGC272MEA5U		3,300	89×120	0.25	9.00	ERHB631LGC332MFC0U	
	2,700	89×85	0.25	7.00	ERHB5H1LGC272MF85U		700	1,000	63.5×115	0.25	4.70	ERHB701LGC102MDB5U
	3,300	76.2×120	0.25	9.70	ERHB5H1LGC332MEC0U			1,200	63.5×125	0.25	5.40	ERHB701LGC122MDC5U
	3,300	89×100	0.25	8.30	ERHB5H1LGC332MFA0U			1,500	76.2×115	0.25	6.40	ERHB701LGC152MEB5U
	3,900	89×105	0.25	9.10	ERHB5H1LGC392MFA5U			1,800	76.2×125	0.25	7.20	ERHB701LGC182MEC5U
	4,700	89×130	0.25	11.1	ERHB5H1LGC472MFD0U			1,800	89×105	0.25	6.20	ERHB701LGC182MFA5U
5,600	89×145	0.25	12.7	ERHB5H1LGC562MFE5U	2,200	76.2×155		0.25	8.80	ERHB701LGC222MEF5U		
630	1,000	63.5×85	0.25	4.10	ERHB631LGC102MD85U	2,200		89×115	0.25	7.10	ERHB701LGC222MFB5U	
	1,200	63.5×95	0.25	4.80	ERHB631LGC122MD95U	2,700		89×135	0.25	8.50	ERHB701LGC272MFD5U	
	1,500	63.5×115	0.25	5.80	ERHB631LGC152MDB5U	3,300		89×155	0.25	9.90	ERHB701LGC332MFF5U	

◆ **RATED RIPPLE CURRENT MULTIPLIERS**

● Frequency Multipliers

Frequency (Hz)	50	120	300	1k	3k
Coefficient	0.8	1.0	1.2	1.3	1.4

The deterioration of aluminum electrolytic capacitors accelerates their life due to the internal heating produced by ripple current. For details, refer to Section "5-3 Ripple Current Effect on Lifetime" in the catalog, Technical Note.

Also, for the RHB series capacitors, using them at operating voltage less than their rated voltage can extend their lifetime. For details, please contact a representative of Nippon Chemi-Con.

RHASeries

- Realized higher voltage than RWF series (500 to 650V_{dc})
- Endurance with ripple current : 5,000 hours at 85°C
- Suitable for high voltage inverter
- RoHS2 compliant

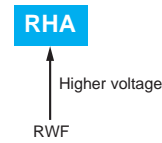

◆ SPECIFICATIONS

Items	Characteristics
Category	
Temperature Range	-25 to +85°C
Rated Voltage Range	500 to 650V _{dc}
Capacitance Tolerance	±20% (M) (at 20°C, 120Hz)
Leakage Current	I=0.02CV or 5mA, whichever is smaller. Where, I : Max. leakage current (μA), C : Nominal capacitance (μF), V : Rated voltage (V) (at 20°C after 5 minutes)
Dissipation Factor (tan δ)	0.25 max. (at 20°C, 120Hz)
Low Temperature Characteristics	Capacitance change $C(-25°C)/C(+20°C) \geq 0.6$ (at 120Hz)
Insulation Resistance	When measured between the terminals that are connected to each other and to the mounting clamp on the insulating sleeve covering the case by using an insulation resistance meter of 500V _{dc} , the insulation resistance shall not be less than 100MΩ.
Insulation Withstanding Voltage	When a voltage of 2,000V _{ac} is applied for 1 minute between the terminals that are connected to each other and to the mounting clamp on the insulating sleeve covering the case, there shall not be electrical damage.
Endurance	The following specifications shall be satisfied when the capacitors are restored to 20°C after subjected to DC voltage with the rated ripple current is applied (the peak voltage shall not exceed the rated voltage) for 5,000 hours at 85°C.
	Capacitance change $\leq \pm 20\%$ of the initial value
	D.F. (tan δ) $\leq 200\%$ of the initial specified value
	Leakage current \leq The initial specified value
Shelf Life	The following specifications shall be satisfied when the capacitors are restored to 20°C after exposing them for 500 hours at 85°C without voltage applied. Before the measurement, the capacitor shall be preconditioned by applying voltage according to Item 4.1 of JIS C 5101-4.
	Capacitance change $\leq \pm 20\%$ of the initial value
	D.F. (tan δ) $\leq 200\%$ of the initial specified value
	Leakage current \leq The initial specified value

◆ DIMENSIONS (Screw-Mount) [mm]

● Terminal Code : LG

● Mounting Clamp Code : B

● Mounting Clamp Code : C

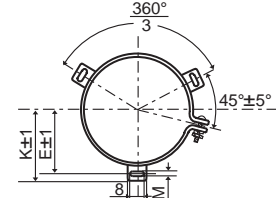
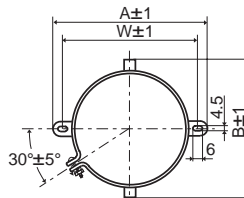
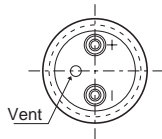
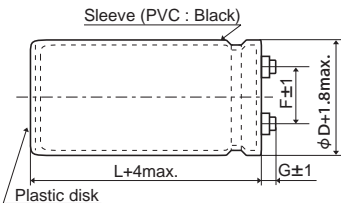

- φ50 & φ63.5 : G=6
- φ76.2 & φ89 : G=5
- φ100 : G=10

φD	A	B	W	F
50	78.0	64.0	68.0	22.4
63.5	90.0	76.0	80.0	28.0
76.2	104.5	90.0	93.5	31.5

φD	E	K	M	F	J
50	32.5	37.0	4.5	22.4	14.0
63.5	38.1	43.5	4.5	28.0	14.0
76.2	44.5	50.0	4.5	31.5	14.0
89	50.8	56.5	4.5	31.5	16.0
100	56.5	63.4	5.5	41.5	18.0

<Screw specifications>

to φ89 Plus hexagon-headed screw :M5×0.8×10
Maximum screw tightening torque :3.23Nm

φ100 Cross-recessed head (phillips) screw : M8×1.25×16
Spring washer, Washer
Maximum screw tightening torque :6.31Nm

* The screw and the mounting clamp are separately supplied and not attached to the product.

◆ PART NUMBERING SYSTEM

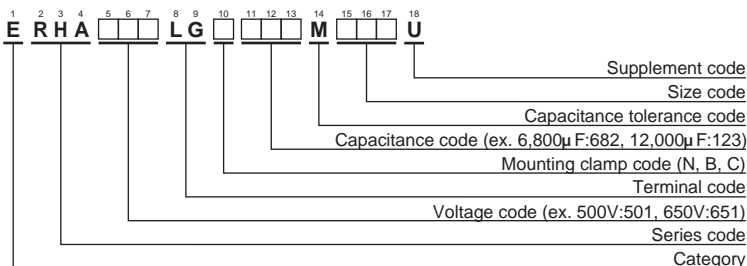

Please refer to "Product code guide (screw-mount terminal type)"



RHA Series

◆ **STANDARD RATINGS**

WV (V _{dc})	Cap (μF)	Case size φD×L(mm)	tan δ	Rated ripple current (Arms/85°C,120Hz)	Part No.	WV (V _{dc})	Cap (μF)	Case size φD×L(mm)	tan δ	Rated ripple current (Arms/85°C,120Hz)	Part No.
500	1,200	50×95	0.25	5.90	ERHA501LGC122MC95U	550	5,600	89×150	0.25	18.2	ERHA551LGC562MFF0U
	1,500	50×115	0.25	7.20	ERHA501LGC152MCB5U		6,800	89×170	0.25	21.1	ERHA551LGC682MFH0U
	1,800	50×130	0.25	8.30	ERHA501LGC182MCD0U		8,200	100×170	0.25	24.8	ERHA551LGC822MGH0U
	2,200	50×150	0.25	9.80	ERHA501LGC222MCF0U		10,000	100×200	0.25	29.4	ERHA551LGC103MGL0U
	2,700	63.5×120	0.25	11.2	ERHA501LGC272MDC0U	600	1,200	63.5×95	0.25	6.70	ERHA601LGC122MD95U
	3,300	63.5×140	0.25	13.3	ERHA501LGC332MDE0U		1,500	63.5×110	0.25	8.00	ERHA601LGC152MDB0U
	3,900	63.5×170	0.25	15.7	ERHA501LGC392MDH0U		1,800	63.5×125	0.25	9.30	ERHA601LGC182MDC5U
	3,900	76.2×130	0.25	15.4	ERHA501LGC392MED0U		1,800	76.2×95	0.25	9.10	ERHA601LGC182ME95U
	4,700	76.2×150	0.25	18.1	ERHA501LGC472MEF0U		2,200	63.5×145	0.25	11.0	ERHA601LGC222MDE5U
	5,600	76.2×170	0.25	20.8	ERHA501LGC562MEH0U		2,200	76.2×110	0.25	10.8	ERHA601LGC222MEB0U
	5,600	89×130	0.25	17.1	ERHA501LGC562MFD0U		2,700	63.5×170	0.25	13.1	ERHA601LGC272MDH0U
	6,800	89×150	0.25	20.0	ERHA501LGC682MFF0U		2,700	76.2×125	0.25	12.6	ERHA601LGC272MEC5U
	8,200	89×190	0.25	24.4	ERHA501LGC822MFK0U		3,300	76.2×145	0.25	14.9	ERHA601LGC332MEE5U
	10,000	89×210	0.25	28.2	ERHA501LGC103MFM0U		3,900	76.2×170	0.25	17.3	ERHA601LGC392MEH0U
	12,000	100×210	0.25	32.9	ERHA501LGC123MGM0U		3,900	89×130	0.25	14.2	ERHA601LGC392MFD0U
15,000	100×250	0.25	39.8	ERHA501LGC153MGR0U	4,700		76.2×190	0.25	20.0	ERHA601LGC472MEK0U	
550	1,000	50×95	0.25	5.40	ERHA551LGC102MC95U	4,700	89×150	0.25	16.6	ERHA601LGC472MFF0U	
	1,200	50×110	0.25	6.30	ERHA551LGC122MCB0U	5,600	89×170	0.25	19.1	ERHA601LGC562MFH0U	
	1,500	50×130	0.25	7.60	ERHA551LGC152MCD0U	650	1,000	63.5×100	0.25	6.30	ERHA651LGC102MDA0U
	1,800	63.5×105	0.25	8.60	ERHA551LGC182MDA5U		1,200	63.5×110	0.25	7.20	ERHA651LGC122MDB0U
	2,200	63.5×120	0.25	10.1	ERHA551LGC222MDC0U		1,500	63.5×130	0.25	8.60	ERHA651LGC152MDD0U
	2,700	63.5×150	0.25	12.4	ERHA551LGC272MDF0U		1,800	63.5×150	0.25	10.1	ERHA651LGC182MDF0U
	2,700	76.2×105	0.25	11.7	ERHA551LGC272MEA5U		2,200	63.5×170	0.25	11.7	ERHA651LGC222MDH0U
	3,300	63.5×170	0.25	14.5	ERHA551LGC332MDH0U		2,700	76.2×150	0.25	13.6	ERHA651LGC272MEF0U
	3,300	76.2×130	0.25	14.2	ERHA551LGC332MED0U		3,300	76.2×170	0.25	15.8	ERHA651LGC332MEH0U
	3,900	76.2×140	0.25	15.9	ERHA551LGC392MEE0U		3,900	89×155	0.25	15.3	ERHA651LGC392MFF5U
	4,700	76.2×170	0.25	19.1	ERHA551LGC472MEH0U		4,700	89×190	0.25	18.4	ERHA651LGC472MFK0U
	4,700	89×130	0.25	15.6	ERHA551LGC472MFD0U						

◆ **RATED RIPPLE CURRENT MULTIPLIERS**

● Frequency Multipliers

Frequency (Hz)	50	120	300	1k	3k
Coefficient	0.8	1.0	1.2	1.3	1.4

The deterioration of aluminum electrolytic capacitors accelerates their life due to the internal heating produced by ripple current. For details, refer to Section "5-3 Ripple Current Effect on Lifetime" in the catalog, Technical Note.

Also, for the RHA series capacitors, using them at operating voltage less than their rated voltage can extend their lifetime. For details, please contact a representative of Nippon Chemi-Con.

LXA Series

- Rated voltage range up to 525V_{dc}
- Endurance with ripple current : 5,000 hours at 105°C (2,000 hours for 500V_{dc} & 525V_{dc})
- RoHS2 Compliant

LXA

Long life
KMH



SPECIFICATIONS

Items	Characteristics												
Category	-40 to +105°C (10 to 100V _{dc}) -25 to +105°C (160 to 525V _{dc})												
Temperature Range													
Rated Voltage Range	10 to 525V _{dc}												
Capacitance Tolerance	-10 to +50% (T) (10 to 250V _{dc}) ±20% (M) (350 to 525V _{dc}) (at 20°C, 120Hz)												
Leakage Current	I=0.02CV or 5mA, whichever is smaller. Where, I : Max. leakage current (μA), C : Nominal capacitance (μF), V : Rated voltage (V) (at 20°C after 5 minutes)												
Dissipation Factor (tan δ)	See STANDARD RATINGS (10 to 250V _{dc}) 0.20max. (350 to 525V _{dc}) (at 20°C, 120Hz)												
Low Temperature Characteristics	Capacitance change C(-40°C)/C(+20°C) ≥ 0.6(10 to 100V _{dc}) C(-25°C)/C(+20°C) ≥ 0.7(160 to 250V _{dc}) C(-25°C)/C(+20°C) ≥ 0.65(350 to 525V _{dc}) (at 120Hz)												
Insulation Resistance	When measured between the terminals that are connected to each other and to the mounting clamp on the insulating sleeve covering the case by using an insulation resistance meter of 500V _{dc} , the insulation resistance shall not be less than 100MΩ.												
Insulation Withstanding Voltage	When a voltage of 2,000V _{ac} is applied for 1 minute between the terminals that are connected to each other and to the mounting clamp on the insulating sleeve covering the case, there shall not be electrical damage.												
Endurance	The following specifications shall be satisfied when the capacitors are restored to 20°C after subjected to DC voltage with the rated ripple current is applied (the peak voltage shall not exceed the rated voltage) for 5,000 hours (2,000 hours for 500 & 525V _{dc} products) at 105°C. <table border="1" style="width: 100%; border-collapse: collapse;"> <tr> <td>Capacitance change</td> <td>≤ ±20% of the initial value</td> </tr> <tr> <td>D.F. (tan δ)</td> <td>≤ 200% of the initial specified value</td> </tr> <tr> <td>Leakage current</td> <td>≤ The initial specified value</td> </tr> </table>	Capacitance change	≤ ±20% of the initial value	D.F. (tan δ)	≤ 200% of the initial specified value	Leakage current	≤ The initial specified value						
Capacitance change	≤ ±20% of the initial value												
D.F. (tan δ)	≤ 200% of the initial specified value												
Leakage current	≤ The initial specified value												
Shelf Life	The following specifications shall be satisfied when the capacitors are restored to 20°C after exposing them for 1,000 hours at 105°C without voltage applied. Before the measurement, the capacitor shall be preconditioned by applying voltage according to Item 4.1 of JIS C 5101-4. <table border="1" style="width: 100%; border-collapse: collapse;"> <tr> <td>Rated voltage</td> <td>10 to 250V_{dc}</td> <td>350 to 525V_{dc}</td> </tr> <tr> <td>Capacitance change</td> <td>≤ ±15% of the initial value</td> <td>≤ ±20% of the initial value</td> </tr> <tr> <td>D.F. (tan δ)</td> <td>≤ 150% of the initial specified value</td> <td>≤ 200% of the initial specified value</td> </tr> <tr> <td>Leakage current</td> <td>≤ The initial specified value</td> <td>≤ The initial specified value</td> </tr> </table>	Rated voltage	10 to 250V _{dc}	350 to 525V _{dc}	Capacitance change	≤ ±15% of the initial value	≤ ±20% of the initial value	D.F. (tan δ)	≤ 150% of the initial specified value	≤ 200% of the initial specified value	Leakage current	≤ The initial specified value	≤ The initial specified value
Rated voltage	10 to 250V _{dc}	350 to 525V _{dc}											
Capacitance change	≤ ±15% of the initial value	≤ ±20% of the initial value											
D.F. (tan δ)	≤ 150% of the initial specified value	≤ 200% of the initial specified value											
Leakage current	≤ The initial specified value	≤ The initial specified value											

DIMENSIONS (Screw-Mount) [mm]

Terminal Code : LG

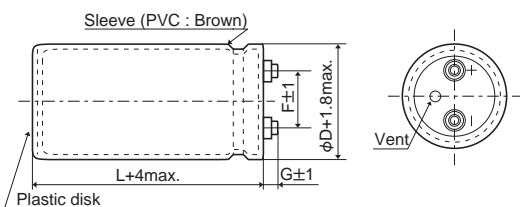

φD	G	
	10 to 250V _{dc}	350 to 525V _{dc}
φ63.5	6	6
φ76.2	5	6
φ89	5	4

Mounting Clamp Code : B

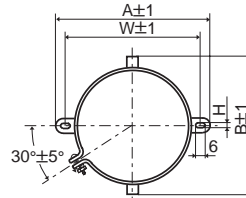

φD	A	B	W	H	F
35	58	44	48	3.5	12.7
50	78	64	68	4.5	22.4
63.5	90	76	80	4.5	28.0
76.2	104.5	90	93.5	4.5	31.5

Mounting Clamp Code : C

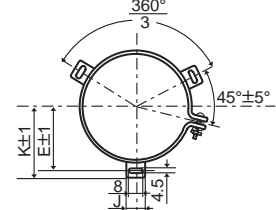

φD	E	K	J	F
50	32.5	37.0	14.0	22.4
63.5	38.1	43.5	14.0	28.0
76.2	44.5	50.0	14.0	31.5
89	50.8	56.5	16.0	31.5

<Screw specifications>

Plus hexagon-headed screw : M5×0.8×10

Maximum screw tightening torque : 3.23Nm

* The screw and the mounting clamp are separately supplied and not attached to the product.

PART NUMBERING SYSTEM

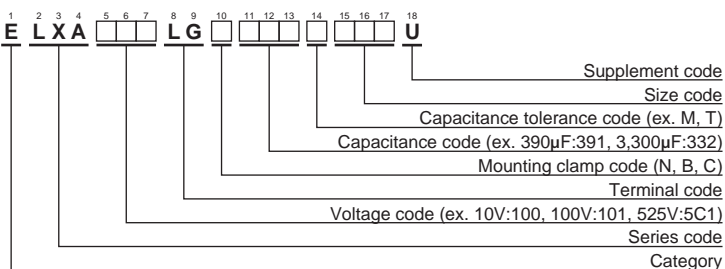

Please refer to "Product code guide (screw-mount terminal type)"



◆ **STANDARD RATINGS**

WV (V _{dc})	Cap (μF)	Case size φD×L(mm)	tan δ	Rated ripple current (Arms/105°C, 120Hz)	Part No.	WV (V _{dc})	Cap (μF)	Case size φD×L(mm)	tan δ	Rated ripple current (Arms/105°C, 120Hz)	Part No.	
10	27,000	35 × 80	0.45	4.30	ELXA100LGB273TA80U	50	10,000	35 × 80	0.25	3.70	ELXA500LGB103TA80U	
	33,000	35 × 80	0.45	4.70	ELXA100LGB333TA80U		12,000	35 × 100	0.25	4.40	ELXA500LGB123TAA0U	
	39,000	35 × 80	0.45	5.30	ELXA100LGB393TA80U		15,000	35 × 120	0.30	4.70	ELXA500LGB153TAC0U	
	47,000	35 × 100	0.45	6.10	ELXA100LGB473TAA0U		18,000	50 × 80	0.35	4.80	ELXA500LGC183TC80U	
	56,000	35 × 100	0.50	6.20	ELXA100LGB563TAA0U		22,000	50 × 100	0.35	5.90	ELXA500LGC223TCA0U	
	68,000	35 × 120	0.60	6.80	ELXA100LGB683TAC0U		27,000	50 × 120	0.35	7.00	ELXA500LGC273TCC0U	
	82,000	50 × 80	0.60	7.80	ELXA100LGC823TC80U		33,000	63.5 × 100	0.40	7.60	ELXA500LGC333TDA0U	
	100,000	50 × 100	0.70	8.50	ELXA100LGC104TCA0U		39,000	63.5 × 120	0.40	8.90	ELXA500LGC393TDC0U	
	120,000	50 × 100	0.70	9.50	ELXA100LGC124TCA0U		47,000	63.5 × 120	0.40	9.80	ELXA500LGC473TDC0U	
	150,000	63.5 × 100	0.80	11.0	ELXA100LGC154TDA0U		56,000	76.2 × 120	0.40	11.9	ELXA500LGC563TEC0U	
	180,000	63.5 × 100	0.80	12.1	ELXA100LGC184TDA0U		68,000	76.2 × 140	0.45	13.1	ELXA500LGC683TEE0U	
	220,000	76.2 × 100	1.00	13.2	ELXA100LGC224TEA0U		82,000	89 × 140	0.50	14.8	ELXA500LGC823TFE0U	
	270,000	76.2 × 120	1.20	14.4	ELXA100LGC274TEC0U		63	2,700	35 × 50	0.15	1.90	ELXA630LGB272TA50U
	330,000	76.2 × 140	1.20	17.0	ELXA100LGC334TEE0U			3,300	35 × 50	0.15	2.10	ELXA630LGB332TA50U
	390,000	89 × 140	1.40	18.6	ELXA100LGC394TFE0U			3,900	35 × 80	0.20	2.70	ELXA630LGB392TA80U
16	15,000	35 × 50	0.45	2.90	ELXA160LGB153TA50U	4,700		35 × 80	0.20	2.90	ELXA630LGB472TA80U	
	18,000	35 × 80	0.45	3.50	ELXA160LGB183TA80U	5,600		35 × 80	0.20	3.20	ELXA630LGB562TA80U	
	22,000	35 × 80	0.45	3.90	ELXA160LGB223TA80U	6,800		35 × 80	0.20	3.50	ELXA630LGB682TA80U	
	27,000	35 × 80	0.45	4.30	ELXA160LGB273TA80U	8,200		35 × 100	0.20	4.20	ELXA630LGB823TAA0U	
	33,000	35 × 100	0.50	4.80	ELXA160LGB333TAA0U	10,000		35 × 120	0.25	4.30	ELXA630LGB103TAC0U	
	39,000	35 × 100	0.50	5.30	ELXA160LGB393TAA0U	12,000		50 × 80	0.25	4.80	ELXA630LGC123TC80U	
	47,000	35 × 120	0.50	6.20	ELXA160LGB473TAC0U	15,000		50 × 100	0.25	5.90	ELXA630LGC153TCA0U	
	56,000	50 × 80	0.60	6.30	ELXA160LGC563TC80U	18,000		50 × 120	0.25	6.30	ELXA630LGC183TCC0U	
	68,000	50 × 100	0.60	7.60	ELXA160LGC683TCA0U	22,000		50 × 120	0.30	6.70	ELXA630LGC223TCC0U	
	82,000	50 × 120	0.70	8.30	ELXA160LGC823TCC0U	27,000		63.5 × 120	0.30	8.80	ELXA630LGC273TDC0U	
	100,000	50 × 120	0.70	9.20	ELXA160LGC104TCC0U	33,000		76.2 × 100	0.30	10.0	ELXA630LGC333TEA0U	
	120,000	63.5 × 100	0.80	9.90	ELXA160LGC124TDA0U	39,000		76.2 × 120	0.35	10.7	ELXA630LGC393TEC0U	
	150,000	76.2 × 100	0.80	12.3	ELXA160LGC154TEA0U	47,000	76.2 × 140	0.35	12.5	ELXA630LGC473TEE0U		
	180,000	76.2 × 120	0.80	14.5	ELXA160LGC184TEC0U	56,000	89 × 140	0.40	13.8	ELXA630LGC563TFE0U		
	220,000	76.2 × 140	1.00	15.2	ELXA160LGC224TEE0U	80	2,200	35 × 50	0.15	1.90	ELXA800LGB222TA50U	
270,000	89 × 140	1.20	16.8	ELXA160LGC274TFE0U	2,700		35 × 80	0.15	2.20	ELXA800LGB272TA80U		
25	12,000	35 × 80	0.35	3.30	ELXA250LGB123TA80U		3,300	35 × 80	0.15	2.50	ELXA800LGB332TA80U	
	15,000	35 × 80	0.35	3.70	ELXA250LGB153TA80U		3,900	35 × 80	0.15	2.90	ELXA800LGB392TA80U	
	18,000	35 × 80	0.35	4.00	ELXA250LGB183TA80U		4,700	35 × 100	0.15	3.10	ELXA800LGB472TAA0U	
	22,000	35 × 80	0.35	4.50	ELXA250LGB223TA80U		5,600	35 × 100	0.15	3.50	ELXA800LGB562TAA0U	
	27,000	35 × 100	0.40	5.00	ELXA250LGB273TAA0U		6,800	35 × 120	0.20	4.10	ELXA800LGB682TAC0U	
	33,000	35 × 120	0.40	5.90	ELXA250LGB333TAC0U		8,200	50 × 80	0.20	4.80	ELXA800LGC822TC80U	
	39,000	50 × 80	0.40	6.50	ELXA250LGC393TC80U		10,000	50 × 100	0.20	5.60	ELXA800LGC103TCA0U	
	47,000	50 × 100	0.40	7.90	ELXA250LGC473TCA0U		12,000	50 × 100	0.20	6.10	ELXA800LGC123TCA0U	
	56,000	50 × 120	0.40	8.80	ELXA250LGC563TCC0U		15,000	50 × 120	0.20	7.40	ELXA800LGC153TCC0U	
	68,000	50 × 120	0.50	9.10	ELXA250LGC683TCC0U		18,000	63.5 × 120	0.25	8.00	ELXA800LGC183TDC0U	
	82,000	63.5 × 100	0.50	10.6	ELXA250LGC823TDA0U		22,000	76.2 × 100	0.25	9.10	ELXA800LGC223TEA0U	
	100,000	63.5 × 120	0.60	11.4	ELXA250LGC104TDC0U		27,000	76.2 × 120	0.30	9.70	ELXA800LGC273TEC0U	
	120,000	76.2 × 100	0.60	12.8	ELXA250LGC124TEA0U		33,000	76.2 × 140	0.30	11.5	ELXA800LGC333TEE0U	
	150,000	76.2 × 120	0.75	13.7	ELXA250LGC154TEC0U	39,000	89 × 140	0.35	12.5	ELXA800LGC393TFE0U		
	180,000	76.2 × 140	0.75	16.1	ELXA250LGC184TEE0U	100	1,200	35 × 50	0.15	1.40	ELXA101LGB122TA50U	
220,000	89 × 140	1.00	16.6	ELXA250LGC224TFE0U	1,500		35 × 80	0.15	1.60	ELXA101LGB152TA80U		
35	8,200	35 × 80	0.30	3.00	ELXA350LGB822TA80U		1,800	35 × 80	0.15	1.80	ELXA101LGB182TA80U	
	10,000	35 × 80	0.30	3.30	ELXA350LGB103TA80U		2,200	35 × 80	0.15	2.00	ELXA101LGB222TA80U	
	12,000	35 × 80	0.30	3.60	ELXA350LGB123TA80U		2,700	35 × 80	0.15	2.40	ELXA101LGB272TA80U	
	15,000	35 × 80	0.30	4.10	ELXA350LGB153TA80U		3,300	35 × 100	0.15	2.80	ELXA101LGB332TAA0U	
	18,000	35 × 100	0.30	4.80	ELXA350LGB183TAA0U		3,900	35 × 120	0.15	3.10	ELXA101LGB392TAC0U	
	22,000	35 × 120	0.35	5.20	ELXA350LGB223TAC0U		4,700	50 × 80	0.15	3.60	ELXA101LGC472TC80U	
	27,000	50 × 80	0.40	5.90	ELXA350LGC273TC80U		5,600	50 × 100	0.15	4.30	ELXA101LGC562TCA0U	
	33,000	50 × 100	0.40	6.60	ELXA350LGC333TCA0U		6,800	50 × 120	0.15	5.00	ELXA101LGC682TCC0U	
	39,000	50 × 120	0.40	7.80	ELXA350LGC393TCC0U		8,200	50 × 120	0.15	5.50	ELXA101LGC822TCC0U	
	47,000	50 × 120	0.45	8.00	ELXA350LGC473TCC0U		10,000	63.5 × 100	0.15	6.40	ELXA101LGC103TDA0U	
	56,000	63.5 × 100	0.45	9.20	ELXA350LGC563TDA0U		12,000	63.5 × 120	0.20	6.60	ELXA101LGC123TDC0U	
	68,000	63.5 × 120	0.45	11.0	ELXA350LGC683TDC0U		15,000	76.2 × 100	0.20	7.50	ELXA101LGC153TEA0U	
	82,000	76.2 × 120	0.50	12.7	ELXA350LGC823TEC0U		18,000	76.2 × 120	0.25	8.00	ELXA101LGC183TEC0U	
	100,000	76.2 × 140	0.60	13.5	ELXA350LGC104TEE0U	22,000	76.2 × 140	0.25	9.40	ELXA101LGC223TEE0U		
	120,000	89 × 140	0.60	16.1	ELXA350LGC124TFE0U	27,000	89 × 140	0.30	10.4	ELXA101LGC273TFE0U		
50	3,900	35 × 50	0.20	2.00	ELXA500LGB392TA50U	160	680	35 × 50	0.15	1.10	ELXA161LGB681TA50U	
	4,700	35 × 50	0.25	2.20	ELXA500LGB472TA50U		820	35 × 80	0.15	1.20	ELXA161LGB821TA80U	
	5,600	35 × 80	0.25	2.80	ELXA500LGB562TA80U		1,000	35 × 80	0.15	1.30	ELXA161LGB102TA80U	
	6,800	35 × 80	0.25	3.00	ELXA500LGB682TA80U		1,200	35 × 80	0.15	1.50	ELXA161LGB122TA80U	
	8,200	35 × 80	0.25	3.30	ELXA500LGB822TA80U		1,500	35 × 80	0.15	1.70	ELXA161LGB152TA80U	

Product specifications in this catalog are subject to change without notice. Request our product specifications before purchase and/or use. Please use our products based on the information contained in this catalog and product specifications.

◆ STANDARD RATINGS

WV (V _{dc})	Cap (μF)	Case size φD×L(mm)	tan δ	Rated ripple current (Arms/105°C, 120Hz)	Part No.	WV (V _{dc})	Cap (μF)	Case size φD×L(mm)	tan δ	Rated ripple current (Arms/105°C, 120Hz)	Part No.
160	1,800	35 × 100	0.15	2.00	ELXA161LGB182TAA0U	400	680	50 × 60	0.20	3.00	ELXA401LGC681MC60U
	2,200	35 × 120	0.15	2.30	ELXA161LGB222TAC0U		1,200	50 × 85	0.20	4.70	ELXA401LGC122MC85U
	2,700	35 × 120	0.15	2.70	ELXA161LGB272TAC0U		1,800	50 × 105	0.20	6.30	ELXA401LGC182MCA5U
	3,300	50 × 100	0.15	3.30	ELXA161LGC332TCA0U		2,200	50 × 125	0.20	7.50	ELXA401LGC222MCC5U
	3,900	50 × 120	0.15	3.80	ELXA161LGC392TCC0U		2,200	63.5 × 85	0.20	7.30	ELXA401LGC222MD85U
	4,700	50 × 120	0.15	4.20	ELXA161LGC472TCC0U		2,700	50 × 145	0.20	8.90	ELXA401LGC272MCE5U
	5,600	50 × 120	0.15	4.70	ELXA161LGC562TCC0U		2,700	63.5 × 105	0.20	8.80	ELXA401LGC272MDA5U
	6,800	63.5 × 120	0.15	5.70	ELXA161LGC682TDC0U		3,300	63.5 × 125	0.20	10.5	ELXA401LGC332MDC5U
	8,200	76.2 × 100	0.20	6.40	ELXA161LGC822TEA0U		3,300	76.2 × 85	0.20	9.90	ELXA401LGC332ME85U
	10,000	76.2 × 120	0.20	6.60	ELXA161LGC103TEC0U		4,700	63.5 × 145	0.20	13.4	ELXA401LGC472MDE5U
	12,000	76.2 × 140	0.20	7.80	ELXA161LGC123TEE0U		4,700	76.2 × 125	0.20	13.9	ELXA401LGC472MCE5U
15,000	89 × 140	0.20	9.50	ELXA161LGC153TFE0U	6,800	76.2 × 145	0.20	17.9	ELXA401LGC682MEE5U		
200	470	35 × 50	0.15	0.90	ELXA201LGB471TA50U	6,800	89 × 125	0.20	17.2	ELXA401LGC682MFC5U	
	560	35 × 80	0.15	1.00	ELXA201LGB561TA80U	8,200	76.2 × 190	0.20	20.8	ELXA401LGC822MEK0U	
	680	35 × 80	0.15	1.10	ELXA201LGB681TA80U	8,200	89 × 145	0.20	20.1	ELXA401LGC822MFE5U	
	820	35 × 80	0.15	1.30	ELXA201LGB821TA80U	12,000	89 × 190	0.20	27.4	ELXA401LGC123MFK0U	
	1,000	35 × 100	0.15	1.50	ELXA201LGB102TAA0U	18,000	89 × 270	0.20	39.4	ELXA401LGC183MFT0U	
	1,200	35 × 120	0.15	1.70	ELXA201LGB122TAC0U	450	560	50 × 60	0.20	2.60	ELXA451LGC561MC60U
	1,500	35 × 120	0.15	1.90	ELXA201LGB152TAC0U		1,000	50 × 85	0.20	4.00	ELXA451LGC102MC85U
	1,800	50 × 80	0.15	2.20	ELXA201LGC182TC80U		1,200	50 × 105	0.20	4.80	ELXA451LGC122MCA5U
	2,200	50 × 100	0.15	2.70	ELXA201LGC222TCA0U		1,800	50 × 125	0.20	6.40	ELXA451LGC182MCC5U
	2,700	50 × 120	0.15	3.20	ELXA201LGC272TCC0U		1,800	63.5 × 85	0.20	6.20	ELXA451LGC182MD85U
	3,300	50 × 120	0.15	3.50	ELXA201LGC332TCC0U		2,200	50 × 145	0.20	7.60	ELXA451LGC222MCE5U
3,900	63.5 × 100	0.15	4.00	ELXA201LGC392TDA0U	2,200		63.5 × 105	0.20	7.50	ELXA451LGC222MDA5U	
4,700	63.5 × 120	0.15	4.70	ELXA201LGC472TDC0U	2,700		63.5 × 125	0.20	8.90	ELXA451LGC272MDC5U	
5,600	76.2 × 100	0.15	5.30	ELXA201LGC562TEA0U	2,700		76.2 × 85	0.20	8.40	ELXA451LGC272ME85U	
6,800	76.2 × 120	0.15	6.30	ELXA201LGC682TEC0U	3,300		63.5 × 145	0.20	10.6	ELXA451LGC332MDE5U	
8,200	76.2 × 140	0.20	6.40	ELXA201LGC822TEE0U	3,300		76.2 × 105	0.20	10.2	ELXA451LGC332MEA5U	
10,000	89 × 140	0.20	7.70	ELXA201LGC103TFE0U	3,900	76.2 × 125	0.20	11.9	ELXA451LGC392MEC5U		
250	330	35 × 50	0.15	0.70	ELXA251LGB331TA50U	4,700	76.2 × 145	0.20	14.0	ELXA451LGC472MEE5U	
	390	35 × 80	0.15	0.80	ELXA251LGB391TA80U	5,600	89 × 125	0.20	14.2	ELXA451LGC562MFC5U	
	470	35 × 80	0.15	0.90	ELXA251LGB471TA80U	6,800	76.2 × 190	0.20	17.3	ELXA451LGC682MEK0U	
	560	35 × 80	0.15	1.00	ELXA251LGB561TA80U	6,800	89 × 145	0.20	16.7	ELXA451LGC682MFE5U	
	680	35 × 100	0.15	1.20	ELXA251LGB681TAA0U	10,000	89 × 190	0.20	22.8	ELXA451LGC103MFK0U	
	820	35 × 100	0.15	1.40	ELXA251LGB821TAA0U	15,000	89 × 270	0.20	32.8	ELXA451LGC153MFT0U	
	1,000	35 × 120	0.15	1.60	ELXA251LGB102TAC0U	500	470	50 × 60	0.20	2.40	ELXA501LGC471MC60U
	1,200	50 × 80	0.15	1.80	ELXA251LGC122TC80U		820	50 × 85	0.20	3.60	ELXA501LGC821MC85U
	1,500	50 × 100	0.15	2.20	ELXA251LGC152TCA0U		1,000	50 × 105	0.20	4.40	ELXA501LGC102MCA5U
	1,800	50 × 120	0.15	2.60	ELXA251LGC182TCC0U		1,200	50 × 125	0.20	5.20	ELXA501LGC122MCC5U
	2,200	50 × 120	0.15	2.80	ELXA251LGC222TCC0U		1,200	63.5 × 85	0.20	5.00	ELXA501LGC122MD85U
2,700	63.5 × 100	0.15	3.30	ELXA251LGC272TDA0U	1,500		50 × 145	0.20	6.30	ELXA501LGC152MCE5U	
3,300	63.5 × 120	0.15	4.00	ELXA251LGC332TDC0U	1,800		63.5 × 105	0.20	6.80	ELXA501LGC182MDA5U	
3,900	76.2 × 100	0.15	4.40	ELXA251LGC392TEA0U	2,700		63.5 × 145	0.20	9.60	ELXA501LGC272MDE5U	
4,700	76.2 × 120	0.15	5.20	ELXA251LGC472TEC0U	2,700		76.2 × 105	0.20	9.20	ELXA501LGC272MEA5U	
5,600	76.2 × 140	0.15	6.10	ELXA251LGC562TEE0U	3,900		76.2 × 145	0.20	12.7	ELXA501LGC392MEE5U	
6,800	89 × 140	0.15	7.40	ELXA251LGC682TFE0U	3,900		89 × 125	0.20	11.9	ELXA501LGC392MFC5U	
350	820	50 × 60	0.20	3.30	ELXA351LGC821MC60U	6,800	89 × 190	0.20	18.8	ELXA501LGC682MFK0U	
	1,500	50 × 85	0.20	5.20	ELXA351LGC152MC85U	10,000	89 × 270	0.20	26.8	ELXA501LGC103MFT0U	
	2,200	50 × 105	0.20	7.00	ELXA351LGC222MCA5U	525	390	50 × 60	0.20	2.20	ELXA5C1LGC391MC60U
	2,700	50 × 125	0.20	8.40	ELXA351LGC272MCC5U		680	50 × 85	0.20	3.30	ELXA5C1LGC681MC85U
	2,700	63.5 × 85	0.20	8.10	ELXA351LGC272MD85U		1,000	50 × 125	0.20	4.80	ELXA5C1LGC102MCC5U
	3,300	50 × 145	0.20	9.90	ELXA351LGC332MCE5U		1,500	63.5 × 105	0.20	6.20	ELXA5C1LGC152MDA5U
	3,300	63.5 × 105	0.20	9.80	ELXA351LGC332MDA5U		1,800	63.5 × 125	0.20	7.30	ELXA5C1LGC182MDC5U
	3,900	63.5 × 125	0.20	11.5	ELXA351LGC392MDC5U		2,200	63.5 × 145	0.20	8.60	ELXA5C1LGC222MDE5U
	3,900	76.2 × 85	0.20	10.8	ELXA351LGC392ME85U		2,200	76.2 × 105	0.20	8.30	ELXA5C1LGC222MEA5U
	5,600	63.5 × 145	0.20	14.7	ELXA351LGC562MDE5U		2,700	76.2 × 125	0.20	9.90	ELXA5C1LGC272MEC5U
	6,800	76.2 × 125	0.20	16.8	ELXA351LGC682MEC5U		3,300	76.2 × 145	0.20	11.7	ELXA5C1LGC332MEE5U
8,200	76.2 × 145	0.20	19.6	ELXA351LGC822MEE5U	4,700		76.2 × 190	0.20	14.4	ELXA5C1LGC472MEK0U	
8,200	89 × 125	0.20	18.9	ELXA351LGC822MFC5U	4,700		89 × 145	0.20	13.9	ELXA5C1LGC472MFE5U	
10,000	76.2 × 190	0.20	23.0	ELXA351LGC103MEK0U	5,600	89 × 190	0.20	17.1	ELXA5C1LGC562MFK0U		
10,000	89 × 145	0.20	22.2	ELXA351LGC103MFE5U							
15,000	89 × 190	0.20	30.6	ELXA351LGC153MFK0U							
22,000	89 × 270	0.20	43.5	ELXA351LGC223MFT0U							



LXA Series

◆ RATED RIPPLE CURRENT MULTIPLIERS

● Frequency Multipliers

Frequency (Hz)	50	120	300	1k	3k	10k	50k
10 to 50V _{dc}	0.95	1.00	1.03	1.05	—	1.09	1.12
63 to 80V _{dc}	0.90	1.00	1.06	1.10	—	1.18	1.22
100 to 250V _{dc}	0.80	1.00	1.12	1.22	—	1.30	1.33
350 to 525V _{dc}	0.80	1.00	1.20	1.50	1.60	—	—

The deterioration of aluminum electrolytic capacitors accelerates their life due to the internal heating produced by ripple current. For details, refer to Section "5-3 Ripple Current Effect on Lifetime" in the catalog, Technical Note.

Also, for the LXA series capacitors (350 to 525V_{dc} products), using them at operating voltage can extend their lifetime. For details, please contact a representative of Nippon Chemi-con.

LXR Series

- Higher ripple capability than LXA series
- Endurance with ripple current : 5,000 hours at 105°C
- RoHS2 Compliant

LXR

Higher ripple
LXA



SPECIFICATIONS

Items	Characteristics						
Category	-25 to +105°C						
Temperature Range							
Rated Voltage Range	350 to 450V _{dc}						
Capacitance Tolerance	±20% (M) (at 20°C, 120Hz)						
Leakage Current	I=0.02CV or 5mA, whichever is smaller. Where, I : Max. leakage current (μA), C : Nominal capacitance (μF), V : Rated voltage (V) (at 20°C after 5 minutes)						
Dissipation Factor (tan δ)	0.15max. (at 20°C, 120Hz)						
Low Temperature Characteristics	Capacitance change $C(-25°C)/C(+20°C) \geq 0.7$ (at 120Hz)						
Insulation Resistance	When measured between the terminals that are connected to each other and to the mounting clamp on the insulating sleeve covering the case by using an insulation resistance meter of 500V _{dc} , the insulation resistance shall not be less than 100MΩ.						
Insulation Withstanding Voltage	When a voltage of 2,000V _{ac} is applied for 1 minute between the terminals that are connected to each other and to the mounting clamp on the insulating sleeve covering the case, there shall not be electrical damage.						
Endurance	The following specifications shall be satisfied when the capacitors are restored to 20°C after subjected to DC voltage with the rated ripple current is applied (the peak voltage shall not exceed the rated voltage) for 5,000 hours at 105°C. <table border="1"> <tr> <td>Capacitance change</td> <td>≤ ±20% of the initial value</td> </tr> <tr> <td>D.F. (tan δ)</td> <td>≤ 200% of the initial specified value</td> </tr> <tr> <td>Leakage current</td> <td>≤ The initial specified value</td> </tr> </table>	Capacitance change	≤ ±20% of the initial value	D.F. (tan δ)	≤ 200% of the initial specified value	Leakage current	≤ The initial specified value
Capacitance change	≤ ±20% of the initial value						
D.F. (tan δ)	≤ 200% of the initial specified value						
Leakage current	≤ The initial specified value						
Shelf Life	The following specifications shall be satisfied when the capacitors are restored to 20°C after exposing them for 1,000 hours at 105°C without voltage applied. Before the measurement, the capacitor shall be preconditioned by applying voltage according to Item 4.1 of JIS C 5101-4. <table border="1"> <tr> <td>Capacitance change</td> <td>≤ ±20% of the initial value</td> </tr> <tr> <td>D.F. (tan δ)</td> <td>≤ 200% of the initial specified value</td> </tr> <tr> <td>Leakage current</td> <td>≤ The initial specified value</td> </tr> </table>	Capacitance change	≤ ±20% of the initial value	D.F. (tan δ)	≤ 200% of the initial specified value	Leakage current	≤ The initial specified value
Capacitance change	≤ ±20% of the initial value						
D.F. (tan δ)	≤ 200% of the initial specified value						
Leakage current	≤ The initial specified value						

DIMENSIONS (Screw-Mount) [mm]

Terminal Code : LG

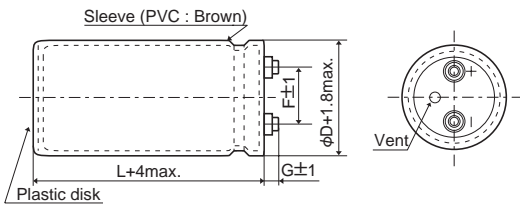

φ63.5 & φ76.2 : G=6
φ89 : G=4
φ100 : G=10

<Screw specifications>

to φ89 Plus hexagon-headed screw :M5×0.8×10
Maximum screw tightening torque :3.23Nm

Mounting Clamp Code : B

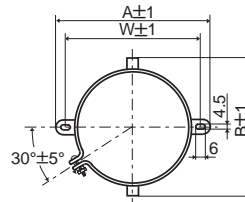

φD	A	B	W	F
63.5	90	76	80	28.0
76.2	104.5	90	93.5	31.5

Mounting Clamp Code : C

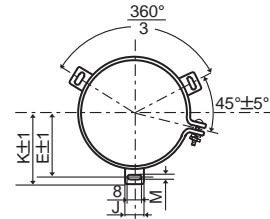

φD	E	K	M	F	J
63.5	38.1	43.5	4.5	28.0	14.0
76.2	44.5	50.0	4.5	31.5	14.0
89	50.8	56.5	4.5	31.5	16.0
100	56.5	63.4	5.5	41.5	18.0

φ100 Cross-recessed head (Phillips) screw : M8×1.25×16
Spring washer, Washer
Maximum screw tightening torque :6.31Nm

* The screw and the mounting clamp are separately supplied and not attached to the product.

PART NUMBERING SYSTEM

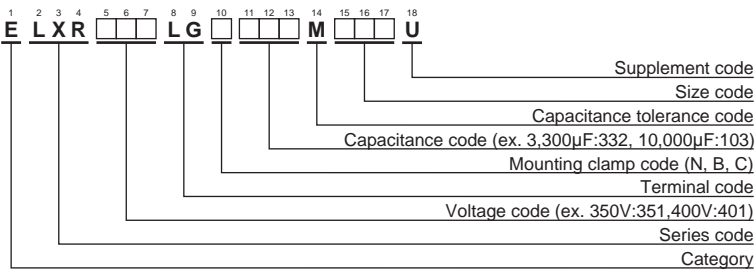

Please refer to "Product code guide (screw-mount terminal type)"



LXR Series

◆STANDARD RATINGS

WV (V _{dc})	Cap (μF)	Case size φD×L(mm)	tan δ	Rated ripple current (Arms/105°C, 120Hz)	Part No.	WV (V _{dc})	Cap (μF)	Case size φD×L(mm)	tan δ	Rated ripple current (Arms/105°C, 120Hz)	Part No.
350	3,300	63.5 × 115	0.15	14.4	ELXR351LGC332MDB5U	400	6,800	76.2 × 170	0.15	27.3	ELXR401LGC682MEH0U
	3,900	63.5 × 130	0.15	16.6	ELXR351LGC392MDD0U		6,800	89 × 155	0.15	26.6	ELXR401LGC682MFF5U
	4,700	63.5 × 155	0.15	19.8	ELXR351LGC472MDF5U		8,200	89 × 170	0.15	30.5	ELXR401LGC822MFH0U
	4,700	76.2 × 115	0.15	19.1	ELXR351LGC472MEB5U		10,000	100 × 190	0.15	34.5	ELXR401LGC103MGK0U
	5,600	63.5 × 170	0.15	22.5	ELXR351LGC562MDH0U		12,000	100 × 220	0.15	40.2	ELXR401LGC123MGN0U
	5,600	76.2 × 130	0.15	21.9	ELXR351LGC562MED0U		450	2,200	63.5 × 115	0.15	11.8
	6,800	76.2 × 155	0.15	26.2	ELXR351LGC682MEF5U	2,700		63.5 × 130	0.15	13.7	ELXR451LGC272MDD0U
	8,200	76.2 × 170	0.15	30.0	ELXR351LGC822MEH0U	2,700		76.2 × 115	0.15	14.5	ELXR451LGC272MEB5U
	8,200	89 × 155	0.15	29.2	ELXR351LGC822MFF5U	3,300		63.5 × 155	0.15	16.5	ELXR451LGC332MDF5U
	10,000	89 × 170	0.15	33.7	ELXR351LGC103MFH0U	3,300		76.2 × 130	0.15	16.9	ELXR451LGC332MED0U
	12,000	100 × 190	0.15	37.8	ELXR351LGC123MGK0U	3,900		63.5 × 170	0.15	18.7	ELXR451LGC392MDH0U
	15,000	100 × 250	0.15	47.7	ELXR351LGC153MGR0U	4,700		76.2 × 155	0.15	21.7	ELXR451LGC472MEF5U
400	2,700	63.5 × 115	0.15	13.1	ELXR401LGC272MDB5U	5,600		76.2 × 190	0.15	26.1	ELXR451LGC562MEK0U
	3,300	63.5 × 130	0.15	15.2	ELXR401LGC332MDD0U	5,600		89 × 155	0.15	24.1	ELXR451LGC562MFF5U
	3,900	63.5 × 155	0.15	17.9	ELXR401LGC392MDF5U	6,800		89 × 170	0.15	27.8	ELXR451LGC682MFH0U
	3,900	76.2 × 115	0.15	18.2	ELXR401LGC392MEB5U	8,200	89 × 190	0.15	32.0	ELXR451LGC822MFK0U	
	4,700	63.5 × 170	0.15	20.5	ELXR401LGC472MDH0U	10,000	100 × 220	0.15	36.8	ELXR451LGC103MGN0U	
	4,700	76.2 × 130	0.15	20.1	ELXR401LGC472MED0U	12,000	100 × 250	0.15	42.7	ELXR451LGC123MGR0U	
	5,600	76.2 × 155	0.15	23.8	ELXR401LGC562MEF5U						

◆RATED RIPPLE CURRENT MULTIPLIERS

●Frequency Multipliers

Frequency (Hz)	120	300	1k	3k
Coefficient	1.0	1.1	1.3	1.4

The deterioration of aluminum electrolytic capacitors accelerates their life due to the internal heating produced by ripple current. For details, refer to Section "5-3 Ripple Current Effect on Lifetime" in the catalog, Technical Note.

Also, for the LXR series capacitors, using them at operating voltage less than their rated voltage can extend their lifetime. For details, please contact a representative of Nippon Chemi-Con.

RWV Series



- For frequently change of regenerative voltage from AC servo amplifier and inverter control
- Improved the resistance for charge and discharge from same dimension of RWF series
- Endurance with ripple current : 5,000 hours at 85°C
- Rated voltage range : 350 to 450V_{dc}, Capacitance 820 to 18,000μF
- RoHS2 Compliant

◆ SPECIFICATIONS

Items	Characteristics										
Category Temperature Range	-25 to +85°C										
Rated Voltage Range	350 to 450V _{dc}										
Capacitance Tolerance	±20% (M) (at 20°C, 120Hz)										
Leakage Current	I=0.02CV or 5mA, whichever is smaller. Where, I : Max. leakage current (μA), C : Nominal capacitance (μF), V : Rated voltage (V) (at 20°C after 5 minutes)										
Dissipation Factor (tan δ)	0.25 max. (at 20°C, 120Hz)										
Low Temperature Characteristics	Capacitance change $C(-25°C)/C(+20°C) \geq 0.7$ (at 120Hz)										
Insulation Resistance	When measured between the terminals shorted each other and the mounting clamp on the insulating sleeve covering the case by using an insulation resistance meter of 500V _{dc} , the insulation resistance shall not be less than 100MΩ.										
Insulation Withstanding Voltage	When a voltage of 2,000V _{ac} is applied for 1 minute between the terminals shorted each other and the mounting clamp on the insulating sleeve covering the case, there shall not be electrical damage.										
Charge and Discharge	The following specifications shall be satisfied when the capacitors are restored to 20°C after subjected to charge and discharge test with the voltage waveform shown below at room temperature (15 to 35°C). <table border="1" style="width: 100%; margin-top: 5px;"> <tr> <td>Capacitance change</td> <td>≤ ±20% of the initial value</td> </tr> <tr> <td>D.F. (tan δ)</td> <td>≤ 200% of the initial specified value</td> </tr> <tr> <td>Leakage current</td> <td>≤ The initial specified value</td> </tr> </table> <div style="margin-top: 5px;"> <table border="1" style="width: 100%;"> <tr> <td>Frequency</td> <td>3Hz</td> </tr> <tr> <td>Number of cycles</td> <td>50 million times</td> </tr> </table> </div>	Capacitance change	≤ ±20% of the initial value	D.F. (tan δ)	≤ 200% of the initial specified value	Leakage current	≤ The initial specified value	Frequency	3Hz	Number of cycles	50 million times
Capacitance change	≤ ±20% of the initial value										
D.F. (tan δ)	≤ 200% of the initial specified value										
Leakage current	≤ The initial specified value										
Frequency	3Hz										
Number of cycles	50 million times										
Endurance	The following specifications shall be satisfied when the capacitors are restored to 20°C after subjected to DC voltage with the rated ripple current is applied (the peak voltage shall not exceed the rated voltage) for 5,000 hours at 85°C. <table border="1" style="width: 100%; margin-top: 5px;"> <tr> <td>Capacitance change</td> <td>≤ ±20% of the initial value</td> </tr> <tr> <td>D.F. (tan δ)</td> <td>≤ 200% of the initial specified value</td> </tr> <tr> <td>Leakage current</td> <td>≤ The initial specified value</td> </tr> </table>	Capacitance change	≤ ±20% of the initial value	D.F. (tan δ)	≤ 200% of the initial specified value	Leakage current	≤ The initial specified value				
Capacitance change	≤ ±20% of the initial value										
D.F. (tan δ)	≤ 200% of the initial specified value										
Leakage current	≤ The initial specified value										
Shelf Life	The following specifications shall be satisfied when the capacitors are restored to 20°C after exposing them for 500 hours at 85°C without voltage applied. Before the measurement, the capacitor shall be preconditioned by applying voltage according to Item 4.1 of JIS C 5101-4. <table border="1" style="width: 100%; margin-top: 5px;"> <tr> <td>Capacitance change</td> <td>≤ ±20% of the initial value</td> </tr> <tr> <td>D.F. (tan δ)</td> <td>≤ 200% of the initial specified value</td> </tr> <tr> <td>Leakage current</td> <td>≤ The initial specified value</td> </tr> </table>	Capacitance change	≤ ±20% of the initial value	D.F. (tan δ)	≤ 200% of the initial specified value	Leakage current	≤ The initial specified value				
Capacitance change	≤ ±20% of the initial value										
D.F. (tan δ)	≤ 200% of the initial specified value										
Leakage current	≤ The initial specified value										

◆ DIMENSIONS (Screw-Mount) [mm]

● Terminal Code : LG

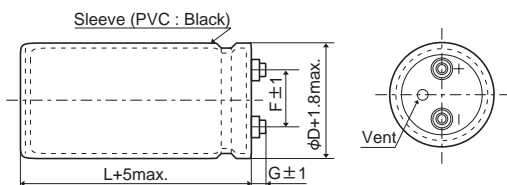

φ50 & φ63.5 : G=6
φ76.2 & φ89 : G=5

● Mounting Clamp Code : B

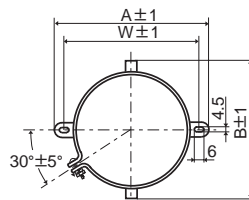

φD	A	B	W	F
50	78.0	64.0	68.0	22.4
63.5	90.0	76.0	80.0	28.0
76.2	104.5	90.0	93.5	31.5

● Mounting Clamp Code : C

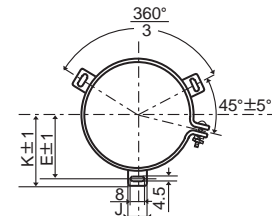

φD	E	K	F	J
50	32.5	37.0	22.4	14.0
63.5	38.1	43.5	28.0	14.0
76.2	44.5	50.0	31.5	14.0
89	50.8	56.5	31.5	16.0

<Screw specifications>

Plus hexagon-headed screw :M5×0.8×10

Maximum screw tightening torque :3.23Nm

* The screw and the mounting clamp are separately supplied and not attached to the product.

◆PART NUMBERING SYSTEM

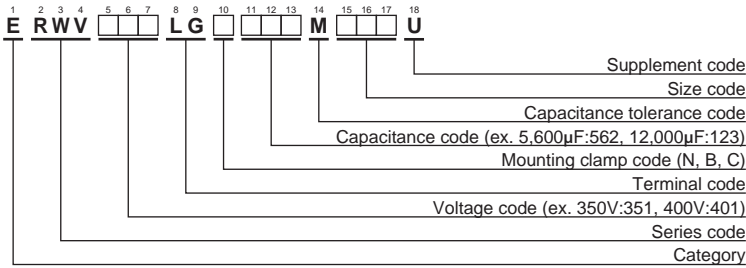

Please refer to "Product code guide (screw-mount terminal type)"

◆STANDARD RATINGS

WV (V _{dc})	Cap (μF)	Case size φD×L(mm)	Rated ripple current (Arms/ 85°C, 120Hz)	Effective value of charge and discharge current (Arms/ 3Hz)	Part No.	WV (V _{dc})	Cap (μF)	Case size φD×L(mm)	Rated ripple current (Arms/ 85°C, 120Hz)	Effective value of charge and discharge current (Arms/ 3Hz)	Part No.	
350	1,200	50 × 60	4.70	1.56	ERWV351LGC122MC60U	400	5,600	63.5 × 170	17.1	5.99	ERWV401LGC562MDH0U	
	1,500	50 × 70	5.50	1.83	ERWV351LGC152MC70U		5,600	76.2 × 105	15.2	5.35	ERWV401LGC562MEA5U	
	1,800	50 × 80	6.40	2.13	ERWV351LGC182MC80U		6,800	76.2 × 130	18.4	6.47	ERWV401LGC682MED0U	
	2,200	50 × 96	7.60	2.53	ERWV351LGC222MC96U		8,200	76.2 × 155	21.9	7.68	ERWV401LGC822MEF5U	
	2,700	50 × 105	8.80	2.94	ERWV351LGC272MCA5U		8,200	76.2 × 170	22.8	8.02	ERWV401LGC822MEH0U	
	2,700	50 × 115	9.20	3.06	ERWV351LGC272MCB5U		8,200	89 × 115	20.9	7.35	ERWV401LGC822MFB5U	
	3,300	50 × 130	10.8	3.58	ERWV351LGC332MCD0U		10,000	89 × 130	24.3	8.26	ERWV401LGC103MFD0U	
	4,700	63.5 × 115	13.2	4.61	ERWV351LGC472MDB5U		12,000	89 × 155	28.7	10.0	ERWV401LGC123MFF5U	
	5,600	63.5 × 130	15.2	5.30	ERWV351LGC562MDD0U		12,000	89 × 170	29.9	10.5	ERWV401LGC123MFH0U	
	5,600	76.2 × 105	15.2	5.36	ERWV351LGC562MEA5U		15,000	89 × 190	35.2	12.3	ERWV401LGC153MFK0U	
	6,800	63.5 × 155	18.1	6.32	ERWV351LGC682MDF5U		420	820	50 × 60	3.80	1.29	ERWV421LGC821MC60U
	8,200	63.5 × 170	20.7	7.25	ERWV351LGC822MDH0U			1,000	50 × 70	4.40	1.50	ERWV421LGC102MC70U
	8,200	76.2 × 130	20.2	6.57	ERWV351LGC822MED0U			1,200	50 × 80	5.20	1.75	ERWV421LGC122MC80U
	10,000	76.2 × 155	24.2	8.47	ERWV351LGC103MEF5U			1,800	50 × 96	6.80	2.30	ERWV421LGC182MC96U
	10,000	89 × 115	23.1	8.10	ERWV351LGC103MFB5U			1,800	50 × 105	7.10	2.40	ERWV421LGC182MCA5U
	12,000	76.2 × 170	27.6	9.66	ERWV351LGC123MEH0U			2,200	50 × 115	8.20	2.77	ERWV421LGC222MCB5U
	12,000	89 × 130	26.6	9.33	ERWV351LGC123MFD0U			2,700	50 × 130	9.60	3.25	ERWV421LGC272MCD0U
	15,000	89 × 155	32.1	11.2	ERWV351LGC153MFF5U			3,300	63.5 × 115	11.0	3.87	ERWV421LGC332MDB5U
15,000	89 × 170	33.5	11.7	ERWV351LGC153MFH0U	3,900	63.5 × 130		12.7	4.44	ERWV421LGC392MDD0U		
18,000	89 × 190	38.5	13.5	ERWV351LGC183MFK0U	4,700	63.5 × 155		15.0	5.28	ERWV421LGC472MDB5U		
375	1,000	50 × 60	4.30	1.42	ERWV3H1LGC102MC60U	4,700		76.2 × 105	13.9	4.92	ERWV421LGC472MEA5U	
	1,200	50 × 70	4.90	1.64	ERWV3H1LGC122MC70U	5,600		63.5 × 170	17.1	6.02	ERWV421LGC562MDH0U	
	1,500	50 × 80	5.80	1.94	ERWV3H1LGC152MC80U	5,600		76.2 × 130	16.6	5.90	ERWV421LGC562MED0U	
	2,200	50 × 96	7.60	2.54	ERWV3H1LGC222MC96U	6,800		76.2 × 155	19.8	7.02	ERWV421LGC682MEF5U	
	2,200	50 × 105	8.00	2.65	ERWV3H1LGC222MCA5U	6,800		89 × 115	19.0	6.73	ERWV421LGC682MFB5U	
	2,700	50 × 115	9.20	3.06	ERWV3H1LGC272MCB5U	8,200		76.2 × 170	22.7	8.04	ERWV421LGC822MEH0U	
	3,300	50 × 130	10.8	3.58	ERWV3H1LGC332MCD0U	8,200		89 × 130	22.0	7.78	ERWV421LGC822MFD0U	
	4,700	63.5 × 115	13.2	4.61	ERWV3H1LGC472MDB5U	10,000		89 × 155	26.2	9.24	ERWV421LGC103MFF5U	
	5,600	63.5 × 130	15.2	5.30	ERWV3H1LGC562MDD0U	12,000	89 × 170	29.9	10.5	ERWV421LGC123MFH0U		
	5,600	76.2 × 105	15.2	5.36	ERWV3H1LGC562MEA5U	12,000	89 × 190	31.5	11.0	ERWV421LGC123MFK0U		
	6,800	63.5 × 155	18.1	6.32	ERWV3H1LGC682MDF5U	450	820	50 × 60	3.80	1.29	ERWV451LGC821MC60U	
	6,800	63.5 × 170	18.9	6.60	ERWV3H1LGC682MDH0U		1,000	50 × 70	4.40	1.50	ERWV451LGC102MC70U	
	8,200	76.2 × 130	20.2	7.09	ERWV3H1LGC822MCD0U		1,200	50 × 80	5.20	1.74	ERWV451LGC122MC80U	
	8,200	89 × 115	20.9	7.35	ERWV3H1LGC822MFB5U		1,500	50 × 96	6.20	2.10	ERWV451LGC152MC96U	
	10,000	76.2 × 155	24.2	8.48	ERWV3H1LGC103MEF5U		1,800	50 × 105	7.10	2.41	ERWV451LGC182MCA5U	
	10,000	76.2 × 170	25.2	8.85	ERWV3H1LGC103MEH0U		1,800	50 × 115	7.40	2.51	ERWV451LGC182MCB5U	
	10,000	89 × 130	24.3	8.54	ERWV3H1LGC103MFD0U		2,200	50 × 130	8.70	2.93	ERWV451LGC222MCD0U	
	12,000	89 × 155	28.7	10.0	ERWV3H1LGC123MFF5U		3,300	63.5 × 115	11.0	3.88	ERWV451LGC332MDB5U	
15,000	89 × 170	33.5	11.7	ERWV3H1LGC153MFH0U	3,900		63.5 × 130	12.7	4.44	ERWV451LGC392MDD0U		
15,000	89 × 190	35.2	12.3	ERWV3H1LGC153MFK0U	3,900		76.2 × 105	13.2	4.49	ERWV451LGC392MEA5U		
400	1,000	50 × 60	4.30	1.42	ERWV401LGC102MC60U		4,700	63.5 × 155	15.0	5.27	ERWV451LGC472MDB5U	
	1,200	50 × 70	4.90	1.64	ERWV401LGC122MC70U		4,700	63.5 × 170	15.6	5.50	ERWV451LGC472MDH0U	
	1,500	50 × 80	5.80	1.95	ERWV401LGC152MC80U		5,600	76.2 × 130	16.6	5.88	ERWV451LGC562MED0U	
	1,800	50 × 96	6.90	2.29	ERWV401LGC182MC96U		6,800	76.2 × 155	19.8	7.04	ERWV451LGC682MEF5U	
	2,200	50 × 105	8.00	2.65	ERWV401LGC222MCA5U		6,800	89 × 115	19.0	6.72	ERWV451LGC682MFB5U	
	2,200	50 × 115	8.30	2.77	ERWV401LGC222MCB5U		8,200	76.2 × 170	22.7	7.97	ERWV451LGC822MEH0U	
	2,700	50 × 130	9.80	3.23	ERWV401LGC272MCD0U		8,200	89 × 130	22.0	7.72	ERWV451LGC822MFD0U	
	3,900	63.5 × 115	12.0	4.21	ERWV401LGC392MDB5U		10,000	89 × 155	26.2	9.22	ERWV451LGC103MFF5U	
	4,700	63.5 × 130	13.9	4.86	ERWV401LGC472MDD0U	10,000	89 × 170	27.3	9.66	ERWV451LGC103MFH0U		
	5,600	63.5 × 155	16.4	5.75	ERWV401LGC562MDF5U	12,000	89 × 190	31.5	11.1	ERWV451LGC123MFK0U		



RWV Series

◆ RATED RIPPLE CURRENT MULTIPLIERS

● Frequency Multipliers

Frequency (Hz)	50	120	300	1k	3k
Coefficient	0.8	1.0	1.1	1.3	1.4

The deterioration of aluminum electrolytic capacitors accelerates their life due to the internal heating produced by ripple current. For details, refer to Section "5-3 Ripple Current Effect on Lifetime" in the catalog, Technical Note.

Also, for the RWV series capacitors, using them at operating voltage less than their rated voltage can extend their lifetime. For the details, please contact a representative of Nippon Chemi-Con.

U37F Series



- Large Can
- Screw Terminals
- General Purpose U37 Grade
- High Ripple
- 350 to 500VDC Ratings
- RoHS Compliant
- 5,000 Hours Lifetime at +85°C
- Up to 150,000 Hours Useful Life



The U37F series is a general purpose, screw mount U37 grade series specifically designed to provide the ripple current capability and long life required for high reliability inverter applications. The U37F has an endurance rating of 5,000 hours at +85°C with the rated ripple current applied. The useful life can exceed 150,000 hours at +40°C and 1.5x the ripple current. These capacitors are available in a variety of high current English or Metric thread terminals. Mounting options include a three-footed clamp or bottom threaded stud. Custom designs are also available.

Summary of Specifications

- Screw terminals: high and low post, English and Metric thread.
- Capacitance range: 1,500 to 22,000µF.
- Voltage range: 350 to 500VDC.
- Category temperature range: -40°C to +85°C.
- Leakage current: 0.02CV(µA) or 5mA, whichever is smaller, after 5 minutes at +25°C.
- Standard capacitance tolerance: ±20%
- Nominal case size (D×L): D = 50mm (2.000") to 89mm (3.500"); L = 92mm (3.625") to 219mm (8.625").
- Rated lifetime: 5,000 hours at +85°C with rated ripple current applied.



U37F Series

U37F Specifications - Screw Terminals

Item	Characteristics																																															
Category Temperature Range	-40 to +85°C																																															
Rated Voltage Range	350 to 500VDC																																															
Capacitance Range	1,500 to 22,000µF at +25°C, 120Hz																																															
Capacitance Tolerance	±20% (M) at +25°C, 120Hz																																															
Leakage Current	$I = 0.02CV$ (µA) or 5mA, whichever is smaller, after 5 minutes at +25°C. Where I = Max. leakage current (µA), C = Nominal capacitance (µF) and V = Rated voltage (V)																																															
Rated Ripple Current Multipliers	<p>Ambient Temperature (°C)</p> <table border="1"> <tr> <td>+45°C</td> <td>+65°C</td> <td>+85°C</td> </tr> <tr> <td>2.82</td> <td>1.73</td> <td>1.00</td> </tr> </table> <p>Frequency (Hz)</p> <table border="1"> <tr> <td>DC Rated Voltage</td> <td>50Hz</td> <td>120Hz</td> <td>300Hz</td> <td>1kHz</td> <td>3kHz</td> <td>10kHz</td> </tr> <tr> <td>350-500V</td> <td>0.80</td> <td>1.00</td> <td>1.20</td> <td>1.30</td> <td>1.40</td> <td>1.41</td> </tr> </table> <p>To determine maximum ripple current at a specified temperature and frequency, use the appropriate multiplier shown.</p>	+45°C	+65°C	+85°C	2.82	1.73	1.00	DC Rated Voltage	50Hz	120Hz	300Hz	1kHz	3kHz	10kHz	350-500V	0.80	1.00	1.20	1.30	1.40	1.41																											
+45°C	+65°C	+85°C																																														
2.82	1.73	1.00																																														
DC Rated Voltage	50Hz	120Hz	300Hz	1kHz	3kHz	10kHz																																										
350-500V	0.80	1.00	1.20	1.30	1.40	1.41																																										
Endurance (Load Life)	<p>The following specifications shall be satisfied when the capacitors are restored to +25°C after subjecting them to DC voltage for 5,000 hours at +85°C with the rated ripple current applied. The sum of the DC voltage and peak AC voltage must not exceed the full rated voltage of the capacitors.</p> <p>Capacitance change: ≤ 20% from initial measurement ESR change : ≤ 200% of initial specified limit Leakage current : ≤ initial specified limit</p>																																															
Useful Life	<p>With specified standard voltage and ripple current applied, typical life as function of ambient temperature is listed below.</p> <table border="1"> <tr> <td>+85°C</td> <td>6,500 hours max.</td> <td rowspan="3"> Capacitance change: ≤ 30% from initial measurement ESR change : ≤ 300% of initial specified limit Leakage current : ≤ initial specified limit </td> </tr> <tr> <td>+65°C</td> <td>23,800 hours max.</td> </tr> <tr> <td>+45°C</td> <td>124,700 hours max.</td> </tr> </table>	+85°C	6,500 hours max.	Capacitance change: ≤ 30% from initial measurement ESR change : ≤ 300% of initial specified limit Leakage current : ≤ initial specified limit	+65°C	23,800 hours max.	+45°C	124,700 hours max.																																								
+85°C	6,500 hours max.	Capacitance change: ≤ 30% from initial measurement ESR change : ≤ 300% of initial specified limit Leakage current : ≤ initial specified limit																																														
+65°C	23,800 hours max.																																															
+45°C	124,700 hours max.																																															
Shelf Life	<p>The following specifications shall be satisfied when the capacitors are restored to +25°C after exposing them for 500 hours at +85°C without voltage applied. The rated voltage shall be applied to the capacitors for a minimum of 30 minutes, at least 24 hours and not more than 48 hours before the measurements.</p> <p>Capacitance change: ≤ 20% from initial measurement ESR change : ≤ 200% of initial specified limit Leakage current : ≤ initial specified limit</p>																																															
Vibration Rating	10-55Hz, 10g sinusoidal in three axes, 2 hours per axis.																																															
Maximum Tightening Torque	<table border="1"> <tr> <td>Terminal Code</td> <td>HP</td> <td>HL</td> <td>CD</td> <td>CP</td> <td>CH</td> <td>CA</td> <td>CS</td> </tr> <tr> <td>Thread Size</td> <td>10-32 NF-2B</td> <td>M5x0.8-6H</td> <td></td> <td>1/4-28 NF-2B</td> <td></td> <td>M6x1-6H</td> <td></td> </tr> <tr> <td>3 Threads Engaged</td> <td colspan="3">2.0 N·m (18.0 in·lb)</td> <td colspan="4">4.0 N·m (35.0 in·lb)</td> </tr> <tr> <td>6 Threads Engaged</td> <td colspan="3">2.8 N·m (25.0 in·lb)</td> <td colspan="4">6.2 N·m (55.0 in·lb)</td> </tr> </table>	Terminal Code	HP	HL	CD	CP	CH	CA	CS	Thread Size	10-32 NF-2B	M5x0.8-6H		1/4-28 NF-2B		M6x1-6H		3 Threads Engaged	2.0 N·m (18.0 in·lb)			4.0 N·m (35.0 in·lb)				6 Threads Engaged	2.8 N·m (25.0 in·lb)			6.2 N·m (55.0 in·lb)																		
Terminal Code	HP	HL	CD	CP	CH	CA	CS																																									
Thread Size	10-32 NF-2B	M5x0.8-6H		1/4-28 NF-2B		M6x1-6H																																										
3 Threads Engaged	2.0 N·m (18.0 in·lb)			4.0 N·m (35.0 in·lb)																																												
6 Threads Engaged	2.8 N·m (25.0 in·lb)			6.2 N·m (55.0 in·lb)																																												
Typical Inductance (nH) at 1MHz	<table border="1"> <tr> <td rowspan="2">Case Diameter (mm)</td> <td colspan="7">Terminal Code</td> </tr> <tr> <td>HP</td> <td>HL</td> <td>CD</td> <td>CP</td> <td>CH</td> <td>CA</td> <td>CS</td> </tr> <tr> <td>∅50.8</td> <td>—</td> <td>—</td> <td>NA</td> <td>NA</td> <td>NA</td> <td>NA</td> <td>NA</td> </tr> <tr> <td>∅63.5</td> <td>—</td> <td>—</td> <td>—</td> <td>—</td> <td>—</td> <td>—</td> <td>—</td> </tr> <tr> <td>∅76.2</td> <td>30</td> <td>30</td> <td>25</td> <td>20</td> <td>25</td> <td>20</td> <td>25</td> </tr> <tr> <td>∅89.0</td> <td>30</td> <td>30</td> <td>25</td> <td>20</td> <td>25</td> <td>20</td> <td>25</td> </tr> </table>	Case Diameter (mm)	Terminal Code							HP	HL	CD	CP	CH	CA	CS	∅50.8	—	—	NA	NA	NA	NA	NA	∅63.5	—	—	—	—	—	—	—	∅76.2	30	30	25	20	25	20	25	∅89.0	30	30	25	20	25	20	25
Case Diameter (mm)	Terminal Code																																															
	HP	HL	CD	CP	CH	CA	CS																																									
∅50.8	—	—	NA	NA	NA	NA	NA																																									
∅63.5	—	—	—	—	—	—	—																																									
∅76.2	30	30	25	20	25	20	25																																									
∅89.0	30	30	25	20	25	20	25																																									
Custom Designs	Custom CV values per case size and termination type may be available upon request. Contact appropriate representative with specific requirements.																																															

U37F Series

U37F Useful Life

Useful Life: 6,500 Hours at +85°C

The life expectancy of a capacitor is shown as a function of ambient temperature and ripple current load.

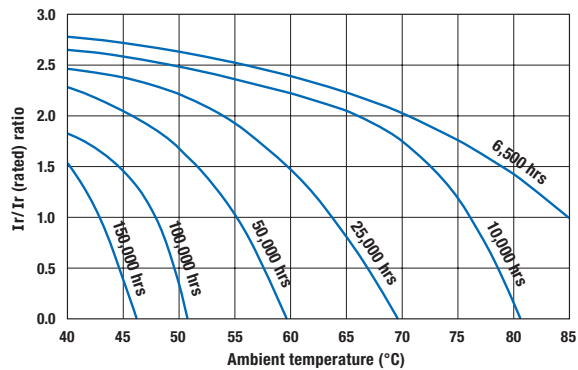
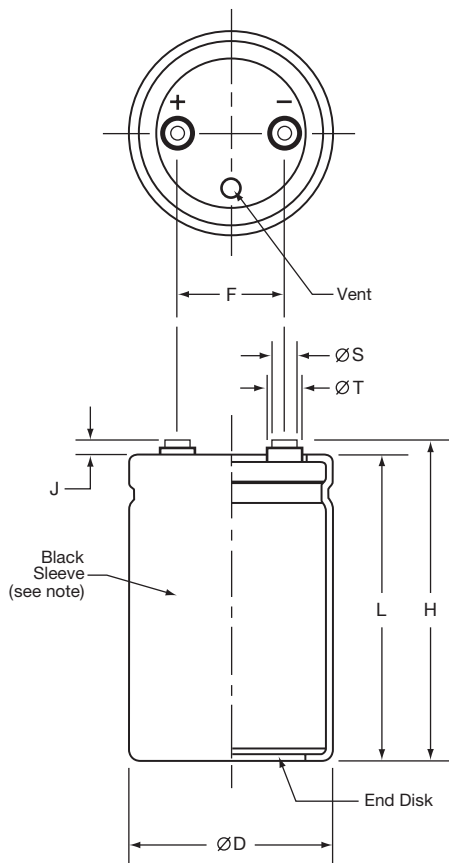

Diagram of Dimensions - Screw Terminals

Large Can/Screw Terminals

Unit: mm (inches)



Case Dimensions and Standard Box Quantities

Case Size Code	ØD +2.0 (0.080)	L ±1.0 (0.040)	F ±0.25 (0.010)	Standard Box Quantity
CB7 CD0	50.8 (2.000)	117 (4.625) 130 (5.125)	22.2 (0.875)	49
D92 DA5 DB7 DD0 DE3	63.5 (2.500)	92 (3.625) 105 (4.125) 117 (4.625) 130 (5.125) 143 (5.625)	28.6 (1.125)	20
E92 EA5 EB7 EE3 EJ1 EM9	76.2 (3.000)	92 (3.625) 105 (4.125) 117 (4.625) 143 (5.625) 181 (7.125) 219 (8.625)	31.8 (1.250)	16 9
F92 FA5 FB7 FE3 FF5 FK0 FM9	89.0 (3.500)	92 (3.625) 105 (4.125) 117 (4.625) 143 (5.625) 155 (6.125) 190 (7.500) 219 (8.625)	31.8 (1.250)	5

Note:

In some cases, the color of the sleeve may change slightly due to the operating conditions, however, the discoloration will not impair capacitor function.

Terminal Specifications

Terminal Code	Available Case Diameter		Thread Size	Minimum Thread Depth	J ±0.5 (0.020)	H ±2.0 (0.080)	ØS ±0.25 (0.010)	ØT ±0.25 (0.010)
	ØD Code	ØD mm (inches)						
HP	C	50.8 (2.000)	10-32 NF-2B	9.5 (0.375)	6.4 (0.250)	L+J	8.0 (0.313)	11.1 (0.438)
HL	C	50.8 (2.000)	M5x0.8-6H	9.5 (0.375)	6.4 (0.250)	L+J	8.0 (0.313)	11.1 (0.438)
CD	D-E	63.5 - 76.2 (2.500 - 3.000)	M5x0.8-6H	8.5 (0.335)	5.0 (0.200)	L+J	13.0 (0.512)	18.8 (0.740)
CP	D-F	63.5 - 89.0 (2.500 - 3.500)	¼-28 NF-2B	8.7 (0.344)	2.4 (0.093)	L+J	17.5 (0.689)	—
CH	D-F	63.5 - 89.0 (2.500 - 3.500)	¼-28 NF-2B	11.9 (0.468)	6.4 (0.250)	L+J	17.5 (0.689)	—
CA	D-F	63.5 - 89.0 (2.500 - 3.500)	M6x1-6H	8.7 (0.344)	2.4 (0.093)	L+J	17.5 (0.689)	—
CS	D-F	63.5 - 89.0 (2.500 - 3.500)	M6x1-6H	11.9 (0.468)	6.4 (0.250)	L+J	17.5 (0.689)	—

Mounting Hardware is optional. Refer to hardware specifications on the following page.

U37F Series

Mounting Hardware - Screw Terminals

Type C: Three-Footed Clamp

Unit: mm (inches)

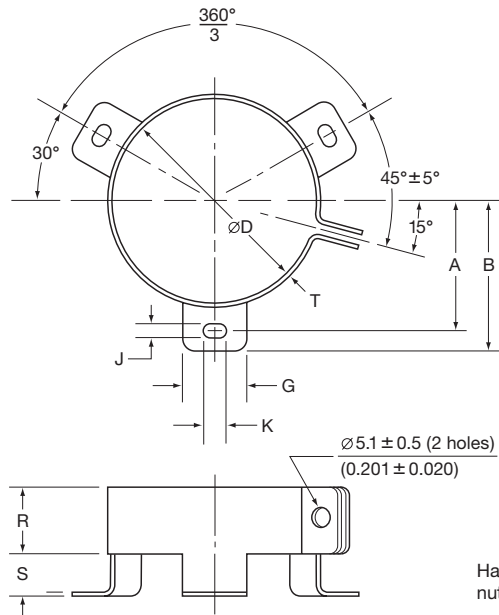

Hardware: Screw, washer and hexagon nut included with each clamp.

Type C: Clamp Dimensions

Mounting Code	Case ØD	A ±1.0 (0.040)	B ±1.0 (0.040)	G ±1.0 (0.040)	J ±0.5 (0.020)	K ±0.5 (0.020)	R ±1.0 (0.040)	S ±1.0 (0.040)	T ±0.5 (0.020)
C	50.8 (2.000)	31.8 (1.250)	36.5 (1.437)	13.3 (0.524)	4.5 (0.177)	7.1 (0.280)	19.1 (0.751)	9.5 (0.374)	0.8 (0.032)
C	63.5 (2.500)	38.1 (1.500)	42.9 (1.689)	13.3 (0.524)	4.5 (0.177)	7.1 (0.280)	19.1 (0.751)	9.5 (0.374)	0.8 (0.032)
C	76.2 (3.000)	44.5 (1.750)	49.2 (1.937)	13.3 (0.524)	4.5 (0.177)	7.1 (0.280)	19.1 (0.751)	9.5 (0.374)	1.0 (0.040)
C	89.0 (3.500)	50.8 (2.000)	56.5 (2.224)	16.0 (0.630)	4.5 (0.177)	8.0 (0.313)	21.0 (0.827)	9.0 (0.354)	1.0 (0.040)

Type S: Stud Mounting

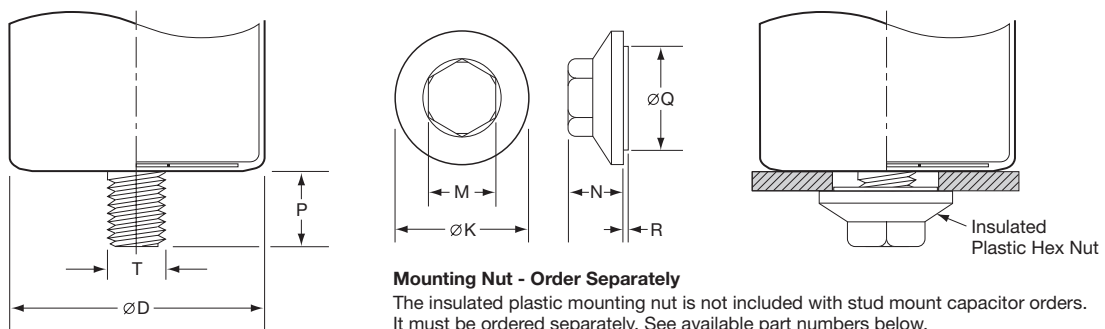

Mounting Nut - Order Separately

The insulated plastic mounting nut is not included with stud mount capacitor orders. It must be ordered separately. See available part numbers below.

Type S: Stud Dimensions

Mounting Code	P ±1.0 (0.040)	T Thread Size
S	16.0 (0.630)	M12

Mounting Nut Dimensions

Part Number	ØK ±2.0 (0.080)	M ±1.0 (0.040)	N ±1.0 (0.040)	ØQ ±1.0 (0.040)	R ±1.0 (0.040)
50-8D	30.0 (1.181)	19.0 (0.748)	18.0 (0.709)	22.0 (0.866)	1.40 (0.055)
50-8E	38.0 (1.496)	19.0 (0.748)	18.0 (0.709)	30.0 (1.181)	1.40 (0.055)

U37F Series

Part Numbering System for U37F Series When ordering, always specify complete 18-field global part number.

18 Fields

1 2 3 4 5 6 7 8 9 10 11 12 13 14 15 16 17 18

E 3 7 F 4 0 1 C P N 1 0 3 M E J 1 U

- 9 Supplement Code.** Field 18.
U = PVC sleeve with end disk.
Other sleeve material available as option upon request.
- 8 Case Size.** Fields 15, 16 and 17.
The single letter diameter code is inserted in field 15.
C = Ø50.8mm (Ø2.000")
D = Ø63.5mm (Ø2.500")
E = Ø76.2mm (Ø3.000")
F = Ø89.0mm (Ø3.500")

The double character length code is inserted in fields 16 and 17.
For lengths ≤99mm, insert the actual length rounded to nearest millimeter. For lengths of 100mm or more, insert the appropriate alpha numeric code as indicated below.
92 = 92mm (3.625")
A5 = 105mm (4.125")
B7 = 117mm (4.625")
D0 = 130mm (5.125")
E3 = 143mm (5.625")
F5 = 155mm (6.125")
J1 = 181mm (7.125")
K0 = 190mm (7.500")
M9 = 219mm (8.625")
- 7 Capacitance Tolerance.** Field 14.
M = ±20%
- 6 Capacitance.** Fields 11, 12 and 13.
Expressed in Microfarads. The first two digits are significant figures inserted in fields 11 and 12, and the third digit inserted in field 13 indicates the number of zeros for capacitance of 10µF or more. R indicates the decimal point for capacitance less than 10µF (e.g. 1R0 = 1.0µF; 100 = 10µF; 101 = 100µF; 102 = 1,000µF; 103 = 10,000µF).
- 5 Mounting Hardware.** Field 10.
N = None.
C = Three-footed clamp.
S = Stud mount. *The mounting nut is not included with stud mount orders. It must be ordered separately.*
- 4 Terminal Type.** Fields 8 and 9.
HP = High post 10-32 NF-2B screw thread.
HL = High post M5x0.8 screw thread.
CD = M5x0.8 screw thread.
CP = Low post 1/4-28 NF-2B screw thread.
CH = High post 1/4-28 NF-2B screw thread.
CA = Low post M6x1 screw thread.
CS = High post M6x1 screw thread.
- 3 DC Rated Voltage.** Fields 5, 6 and 7.
Expressed in Volts. The first two digits are significant figures inserted in fields 5 and 6, and the third digit inserted in field 7 indicates the number of zeros for rated voltage of 10VDC or more. R indicates the decimal point for rated voltage less than 10VDC (e.g. 4R0 = 4.0VDC; 400 = 40VDC; 401 = 400VDC).
- 2 Series Name.** Fields 2, 3 and 4.
Enter the 3-letter/digit series name in fields 2, 3 and 4. If the series name is only 2 letters/digits, place a dash in field 4. For a series name with more than 3 letters/digits, refer to the individual series for the appropriate 3-field series name.
- 1 Capacitor Type.** Field 1.
Aluminum Electrolytic Capacitor (Polar).



U37F Series

Standard Voltage Ratings - Screw Terminals

Rated Voltage (WVDC)	Capacitance (μF)	Global Part Number†	Nominal Case Size* D × L (mm)	Case Size Code	Maximum ESR (mΩ) at +25°C, 120Hz	Rated Ripple Current (A rms) at +85°C		
						120Hz	300Hz	>3kHz
350 Volts 400 Volts Surge	3,300	E37F351HPN332MCB7U	50 × 117	CB7	28	10.8	12.9	15.1
	3,900	E37F351HPN392MCD0U	50 × 130	CD0	23	12.2	14.6	17.0
	3,300	E37F351CPN332MD92U	63.5 × 92	D92	28	11.2	13.4	15.6
	3,900	E37F351CPN392MDA5U	63.5 × 105	DA5	23	12.7	15.2	17.7
	4,700	E37F351CPN472MDB7U	63.5 × 117	DB7	19	14.5	17.4	20.3
	5,600	E37F351CPN562MDD0U	63.5 × 130	DD0	16	16.4	19.7	22.9
	5,600	E37F351CPN562MDE3U	63.5 × 143	DE3	16	17.0	20.4	23.7
	4,700	E37F351CPN472ME92U	76.2 × 92	E92	20	14.5	17.4	20.2
	5,600	E37F351CPN562MEA5U	76.2 × 105	EA5	17	16.5	19.8	23.1
	6,800	E37F351CPN682MEB7U	76.2 × 117	EB7	14	18.9	22.6	26.4
	8,200	E37F351CPN822MEE3U	76.2 × 143	EE3	12	22.2	26.7	31.1
	12,000	E37F351CPN123MEJ1U	76.2 × 181	EJ1	8	29.4	35.2	41.1
	15,000	E37F351CPN153MEM9U	76.2 × 219	EM9	6	35.4	42.5	49.6
	6,800	E37F351CPN682MF92U	89 × 92	F92	14	19.1	22.9	26.7
	8,200	E37F351CPN822MFA5U	89 × 105	FA5	12	21.8	26.2	30.5
	10,000	E37F351CPN103MFB7U	89 × 117	FB7	10	25.0	30.0	35.0
	12,000	E37F351CPN123MFE3U	89 × 143	FE3	8	29.3	35.2	41.1
	15,000	E37F351CPN153MFF5U	89 × 155	FF5	6	33.8	40.5	47.3
18,000	E37F351CPN183MFK0U	89 × 190	FK0	5	40.0	47.9	55.9	
22,000	E37F351CPN223MFM9U	89 × 219	FM9	4	46.7	56.0	65.4	
400 Volts 450 Volts Surge	2,700	E37F401HPN272MCB7U	50 × 117	CB7	30	10.4	12.5	14.6
	3,300	E37F401HPN332MCD0U	50 × 130	CD0	26	11.6	13.9	16.2
	2,700	E37F401CPN272MD92U	63.5 × 92	D92	30	10.7	12.9	15.0
	3,300	E37F401CPN332MDA5U	63.5 × 105	DA5	25	12.3	14.7	17.2
	3,900	E37F401CPN392MDB7U	63.5 × 117	DB7	21	13.8	16.5	19.3
	4,700	E37F401CPN472MDD0U	63.5 × 130	DD0	19	15.3	18.3	21.4
	4,700	E37F401CPN472MDE3U	63.5 × 143	DE3	17	16.8	20.1	23.5
	3,900	E37F401CPN392ME92U	76.2 × 92	E92	21	14.3	17.2	20.0
	5,600	E37F401CPN562MEA5U	76.2 × 105	EA5	17	16.4	19.6	22.9
	5,600	E37F401CPN562MEB7U	76.2 × 117	EB7	15	18.4	22.0	25.7
	8,200	E37F401CPN822MEE3U	76.2 × 143	EE3	12	22.3	26.8	31.3
	10,000	E37F401CPN103MEJ1U	76.2 × 181	EJ1	9	28.2	33.8	39.5
	12,000	E37F401CPN123MEM9U	76.2 × 219	EM9	7	34.0	40.8	47.6
	5,600	E37F401CPN562MF92U	89 × 92	F92	15	18.6	22.3	26.1
	6,800	E37F401CPN682MFA5U	89 × 105	FA5	12	21.2	25.5	29.7
	8,200	E37F401CPN822MFB7U	89 × 117	FB7	11	23.8	28.6	33.4
	10,000	E37F401CPN103MFE3U	89 × 143	FE3	8	28.9	34.7	40.5
	12,000	E37F401CPN123MFF5U	89 × 155	FF5	7	31.4	37.7	44.0
15,000	E37F401CPN153MFK0U	89 × 190	FK0	6	38.3	45.9	53.6	
18,000	E37F401CPN183MFM9U	89 × 219	FM9	5	43.9	52.7	61.5	
420 Volts 470 Volts Surge	2,700	E37F421HPN272MCB7U	50 × 117	CB7	34	9.8	11.7	13.7
	3,300	E37F421HPN332MCD0U	50 × 130	CD0	28	11.2	13.4	15.7
	2,700	E37F421CPN272MD92U	63.5 × 92	D92	34	10.1	12.1	14.1
	3,300	E37F421CPN332MDA5U	63.5 × 105	DA5	28	11.7	14.0	16.3
	3,900	E37F421CPN392MDB7U	63.5 × 117	DB7	23	13.2	15.8	18.5
	3,900	E37F421CPN392MDD0U	63.5 × 130	DD0	23	13.7	16.4	19.1
	4,700	E37F421CPN472MDE3U	63.5 × 143	DE3	19	15.5	18.6	21.8
	3,900	E37F421CPN392ME92U	76.2 × 92	E92	24	13.2	15.8	18.4
	4,700	E37F421CPN472MEA5U	76.2 × 105	EA5	20	15.1	18.1	21.1
	5,600	E37F421CPN562MEB7U	76.2 × 117	EB7	17	17.1	20.5	24.0
	6,800	E37F421CPN682MEE3U	76.2 × 143	EE3	14	20.2	24.3	28.3
	10,000	E37F421CPN103MEJ1U	76.2 × 181	EJ1	10	26.8	32.2	37.5
	12,000	E37F421CPN123MEM9U	76.2 × 219	EM9	8	31.7	38.0	44.4
	5,600	E37F421CPN562MF92U	89 × 92	F92	17	17.3	20.8	24.2
	6,800	E37F421CPN682MFA5U	89 × 105	FA5	14	19.9	23.8	27.8

† For terminal, mounting and construction options, refer to the part numbering system for descriptions and codes.

* Refer to diagram of dimensions for detailed case size specifications.



U37F Series

Standard Voltage Ratings - Screw Terminals

Rated Voltage (WVDC)	Capacitance (µF)	Global Part Number†	Nominal Case Size* D × L (mm)	Case Size Code	Maximum ESR (mΩ) at +25°C, 120Hz	Rated Ripple Current (A rms) at +85°C		
						120Hz	300Hz	>3kHz
420 Volts 470 Volts Surge	8,200	E37F421CPN822MFB7U	89 × 117	FB7	12	22.7	27.2	31.7
	10,000	E37F421CPN103MFE3U	89 × 143	FE3	10	26.8	32.1	37.5
	12,000	E37F421CPN123MFF5U	89 × 155	FF5	8	30.3	36.3	42.4
	15,000	E37F421CPN153MFK0U	89 × 190	FK0	6	36.5	43.8	51.1
	18,000	E37F421CPN183MFM9U	89 × 219	FM9	5	42.2	50.7	59.1
450 Volts 500 Volts Surge	2,700	E37F451HPN272MCB7U	50 × 117	CB7	34	9.8	11.7	13.7
	2,700	E37F451HPN272MCD0U	50 × 130	CD0	34	10.1	12.1	14.2
	2,200	E37F451CPN222MD92U	63.5 × 92	D92	42	9.1	10.9	12.8
	2,700	E37F451CPN272MDA5U	63.5 × 105	DA5	34	10.5	12.7	14.8
	3,300	E37F451CPN332MDB7U	63.5 × 117	DB7	28	12.1	14.6	17.0
	3,900	E37F451CPN392MDD0U	63.5 × 130	DD0	23	13.7	16.4	19.1
	4,700	E37F451CPN472MDE3U	63.5 × 143	DE3	19	15.5	18.6	21.8
	3,900	E37F451CPN392ME92U	76.2 × 92	E92	24	13.2	15.8	18.4
	4,700	E37F451CPN472MEA5U	76.2 × 105	EA5	20	15.1	18.1	21.1
	5,600	E37F451CPN562MEB7U	76.2 × 117	EB7	17	17.1	20.5	24.0
	6,800	E37F451CPN682MEE3U	76.2 × 143	EE3	14	20.2	24.3	28.3
	8,200	E37F451CPN822MEJ1U	76.2 × 181	EJ1	12	24.3	29.1	34.0
	12,000	E37F451CPN123MEM9U	76.2 × 219	EM9	8	31.7	38.0	44.4
	5,600	E37F451CPN562MF92U	89 × 92	F92	17	17.3	20.8	24.2
	6,800	E37F451CPN682MFA5U	89 × 105	FA5	14	19.9	23.8	27.8
	6,800	E37F451CPN682MFB7U	89 × 117	FB7	14	20.6	24.8	28.9
	8,200	E37F451CPN822MFE3U	89 × 143	FE3	12	24.3	29.1	34.0
	12,000	E37F451CPN123MFF5U	89 × 155	FF5	8	30.2	36.3	42.3
15,000	E37F451CPN153MFK0U	89 × 190	FK0	6	36.5	43.8	51.1	
15,000	E37F451CPN153MFM9U	89 × 219	FM9	6	38.6	46.3	54.0	
500 Volts 550 Volts Surge	1,500	E37F501HPN152MCB7U	50 × 117	CB7	63	7.2	8.6	10.1
	1,800	E37F501HPN182MCD0U	50 × 130	CD0	55	8.0	9.6	11.2
	1,800	E37F501CPN182MD92U	63.5 × 92	D92	52	8.2	9.8	11.5
	2,200	E37F501CPN222MDA5U	63.5 × 105	DA5	43	9.4	11.2	13.1
	2,700	E37F501CPN272MDB7U	63.5 × 117	DB7	37	10.5	12.6	14.7
	3,300	E37F501CPN332MDD0U	63.5 × 130	DD0	32	11.7	14.0	16.3
	3,300	E37F501CPN332MDE3U	63.5 × 143	DE3	29	12.8	15.4	17.9
	2,700	E37F501CPN272ME92U	76.2 × 92	E92	36	10.9	13.1	15.3
	3,300	E37F501CPN332MEA5U	76.2 × 105	EA5	30	12.5	15.0	17.5
	3,900	E37F501CPN392MEB7U	76.2 × 117	EB7	25	14.0	16.8	19.6
	5,600	E37F501CPN562MEE3U	76.2 × 143	EE3	20	17.1	20.5	23.9
	6,800	E37F501CPN682MEJ1U	76.2 × 181	EJ1	15	21.5	25.8	30.1
	8,200	E37F501CPN822MEM9U	76.2 × 219	EM9	12	26.0	31.2	36.3
	3,900	E37F501CPN392MF92U	89 × 92	F92	25	14.2	17.1	19.9
	4,700	E37F501CPN472MFA5U	89 × 105	FA5	21	16.2	19.5	22.7
	5,600	E37F501CPN562MFB7U	89 × 117	FB7	18	18.2	21.8	25.5
	6,800	E37F501CPN682MFE3U	89 × 143	FE3	14	22.1	26.5	30.9
	8,200	E37F501CPN822MFF5U	89 × 155	FF5	13	24.0	28.8	33.6
	10,000	E37F501CPN103MFK0U	89 × 190	FK0	10	29.2	35.1	40.9
	12,000	E37F501CPN123MFM9U	89 × 219	FM9	8	33.5	40.2	46.9

†For terminal, mounting and construction options, refer to the part numbering system for descriptions and codes.

*Refer to diagram of dimensions for detailed case size specifications.

U37L Series



- Large Can
- Screw Terminals
- General Purpose U37 Grade
- High Ripple
- 350 to 500VDC Ratings
- RoHS Compliant
- 10,000 Hours Lifetime at +85°C
- Up to 175,000 Hours Useful Life

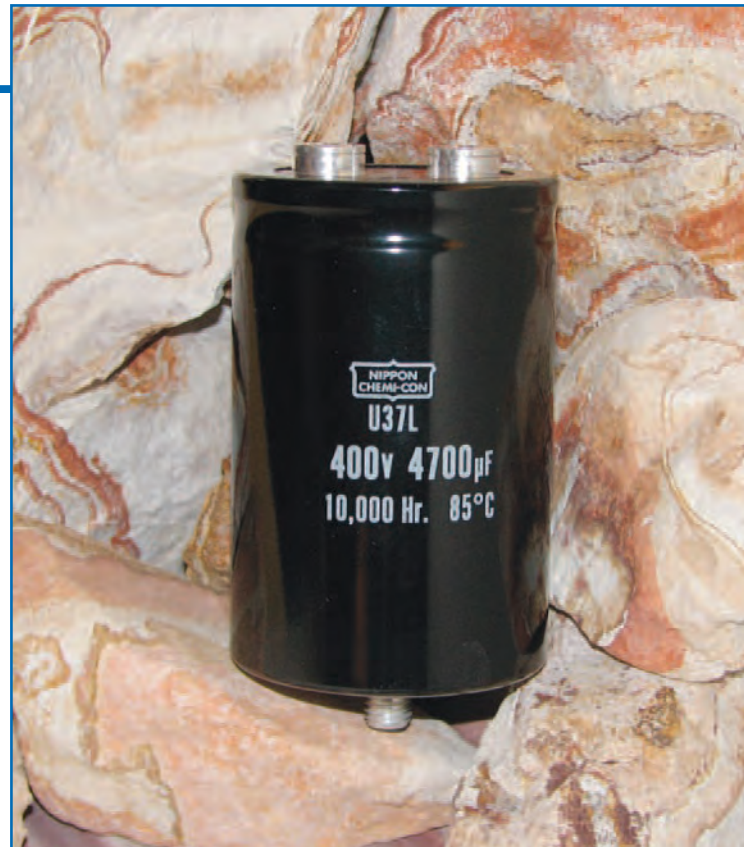

The U37L series is a longer life version of the U37 grade series and is specifically designed to provide the ripple current capability and long life required for high reliability inverter applications. The U37L has an endurance rating of 10,000 hours at +85°C with the rated ripple current applied. The useful life can exceed 175,000 hours at +40°C and 2x the ripple current. These capacitors are available in a variety of high current English or Metric thread terminals. Mounting options include a three-footed clamp or bottom threaded stud. Custom designs are also available.

Summary of Specifications

- Screw terminals: high and low post, English and Metric thread.
- Capacitance range: 1,500 to 18,000µF.
- Voltage range: 350 to 500VDC.
- Category temperature range: -40°C to +85°C.
- Leakage current: 0.02CV(µA) or 5mA, whichever is smaller, after 5 minutes at +25°C.
- Standard capacitance tolerance: ±20%
- Nominal case size (D×L): D = 50mm (2.000") to 89mm (3.500"); L = 92mm (3.625") to 219mm (8.625").
- Rated lifetime: 10,000 hours at +85°C with rated ripple current applied.



U37L Series

U37L Specifications - Screw Terminals

Item	Characteristics																																															
Category Temperature Range	- 40 to +85°C																																															
Rated Voltage Range	350 to 500VDC																																															
Capacitance Range	1,500 to 18,000µF at +25°C, 120Hz																																															
Capacitance Tolerance	±20% (M) at +25°C, 120Hz																																															
Leakage Current	I = 0.02CV (µA) or 5mA, whichever is smaller, after 5 minutes at +25°C. Where I = Max. leakage current (µA), C = Nominal capacitance (µF) and V = Rated voltage (V)																																															
Rated Ripple Current Multipliers	Ambient Temperature (°C) <table border="1"> <tr> <td>+45°C</td> <td>+65°C</td> <td>+85°C</td> </tr> <tr> <td>2.82</td> <td>1.73</td> <td>1.00</td> </tr> </table> Frequency (Hz) <table border="1"> <tr> <td>DC Rated Voltage</td> <td>50Hz</td> <td>120Hz</td> <td>300Hz</td> <td>1kHz</td> <td>3kHz</td> <td>10kHz</td> </tr> <tr> <td>350-500V</td> <td>0.80</td> <td>1.00</td> <td>1.20</td> <td>1.30</td> <td>1.40</td> <td>1.41</td> </tr> </table> To determine maximum ripple current at a specified temperature and frequency, use the appropriate multiplier shown.	+45°C	+65°C	+85°C	2.82	1.73	1.00	DC Rated Voltage	50Hz	120Hz	300Hz	1kHz	3kHz	10kHz	350-500V	0.80	1.00	1.20	1.30	1.40	1.41																											
+45°C	+65°C	+85°C																																														
2.82	1.73	1.00																																														
DC Rated Voltage	50Hz	120Hz	300Hz	1kHz	3kHz	10kHz																																										
350-500V	0.80	1.00	1.20	1.30	1.40	1.41																																										
Endurance (Load Life)	The following specifications shall be satisfied when the capacitors are restored to +25°C after subjecting them to DC voltage for 10,000 hours at +85°C with the rated ripple current applied. The sum of the DC voltage and peak AC voltage must not exceed the full rated voltage of the capacitors. Capacitance change: ≤ 20% from initial measurement ESR change : ≤ 200% of initial specified limit Leakage current : ≤ initial specified limit																																															
Useful Life	With specified standard voltage and ripple current applied, typical life as function of ambient temperature is listed below. <table border="1"> <tr> <td>+85°C</td> <td>13,000 hours max.</td> </tr> <tr> <td>+65°C</td> <td>47,700 hours max.</td> </tr> <tr> <td>+45°C</td> <td>175,000 hours max.</td> </tr> </table> Capacitance change: ≤ 30% from initial measurement ESR change : ≤ 300% of initial specified limit Leakage current : ≤ initial specified limit	+85°C	13,000 hours max.	+65°C	47,700 hours max.	+45°C	175,000 hours max.																																									
+85°C	13,000 hours max.																																															
+65°C	47,700 hours max.																																															
+45°C	175,000 hours max.																																															
Shelf Life	The following specifications shall be satisfied when the capacitors are restored to +25°C after exposing them for 500 hours at +85°C without voltage applied. The rated voltage shall be applied to the capacitors for a minimum of 30 minutes, at least 24 hours and not more than 48 hours before the measurements. Capacitance change: ≤ 20% from initial measurement ESR change : ≤ 200% of initial specified limit Leakage current : ≤ initial specified limit																																															
Vibration Rating	10-55Hz, 10g sinusoidal in three axes, 2 hours per axis.																																															
Maximum Tightening Torque	<table border="1"> <tr> <td>Terminal Code</td> <td>HP</td> <td>HL</td> <td>CD</td> <td>CP</td> <td>CH</td> <td>CA</td> <td>CS</td> </tr> <tr> <td>Thread Size</td> <td>10-32 NF-2B</td> <td>M5x0.8-6H</td> <td></td> <td>1/4-28 NF-2B</td> <td></td> <td>M6x1-6H</td> <td></td> </tr> <tr> <td>3 Threads Engaged</td> <td colspan="3">2.0 N·m (18.0 in·lb)</td> <td colspan="4">4.0 N·m (35.0 in·lb)</td> </tr> <tr> <td>6 Threads Engaged</td> <td colspan="3">2.8 N·m (25.0 in·lb)</td> <td colspan="4">6.2 N·m (55.0 in·lb)</td> </tr> </table>	Terminal Code	HP	HL	CD	CP	CH	CA	CS	Thread Size	10-32 NF-2B	M5x0.8-6H		1/4-28 NF-2B		M6x1-6H		3 Threads Engaged	2.0 N·m (18.0 in·lb)			4.0 N·m (35.0 in·lb)				6 Threads Engaged	2.8 N·m (25.0 in·lb)			6.2 N·m (55.0 in·lb)																		
Terminal Code	HP	HL	CD	CP	CH	CA	CS																																									
Thread Size	10-32 NF-2B	M5x0.8-6H		1/4-28 NF-2B		M6x1-6H																																										
3 Threads Engaged	2.0 N·m (18.0 in·lb)			4.0 N·m (35.0 in·lb)																																												
6 Threads Engaged	2.8 N·m (25.0 in·lb)			6.2 N·m (55.0 in·lb)																																												
Typical Inductance (nH) at 1MHz	<table border="1"> <tr> <td rowspan="2">Case Diameter (mm)</td> <td colspan="7">Terminal Code</td> </tr> <tr> <td>HP</td> <td>HL</td> <td>CD</td> <td>CP</td> <td>CH</td> <td>CA</td> <td>CS</td> </tr> <tr> <td>∅50.8</td> <td>—</td> <td>—</td> <td>NA</td> <td>NA</td> <td>NA</td> <td>NA</td> <td>NA</td> </tr> <tr> <td>∅63.5</td> <td>—</td> <td>—</td> <td>—</td> <td>—</td> <td>—</td> <td>—</td> <td>—</td> </tr> <tr> <td>∅76.2</td> <td>30</td> <td>30</td> <td>25</td> <td>20</td> <td>25</td> <td>20</td> <td>25</td> </tr> <tr> <td>∅89.0</td> <td>30</td> <td>30</td> <td>25</td> <td>20</td> <td>25</td> <td>20</td> <td>25</td> </tr> </table>	Case Diameter (mm)	Terminal Code							HP	HL	CD	CP	CH	CA	CS	∅50.8	—	—	NA	NA	NA	NA	NA	∅63.5	—	—	—	—	—	—	—	∅76.2	30	30	25	20	25	20	25	∅89.0	30	30	25	20	25	20	25
Case Diameter (mm)	Terminal Code																																															
	HP	HL	CD	CP	CH	CA	CS																																									
∅50.8	—	—	NA	NA	NA	NA	NA																																									
∅63.5	—	—	—	—	—	—	—																																									
∅76.2	30	30	25	20	25	20	25																																									
∅89.0	30	30	25	20	25	20	25																																									
Custom Designs	Custom CV values per case size and termination type may be available upon request. Contact appropriate representative with specific requirements.																																															

U37L Series

U37L Useful Life

Useful Life: 13,000 Hours at +85°C
 The life expectancy of a capacitor is shown as a function of ambient temperature and ripple current load.

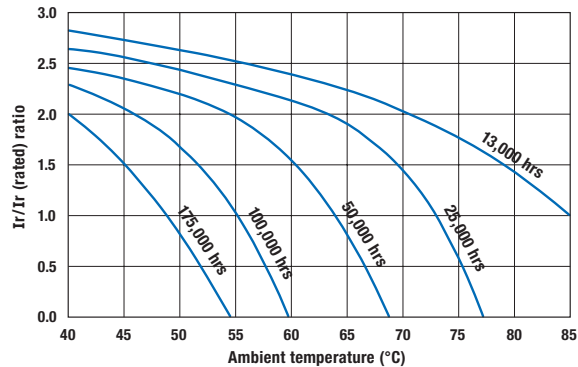
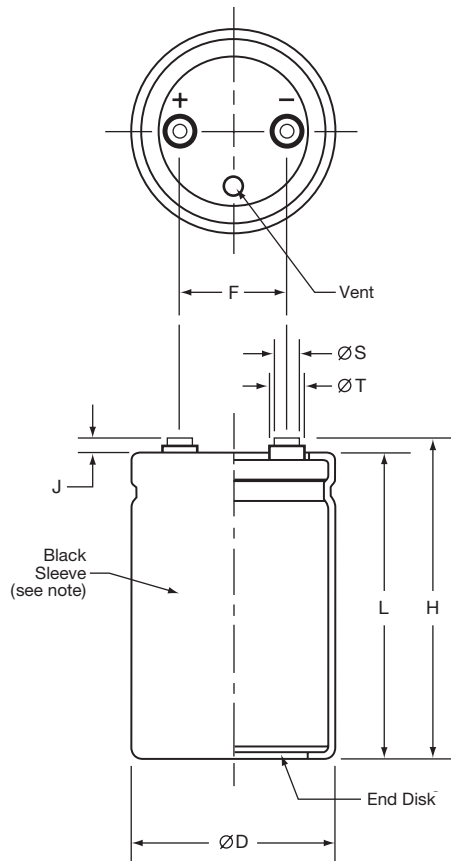

Diagram of Dimensions - Screw Terminals

Large Can/Screw Terminals

Unit: mm (inches)



Case Dimensions and Standard Box Quantities

Case Size Code	ØD +2.0 (0.080)	L ±1.0 (0.040)	F ±0.25 (0.010)	Standard Box Quantity
CB7 CD0	50.8 (2.000)	117 (4.625) 130 (5.125)	22.2 (0.875)	49
D92 DA5 DB7 DD0 DE3	63.5 (2.500)	92 (3.625) 105 (4.125) 117 (4.625) 130 (5.125) 143 (5.625)	28.6 (1.125)	20
E92 EA5 EB7 EE3 EJ1 EM9	76.2 (3.000)	92 (3.625) 105 (4.125) 117 (4.625) 143 (5.625) 181 (7.125) 219 (8.625)	31.8 (1.250)	16 9
F92 FA5 FB7 FE3 FF5 FK0 FM9	89.0 (3.500)	92 (3.625) 105 (4.125) 117 (4.625) 143 (5.625) 155 (6.125) 190 (7.500) 219 (8.625)	31.8 (1.250)	5

Note:
 In some cases, the color of the sleeve may change slightly due to the operating conditions, however, the discoloration will not impair capacitor function.

Terminal Specifications

Terminal Code	Available Case Diameter		Thread Size	Minimum Thread Depth	J ±0.5 (0.020)	H ±2.0 (0.080)	ØS ±0.25 (0.010)	ØT ±0.25 (0.010)
	ØD Code	ØD mm (inches)						
HP	C	50.8 (2.000)	10-32 NF-2B	9.5 (0.375)	6.4 (0.250)	L+J	8.0 (0.313)	11.1 (0.438)
HL	C	50.8 (2.000)	M5x0.8-6H	9.5 (0.375)	6.4 (0.250)	L+J	8.0 (0.313)	11.1 (0.438)
CD	D-E	63.5 - 76.2 (2.500 - 3.000)	M5x0.8-6H	8.5 (0.335)	5.0 (0.200)	L+J	13.0 (0.512)	18.8 (0.740)
CP	D-F	63.5 - 89.0 (2.500 - 3.500)	1/4-28 NF-2B	8.7 (0.344)	2.4 (0.093)	L+J	17.5 (0.689)	—
CH	D-F	63.5 - 89.0 (2.500 - 3.500)	1/4-28 NF-2B	11.9 (0.468)	6.4 (0.250)	L+J	17.5 (0.689)	—
CA	D-F	63.5 - 89.0 (2.500 - 3.500)	M6x1-6H	8.7 (0.344)	2.4 (0.093)	L+J	17.5 (0.689)	—
CS	D-F	63.5 - 89.0 (2.500 - 3.500)	M6x1-6H	11.9 (0.468)	6.4 (0.250)	L+J	17.5 (0.689)	—

Mounting Hardware is optional. Refer to hardware specifications on the following page.



U37L Series

Mounting Hardware - Screw Terminals

Type C: Three-Footed Clamp

Unit: mm (inches)

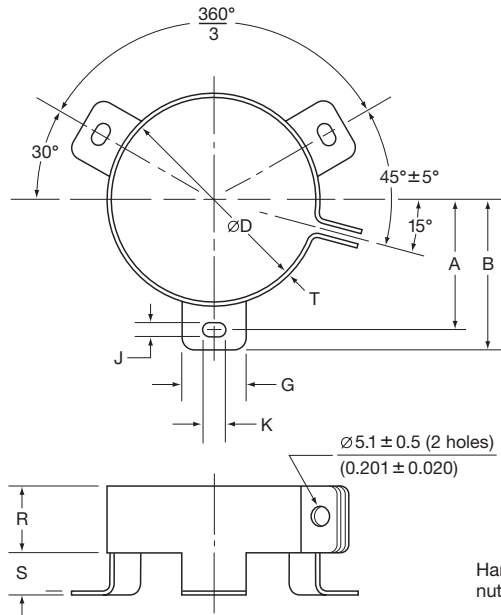

Hardware: Screw, washer and hexagon nut included with each clamp.

Type C: Clamp Dimensions

Mounting Code	Case $\varnothing D$	A ± 1.0 (0.040)	B ± 1.0 (0.040)	G ± 1.0 (0.040)	J ± 0.5 (0.020)	K ± 0.5 (0.020)	R ± 1.0 (0.040)	S ± 1.0 (0.040)	T ± 0.5 (0.020)
C	50.8 (2.000)	31.8 (1.250)	36.5 (1.437)	13.3 (0.524)	4.5 (0.177)	7.1 (0.280)	19.1 (0.751)	9.5 (0.374)	0.8 (0.032)
C	63.5 (2.500)	38.1 (1.500)	42.9 (1.689)	13.3 (0.524)	4.5 (0.177)	7.1 (0.280)	19.1 (0.751)	9.5 (0.374)	0.8 (0.032)
C	76.2 (3.000)	44.5 (1.750)	49.2 (1.937)	13.3 (0.524)	4.5 (0.177)	7.1 (0.280)	19.1 (0.751)	9.5 (0.374)	1.0 (0.040)
C	89.0 (3.500)	50.8 (2.000)	56.5 (2.224)	16.0 (0.630)	4.5 (0.177)	8.0 (0.313)	21.0 (0.827)	9.0 (0.354)	1.0 (0.040)

Type S: Stud Mounting

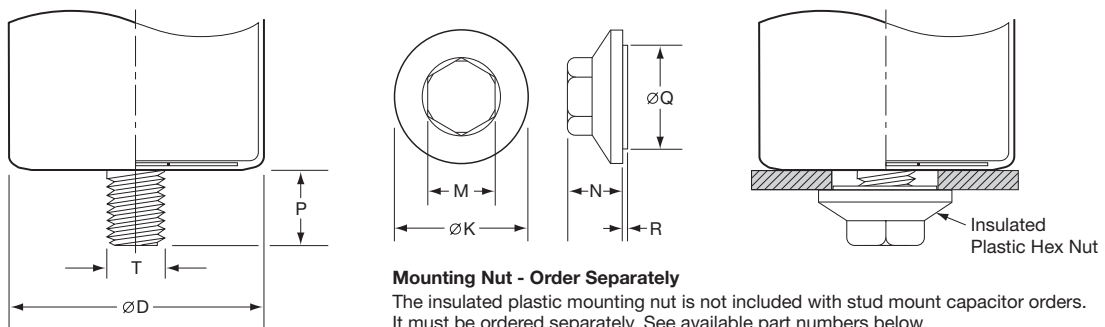

Mounting Nut - Order Separately

The insulated plastic mounting nut is not included with stud mount capacitor orders. It must be ordered separately. See available part numbers below.

Type S: Stud Dimensions

Mounting Code	P ± 1.0 (0.040)	T Thread Size
S	16.0 (0.630)	M12

Mounting Nut Dimensions

Part Number	ØK ± 2.0 (0.080)	M ± 1.0 (0.040)	N ± 1.0 (0.040)	ØQ ± 1.0 (0.040)	R ± 1.0 (0.040)
50-8D	30.0 (1.181)	19.0 (0.748)	18.0 (0.709)	22.0 (0.866)	1.40 (0.055)
50-8E	38.0 (1.496)	19.0 (0.748)	18.0 (0.709)	30.0 (1.181)	1.40 (0.055)



U37L Series

Part Numbering System for U37L Series When ordering, always specify complete 18-field global part number.

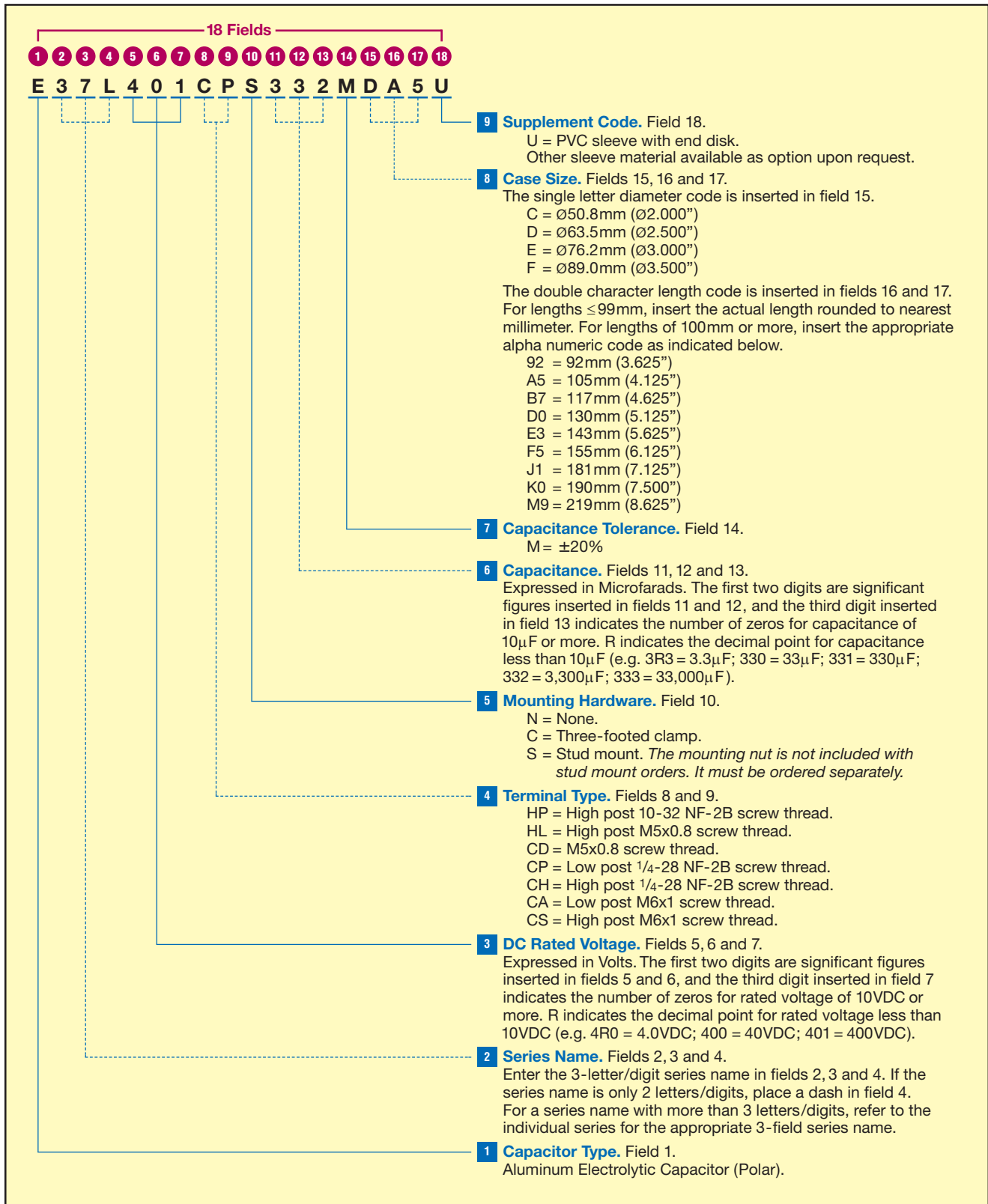



U37L Series

Standard Voltage Ratings - Screw Terminals

Rated Voltage (WVDC)	Capacitance (μF)	Global Part Number†	Nominal Case Size* D × L (mm)	Case Size Code	Maximum ESR (mΩ) at +25°C, 120Hz	Rated Ripple Current (A rms) at +85°C		
						120Hz	300Hz	>3kHz
350 Volts 400 Volts Surge	3,300	E37L351HPN332MCB7U	50 × 117	CB7	29	10.6	12.7	14.8
	3,300	E37L351HPN332MCD0U	50 × 130	CD0	29	11.0	13.1	15.3
	3,300	E37L351CPN332MD92U	63.5 × 92	D92	30	10.7	12.8	15.0
	3,900	E37L351CPN392MDA5U	63.5 × 105	DA5	26	12.2	14.6	17.0
	3,900	E37L351CPN392MDB7U	63.5 × 117	DB7	26	12.6	15.2	17.7
	4,700	E37L351CPN472MDD0U	63.5 × 130	DD0	21	14.4	17.3	20.2
	5,600	E37L351CPN562MDE3U	63.5 × 143	DE3	18	16.3	19.5	22.8
	4,700	E37L351CPN472ME92U	76.2 × 92	E92	22	13.9	16.7	19.5
	5,600	E37L351CPN562MEA5U	76.2 × 105	EA5	18	15.8	19.0	22.1
	6,800	E37L351CPN682MEB7U	76.2 × 117	EB7	15	18.1	21.7	25.4
	8,200	E37L351CPN822MEE3U	76.2 × 143	EE3	13	21.3	25.6	29.9
	12,000	E37L351CPN123MEJ1U	76.2 × 181	EJ1	9	28.2	33.9	39.5
	15,000	E37L351CPN153MEM9U	76.2 × 219	EM9	7	34.0	40.8	47.6
	6,800	E37L351CPN682MF92U	89 × 92	F92	15	18.3	22.0	25.6
	8,200	E37L351CPN822MFA5U	89 × 105	FA5	13	21.0	25.2	29.3
	8,200	E37L351CPN822MFB7U	89 × 117	FB7	13	21.8	26.1	30.5
	12,000	E37L351CPN123MFE3U	89 × 143	FE3	9	28.2	33.8	39.5
	12,000	E37L351CPN123MFF5U	89 × 155	FF5	9	29.0	34.8	40.6
15,000	E37L351CPN153MFK0U	89 × 190	FK0	7	35.0	42.0	49.1	
18,000	E37L351CPN183MFM9U	89 × 219	FM9	6	41.1	49.4	57.6	
400 Volts 450 Volts Surge	2,700	E37L401HPN272MCB7U	50 × 117	CB7	35	9.5	11.5	13.4
	3,300	E37L401HPN332MCD0U	50 × 130	CD0	29	11.0	13.1	15.3
	2,700	E37L401CPN272MD92U	63.5 × 92	D92	37	9.7	11.6	13.6
	3,300	E37L401CPN332MDA5U	63.5 × 105	DA5	30	11.2	13.4	15.7
	3,900	E37L401CPN392MDB7U	63.5 × 117	DB7	26	12.6	15.2	17.7
	3,900	E37L401CPN392MDD0U	63.5 × 130	DD0	26	13.1	15.7	18.4
	4,700	E37L401CPN472MDE3U	63.5 × 143	DE3	21	14.9	17.9	20.9
	3,900	E37L401CPN392ME92U	76.2 × 92	E92	27	12.7	15.2	17.7
	4,700	E37L401CPN472MEA5U	76.2 × 105	EA5	22	14.5	17.4	20.3
	5,600	E37L401CPN562MEB7U	76.2 × 117	EB7	18	16.4	19.7	23.0
	6,800	E37L401CPN682MEE3U	76.2 × 143	EE3	15	19.4	23.3	27.2
	10,000	E37L401CPN103MEJ1U	76.2 × 181	EJ1	10	25.8	30.9	36.1
	12,000	E37L401CPN123MEM9U	76.2 × 219	EM9	9	30.4	36.5	42.6
	5,600	E37L401CPN562MF92U	89 × 92	F92	18	16.6	20.0	23.3
	6,800	E37L401CPN682MFA5U	89 × 105	FA5	15	19.1	22.9	26.7
	8,200	E37L401CPN822MFB7U	89 × 117	FB7	13	21.8	26.1	30.5
	10,000	E37L401CPN103MFE3U	89 × 143	FE3	10	25.7	30.9	36.0
	12,000	E37L401CPN123MFF5U	89 × 155	FF5	9	29.0	34.8	40.6
15,000	E37L401CPN153MFK0U	89 × 190	FK0	7	35.0	42.0	49.1	
18,000	E37L401CPN183MFM9U	89 × 219	FM9	6	40.6	48.7	56.8	
420 Volts 470 Volts Surge	2,700	E37L421HPN272MCB7U	50 × 117	CB7	35	9.5	11.5	13.4
	2,900	E37L421HPN292MCD0U	50 × 130	CD0	33	10.3	12.3	14.4
	2,200	E37L421CPN222MD92U	63.5 × 92	D92	45	8.7	10.5	12.2
	2,700	E37L421CPN272MDA5U	63.5 × 105	DA5	37	10.1	12.1	14.2
	3,300	E37L421CPN332MDB7U	63.5 × 117	DB7	30	11.6	14.0	16.3
	3,900	E37L421CPN392MDD0U	63.5 × 130	DD0	26	13.1	15.7	18.4
	4,700	E37L421CPN472MDE3U	63.5 × 143	DE3	21	14.9	17.9	20.9
	3,900	E37L421CPN392ME92U	76.2 × 92	E92	27	12.7	15.2	17.7
	4,700	E37L421CPN472MEA5U	76.2 × 105	EA5	22	14.5	17.4	20.3
	5,600	E37L421CPN562MEB7U	76.2 × 117	EB7	18	16.4	19.7	23.0
	6,800	E37L421CPN682MEE3U	76.2 × 143	EE3	15	19.4	23.3	27.2
	8,200	E37L421CPN822MEJ1U	76.2 × 181	EJ1	13	23.3	28.0	32.7
	12,000	E37L421CPN123MEM9U	76.2 × 219	EM9	9	30.4	36.5	42.6
	5,600	E37L421CPN562MF92U	89 × 92	F92	18	16.6	20.0	23.3
	6,800	E37L421CPN682MFA5U	89 × 105	FA5	15	19.1	22.9	26.7

† For terminal, mounting and construction options, refer to the part numbering system for descriptions and codes.

* Refer to diagram of dimensions for detailed case size specifications.



U37L Series

Standard Voltage Ratings - Screw Terminals

Rated Voltage (WVDC)	Capacitance (µF)	Global Part Number†	Nominal Case Size* D × L (mm)	Case Size Code	Maximum ESR (mΩ) at +25°C, 120Hz	Rated Ripple Current (A rms) at +85°C		
						120Hz	300Hz	>3kHz
420 Volts 470 Volts Surge	6,800	E37L421CPN682MFB7U	89 × 117	FB7	15	19.8	23.8	27.8
	10,000	E37L421CPN103MFE3U	89 × 143	FE3	10	25.7	30.9	36.0
	10,000	E37L421CPN103MFF5U	89 × 155	FF5	10	26.5	31.8	37.1
	12,000	E37L421CPN123MFK0U	89 × 190	FK0	9	31.3	37.6	43.9
	15,000	E37L421CPN153MFM9U	89 × 219	FM9	7	37.0	44.5	51.9
450 Volts 500 Volts Surge	2,200	E37L451HPN222MCB7U	50 × 117	CB7	43	8.6	10.3	12.1
	2,200	E37L451HPN222MCD0U	50 × 130	CD0	43	8.9	10.7	12.5
	2,200	E37L451CPN222MD92U	63.5 × 92	D92	45	8.7	10.5	12.2
	2,200	E37L451CPN222MDA5U	63.5 × 105	DA5	45	9.1	11.0	12.8
	2,700	E37L451CPN272MDB7U	63.5 × 117	DB7	37	10.5	12.6	14.7
	3,300	E37L451CPN332MDD0U	63.5 × 130	DD0	30	12.1	14.5	16.9
	3,900	E37L451CPN392MDE3U	63.5 × 143	DE3	26	13.6	16.3	19.0
	3,300	E37L451CPN332ME92U	76.2 × 92	E92	31	11.6	14.0	16.3
	3,900	E37L451CPN392MEA5U	76.2 × 105	EA5	27	13.2	15.8	18.5
	4,700	E37L451CPN472MEB7U	76.2 × 117	EB7	22	15.1	18.1	21.1
	5,600	E37L451CPN562MEE3U	76.2 × 143	EE3	18	17.6	21.2	24.7
	6,800	E37L451CPN682MEJ1U	76.2 × 181	EJ1	15	21.2	25.5	29.7
	10,000	E37L451CPN103MEM9U	76.2 × 219	EM9	10	27.8	33.3	38.9
	4,700	E37L451CPN472MF92U	89 × 92	F92	22	15.2	18.3	21.3
	5,600	E37L451CPN562MFA5U	89 × 105	FA5	18	17.3	20.8	24.2
	5,600	E37L451CPN562MFB7U	89 × 117	FB7	18	18.0	21.6	25.2
	8,200	E37L451CPN822MFE3U	89 × 143	FE3	13	23.3	28.0	32.6
	8,200	E37L451CPN822MFF5U	89 × 155	FF5	13	24.0	28.8	33.6
12,000	E37L451CPN123MFK0U	89 × 190	FK0	9	31.3	37.6	43.9	
12,000	E37L451CPN123MFM9U	89 × 219	FM9	9	33.1	39.8	46.4	
500 Volts 550 Volts Surge	1,500	E37L501HPN152MCB7U	50 × 117	CB7	64	7.1	8.5	10.0
	1,500	E37L501HPN152MCD0U	50 × 130	CD0	64	7.4	8.9	10.3
	1,800	E37L501CPN182MD92U	63.5 × 92	D92	55	7.9	9.5	11.1
	2,200	E37L501CPN222MDA5U	63.5 × 105	DA5	45	9.1	11.0	12.8
	2,200	E37L501CPN222MDB7U	63.5 × 117	DB7	45	9.5	11.4	13.3
	2,700	E37L501CPN272MDD0U	63.5 × 130	DD0	37	10.9	13.1	15.3
	2,700	E37L501CPN272MDE3U	63.5 × 143	DE3	37	11.3	13.6	15.8
	2,700	E37L501CPN272ME92U	76.2 × 92	E92	38	10.5	12.6	14.7
	3,300	E37L501CPN332MEA5U	76.2 × 105	EA5	31	12.1	14.6	17.0
	3,300	E37L501CPN332MEB7U	76.2 × 117	EB7	31	12.6	15.2	17.7
	4,700	E37L501CPN472MEE3U	76.2 × 143	EE3	22	16.2	19.4	22.6
	5,600	E37L501CPN562MEJ1U	76.2 × 181	EJ1	18	19.3	23.1	27.0
	8,200	E37L501CPN822MEM9U	76.2 × 219	EM9	13	25.2	30.2	35.2
	3,900	E37L501CPN392MF92U	89 × 92	F92	27	13.9	16.6	19.4
	3,900	E37L501CPN392MFA5U	89 × 105	FA5	27	14.5	17.3	20.2
	4,700	E37L501CPN472MFB7U	89 × 117	FB7	22	16.5	19.8	23.1
	6,800	E37L501CPN682MFE3U	89 × 143	FE3	15	21.2	25.5	29.7
	6,800	E37L501CPN682MFF5U	89 × 155	FF5	15	21.9	26.2	30.6
8,200	E37L501CPN822MFK0U	89 × 190	FK0	12	26.7	32.0	37.4	
10,000	E37L501CPN103MFM9U	89 × 219	FM9	9	33.1	39.8	46.4	

† For terminal, mounting and construction options, refer to the part numbering system for descriptions and codes.

* Refer to diagram of dimensions for detailed case size specifications.

U37X Series



- Large Can
- Screw Terminals
- General Purpose U37 Grade
- High Ripple
- 350 to 500VDC Ratings
- RoHS Compliant
- 15,000 Hours Lifetime at +85°C
- Up to 175,000 Hours Useful Life



The U37X series is the longest life version of the U37 grade series and is specifically designed to provide the ripple current capability and long life required for high reliability inverter applications. The U37X has an endurance rating of 15,000 hours at +85°C with the rated ripple current applied. The useful life can exceed 175,000 hours at +40°C and 2.1x the ripple current. These capacitors are available in a variety of high current English or Metric thread terminals. Mounting options include a three-footed clamp or bottom threaded stud. Custom designs are also available.

Summary of Specifications

- Screw terminals: high and low post, English and Metric thread.
- Capacitance range: 1,200 to 18,000µF.
- Voltage range: 350 to 500VDC.
- Category temperature range: -40°C to +85°C.
- Leakage current: 0.02CV(µA) or 5mA, whichever is smaller, after 5 minutes at +25°C.
- Standard capacitance tolerance: ±20%
- Nominal case size (D×L): D = 50mm (2.000") to 89mm (3.500"); L = 92mm (3.625") to 219mm (8.625").
- Rated lifetime: 15,000 hours at +85°C with rated ripple current applied.



U37X Series

U37X Specifications - Screw Terminals

Item	Characteristics																																															
Category Temperature Range	-40 to +85°C																																															
Rated Voltage Range	350 to 500VDC																																															
Capacitance Range	1,200 to 18,000µF at +25°C, 120Hz																																															
Capacitance Tolerance	±20% (M) at +25°C, 120Hz																																															
Leakage Current	I = 0.02CV (µA) or 5mA, whichever is smaller, after 5 minutes at +25°C. Where I = Max. leakage current (µA), C = Nominal capacitance (µF) and V = Rated voltage (V)																																															
Rated Ripple Current Multipliers	<p>Ambient Temperature (°C)</p> <table border="1"> <tr> <td>+45°C</td> <td>+65°C</td> <td>+85°C</td> </tr> <tr> <td>2.82</td> <td>1.73</td> <td>1.00</td> </tr> </table> <p>Frequency (Hz)</p> <table border="1"> <tr> <td>DC Rated Voltage</td> <td>50Hz</td> <td>120Hz</td> <td>300Hz</td> <td>1kHz</td> <td>3kHz</td> <td>10kHz</td> </tr> <tr> <td>350-500V</td> <td>0.80</td> <td>1.00</td> <td>1.20</td> <td>1.30</td> <td>1.40</td> <td>1.41</td> </tr> </table> <p>To determine maximum ripple current at a specified temperature and frequency, use the appropriate multiplier shown.</p>	+45°C	+65°C	+85°C	2.82	1.73	1.00	DC Rated Voltage	50Hz	120Hz	300Hz	1kHz	3kHz	10kHz	350-500V	0.80	1.00	1.20	1.30	1.40	1.41																											
+45°C	+65°C	+85°C																																														
2.82	1.73	1.00																																														
DC Rated Voltage	50Hz	120Hz	300Hz	1kHz	3kHz	10kHz																																										
350-500V	0.80	1.00	1.20	1.30	1.40	1.41																																										
Endurance (Load Life)	<p>The following specifications shall be satisfied when the capacitors are restored to +25°C after subjecting them to DC voltage for 15,000 hours at +85°C with the rated ripple current applied. The sum of the DC voltage and peak AC voltage must not exceed the full rated voltage of the capacitors.</p> <p>Capacitance change: ≤ 20% from initial measurement ESR change : ≤ 200% of initial specified limit Leakage current : ≤ initial specified limit</p>																																															
Useful Life	<p>With specified standard voltage and ripple current applied, typical life as function of ambient temperature is listed below.</p> <table border="1"> <tr> <td>+85°C</td> <td>20,000 hours max.</td> </tr> <tr> <td>+65°C</td> <td>71,600 hours max.</td> </tr> <tr> <td>+45°C</td> <td>175,000 hours max.</td> </tr> </table> <p>Capacitance change: ≤ 30% from initial measurement ESR change : ≤ 300% of initial specified limit Leakage current : ≤ initial specified limit</p>	+85°C	20,000 hours max.	+65°C	71,600 hours max.	+45°C	175,000 hours max.																																									
+85°C	20,000 hours max.																																															
+65°C	71,600 hours max.																																															
+45°C	175,000 hours max.																																															
Shelf Life	<p>The following specifications shall be satisfied when the capacitors are restored to +25°C after exposing them for 500 hours at +85°C without voltage applied. The rated voltage shall be applied to the capacitors for a minimum of 30 minutes, at least 24 hours and not more than 48 hours before the measurements.</p> <p>Capacitance change: ≤ 20% from initial measurement ESR change : ≤ 200% of initial specified limit Leakage current : ≤ initial specified limit</p>																																															
Vibration Rating	10-55Hz, 10g sinusoidal in three axes, 2 hours per axis.																																															
Maximum Tightening Torque	<table border="1"> <tr> <td>Terminal Code</td> <td>HP</td> <td>HL</td> <td>CD</td> <td>CP</td> <td>CH</td> <td>CA</td> <td>CS</td> </tr> <tr> <td>Thread Size</td> <td>10-32 NF-2B</td> <td>M5x0.8-6H</td> <td></td> <td>1/4-28 NF-2B</td> <td></td> <td>M6x1-6H</td> <td></td> </tr> <tr> <td>3 Threads Engaged</td> <td colspan="3">2.0 N·m (18.0 in·lb)</td> <td colspan="4">4.0 N·m (35.0 in·lb)</td> </tr> <tr> <td>6 Threads Engaged</td> <td colspan="3">2.8 N·m (25.0 in·lb)</td> <td colspan="4">6.2 N·m (55.0 in·lb)</td> </tr> </table>	Terminal Code	HP	HL	CD	CP	CH	CA	CS	Thread Size	10-32 NF-2B	M5x0.8-6H		1/4-28 NF-2B		M6x1-6H		3 Threads Engaged	2.0 N·m (18.0 in·lb)			4.0 N·m (35.0 in·lb)				6 Threads Engaged	2.8 N·m (25.0 in·lb)			6.2 N·m (55.0 in·lb)																		
Terminal Code	HP	HL	CD	CP	CH	CA	CS																																									
Thread Size	10-32 NF-2B	M5x0.8-6H		1/4-28 NF-2B		M6x1-6H																																										
3 Threads Engaged	2.0 N·m (18.0 in·lb)			4.0 N·m (35.0 in·lb)																																												
6 Threads Engaged	2.8 N·m (25.0 in·lb)			6.2 N·m (55.0 in·lb)																																												
Typical Inductance (nH) at 1MHz	<table border="1"> <tr> <td rowspan="2">Case Diameter (mm)</td> <td colspan="7">Terminal Code</td> </tr> <tr> <td>HP</td> <td>HL</td> <td>CD</td> <td>CP</td> <td>CH</td> <td>CA</td> <td>CS</td> </tr> <tr> <td>∅50.8</td> <td>—</td> <td>—</td> <td>NA</td> <td>NA</td> <td>NA</td> <td>NA</td> <td>NA</td> </tr> <tr> <td>∅63.5</td> <td>—</td> <td>—</td> <td>—</td> <td>—</td> <td>—</td> <td>—</td> <td>—</td> </tr> <tr> <td>∅76.2</td> <td>30</td> <td>30</td> <td>25</td> <td>20</td> <td>25</td> <td>20</td> <td>25</td> </tr> <tr> <td>∅89.0</td> <td>30</td> <td>30</td> <td>25</td> <td>20</td> <td>25</td> <td>20</td> <td>25</td> </tr> </table>	Case Diameter (mm)	Terminal Code							HP	HL	CD	CP	CH	CA	CS	∅50.8	—	—	NA	NA	NA	NA	NA	∅63.5	—	—	—	—	—	—	—	∅76.2	30	30	25	20	25	20	25	∅89.0	30	30	25	20	25	20	25
Case Diameter (mm)	Terminal Code																																															
	HP	HL	CD	CP	CH	CA	CS																																									
∅50.8	—	—	NA	NA	NA	NA	NA																																									
∅63.5	—	—	—	—	—	—	—																																									
∅76.2	30	30	25	20	25	20	25																																									
∅89.0	30	30	25	20	25	20	25																																									
Custom Designs	Custom CV values per case size and termination type may be available upon request. Contact appropriate representative with specific requirements.																																															

U37X Series

U37X Useful Life

Useful Life: 20,000 Hours at +85°C

The life expectancy of a capacitor is shown as a function of ambient temperature and ripple current load.

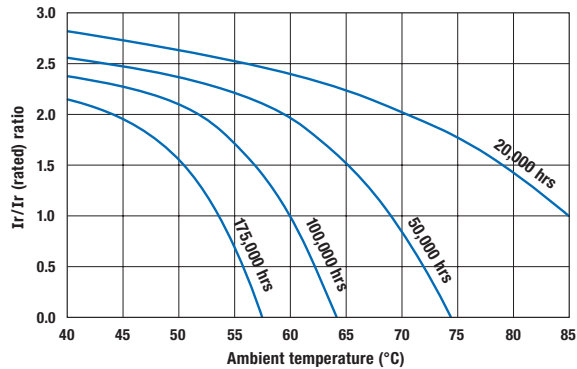
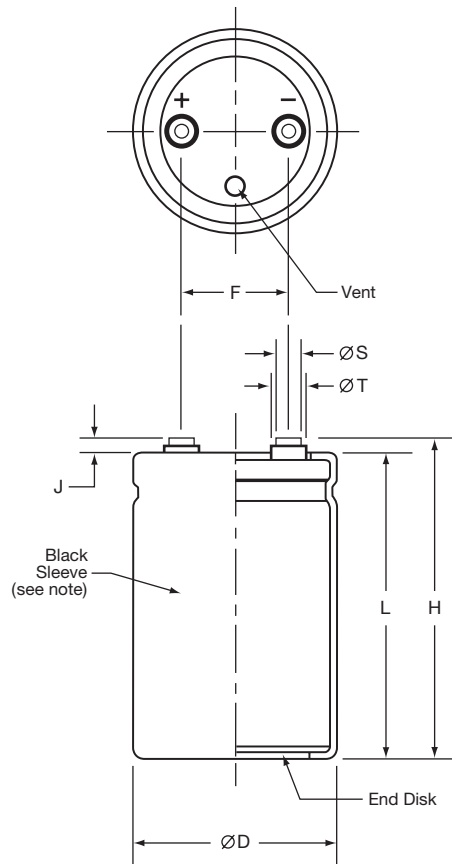

Diagram of Dimensions - Screw Terminals

Large Can/Screw Terminals

Unit: mm (inches)



Case Dimensions and Standard Box Quantities

Case Size Code	ØD +2.0 (0.080)	L ±1.0 (0.040)	F ±0.25 (0.010)	Standard Box Quantity
CB7 CD0	50.8 (2.000)	117 (4.625) 130 (5.125)	22.2 (0.875)	49
D92 DA5 DB7 DD0 DE3	63.5 (2.500)	92 (3.625) 105 (4.125) 117 (4.625) 130 (5.125) 143 (5.625)	28.6 (1.125)	20
E92 EA5 EB7 EE3 EJ1 EM9	76.2 (3.000)	92 (3.625) 105 (4.125) 117 (4.625) 143 (5.625) 181 (7.125) 219 (8.625)	31.8 (1.250)	16 9
F92 FA5 FB7 FE3 FF5 FK0 FM9	89.0 (3.500)	92 (3.625) 105 (4.125) 117 (4.625) 143 (5.625) 155 (6.125) 190 (7.500) 219 (8.625)	31.8 (1.250)	5

Note:
In some cases, the color of the sleeve may change slightly due to the operating conditions, however, the discoloration will not impair capacitor function.

Terminal Specifications

Terminal Code	Available Case Diameter		Thread Size	Minimum Thread Depth	J ± 0.5 (0.020)	H ± 2.0 (0.080)	ØS ± 0.25 (0.010)	ØT ± 0.25 (0.010)
	ØD Code	ØD mm (inches)						
HP	C	50.8 (2.000)	10-32 NF-2B	9.5 (0.375)	6.4 (0.250)	L+J	8.0 (0.313)	11.1 (0.438)
HL	C	50.8 (2.000)	M5x0.8-6H	9.5 (0.375)	6.4 (0.250)	L+J	8.0 (0.313)	11.1 (0.438)
CD	D-E	63.5 - 76.2 (2.500 - 3.000)	M5x0.8-6H	8.5 (0.335)	5.0 (0.200)	L+J	13.0 (0.512)	18.8 (0.740)
CP	D-F	63.5 - 89.0 (2.500 - 3.500)	1/4-28 NF-2B	8.7 (0.344)	2.4 (0.093)	L+J	17.5 (0.689)	—
CH	D-F	63.5 - 89.0 (2.500 - 3.500)	1/4-28 NF-2B	11.9 (0.468)	6.4 (0.250)	L+J	17.5 (0.689)	—
CA	D-F	63.5 - 89.0 (2.500 - 3.500)	M6x1-6H	8.7 (0.344)	2.4 (0.093)	L+J	17.5 (0.689)	—
CS	D-F	63.5 - 89.0 (2.500 - 3.500)	M6x1-6H	11.9 (0.468)	6.4 (0.250)	L+J	17.5 (0.689)	—

Mounting Hardware is optional. Refer to hardware specifications on the following page.

U37X Series

Mounting Hardware - Screw Terminals

Type C: Three-Footed Clamp

Unit: mm (inches)

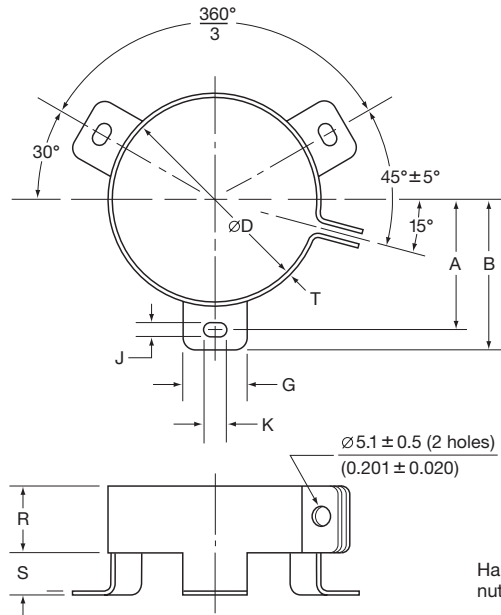

Hardware: Screw, washer and hexagon nut included with each clamp.

Type C: Clamp Dimensions

Mounting Code	Case ØD	A ±1.0 (0.040)	B ±1.0 (0.040)	G ±1.0 (0.040)	J ±0.5 (0.020)	K ±0.5 (0.020)	R ±1.0 (0.040)	S ±1.0 (0.040)	T ±0.5 (0.020)
C	50.8 (2.000)	31.8 (1.250)	36.5 (1.437)	13.3 (0.524)	4.5 (0.177)	7.1 (0.280)	19.1 (0.751)	9.5 (0.374)	0.8 (0.032)
C	63.5 (2.500)	38.1 (1.500)	42.9 (1.689)	13.3 (0.524)	4.5 (0.177)	7.1 (0.280)	19.1 (0.751)	9.5 (0.374)	0.8 (0.032)
C	76.2 (3.000)	44.5 (1.750)	49.2 (1.937)	13.3 (0.524)	4.5 (0.177)	7.1 (0.280)	19.1 (0.751)	9.5 (0.374)	1.0 (0.040)
C	89.0 (3.500)	50.8 (2.000)	56.5 (2.224)	16.0 (0.630)	4.5 (0.177)	8.0 (0.313)	21.0 (0.827)	9.0 (0.354)	1.0 (0.040)

Type S: Stud Mounting

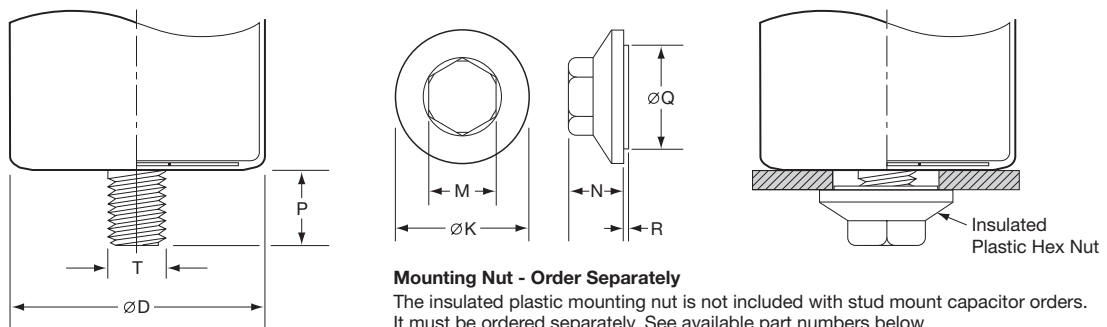

Mounting Nut - Order Separately

The insulated plastic mounting nut is not included with stud mount capacitor orders. It must be ordered separately. See available part numbers below.

Type S: Stud Dimensions

Mounting Code	P ±1.0 (0.040)	T Thread Size
S	16.0 (0.630)	M12

Mounting Nut Dimensions

Part Number	ØK ±2.0 (0.080)	M ±1.0 (0.040)	N ±1.0 (0.040)	ØQ ±1.0 (0.040)	R ±1.0 (0.040)
50-8D	30.0 (1.181)	19.0 (0.748)	18.0 (0.709)	22.0 (0.866)	1.40 (0.055)
50-8E	38.0 (1.496)	19.0 (0.748)	18.0 (0.709)	30.0 (1.181)	1.40 (0.055)



U37X Series

Part Numbering System for U37X Series When ordering, always specify complete 18-field global part number.

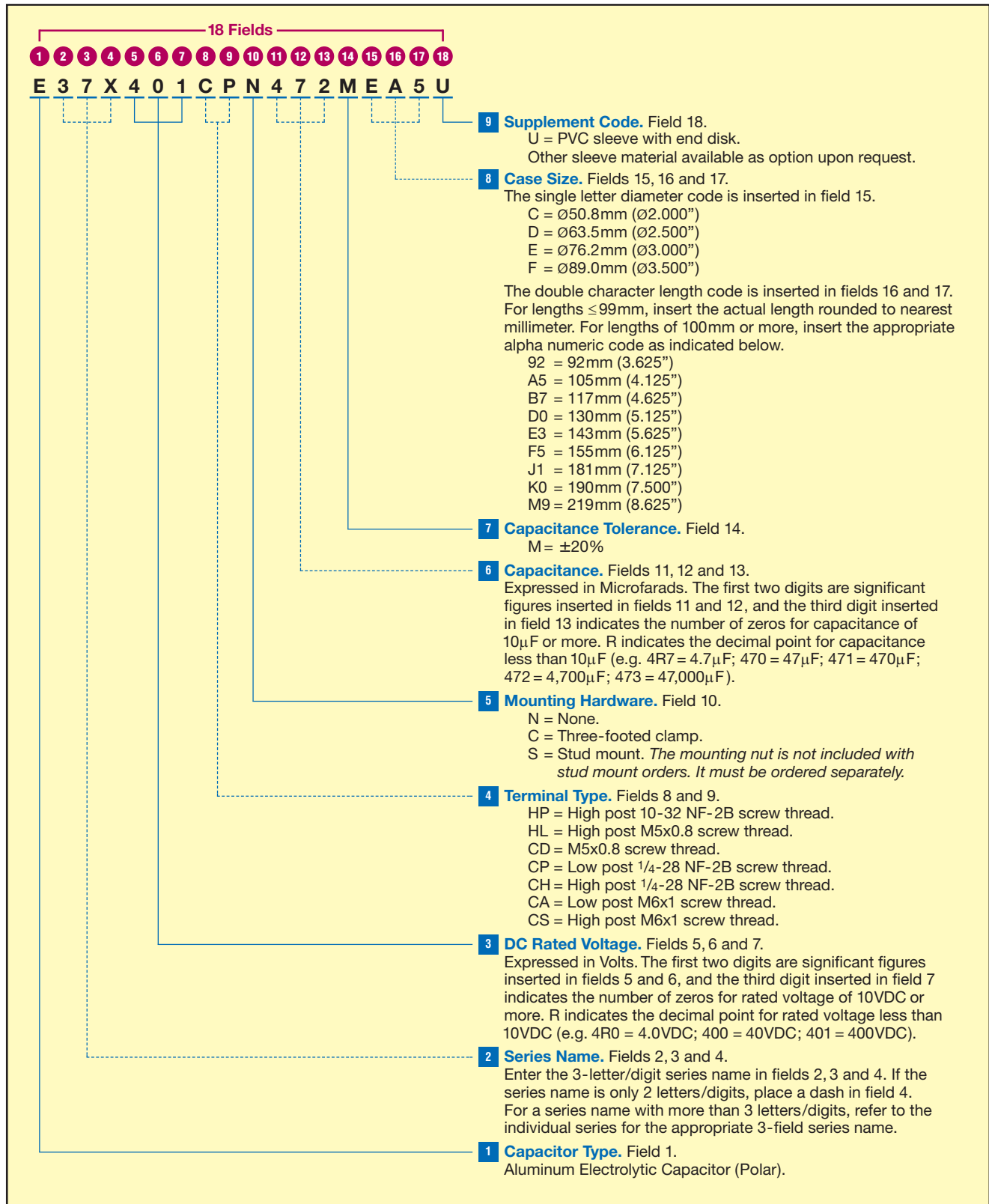



U37X Series

Standard Voltage Ratings - Screw Terminals

Rated Voltage (WVDC)	Capacitance (µF)	Global Part Number†	Nominal Case Size* D × L (mm)	Case Size Code	Maximum ESR (mΩ) at +25°C, 120Hz	Rated Ripple Current (A rms) at +85°C		
						120Hz	300Hz	>3kHz
350 Volts 400 Volts Surge	2,700	E37X351HPN272MCB7U	50 × 117	CB7	35	9.6	11.5	13.4
	3,300	E37X351HPN332MCD0U	50 × 130	CD0	31	10.6	12.8	14.9
	2,700	E37X351CPN272MD92U	63.5 × 92	D92	37	9.7	11.6	13.5
	3,300	E37X351CPN332MDA5U	63.5 × 105	DA5	31	11.1	13.3	15.5
	3,900	E37X351CPN392MDB7U	63.5 × 117	DB7	26	12.4	14.9	17.4
	4,700	E37X351CPN472MDD0U	63.5 × 130	DD0	23	13.8	16.5	19.3
	4,700	E37X351CPN472MDE3U	63.5 × 143	DE3	21	15.1	18.1	21.2
	3,900	E37X351CPN392ME92U	76.2 × 92	E92	26	12.7	15.2	17.8
	4,700	E37X351CPN472MEA5U	76.2 × 105	EA5	22	14.5	17.4	20.3
	5,600	E37X351CPN562MEB7U	76.2 × 117	EB7	19	16.3	19.5	22.8
	8,200	E37X351CPN822MEE3U	76.2 × 143	EE3	15	19.8	23.7	27.7
	10,000	E37X351CPN103MEJ1U	76.2 × 181	EJ1	11	25.0	30.0	35.0
	12,000	E37X351CPN123MEM9U	76.2 × 219	EM9	9	30.1	36.1	42.2
	5,600	E37X351CPN562MF92U	89 × 92	F92	19	16.2	19.4	22.7
	6,800	E37X351CPN682MFA5U	89 × 105	FA5	16	18.5	22.2	25.9
	8,200	E37X351CPN822MFB7U	89 × 117	FB7	14	20.7	24.9	29.0
	12,000	E37X351CPN123MFE3U	89 × 143	FE3	11	25.2	30.2	35.2
	12,000	E37X351CPN123MFF5U	89 × 155	FF5	10	27.3	32.8	38.2
15,000	E37X351CPN153MFK0U	89 × 190	FK0	8	33.3	40.0	46.6	
18,000	E37X351CPN183MFM9U	89 × 219	FM9	6	38.2	45.8	53.5	
400 Volts 450 Volts Surge	2,700	E37X401HPN272MCB7U	50 × 117	CB7	41	8.9	10.7	12.5
	2,700	E37X401HPN272MCD0U	50 × 130	CD0	35	9.9	11.9	13.9
	2,700	E37X401CPN272MD92U	63.5 × 92	D92	43	9.0	10.8	12.6
	2,700	E37X401CPN272MDA5U	63.5 × 105	DA5	36	10.3	12.3	14.4
	3,300	E37X401CPN332MDB7U	63.5 × 117	DB7	31	11.6	13.9	16.2
	3,900	E37X401CPN392MDD0U	63.5 × 130	DD0	27	12.8	15.4	18.0
	3,900	E37X401CPN392MDE3U	63.5 × 143	DE3	24	14.1	16.9	19.7
	3,900	E37X401CPN392ME92U	76.2 × 92	E92	30	11.8	14.2	16.5
	4,700	E37X401CPN472MEA5U	76.2 × 105	EA5	25	13.5	16.2	18.9
	5,600	E37X401CPN562MEB7U	76.2 × 117	EB7	22	15.2	18.2	21.2
	6,800	E37X401CPN682MEE3U	76.2 × 143	EE3	17	18.4	22.1	25.8
	8,200	E37X401CPN822MEJ1U	76.2 × 181	EJ1	13	23.3	27.9	32.6
	12,000	E37X401CPN123MEM9U	76.2 × 219	EM9	10	28.0	33.6	39.3
	5,600	E37X401CPN562MF92U	89 × 92	F92	22	15.1	18.1	21.1
	6,800	E37X401CPN682MFA5U	89 × 105	FA5	19	17.2	20.6	24.1
	6,800	E37X401CPN682MFB7U	89 × 117	FB7	16	19.3	23.2	27.0
	10,000	E37X401CPN103MFE3U	89 × 143	FE3	12	23.4	28.1	32.8
	10,000	E37X401CPN103MFF5U	89 × 155	FF5	11	25.4	30.5	35.6
12,000	E37X401CPN123MFK0U	89 × 190	FK0	9	31.0	37.2	43.4	
15,000	E37X401CPN153MFM9U	89 × 219	FM9	7	35.6	42.7	49.8	
420 Volts 470 Volts Surge	2,200	E37X421HPN222MCB7U	50 × 117	CB7	44	8.5	10.2	11.9
	2,700	E37X421HPN272MCD0U	50 × 130	CD0	39	9.4	11.3	13.2
	2,200	E37X421CPN222MD92U	63.5 × 92	D92	47	8.6	10.3	12.0
	2,700	E37X421CPN272MDA5U	63.5 × 105	DA5	39	9.8	11.8	13.8
	3,300	E37X421CPN332MDB7U	63.5 × 117	DB7	33	11.0	13.3	15.5
	3,900	E37X421CPN392MDD0U	63.5 × 130	DD0	29	12.2	14.7	17.1
	3,900	E37X421CPN392MDE3U	63.5 × 143	DE3	26	13.4	16.1	18.8
	3,300	E37X421CPN332ME92U	76.2 × 92	E92	33	11.3	13.5	15.8
	3,900	E37X421CPN392MEA5U	76.2 × 105	EA5	28	12.9	15.5	18.0
	4,700	E37X421CPN472MEB7U	76.2 × 117	EB7	24	14.5	17.4	20.3
	5,600	E37X421CPN562MEE3U	76.2 × 143	EE3	19	17.6	21.1	24.6
	8,200	E37X421CPN822MEJ1U	76.2 × 181	EJ1	14	22.2	26.6	31.1
	10,000	E37X421CPN103MEM9U	76.2 × 219	EM9	11	26.8	32.1	37.5
	4,700	E37X421CPN472MF92U	89 × 92	F92	25	14.4	17.3	20.2
	5,600	E37X421CPN562MFA5U	89 × 105	FA5	21	16.4	19.7	23.0

† For terminal, mounting and construction options, refer to the part numbering system for descriptions and codes.

* Refer to diagram of dimensions for detailed case size specifications.



U37X Series

Standard Voltage Ratings - Screw Terminals

Rated Voltage (WVDC)	Capacitance (µF)	Global Part Number†	Nominal Case Size* D × L (mm)	Case Size Code	Maximum ESR (mΩ) at +25°C, 120Hz	Rated Ripple Current (A rms) at +85°C		
						120Hz	300Hz	>3kHz
420 Volts 470 Volts Surge	6,800	E37X421CPN682MFB7U	89 × 117	FB7	18	18.4	22.1	25.8
	8,200	E37X421CPN822MFE3U	89 × 143	FE3	14	22.4	26.8	31.3
	10,000	E37X421CPN103MFF5U	89 × 155	FF5	12	24.3	29.1	34.0
	12,000	E37X421CPN123MFK0U	89 × 190	FK0	10	29.6	35.5	41.4
	15,000	E37X421CPN153MFM9U	89 × 219	FM9	8	34.0	40.7	47.5
450 Volts 500 Volts Surge	1,800	E37X451HPN182MCB7U	50 × 117	CB7	51	8.0	9.6	11.2
	2,200	E37X451HPN222MCD0U	50 × 130	CD0	44	8.9	10.6	12.4
	2,200	E37X451CPN222MD92U	63.5 × 92	D92	53	8.1	9.7	11.3
	2,200	E37X451CPN222MDA5U	63.5 × 105	DA5	44	9.2	11.1	12.9
	2,700	E37X451CPN272MDB7U	63.5 × 117	DB7	38	10.4	12.4	14.5
	3,300	E37X451CPN332MDD0U	63.5 × 130	DD0	33	11.5	13.8	16.1
	3,900	E37X451CPN392MDE3U	63.5 × 143	DE3	30	12.6	15.1	17.6
	3,300	E37X451CPN332ME92U	76.2 × 92	E92	38	10.6	12.7	14.8
	3,900	E37X451CPN392MEA5U	76.2 × 105	EA5	32	12.1	14.5	16.9
	3,900	E37X451CPN392MEB7U	76.2 × 117	EB7	27	13.6	16.3	19.0
	5,600	E37X451CPN562MEE3U	76.2 × 143	EE3	21	16.5	19.8	23.1
	6,800	E37X451CPN682MEJ1U	76.2 × 181	EJ1	16	20.8	25.0	29.2
	8,200	E37X451CPN822MEM9U	76.2 × 219	EM9	13	25.1	30.1	35.2
	3,900	E37X451CPN392MF92U	89 × 92	F92	28	13.5	16.2	18.9
	4,700	E37X451CPN472MFA5U	89 × 105	FA5	23	15.4	18.5	21.6
	5,600	E37X451CPN562MFB7U	89 × 117	FB7	20	17.3	20.7	24.2
	8,200	E37X451CPN822MFE3U	89 × 143	FE3	16	21.0	25.2	29.4
	8,200	E37X451CPN822MFF5U	89 × 155	FF5	14	22.8	27.3	31.9
10,000	E37X451CPN103MFK0U	89 × 190	FK0	11	27.8	33.3	38.9	
12,000	E37X451CPN123MFM9U	89 × 219	FM9	9	32.2	38.6	45.0	
500 Volts 550 Volts Surge	1,200	E37X501HPN122MCB7U	50 × 117	CB7	78	6.4	7.7	9.0
	1,500	E37X501HPN152MCD0U	50 × 130	CD0	68	7.2	8.6	10.0
	1,500	E37X501CPN152MD92U	63.5 × 92	D92	67	7.2	8.6	10.1
	1,800	E37X501CPN182MDA5U	63.5 × 105	DA5	56	8.2	9.9	11.5
	2,200	E37X501CPN222MDB7U	63.5 × 117	DB7	48	9.3	11.1	13.0
	2,700	E37X501CPN272MDD0U	63.5 × 130	DD0	42	10.3	12.3	14.4
	2,700	E37X501CPN272MDE3U	63.5 × 143	DE3	37	11.3	13.5	15.8
	2,200	E37X501CPN222ME92U	76.2 × 92	E92	48	9.5	11.3	13.2
	2,700	E37X501CPN272MEA5U	76.2 × 105	EA5	40	10.8	13.0	15.1
	3,300	E37X501CPN332MEB7U	76.2 × 117	EB7	34	12.1	14.6	17.0
	3,900	E37X501CPN392MEE3U	76.2 × 143	EE3	26	14.8	17.7	20.7
	5,600	E37X501CPN562MEJ1U	76.2 × 181	EJ1	20	18.6	22.3	26.1
	6,800	E37X501CPN682MEM9U	76.2 × 219	EM9	16	22.5	26.9	31.4
	3,300	E37X501CPN332MF92U	89 × 92	F92	35	12.1	14.5	16.9
	3,900	E37X501CPN392MFA5U	89 × 105	FA5	29	13.8	16.5	19.3
	4,700	E37X501CPN472MFB7U	89 × 117	FB7	25	15.5	18.5	21.6
	5,600	E37X501CPN562MFE3U	89 × 143	FE3	19	18.8	22.5	26.3
	6,800	E37X501CPN682MFF5U	89 × 155	FF5	18	20.4	24.4	28.5
	8,200	E37X501CPN822MFK0U	89 × 190	FK0	14	24.8	29.8	34.8
	10,000	E37X501CPN103MFM9U	89 × 219	FM9	12	28.5	34.2	39.9

† For terminal, mounting and construction options, refer to the part numbering system for descriptions and codes.

* Refer to diagram of dimensions for detailed case size specifications.



UTOR Series



- Large Can Toroidal Design
- Lowest Thermal Resistance
- Optimum Cooling Capability
- New Lower Profile Sizes
- New Heat-Sink Mounting Kit
- RoHS Compliant

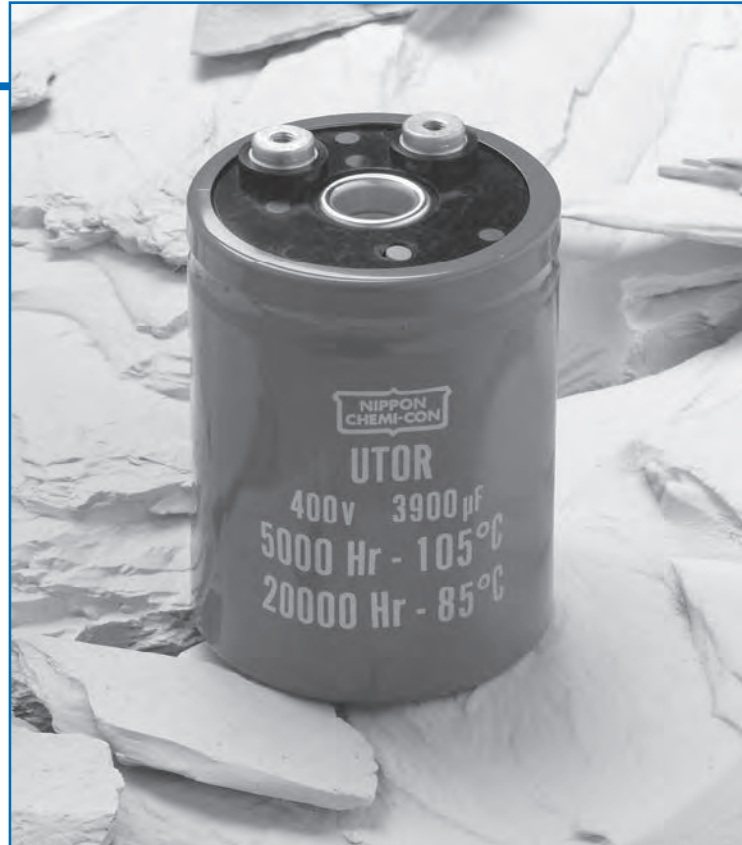

The UTOR series now offers higher capacitance and ripple current per case size. The upgrade allows the inverter designer to significantly reduce the size, weight, and cost of the capacitor bank. Toroidal geometry is ideal for cooling by either forced air or by heat-sink with the use of a new mounting kit option. The heat-sink kit option provides optimum thermal transfer while maintaining electrical isolation. These capacitors have an endurance rating of 5,000 hours at 105°C or 20,000 hours at 85°C with the rated ripple current applied. The UTOR series represents the optimum cost per amp of ripple current for a screw terminal mounted electrolytic capacitor.

Summary of Specifications

- Screw terminals, high ripple Metric thread.
- Capacitance range: 680 to 10,000µF.
- Voltage range: 350 to 500VDC.
- Operating temperature range: -40°C to +105°C.
- Leakage current: 0.02CV(µA) or 5mA, whichever is smaller, after 5 minutes at +25°C.
- Standard capacitance tolerance: ±20%
- Nominal case size (D×L): D = 76mm (3.000"); L = 54mm (2.125") to 168mm (6.625").
- Rated lifetime: 5,000 hours at +105°C with rated ripple current applied.



UTOR Series

UTOR Specifications - Screw Terminals

Item	Characteristics																											
Category Temperature Range	- 40 to +105°C																											
Rated Voltage Range	350 to 500VDC																											
Capacitance Range	680 to 10,000µF at +25°C, 120Hz																											
Capacitance Tolerance	±20% (M) at +25°C, 120Hz																											
Leakage Current	I = 0.02CV (µA) or 5mA, whichever is smaller, after 5 minutes at +25°C. Where I = Max. leakage current (µA), C = Nominal capacitance (µF) and V = Rated voltage (V)																											
Rated Ripple Current Multipliers	<p>Ambient Temperature (°C)</p> <table border="1"> <tr> <td>+45°C</td> <td>+65°C</td> <td>+85°C</td> <td>+105°C</td> </tr> <tr> <td>2.45</td> <td>2.12</td> <td>1.73</td> <td>1.00</td> </tr> </table> <p>Cooling</p> <table border="1"> <thead> <tr> <th rowspan="2">Mounting Type</th> <th colspan="3">Air Velocity</th> </tr> <tr> <th>Static</th> <th>1.0m/s</th> <th>2.0m/s</th> </tr> </thead> <tbody> <tr> <td>Clamp Mount</td> <td>1.00</td> <td>1.20</td> <td>1.30</td> </tr> <tr> <td>Heat-Sink (air cooled)</td> <td>1.20</td> <td>1.45</td> <td>1.55</td> </tr> <tr> <td>Heat-Sink (fluid cooled)</td> <td>1.35</td> <td>1.65</td> <td>1.75</td> </tr> </tbody> </table>	+45°C	+65°C	+85°C	+105°C	2.45	2.12	1.73	1.00	Mounting Type	Air Velocity			Static	1.0m/s	2.0m/s	Clamp Mount	1.00	1.20	1.30	Heat-Sink (air cooled)	1.20	1.45	1.55	Heat-Sink (fluid cooled)	1.35	1.65	1.75
+45°C	+65°C	+85°C	+105°C																									
2.45	2.12	1.73	1.00																									
Mounting Type	Air Velocity																											
	Static	1.0m/s	2.0m/s																									
Clamp Mount	1.00	1.20	1.30																									
Heat-Sink (air cooled)	1.20	1.45	1.55																									
Heat-Sink (fluid cooled)	1.35	1.65	1.75																									
Endurance (Load Life)	<p>The following specifications shall be satisfied when the capacitors are restored to +25°C after subjecting them to DC voltage for 5,000 hours at +105°C with the rated ripple current applied. The sum of the DC voltage and peak AC voltage must not exceed the full rated voltage of the capacitors.</p> <p>Capacitance change: ≤ ±20% of initial measured value ESR change : ≤ 200% of initial specified value Leakage current : ≤ initial specified value</p>																											
Shelf Test	<p>The following specifications shall be satisfied when the capacitors are restored to +25°C after exposing them for 1,000 hours at +105°C without voltage applied. The rated voltage shall be applied to the capacitors for a minimum of 30 minutes, at least 24 hours and not more than 48 hours before the measurements.</p> <p>Capacitance change: ≤ ±20% of initial measured value ESR change : ≤ 200% of initial specified value Leakage current : ≤ initial specified value</p>																											
Vibration Rating	10-55Hz, 10g sinusoidal in three axis, 2 hours per axis.																											
Maximum Tightening Torque	<table border="1"> <thead> <tr> <th rowspan="2">Terminal Code</th> <th rowspan="2">Thread Size</th> <th colspan="2">3 Threads Engaged</th> <th colspan="2">6 Threads Engaged</th> </tr> <tr> <th>in-lb</th> <th>N·m</th> <th>in-lb</th> <th>N·m</th> </tr> </thead> <tbody> <tr> <td>CT</td> <td>M5x0.8</td> <td>18.0</td> <td>2.0</td> <td>28.5</td> <td>3.2</td> </tr> </tbody> </table>	Terminal Code	Thread Size	3 Threads Engaged		6 Threads Engaged		in-lb	N·m	in-lb	N·m	CT	M5x0.8	18.0	2.0	28.5	3.2											
Terminal Code	Thread Size			3 Threads Engaged		6 Threads Engaged																						
		in-lb	N·m	in-lb	N·m																							
CT	M5x0.8	18.0	2.0	28.5	3.2																							
Typical Inductance	25nH at 1MHz																											
Custom Designs	Custom CV values per case size may be available upon request. Contact appropriate representative with specific requirements.																											

UTOR Series

Diagram of Dimensions - Screw Terminals

Toroidal Large Can/Screw Terminals

Unit: mm and inches

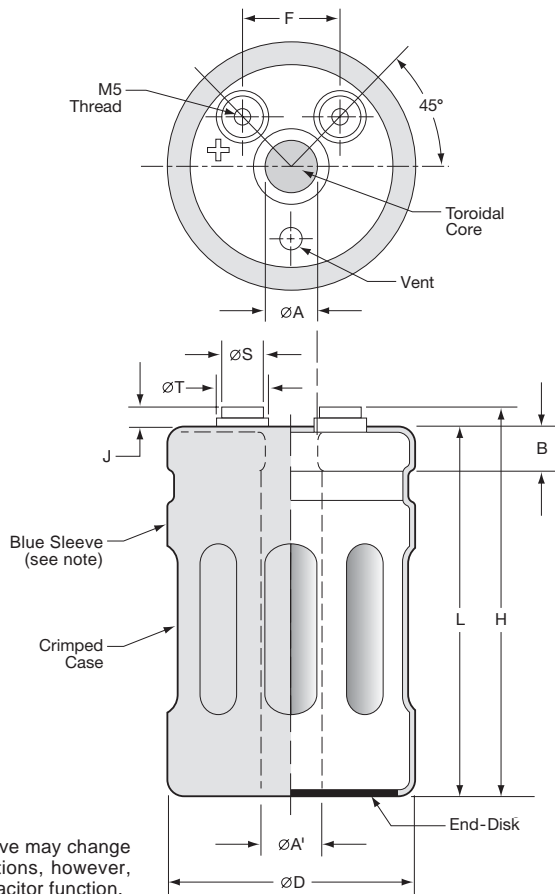

Note:
In some cases, the color of the sleeve may change slightly due to the operating conditions, however, the discoloration will not impair capacitor function.

Terminal Specifications in Millimeters

Terminal Code	Thread Size	Minimum Thread Depth	J ± 0.50	øS ± 0.25	øT ± 0.25
CT	M5x0.8	10.5	7.0	13.0	18.5

Terminal Specifications in Inches

Terminal Code	Thread Size	Minimum Thread Depth	J ± 0.020	øS ± 0.010	øT ± 0.010
CT	M5x0.8	0.413	0.276	0.512	0.728

Case Dimensions in Millimeters

øA ± 0.20	øA' ± 0.30	B ± 0.5	F ± 0.25
16.3	18.9	9.5	31.8

Case Dimensions in Inches

øA ± 0.008	øA' ± 0.012	B ± 0.020	F ± 0.010
0.642	0.744	0.374	1.250

Case Size Code	øD +2.0	L +2.0	H ± 1.0
E54	76	54	61
E67	76	67	74
E79	76	79	86
E92	76	92	99
EA5	76	105	112
EB7	76	117	124
ED0	76	130	137
EE3	76	143	150
EF5	76	155	162
EG8	76	168	175

Case Size Code	øD +0.080	L +0.080	H ± 0.040
E54	3.000	2.125	2.402
E67	3.000	2.625	2.913
E79	3.000	3.125	3.386
E92	3.000	3.625	3.898
EA5	3.000	4.125	4.409
EB7	3.000	4.625	4.882
ED0	3.000	5.125	5.394
EE3	3.000	5.625	5.906
EF5	3.000	6.125	6.378
EG8	3.000	6.625	6.890



UTOR^{Series}

Mounting Hardware - Screw Terminals

Type C: Three-Footed Clamp

Unit: mm (inches)

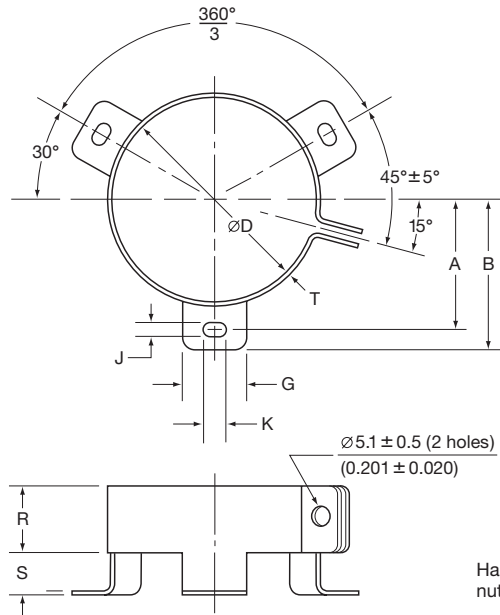

Hardware: Screw, washer and hexagon nut included with each clamp.

Type C: Clamp Specifications

Mounting Code	Case $\varnothing D$	A ± 1.0 (0.040)	B ± 1.0 (0.040)	G ± 1.0 (0.040)	J ± 0.5 (0.020)	K ± 0.5 (0.020)	R ± 1.0 (0.040)	S ± 1.0 (0.040)	T ± 0.5 (0.020)
C	76.2 (3.000)	44.5 (1.750)	49.2 (1.937)	13.3 (0.524)	4.5 (0.177)	7.1 (0.280)	19.1 (0.751)	9.5 (0.374)	1.0 (0.040)

UTOR Series

Mounting Hardware - Screw Terminals

Type H: Heat Sink Mounting Kit

Unit: mm (inches)

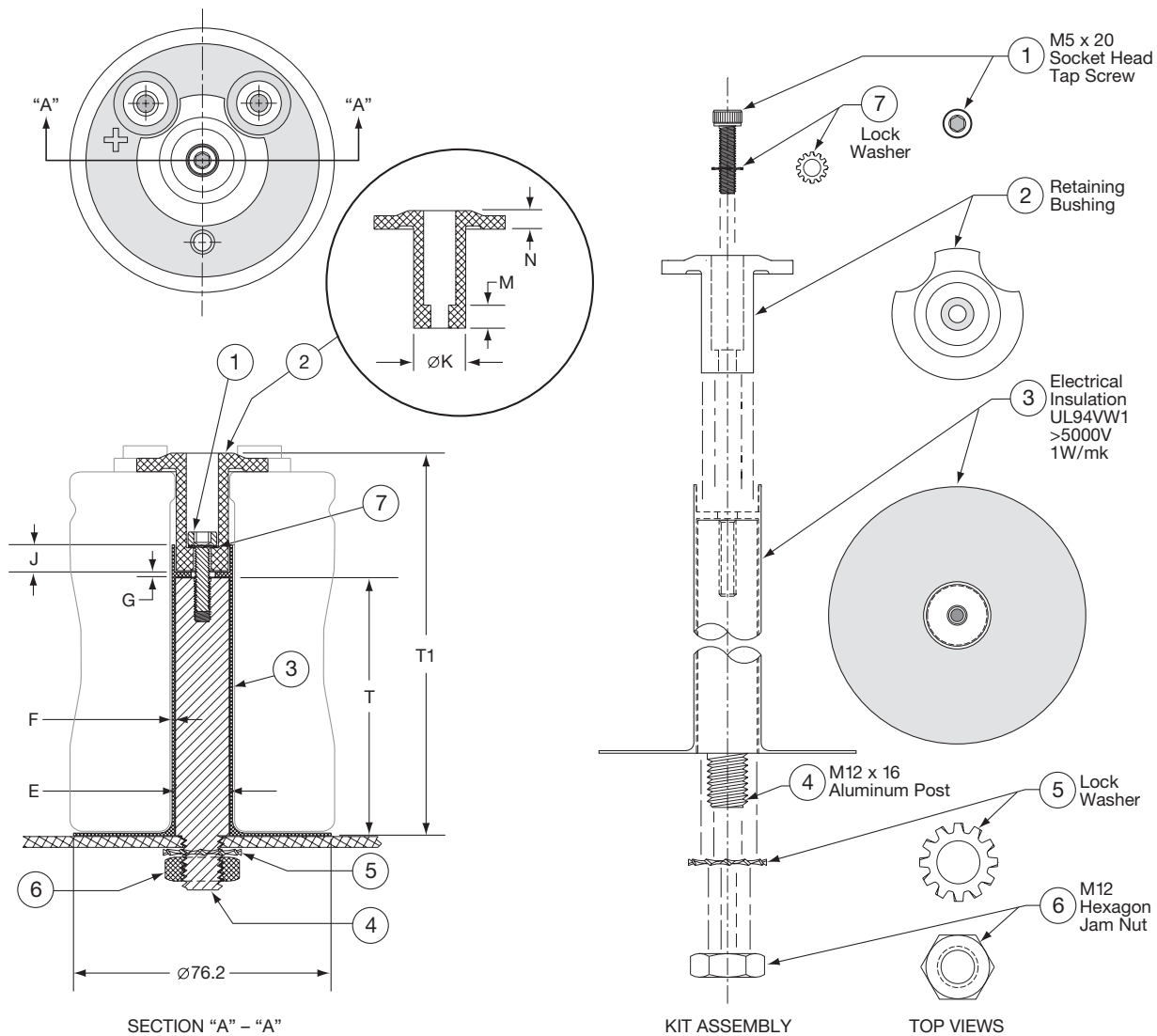

Type H: Heat Sink Mounting Kit Dimensions

Mounting Code	Case Size Code	T ± 0.2 (0.008)	T1 ± 0.5 (0.020)
H	E54	35 (1.378)	58 (2.280)
H	E67	35 (1.378)	71 (2.780)
H	E79	60 (2.362)	83 (3.280)
H	E92	60 (2.362)	96 (3.780)
H	EA5	60 (2.362)	109 (4.280)
H	EB7	60 (2.362)	121 (4.780)
H	ED0	111 (4.370)	134 (5.280)
H	EE3	111 (4.370)	147 (5.780)
H	EF5	111 (4.370)	160 (6.280)
H	EG8	111 (4.370)	172 (6.780)

Dimension	Millimeters	Inches
E	18.6 Max.	0.732 Max.
F	0.56 ± 0.05	0.022 ± 0.002
G	2.00 ± 0.13	0.080 ± 0.005
J	8.00 ± 0.13	0.315 ± 0.005
øK	15.24 ± 0.20	0.600 ± 0.008
M	6.76 ± 0.13	0.266 ± 0.005
N	5.49 ± 0.13	0.216 ± 0.005

UTOR Series

Part Numbering System for UTOR Series When ordering, always specify complete 18-field global part number.

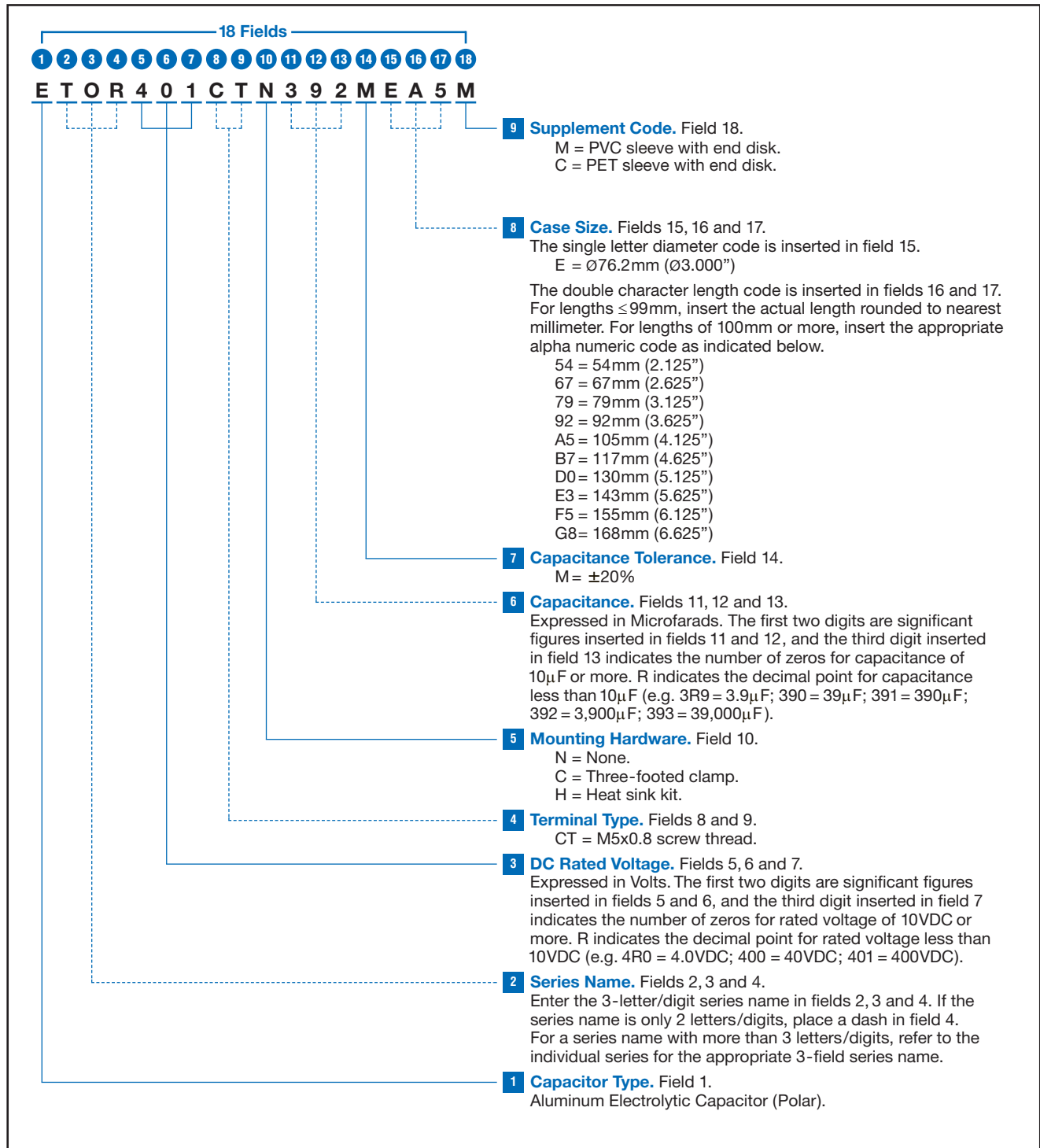



UTOR Series

Standard Voltage Ratings - Screw Terminals

Rated Voltage (WVDC)	Capacitance (µF)	Global Part Number†	Nominal Case Size* D x L (mm)	Case Size Code	Maximum ESR (mΩ) at +25°C, 120Hz	Rated Ripple Current (A rms) at +105°C		
						120Hz	300Hz	>3kHz
350 Volts 400 Volts Surge	1,800	ETOR351CTN182ME54M	76 x 54	E54	44	11.8	14.1	16.5
	2,700	ETOR351CTN272ME67M	76 x 67	E67	30	15.4	18.5	21.6
	3,300	ETOR351CTN332ME79M	76 x 79	E79	24	17.1	20.5	23.9
	4,700	ETOR351CTN472ME92M	76 x 92	E92	17	21.6	26.0	30.3
	5,600	ETOR351CTN562MEA5M	76 x 105	EA5	14	24.9	29.9	34.9
	6,800	ETOR351CTN682MED0M	76 x 130	ED0	12	30.2	36.2	42.2
	8,200	ETOR351CTN822MEE3M	76 x 143	EE3	10	34.5	41.4	48.3
	10,000	ETOR351CTN103MEG8M	76 x 168	EG8	8	41.0	49.2	57.4
400 Volts 450 Volts Surge	1,500	ETOR401CTN152ME54M	76 x 54	E54	53	10.7	12.9	15.0
	2,200	ETOR401CTN222ME67M	76 x 67	E67	36	13.9	16.7	19.5
	2,700	ETOR401CTN272ME79M	76 x 79	E79	30	15.4	18.5	21.6
	3,300	ETOR401CTN332ME92M	76 x 92	E92	24	18.1	21.8	25.4
	3,900	ETOR401CTN392MEA5M	76 x 105	EA5	21	20.8	25.0	29.1
	4,700	ETOR401CTN472MEB7M	76 x 117	EB7	17	24.0	28.8	33.6
	5,600	ETOR401CTN562MED0M	76 x 130	ED0	14	27.4	32.9	38.3
	6,800	ETOR401CTN682MEE3M	76 x 143	EE3	12	31.4	37.7	44.0
	8,200	ETOR401CTN822MEG8M	76 x 168	EG8	10	37.1	44.5	52.0
420 Volts 470 Volts Surge	1,200	ETOR421CTN122ME54M	76 x 54	E54	89	9.3	11.1	13.0
	1,800	ETOR421CTN182ME67M	76 x 67	E67	59	12.2	14.6	17.1
	2,200	ETOR421CTN222ME79M	76 x 79	E79	40	14.9	17.9	20.9
	3,300	ETOR421CTN332ME92M	76 x 92	E92	32	17.5	21.0	24.5
	3,900	ETOR421CTN392MEA5M	76 x 105	EA5	27	20.1	24.1	28.2
	4,700	ETOR421CTN472MED0M	76 x 130	ED0	23	24.2	29.1	33.9
	5,600	ETOR421CTN562MEE3M	76 x 143	EE3	19	27.6	33.1	38.6
	6,800	ETOR421CTN682MEG8M	76 x 168	EG8	16	32.7	39.2	45.7
450 Volts 500 Volts Surge	1,000	ETOR451CTN102ME54M	76 x 54	E54	89	9.3	11.1	13.0
	1,500	ETOR451CTN152ME67M	76 x 67	E67	59	12.2	14.6	17.1
	2,200	ETOR451CTN222ME79M	76 x 79	E79	48	13.5	16.2	18.9
	2,700	ETOR451CTN272ME92M	76 x 92	E92	40	15.9	19.0	22.2
	3,300	ETOR451CTN332MEA5M	76 x 105	EA5	32	18.5	22.2	25.9
	3,900	ETOR451CTN392MEB7M	76 x 117	EB7	27	21.1	25.3	29.6
	4,700	ETOR451CTN472MED0M	76 x 130	ED0	23	24.2	29.1	33.9
	5,600	ETOR451CTN562MEF5M	76 x 155	EF5	19	28.6	34.3	40.1
500 Volts 550 Volts Surge	680	ETOR501CTN681ME54M	76 x 54	E54	206	6.5	7.8	9.1
	1,000	ETOR501CTN102ME67M	76 x 67	E67	140	8.4	10.1	11.8
	1,500	ETOR501CTN152ME79M	76 x 79	E79	93	10.3	12.4	14.4
	1,800	ETOR501CTN182ME92M	76 x 92	E92	78	12.0	14.4	16.8
	2,200	ETOR501CTN222MEA5M	76 x 105	EA5	64	14.0	16.8	19.6
	2,700	ETOR501CTN272MEB7M	76 x 117	EB7	52	16.3	19.5	22.8
	3,300	ETOR501CTN332MEE3M	76 x 143	EE3	42	19.6	23.5	27.4
	3,900	ETOR501CTN392MEG8M	76 x 168	EG8	36	22.1	26.5	31.0

†For mounting and construction options, refer to the part numbering system for descriptions and codes.

*Refer to diagram of dimensions for detailed case size specifications.

Alchip™-MAR Series

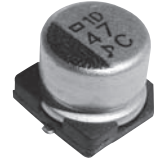

- Suitable for small and low profile product such as the car audio and electronics
- Non solvent resistant type
- RoHS2 Compliant

◆ SPECIFICATIONS

Items	Characteristics							
Category	-40 to +85°C							
Temperature Range	-40 to +85°C							
Rated Voltage Range	6.3 to 50V _{dc}							
Capacitance Tolerance	±20% (M) (at 20°C, 120Hz)							
Leakage Current	I=0.01CV or 3μA, whichever is greater. Where, I : Max. leakage current (μA), C : Nominal capacitance (μF), V : Rated voltage (V) (at 20°C after 2 minutes)							
Dissipation Factor (tan δ)	Rated voltage (V _{dc})	6.3V	10V	16V	25V	35V	50V	
	tan δ (Max.)	D55 to F55	0.30	0.24	0.20	0.16	0.14	0.12
		H63 to JA0	0.40	0.30	0.26	0.16	0.14	0.12
Low Temperature Characteristics (Max. Impedance Ratio)	Rated voltage (V _{dc})	6.3V	10V	16V	25V	35V	50V	
	Z(-25°C)/Z(+20°C)	4	3	2	2	2	2	
	Z(-40°C)/Z(+20°C)	12	8	6	4	3	3	
Endurance	The following specifications shall be satisfied when the capacitors are restored to 20°C after the rated voltage is applied for 2,000 hours at 85°C.							
	Capacitance change	≤ ±20% of the initial value						
	D.F. (tan δ)	≤ 200% of the initial specified value						
	Leakage current	≤ The initial specified value						
Shelf Life	The following specifications shall be satisfied when the capacitors are restored to 20°C after exposing them for 500 hours at 85°C without voltage applied. Before the measurement, the capacitor shall be preconditioned by applying voltage according to Item 4.1 of JIS C 5101-4.							
	Capacitance change	≤ ±20% of the initial value						
	D.F. (tan δ)	≤ 200% of the initial specified value						
	Leakage current	≤ The initial specified value						

◆ DIMENSIONS [mm]

● Terminal Code : A

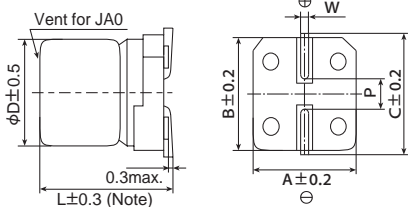

Note : L±0.5 for H63 to JA0

Size code	D	L	A	B	C	W	P
D55	4	5.2	4.3	4.3	5.1	0.5 to 0.8	1.0
E55	5	5.2	5.3	5.3	5.9	0.5 to 0.8	1.4
F55	6.3	5.2	6.6	6.6	7.2	0.5 to 0.8	1.9
H63	8	6.3	8.3	8.3	9.0	0.5 to 0.8	2.3
HA0	8	10.0	8.3	8.3	9.0	0.7 to 1.1	3.1
JA0	10	10.0	10.3	10.3	11.0	0.7 to 1.1	4.5

◆ MARKING

EX) 16V47μF



● Rated voltage symbol

Rated voltage (V _{dc})	Symbol
6.3	j
10	A
16	C
25	E
35	V
50	H

◆ PART NUMBERING SYSTEM

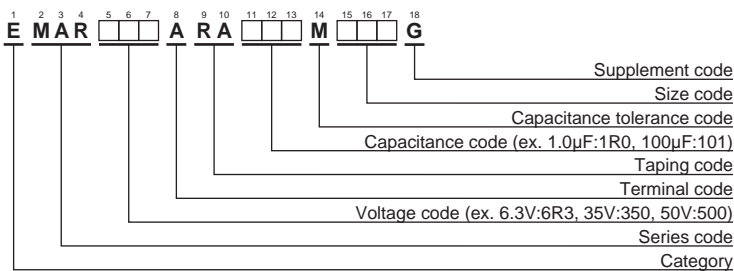

Please refer to "Product code guide (surface mount type)"



Alchip™ - **MAR** Series

◆ STANDARD RATINGS

WV (V _{dc})	Cap (μF)	Size Code	tan δ	Part No.	WV (V _{dc})	Cap (μF)	Size Code	tan δ	Part No.
6.3	22	D55	0.30	EMAR6R3ARA220MD55G	25	4.7	D55	0.16	EMAR250ARA4R7MD55G
	33	E55	0.30	EMAR6R3ARA330ME55G		10	E55	0.16	EMAR250ARA100ME55G
	47	E55	0.30	EMAR6R3ARA470ME55G		22	F55	0.16	EMAR250ARA220MF55G
	100	F55	0.30	EMAR6R3ARA101MF55G		33	F55	0.16	EMAR250ARA330MF55G
	220	H63	0.40	EMAR6R3ARA221MH63G		47	H63	0.16	EMAR250ARA470MH63G
	330	H63	0.40	EMAR6R3ARA331MH63G		100	H63	0.16	EMAR250ARA101MH63G
	470	HA0	0.40	EMAR6R3ARA471MHA0G		220	HA0	0.16	EMAR250ARA221MHA0G
1,000	JA0	0.40	EMAR6R3ARA102MJA0G	330	JA0	0.16	EMAR250ARA331MJA0G		
10	10	D55	0.24	EMAR100ARA100MD55G	35	3.3	D55	0.14	EMAR350ARA3R3MD55G
	22	E55	0.24	EMAR100ARA220ME55G		4.7	D55	0.14	EMAR350ARA4R7MD55G
	33	E55	0.24	EMAR100ARA330ME55G		10	E55	0.14	EMAR350ARA100ME55G
	47	F55	0.24	EMAR100ARA470MF55G		22	F55	0.14	EMAR350ARA220MF55G
	100	F55	0.24	EMAR100ARA101MF55G		33	H63	0.14	EMAR350ARA330MH63G
	220	H63	0.30	EMAR100ARA221MH63G		47	H63	0.14	EMAR350ARA470MH63G
	330	HA0	0.30	EMAR100ARA331MHA0G		100	HA0	0.14	EMAR350ARA101MHA0G
470	JA0	0.30	EMAR100ARA471MJA0G	220	JA0	0.14	EMAR350ARA221MJA0G		
16	4.7	D55	0.20	EMAR160ARA4R7MD55G	50	1.0	D55	0.12	EMAR500ARA1R0MD55G
	10	D55	0.20	EMAR160ARA100MD55G		2.2	D55	0.12	EMAR500ARA2R2MD55G
	22	E55	0.20	EMAR160ARA220ME55G		3.3	D55	0.12	EMAR500ARA3R3MD55G
	33	F55	0.20	EMAR160ARA330MF55G		4.7	E55	0.12	EMAR500ARA4R7ME55G
	47	F55	0.20	EMAR160ARA470MF55G		10	F55	0.12	EMAR500ARA100MF55G
	100	H63	0.26	EMAR160ARA101MH63G		22	H63	0.12	EMAR500ARA220MH63G
	220	HA0	0.26	EMAR160ARA221MHA0G		33	H63	0.12	EMAR500ARA330MH63G
	330	HA0	0.26	EMAR160ARA331MHA0G		47	HA0	0.12	EMAR500ARA470MHA0G
	470	JA0	0.26	EMAR160ARA471MJA0G		100	JA0	0.12	EMAR500ARA101MJA0G

Production of the products shown in is scheduled to be discontinued.

Alchip™-MAK Series

- Suitable for small and low profile product such as the car audio and electronics
- Non solvent resistant type
- RoHS2 Compliant



◆ SPECIFICATIONS

Items	Characteristics						
Category	-40 to +105°C						
Temperature Range	-40 to +105°C						
Rated Voltage Range	6.3 to 50V _{dc}						
Capacitance Tolerance	±20% (M) (at 20°C, 120Hz)						
Leakage Current	I=0.01CV or 3μA, whichever is greater. Where, I : Max. leakage current (μA), C : Nominal capacitance (μF), V : Rated voltage (V) (at 20°C after 2 minutes)						
Dissipation Factor (tan δ)	Rated voltage (V _{dc})	6.3V	10V	16V	25V	35V	50V
	tan δ (Max.)	0.30	0.26	0.22	0.16	0.13	0.12
Low Temperature Characteristics (Max. Impedance Ratio)	Rated voltage (V _{dc})	6.3V	10V	16V	25V	35V	50V
	Z(-25°C)/Z(+20°C)	4	3	2	2	2	2
	Z(-40°C)/Z(+20°C)	8	5	4	3	3	3
Endurance	The following specifications shall be satisfied when the capacitors are restored to 20°C after the rated voltage is applied for 1,000 hours at 105°C.						
	Size code	D55 to F55			H63 to JA0		
	Capacitance change	≤ ±30% of the initial value			≤ ±20% of the initial value		
	D.F. (tan δ)	≤200% of the initial specified value			≤200% of the initial specified value		
	Leakage current	≤The initial specified value			≤The initial specified value		
Shelf Life	The following specifications shall be satisfied when the capacitors are restored to 20°C after exposing them for 1,000 hours at 105°C without voltage applied. Before the measurement, the capacitor shall be preconditioned by applying voltage according to Item 4.1 of JIS C 5101-4.						
	Size code	D55 to F55			H63 to JA0		
	Capacitance change	≤ ±30% of the initial value			≤ ±20% of the initial value		
	D.F. (tan δ)	≤200% of the initial specified value			≤200% of the initial specified value		
	Leakage current	≤The initial specified value			≤The initial specified value		

◆ DIMENSIONS [mm]

- Terminal Code : A

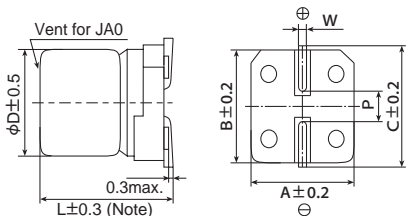

Note : L ± 0.5 for H63 to JA0

Size code	D	L	A	B	C	W	P
D55	4	5.2	4.3	4.3	5.1	0.5 to 0.8	1.0
E55	5	5.2	5.3	5.3	5.9	0.5 to 0.8	1.4
F55	6.3	5.2	6.6	6.6	7.2	0.5 to 0.8	1.9
H63	8	6.3	8.3	8.3	9.0	0.5 to 0.8	2.3
HA0	8	10.0	8.3	8.3	9.0	0.7 to 1.1	3.1
JA0	10	10.0	10.3	10.3	11.0	0.7 to 1.1	4.5

◆ MARKING

EX) 10V100μF



- Rated voltage symbol

Rated voltage (V _{dc})	Symbol
6.3	j
10	A
16	C
25	E
35	V
50	H

◆ PART NUMBERING SYSTEM

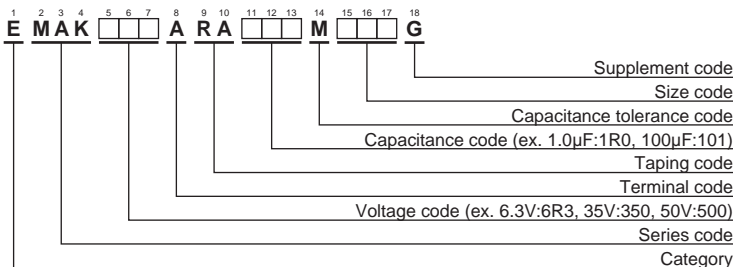

Please refer to "Product code guide (surface mount type)"



Alchip™-MAK Series

◆STANDARD RATINGS

WV (V _{dc})	Cap (μF)	Size Code	tan δ	Part No.	WV (V _{dc})	Cap (μF)	Size Code	tan δ	Part No.
6.3	22	D55	0.30	EMAK6R3ARA220MD55G	25	4.7	D55	0.16	EMAK250ARA4R7MD55G
	33	E55	0.30	EMAK6R3ARA330ME55G		10	E55	0.16	EMAK250ARA100ME55G
	47	E55	0.30	EMAK6R3ARA470ME55G		22	F55	0.16	EMAK250ARA220MF55G
	100	F55	0.30	EMAK6R3ARA101MF55G		33	F55	0.16	EMAK250ARA330MF55G
	220	H63	0.30	EMAK6R3ARA221MH63G		47	H63	0.16	EMAK250ARA470MH63G
	330	H63	0.30	EMAK6R3ARA331MH63G		100	HA0	0.16	EMAK250ARA101MHA0G
	470	HA0	0.30	EMAK6R3ARA471MHA0G		330	JA0	0.16	EMAK250ARA331MJA0G
1,000	JA0	0.30	EMAK6R3ARA102MJA0G	35	4.7	D55	0.13	EMAK350ARA4R7MD55G	
10	22	E55	0.26		EMAK100ARA220ME55G	10	E55	0.13	EMAK350ARA100ME55G
	33	E55	0.26		EMAK100ARA330ME55G	22	F55	0.13	EMAK350ARA220MF55G
	47	F55	0.26		EMAK100ARA470MF55G	33	H63	0.13	EMAK350ARA330MH63G
	100	F55	0.26		EMAK100ARA101MF55G	47	HA0	0.13	EMAK350ARA470MHA0G
	220	H63	0.26		EMAK100ARA221MH63G	100	JA0	0.13	EMAK350ARA101MJA0G
	330	HA0	0.26		EMAK100ARA331MHA0G	220	JA0	0.13	EMAK350ARA221MJA0G
	470	JA0	0.26	EMAK100ARA471MJA0G	50	1.0	D55	0.12	EMAK500ARA1R0MD55G
16	10	D55	0.22	EMAK160ARA100MD55G		2.2	D55	0.12	EMAK500ARA2R2MD55G
	22	E55	0.22	EMAK160ARA220ME55G		3.3	D55	0.12	EMAK500ARA3R3MD55G
	47	F55	0.22	EMAK160ARA470MF55G		4.7	E55	0.12	EMAK500ARA4R7ME55G
	100	H63	0.22	EMAK160ARA101MH63G		10	F55	0.12	EMAK500ARA100MF55G
	220	HA0	0.22	EMAK160ARA221MHA0G		22	H63	0.12	EMAK500ARA220MH63G
	330	HA0	0.22	EMAK160ARA331MHA0G		33	HA0	0.12	EMAK500ARA330MHA0G
	470	JA0	0.22	EMAK160ARA471MJA0G		47	HA0	0.12	EMAK500ARA470MHA0G
				100		JA0	0.12	EMAK500ARA101MJA0G	

Production of the products shown in is scheduled to be discontinued.

AVH Series

- The oxide free copper lead wire and electrolyte on audio purpose are employed
- Non solvent resistant type
- RoHS2 Compliant



SPECIFICATIONS

Items	Characteristics									
Category	-40 to +85°C									
Temperature Range	-40 to +85°C									
Rated Voltage Range	6.3 to 100V _{dc}									
Capacitance Tolerance	±20% (M) (at 20°C, 120Hz)									
Leakage Current	I=0.03CV or 4μA, whichever is greater. (at 20°C after 1 minute) I=0.01CV or 3μA, whichever is greater. (at 20°C after 2 minutes) Where, I : Max. leakage current (μA), C : Nominal capacitance (μF), V : Rated voltage (V)									
Dissipation Factor (tan δ)	Rated voltage (V _{dc})	6.3V	10V	16V	25V	35V	50V	63V	80V	100V
	tan δ (Max.)	0.24	0.20	0.16	0.14	0.12	0.10	0.09	0.08	0.07
	When nominal capacitance exceeds 1,000μF, add 0.02 to the value above for each 1,000μF increase. (at 20°C, 120Hz)									
Low Temperature Characteristics (Max. Impedance Ratio)	Rated voltage (V _{dc})	6.3V	10V	16V	25V	35V	50V	63V	80V	100V
	Z(-25°C)/Z(+20°C)	4	3	2	2	2	2	2	2	2
	Z(-40°C)/Z(+20°C)	10	8	6	4	3	3	3	3	3
(at 120Hz)										
Endurance	The following specifications shall be satisfied when the capacitors are restored to 20°C after the rated voltage is applied for 1,000 hours at 85°C.									
	Capacitance change	≤ ±20% of the initial value								
	D.F. (tan δ)	≤ 150% of the initial specified value								
	Leakage current	≤ The initial specified value								
Shelf Life	The following specifications shall be satisfied when the capacitors are restored to 20°C after exposing them for 500 hours at 85°C without voltage applied. Before the measurement, the capacitor shall be preconditioned by applying voltage according to Item 4.1 of JIS C 5101-4.									
	Capacitance change	≤ ±20% of the initial value								
	D.F. (tan δ)	≤ 150% of the initial specified value								
	Leakage current	≤ The initial specified value								

DIMENSIONS[mm]

- Terminal Code : E

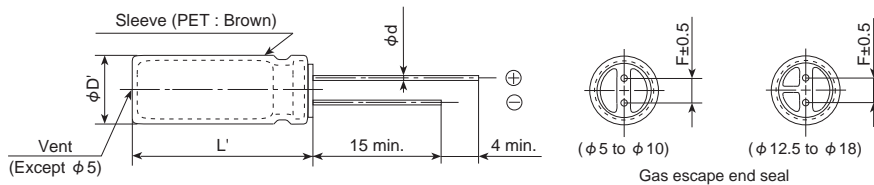

φD	5	6.3	8	10	12.5	16	18
φd	0.6	0.6	0.6	0.8	0.8	0.8	0.8
F	2.0	2.5	3.5	5.0	5.0	7.5	7.5
φD'	φD+0.5 max.						
L'	L+1.5 max.					L+2.0 max.	

PART NUMBERING SYSTEM

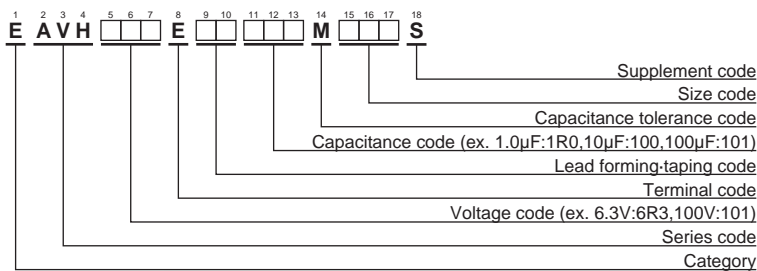

Please refer to "Product code guide (radial lead type)"



AVH Series

◆STANDARD RATINGS

WV (V _{dc})	Cap (μF)	Case size φD×L(mm)	tan δ	Part No.	WV (V _{dc})	Cap (μF)	Case size φD×L(mm)	tan δ	Part No.
6.3	470	10 × 12.5	0.24	EAVH6R3E□□471MJC5S	50	1.0	5 × 11	0.10	EAVH500E□□1R0ME11S
	1,000	10 × 20	0.24	EAVH6R3E□□102MJ20S		2.2	5 × 11	0.10	EAVH500E□□2R2ME11S
	2,200	12.5 × 25	0.26	EAVH6R3E□□222MK25S		3.3	5 × 11	0.10	EAVH500E□□3R3ME11S
	3,300	16 × 25	0.28	EAVH6R3E□□332ML25S		4.7	5 × 11	0.10	EAVH500E□□4R7ME11S
	4,700	16 × 31.5	0.30	EAVH6R3E□□472MLN3S		10	5 × 11	0.10	EAVH500E□□100ME11S
	6,800	16 × 35.5	0.34	EAVH6R3E□□682MLP1S		22	6.3 × 11	0.10	EAVH500E□□220MF11S
	10,000	18 × 40	0.42	EAVH6R3E□□103MM40S		33	8 × 11.5	0.10	EAVH500E□□330MHB5S
10	47	5 × 11	0.20	EAVH100E□□470ME11S		47	8 × 11.5	0.10	EAVH500E□□470MHB5S
	100	6.3 × 11	0.20	EAVH100E□□101MF11S		100	10 × 16	0.10	EAVH500E□□101MJ16S
	220	8 × 11.5	0.20	EAVH100E□□221MHB5S		220	12.5 × 20	0.10	EAVH500E□□221MK20S
	330	10 × 12.5	0.20	EAVH100E□□331MJC5S		330	12.5 × 20	0.10	EAVH500E□□331MK20S
	470	10 × 16	0.20	EAVH100E□□471MJ16S		470	16 × 25	0.10	EAVH500E□□471ML25S
	1,000	12.5 × 20	0.20	EAVH100E□□102MK20S		1,000	16 × 31.5	0.10	EAVH500E□□102MLN3S
	2,200	16 × 25	0.22	EAVH100E□□222ML25S		63	2.2	5 × 11	0.09
	3,300	16 × 31.5	0.24	EAVH100E□□332MLN3S	3.3		5 × 11	0.09	EAVH630E□□3R3ME11S
	4,700	16 × 35.5	0.26	EAVH100E□□472MLP1S	4.7		5 × 11	0.09	EAVH630E□□4R7ME11S
6,800	18 × 40	0.30	EAVH100E□□682MM40S	10	6.3 × 11		0.09	EAVH630E□□100MF11S	
16	33	5 × 11	0.16	EAVH160E□□330ME11S	22		8 × 11.5	0.09	EAVH630E□□220MHB5S
	100	8 × 11.5	0.16	EAVH160E□□101MHB5S	33		8 × 11.5	0.09	EAVH630E□□330MHB5S
	220	10 × 12.5	0.16	EAVH160E□□221MJC5S	47		10 × 12.5	0.09	EAVH630E□□470MJC5S
	330	10 × 16	0.16	EAVH160E□□331MJ16S	100		10 × 20	0.09	EAVH630E□□101MJ20S
	470	10 × 20	0.16	EAVH160E□□471MJ20S	220		12.5 × 20	0.09	EAVH630E□□221MK20S
	1,000	12.5 × 25	0.16	EAVH160E□□102MK25S	330		12.5 × 25	0.09	EAVH630E□□331MK25S
	2,200	16 × 25	0.18	EAVH160E□□222ML25S	470	16 × 25	0.09	EAVH630E□□471ML25S	
	3,300	16 × 35.5	0.20	EAVH160E□□332MLP1S	1,000	18 × 35.5	0.09	EAVH630E□□102MMP1S	
	4,700	18 × 35.5	0.22	EAVH160E□□472MMP1S	80	47	10 × 16	0.08	EAVH800E□□470MJ16S
25	22	5 × 11	0.14	EAVH250E□□220ME11S		220	12.5 × 25	0.08	EAVH800E□□221MK25S
	47	6.3 × 11	0.14	EAVH250E□□470MF11S		330	16 × 31.5	0.08	EAVH800E□□331MLN3S
	100	8 × 11.5	0.14	EAVH250E□□101MHB5S		470	16 × 35.5	0.08	EAVH800E□□471MLP1S
	220	10 × 16	0.14	EAVH250E□□221MJ16S	100	1.0	5 × 11	0.07	EAVH101E□□1R0ME11S
	330	10 × 20	0.14	EAVH250E□□331MJ20S		2.2	5 × 11	0.07	EAVH101E□□2R2ME11S
	470	12.5 × 20	0.14	EAVH250E□□471MK20S		3.3	5 × 11	0.07	EAVH101E□□3R3ME11S
	1,000	16 × 25	0.14	EAVH250E□□102ML25S		4.7	6.3 × 11	0.07	EAVH101E□□4R7MF11S
	2,200	16 × 35.5	0.16	EAVH250E□□222MLP1S		10	8 × 11.5	0.07	EAVH101E□□100MHB5S
	3,300	18 × 40	0.18	EAVH250E□□332MM40S		22	10 × 12.5	0.07	EAVH101E□□220MJC5S
35	33	6.3 × 11	0.12	EAVH350E□□330MF11S		33	10 × 16	0.07	EAVH101E□□330MJ16S
	100	10 × 12.5	0.12	EAVH350E□□101MJC5S		47	10 × 20	0.07	EAVH101E□□470MJ20S
	220	10 × 20	0.12	EAVH350E□□221MJ20S		100	12.5 × 20	0.07	EAVH101E□□101MK20S
	470	12.5 × 25	0.12	EAVH350E□□471MK25S		220	16 × 25	0.07	EAVH101E□□221ML25S
	1,000	16 × 25	0.12	EAVH350E□□102ML25S		330	16 × 31.5	0.07	EAVH101E□□331MLN3S
	2,200	18 × 35.5	0.14	EAVH350E□□222MMP1S		470	18 × 35.5	0.07	EAVH101E□□471MMP1S

□□ : Enter the appropriate lead forming or taping code.

Production of the products shown in is scheduled to be discontinued.

AWJ Series

- Please consult with us when you need "Bi-polar" type
- Non solvent resistant type
- RoHS2 Compliant



◆ SPECIFICATIONS

Items	Characteristics					
Category	-40 to +85°C					
Temperature Range	-40 to +85°C					
Rated Voltage Range	16 to 100V _{dc}					
Capacitance Tolerance	±20% (M) (at 20°C, 120Hz)					
Leakage Current	I = 0.01CV or 3µA, whichever is greater. Where, I : Max. leakage current (µA), C : Nominal capacitance (µF), V : Rated voltage (V) (at 20°C after 2 minutes)					
Dissipation Factor (tan δ)	Rated voltage (V _{dc})	16V	25V	50V	80V	100V
	tan δ (Max.)	0.16	0.14	0.10	0.08	0.07
Low Temperature Characteristics (Max. Impedance Ratio)	Rated voltage (V _{dc})	16V	25V	50V	80V	100V
	Z(-25°C)/Z(+20°C)	2	2	2	2	2
	Z(-40°C)/Z(+20°C)	6	4	3	3	3
Endurance	The following specifications shall be satisfied when the capacitors are restored to 20°C after the rated voltage is applied for 1,000 hours at 85°C.					
	Capacitance change	≤ ±20% of the initial value				
	D.F. (tan δ)	≤ 150% of the initial specified value				
	Leakage current	≤ The initial specified value				
Shelf Life	The following specifications shall be satisfied when the capacitors are restored to 20°C after exposing them for 500 hours at 85°C without voltage applied. Before the measurement, the capacitor shall be preconditioned by applying voltage according to Item 4.1 of JIS C 5101-4.					
	Capacitance change	≤ ±20% of the initial value				
	D.F. (tan δ)	≤ 150% of the initial specified value				
	Leakage current	≤ The initial specified value				

◆ DIMENSIONS [mm]

- Terminal Code : E

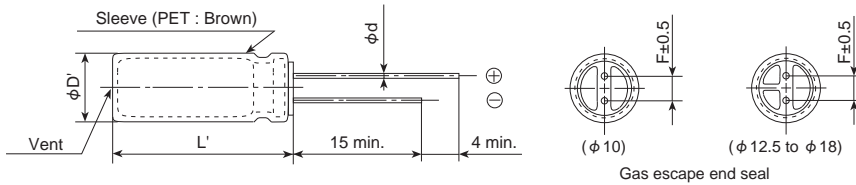

φ D	10	12.5	16	18
φ d	0.8	0.8	0.8	0.8
F	5.0		7.5	
φ D'	φ D + 0.5 max.			
L'	L + 1.5 max.		L + 2.0 max.	

◆ PART NUMBERING SYSTEM

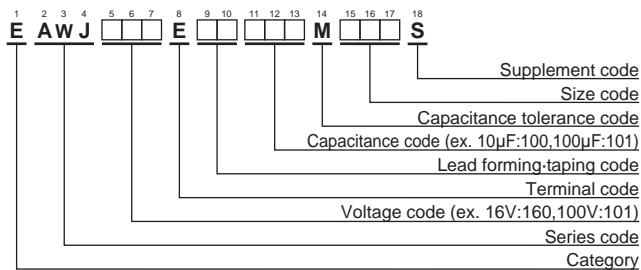

Please refer to "Product code guide (radial lead type)"

AWJ Series

◆STANDARD RATINGS

WV (V _{dc})	Cap (μF)	Case size φD×L(mm)	tan δ	Part No.	WV (V _{dc})	Cap (μF)	Case size φD×L(mm)	tan δ	Part No.
16	220	10 × 20	0.16	EAWJ160E□□221MJ20S	80	22	10 × 16	0.08	EAWJ800E□□220MJ16S
	330	12.5 × 20	0.16	EAWJ160E□□331MK20S		33	10 × 20	0.08	EAWJ800E□□330MJ20S
	470	12.5 × 25	0.16	EAWJ160E□□471MK25S		47	10 × 20	0.08	EAWJ800E□□470MJ20S
	1,000	16 × 31.5	0.16	EAWJ160E□□102MLN3S		100	12.5 × 25	0.08	EAWJ800E□□101MK25S
25	100	10 × 16	0.14	EAWJ250E□□101MJ16S		220	16 × 31.5	0.08	EAWJ800E□□221MLN3S
	220	12.5 × 20	0.14	EAWJ250E□□221MK20S		330	16 × 35.5	0.08	EAWJ800E□□331MLP1S
	330	12.5 × 25	0.14	EAWJ250E□□331MK25S		470	18 × 40	0.08	EAWJ800E□□471MM40S
	470	16 × 25	0.14	EAWJ250E□□471ML25S		100	10	10 × 16	0.07
	1,000	16 × 35.5	0.14	EAWJ250E□□102MLP1S	22		10 × 20	0.07	EAWJ101E□□220MJ20S
50	22	10 × 16	0.10	EAWJ500E□□220MJ16S	33		12.5 × 20	0.07	EAWJ101E□□330MK20S
	33	10 × 16	0.10	EAWJ500E□□330MJ16S	47		12.5 × 25	0.07	EAWJ101E□□470MK25S
	47	10 × 16	0.10	EAWJ500E□□470MJ16S	100		16 × 25	0.07	EAWJ101E□□101ML25S
	100	12.5 × 20	0.10	EAWJ500E□□101MK20S	220		18 × 35.5	0.07	EAWJ101E□□221MMP1S
	220	16 × 25	0.10	EAWJ500E□□221ML25S	330		18 × 45	0.07	EAWJ101E□□331MM45S
	330	16 × 31.5	0.10	EAWJ500E□□331MLN3S					
	470	16 × 35.5	0.10	EAWJ500E□□471MLP1S					
1,000	18 × 45	0.10	EAWJ500E□□102MM45S						

□□ : Enter the appropriate lead forming or taping code.

Technical Note

— Judicious Use of Aluminum Electrolytic Capacitors —

Contents

1. Overview of Aluminum Electrolytic Capacitors

- 1 – 1 Basic Model of Aluminum Electrolytic Capacitors
- 1 – 2 Structure of Aluminum Electrolytic Capacitors
- 1 – 3 Features of Capacitor Materials
- 1 – 4 Manufacturing process

2. Basic Performance

- 2 – 1 Basic Electrical Characteristics
- 2 – 2 Frequency Characteristics of Impedance

3. Reliability

4. Failure Modes

5. Lifetime of Aluminum Electrolytic Capacitors

- 5 – 1 Ambient Temperature Effect on Lifetime
- 5 – 2 Applying Voltage Effect on Lifetime
- 5 – 3 Ripple Current Effect on Lifetime
- 5 – 4 Charge and Discharge Operation Effect on Lifetime
- 5 – 5 Inrush Current
- 5 – 6 Abnormal Voltage Effect on Lifetime

6. Effect of Halogens

- 6 – 1 Effect of Flux
- 6 – 2 Cleaning Agents
- 6 – 3 Adhesive and Coating Materials
- 6 – 4 Effect of Fumigation

7. Recovery Voltage

8. Storage

9. Tips for Selecting Capacitors Appropriate for Individual Applications

- 9 – 1 Input Filtering Capacitors for Switching Mode Power Supplies
- 9 – 2 Output Filtering Capacitors for Switching Mode Power Supplies
- 9 – 3 Filtering Capacitors for Inverter Main Circuits
- 9 – 4 Capacitors for Control Circuits
- 9 – 5 Photoflash Capacitors

1. Overview of Aluminum Electrolytic Capacitors

1-1 Basic Model of Aluminum Electrolytic Capacitors

Capacitors are passive components. Among the various kinds of capacitors, aluminum electrolytic capacitors offer larger CV product per case size and lower cost than the others. In principles of capacitor, its fundamental model is shown in Fig. 1 and its capacitance (C) is expressed by Equation (1) below:

$$C = 8.854 \times 10^{-12} \frac{\epsilon r S}{d} \text{ (F)} \dots\dots\dots(1)$$

- ϵr : Dielectric constant
- S : Surface area of dielectric(m²)
- d : Thickness of dielectric(m)

Equation (1) shows that the capacitance (C) increases as the dielectric constant (ϵr) and/or its surface area (S) increases and/or the dielectric thickness (d) decreases.

An aluminum electrolytic capacitor comprises a dielectric layer of aluminum oxide (Al₂O₃), the dielectric constant (ϵr) of which is 8 to 10. This value is not significantly larger than those of other types of capacitors.

However, by extending the surface area (S) of the aluminum foil electrode by means of etching, and by electrochemically forming a thinner but highly voltage-withstandable layer of oxide layer dielectric, the aluminum electrolytic capacitor can offer a larger CV product per case size than other types of capacitors.

A basic model of aluminum electrolytic capacitor is shown in Fig. 2. An aluminum electrolytic capacitor comprises:

- Anode ...Aluminum foil
- Dielectric...Electrochemically formed oxide layer (Al₂O₃) on the anode
- Cathode ...A true cathode is electrolytic solution (electrolyte).

Other component materials include a paper separator that holds electrolyte in place and another aluminum foil that functions as a draw-out electrode coming into contact with the true cathode (electrolyte).

In general, an aluminum electrolytic capacitor is asymmetrical in structure and polarized. The other capacitor type known as a bi-polar (non-polar) comprises the anodic aluminum foils for both electrodes.

1-2 Structure of Aluminum Electrolytic Capacitor

The aluminum electrolytic capacitor has, as shown in Fig. 3, a roll of anode foil, paper separator, cathode foil and electrode terminals (internal and external terminals) with the electrolyte impregnated, which is sealed in an aluminum can case with a sealing material.

The terminal draw-out structure, sealing material and structure differ depending on the type of the capacitor. Figure 4 shows typical examples.

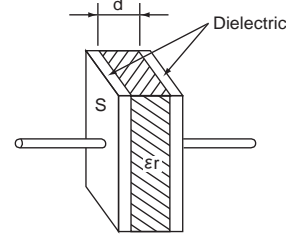
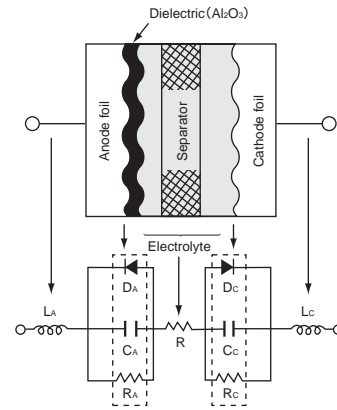

Fig-1 Basic model of capacitor



- C_A, C_C : Capacitance due to anode and cathodes foils
- D_A, D_C : Diode effects due to oxide layer on anode and cathode foils
- L_A, L_C : Inductance due to anode and cathode terminals
- R : Resistance of electrolyte and separator
- R_A, R_C : Internal resistance of oxide layer on anode and cathode foils

Fig-2 Basic model and equivalent circuit of aluminum electrolytic capacitor

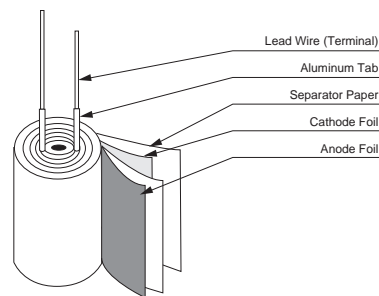

Fig-3 Basic model of element

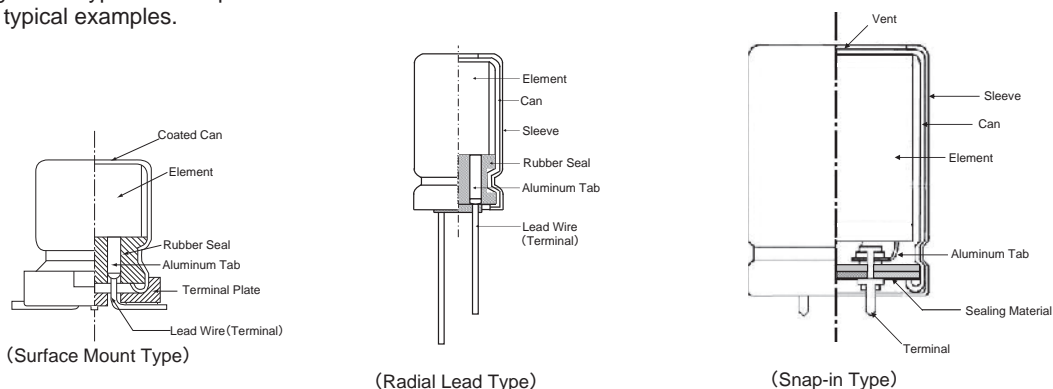

Fig-4 Construction of Aluminum Electrolytic Capacitors

1-3 Features of Capacitor Materials

Aluminum, which is main material in an aluminum electrolytic capacitor, forms an oxide layer (Al_2O_3) on its surface when the aluminum is set as anode and charged with electricity in electrolyte.

The aluminum foil with an oxide layer formed thereon, as shown in Fig. 5, is capable of rectifying electric current in electrolyte. Such a metal is called a valve metal.

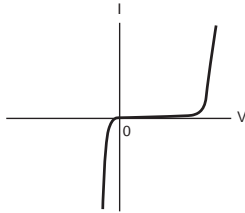

Fig-5 V-I characteristics of aluminum oxide

<Anode aluminum foil>

First, the foil material is electromechanically etched in a chloride solution to extend the surface area of the foil.

Secondly, for the foil to form an aluminum oxide layer (Al_2O_3) as a dielectric, more than the rated voltage is applied to the foil in a solution such as ammonium borate. This dielectric layer is as dense and thin as 1.1 - 1.5 nm/volt and showing a high insulation resistance ($10^8 - 10^9 \Omega/m$).

The thickness of the oxide layer determines the withstand voltage according to their direct proportional relationship. For the etching pits to be shaped to the intended thickness of the oxide layer, the pit patterns have been designed to have efficient surface area extension depending on the intended withstand voltage (see Fig. 6)

<Cathode aluminum foil>

An etching process is performed to the cathode aluminum foil as well as the anode foil. However, the formation process for oxide layer is generally not performed. Therefore, the surface of the cathode foil only has an oxide layer (Al_2O_3) that has spontaneously formed, which gives a withstand voltage of about 0.5 volt.

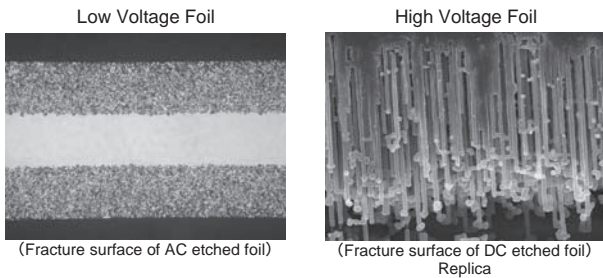

Fig-6 Cross section of aluminum etched foil (SEM)

<Electrolyte>

The electrolyte, an ion-conductive liquid functions as a true cathode coming into contact with the dielectric layer on the surface of the anode foil. The cathode foil serves as a collector electrode to connect the true cathode with the external circuit. Electrolyte is an essential material that controls the performance of the capacitor (temperature characteristics, frequency characteristics, service life, etc.).

<Paper separator >

The separator maintains uniform distribution of the electrolyte and keeps the anode-to-cathode foil distance unchanged.

<Can case and sealing materials>

An aluminum can case and seal materials mainly consisting of rubber are used for the purpose of keeping airtightness.

1-4 Manufacturing Process

① Etching (for extending the surface area)

This etching process serves to extend the surface area of the aluminum foil. This is an AC or DC current-employed electrochemical process for etching the foil surface in a chloride solution.

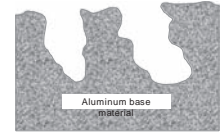

Etching Model

② Formation (for forming a dielectric)

This is a process for forming a dielectric layer (Al_2O_3), which is normally performed on the anode aluminum foil.

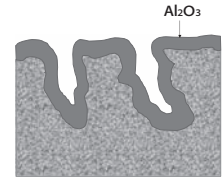

Forming Model

③ Slitting

This is a process for slitting aluminum foils (both the anode and cathode) and paper separators to the specified product size.

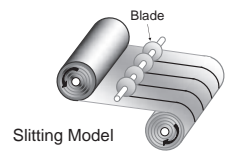

Slitting Model

④ Winding

This is a process for rolling a set of anode and cathode foils into a cylindrical form with a paper separator inserted between them. During this process, an inner terminal (called a tab) is attached to each of the aluminum foils. The roll made at this process is called a capacitor element.

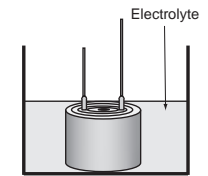
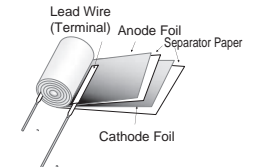

Impregnation

⑤ Impregnation

This is a process for impregnating the element with electrolyte as a true cathode. The electrolyte also functions to repair the dielectric layer.

⑥ Sealing

This process seals the element using the aluminum can case and sealing materials (rubber, rubber-lined cover, etc.) for keeping the case airtight.

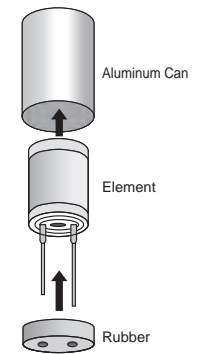

⑦ Aging (reforming)

The process of applying voltage to a post-sealed capacitor at high temperature is called "aging". This serves to repair defective dielectrics that have been made on the foil during the slitting or winding process.

⑧ 100% inspection and packaging

After the aging, all products shall undergo testing for checking their electrical characteristics with chip termination, lead reforming, taping etc. finished, and then be packaged.

⑨ Outgoing inspections

Outgoing inspections are performed as per standard inspection procedures.

⑩ Shipment

2. Basic Performance

2-1 Basic Electrical Characteristics

2-1-1 Capacitance

The larger the surface area of an electrode is, the higher the capacitance (capacity for storing electricity) is. For aluminum electrolytic capacitors, the capacitance is measured under the standard measuring conditions of 20°C and a 120Hz AC signal of about 0.5V. Generally, as the temperature rises, the capacitance increases; as the temperature decreases, the capacitance decreases (Fig. 7). With a higher frequency, the capacitance is smaller; with a lower frequency, the capacitance is larger (Fig. 8).

2-1-2 Tan δ (also called tangent of loss angle or dissipation factor)

(Fig. 9) is a simplified model of the equivalent circuit shown in (Fig. 2). For an ideal capacitor with an equivalent series resistance of $R = 0$, the $\tan \delta$ shown in (Fig. 10) is zero. For an aluminum electrolytic capacitor, the equivalent series resistance (R) is not zero due to the presence of resistance of the electrolyte and paper separator and other contact resistances. $1/\omega C$ and R are correlated as shown in (Fig. 10) and Equation (2).

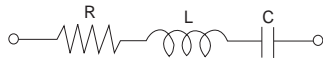

Fig-9 Simplified equivalent circuit

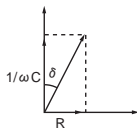

Fig-10 Dissipation Factor ($\tan \delta$)

$$\tan \delta = \frac{R}{1/\omega C} = \omega CR \dots\dots\dots (2)$$

$$\omega : 2\pi f$$

$$\pi = \text{Circular constant, } f : \text{Frequency (} f = 120\text{Hz)}$$

2-1-3 Leakage Current (LC)

As a feature of an aluminum electrolytic capacitor, when DC voltage is applied to it, the oxide layer that acts as a dielectric in the electrolyte allows a small amount of electric current to flow in it. The small amount of current is called a leakage current (LC). An ideal capacitor does not allow the leakage current to flow (this is not the case for charging current).

The leakage current (LC) changes with time as shown in (Fig. 12). Note that LC, decreasing with time, will reach a steady-state value. Therefore, the specifications of LC are defined as a value measured several minutes after the beginning of the application of the rated voltage at 20°C. As the temperature rises, the LC increases; as the temperature decreases, the LC decreases (Fig.13). As the applied voltage decreases, the LC decreases.

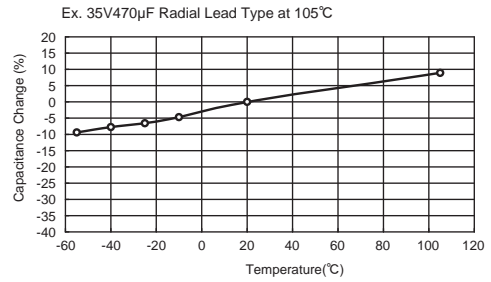

Fig-7 Temperature Characteristics of Capacitance

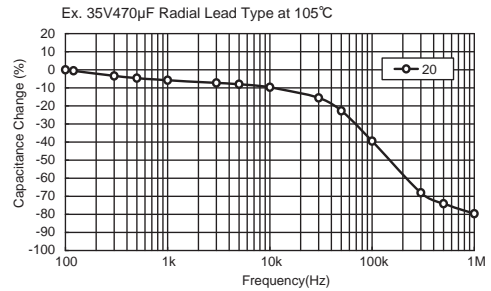

Fig-8 Frequency Characteristics of Capacitance

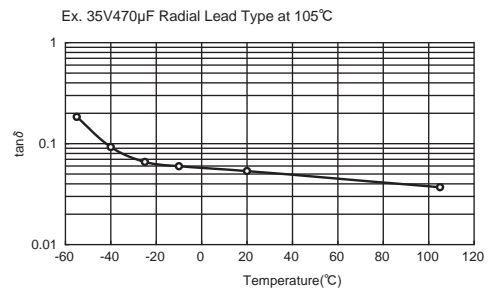

Fig-11 Temperature Characteristics of $\tan \delta$

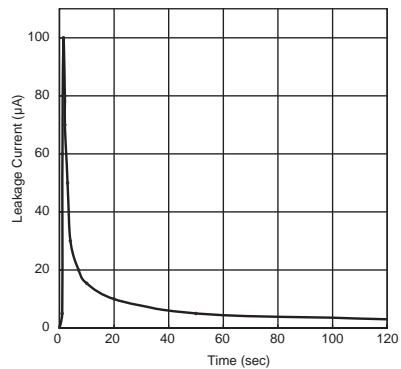

Fig-12 Leakage Current vs. Time

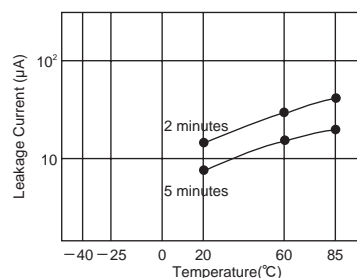

Fig-13 Temperature Characteristics of Leakage Current

2-2 Frequency Characteristics of Impedance

When a capacitor is applied with a voltage with the frequency changed, the impedance (Z), a factor of preventing the AC current changes as shown in (Fig. 14). This is the impedance-frequency characteristics of the capacitor.

(Fig. 9) is a simplified model of an equivalent circuit of an aluminum electrolyte capacitor. (Fig. 14) shows dotted lines representing a breakdown of the impedance-frequency characteristic curve into components (C, R and L). As can be seen in this figure, the impedance-frequency characteristics are a composition of C, R and L frequency characteristics.

The value $1/\omega C$ shows the pure capacitive reactance graphically presented by a straight line going downward at an angle of 45° , and ωL shows the pure inductive reactance graphically presented by a straight line going upward at 45° . R shows the equivalent series resistance (ESR). At a range of lower frequencies, the R curve goes downward due to the dielectric loss frequency-dependence. At a range of higher frequencies, the R curve tends to be almost flat since resistance of electrolyte and paper separator is dominant and independent on frequency. Equation (3) shows this tendency.

$$Z = \sqrt{R^2 + \left(\omega L - \frac{1}{\omega C}\right)^2} \dots\dots\dots (3)$$

Because the impedance characteristics of an aluminum electrolyte capacitor depend on resistance of the electrolyte and paper separator, the Z value at the self-resonant frequency tends to be relatively higher, as shown by the solid line in (Fig. 15). The resistance of the electrolyte varies depending on temperature: as the temperature rises, the impedance decreases; and as the temperature decreases, the impedance increases, as shown in (Fig. 16).

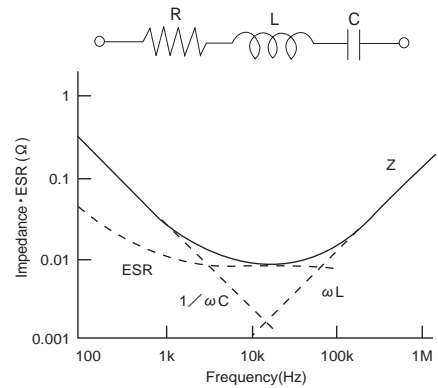

Fig-14 Factor of Impedance Frequency

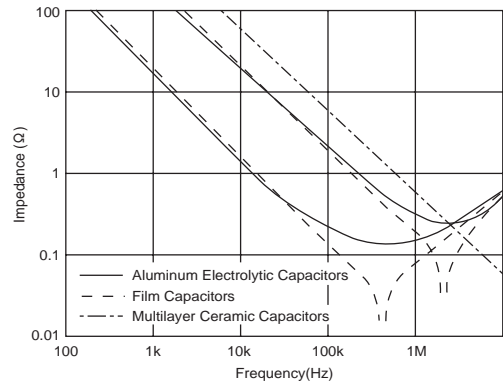

Fig-15 Frequency Characteristics of each Capacitors Impedance

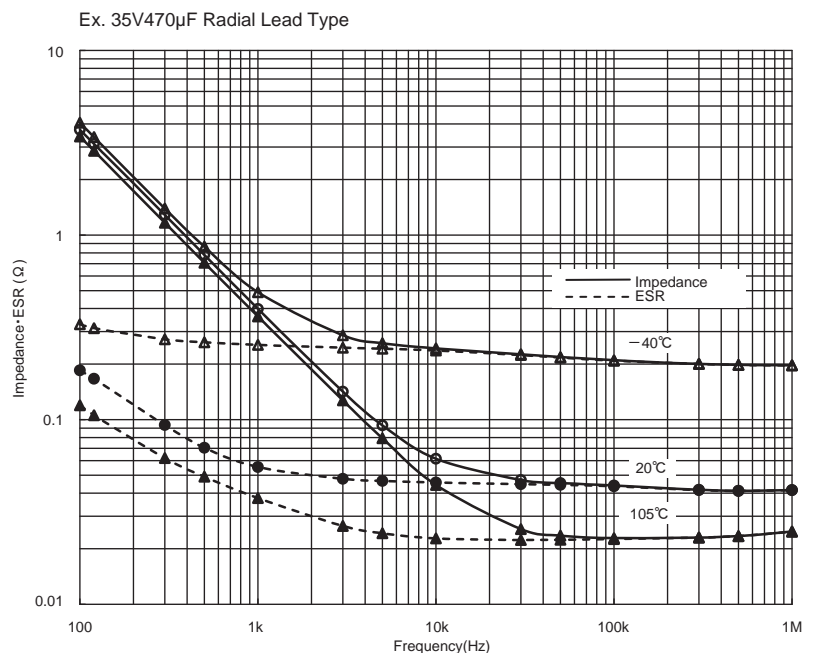

Fig-16 Temperature and Frequency Characteristics of Impedance · ESR

3. Reliability

For designing the device with aluminum electrolytic capacitors, a failure rate and useful life are necessary to be considered for their reliability. The failure rate of aluminum electrolytic capacitors is approximated by the bathtub curve shown in (Fig.17).

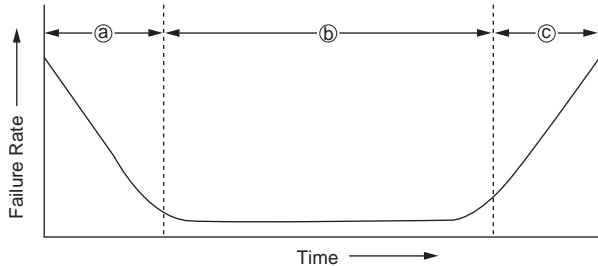

Fig-17 Bathtub curve

- (a) **Early failure period**
At the comparatively early periods of use, devices/components fail by deficiencies in design or manufacturing process or incompatibility with operation conditions. For aluminum electrolytic capacitors, these defectives are removed by debugging at one of manufacturing processes before shipments.
- (b) **Random failure period**
Failure is stable low in occurrence and appears unrelated to their served term. Aluminum electrolytic capacitors are low in catastrophic failures in this period compared with semi-conductors and solid tantalum capacitors.
- (c) **Wear-out failure period**
In this period, the failure rate increases with the served time. For aluminum electrolytic capacitors, since they were completed in manufacturing, the electrolyte impregnated has gradually evaporated and diffused out of the capacitors through the rubber seal materials with time, which leads to decrease in the capacitance and/or increase $\tan\delta$. When any of these values changes beyond the allowable range of specifications, the capacitors are defined as "fell into the wear-out failure". The served term until the capacitors fall into the wear-out failure period is called a useful life.

Aluminum electrolytic capacitors have two categories of failures: catastrophic failure and wear-out failure.

<Catastrophic failure>

This is a failure mode that completely destroys the function of the capacitor such as short circuit and open circuit failure.

<Wear-out failure>

This is a failure mode where the electrical parameters of the capacitor gradually deteriorate and fail. The criteria for determining if this failure has occurred depend on the purpose of a device. For each series of capacitors, the following electrical parameters have been defined as criteria in the specifications of Endurance in the catalogs or product specifications:

- Change in capacitance
- $\tan\delta$
- Leakage current

Failure rates are often measured in units of % per 1000 hours ($10^{-5}/\text{hour}$). For higher reliability devices designed with a smaller failure rate, units of Failure In Time (FIT) ($10^{-9}/\text{hour}$) is used.

Aluminum electrolytic capacitors are considered as components of wear-out failure mode, the electrical characteristics of which gradually deteriorate and their failure rate increases with time. In general, the failure rate in FIT is determined by total component-hours (product of the number of tested components and test hours).

Due to the definition of FIT, the same FIT rate can be calculated in both cases of testing on the large number of tested components and also testing for long test periods of time. However, these cases mean differently for aluminum electrolytic capacitors. Using the failure rate is not suited to express the reliability of aluminum electrolytic capacitors, but the electrical characteristics based lifetime in hour should be considered to express the reliability.

Also, there are MTBF (Mean Time Between Failures) and MTTF (Mean Time To Failure) to express reliability. The latter is applicable for aluminum electrolytic capacitors because they are categorized into a group of non-repairable systems, equipment and devices for which MTTF is applicable.

4. Failure Modes

Failure modes depend on the application conditions that lead to fail. (Fig. 18).

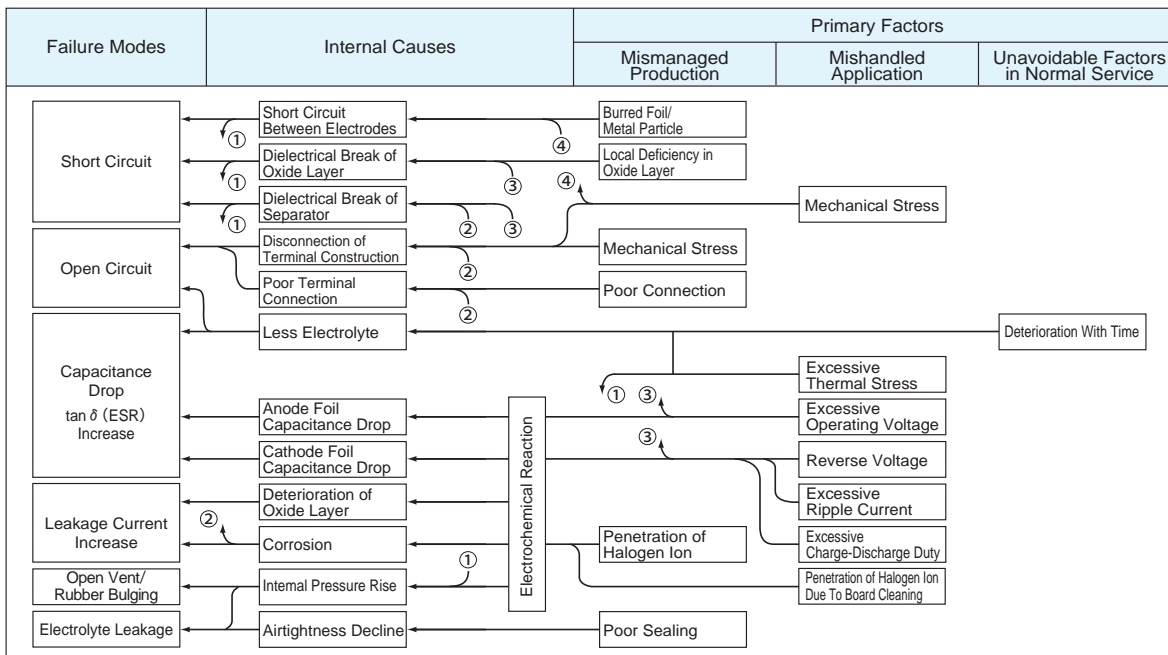

Fig-18 Failure Modes

5. Lifetime of Aluminum Electrolytic Capacitors

The lifetime of aluminum electrolytic capacitors is largely dependent on the application conditions. Environmental factors include temperature, humidity, atmospheric pressure and vibrations. Electrical factors include operating voltage, ripple current and charge-discharge. Where the capacitors are used in a normal filtering circuit, ambient temperature and heating due to the ripple current are crucial factors for determining the lifetime of the capacitors. These factors are included to the lifetime specifications titled "Endurance" on the catalogs or product specifications. For applications subject to high humidity and/or continuous vibrations, or subject to frequent charge and discharge operations, the endurance of individual conditions should be considered.

5-1 Ambient Temperature Effect on Lifetime

The lifetime of aluminum electrolytic capacitors is affected mainly by the loss of electrolyte as the result of diffusion through the rubber seal materials, which leads to a decrease in capacitance and increase in $\tan \delta$.

The relationship of temperature to the diffusion of electrolyte follows the Arrhenius' Law (Equations (4) and (5)):

$$k = Ae^{\frac{-E}{RT}} \dots\dots\dots (4)$$

$$\ln k = \left(\frac{-E}{RT} \right) + \ln A \dots\dots\dots (5)$$

- k : Reaction rate constant
- A : Frequency factor
- E : Activation energy
- R : Gas constant (8.31J/deg)
- T : Absolute temperature (K)

Applying Equation (5) to the lifetime of the capacitors brings Equation (6), which is converted to Equation (7):

$$\log \left(\frac{L_x}{L_o} \right) = \frac{E}{2.303R} \left(\frac{1}{T_x} - \frac{1}{T_o} \right) \dots\dots\dots (6)$$

$$\log L_x = \frac{E}{2.303R} \left(\frac{1}{T_x} - \frac{1}{T_o} \right) + \log L_o \dots\dots\dots (7)$$

Practical estimation of the lifetime has been using Equation (8) as an approximation:

$$L_x = L_o \cdot Bt^{(T_o - T_x)/10} \dots\dots\dots (8)$$

- L_o : Specified lifetime (hour) with the rated voltage applied (or the rated ripple current superimposed to a DC voltage) at the upper limit of the category temperature. Refer to the lifetime specifications of individual products.
- L_x : Estimated life on actual usage (hour)
- T_o : Maximum Category Temperature (°C)
- T_x : Actual Ambient Temperature (°C)
- Bt : Temperature acceleration factor

Where, the temperature acceleration factor (BT) is approximately 2 over an ambient temperature range from 60°C to 95°C, which means that the lifetime is approximately halved for every 10°C rise in ambient temperature. However, according to the Arrhenius Equation (6), the reciprocal of T is directly proportional to the logarithm of lifetime, which means that, strictly speaking, there is the temperature range where the theory of lifetime reducing by half at every 10°C rise is not applied. (Fig. 19).

Especially for capacitors whose maximum operating temperature is a 105°C or higher, the temperature acceleration factor (BT) needs to be modified depending on temperature ranges of the lifetime estimation. For details, please consult us.

For lifetime estimation at a lower-temperature range, evaluation test data have not been obtained, and for evaluating long term endurance, it is necessary to take into account some additional factors such as deterioration of the rubber seal materials as well as the diffusion of electrolyte. Accordingly, in Equation (8), T_x should be 40°C at the lowest for the lifetime calculation purpose, and also the estimated lifetime (L_x) should be 15 years at the longest.

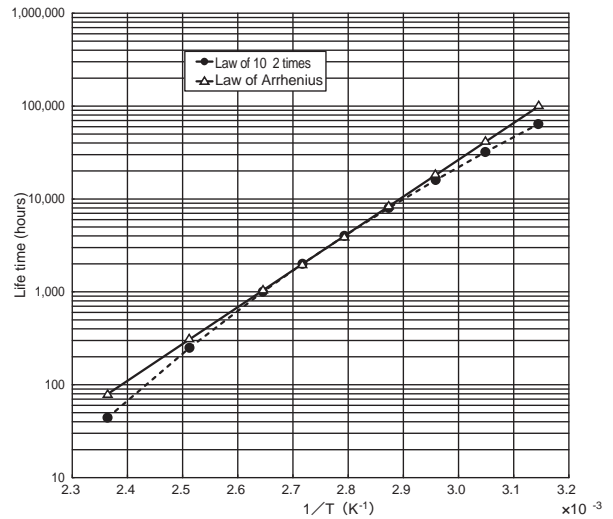

Fig-19 Estimated result by Law of 10°C 2 times and Law of Arrhenius

5-2 Applying Voltage Effect on Lifetime

Where a capacitor is used at lower than the rated voltage, the lifetime may not be adversely affected, which means that the effect of the applying voltage is negligibly small, while the effect of the ambient temperature and heat generation due to ripple current is significant.

(Fig-20)

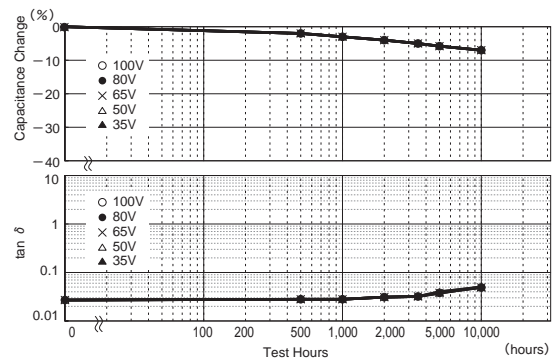

Fig-20 Endurance (measured by each apply voltage, result curves are overlapped)
Note: Due to the very small effect of the applying voltages, the plots cannot be distinguished from one another.

However, for capacitors of larger size and higher rated voltage contain a larger volume of electrolyte, difference in applying voltages can affect degradation of the oxide layer, other than the diffusion of electrolyte.

Therefore, with the exception of certain items, for board-mount products with a rated voltage of 160Vdc or higher, and screw mount terminal-type products with a rated voltage of 350Vdc or higher, the product lifespan estimation includes the effect of applying a lower voltage than the rated voltage (derating voltage).

5-3 Ripple Current Effect on Lifetime

Since an aluminum electrolytic capacitor has a larger $\tan\delta$ than other types of capacitors, the capacitor produces more internal heat when a ripple current flows through it. The temperature rise due to this heat may significantly affect the lifetime of the capacitor. This is the reason why ripple current ratings are specified for capacitors.

5-3-1 Heat Generation due to Ripple Current

Power consumption by the ripple current can be expressed as follows:

$$W = I_R^2 R + V I_L \dots\dots\dots (9)$$

- W : Internal power dissipation
- I_R : Ripple Current
- R : Internal Resistance (Equivalent Series Resistance)
- V : Applied voltage
- I_L : Leakage Current

Leakage current I_L at the maximum operating temperature can be 5 to 10 times higher than the values measured at 20°C. However, considering $I_R \gg I_L$, the above equation can be simplified as Equation (10).

$$W \approx I_R^2 R \dots\dots\dots (10)$$

To obtain the temperature at which equilibrium is achieved between heat generation and dissipation, derive Equation (11).

$$I_R^2 R = \beta A \Delta T \dots\dots\dots (11)$$

- β : Radiation Constant
- A : Surface area of can case (m^2)
- ΔT : Temperature-rise due to the Ripple Current(°C)
- $A = \frac{\pi}{4} D(D + 4L)$
- D : Can Diameter (m)
- L : Can Length (m)

From the above equation, the internal temperature rise (ΔT) is given by Equation (12):

$$\Delta T = \frac{I_R^2 R}{\beta A} \dots\dots\dots (12)$$

Also, for a ripple frequency of 120Hz, Equation (12) for calculating ΔT is rewritten as Equation (13):

$$\Delta T = \frac{I_R^2 R}{\beta A} = \frac{I_R^2 \tan \delta}{\beta A \omega C} \dots\dots\dots (13)$$

Where $R = \frac{\tan \delta}{\omega C}$

- $\tan \delta$: Dissipation Factor at 120Hz
- ω : $2 \pi f$ ($f = 120\text{Hz}$)
- C : Capacitance at 120Hz(F)

An approximate value of ripple current-caused ΔT can be calculated using Equation (14):

$$\Delta T = (I_x/I_o)^2 \times \Delta T_o \dots\dots\dots (14)$$

- I_o : Rated ripple current (Arms), frequency compensated, at the upper limit of the category temperature range
- I_x : Operating ripple current (Arms) actually flowing in the capacitor
- ΔT_o : Rise in internal temperature due to the rated ripple current (°C): different for each product series. Please consult us.

There are some product families that can accept a higher ripple current than the rated value providing that ambient temperature T_x is lower than the upper limit of the category temperature range. However, in this case, remember that the lifetime decreases due to the higher ΔT due to the ripple current. Be sure that ΔT does not exceed the specified limit that has been determined as a function of ambient temperature. Note that the core temperature limit of the element is shown by $[T_x + \Delta T \text{ limit}]$.

Examples of ΔT limits at some ambient temperatures are shown below.

Ambient Temp T_x	85°C less or equal	105°C
Limit value of ΔT	15°C	5°C

Each product family has a different ΔT limit. For details, consult us.

5-3-2 Ripple Current and Frequency

The ripple current rating is specified normally by the effective value (r.m.s value) of 120Hz or 100kHz sine wave. However, since the equivalent series resistance

(ESR) of a capacitor is frequency-dependent, the allowable ripple current depends on the frequency. Where the operating ripple current consists of a mains power frequency element and switching frequency element(s) like switching mode power supplies do, the internal power loss is expressed by Equation (15):

$$W = I_{f1}^2 R_{f1} + I_{f2}^2 R_{f2} + \dots\dots I_{fn}^2 R_{fn} \dots\dots\dots (15)$$

- W : Power consumption
- $I_{f1}, I_{f2}, \dots, I_{fn}$: Ripple current (Arms) at frequency $f1 \dots fn$
- $R_{f1}, R_{f2}, \dots, R_{fn}$: ESR (Ω) at $f1 \dots fn$

Given a frequency compensation factor (Frequency Multiplier) = F_{fn} and reference frequency for the ripple current = f_o , $R_{fn} = R_o/F_{fn}^2$ is obtained. Therefore, the ripple current at any frequency can be converted into its r.m.s. value at the reference frequency (I_{fo}) using Equation (16):

$$I_{fo} = \sqrt{(I_{f1}/F_{f1})^2 + (I_{f2}/F_{f2})^2 + \dots\dots (I_{fn}/F_{fn})^2} \dots\dots\dots (16)$$

- I_{fo} : Reference ripple current (Arms), i.e., that at the reference frequency
- $F_{f1}, F_{f2}, \dots, F_{fn}$: Frequency compensation factor (Frequency Multiplier) at frequency $f1 \dots fn$ (Refer to the catalogs)

Note that the ESR depends on the temperature and the value of β depends on the installation conditions of the capacitor on the board. To determine more accurate values of ΔT , they can be actually measured using a thermocouple.

5-3-3 Lifetime Estimation

Equations (17) through (19) can be used for estimating the lifetime of a non-solid aluminum electrolytic capacitor based on the ambient temperature, the rise of internal temperature due to ripple current, and operating voltage applied.

For a surface mount type or radial lead type capacitor :
Endurance specifications are defined by the rated voltage.

$$L_x = L_o \times 2^{\frac{T_o - T_x}{10}} \times 2^{\frac{-\Delta T}{5}} \dots\dots\dots (17)$$

For a surface mount type or radial lead type capacitor : Endurance specifications are defined by "the rated ripple current superimposition".

$$L_x = L_r \times 2^{\frac{T_o - T_x}{10}} \times 2^{\frac{\Delta T_o - \Delta T}{5}} \dots\dots\dots (18)$$

For a snap-in type or screw terminal type capacitor

$$L_x = L_r \times 2^{\frac{K(T_o - T_x)}{10}} \times 2^{\frac{\Delta T_o - \Delta T}{A}} \times K_v \dots\dots\dots (19)$$

- L_o : Specified lifetime (hour) at the upper limit of the category temperature range and at the rated voltage
- L_r : Specified lifetime (hour) at the upper limit of the category temperature range and at the rated ripple current superimposed to a DC voltage
- L_x : Estimation of actual lifetime (hour)
- T_o : Upper limit of the category temperature range (°C)
- T_x : Actual ambient temperature of the capacitor (°C)
Use 40°C if the actual ambient temperature is below it.
- ΔT : Rise of internal temperature due to actual ripple current (°C)
- * ΔT_o : Rise of internal temperature due to the rated ripple current (°C)
- * K_t : Correction factor of ambient temperature acceleration factor
- * K_v : Derating voltage factor (a snap-in type capacitor with the rated voltage of less than 160V_{dc} and a screw terminal type capacitor with the rated voltage of less than 350V_{dc} :1)
- * A : Acceleration factor of temperature-rise due to the ripple current (This factor depends on use conditions.)

For the values marked with *, consult us.

Please consult us about lifetime equations for the series of the category temperature 125°C or more.

Subject series : MXB, MHS, MVH, MHL, MHB, MHJ, MHK, GPA, GVA, GXF, GXL, GPD, GVD, GQB, GXA, GXM.

Note that the calculation results above are not considered as a guaranteed value. When designing the lifetime of a device, please select a capacitor that has an extra margin against the device lifetime requirements. Also, where the estimation result calculated exceeds 15 years, please consider 15 years to be a maximum. If 15 years or more may be required as an expected lifetime, please consult us.

5-4 Charge and Discharge Operation Effect on Lifetime

Applying a voltage to an aluminum electrolytic capacitor makes the electric charges accumulate on the anode foil dielectric. Discharging the electricity through a discharging resistance makes the electric charges move to the cathode foil and cause chemical reactions between the cathode aluminum and electrolyte, thereby forming a dielectric oxide layer.

When this charge and discharge is repeatedly operated, the chemical reactions proceed to further form the oxide layer on the cathode foil, causing the capacitance of the cathode foil to reduce and thereby reducing the capacitance of the capacitor. Moreover, the chemical reactions bring heat and gases. Depending on the charge and discharge conditions, the internal pressure may increase, the pressure relief vent may open or the capacitor may have destructive failures. Consult us for using a capacitor with the following applications:

- Frequently repeating power on/off.
- Repeating rapid charge and discharge operations at a short interval cycle.
- Repeating charge and discharge operations with a large voltage drop.

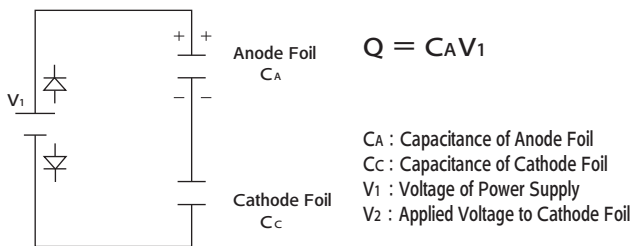

Fig-21 Charge Condition at Charge

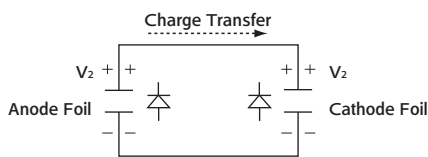

Fig-22 Charge Condition at Discharge (Disconnect V1 and Discharged condition)

$$Q = C_A V_2 + C_C V_2$$

then $C_A V_1 = C_A V_2 + C_C V_2$

$$V_2 = \frac{C_A V_1}{C_A + C_C} \dots\dots\dots (20)$$

Figures 23 through 25 show some test data of special-design capacitors for charge and discharge application, compared with general-purpose capacitors.

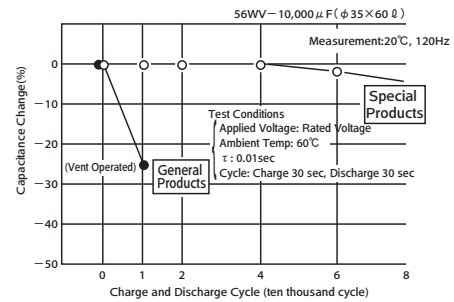

Fig-23 Rapid charge and discharge characteristics (Effects of Frequency)

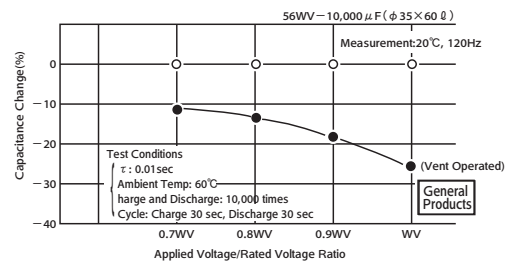

Fig-24 Rapid charge and discharge characteristics (Effects of Applied Voltage)

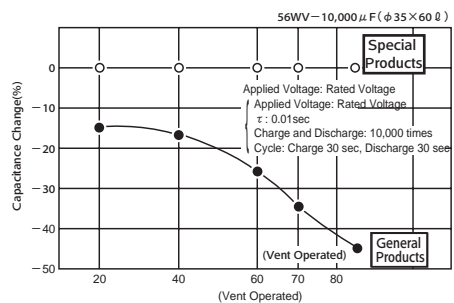

Fig-25 Rapid charge and discharge characteristics (Effects of Ambient Temperature)

5-5 Inrush Current

For the power supply inrush current that can occur on the start-up of a power supply or on the charge of a welding machine lasts only milliseconds, but its magnitude may reach 10 to 1,000 times more than the normal current. Usually, a single, non-repeated inrush current produces a negligibly small amount of heat, so it does not matter.

However, frequently repeating inrush currents may heat up the element inside a capacitor more than the allowable limit and/or overheat the external terminal connections or the connections between the internal lead and foil electrode.

5-6 Abnormal Voltage Effect on Lifetime

Applying abnormal voltage can increase the internal pressure with heat and gases produced, causing the pressure relief vent to open or the capacitor to have destructive failures.

5-6-1 Overvoltage

Applying a voltage higher than the rated voltage will cause chemical reactions (formation of dielectric) to occur on the anode foil with the leakage current rapidly increasing, which produces heat and gases and thereby increases the internal pressure.

The reactions are accelerated by the voltage, current density and ambient temperature, causing the pressure relief vent to open or the capacitor to have destructive failures. It may also accompany a reduction in capacitance and an increase in $\tan \delta$ as well as an increase in the leakage current, which can lead to internal short-circuiting failure. An example of capacitor overvoltage characteristics is shown in Fig. 26.

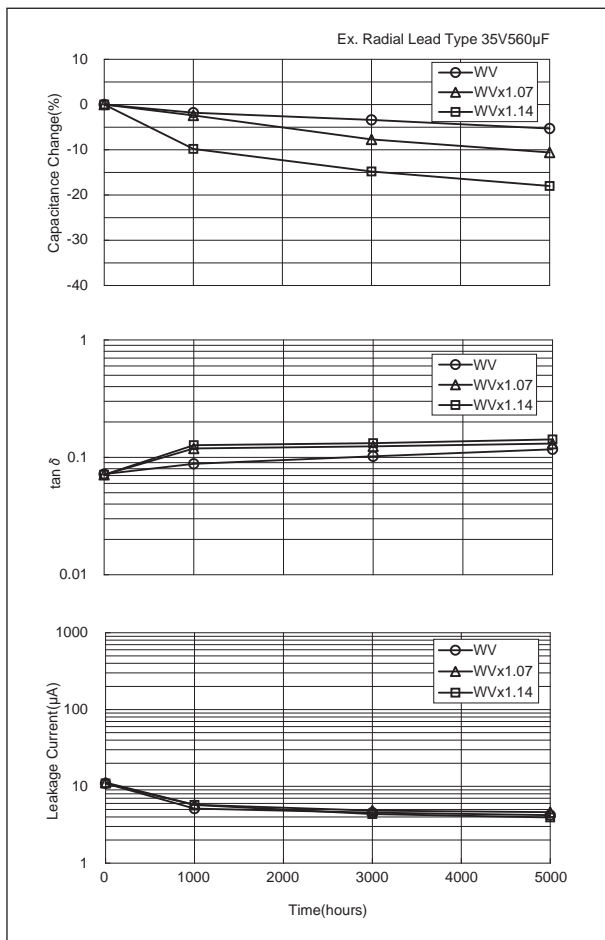

Fig-26 Applied overvoltage characteristic at 105°C

5-6-2 Reverse Voltage

Applying a reverse voltage will cause chemical reactions (formation of dielectric) to occur on the cathode foil, and, as is the case with overvoltage, the leakage current will rapidly increase with heat and gases generating and thus the internal pressure increases.

The reactions are accelerated by the voltage, current density and ambient temperature. It may also accompany a reduction in capacitance and an increase in $\tan \delta$ as well as an increase in the leakage current. An example of capacitor reverse-voltage characteristics is shown in Fig. 27.

A reverse voltage of as small as 1V can cause the capacitance to decrease. A reverse voltage of 2 to 3V can shorten lifetime due to a reduction in capacitance, increase in $\tan \delta$, and/or increase in leakage current. A reverse voltage of even higher value can open the pressure relief vent or lead to destructive failures (Fig. 27).

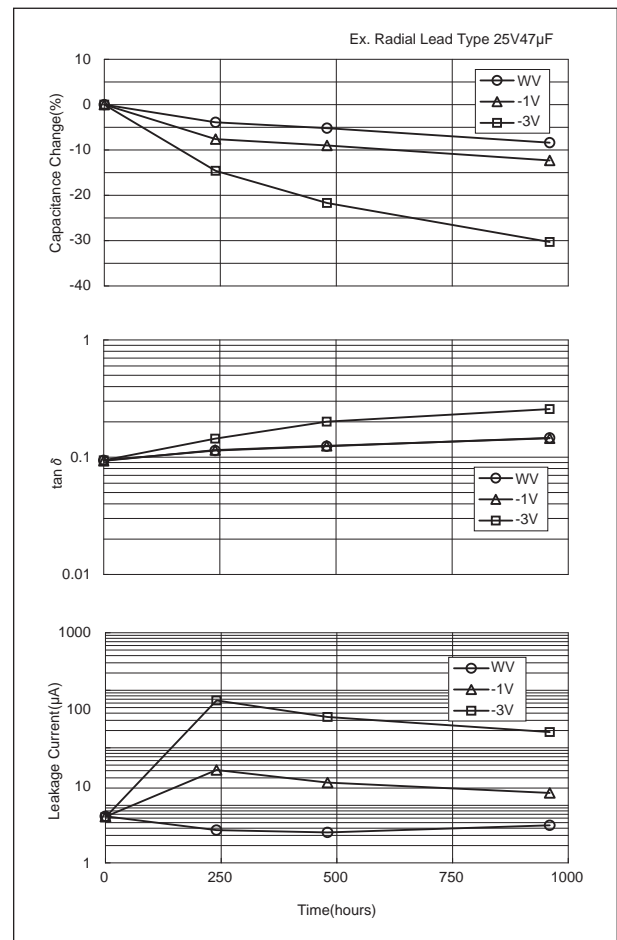

Fig-27 Applied Reverse voltage characteristic at 105°C

5-6-3 Do not Use Aluminum Electrolytic Capacitors in an AC Circuit

Using an aluminum electrolytic capacitor in an AC circuit will result in the same situation as that with a positive potential being applied to the cathode (like a reverse voltage) and with an excessively large ripple current flowing in the capacitor, which may increase the internal pressure due to the generation of heat and gases, open the pressure relief vent, leak the electrolyte with the rubber seal bung expelled or cause the capacitor to blow up or catch fire in the worst case. If the capacitor blows up, it may scatter flammable materials such as electrolyte and element-supporting wax materials, which can lead to short-circuiting of the device. Therefore, do not use aluminum electrolytic capacitors in any of the AC circuits.

6. Effect of Halogens

Aluminum electrolytic capacitors are sensitive to contamination of halogen ions (especially to chlorine and bromine ions) though the degree of the effect depends on the properties of the electrolyte and/or sealing materials used in the capacitors. For using a halide-containing flux, solvent (cleaning agent, adhesive or coating materials) or fumigant, the halide may penetrate into the capacitor through the rubber seal materials and cause the following corrosion reactions to occur. These reactions can lead to an increase in leakage current, opening of the pressure relief vent, and/or open-circuit failure in the capacitor. The reactions are accelerated as the voltage and/or temperature rises.

[Corrosion reactions]

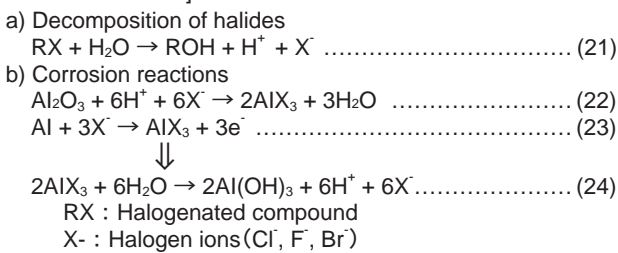

Halides that penetrated the element inside a capacitor make contact with the electrolyte, by which the halides are hydrolyzed and release halogen ions as shown on Reaction (21). The halogen ions then attack aluminum by anodic half-cell reaction, producing AlX₃ (Reaction 22 and 23).

AlX₃ is then hydrolyzed, which is decomposed to aluminum hydroxide and the halogen ions (Reaction (24)). The halogen ions reproduced are repeatedly used and reproduced by the reactions of (22) ~ (24), and then the corrosion develops endlessly.

Shown below are precautions for use of flux, cleaning agents, adhesive, coating materials and fumigant.

6-1 Effect of Flux

Usually flux products contain an activator of ionic halide system, which has been associated with the corrosion issues of capacitors, and nowadays non-ionic halide system type flux products have been increasingly available on the market. Some of the latter flux type have been classified into the so called "non-halogen flux" or "halogen-free flux", and parts of the "non-halogen" or "halogen-free" flux products may contain a large amount of non-ionic halides, which can also adversely affect the capacitors.

6-2 Cleaning Agents

Where cleaning the solvent resistance type of aluminum electrolytic capacitors, confirm the following conditions:

- a. Control the contamination (the conductivity, pH, specific gravity, water content, etc.) of the cleaning agents.
- b. After the cleaning, do not leave the capacitors (assembly boards) in an environment of cleaning agent-rich or in a closed container. Sufficiently evaporate the residual cleaning agent from the assembly boards and the capacitors by forced hot air at temperatures less than the upper limit of category temperature range for more than 10 minutes.

In general, aluminum electrolytic capacitors are sensitive to contamination of halogen ions (particularly to chlorine ions). Depending on the properties of the electrolyte and rubber seal materials used in a capacitor, the halogen ions lead up to catastrophic failures on the capacitor. Where the inside of a capacitor has been contaminated with more than a certain amount of halogen ions and the capacitor is in use, the corrosion reaction of aluminum occurs. The corrosion causes the capacitor to have a significant increase in leakage cur-

rent with heat produced, open the pressure relief vent and become open circuit mode failure.

Due to global environmental issues (greenhouse effects and other environmental destruction by depletion of the ozone layer), the conventional cleaning solvents of CFC 113, Trichloroethylene and 1,1,1-trichloroethylene were replaced by substitutes.

6-2-1 Alcohol Cleaning Agents

- ① Fatty-alcohol cleaning agents (New type of solvent)
 Pine Alpha ST-100S (Arakawa Chemical)
 Clean Through 750H, 750HS and 750J (Kao)
- ② IPA (Isopropyl alcohol)

[Compatible capacitor products]

Terminal Shape	Subject Series
Surface Mount Type	All Series
Radial Lead Type	All Series
Snap-in Type	All Series (Less and equal 100V _{dc})

[Cleaning conditions]

Either of Immersion or ultrasonic cleaning, for a maximum of 10 minutes at a maximum liquid temperature of 60°C.

[Precautions]

- a. Make sure that the markings on a capacitor are not rubbed against any other component or the PC board during cleaning. Note that shower cleaning can cause the markings on the capacitor to be washed off.
- b. Depending on the cleaning method, the markings may be erased or blur.
- c. A drying process following a water cleaning or rinsing process may cause the outer sleeve materials of a capacitor to swell or shrink.
- d. After using a weak-alkaline cleaning agent (e.g. Clean Through 750HS, 750J), rinse with water to make sure that no alkaline residue is left on the capacitor.
- e. Control a flux concentration in a cleaning agent within 2 wt%.
- f. IPS (Isopropyl Alcohol), if containing xylene or other solvent to improve its cleanability, may swell the rubber seal materials.
- g. Depending on the type of cleaning agent or conditions, note that the outer sleeve of a capacitor may lose a gloss or whiten in appearance.

6-2-2 HCFC (Freon-225), as Alternative CFCs AK225AES (Asahi Glass)

[Cleaning conditions]

Solvent resistant type capacitors, which were originally developed to intend to resist Freon TE or Freon TES, are also capable of withstanding either of immersion or ultrasonic cleaning, for a maximum of 5 minutes (or 2 minutes for KRE series or 3 minutes for SRM series). However, in view of global environmental issues, HCFCs has not been recommended.

[Compatible capacitor products]

Terminal Shape	Subject Series
Surface Mount Type	MVE (~63V _{dc}), MZS, MZL, MZR, MZJ, MZA, MVY (6.3 ~ 63V _{dc}), MZF, MZE, MZK, MLA, MLF, MLE, MLK, MVL, MVJ, MHS, MVH (~50V _{dc}), MHL, MHB, MHJ, MXB, MHK
Radial Lead Type	SRG, KRG, KMQ (~100V _{dc}), LZA, LXZ, LXY, LXV, LE, GPA, GVA, GXF, GXL, GPD, GVD, GQB, LBV, LBG

When a capacitor is mounted closely flush on the PC board, a residual cleaning agent may be left in the gap between the body of the capacitor and PC board surface. Dry out the residue with a forced hot air of 50 to 85°C for 10 minutes or more.

6-2-3 Other Solvents

To avoid capacitor failures, do not use the following cleaning agents:

- Halogenated system: causes capacitor failures due to corrosion.
- Alkali system: corrodes (dissolves) the aluminum can case.
- Terpene and petroleum system: deteriorates the rubber seal materials.
- Xylene and toluene: deteriorates the rubber seal materials as well.
- Acetone: erases the markings printed on a capacitor.

6-3 Adhesive and Coating Materials

To use adhesives and/or coating materials for aluminum electrolytic capacitors, make sure of the following conditions:

- Do not use any of adhesive or coating materials containing halogenated solvents.
- No flux residue nor stain is left between the rubber seal of a capacitor and PC board.
- Dry the capacitor to remove residual cleaning agents before applying adhesive and coating materials. Do not cover up the entire surface of the rubber seal of the capacitor with adhesive and coating materials.
- Improper heating and/or curing conditions for adhesives and coating materials may cause the sleeve to swell or shrink. Please consult us for proper conditions.
- For a non-solid aluminum electrolytic capacitor, covering up

the entire surface of the rubber seal with resin mold materials will obstruct the normal diffusion of internal hydrogen gas from the capacitor and result in serious failures. Also, where the adhesive and coating materials contain a large amount of halogen ions, the halogen ions will contaminate the inside of the capacitor through the rubber seal materials, which cause the capacitor to become a failure.

- The outer sleeve of a capacitor may lose a gloss or whiten in appearance depending on solvent materials that the adhesive or coating materials contains.
- Some adhesives or coating materials contain organic solvent such as Xylene. Xylene can deteriorate the rubber seal materials, which cause the flux ingredients to penetrate into the capacitor.

6-4 Effect of Fumigation

In exporting or importing electronic devices, they may be exposed to fumigation with halide such as methyl bromide. Where aluminum electrolytic capacitors exposed to halide such as methyl bromide, the capacitors will be damaged with the corrosion reaction with the halogen ions.

For the export and import, Nippon Chemi-Con considers using some packaging method and so forth that the fumigation is not required to. For customers to export or import electronic devices, semi-assembly products or capacitor components, confirm if they will be exposed to fumigation and also consider final condition of packaging. (Note that either cardboard or vinyl package has a risk of fumigation gas penetration.)

7. Recovery Voltage

Where a capacitor is once charged and discharged with both of the terminals short-circuiting and then left the terminals open for a while, a voltage across the capacitor spontaneously increases again. This is called "recovery voltage phenomenon". The mechanism for this phenomenon can be interpreted as follows:

When charged with a voltage, the dielectric produces some electrical changes within, and then the inside of the dielectric is electrified with the opposite polarities (dielectric polarization). The dielectric polarization occurs in both ways of proceeding rapidly and slowly. When a charged capacitor was discharged until the voltage across the capacitor disappears, and then being left the terminals open, the slow polarization will discharge within the capacitor and appear as recovery voltage. (Fig. 28).

The recovery voltage changes with time as shown in Fig. 29. Its peak will appear 10 to 20 days after the terminals are opened, with gradual weakening thereafter. Larger sized capacitors (screw terminal type and snap-in type) may produce larger recovery voltage.

With a recovery voltage residing in a capacitor, carelessly short-circuiting the terminals can cause sparks to occur, which may scare workers and/or damage low-voltage operating components such as CPU's and memories in the device circuit. To avoid this trouble, discharge the capacitor through 100 - 1kΩ resistors before use. Also, Nippon Chemi-Con may provide some solutions with some packaging method for it. Please consult us.

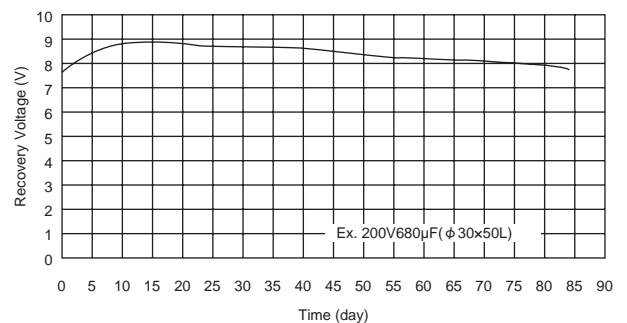
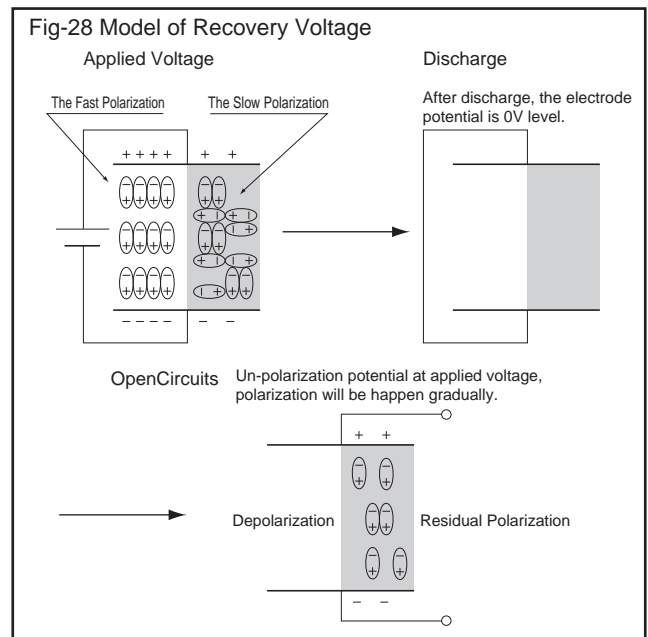

Fig-29 Change of Recovery Voltage

8. Storage

Some characteristics of an aluminum electrolytic capacitor are temperature-dependent. The higher the temperature is, the more deteriorated the capacitor will be. An increase in temperature accelerates the increase in leakage current and $\tan\delta$ and the decrease in capacitance. Leaving a capacitor exposed to high humidity for long hours may lead to discoloration of the lead wires and terminals, and poor solderability. To store aluminum electrolytic capacitors, keep them at normal temperature and humidity without exposure to direct sunlight.

Leaving them exposed to high temperatures (higher than the normal ambient temperature) for long periods of time may lead to chemical reactions between the anode oxide layer and electrolyte, which drop the withstanding voltage and increase leakage current. If this is the case, applying the rated voltage to the capacitor will lead to dielectric breakdown due to the heat produced with the large leakage current, which finally causes the pressure relief vent to open.

Capacitors that have been stored for long periods of time should be subjected to a voltage treatment process (see Note 1) which will reform the dielectric (Al_2O_3) by electrolyte and return the leakage current to the initial level. Leakage current increase during storage will vary with the withstanding voltage of a capacitor. In general, the higher the rated voltage, the larger increased the leakage current tends to be. Also, since storing for long period of time may shorten the lifetime of the capacitors, consider storage conditions according to the requirements of device life expectancy.

(Note 1) In the voltage treatment process, connecting resistor (around $1k\Omega$) in series with the capacitor, applied the rated voltage and then be kept the rated voltage for 30 to 60 minutes.

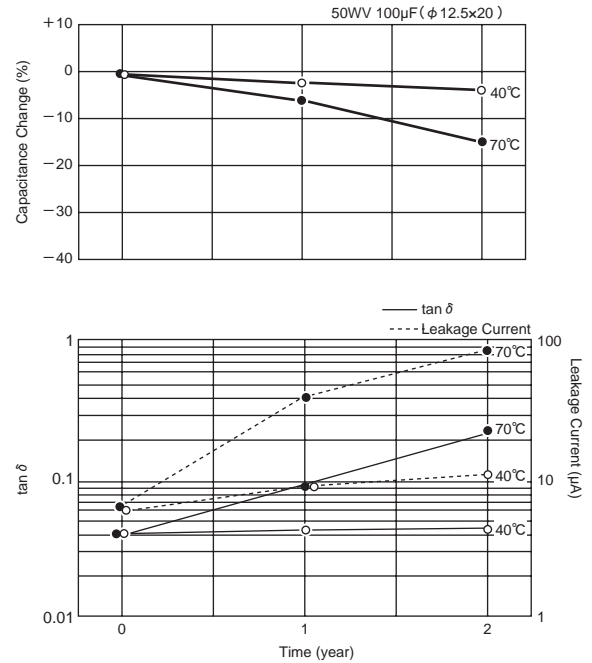

Fig-30 Temperature Characteristics of Storage



9. Tips for Selecting Capacitors Appropriate for Individual Applications

Aluminum electrolytic capacitors are used mainly for the filtering application of power supplies. Select appropriate capacitors for the specific requirements of each application, referring to the following examples for typical applications:

9-1 Input Filtering Capacitors for Switching Mode Power Supplies

An input filtering capacitor functions to smooth 50-120 Hz waveforms that come from a rectifying circuit, the waveforms of which are superimposed with the ripples with the switching frequency from the switching stage where the capacitor supplies the electric power. Therefore, the capacitor must be capable of managing both ripple currents with each frequency. The ESR of a capacitor is frequency-dependent, so that a ripple current of different frequency produces a different thermal energy in the capacitor.

For PFC power supplies or lighting ballasts, capacitors are subjected to ripple current whose frequency is several dozens of kHz to 100kHz. Therefore, to select capacitors, take their impedance characteristics into consideration.

● Representative output filtering capacitors for SMPS

Characteristics	85°C		105°C		
	Standard	Longer Life	Standard	Compact	Longer Life
Radial Lead	—	—	KMQ	PAG	KXJ
Snap-in	SMQ	SMM	KMQ	KMS, KMR	LXS, LXM

9-2 Output Filtering Capacitors for Switching Mode Power Supplies

In the output filtering, a capacitor must be capable of managing a ripple current with the frequency as high as around 100 kHz. Therefore, Nippon Chemi-Con provides excellent product line-ups with low impedance characteristic at high frequencies, including high temperature and long-life versions, which can be chosen according to the application purpose.

The 125°C maximum temperature series capacitors have a shorter lifetime than the "Long Life" series of 105°C max. temperature though the electrical characteristics are highly stable. The "wide temperature range" series has two subseries that differ by the applicable temperature range: -55 to 105°C and -40 to 125°C. The "Long Life" series capacitors have been designed for specializing lower impedance and also longer lifetime. Compared to the "wide temperature range" series, the Long Life series can serve longer with the lower impedance, though the maximum operating temperature is limited to 105°C and the electrical characteristics are large in change over the temperature range.

● Representative output filtering capacitors for SMPS

Characteristics	105°C		125°C
	Standard	Low Z	High Temp
Wide Temp Range	LXY	LZA	GPA
Longer Life	KYB	KZN	—

9-3 Filtering Capacitors for Inverter Main Circuits

These capacitors are used in a similar way to those for the input of the switching mode power supplies. Additionally, please understand the following precautions:

For the filtering circuit for 400Vac line, two capacitors of each a rated voltage 350 to 400Vdc can be used with being connected in series. In the series connection, voltages across the individual capacitors during charging depend on their individual capacitance values. After completion of the charging, the voltages come to depend on their leakage current values as the voltage distribution to the individual capacitors inversely corresponds to their leakage current values. For the voltage not to exceed the rated value after the charging is completed, balancing resistors should be connected in parallel with each capacitor. For guidance on choosing balancing resistors, please consult us.

Where capacitors connected in series are frequently charged and discharged, individual charging voltages depend on the variations in their capacitance values. Therefore, keeping the voltage balance will be difficult even if balancing resistors are employed. For servo amplifiers and other application where the voltage fluctuates frequently due to regeneration, use capacitor families that have been especially designed for intensive charge and discharge operations, or consult us for individual designs.

● Representative filtering capacitors for inverter main circuits

Characteristics	85°C		105°C	
	Standard	Longer Life	Standard	Longer Life
Snap-in	SMQ	SMM	KMQ	LXS, LXM
Screw Mount	RWE	RWF, RWH	KMH	LXA, LXR

● Representative capacitors for servo amplifiers

Characteristics	85°C	105°C
	Standard	High Temp
Snap-in	—	KMV
Screw Mount	RWV	—

Appendix

Appendix (Part number)

◆ Capacitance code

* How to use the table

	1st
2nd	Cap. Value

Capacitance value part

2nd	1st								
	1	2	3	4	5	6	7	8	9
0	10.0	20.0	30.0	40.0	50.0	60.0	70.0	80.0	90.0
A	10.5	20.5	30.5	40.5	50.5	60.5	70.5	80.5	90.5
1	11.0	21.0	31.0	41.0	51.0	61.0	71.0	81.0	91.0
B	11.5	21.5	31.5	41.5	51.5	61.5	71.5	81.5	91.5
2	12.0	22.0	32.0	42.0	52.0	62.0	72.0	82.0	92.0
C	12.5	22.5	32.5	42.5	52.5	62.5	72.5	82.5	92.5
3	13.0	23.0	33.0	43.0	53.0	63.0	73.0	83.0	93.0
D	13.5	23.5	33.5	43.5	53.5	63.5	73.5	83.5	93.5
4	14.0	24.0	34.0	44.0	54.0	64.0	74.0	84.0	94.0
E	14.5	24.5	34.5	44.5	54.5	64.5	74.5	84.5	94.5
5	15.0	25.0	35.0	45.0	55.0	65.0	75.0	85.0	95.0
F	15.5	25.5	35.5	45.5	55.5	65.5	75.5	85.5	95.5
6	16.0	26.0	36.0	46.0	56.0	66.0	76.0	86.0	96.0
G	16.5	26.5	36.5	46.5	56.5	66.5	76.5	86.5	96.5
7	17.0	27.0	37.0	47.0	57.0	67.0	77.0	87.0	97.0
H	17.5	27.5	37.5	47.5	57.5	67.5	77.5	87.5	97.5
8	18.0	28.0	38.0	48.0	58.0	68.0	78.0	88.0	98.0
J	18.5	28.5	38.5	48.5	58.5	68.5	78.5	88.5	98.5
9	19.0	29.0	39.0	49.0	59.0	69.0	79.0	89.0	99.0
K	19.5	29.5	39.5	49.5	59.5	69.5	79.5	89.5	99.5



For less than 10μF, a decimal point position is displayed with R.

For 10μF or more, capacitance code is set to the first 2 digits and index (1 digit).

Treatment of fraction (Refer to the table)

Example of conversion

Real cap.	The first 2 digits	Treatment of fraction	Code		
			11th	12th	13th
10.0μF →	10.0 →	10.0 →	1	0	0
10.1μF →	10.1 →	10.0 →	1	0	0
10.2μF →	10.2 →	10.0 →	1	0	0
10.3μF →	10.3 →	10.5 →	1	A	0
10.4μF →	10.4 →	10.5 →	1	A	0
10.5μF →	10.5 →	10.5 →	1	A	0
10.6μF →	10.6 →	10.5 →	1	A	0
10.7μF →	10.7 →	10.5 →	1	A	0
10.8μF →	10.8 →	11.0 →	1	1	0
10.9μF →	10.9 →	11.0 →	1	1	0
11.0μF →	11.0 →	11.0 →	1	1	0
132μF →	13.2 →	13.0 →	1	3	1
133μF →	13.3 →	13.5 →	1	D	1
167μF →	16.7 →	16.5 →	1	G	1
168μF →	16.8 →	17.0 →	1	7	1
1110μF →	11.1 →	11.0 →	1	1	2
1340μF →	13.4 →	13.5 →	1	D	2
13200μF →	13.2 →	13.0 →	1	3	3
13600μF →	13.6 →	13.5 →	1	D	3
270000μF →	27.0 →	27.0 →	2	7	4

◆ Case length (Radial lead type)

Case length [mm]	16th	17th	Case length [mm]	16th	17th	Case length [mm]	16th	17th	Case length [mm]	16th	17th	Case length [mm]	16th	17th	Case length [mm]	16th	17th
0.0	—	—	1.0	0	1	2.0	0	2	3.0	0	3	4.0	0	4			
0.1	0	B	1.1	1	B	2.1	2	B	3.1	3	B	4.1	4	B			
0.2	0	C	1.2	1	C	2.2	2	C	3.2	3	C	4.2	4	C			
0.3	0	D	1.3	1	D	2.3	2	D	3.3	3	D	4.3	4	D			
0.4	0	E	1.4	1	E	2.4	2	E	3.4	3	E	4.4	4	E			
0.5	0	F	1.5	1	F	2.5	2	F	3.5	3	F	4.5	4	F			
0.6	0	G	1.6	1	G	2.6	2	G	3.6	3	G	4.6	4	G			
0.7	0	H	1.7	1	H	2.7	2	H	3.7	3	H	4.7	4	H			
0.8	0	J	1.8	1	J	2.8	2	J	3.8	3	J	4.8	4	J			
0.9	0	K	1.9	1	K	2.9	2	K	3.9	3	K	4.9	4	K			
5.0	0	5	6.0	0	6	7.0	0	7	8.0	0	8	9.0	0	9			
5.1	5	B	6.1	6	B	7.1	7	B	8.1	8	B	9.1	9	B			
5.2	5	C	6.2	6	C	7.2	7	C	8.2	8	C	9.2	9	C			
5.3	5	D	6.3	6	D	7.3	7	D	8.3	8	D	9.3	9	D			
5.4	5	E	6.4	6	E	7.4	7	E	8.4	8	E	9.4	9	E			
5.5	5	F	6.5	6	F	7.5	7	F	8.5	8	F	9.5	9	F			
5.6	5	G	6.6	6	G	7.6	7	G	8.6	8	G	9.6	9	G			
5.7	5	H	6.7	6	H	7.7	7	H	8.7	8	H	9.7	9	H			
5.8	5	J	6.8	6	J	7.8	7	J	8.8	8	J	9.8	9	J			
5.9	5	K	6.9	6	K	7.9	7	K	8.9	8	K	9.9	9	K			
10.0	1	0	11.0	1	1	12.0	1	2	13.0	1	3	14.0	1	4			
10.1	A	1	11.1	B	1	12.1	C	1	13.1	D	1	14.1	E	1			
10.2	A	2	11.2	B	2	12.2	C	2	13.2	D	2	14.2	E	2			
10.3	A	3	11.3	B	3	12.3	C	3	13.3	D	3	14.3	E	3			
10.4	A	4	11.4	B	4	12.4	C	4	13.4	D	4	14.4	E	4			
10.5	A	5	11.5	B	5	12.5	C	5	13.5	D	5	14.5	E	5			
10.6	A	6	11.6	B	6	12.6	C	6	13.6	D	6	14.6	E	6			
10.7	A	7	11.7	B	7	12.7	C	7	13.7	D	7	14.7	E	7			
10.8	A	8	11.8	B	8	12.8	C	8	13.8	D	8	14.8	E	8			
10.9	A	9	11.9	B	9	12.9	C	9	13.9	D	9	14.9	E	9			

CHEMI-CON PART NUMBERING SYSTEM

Case length [mm]	16th	17th
15.0	1	5
15.1	F	1
15.2	F	2
15.3	F	3
15.4	F	4
15.5	F	5
15.6	F	6
15.7	F	7
15.8	F	8
15.9	F	9

Case length [mm]	16th	17th
16.0	1	6
16.1	G	1
16.2	G	2
16.3	G	3
16.4	G	4
16.5	G	5
16.6	G	6
16.7	G	7
16.8	G	8
16.9	G	9

Case length [mm]	16th	17th
17.0	1	7
17.1	H	1
17.2	H	2
17.3	H	3
17.4	H	4
17.5	H	5
17.6	H	6
17.7	H	7
17.8	H	8
17.9	H	9

Case length [mm]	16th	17th
18.0	1	8
18.1	J	1
18.2	J	2
18.3	J	3
18.4	J	4
18.5	J	5
18.6	J	6
18.7	J	7
18.8	J	8
18.9	J	9

Case length [mm]	16th	17th
19.0	1	9
19.1	K	1
19.2	K	2
19.3	K	3
19.4	K	4
19.5	K	5
19.6	K	6
19.7	K	7
19.8	K	8
19.9	K	9

Case length [mm]	16th	17th
20.0	2	0
20.5	L	1
21.0	2	1
21.5	L	3
22.0	2	2
22.5	L	5
23.0	2	3
23.5	L	7
24.0	2	4
24.5	L	9
25.0	2	5
25.5	M	1
26.0	2	6
26.5	M	3
27.0	2	7
27.5	M	5
28.0	2	8
28.5	M	7
29.0	2	9
29.5	M	9

Case length [mm]	16th	17th
30.0	3	0
30.5	N	1
31.0	3	1
31.5	N	3
32.0	3	2
32.5	N	5
33.0	3	3
33.5	N	7
34.0	3	4
34.5	N	9
35.0	3	5
35.5	P	1
36.0	3	6
36.5	P	3
37.0	3	7
37.5	P	5
38.0	3	8
38.5	P	7
39.0	3	9
39.5	P	9

Case length [mm]	16th	17th
40.0	4	0
40.5	Q	1
41.0	4	1
41.5	Q	3
42.0	4	2
42.5	Q	5
43.0	4	3
43.5	Q	7
44.0	4	4
44.5	Q	9
45.0	4	5
45.5	R	1
46.0	4	6
46.5	R	3
47.0	4	7
47.5	R	5
48.0	4	8
48.5	R	7
49.0	4	9
49.5	R	9

Case length [mm]	16th	17th
50.0	5	0
50.5	S	1
51.0	5	1
51.5	S	3
52.0	5	2
52.5	S	5
53.0	5	3
53.5	S	7
54.0	5	4
54.5	S	9
55.0	5	5
55.5	T	1
56.0	5	6
56.5	T	3
57.0	5	7
57.5	T	5
58.0	5	8
58.5	T	7
59.0	5	9
59.5	T	9

Case length [mm]	16th	17th
60.0	6	0
60.5	U	1
61.0	6	1
61.5	U	3
62.0	6	2
62.5	U	5
63.0	6	3
63.5	U	7
64.0	6	4
64.5	U	9
65.0	6	5
65.5	V	1
66.0	6	6
66.5	V	3
67.0	6	7
67.5	V	5
68.0	6	8
68.5	V	7
69.0	6	9
69.5	V	9

Case length [mm]	16th	17th
70.0	7	0
70.5	W	1
71.0	7	1
71.5	W	3
72.0	7	2
72.5	W	5
73.0	7	3
73.5	W	7
74.0	7	4
74.5	W	9
75.0	7	5
75.5	X	1
76.0	7	6
76.5	X	3
77.0	7	7
77.5	X	5
78.0	7	8
78.5	X	7
79.0	7	9
79.5	X	9

Case length [mm]	16th	17th
80.0	8	0
80.5	Y	1
81.0	8	1
81.5	Y	3
82.0	8	2
82.5	Y	5
83.0	8	3
83.5	Y	7
84.0	8	4
84.5	Y	9
85.0	8	5
85.5	Z	1
86.0	8	6
86.5	Z	3
87.0	8	7
87.5	Z	5
88.0	8	8
88.5	Z	7
89.0	8	9
89.5	Z	9

◆ **Case length (Snap-in type / Screw mount terminal type)**

Case length [mm]	16th	17th
20	2	0
21	2	1
22	2	2
23	2	3
24	2	4
25	2	5
26	2	6
27	2	7
28	2	8
29	2	9

Case length [mm]	16th	17th
30	3	0
31	3	1
32	3	2
33	3	3
34	3	4
35	3	5
36	3	6
37	3	7
38	3	8
39	3	9

Case length [mm]	16th	17th
40	4	0
41	4	1
42	4	2
43	4	3
44	4	4
45	4	5
46	4	6
47	4	7
48	4	8
49	4	9

Case length [mm]	16th	17th
50	5	0
51	5	1
52	5	2
53	5	3
54	5	4
55	5	5
56	5	6
57	5	7
58	5	8
59	5	9

Case length [mm]	16th	17th
60	6	0
61	6	1
62	6	2
63	6	3
64	6	4
65	6	5
66	6	6
67	6	7
68	6	8
69	6	9

Case length [mm]	16th	17th
70	7	0
71	7	1
72	7	2
73	7	3
74	7	4
75	7	5
76	7	6
77	7	7
78	7	8
79	7	9

Case length [mm]	16th	17th
80	8	0
81	8	1
82	8	2
83	8	3
84	8	4
85	8	5
86	8	6
87	8	7
88	8	8
89	8	9

Case length [mm]	16th	17th
90	9	0
91	9	1
92	9	2
93	9	3
94	9	4
95	9	5
96	9	6
97	9	7
98	9	8
99	9	9

Case length [mm]	16th	17th
100	A	0
101	A	1
102	A	2
103	A	3
104	A	4
105	A	5
106	A	6
107	A	7
108	A	8
109	A	9

Case length [mm]	16th	17th
110	B	0
111	B	1
112	B	2
113	B	3
114	B	4
115	B	5
116	B	6
117	B	7
118	B	8
119	B	9

Case length [mm]	16th	17th
120	C	0
121	C	1
122	C	2
123	C	3
124	C	4
125	C	5
126	C	6
127	C	7
128	C	8
129	C	9

Case length [mm]	16th	17th
130	D	0
131	D	1
132	D	2
133	D	3
134	D	4
135	D	5
136	D	6
137	D	7
138	D	8
139	D	9

Case length [mm]	16th	17th
140	E	0
141	E	1
142	E	2
143	E	3
144	E	4
145	E	5
146	E	6
147	E	7
148	E	8
149	E	9

Case length [mm]	16th	17th
150	F	0
151	F	1
152	F	2
153	F	3
154	F	4
155	F	5
156	F	6
157	F	7
158	F	8
159	F	9

Case length [mm]	16th	17th
160	G	0
161	G	1
162	G	2
163	G	3
164	G	4
165	G	5
166	G	6
167	G	7
168	G	8
169	G	9

Case length [mm]	16th	17th
170	H	0
171	H	1
172	H	2
173	H	3
174	H	4
175	H	5
176	H	6
177	H	7
178	H	8
179	H	9

Case length [mm]	16th	17th
180	J	0
181	J	1
182	J	2
183	J	3
184	J	4
185	J	5
186	J	6
187	J	7
188	J	8
189	J	9

Case length [mm]	16th	17th
190	K	0
191	K	1
192	K	2
193	K	3
194	K	4
195	K	5
196	K	6
197	K	7
198	K	8
199	K	9

Case length [mm]	16th	17th
200	L	0
201	L	1
202	L	2
203	L	3
204	L	4
205	L	5
206	L	6
207	L	7
208	L	8
209	L	9

Case length [mm]	16th	17th
210	M	0
211	M	1
212	M	2
213	M	3
214	M	4
215	M	5
216	M	6
217	M	7
218	M	8
219	M	9

Case length [mm]	16th	17th
220	N	0
221	N	1
222	N	2
223	N	3
224	N	4
225	N	5
226	N	6
227	N	7
228	N	8
229	N	9

Case length [mm]	16th	17th
230	P	0
231	P	1
232	P	2
233	P	3
234	P	4
235	P	5
236	P	6
237	P	7
238	P	8
239	P	9

Case length [mm]	16th	17th
240	Q	0
241	Q	1
242	Q	2
243	Q	3
244	Q	4
245	Q	5
246	Q	6
247	Q	7
248	Q	8
249	Q	9

Case length [mm]	16th	17th
250	R	0
251	R	1
252	R	2
253	R	3
254	R	4
255	R	5
256	R	6
257	R	7
258	R	8
259	R	9

◆ **Supplement code**

Conductive Polymer Aluminum Solid Capacitors (Chip and Radial lead type)

Conductive Polymer Hybrid Aluminum Electrolytic Capacitors (Chip and Radial lead type)

Aluminum Electrolytic Capacitors (Chip type)

	Terminal plating material	
	Sn	Sn-Bi
Coating case	S	G

Aluminum Electrolytic Capacitors (Radial lead and Snap-in type)

		Terminal plating material	
		Sn	Sn-Bi
Outer sleeve	PET	S	D
	Coating case	H	G
	Polyolefin	L	-
	PVC	M	-

* Standard design of "environmental friendly" snap-in are not equipped with a plastic disk on the top of the can case. We also produce snap-in type with "Plastic disk, PVC sleeve and Sn terminal plating".

Aluminum Electrolytic Capacitors (Screw mount terminal type)

Outer sleeve	Supplement code
PVC	U
Polyolefin	S
PET	C

* For the screw-mount type, the standard design has a plastic disk on the bottom side.

ELECTRONIC COMPONENTS & DEVICES

PRODUCTS

	CAT.No.
Aluminum Electrolytic Capacitors	1001
Multilayer Ceramic Capacitors	1002
Film Capacitors	1003
Metal Oxide Varistors TNR™	1006
Nanocrystalline / Amorphous / Dust Choke Coils	1008
Electric Double Layer Capacitors	1009
Camera Modules	

Notes on Safety



- Always read "Notes on Use" before using the product in order to enable you to use the product correctly and prevent any faults and accidents from occurring.
- Request the Product Specification on the product of NIPPON CHEMI-CON CORPORATION to refer to it as well as this brochure prior to the order of the products. Some specific notes on use of the ordered product may be described in the specifications.
- The products listed in this catalog are designed and manufactured for general electronics equipment use and are not intended for use in applications that can adversely affect human life; where the malfunction of equipment may cause damage to life or property. In addition, our products are not intended to be used in specific applications that may cause a major social impact. Please consult with us in advance of usage of our products in the following listed applications. ① Aerospace equipment ② Power generation equipment such as thermal power, nuclear power etc. ③ Medical equipment ④ Transport equipment (automobiles, trains, ships, etc.) ⑤ Transportation control equipment ⑥ Disaster prevention/crime prevention equipment ⑦ Highly publicized information processing equipment ⑧ Submarine equipment ⑨ Other applications that are not considered general-purpose applications.
- The circuits described as examples in this catalog and the "delivery specifications" are featured in order to show the operations and usage of our products, however, this fact does not guarantee that the circuits are available to function in your equipment systems. We are not in any case responsible for any failures or damage caused by the use of information contained herein. You should examine our products, of which the characteristics are described in the "delivery specifications" and other documents, and determine whether or not our products suit your requirements according to the specifications of your equipment systems. Therefore, you bear final responsibility regarding the use of our products. Please make sure that you take appropriate safety measures such as use of redundant design and malfunction prevention measures in order to prevent fatal accidents and/or fires in the event any of our products malfunction.

Note

- We strongly recommend our customers to purchase Nippon Chemi-Con products only through our official sales channels. We assume no responsibility for any defects or damages caused by using products purchased from outside our official sales channel or of counterfeit goods. In addition, we will ask the customer to pay the investigation cost for products purchased outside our official sales channel.
- We reserve the right to discontinue production and delivery of products. We do not guarantee that all the products included in this catalog will be available in the future.
The aforementioned does not apply in the case of individual agreements deviating from the foregoing for customer-specific products
- We continually strive to improve the quality and reliability of our products, but in any case that our product does not meet our published specifications, please stop using it promptly and contact us immediately. As for compensation for non-conforming goods delivered by Chemi-Con, we will limit it only to goods found in non-compliance of our published specifications. This may be accomplished by a no cost replacement of non-conforming individual products, a credit of the piece price paid per each individual non-conforming product, or in other ways deemed necessary.
In addition, we have an established system with enhanced traceability, therefore we will limit the applicable lot items for any potential compensation.
- The content of this catalog is as of April 2024

NIPPON CHEMI-CON CORPORATION
<https://www.chemi-con.co.jp/en/>



Distributed or Represented by

X-ON Electronics

Largest Supplier of Electrical and Electronic Components

Click to view similar products for [Aluminium Electrolytic Capacitors - SMD category](#):

Click to view products by [Chemi-Con manufacturer](#):

Other Similar products are found below :

[ULV2H4R7MNL1GS](#) [ULV2H1R8MNL1GS](#) [EMZA500ARA221MJA0G](#) [CA025M4R70REB-0405](#) [UCX1V471MNQ1MS](#) [10SVP120M](#)
[DV100M050C055ETR](#) [AEH1012471M016R](#) [GVT1C337M0608CNVC](#) [EMK1EM331FB0D00R](#) [EMF1CM221FB0D00R](#)
[EMF1CM331FB0D00R](#) [EMF1CM471FB0D00R](#) [EMK1JM101GB0D00R](#) [EMK1AM102GB0D00R](#) [EMK1HM221GB0D00R](#)
[DV221M6R3E055ETR](#) [DV221M025E077ETR](#) [RV331M025F105ETR](#) [RVT1A101M0505](#) [GVZ1H101M0607](#) [CK1E100M0405](#)
[GVM1E331M0607](#) [VT100UF16V167RV0124](#) [CK220UF16V167RV0142](#) [VT10UF16V167RV0128](#) [VT22UF35V167RV0131](#)
[CS470UF10V167RV0150](#) [CK100UF16V167RV0138](#) [CK220UF10V167RV0141](#) [RVT330UF25V167RV0055](#) [CS47UF16V167RV0152](#)
[VT470UF16V167RV0135](#) [CS100UF10V167RV0144](#) [126RV0017](#) [VT47UF35V167RV0137](#) [CS220UF35V167RV0148](#) [126RV0010](#)
[126RV0009](#) [VT220UF25V167RV160](#) [VT220UF16V167RV0088](#) [126RV0012](#) [126RV0011](#) [126RV0013](#) [126RV0018](#) [126RV0008](#)
[126RV0015](#) [126RV0021](#) [126RV0006](#) [126RV0020](#)