

客 戶： \_\_\_\_\_ 發行日期： 年 月 日  
(CUSTOMER) \_\_\_\_\_ PUBLISH DATE year month day

# 承 認 書

(APPROVAL SHEET)

名 稱： 水泥電阻器  
(DESCRIPTION) Cement Type Resistors

貴公司料號碼： \_\_\_\_\_  
(CUSTOMER TYPE NO) \_\_\_\_\_

承認 APPROVED BY

千 志 電 子 (深 圳) 有 限 公 司  
CHIAN CHIA ELECTRONIC(SHENZHEN)CO.,LTD

千 志 電 子 科 技 (湖 北) 有 限 公 司  
CHIAN CHIA ELECTRONIC(HU BEI)CO.,LTD

湖北工厂:湖北省孝感市孝南区汉十工业园  
HANSHIINDUSTRY XIAOGANG TOWN SOUTH AREA XIAOGAN CITY HUBEI PROVINCE  
TEL:86-712-2610128 FAX:86-712-2610235  
Http:www.cco-chianchia.com E-mail:ccoserve@cco-chianchia.com

公司名稱 Company Name	千志電子科技(湖北)有限公司 CHIAN CHIA ELECTRONIC(HU BEI)CO.,LTD				
品名 Product Name	水泥電阻器 Cement Type Resistors				
版本 Version	A/0 版	制定日期 Enactment Date	2016 年 05 月 30 日 May 30, 2016	頁數 Page	13-1

## 1. 一般事項 General

### 1.1 適用 Scope

本承認書適用於 千志電子科技(湖北)有限公司 製造之[水泥型電阻器]，符合環境關聯物質要求之 RoHS 測試。

This specification is available for Cement Type Resistors manufactured by CHIAN CHIA ELECTRONIC(HU BEI)CO.,LTD, it accords with RoHS test of Environment related substance requirement.

### 1.2 形名(例) Type designation (example)

依使用種類、額定電力、公稱電阻值、容許誤差而區別,其構造如下。

The type designation shall be in the following form and as specified.

CR-(?)	5W	10K	J
種類 Type	額定電力 Rated power	公稱電阻值 Nominal resistance value	電阻值容許誤差 Resistance tolerance
CR-L	2W	E-12 Series	K    ±10%
CR-M	3W	E-24 Series	J    ±5%
CR-YA	5W		G    ±2%
CR-YB	7W		
CR-YC	10W		
CR-YD	15W		
CR-YD1	20W		
CR-YE	30W		
CR-YG	40W		
CR-V	50W		
	100W		

### 1.3 額定電力 Rated power

額定電力係應在周圍溫度 70°C 可以連續負載的最大電力，如表-1;但周圍溫度如超過 70°C 時之額定電力則依圖一的電力遞減曲線實施。

Rated power is maximum power which can be continuously loaded at specified ambient temperature 70°C, as Table-1; however when the ambient temperature exceeds 70°C, rated power should be determined from the derating curve of Fig.1.

公司名稱 Company Name	千志電子科技(湖北)有限公司 CHIAN CHIA ELECTRONIC(HU BEI)CO.,LTD				
品名 Product Name	水泥電阻器 Cement Type Resistors				
版本 Version	A/0 版	制定日期 Enactment Date	2016 年 05 月 30 日 May 30, 2016	頁數 Page	13-2

表-1 Table-1

定格電力 Rated power	最高使用電壓 Maximum working voltage	最高過負荷電壓 Maximum overload voltage	介質耐電壓 Dielectric withstanding voltage	最高斷續過負荷電壓 Max Intermittence Overload Voltage
1W	350V	700V	1000V	1500V
2W	350V	700V	1000V	1500V
3W	500V	1000V	1000V	1500V
5W	750V	1500V	1000V	1500V
7W	1000V	1500V	1000V	1500V
10W	1000V	1500V	1000V	1500V
15W	1000V	1500V	1000V	1500V
20W	1000V	1500V	1000V	1500V
30W	1000V	1500V	1000V	1500V
40W	1000V	1500V	1000V	1500V
50W	1000V	1500V	1000V	1500V
100W	1000V	1500V	1000V	1500V

圖一 電力遞減曲線 Figure 1 Power derating curve  
線繞型水泥電阻 Wire Wound Cement Type

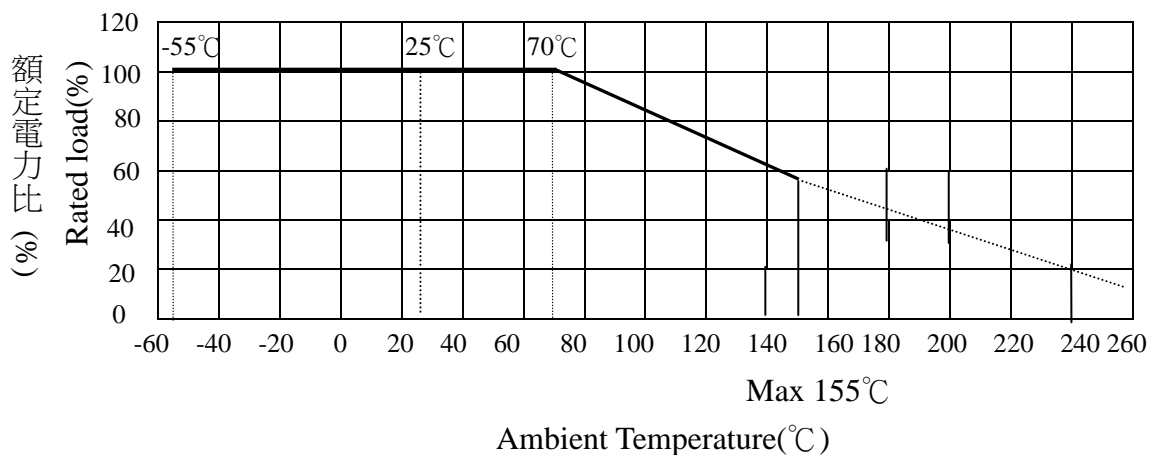

周圍溫度°C  
(定格周圍溫度: 1W~10W 70°C  
15W 以上 25°C)  
(Rated ambient temperature: 1W~10W 70°C  
15W or more 25°C)

公司名稱 Company Name	千志電子科技(湖北)有限公司 CHIAN CHIA ELECTRONIC(HU BEI)CO.,LTD				
品名 Product Name	水泥電阻器 Cement Type Resistors				
版本 Version	A/0 版	制定日期 Enactment Date	2016 年 05 月 30 日 May 30, 2016	頁數 Page	13-3

金屬氧化皮膜水泥電阻      Metal Oxide Film Cement Type

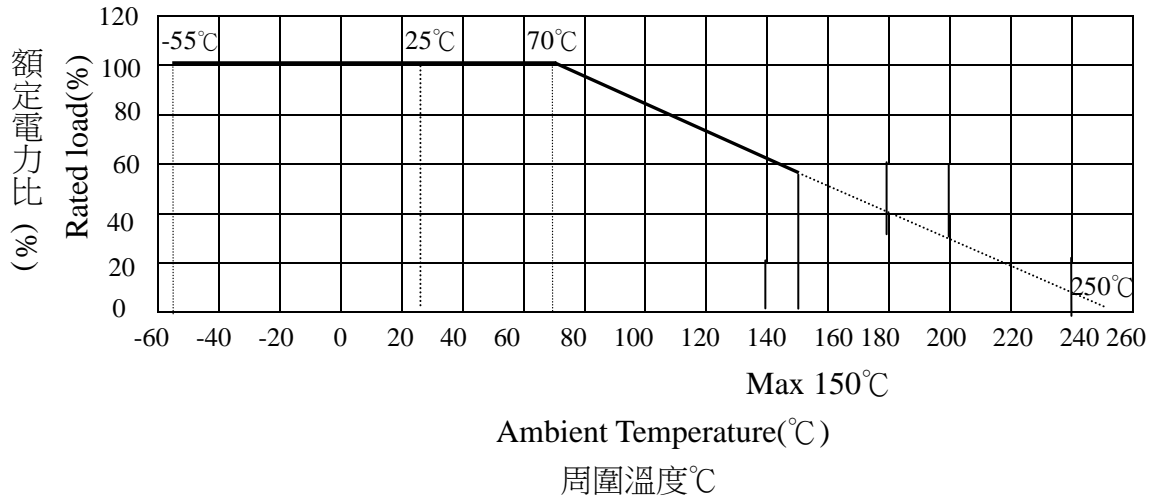

(定格周圍溫度:            1W~10W            70°C  
   15W 以上            25°C)  
(Rated ambient temperature: 1W~10W            70°C  
   15W or more            25°C)

1.4 額定電壓 Rated voltage

額定電壓係指對應於額定電力的直流或交流(商用頻率之有效值)的電壓,由下式求得。

The rated voltage shall be the D.C. or A.C.(R.M.S. at power frequency) voltage which corresponds the rated power and the value of which is calculated from the formula below.

$$E = \sqrt{P \times R}$$

Where    E: 定格電壓    Rated voltage(V)  
              P: 定格電力    Rated power(W)  
              R: 公稱電阻值    Nominal resistance(Ω)

使用溫度 Operating Temperature Range: -55°C ~ +250°C

公司名稱 Company Name	千志電子科技(湖北)有限公司 CHIAN CHIA ELECTRONIC(HU BEI)CO.,LTD				
品名 Product Name	水泥電阻器 Cement Type Resistors				
版本 Version	A/0 版	制定日期 Enactment Date	2016 年 05 月 30 日 May 30, 2016	頁數 Page	13-4

## 2. 構造 Construction

### 2.1 外形尺寸 External dimensions

參照本承認書的 [5. 外形尺寸]。

The dimensions shall be satisfied with [5. External dimensions].

### 2.2 構造圖 Structure diagram

CR- (?) 系列之水泥固定電阻器係按下表的材料而構成:

The construction of resistor Cement Type Resistors shall be as follow:

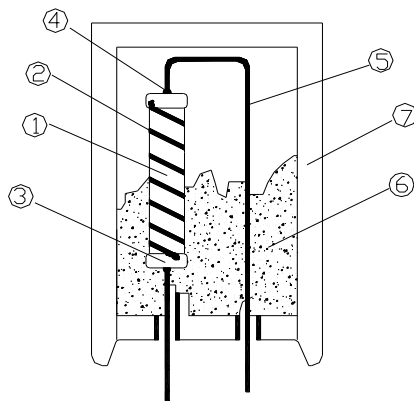

號碼 NO	構造名稱 Item	內容 Material
1	基體磁器 Ceramic core	使用高含鋁量的磁器棒。 High alumina ceramic is used.
2	電阻體 Resistor element	電阻體的成份係使用金屬氧化皮膜或電阻線(例如 : CN49W Φ1.0mm)。 The resistor element shall consist of metal oxide film or Resistance wire (Exemple:CN49W Φ1.0mm) .
3	端子 Terminal	鐵帽 Tinned iron cap.
4	連接 Connection	導線對鐵帽須以電氣熔接。 The lead wire, which is plated with solder, shall be mounted to the caps by welding process.
5	導線 Lead wire t	焊錫或鍍錫的導線。 Soldered or tinned annealed wire.
6	矽水泥 Silicon cement	使用矽樹脂。符合 UL-94V-0 不然性規定 Silicon resin is used. Accord with UL-94V-0 Nonflammable specification
7	磁殼 Ceramic case	高頻陶磁器 High thermal conductivity

公司名稱 Company Name	千志電子科技(湖北)有限公司 CHIAN CHIA ELECTRONIC(HU BEI)CO.,LTD				
品名 Product Name	水泥電阻器 Cement Type Resistors				
版本 Version	A/0 版	制定日期 Enactment Date	2016年05月30日 May 30, 2016	頁數 Page	13-5

### 3. 特性 Characteristics

表-2 Table-2

項目 Item	規格值 Performance	試驗方法(依據 JIS C 5202) Test methods(Conform to JIS C 5202)
溫度係數 Temperature Coefficient	金屬氧化皮膜:±350PPM/°C Metal Oxide Film:±350PPM/°C 電阻線: ±260PPM/°C Resistor Wire:±260PPM/°C	5.2 項參照 Comply with 5.2 $\frac{R_1 - R_0}{R_0(T_1 - T_0)} \times 10^6 (\text{PPM}/^\circ\text{C})$ R <sub>0</sub> :室溫(T <sub>0</sub> )所測量之電阻值。 R <sub>1</sub> :室溫+100°C(T <sub>1</sub> )後所測量之電阻值。 R <sub>0</sub> :Resistance value at room temp.( T <sub>0</sub> ). R <sub>1</sub> :Resistance value at room temp.plus 100°C (T <sub>1</sub> )
短時間過負荷 Short time overload	±(2%+0.05Ω)以內。 不得有機械的損傷。 Within ±(2%+0.05Ω). No evidence of mechanical damage.	5.5 項參照 Comply with 5.5 定格電力×10 倍,5 秒。 不可超過最高過負荷電壓(見表-1) Rated power×10 times,5s But not to exceed maximum overload voltage. (See table-1)
絕緣電阻 Insulation Resistance	10 <sup>3</sup> MΩ 以上。 10 <sup>3</sup> MΩ or more.	5.6 項參照 Comply with 5.6 施加直流電壓 500V 60 秒。 Resistor shall be tested at DC 500V for 60 seconds.
耐電壓 Dielectric Withstanding Voltage	無電弧放電、燒損及絕緣破 壞等異狀。 No evidence of flashover mechanical damage, arcing or insulation breakdown.	5.7 項參照 Comply with 5.7 施加個別規定之交流電壓 60 秒。(見表-1) Resistor shall be tested at AC potential respectively for 60 seconds. (See table-1)
斷續過負荷 Pulse overload	±(2%+0.05Ω)以內。 Within ±(2%+0.05Ω)	5.8 項參照 Comply with 5.8 額定電壓×4 倍,10000 回(1 秒 ON,25 秒 OFF)。 不可超過最高斷續電壓(見表-1) Rated voltage X 4 times, 10000 cyc.(1s ON, 25s OFF) But not to exceed maximum pulse voltage. (See table-1)

公司名稱 Company Name	千志電子科技(湖北)有限公司 CHIAN CHIA ELECTRONIC(HU BEI)CO.,LTD				
品名 Product Name	水泥電阻器 Cement Type Resistors				
版本 Version	A/0 版	制定日期 Enactment Date	2016 年 05 月 30 日 May 30, 2016	頁數 Page	13-6
項目 Item	規格值 Performance	試驗方法(依據 JIS C 5202) Test methods(Conform to JIS C 5202)			
焊錫耐熱性 Resistance to soldering heat	±(1%+0.05Ω)以內。 不得有機械的損傷。 Within ±(1%+0.05Ω) No evidence of mechanical damage.	6.4 項參照 Comply with 6.4 350±10°C, 3±1 秒, 試驗後放置半小時。 350±10°C, 3±1s After test leave for 0.5h.			
焊錫附著性 Solderability	導線至少 95%以上新錫覆蓋。 Covered with new solder by 95% at least.	6.5 項參照 Comply with 6.5 焊錫溫度: 255±5°C。 浸錫時間: 3±1 秒。 Test temperature of solder: 255±5°C Dipping time in solder:3±1 s			
溫度循環 Temperature cycle	±(2%+0.05Ω)以內。 不得有機械的損傷。 Within ±(2%+0.05Ω) No evidence of mechanical damage.	7.4 項參照 Comply with 7.4 低溫側: -55°C/30 分, 室溫: 10~15 分鐘 高溫側: +80°C/30 分, 室溫: 10~15 分鐘 5 回 Low side: -55°C/30min, Room temp.: 10 to 15min High side: 80°C/30min, Room temp.: 10 to 15min 5 cycles			
耐濕負荷壽命 Load life in humidity	±(5%+0.05Ω)以內。 Within ±(5%+0.05Ω)	7.9 項參照 Comply with 7.9 40±2°C, 濕度 90~95%, 1000 小時 定格電壓(90 分鐘 ON, 30 分鐘 OFF) 40±2°C, 90 to 95%RH, 1000h Rated voltage (90 min ON, 30 min OFF)			
負荷壽命 Load life	±(5%+0.05Ω)以內。 Within ±(5%+0.05Ω)	7.10 項參照 Comply with 7.10 70±3°C, 1000 小時 定格電壓(90 分鐘 ON, 30 分鐘 OFF) 70±3°C, 1000h Rated voltage (90 min ON, 30 min OFF)			

公司名稱 Company Name	千志電子科技(湖北)有限公司 CHIAN CHIA ELECTRONIC(HU BEI)CO.,LTD				
品名 Product Name	水泥電阻器 Cement Type Resistors				
版本 Version	A/0 版	制定日期 Enactment Date	2016 年 05 月 30 日 May 30, 2016	頁數 Page	13-7

#### 4. 表示 Indication

(1) 定格電力 Rated Power

(2) 公稱抵抗值 Resistance

(3) 抵抗值許容差 Tolerance

例： Sample

5W 100Ω J
-----------

#### 5. 外形寸法 External dimensions

##### 5.1 CR-L 型 CR-Ltype

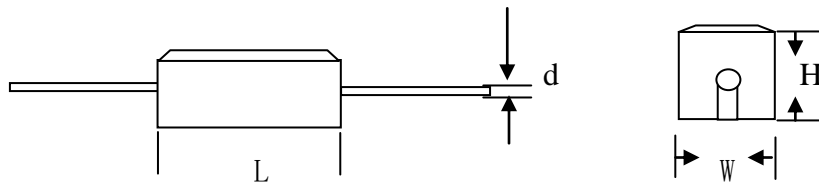

單位:mm

Unit:mm

瓦特 Watt	尺寸 Dimensions (mm)				阻值範圍(Ω) Resistance Range(Ω)	
	L	W	H	Φd±0.05	線繞 Wire Wound	金屬氧化皮膜 Metal Oxide Film
1W	14±1.0	6.5±1.0	6.5±1.0	0.50	0.1Ω ~22Ω	25Ω ~56KΩ
2W	18±1.0	7.0±1.0	7.0±1.0	0.50	0.1Ω ~22Ω	25Ω ~56KΩ
3W	22±1.0	8.0±1.0	8.0±1.0	0.68	0.1Ω ~47Ω	50Ω ~100KΩ
5W	22±1.0	9.5±1.0	9.5±1.0	0.68	0.1Ω ~47Ω	50Ω ~100KΩ
7W	35±1.5	9.5±1.5	9.5±1.5	0.68	0.5Ω ~330Ω	450Ω ~100KΩ
10W	48±1.5	9.5±1.5	9.5±1.5	0.68	0.5Ω ~450Ω	470Ω ~100KΩ
15W	48±1.5	13±1.5	13±1.5	0.68	1Ω ~500Ω	510Ω ~100KΩ
20W	60±1.5	13±1.5	13±1.5	0.68	1Ω ~600Ω	620Ω ~100KΩ
30W	75±2.0	19±2.0	17±2.0	0.68	1Ω ~600Ω	620Ω ~100KΩ
40W	89±2.0	19±2.0	19±2.0	0.68	1Ω ~600Ω	620Ω ~100KΩ
50W	89±2.0	19±2.0	19±2.0	0.68	1Ω ~600Ω	620Ω ~100KΩ
100W	135±2.0	22±2.0	22±2.0	0.68	1Ω ~600Ω	620Ω ~100KΩ



公司名稱 Company Name	千志電子科技(湖北)有限公司 CHIAN CHIA ELECTRONIC(HU BEI)CO.,LTD				
品名 Product Name	水泥電阻器 Cement Type Resistors				
版本 Version	A/0 版	制定日期 Enactment Date	2016 年 05 月 30 日 May 30, 2016	頁數 Page	13-8

5.2 CR-M 型 CR-M type

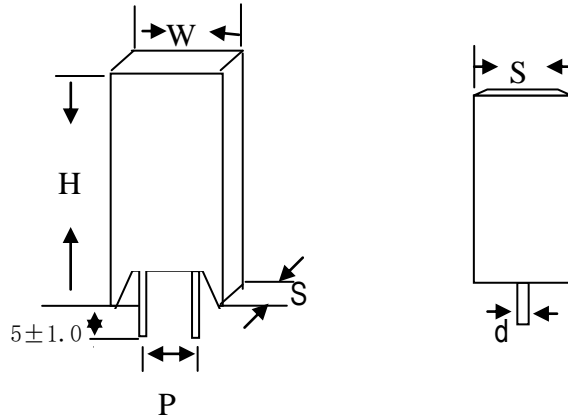

單位：mm  
Unit：mm

瓦特 Watt	尺寸 Dimensions (mm)					阻值範圍(Ω) Resistance Range(Ω)	
	W±1.0	S±1.0	H±1.5	Φ d±0.05	P±1.0	線繞 Wire Wound	金屬氧化皮膜 Metal Oxide Film
2W	11.5	7.5	20.5	0.50	4.5	0.1Ω ~47Ω	50Ω ~100KΩ
3W	12	8.5	25	0.68	4.5	0.1Ω ~47Ω	50Ω ~100KΩ
5W	13	9.5	25	0.68	4.5	0.1Ω ~47Ω	50Ω ~100KΩ
7W	13	9.5	38	0.68	4.5	0.5Ω ~330Ω	450Ω ~100KΩ
10W	13	9.5	52	0.68	4.5	0.5Ω ~450Ω	470Ω ~100KΩ
10W	16	11.5	36	0.68	4.5	0.5Ω ~450Ω	470Ω ~100KΩ

5.3 CR-YB 型 CR-YBtype

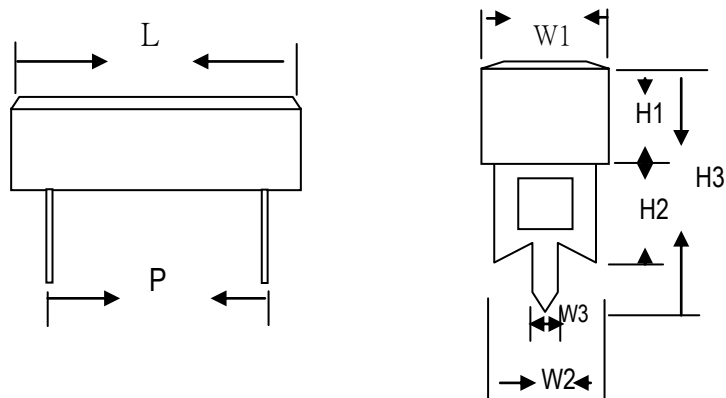

公司名稱 Company Name	千志電子科技(湖北)有限公司 CHIAN CHIA ELECTRONIC(HU BEI)CO.,LTD				
品名 Product Name	水泥電阻器 Cement Type Resistors				
版本 Version	A/0 版	制定日期 Enactment Date	2016 年 05 月 30 日 May 30, 2016	頁數 Page	13-9

單位:mm

Unit:mm

瓦特 Watt	尺寸 Dimensions (mm)								阻值範圍(Ω)
	L	P±1.5	W1±1.2	W2±0.3	W3±0.2	H1±1.2	H2±0.2	H3±1.5	Resistance Range(Ω)
15	48±1.5	32.5	12.5	10	2.7	12.5	15	36	1.0-820
20	63±2.0	44	12.5	10	2.7	12.5	15.5	36	1.0-2K
30	75±2.0	54	19±2.0	10	3.0	17±2.0	10.5	36	1.0-2K
40	89±2.0	67	19±2.0	10	3.0	19±2.0	10.5	36	1.0-2K
50	89±2.0	67	19±2.0	10	3.0	19±2.0	10.5	36	1.0-2K
100	135±2.0	114	22±2.0	10	3.0	22±2.0	13.0	40	1.0-2K

#### 5.4 CR-YD 型 CR-YD type

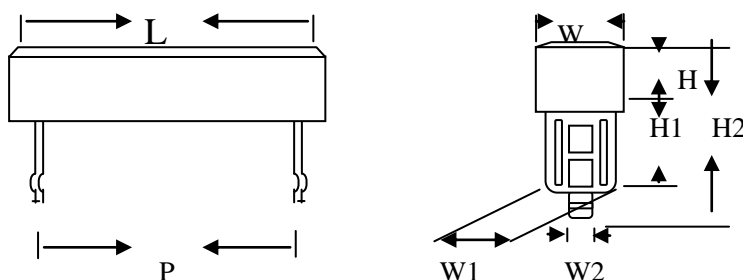

單位:mm

Unit:mm

瓦特 Watt	尺寸 Dimensions (mm)								阻值範圍(Ω)
	L	P±1.5	W±1.0	W1±0.2	W2±0.2	H±0.2	H1±0.2	H2±1.5	Resistance Range(Ω)
3	24±1.0	12	9.5	7.5	1.6	9.5	25	39	0.5-150
5	27±1.0	15	9.5	7.5	1.6	9.5	25	39	0.5-220
7	35±1.5	22.5	9.5	7.5	1.6	9.5	25	39	1-470
10	48±1.5	34	9.5	7.5	1.6	9.5	25	39	1-680
15	48±1.5	32.5	12.5	10	3	12.5	30	47.5	1-820
20	63±2.0	44	12.5	10	3	12.5	30	47.5	1-1K

公司名稱 Company Name	千志電子科技(湖北)有限公司 CHIAN CHIA ELECTRONIC(HU BEI)CO.,LTD				
品名 Product Name	水泥電阻器 Cement Type Resistors				
版本 Version	A/0 版	制定日期 Enactment Date	2016 年 05 月 30 日 May 30, 2016	頁數 Page	13-10

5.5 CR-YA 型 CR-YA type

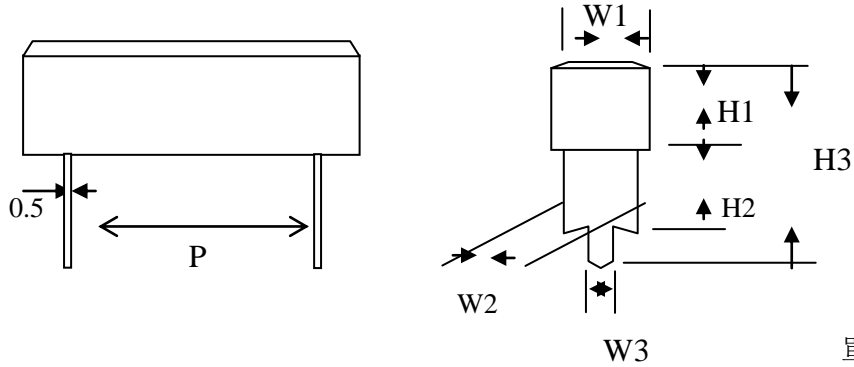

單位:mm  
Unit:mm

瓦特 Watt	尺寸 Dimensions (mm)								阻值範圍(Ω)
	L	P±1.5	W1±1.0	W2±0.2	W3±0.2	H1±0.2	H2±0.2	H3±0.2	Resistance Range(Ω)
3	24±1.0	12	9.5	5.3	0.9	9.5	10	25.5	0.5-150
5	27±1.0	15	9.5	5.3	0.9	9.5	10	25.5	0.5-220
7	35±1.5	22.5	9.5	5.3	0.9	9.5	10	25.5	1-470
10	48±1.5	34	9.5	5.3	0.9	9.5	10	25.5	1-680

5.6 CR-YC 型 CR-YC type

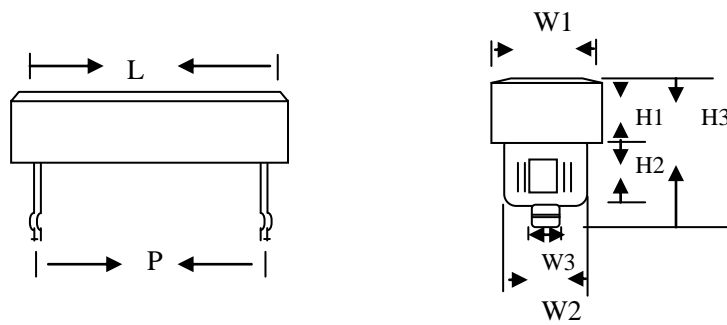

單位:mm  
Unit:mm

瓦特 Watt	尺寸 Dimensions (mm)								阻值範圍(Ω)
	L	P±1.5	W1±1.0	W2±0.2	W3±0.2	H1±1	H2±0.5	H3±1.5	Resistance Range(Ω)
3	24±1.0	12	9.5	7.3	1.6	9.5	10	25	0.5-150
5	27±1.0	15	9.5	7.3	1.6	9.5	10	25	0.5-220
7	35±1.5	22.5	9.5	7.3	1.6	9.5	10	25	1-470
10	48±1.5	34	9.5	7.3	1.6	9.5	10	25	1-680
20	63±2.0	44	12.5	10	3	12.5	15	35.5	1-680

公司名稱 Company Name	千志電子科技(湖北)有限公司 CHIAN CHIA ELECTRONIC(HU BEI)CO.,LTD				
品名 Product Name	水泥電阻器 Cement Type Resistors				
版本 Version	A/0 版	制定日期 Enactment Date	2016 年 05 月 30 日 May 30, 2016	頁數 Page	13-11

5.7 CR-YE 型 CR-YE type

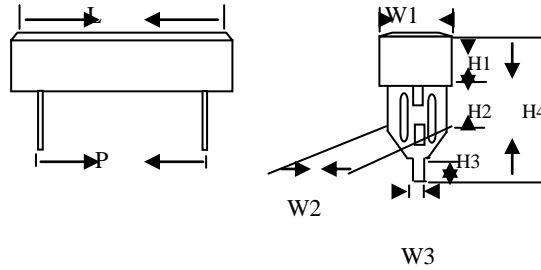

單位:mm

Unit:mm

瓦特 Watt	尺寸 Dimensions (mm)									阻值範圍(Ω)
	L	P±1.5	W1±1.0	W2±0.2	W3±0.2	H1±0.2	H2±0.2	H3±1.5	H4±1.5	Resistance Range(Ω)
3	24±1.0	12	9.5	7.4	3	9.5	7.5	4.5	30.4	0.5-150
5	27±1.0	15	9.5	7.4	3	9.5	7.5	4.5	30.4	0.5-220
7	35±1.5	22.5	9.5	7.4	3	9.5	7.5	4.5	30.4	1-470
10	48±1.5	34	9.5	7.4	3	9.5	7.5	4.5	30.4	1-680

5.8 CR-YD1 型 CR-YD1 type

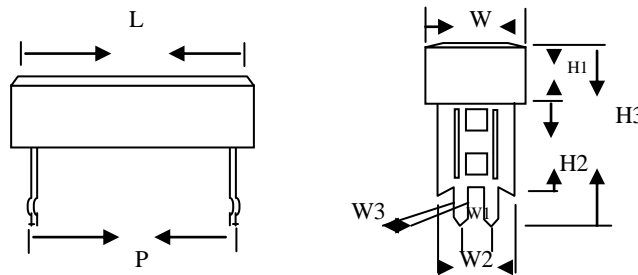

單位:mm

Unit:mm

瓦特 Watt	尺寸 Dimensions (mm)									阻值範圍(Ω)
	L	P±1.5	W±1	W2±0.5	W3±0.2	W1±0.5	H1±1	H2±1	H3±1.5	Resistance Range(Ω)
15	48±1.5	22	12.5	10	1.5	5	12.5	30	47.5	10-820
20	63±2.0	43	12.5	10	1.5	5	12.5	30	47.5	1.0-1K
30	75±2.0	54	19±2.0	10	1.5	5	17.5	30	47.5	1.0-1K
40	89±2.0	67	19±2.0	10	1.5	5	17.5	23	45.5	1.0-1K
50	89±2.0	67	19±2.0	10	1.5	5	17.5	23	45.5	1.0-1K
100	135±2.0	108	22±2.0	10	1.5	5	22	24	51	1.0-2K

公司名稱 Company Name	千志電子科技(湖北)有限公司 CHIAN CHIA ELECTRONIC(HU BEI)CO.,LTD				
品名 Product Name	水泥電阻器 Cement Type Resistors				
版本 Version	A/0 版	制定日期 Enactment Date	2016 年 05 月 30 日 May 30, 2016	頁數 Page	13-12

5.9 CR-V 型 CR-V type

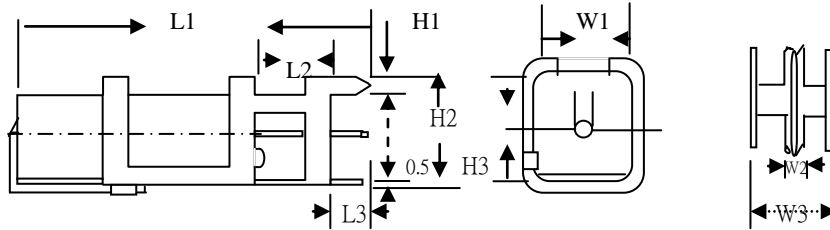

單位:mm  
Unit:mm

瓦特 Watt	尺寸 Dimensions (mm)									阻值範圍(Ω)
	L1	L2±0.2	L3±0.2	H1±0.2	H2±0.2	H3±1.0	W1±1.0	W2±0.2	W3±0.5	Resistance Range(Ω)
5	31±1.0	5	4	1.5	11	9.5	9.5	1.5	11.5	0.5-220
7	49±1.5	10	4	1.5	11	9.5	9.5	1.5	11.5	1-470
10	62.5±2	10	4	1.5	11	9.5	9.5	1.5	11.5	1-680
15	63.5±2	10	4.5	2.5	14.5	13	13	2.5	15.5	1-820
20	75±2	10	4.5	2.5	17.5	13	13	2.5	15.5	1-1K

公司名稱 Company Name	千志電子科技(湖北)有限公司 CHIAN CHIA ELECTRONIC(HU BEI)CO.,LTD				
品名 Product Name	水泥電阻器 Cement Type Resistors				
版本 Version	A/0 版	制定日期 Enactment Date	2016 年 05 月 30 日 May 30, 2016	頁數 Page	13-13

5.10 CR-H 型 CR-H type

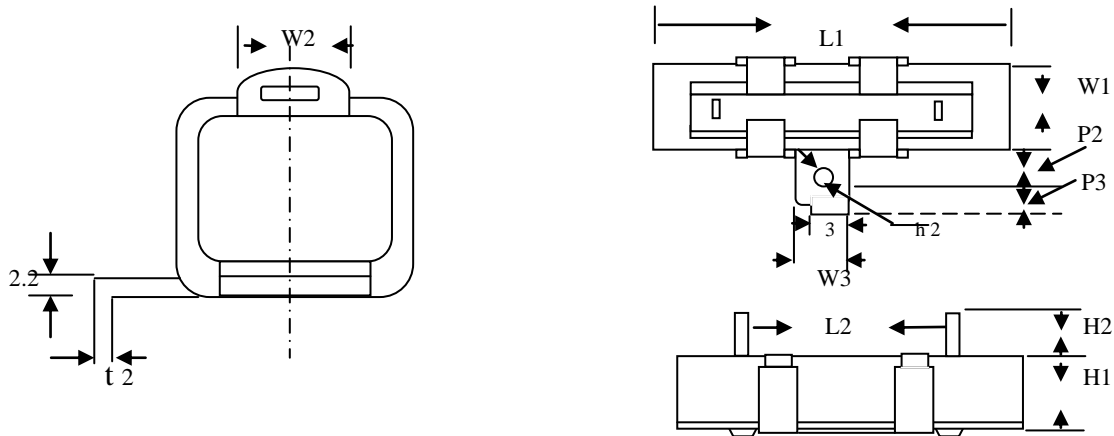

單位:mm  
Unit:mm

瓦特 Watt	尺寸 Dimensions (mm)										阻值範圍(Ω) Resistance Range(Ω)	
	L1	L2±1.0	W3±0.2	P2	P3	t2	h2	W1	W2	H1	H2	
10	48±1.5	23	12	6	8	0.6	4	9.5±1.0	5	9.5±1.0	6±1.5	1-680
15	48±1.5	23	12	7	8	0.8	4	12.5±1.2	6	12.5±1.2	7.5±2.0	10-820
20	63±2.0	23	12	7	10	0.8	4	12.5±1.2	6	12.5±1.2	7.5±2.0	1-1K
30	75±2.5	56	18	9	10	0.8	4.2	19±1.5	7.5	19±1.5	10±2.0	1-1K
40	88±2.5	68	18	9	10	0.8	4.2	19±1.5	7.5	19±1.5	10±2.0	1-1K

## X-ON Electronics

Largest Supplier of Electrical and Electronic Components

*Click to view similar products for [Thick Film Resistors - Through Hole](#) category:*

*Click to view products by [Chian Chia](#) manufacturer:*

Other Similar products are found below :

[M8340104K3300GCD03](#) [M8340105K3300GGD03](#) [M8340105K3922FGD03](#) [M8340107K2401GCD03](#) [M8340109K1002JCD03](#)

[M8340109K1003GCD03](#) [MP850-3.00-1%](#) [ARC3.11 2M J A](#) [M8340105K1003GCD03](#) [M8340105M2201GCD03](#) [M8340107M7501GCD03](#)

[M8340108K2051FCD03](#) [M8340108K7501GCD03](#) [M8340108M5100JGD03](#) [M8340109K1000GCD03](#) [MOX-GRD-001](#)

[M8340102M4701GBD04](#) [M8340102K1002GBD04](#) [M8340109K2002GGD03](#) [M8340108K2002FGD03](#) [OE1305](#) [MS-221-82R5](#) [MOX-](#)

[750231004DE](#) [MOX-4-127505J](#) [SM102034504FE](#) [MOX300002206FE](#) [MOX-400233004F](#) [MOX300001005BE](#) [SM104066008J](#) [MOX-](#)

[400262008PE](#) [MOX-400232506FE](#) [MOX-400234007FE](#) [MOX-400221006G](#) [MOX-750235006ME](#) [SM103032506FE](#) [SM202022005FE](#)

[MOX1125231002FE](#) [MOX-1-122504F](#) [MOX-400225003F](#) [MOX1125731008FE](#) [MOX-5-126002JE](#) [MS176-2.20M-1%](#) [MOX-830212453BE](#)

[TRHE01A270RJ2E](#) [TRHE01A560RJ2E](#) [TRHP01A200RF2E](#) [TRHP01A5001F2E](#) [MG715-2.40M-1%](#) [MS214-20.0K-1%](#) [MF0W4FF4702A50](#)