



客 戶:

(CUSTOMER)

發行日期:

PUBLISH DATE

年

月

日

year

month

day

承 認 書

(APPROVAL SHEET)

名

稱:

不燃性金屬氧化皮膜電阻器

(DESCRIPTION)

Metal Oxide Film Resistors(Nonflammable)

貴公司料號碼:

(CUSTOMER TYPE NO)

承認 APPROVED BY

千 志 電 子 (深 圳) 有 限 公 司
CHIAN CHIA ELECTRONIC(SHENZHEN)CO.,LTD

千 志 電 子 科 技 (湖 北) 有 限 公 司
CHIAN CHIA ELECTRONIC(HU BEI)CO.,LTD

湖北工厂:湖北省孝感市孝南区汉十工业园

HANSHIINDUSTRY XIAOGANG TOWN SOUTH AREA XIAOGAN CITY HUBEI PROVINCE

TEL:86-712-2610128

FAX:86-712-2610235

Http:www.cco-chianchia.com

E-mail:ccoserve@cco-chianchia.com

| | | | | | |
|----------------------|----------------------------------------------------------|------------------------|----------------------------------|------------|------|
| 公司名稱 Company Name | 千志電子科技(湖北)有限公司 CHIAN CHIA ELECTRONIC(HU BEI)CO.,LTD | | | | |
| 品名 Product Name | 不燃性金屬氧化皮膜電阻器 Metal Oxide Film Resistors(Nonflammable) | | | | |
| 版本 Version | A/0 版 | 制定日期 Enactment Date | 2016 年 05 月 30 日 May 30, 2016 | 頁數 Page | 13-1 |

1. 一般事項 General

1.1 適用 Scope

本承認書適用於 千志電子科技(湖北)有限公司 製造之[不燃性金屬氧化皮膜電阻器]，符合環境關聯物質要求之 RoHS 測試。

This specification is available for Metal Oxide Film Resistors manufactured by CHIAN CHIA ELECTRONIC(HU BEI)CO.,LTD, it accords with RoHS test of Environment related substance requirement.

1.2 形名(例) Type designation (example)

依使用種類、額定電力、公稱電阻值、容許誤差及型狀而區別,其構造如下。

The type designation shall be in the following form and as specified.

| MOF | 1/4 W | 10K | J | T52 |
|------------|-----------------------|-----------------------------------|---------------------------------|----------------|
| 種類 Type | 額定電力 Rated power | 公稱電阻值 Nominal resistance value | 電阻值容許誤差 Resistance tolerance | 形狀 Form |
| | 標準 小型 Normal Small | E-24 Series | J ±5% | P 型 P Type |
| | 1/4W 1/2WS | E-96 Series | G ±2% | M 型 M Type |
| | 1/2W 1WS | | | MB 型 MB Type |
| | 1W 2WS | | | FK1 型 FK1Type |
| | 2W 3WS | | | FK2 型 FK2 Type |
| | 3W 5WS | | | FKK 型 FKK Type |
| | 5W | | | |

1.3 額定電力 Rated power

額定電力係應在周圍溫度 70°C 可以連續負載的最大電力，如表-1;但周圍溫度如超過 70°C 時之額定電力則依圖一的電力遞減曲線實施。

Rated power is maximum power which can be continuously loaded at specified ambient temperature 70°C, as Table-1; however when the ambient temperature exceeds 70°C, rated power should be determined from the derating curve of Fig.1.

| | | | | | |
|----------------------|----------------------------------------------------------|------------------------|-----------------------------|------------|------|
| 公司名稱 Company Name | 千志電子科技(湖北)有限公司 CHIAN CHIA ELECTRONIC(HU BEI)CO.,LTD | | | | |
| 品名 Product Name | 不燃性金屬氧化皮膜電阻器 Metal Oxide Film Resistors(Nonflammable) | | | | |
| 版本 Version | A/0 版 | 制定日期 Enactment Date | 2016年05月30日 May 30, 2016 | 頁數 Page | 13-2 |

表-1 Table-1

| 種類 Type | 定格電力 Rated power | 最高使用電壓 Maximum working voltage | 最高過負荷電壓 Maximum overload voltage | 絕緣耐電壓 Dielectric withstanding voltage | 阻值範圍(Ω) Resistance Range(Ω) | |
|-------------|---------------------|-----------------------------------|-------------------------------------|------------------------------------------|--------------------------------|-------------|
| Normal size | MOF1/4W | 0.25W | 250V | 400V | 200V | 0.1Ω ~100KΩ |
| | MOF1/2W | 0.5W | 250V | 400V | 300V | 0.1Ω ~100KΩ |
| | MOF1W | 1W | 350V | 600V | 350V | 0.1Ω ~100KΩ |
| | MOF2W | 2W | 350V | 600V | 350V | 0.1Ω ~100KΩ |
| | MOF3W | 3W | 500V | 800V | 400V | 0.1Ω ~100KΩ |
| | MOF5W | 5W | 750V | 1000V | 400V | 0.1Ω ~100KΩ |
| Small size | MOF1/2WS | 0.5W | 250V | 400V | 200V | 0.1Ω ~100KΩ |
| | MOF1WS | 1W | 350V | 600V | 300V | 0.1Ω ~100KΩ |
| | MOF2WS | 2W | 350V | 600V | 350V | 0.1Ω ~100KΩ |
| | MOF3WS | 3W | 350V | 600V | 350V | 0.1Ω ~100KΩ |
| | MOF5WS | 5W | 500V | 800V | 400V | 0.1Ω ~100KΩ |

圖一 電力遞減曲線 Figure 1 Power derating curve



1.4 額定電壓 Rated voltage

額定電壓係指對應於額定電力的直流或交流(商用頻率之有效值)的電壓,由下式求得。

The rated voltage shall be the D.C. or A.C.(R.M.S. at power frequency) voltage which corresponds the rated power and the value of which is calculated from the formula below.

| | | | | | |
|----------------------|----------------------------------------------------------|------------------------|-----------------------------|------------|------|
| 公司名稱 Company Name | 千志電子科技(湖北)有限公司 CHIAN CHIA ELECTRONIC(HU BEI)CO.,LTD | | | | |
| 品名 Product Name | 不燃性金屬氧化皮膜電阻器 Metal Oxide Film Resistors(Nonflammable) | | | | |
| 版本 Version | A/0 版 | 制定日期 Enactment Date | 2016年05月30日 May 30, 2016 | 頁數 Page | 13-4 |

- 2.3 鐵帽端子 Terminal caps
鐵帽端子須確實地連接(電氣的及機械的)於電阻體上。
The caps shall be securely connected with the resistor element electrically and mechanically.
- 2.4 外裝色澤 Resistor body color

表-2 Table-2

| 普通型 Normal size | | 小型化 Small size | |
|--------------------------------------------------|------------|----------------------------------------------|------------------------|
| 種類 Type | 顏色 Color | 種類 Type | 顏色 Color |
| MOF1/4W,MOF1/2W, MOF1W,MOF2W, MOF3W, MOF5W | 灰色 Gray | MOF1/2WS,MOF1WS, MOF2WS,MOF3WS, MOF5WS | 灰色或粉紅色 Gray or pink |

- 2.5 表示 Indication
參照本承認書的 [4. 表示]。
The indication shall be satisfied with [4. Indication].

3. 特性 Characteristics

表-3 Table-3

| 項目 Item | 規格值 Performance | 試驗方法(依據 JIS C 5202) Test methods(Conform to JIS C 5202) |
|------------------------------------|---------------------------------------------------------------------------------------------------------------|----------------------------------------------------------------------------------------------------------------------------------------------------------------------------------------------------------------------------------------------------------------------------------------------------------------------------|
| 溫度係數 Temperature Coefficient | $\pm 350\text{PPM}/^\circ\text{C}$ ($\pm 500\text{PPM}/^\circ\text{C} < 1\Omega$) | 5.2 項參照 Comply with 5.2 $\frac{R_1 - R_0}{R_0(T_1 - T_0)} \times 10^6 (\text{PPM}/^\circ\text{C})$ R_0 :室溫(T_0)所測量之電阻值。 R_1 :室溫+100 $^\circ\text{C}$ (T_1)後所測量之電阻值。 R_0 :Resistance value at room temp.(T_0). R_1 :Resistance value at room temp.plus 100 $^\circ\text{C}$ (T_1) |
| 短時間過負荷 Short time overload | $\pm(1\%+0.05\Omega)$ 以內。 不得有機械的損傷。 Within $\pm(1\%+0.05\Omega)$. No evidence of mechanical damage. | 5.5 項參照 Comply with 5.5 額定電壓 $\times 2.5$ 倍,5秒。 不可超過最高過負荷電壓(見表-1) Rated voltage $\times 2.5$ times,5s But not to exceed maximum overload voltage.(See table-1) |

| | | | | | |
|------------------------------------------------------------------------------------------------------------------------------------------------------------------------------------------------------------------------------------------------------------------------------------------------------------------------------------------------------------------------------------------------------------------------------------------------------------------------------------------------------------------------------------------------------------------------------------------------------------------------|--------------------------------------------------------------------------------------------------|----------------------------------------------------------------------------------------------------------------------------------------------------------------------------------------------------|-----------------------------|--------------------------------|----------------|
| 公司名稱 Company Name | | 千志電子科技(湖北)有限公司 CHIAN CHIA ELECTRONIC(HU BEI)CO.,LTD | | | |
| 品名 Product Name | | 不燃性金屬氧化皮膜電阻器 Metal Oxide Film Resistors(Nonflammable) | | | |
| 版本 Version | A/0 版 | 制定日期 Enactment Date | 2016年05月30日 May 30, 2016 | 頁數 Page | 13-5 |
| 項目 Item | 規格值 Performance | 試驗方法(依據 JIS C 5202) Test methods(Conform to JIS C 5202) | | | |
| 絕緣電阻 Insulation Resistance | 10 ⁴ MΩ 以上。 10 ⁴ MΩ or more. | 5.6 項參照 Comply with 5.6 置於 V 型槽方法。 施加直流電壓 500V 60 秒。 V-block method Resistor shall be tested at DC 500V for 60 seconds. | | | |
| 耐電壓 Dielectric Withstanding Voltage | 無電弧放電、燒損及絕緣破壞等異狀。 No evidence of flashover mechanical damage, arcing or insulation breakdown. | 5.7 項參照 Comply with 5.7 常壓,置於 V 型槽方法。 施加個別規定之交流電壓 60 秒。(見表-1) Constant pressure, V-block method Resistor shall be tested at AC potential respectively for 60 seconds. (See table-1) | | | |
| 斷續過負荷 Pulse overload | ±(2%+0.05Ω)以內。 Within ±(2%+0.05Ω) | 5.8 項參照 Comply with 5.8 額定電壓×4 倍,10000 回(1 秒 ON,25 秒 OFF)。 不可超過最高斷續電壓(見表-1) Rated voltage X 4 times, 10000 cyc.(1s ON, 25s OFF) But not to exceed maximum pulse voltage. (See table-1) | | | |
| 端子強度 Terminal strength | 端子不得斷裂及鬆弛。 No evidence of mechanical damage. | 6.1 項參照 Comply with 6.1 | | | |
| | | 引張強度 Tensile strength | 線徑 mm Diameter | 引張力 Tensile force N(kgf) | 時間 Time |
| | | | Φ 0.38mm~0.50mm | 5(0.51) | 10±1 second |
| | | | Φ 0.50mm~0.68 mm | 10(1.02) | |
| <p>扭轉強度：自電阻體起約 6mm~6.5mm 處之端子線,以約 0.75mm 曲率半徑彎曲 90 度,其次由彎曲處向端子線先端 1.2±0.4mm 處挾定端子引出軸,作回轉軸,以約 5 秒時間沿直面回轉 360°再逆轉 360°,如此施行回逆轉 2 次,不可發生折斷及鬆動現象。</p> <p>Tensional strength : To bend the lead wire at the point of about 6mm~6.5mm from resistor body. about 0.75mm curvature radii to 90° then catch the wire at 1.2±0.4mm apart from the bend point end and turn it (clockwise) by 360 degrees perpendicular to the resistor axis at speed of same 5 seconds per turn, and do the same counterclockwise again which constitute a whole turn. Repeat the turn for 2 times without causing any break and looseness.</p> | | | | | |

| | | | | | |
|---------------------------------------|----------------------------------------------------------------------------------------|------------------------------------------------------------------------------------------------------------------------------------------------------------------------------------------------------------------|----------------------------------|------------|------|
| 公司名稱 Company Name | 千志電子科技(湖北)有限公司 CHIAN CHIA ELECTRONIC(HU BEI)CO.,LTD | | | | |
| 品名 Product Name | 不燃性金屬氧化皮膜電阻器 Metal Oxide Film Resistors(Nonflammable) | | | | |
| 版本 Version | A/0 版 | 制定日期 Enactment Date | 2016 年 05 月 30 日 May 30, 2016 | 頁數 Page | 13-6 |
| 項目 Item | 規格值 Performance | 試驗方法(依據 JIS C 5202) Test methods(Conform to JIS C 5202) | | | |
| 焊錫耐熱性 Resistance to soldering heat | ±(1%+0.05Ω)以內。 不得有機械的損傷。 Within ±(1%+0.05Ω) No evidence of mechanical damage. | 6.4 項參照 Comply with 6.4 350±10°C, 3±1.0 秒, 試驗後放置半小時。 350±10°C, 3±1.0s After test leave for 0.5h. | | | |
| 焊錫附著性 Solderability | 導線至少 95%以上新錫覆蓋。 Covered with new solder by 95% at least. | 6.5 項參照 Comply with 6.5 焊錫溫度: 255±5°C。 浸錫時間: 3±1.0 秒。 Test temperature of solder:255±5°C Dipping time in solder:3±1.0 s | | | |
| 耐溶劑性 Resistance to solvent | 塗裝及色碼不得脫落。 No deterioration of protective coating and markings. | 6.9 項參照 Comply with 6.9 放入酒精溶劑之超音波機內, 保持 3 分鐘。 Specimens shall be immersed in a bath of isoproalcohol completely for 3 minutes with ultrasonic. | | | |
| 溫度循環 Temperature cycle | ±(2%+0.05Ω)以內。 不得有機械的損傷。 Within ±(2%+0.05Ω) No evidence of mechanical damage. | 7.4 項參照 Comply with 7.4 低溫側: -55°C/30 分, 室溫: 10~15 分鐘 高溫側: +80°C/30 分, 室溫: 10~15 分鐘 5 回 Low side: -55°C/30min, Room temp.: 10 to 15min High side: 80°C/30min, Room temp.: 10 to 15min 5 cycles | | | |
| 耐濕負荷壽命 Load life in humidity | ±(5%+0.05Ω)以內。 Within ±(5%+0.05Ω) | 7.9 項參照 Comply with 7.9 40±2°C, 濕度 90~95%, 1000 小時 定格電壓(90 分鐘 ON, 30 分鐘 OFF) 40±2°C, 90 to 95%RH, 1000h Rated voltage (90 min ON, 30 min OFF) | | | |
| 負荷壽命 Load life | ±(5%+0.05Ω)以內。 Within ±(5%+0.05Ω) | 7.10 項參照 Comply with 7.10 70±3°C, 1000 小時 定格電壓(90 分鐘 ON, 30 分鐘 OFF) 70±3°C, 1000h Rated voltage (90 min ON, 30 min OFF) | | | |

| | | | | | |
|----------------------|----------------------------------------------------------|------------------------|----------------------------------|------------|------|
| 公司名稱 Company Name | 千志電子科技(湖北)有限公司 CHIAN CHIA ELECTRONIC(HU BEI)CO.,LTD | | | | |
| 品名 Product Name | 不燃性金屬氧化皮膜電阻器 Metal Oxide Film Resistors(Nonflammable) | | | | |
| 版本 Version | A/0 版 | 制定日期 Enactment Date | 2016 年 05 月 30 日 May 30, 2016 | 頁數 Page | 13-7 |

4. 表示 Indication
色碼 Color Code

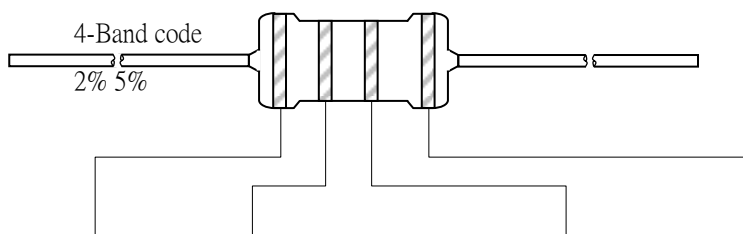

| 顏色 Color | 第 1 數字 1 st figure | 第 2 數字 2 nd figure | 第 3 數字 3 RD figure | 倍 率 Multiplier | 誤差率 Tolerance |
|----------|----------------------------------|----------------------------------|----------------------------------|-------------------|------------------|
| 黑 Black | 0 | 0 | 0 | 10 ⁰ | |
| 棕 Brown | 1 | 1 | 1 | 10 ¹ | |
| 紅 Red | 2 | 2 | 2 | 10 ² | ±2% (G) |
| 橙 Orange | 3 | 3 | 3 | 10 ³ | |
| 黃 Yellow | 4 | 4 | 4 | 10 ⁴ | |
| 綠 Green | 5 | 5 | 5 | 10 ⁵ | |
| 藍 Blue | 6 | 6 | 6 | 10 ⁶ | |
| 紫 Violet | 7 | 7 | 7 | 10 ⁷ | |
| 灰 Gray | 8 | 8 | 8 | | |
| 白 White | 9 | 9 | 9 | | |
| 金 Gold | | | | 10 ⁻¹ | ±5% (J) |
| 銀 Silver | | | | 10 ⁻² | |
| 無 Plain | | | | | |

| | | | | | |
|----------------------|----------------------------------------------------------|------------------------|-----------------------------|------------|------|
| 公司名稱 Company Name | 千志電子科技(湖北)有限公司 CHIAN CHIA ELECTRONIC(HU BEI)CO.,LTD | | | | |
| 品名 Product Name | 不燃性金屬氧化皮膜電阻器 Metal Oxide Film Resistors(Nonflammable) | | | | |
| 版本 Version | A/0 版 | 制定日期 Enactment Date | 2016年05月30日 May 30, 2016 | 頁數 Page | 13-8 |

5. 外形寸法 External dimensions

5.1 散裝P型 P type

P Type

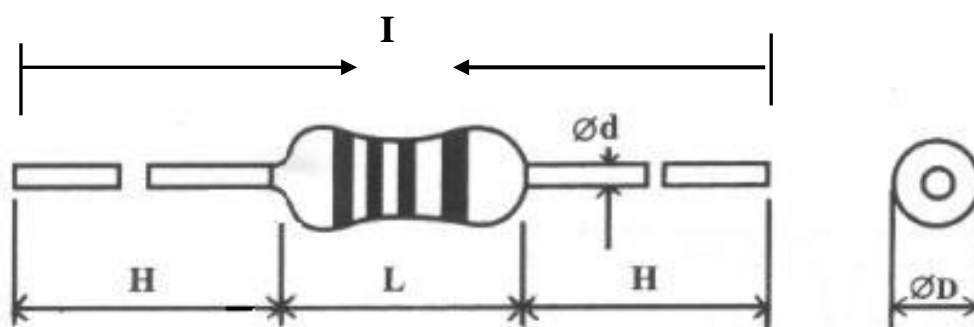

單位：mm

Unit：mm

| 種類 Type | | 尺寸 Dimensions | | | | |
|--------------------|-------------------|---------------|-------------|---------------|-------------------|-------------|
| 普通型 Normal Size | 小型化 Small Size | $I \pm 2.0$ | $L \pm 1.0$ | ψD | $\psi d \pm 0.05$ | $H \pm 2.0$ |
| MOF1/4W | MOF1/2WS | 60 | 6.5 | 2.3 ± 0.5 | 0.43 | 26 |
| MOF1/2W | MOF1WS | 60 | 9.0 | 3.2 ± 0.5 | 0.50 | 26 |
| MOF1W | MOF2WS | 60 | 11.5 | 4.5 ± 1.0 | 0.68 | 25 |
| | | 73 | 11.5 | 4.5 ± 1.0 | 0.68 | 31 |
| MOF2W | MOF3WS | 60 | 15.5 | 5.0 ± 1.0 | 0.68 | 23 |
| | | 81 | 15.5 | 5.0 ± 1.0 | 0.68 | 33 |
| MOF3W | MOF5WS | 94 | 17.5 | 6.0 ± 1.0 | 0.68 | 38 |
| MOF5W | | 94 | 24.5 | 8.0 ± 1.0 | 0.68 | 35 |

| | | | | | |
|----------------------|----------------------------------------------------------|------------------------|-----------------------------|------------|------|
| 公司名稱 Company Name | 千志電子科技(湖北)有限公司 CHIAN CHIA ELECTRONIC(HU BEI)CO.,LTD | | | | |
| 品名 Product Name | 不燃性金屬氧化皮膜電阻器 Metal Oxide Film Resistors(Nonflammable) | | | | |
| 版本 Version | A/0 版 | 制定日期 Enactment Date | 2016年05月30日 May 30, 2016 | 頁數 Page | 13-9 |

5.2 帶裝 Axial Lead Taping

Txx Type

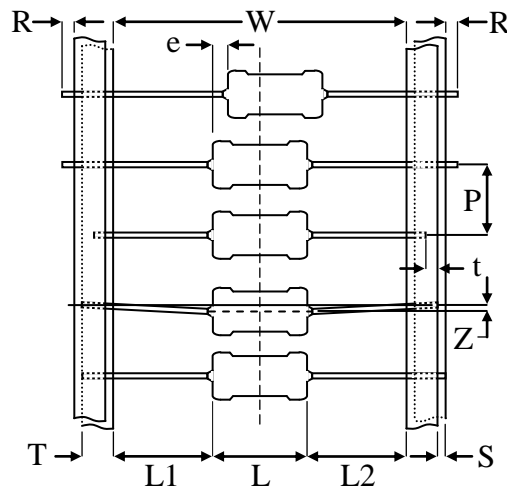

單位：mm
Unit：mm

| 種類 Type | | 帶狀 Taping | 尺寸 Dimensions | | | | | | | | | |
|-----------------|----------------|-----------|---------------|--------------------------------|--------|------------|-------|--------|--------|--------|--------|--------|
| 普通型 Normal Size | 小型化 Small Size | | L | W | P | L1-L2 Max. | T | Z Max. | R Max. | t Max. | e Max. | S Max. |
| MOF1/4W | MOF1/2WS | T26 | 6.5±0.5 | 26 ⁺¹ ₋₀ | 5±0.5 | 0.5 | 6±0.5 | 1.2 | 0 | 3.0 | 0.6 | 0.5 |
| | | T52 | 6.5±0.5 | 52±1.0 | 5±0.5 | 1.0 | 6±0.5 | 1.2 | 0 | 3.0 | 0.6 | 0.5 |
| MOF1/2W | MOF1WS | T52 | 9.0±1.0 | 52±1.0 | 5±0.5 | 1.0 | 6±0.5 | 1.2 | 0 | 3.0 | 0.6 | 0.5 |
| MOF1W | MOF2WS | T52 | 11.5±1.0 | 52±1.0 | 5±0.5 | 1.0 | 6±0.5 | 1.2 | 0 | 3.0 | 0.6 | 0.5 |
| | | T65 | 11.5±1.0 | 65±1.0 | 5±0.5 | 1.0 | 6±0.5 | 1.2 | 0 | 3.0 | 0.6 | 0.5 |
| MOF2W | MOF3WS | T52 | 15.5±1.0 | 52±1.0 | 10±0.5 | 1.0 | 6±0.5 | 1.2 | 0 | 3.0 | 0.6 | 0.5 |
| | | T73 | 15.5±1.0 | 73±1.0 | 10±0.5 | 1.0 | 6±0.5 | 1.2 | 0 | 3.0 | 0.6 | 0.5 |
| MOF3W | MOF5WS | T84 | 17.5±1.5 | 84±1.0 | 10±0.5 | 1.0 | 6±0.5 | 1.2 | 0 | 3.0 | 0.6 | 0.5 |
| MOF5W | | T84 | 24.5±1.5 | 84±1.0 | 10±0.5 | 1.0 | 6±0.5 | 1.2 | 0 | 3.0 | 0.6 | 0.5 |

| | | | | | |
|----------------------|----------------------------------------------------------|------------------------|----------------------------------|------------|-------|
| 公司名稱 Company Name | 千志電子科技(湖北)有限公司 CHIAN CHIA ELECTRONIC(HU BEI)CO.,LTD | | | | |
| 品名 Product Name | 不燃性金屬氧化皮膜電阻器 Metal Oxide Film Resistors(Nonflammable) | | | | |
| 版本 Version | A/0 版 | 制定日期 Enactment Date | 2016 年 05 月 30 日 May 30, 2016 | 頁數 Page | 13-10 |

5.3 MB 型&M 型&MK 型 MB Type &M Type& MK Type

MB

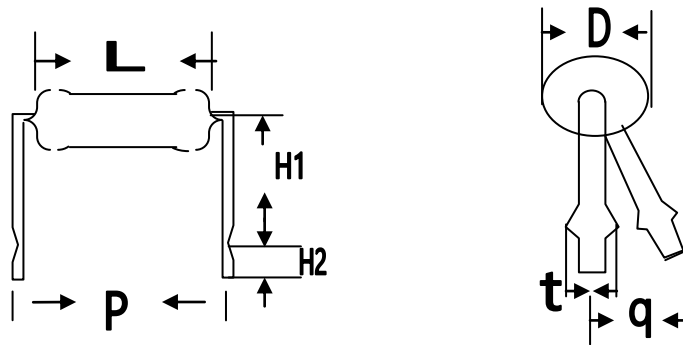

| 瓦特數 Watts | 尺寸 Dimensions (mm) | | | | | | |
|--------------|--------------------|-------------|-------------|--------------|--------------|--------------|------|
| | D | L \pm 1.0 | P \pm 1.0 | H1 \pm 1.0 | H2 \pm 0.5 | t \pm 0.15 | qMax |
| 1/2w,1ws | 3.2 \pm 0.5 | 9.0 | 12.5/15 | 10.5 | 4.5 | 1.2 | 3 |
| 1w,2ws | 4.5 \pm 1.0 | 11.5 | 15 | 10.5 | 4.5 | 1.25 | 3 |
| 2w,3ws | 5.0 \pm 1.0 | 15.5 | 20 | 10.5 | 4.5 | 1.25 | 3 |
| 3W5WS | 6.0 \pm 1.0 | 17.5 | 25 | 10.5 | 4.5 | 1.25 | 3 |
| 5W | 8.0 \pm 1.0 | 24.5 | 30 | 10.5 | 4.5 | 1.25 | 3 |

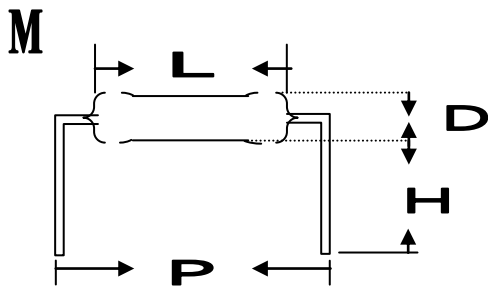

| 瓦特數 Watts | 尺寸 Dimensions (mm) | | | |
|--------------|--------------------|----------------|-------------|-------------|
| | Φ D | L | P \pm 1.0 | H \pm 1.0 |
| 1/8w,1/6w | 1.8 \pm 0.3 | 3.2 \pm 0.5 | 6 | 8 |
| 1/4w,1/2ws | 2.3 \pm 0.5 | 6.5 \pm 0.5 | 10 | 8 |
| 1/2w,1ws | 3.5 \pm 0.5 | 9.0 \pm 1.0 | 12.5/15 | 10 |
| 1w,2ws | 4.5 \pm 1.0 | 11.5 \pm 1.0 | 15 | 10 |
| 2w,3ws | 5.0 \pm 1.0 | 15.5 \pm 1.0 | 20 | 10 |
| 3w | 6.0 \pm 1.0 | 17.5 \pm 1.0 | 25 | 10 |
| 5w | 8.0 \pm 1.0 | 24.5 \pm 1.0 | 30 | 10 |

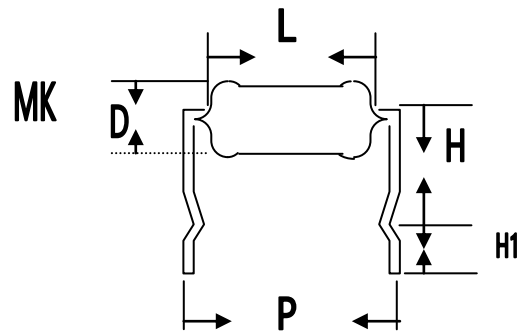

| 瓦特數 Watts | 尺寸 Dimensions (mm) | | | | |
|--------------|--------------------|-------------|-------------|-------------|--------------|
| | D | L \pm 1.0 | P \pm 1.0 | H \pm 1.0 | H1 \pm 1.0 |
| 1/2w,1ws | 3.2 \pm 0.5 | 9.0 | 12.5 | 10 | 4.5 |
| 1w,2ws | 4.5 \pm 1.0 | 11.5 | 15 | 10 | 4.5 |
| 2w,3ws | 5.0 \pm 1.0 | 15.5 | 20 | 10 | 4.5 |
| 3W5WS | 6.0 \pm 1.0 | 17.5 | 25 | 10 | 4.5 |

| | | | | | |
|----------------------|----------------------------------------------------------|------------------------|----------------------------------|------------|-------|
| 公司名稱 Company Name | 千志電子科技(湖北)有限公司 CHIAN CHIA ELECTRONIC(HU BEI)CO.,LTD | | | | |
| 品名 Product Name | 不燃性金屬氧化皮膜電阻器 Metal Oxide Film Resistors(Nonflammable) | | | | |
| 版本 Version | A/0 版 | 制定日期 Enactment Date | 2016 年 05 月 30 日 May 30, 2016 | 頁數 Page | 13-11 |

5.4 F 型&FK2 型& FKK 型 F Type &FK2Type&FKK Type

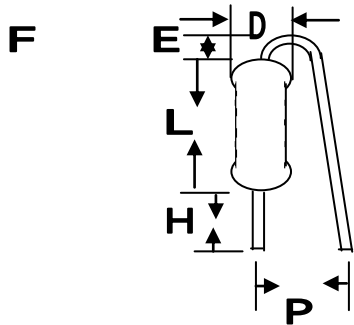

FK2

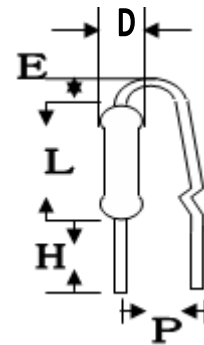

| 瓦特數 Watts | 尺寸 Dimensions (mm) | | | | |
|--------------|--------------------|-------------|-------------|-------|-------------|
| | ϕD | $L \pm 1.0$ | $P \pm 2.0$ | E Max | $H \pm 1.0$ |
| 1/2w,1ws | 3.2 ± 0.5 | 9.0 | 6 | 3.5 | 5-8 |
| 1w,2ws | 4.5 ± 1.0 | 11.5 | 8 | 3.5 | 5-8 |
| 2w,3ws | 5.0 ± 1.0 | 15.5 | 8 | 3.5 | 5-8 |
| 3w | 6.0 ± 1.0 | 17.5 | 8 | 3.5 | 5-8 |

| 瓦特數 Watts | 尺寸 Dimensions (mm) | | | | |
|--------------|--------------------|-------------|-------------|-------|-------------|
| | ϕD | $L \pm 1.0$ | $P \pm 2.0$ | E Max | $H \pm 1.0$ |
| 1/2w,1ws | 3.2 ± 0.5 | 9.0 | 6 | 3.5 | 5-8 |
| 1w,2ws | 4.5 ± 1.0 | 11.5 | 8 | 3.5 | 5-8 |
| 2w,3ws | 5.0 ± 1.0 | 15.5 | 8 | 3.5 | 5-8 |
| 3w | 6.0 ± 1.0 | 17.5 | 8 | 3.5 | 5-8 |

FKK

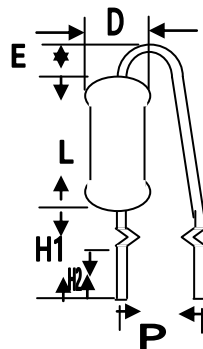

| 瓦特數 Watts | 尺寸 Dimensions(mm) | | | | | |
|--------------|-------------------|-------------|-------------|-------|--------------|--------------|
| | ϕD | $L \pm 1.0$ | $P \pm 1.0$ | E Max | $H1 \pm 1.0$ | $H2 \pm 1.0$ |
| 1/2w,1ws | 3.2 ± 0.5 | 9.0 | 5-7 | 3.5 | 8 | 4.5 |
| 1w,2ws | 4.5 ± 1.0 | 11.5 | 5-9 | 3.5 | 8 | 4.5 |
| 2w,3ws | 5.0 ± 1.0 | 15.5 | 5-9 | 3.5 | 8 | 4.5 |
| 3w | 6.0 ± 1.0 | 17.5 | 5-10 | 3.5 | 8 | 4.5 |

| | | | | | |
|----------------------|----------------------------------------------------------|------------------------|----------------------------------|------------|-------|
| 公司名稱 Company Name | 千志電子科技(湖北)有限公司 CHIAN CHIA ELECTRONIC(HU BEI)CO.,LTD | | | | |
| 品名 Product Name | 不燃性金屬氧化皮膜電阻器 Metal Oxide Film Resistors(Nonflammable) | | | | |
| 版本 Version | A/0 版 | 制定日期 Enactment Date | 2016 年 05 月 30 日 May 30, 2016 | 頁數 Page | 13-12 |

6 包裝 Package

6.1 帶裝品包裝 Tape in box packing (Ammo packing)

6.1.1 表示項目 Indication

- (1) 客戶品號 Customer Part No.
- (2) 製造品號 Manufacturer Part No.
- (3) 數量 Quantity
- (4) 製造者名 Manufacturer



6.1.2 包裝盒尺寸和數量

Packing box size and quantity

| 種類 Type | | 形狀 Form | 包裝數量 Quantity | 尺寸 Dimensions (mm) | | |
|-----------------|----------------|---------|---------------|--------------------|-----|-----|
| 普通型 Normal Size | 小型化 Small Size | | | L | W | H |
| MOF1/4W | MOF1/2WS | T26 | 5000 PCS | 260 | 50 | 100 |
| | | T52 | 5000 PCS | 260 | 80 | 100 |
| MOF1/2W | MOF1WS | T52 | 2000 PCS | 260 | 80 | 85 |
| MOF1W | MOF2WS | T52 | 1000 PCS | 260 | 80 | 85 |
| | | T65 | 1000 PCS | 260 | 90 | 92 |
| MOF2W | MOF3WS | T52 | 1000 PCS | 260 | 80 | 100 |
| | | T73 | 1000 PCS | 260 | 95 | 92 |
| MOF3W | MOF5WS | T86 | 500PCS | 260 | 110 | 75 |
| MOF5W | | T86 | 250PCS | 260 | 110 | 75 |

| | | | | | |
|----------------------|----------------------------------------------------------|------------------------|-----------------------------|------------|-------|
| 公司名稱 Company Name | 千志電子科技(湖北)有限公司 CHIAN CHIA ELECTRONIC(HU BEI)CO.,LTD | | | | |
| 品名 Product Name | 不燃性金屬氧化皮膜電阻器 Metal Oxide Film Resistors(Nonflammable) | | | | |
| 版本 Version | A/0 版 | 制定日期 Enactment Date | 2016年05月30日 May 30, 2016 | 頁數 Page | 13-13 |

6.2 散裝品包裝 Tape in box Bulk (Ammo Bulk)

6.2.1 表示項目 Indication

- (5) 客戶品號 Customer Part No.
- (6) 製造品號 Manufacturer Part No.
- (7) 數量 Quantity
- (8) 製造者名 Manufacturer



6.2.2 包裝盒尺寸和數量

Packing box size and quantity

| 種類 Type | | 形狀 Form | 包裝數量 Quantity | 尺寸 Dimensions (mm) | | |
|-----------------|----------------|-------------|---------------|--------------------|-----|----|
| 普通型 Normal Size | 小型化 Small Size | | | L | W | H |
| MOF1/4W | MOF1/2WS | P | 10000 PCS | 240 | 140 | 76 |
| | | 成型 Moulding | 10000 PCS | 240 | 140 | 76 |
| MOF1/2W | MOF1WS | P | 5000 PCS | 240 | 140 | 76 |
| | | 成型 Moulding | 5000 PCS | 240 | 140 | 76 |
| MOF1W | MOF2WS | P | 2000 PCS | 240 | 140 | 76 |
| | | 成型 Moulding | 2000 PCS | 240 | 140 | 76 |
| MOF2W | MOF3WS | P | 2000 PCS | 240 | 140 | 76 |
| | | 成型 Moulding | 2000 PCS | 240 | 140 | 76 |
| MOF3W | MOF5WS | P | 1000PCS | 240 | 140 | 76 |
| | | 成型 Moulding | 1000PCS | 240 | 140 | 76 |
| MOF5W | | P | 400PCS | 240 | 140 | 76 |
| | | 成型 Moulding | 400PCS | 240 | 140 | 76 |

X-ON Electronics

Largest Supplier of Electrical and Electronic Components

Click to view similar products for [Metal Oxide Resistors](#) category:

Click to view products by [Chian Chia](#) manufacturer:

Other Similar products are found below :

[009260C](#) [FA87/180R/5%](#) [ROX1SJ4R7](#) [R0229](#) [M012CT52R220J](#) [WK80922003900J5C00](#) [434529B](#) [WMO5S-100KJA05](#) [ROX1SJ12K](#)
[ROX1SJ270K](#) [054084X](#) [054211G](#) [054220E](#) [095734G](#) [RS02B887R0FE73](#) [RSS2W470RJTB](#) [RSS3470RJTB](#) [WK202070A1003JD500](#)
[ROX3SJR22](#) [WR404140A2208JFE00](#) [RSS551KJ](#) [RSS3150RJTB](#) [ROX5SJ39K](#) [MOSX1CT528R2R20F](#) [MHR0314SA207F70](#) [RSF-25JT-52-](#)
[120R](#) [RSF50SJT-52-330K](#) [RSF2WSJT-52-60R](#) [RSF-25JT-52-2M](#) [RSF50SJT-52-1M](#) [RSF100JT-52-360K](#) [RSF50SJT-52-22R](#) [RSF50SJT-52-](#)
[15R](#) [RSF200JT-73-280R](#) [RSF50SJT-52-0R5](#) [RSF-25JT-52-1M2](#) [RSF200JT-73-0R2](#) [RSF-50JT-52-2K5](#) [MO1W-150R±5%-TT63](#) [MO3W-](#)
[200R±5%-9T73](#) [ROX2SJ4K3](#) [ROX5SJ120R](#) [ROX3SJR10](#) [ROX2SJ200K](#) [CPF2200R00JKRE6](#) [LVR01R0200FE73](#) [HR1206J47RP05](#)
[HR1206J1MP05](#) [HR1206F430KP05](#) [HR1206F680KP05](#)