



千志電子
Chian-Chia

客 戶:

(CUSTOMER)

發行日期:

PUBLISH DATE

年 月 日

year month day

承 認 書

(APPROVAL SHEET)

名 稱: 高壓金屬玻璃釉電阻器

(DESCRIPTION) Metal Glaze (High Voltage) Resistor

貴公司料號碼: _____

(CUSTOMER TYPE NO)

承認 APPROVED BY

千 志 電 子 (深 圳) 有 限 公 司
CHIAN CHIA ELECTRONIC(SHENZHEN)CO.,LTD

千 志 電 子 科 技 (湖 北) 有 限 公 司
CHIAN CHIA ELECTRONIC(HU BEI)CO.,LTD

湖北工厂:湖北省孝感市孝南区汉十工业园
HANSHI LINDUSTRY XIAOGANG TOWN SOUTH AREA XIAOGAN CITY HUBEI PROVINCE

TEL:86-712-2610128

FAX:86-712-2610235

Http:www.cco-chianchia.com

E-mail:ccoserve@cco-chianchia.com

公司名稱 Company Name	千志電子科技(湖北)有限公司 CHIAN CHIA ELECTRONIC(HU BEI)CO.,LTD				
品名 Product Name	高壓金屬玻璃釉電阻器 Metal Glaze (High Voltage) Resistor				
版本 Version	A/0 版	制定日期 Enactment Date	2016年05月30日 May 30, 2016	頁數 Page	13-1

1. 一般事項 General

1.1 適用 Scope

本承認書適用於 千志電子科技(湖北)有限公司 製造之[高壓金屬玻璃釉電阻器], 符合環境關聯物質要求之 RoHS 測試。

This specification is available for **Metal Glaze (High Voltage)** Resistor manufactured by CHIAN CHIA ELECTRONIC(HU BEI)CO.,LTD, it accords with RoHS test of Environment related substance requirement.

1.2 形名(例) Type designation (example)

依使用種類、額定電力、公稱電阻值、容許誤差及型狀而區別,其構造如下。

The type designation shall be in the following form and as specified.

MG	1/2 W	100K	J	T52
種類 Type	額定電力 Rated power	公稱電阻值 Nominal resistance value	電阻值容許誤差 Resistance tolerance	形狀 Form
	1/4W	E-24 Series	J ±5%	P 型 P Type
	1/2W	E-96 Series	G ± 2%	M 型 M Type
	1W		F ±1%	MB 型 MB Type
	2W			FK1 型 FK1Type
				FK2 型 FK2 Type
				FKK 型 FKK Type

1.3 額定電力 Rated power

額定電力係應在周圍溫度 70°C 可以連續負載的最大電力, 如表-1;但周圍溫度如超過 70°C 時之額定電力則依圖一的電力遞減曲線實施。

Rated power is maximum power which can be continuously loaded at specified ambient temperature 70°C, as Table-1; however when the ambient temperature exceeds 70°C, rated power should be determined from the derating curve of Fig.1.

公司名稱 Company Name	千志電子科技(湖北)有限公司 CHIAN CHIA ELECTRONIC(HU BEI)CO.,LTD				
品名 Product Name	高壓金屬玻璃釉電阻器 Metal Glaze (High Voltage) Resistor				
版本 Version	A/0 版	制定日期 Enactment Date	2016年05月30日 May 30, 2016	頁數 Page	13-2

表-1 Table-1

種類 Type	定格電力 Rated power	最大工作電壓 Max Working Voltage	最大負荷電壓 Max Overload Voltage	絕緣耐電壓 Dielectric withstanding voltage	衝擊耐壓 Surge Withstanding Voltage	阻值範圍(Ω) Resistance Range(Ω)
MG1/4W	0.25W	500V	700V	500V	100KΩ~1MΩ 3000V	100KΩ~39MΩ
					1.1MΩ~6.2MΩ 4000V	
					6.8MΩ~39MΩ 6000V	
MG1/2W	0.5W	700V	1000V	700V	100KΩ~1MΩ 4000V	100KΩ~39MΩ
					1.1MΩ~6.2MΩ 5000V	
					6.8MΩ~39MΩ 8000V	
MG1W	1W	1000V	1400V	1000V	100KΩ~1MΩ 5000V	100KΩ~39MΩ
					1.1MΩ~6.2MΩ 6000V	
					6.8MΩ~39MΩ 9000V	
MG2W	2W	1000V	1400V	1000V	100KΩ~1MΩ 8000V	100KΩ~39MΩ
					1.1MΩ~6.2MΩ 9000V	
					6.8MΩ~39MΩ 10000V	

圖一 電力遞減曲線 Figure 1 Power derating curve

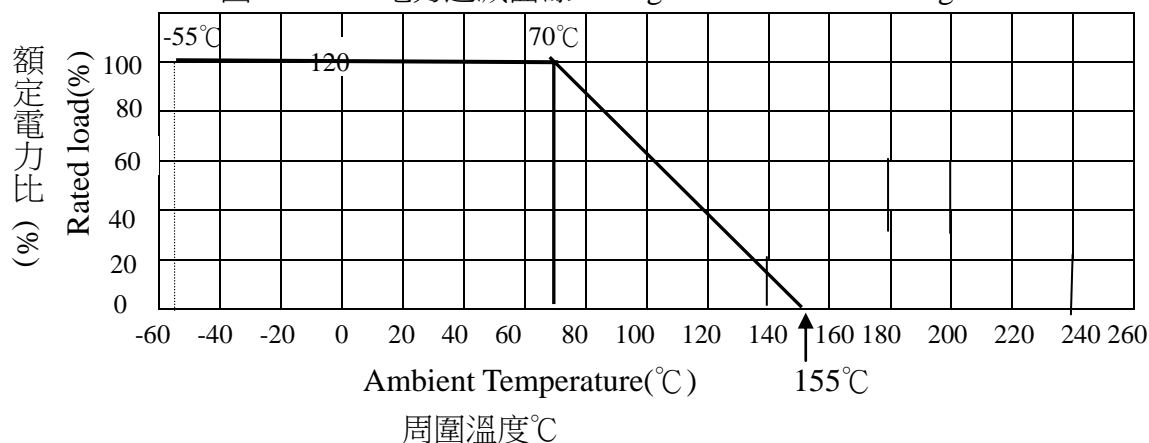

1.4 額定電壓 Rated voltage

額定電壓係指對應於額定電力的直流或交流(商用頻率之有效值)的電壓,由下式求得。

The rated voltage shall be the D.C. or A.C.(R.M.S. at power frequency) voltage which corresponds the rated power and the value of which is calculated from the formula below.

$$E = \sqrt{P \times R}$$

Where E: 定格電壓 Rated voltage(V)
P: 定格電力 Rated power(W)
R: 公稱電阻值 Nominal resistance(Ω)

使用溫度 Operating Temperature Range: -55°C ~ +155°C

公司名稱 Company Name	千志电子科技(湖北)有限公司 CHIAN CHIA ELECTRONIC(HU BEI)CO.,LTD				
品名 Product Name	高壓金屬玻璃釉電阻器 Metal Glaze (High Voltage) Resistor				
版本 Version	A/0 版	制定日期 Enactment Date	2016 年 05 月 30 日 May 30, 2016	頁數 Page	13-3

2. 構造 Construction

2.1 外形尺寸 External dimensions

參照本承認書的 [5. 外形尺寸]。

The dimensions shall be satisfied with [5. External dimensions].

2.2 構造圖 Structure diagram

MG 系列之高壓金屬玻璃釉電阻器係按下表的材料而構成:

The construction of resistor (MG series) shall be as follows:

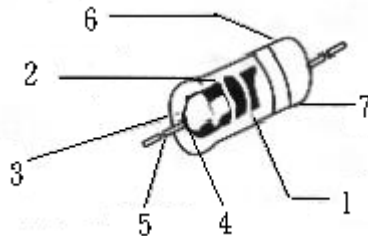

號碼 NO	構造名稱 Item	內容 Material
1	基體磁器 Ceramic core	使用高含鋁量的磁器棒。 High alumina ceramic is used.
2	電阻體 Resistor element	電阻體的成份係使用高壓金屬玻璃釉。 The resistor element shall consist of Metal Glaze.
3	端子 Terminal	鐵帽 Tinned iron cap.
4	連接 Connection	導線對鐵帽須以電氣熔接。 The lead wire, which is plated with solder, shall be mounted to the caps by welding process.
5	導線 Lead wire	焊錫或鍍錫的導線。 Soldered or tinned annealed wire.
6	上塗塗裝 Finishing painting	使用矽樹脂塗料。符合 UL-94V-0 不燃性規定。 Silicon resin is used. Accord with UL-94V-0 Nonflammable specification.
7	表示 Indication	色碼。 Color code.

公司名稱 Company Name	千志电子科技(湖北)有限公司 CHIAN CHIA ELECTRONIC(HU BEI)CO.,LTD				
品名 Product Name	高壓金屬玻璃釉電阻器 Metal Glaze (High Voltage) Resistor				
版本 Version	A/0 版	制定日期 Enactment Date	2016 年 05 月 30 日 May 30, 2016	頁數 Page	13-4

2.3 鐵帽端子 Terminal caps

鐵帽端子須確實地連接(電氣的及機械的)於電阻體上。

The caps shall be securely connected with the resistor element electrically and mechanically.

2.4 外裝色澤 Resistor body color

以‘灰色’表示。

The type in ‘Gray’ color.

2.5 表示 Indication

參照本承認書的 [4. 表示]。

The indication shall be satisfied with [4. Indication].

3. 特性 Characteristics

表-2 Table-2

項目 Item	規格值 Performance	試驗方法(依據 JIS C 5202) Test methods(Conform to JIS C 5202)
溫度係數 Temperature Coefficient	±250PPM/°C	5.2 項參照 Comply with 5.2 $\frac{R_1 - R_0}{R_0(T_1 - T_0)} \times 10^6 (\text{PPM}/^\circ\text{C})$ R ₀ :室溫(T ₀)所測量之電阻值。 R ₁ :室溫+100°C(T ₁)後所測量之電阻值。 R ₀ :Resistance value at room temp.(T ₀). R ₁ :Resistance value at room temp.plus 100°C(T ₁)
短時間過負荷 Short time overload	±(1%+0.05Ω)以內。 不得有機械的損傷。 Within ±(1%+0.05Ω). No evidence of mechanical damage.	5.5 項參照 Comply with 5.5 額定電壓×2.5 倍,5 秒。 不可超過最高過負荷電壓(見表-1) Rated voltage×2.5 times,5s But not to exceed maximum overload voltage. (See table-1)
絕緣電阻 Insulation Resistance	10 ⁴ MΩ 以上。 10 ⁴ MΩ or more.	5.6 項參照 Comply with 5.6 置於 V 型槽方法。V-block method 施加直流電壓 500V 60 秒。 Resistor shall be tested at DC 500V for 60 seconds.
焊錫附著性 Solderability	導線至少 95%以上新錫覆蓋。 Covered with new solder by 95% at least.	6.5 項參照 Comply with 6.5 焊錫溫度：255±5°C。 浸錫時間：3±1.0 秒。 Test temperature of solder: 255±5°C Dipping time in solder:3±1.0 s

公司名稱 Company Name	千志电子科技(湖北)有限公司 CHIAN CHIA ELECTRONIC(HU BEI)CO.,LTD				
品名 Product Name	高壓金屬玻璃釉電阻器 Metal Glaze (High Voltage) Resistor				
版本	A/0 版	制定日期	2016 年 05 月 30 日	頁數	13-5

Version		Enactment Date	May 30, 2016	Page	
項目 Item	規格值 Performance	試驗方法(依據 JIS C 5202) Test methods(Conform to JIS C 5202)			
耐電壓 Dielectric Withstanding Voltage	無電弧放電、燒損及絕緣破壞等異狀。 No evidence of flashover mechanical damage, arcing or insulation breakdown.	5.7 項參照 Comply with 5.7 常壓, 置於 V 型槽方法。 施加個別規定之交流電壓 60 秒。(見表-1) Constant pressure, V-block method Resistor shall be tested at AC potential respectively for 60 seconds. (See table-1)			
斷續過負荷 Pulse overload	$\pm(3\%+0.05\Omega)$ 以內。 within $\pm(3\%+0.05\Omega)$	5.8 項參照 Comply with 5.8 額定電壓 X 4 倍, 10000 回(1 秒 ON, 25 秒 OFF)。 不可超過最高斷續電壓(見表-1) Rated voltage X 4 times, 10000 cyc.(1s ON, 25s OFF) But not to exceed maximum pulse voltage.(See table-1)			
端子強度 Terminal strength	端子不得斷裂及鬆弛。 No evidence of mechanical damage.	6.1 項參照 Comply with 6.1			
		引張強度 Tensile strength	線徑 mm Diameter	引張力 Tensile force N(kgf)	時間 Time
		$\Phi 0.38\text{mm}\sim 0.50\text{mm}$	5(0.51)	10 \pm 1 second	
		$\Phi 0.50\text{mm}\sim 0.70\text{mm}$	10(1.02)		
		扭轉強度：自電阻體起約 6mm~6.5mm 處之端子線, 以約 0.75mm 曲率半徑彎曲 90 度, 其次由彎曲處向端子線先端 1.2 \pm 0.4mm 處挾定端子引出軸, 作回轉軸, 以約 5 秒時間沿直面回轉 360°再逆轉 360°, 如此施行回逆轉 2 次, 不可發生折斷及鬆動現象。 Torsional strength : To bend the lead wire at the point of about 6mm~6.5mm from resistor body. about 0.75mm curvature radii to 90° then catch the wire at 1.2 \pm 0.4mm apart from the bend point end and turn it (clockwise) by 360 degrees perpendicular to the resistor axis at speed of same 5 seconds per turn, and do the same counterclockwise again which constitute a whole turn. Repeat the turn for 2 times without causing any break and looseness.			
焊錫耐熱性 Resistance to soldering heat	$\pm(1\%+0.05\Omega)$ 以內。 不得有機械的損傷。 Within $\pm(1\%+0.05\Omega)$ No evidence of mechanical damage.	6.4 項參照 Comply with 6.4 350 \pm 10°C, 3 \pm 1 秒, 試驗後放置半小時。 350 \pm 10°C, 3 \pm 1s After test leave for 0.5h.			
公司名稱 Company Name	千志電子科技(湖北)有限公司 CHIAN CHIA ELECTRONIC(HU BEI)CO.,LTD				
品名 Product Name	高壓金屬玻璃釉電阻器 Metal Glaze (High Voltage) Resistor				

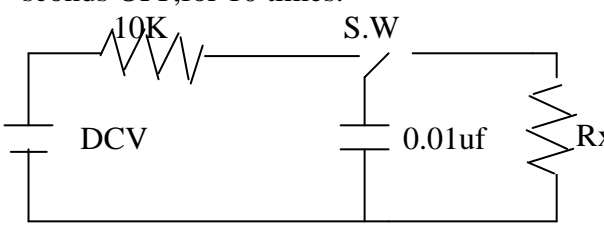
版本 Version	A/0 版	制定日期 Enactment Date	2016 年 05 月 30 日 May 30, 2016	頁數 Page	13-6
項目 Item	規格值 Performance	試驗方法(依據 JIS C 5202) Test methods(Conform to JIS C 5202)			
耐溶劑性 Resistance to solvent	塗裝及色碼不得脫落。 No deterioration of protective coating and markings.	6.9 項參照 Comply with 6.9 放入酒精溶劑之超音波機內，保持 3 分鐘。 Specimens shall be immersed in a bath of isoproalcohol completely for 3 minutes with ultrasonic.			
溫度循環 Temperature cycle	±(1%+0.05Ω)以內。 不得有機械的損傷。 Within ±(1%+0.05Ω) No evidence of mechanical damage.	7.4 項參照 Comply with 7.4 低溫側：-55°C/30 分，室溫：10~15 分鐘 高溫側：+80°C/30 分，室溫：10~15 分鐘 5 回 Low side : -55°C/30min, Room temp. : 10 to 15min High side : 80°C/30min, Room temp. : 10 to 15min 5 cycles			
耐濕負荷壽命 Load life in humidity	±(5%+0.1Ω)以內。 Within ±(5%+0.1Ω)	7.9 項參照 Comply with 7.9 40±2°C，濕度 90~95%，1000 小時 定格電壓(90 分鐘 ON, 30 分鐘 OFF) 40±2°C，90 to 95%RH, 1000h Rated voltage (90 min ON, 30 min OFF)			
負荷壽命 Load life	±(5%+0.1Ω)以內。 Within ±(5%+0.1Ω)	7.10 項參照 Comply with 7.10 70±3°C，1000 小時 定格電壓(90 分鐘 ON, 30 分鐘 OFF) 70±3°C，1000h Rated voltage (90 min ON, 30 min OFF)			
衝擊耐壓 Surge Withstanding Voltage	無燒損或絕緣性破壞 No flashover or Insulation damage.	加入適當電壓 2.5 秒 ON,2.5 秒 OFF.循環 10 次 Add to suitable voltage 2.5 seconds ON,2.5 sconds OFF,for 10 times. 			

公司名稱 Company Name	千志电子科技(湖北)有限公司 CHIAN CHIA ELECTRONIC(HU BEI)CO.,LTD
品名 Product Name	高壓金屬玻璃釉電阻器 Metal Glaze (High Voltage) Resistor

4. 表示 Indication

色碼 Color Code

(因±5%金色塗料是銅製的.會破壞玻璃釉皮膜.故高壓電阻誤差±5%—色環改為黃色)

(The ±5% gold paint is made of copper. It shall destroyed Metal Glaze. So the Metal Glaze ((High Voltage)) Resistor ±5% tolerance color code is changed yellow color.)

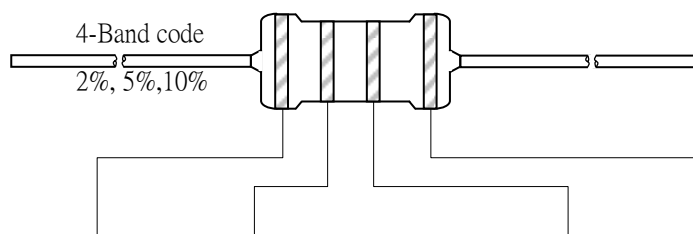

顏色 Color	第 1 數字 1 st figure	第 2 數字 2 nd figure	第 3 數字 3 rd figure	倍 率 Multiplier	誤差率 Tolerance
黑 Black	0	0	0	10 ⁰	
棕 Brown	1	1	1	10 ¹	±1% (F)
紅 Red	2	2	2	10 ²	±2% (G)
橙 Orange	3	3	3	10 ³	
黃 Yellow	4	4	4	10 ⁴	±5% (J)
綠 Green	5	5	5	10 ⁵	±0.5% (D)
藍 Blue	6	6	6	10 ⁶	±0.25% (C)
紫 Violet	7	7	7	10 ⁷	±0.1% (B)
灰 Gray	8	8	8		±0.05% (A)
白 White	9	9	9		
金 Gold				10 ⁻¹	
銀 Silver				10 ⁻²	±10% (K)
無 Plain					±20% (M)

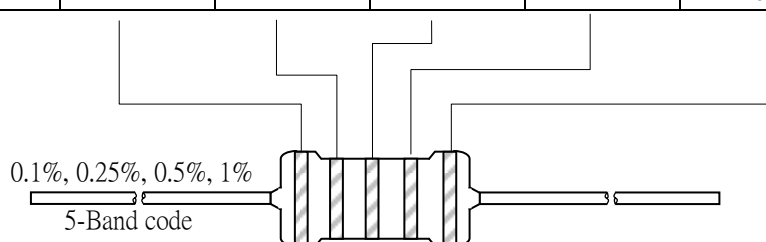

公司名稱 Company Name	千志电子科技(湖北)有限公司 CHIAN CHIA ELECTRONIC(HU BEI)CO.,LTD
品 名 Product Name	高壓金屬玻璃釉電阻器 Metal Glaze (High Voltage) Resistor

5. 外形寸法 External dimensions

5.1 散裝 P 型 P type

P Type

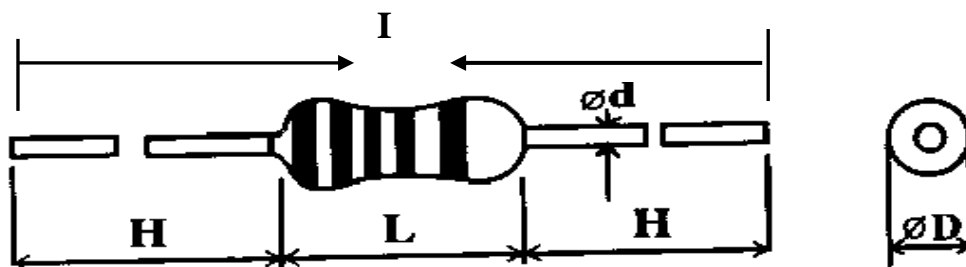

單位：mm

Unit：mm

額定功率 Power Rating	尺 寸 Dimensions				
	I±2.0	L±1.0	ψ D	ψ d±0.05	H±2.0
MG1/4W	60	6.5	2.3±0.5	0.45	28
MG1/2W	60	9.0	3.2±0.5	0.50	28
MG1W	60	11.5	4.5±1.0	0.70	25
	81	11.5	4.5±1.0	0.70	35
	94	11.5	4.5±1.0	0.70	42
MG2W	60	15.5	5.0±1.0	0.70	23
	81	15.5	5.0±1.0	0.70	33
	94	15.5	5.0±1.0	0.70	40

公司名稱

Company Name

千志电子科技(湖北)有限公司

CHIAN CHIA ELECTRONIC(HU BEI)CO.,LTD

品 名

Product Name

高壓金屬玻璃釉電阻器

Metal Glaze (High Voltage) Resistor

5.2 帶裝 Axial Lead Taping

Txx Type

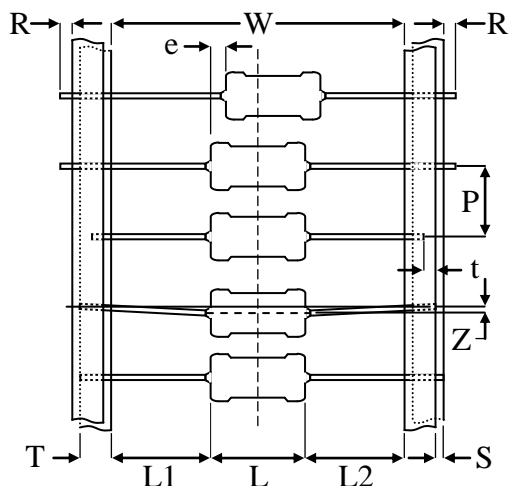

單位：mm
Unit：mm

額定功率 Power Rating	帶狀 Taping	尺寸 Dimensions									
		L	W	P	L1-L2 Max.	T	Z Max.	R Max.	t Max.	e Max.	S Max.
MG1/4W	T26	6.5±0.5	26 ⁺¹ ₋₀	5±0.5	0.5	6±0.5	1.2	0	3.0	0.6	0.5
	T52	6.5±0.5	52±1.0	5±0.5	1.0	6±0.5	1.2	0	3.0	0.6	0.5
MG1/2W	T52	9.0±1.0	52±1.0	5±0.5	1.0	6±0.5	1.2	0	3.0	0.6	0.5
MG1W	T52	11.5±1.0	52±1.0	5±0.5	1.0	6±0.5	1.2	0	3.0	0.6	0.5
	T66	11.5±1.0	66±1.0	5±0.5	1.0	6±0.5	1.2	0	3.0	0.6	0.5
MG2W	T52	15.5±1.0	52±1.0	10±0.5	1.0	6±0.5	1.2	0	3.0	0.6	0.5
	T73	15.5±1.0	73±1.0	10±0.5	1.0	6±0.5	1.2	0	3.0	0.6	0.5
	T84	15.5±1.0	84±1.0	10±0.5	1.0	6±0.5	1.2	0	3.0	0.6	0.5

公司名稱 Company Name	千志电子科技(湖北)有限公司 CHIAN CHIA ELECTRONIC(HU BEI)CO.,LTD
品名 Product Name	高壓金屬玻璃釉電阻器 Metal Glaze (High Voltage) Resistor

5.3 MB 型&M 型&MK 型 MB Type &M Type& MK Type

MB

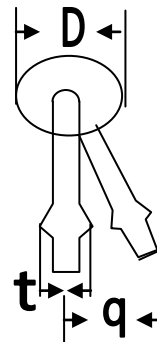
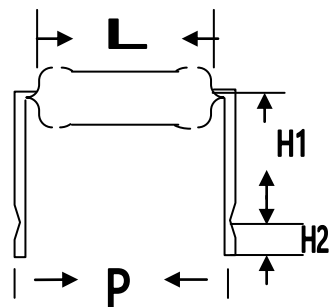

瓦特數 Watts	尺寸 Dimensions (mm)							
	D	L±1.0	P±1.0	H1±1.0	H2±0.5	d±0.05	t±0.15	qMax
1/2w	3.2±0.5	9.0	12.5/15	10.5	4.5	0.50	1.2	3
1w	4.5±1.0	11.5	15	10.5	4.5	0.70	1.25	3
2w	5.0±1.0	15.5	20	10.5	4.5	0.70	1.25	3

M

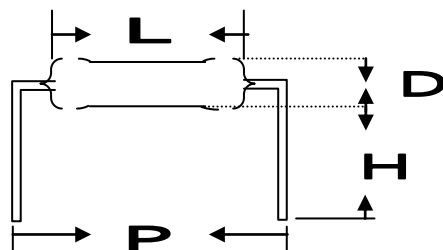

MK

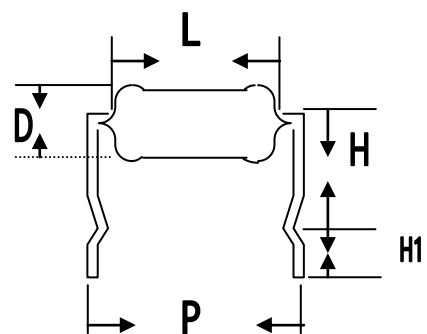

瓦特數 Watts	尺寸 Dimensions (mm)			
	ΦD	L±1.0	P±1.0	H±1.0
1/2w	3.5±0.5	9.0	12.5/15	10
1w	4.5±1.0	11.5	15	10
2w	5.0±1.0	15.5	20	10

瓦特數 Watts	尺寸 Dimensions (mm)				
	D	L±1.0	P±1.0	H±1.0	H1±1.0
1/2w	3.2±0.5	9.0	12.5	10	4.5
1w	4.5±1.0	11.5	15	10	4.5
2w	5.0±1.0	15.5	20	10	4.5

公司名稱
Company Name

千志电子科技(湖北)有限公司
CHIAN CHIA ELECTRONIC(HU BEI)CO.,LTD

品名
Product Name

高壓金屬玻璃釉電阻器
Metal Glaze (High Voltage) Resistor

5.4 F 型&FK2 型& FKK 型 F Type &FK2Type&FKK Type

F

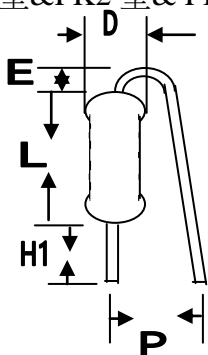

FK2

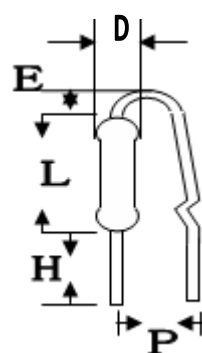

瓦特數 Watts	尺寸 Dimensions (mm)				
	φD	L±1.0	P±2.0	E Max	H±1.0
1/2w,1ws	3.2±0.5	9.0	6	3.5	5-8
1w,2ws	4.5±1.0	11.5	8	3.5	5-8
2w,3ws	5.0±1.0	15.5	8	3.5	5-8

瓦特數 Watts	尺寸 Dimensions (mm)				
	φD	L±1.0	P±2.0	E Max	H±1.0
1/2w	3.2±0.5	9.0	6	3.5	5-8
1w	4.5±1.0	11.5	8	3.5	5-8
2w	5.0±1.0	15.5	8	3.5	5-8

FKK

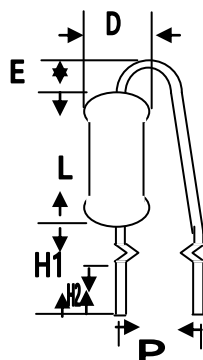

瓦特數 Watts	尺寸 Dimensions(mm)					
	φD	L±1.0	P±1.0	E Max	H1±1.0	H2±1.0
1/2w	3.2±0.5	9.0	5-7	3.5	8	4.5
1w	4.5±1.0	11.5	5-9	3.5	8	4.5
2w	5.0±1.0	15.5	5-9	3.5	8	4.5

公司名稱
Company Name

千志电子科技(湖北)有限公司
CHIAN CHIA ELECTRONIC(HU BEI)CO.,LTD

品名
Product Name

高壓金屬玻璃釉電阻器
Metal Glaze (High Voltage) Resistor

版本 Version	A/0 版	制定日期 Enactment Date	2016 年 05 月 30 日 May 30, 2016	頁數 Page	13-12
---------------	-------	------------------------	----------------------------------	------------	-------

6 包裝 Package

6.1 帶裝品包裝 Tape in box packing (Ammo packing)

6.1.1 表示項目 Indication

- (1) 客戶品號 Customer Part No.
- (2) 製造品號 Manufacturer Part No.
- (3) 數量 Quantity
- (4) 製造者名 Manufacturer

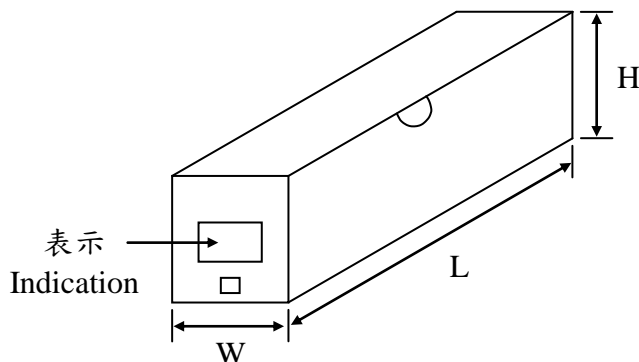

6.1.2 包裝盒尺寸和數量

Packing box size and quantity

種類 Type	形狀 Form	包裝數量 Quantity	尺寸 Dimensions (mm)		
			L	W	H
MG1/4W	T26	5000 PCS	260	50	100
	T52	5000 PCS	260	80	100
MG1/2W	T52	2000 PCS	260	80	85
MG1W	T52	1000 PCS	260	80	85
	T73	1000 PCS	260	95	92
MG2W	T52	1000 PCS	260	80	100
	T73	1000 PCS	260	95	92

公司名稱 Company Name	千志电子科技(湖北)有限公司 CHIAN CHIA ELECTRONIC(HU BEI)CO.,LTD
品名 Product Name	高壓金屬玻璃釉電阻器 Metal Glaze (High Voltage) Resistor

版本 Version	A/0 版	制定日期 Enactment Date	2016 年 05 月 30 日 May 30, 2016	頁數 Page	13-13
---------------	-------	------------------------	----------------------------------	------------	-------

6.2 散裝品包裝 Tape in box Bulk (Ammo Bulk)

6.2.1 表示項目 Indication

- (5) 客戶品號 Customer Part No.
- (6) 製造品號 Manufacturer Part No.
- (7) 數量 Quantity
- (8) 製造者名 Manufacturer

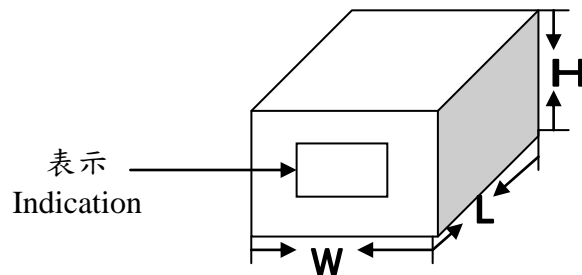

6.2.2 包裝盒尺寸和數量

Packing box size and quantity

種類 Type	形狀 Form	包裝數量 Quantity	尺寸 Dimensions (mm)		
			L	W	H
MG1/4W	P	10000 PCS	240	140	76
	成型 Moulding	10000 PCS	240	140	76
MG1/2W	P	5000 PCS	240	140	76
	成型 Moulding	5000 PCS	240	140	76
MG1W	P	2000 PCS	240	140	76
	成型 Moulding	2000 PCS	240	140	76
MG2W	P	2000 PCS	240	140	76
	成型 Moulding	2000 PCS	240	140	76

X-ON Electronics

Largest Supplier of Electrical and Electronic Components

Click to view similar products for [Metal Film Resistors - Through Hole](#) category:

Click to view products by [Chian Chia](#) manufacturer:

Other Similar products are found below :

[FRN25J330R](#) [FRN50J1R0S](#) [H4100RBYA](#) [H415RBZA](#) [H41K1BYA](#) [H41K5BYA](#) [H41M0BDA](#) [H420R5BCA](#) [H421R5BZA](#) [H4221RBYA](#)
[H424K3BDA](#) [H442K2BDA](#) [H45K62BZA](#) [H4634RBZA](#) [H473R2BZA](#) [H4931KBZA](#) [H8160KFDA](#) [H8274KBZA](#) [H82K0FDA](#) [H82K0FZA](#)
[H87K5DYA](#) [RLR05C1501GPB14](#) [RLR05C6201GS](#) [RLR20C3240FRB14](#) [RLR20C51R0GMB14](#) [RLR32C7R50FMB14](#) [RNC55H4642FPB14](#)
[HR01623J](#) [HR01682J](#) [270-1.69M-RC](#) [LR0204F110R](#) [LR0204F18R](#) [LR0204F20K](#) [LR0204F20R](#) [LR0204F510R](#) [LR1F121R](#) [LR1F133K](#)
[LR1F383R](#) [LR1F3K01](#) [LR1F4K75](#) [LR2F330RJIT](#) [LR2F51R](#) [LR2F910R](#) [ERX-2SZJR20E](#) [SQMR74K7J](#) [FMF-25FTF52-100K](#)
[FRN50J100RS](#) [FRN50J470RS](#) [H4100RBZA](#) [H414R3BZA](#)