

Chip Bead

ABPY Series ISO9001 | ISO14001 | IATF16949



■ Part Numbering

A	BPY	00	100505	300	Y	00
Grade	Series Name	Control Code	Dimensions Code (mm)	Impedance (Ω)	Tolerance	Internal Code
			100505 1.0x0.5x0.5	300 30	Y ±25%	
			160808 1.6x0.8x0.8	121 120		
			201209 2.0x1.25x0.9	102 1000		
			321611 3.2x1.6x1.1			

This specification applies to Multilayer Chip ferrite Bead for Automotive Electronics based on AEC-Q200 except for Power train and Safety.

ABPY00100505 Type

■ Dimensions

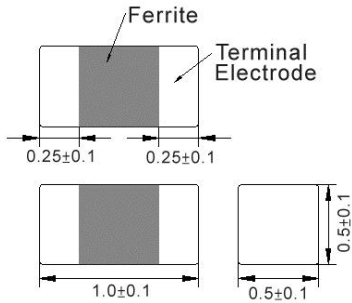

unit:mm

■ Recommended Land Pattern

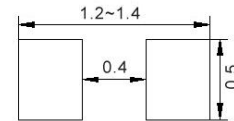

unit:mm

■ Electrical Characteristics

Part No.	Impedance (Ω)	Test Freq.	RDC (Ω)Max.	Rated Current (mA)Max.
ABPY00100505100Y00	10	100 MHz,200 mV	0.030	2000
ABPY00100505300Y00	30	100 MHz,200 mV	0.050	1700
ABPY00100505600Y00	60	100 MHz,200 mV	0.075	1500
ABPY00100505121Y00	120	100 MHz,200 mV	0.090	1400
ABPY00100505181Y00	180	100 MHz,200 mV	0.140	900
ABPY00100505221Y00	220	100 MHz,200 mV	0.180	1100
ABPY00100505601Y00	600	100 MHz,200 mV	0.340	700
ABPY00100505102Y00	1000	100 MHz,200 mV	0.490	500

Note: When ordering, please specify tolerance code. Tolerance: Y=±25%

1. Operating temperature range - 55°C ~ 125°C
2. Rate Current : Applied the current to coils, the temperature rise shall not be more than 30°C
3. Measure Equipment:
Z: HP4291A
RDC: HP4338B or CHEN HWA 502

ABPY00100505 Type

Characteristics Graph

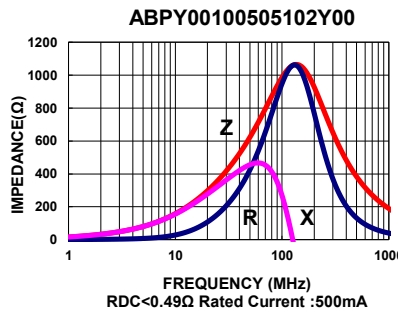
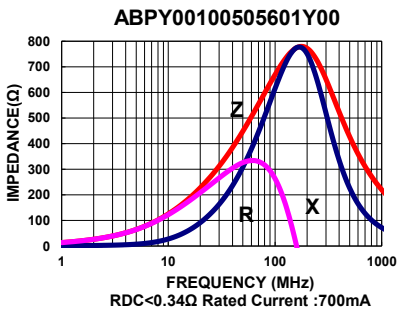
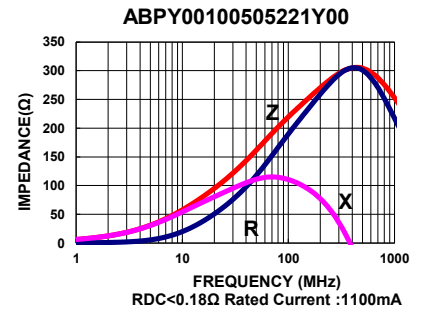
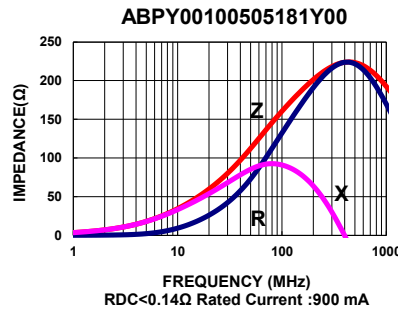
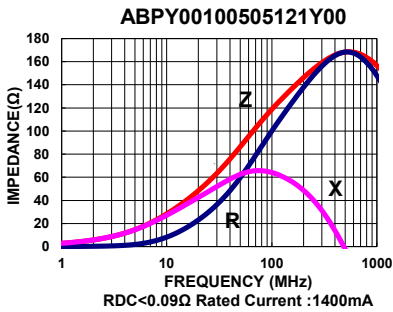
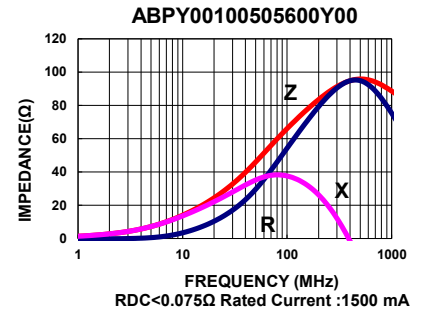
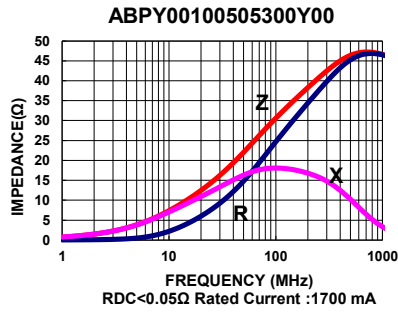
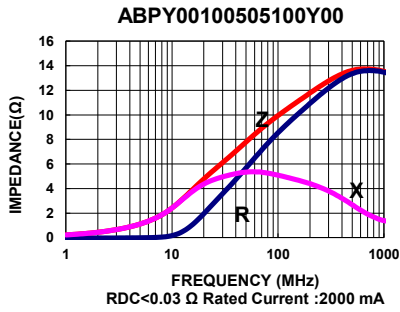

ABPY00160808 Type

■ Dimensions

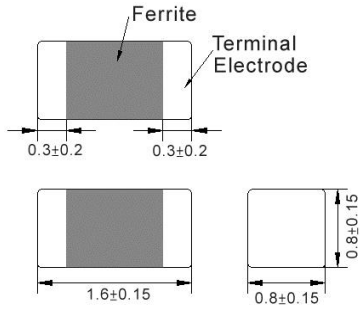

unit:mm

■ Recommended Land Pattern

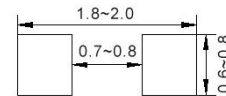

unit:mm

■ Electrical Characteristics

Part No.	Impedance (Ω)	Test Freq.	RDC (Ω)Max.	Rated Current (mA)Max.
ABPY00160808100Y00	10	100 MHz, 200 mV	0.020	4000
ABPY00160808300Y00	30	100 MHz, 200 mV	0.030	3000
ABPY00160808600Y00	60	100 MHz, 200 mV	0.040	3000
ABPY00160808800Y00	80	100 MHz, 200 mV	0.050	2500
ABPY00160808121Y00	120	100 MHz, 200 mV	0.080	2500
ABPY00160808181Y00	180	100 MHz, 200 mV	0.090	2000
ABPY00160808221Y00	220	100 MHz, 200 mV	0.100	2000
ABPY00160808301Y00	300	100 MHz, 200 mV	0.120	1500
ABPY00160808471Y00	470	100 MHz, 200 mV	0.150	1500
ABPY00160808601Y00	600	100 MHz, 200 mV	0.200	1000
ABPY00160808102Y00	1000	100 MHz, 200 mV	0.250	800

Note: When ordering, please specify tolerance code. Tolerance: Y=±25%

1. Operating temperature range - 55°C ~ 125°C
2. Rate Current : Applied the current to coils, the temperature rise shall not be more than 30°C
3. Measure Equipment:
Z: HP4291A
RDC: HP4338B or CHEN HWA 502

ABPY00160808 Type

Characteristics Graph

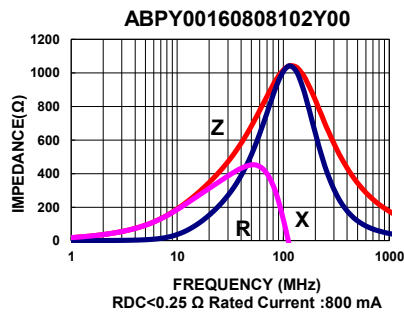
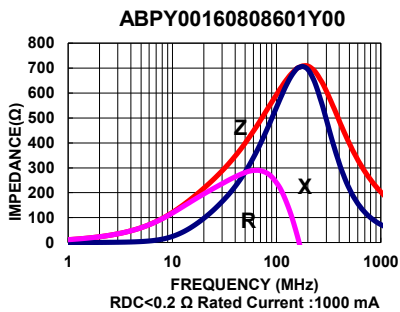
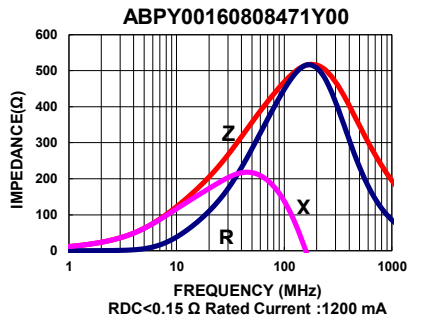
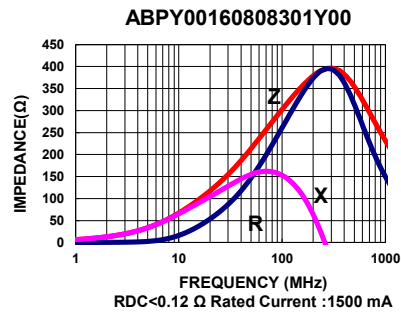
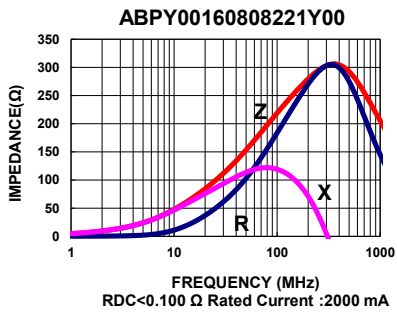
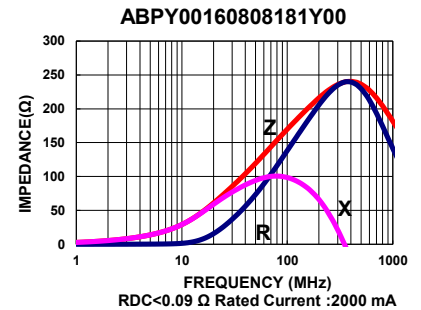
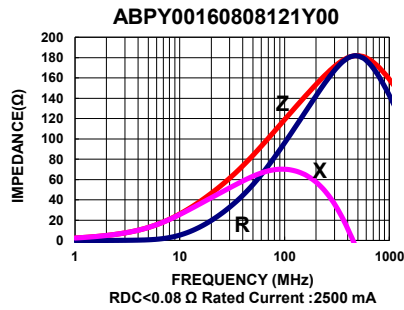
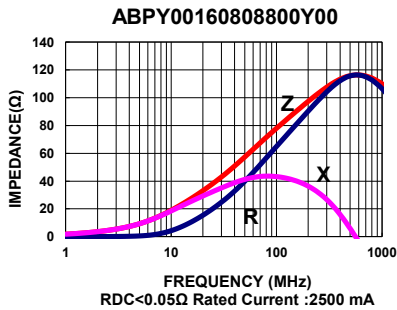
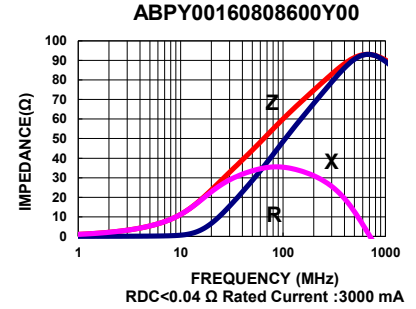
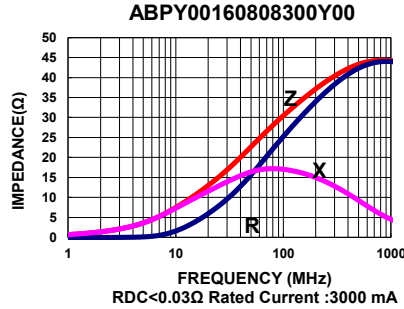
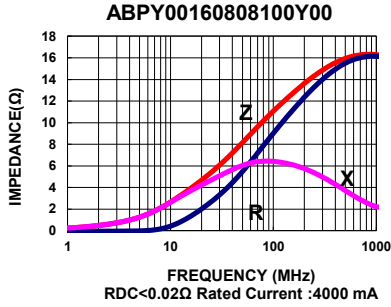

ABPY00201209 Type

■ Dimensions

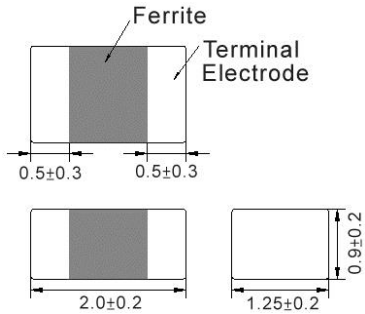

unit:mm

■ Recommended Land Pattern

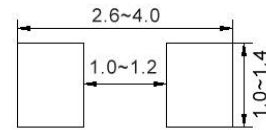

unit:mm

■ Electrical Characteristics

Part No.	Impedance (Ω)	Test Freq.	RDC (Ω)Max.	Rated Current (mA)Max.
ABPY00201209100Y00	10	100 MHz,200 mV	0.010	6000
ABPY00201209300Y00	30	100 MHz,200 mV	0.015	4000
ABPY00201209600Y00	60	100 MHz,200 mV	0.030	3000
ABPY00201209800Y00	80	100 MHz,200 mV	0.040	3000
ABPY00201209121Y00	120	100 MHz,200 mV	0.040	3000
ABPY00201209201Y00	200	100 MHz,200 mV	0.050	2500
ABPY00201209221Y00	220	100 MHz,200 mV	0.080	2000
ABPY00201209301Y00	300	100 MHz,200 mV	0.080	2000
ABPY00201209471Y00	470	100 MHz,200 mV	0.100	2000
ABPY00201209601Y00	600	100 MHz,200 mV	0.100	2000
ABPY00201209102Y00	1000	100 MHz,200 mV	0.120	1500

Note: When ordering, please specify tolerance code. Tolerance: Y=±25% , T=±30%

1. Operating temperature range - 55°C ~ 125°C
2. Rate Current : Applied the current to coils, the temperature rise shall not be more than 30°C
3. Measure Equipment:
Z: HP4291A
RDC: HP4338B or CHEN HWA 502

ABPY00201209 Type

Characteristics Graph

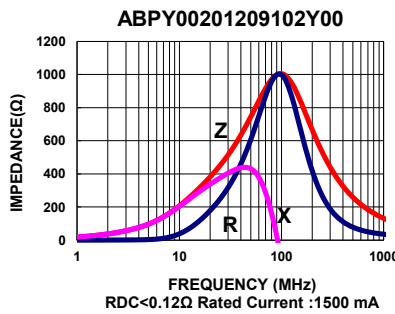
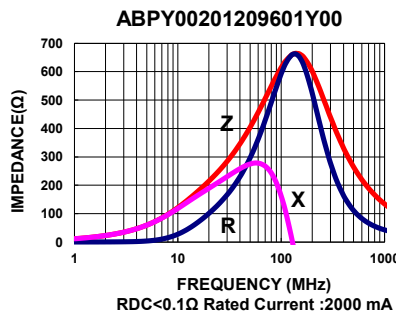
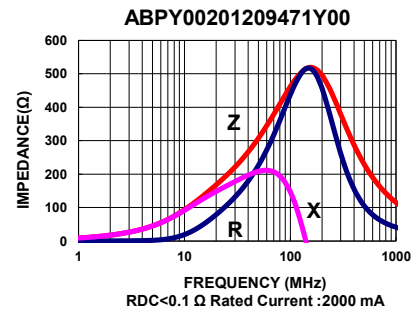
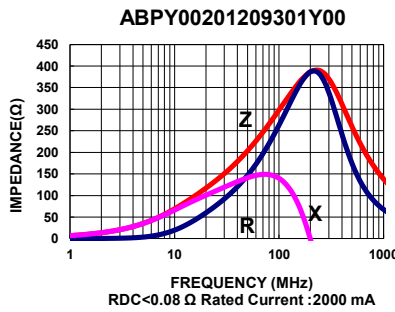
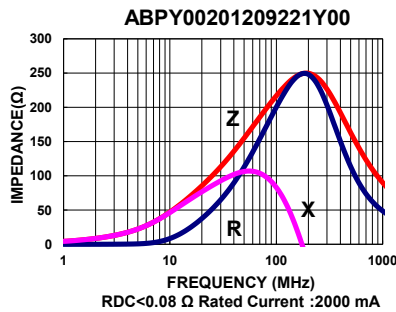
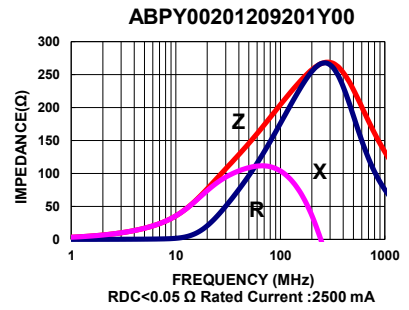
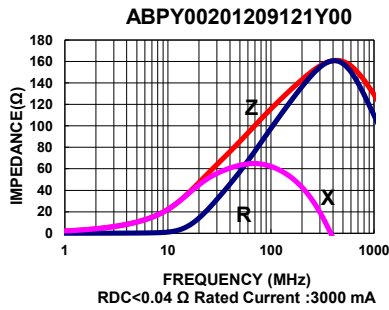
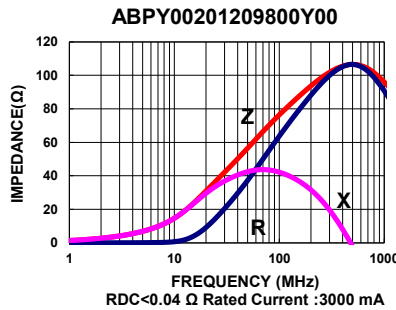
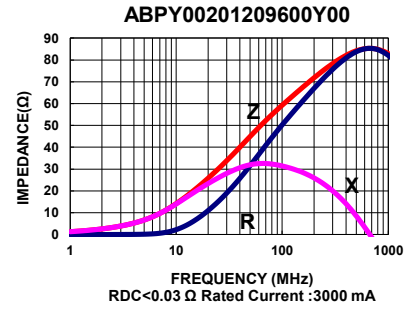
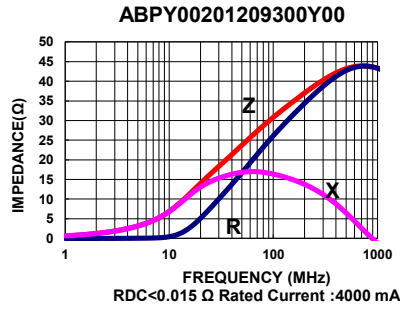
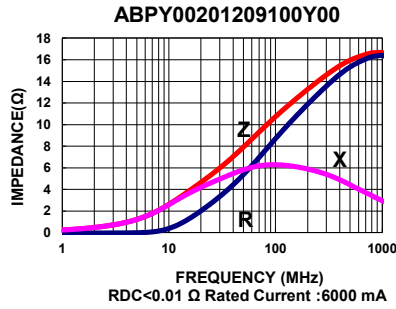

ABPY00321611 Type

■ Dimensions

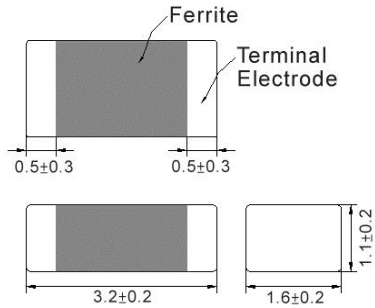

unit:mm

■ Recommended Land Pattern

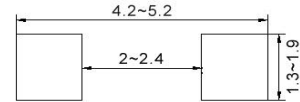

unit:mm

■ Electrical Characteristics

Part No.	Impedance (Ω)	Test Freq.	RDC (Ω)Max.	Rated Current (mA)Max.
ABPY00321611300Y00	30	100 MHz,200 mV	0.015	4000
ABPY00321611500Y00	50	100 MHz,200 mV	0.020	4000
ABPY00321611600Y00	60	100 MHz,200 mV	0.020	4000
ABPY00321611800Y00	80	100 MHz,200 mV	0.025	3000
ABPY00321611101Y00	100	100 MHz,200 mV	0.030	3000
ABPY00321611121Y00	120	100 MHz,200 mV	0.030	3000
ABPY00321611221Y00	220	100 MHz,200 mV	0.050	2000
ABPY00321611301Y00	300	100 MHz,200 mV	0.060	2000
ABPY00321611391Y00	390	100 MHz,200 mV	0.060	2000
ABPY00321611401Y00	400	100 MHz,200 mV	0.100	2000
ABPY00321611471Y00	470	100 MHz,200 mV	0.100	2000
ABPY00321611501Y00	500	100 MHz,200 mV	0.100	2000
ABPY00321611601Y00	600	100 MHz,200 mV	0.100	2000
ABPY00321611102Y00	1000	100 MHz,200 mV	0.150	1200

Note: When ordering, please specify tolerance code. Tolerance: Y=±25%

1. Operating temperature range - 55°C ~ 125°C
2. Rate Current : Applied the current to coils, the temperature rise shall not be more than 30°C
3. Measure Equipment:
 - Z: HP4291A
 - RDC: HP4338B or CHEN HWA 502

ABPY00321611 Type

Characteristics Graph

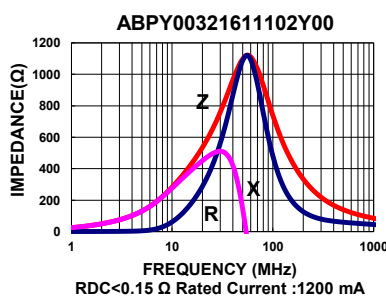
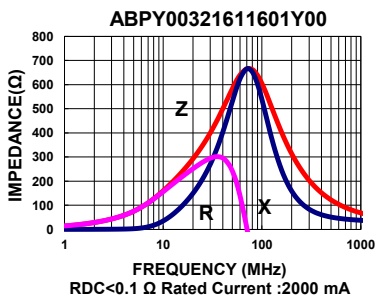
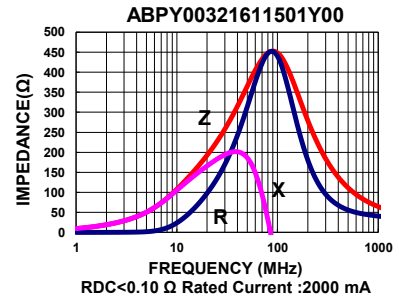
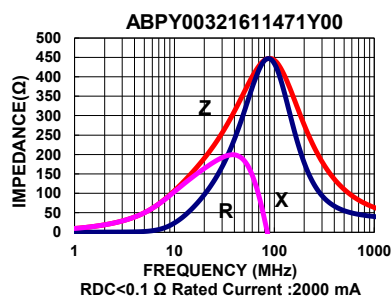
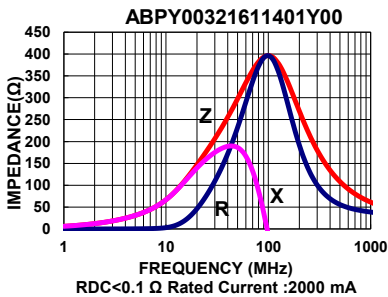
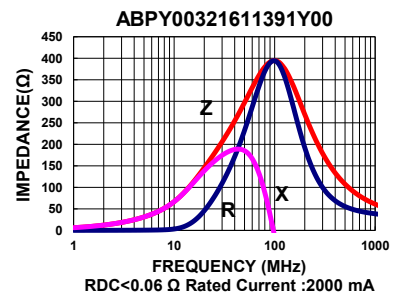
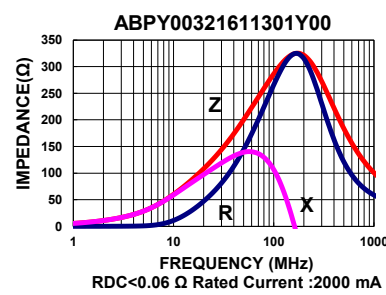
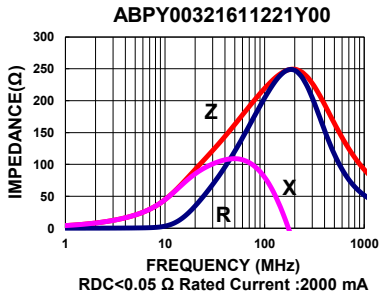
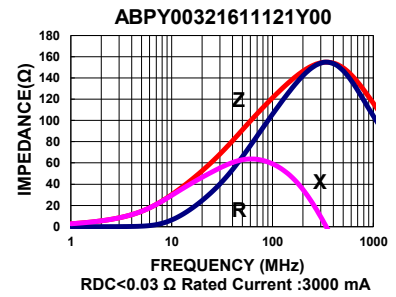
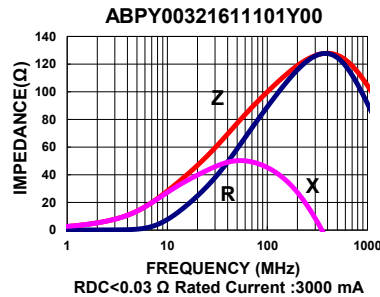
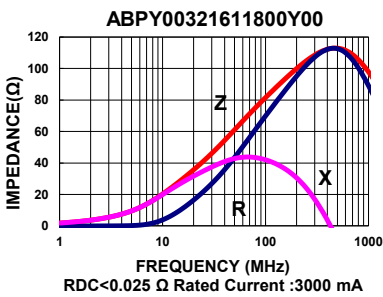
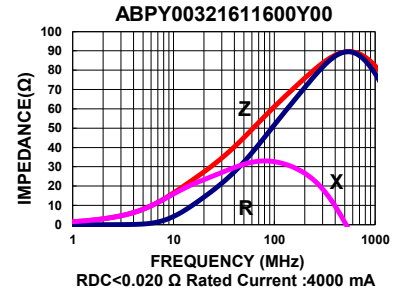
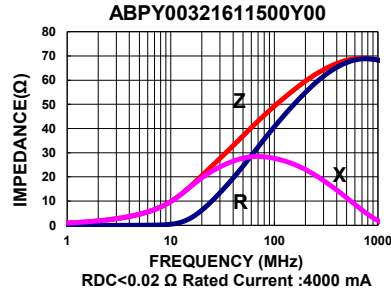
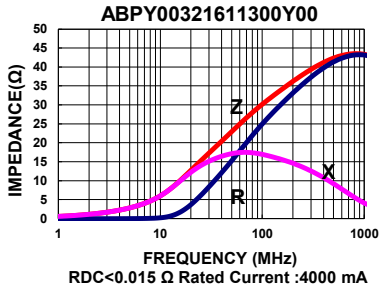

■ Packaging

Tape Dimensions

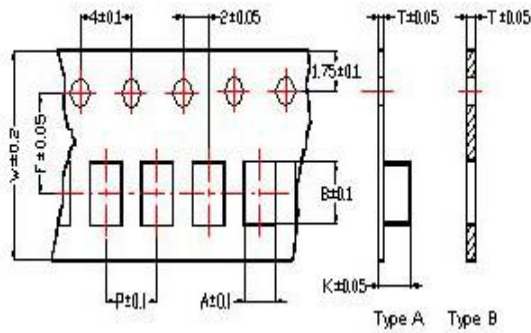

Tape Material

Carrier Tape: Polycarbonate (Tape A)
 Carrier Tape: Paper (Tape B)
 Cover Tape: Polystyrene

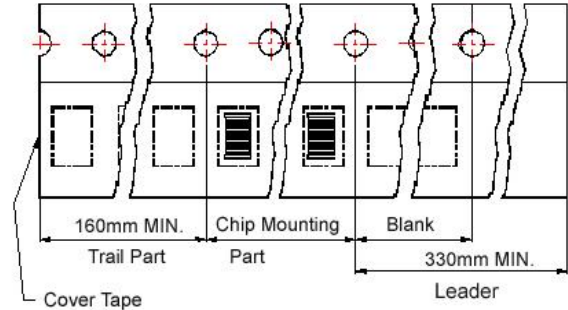

Reel Dimensions

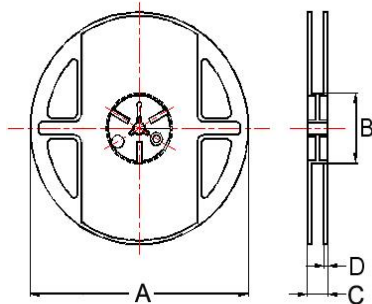

Dimensions in mm

TYPE	Tape Dimensions								Reel Dimensions				Quantity PCS / Reel
	A	B	T	W	P	F	K	Tape	A	B	C	D	
ABPY00100505	0.62	1.12	0.60	8	2	3.5	-	B	178	60	12	2	10000
ABPY00160808	1.05	1.85	0.95	8	4	3.5	-	B	178	60	12	2	4000
ABPY00201209	1.50	2.30	0.97	8	4	3.5	-	B	178	60	12	2	4000
ABPY00321611	1.88	3.50	0.22	8	4	3.5	1.27	A	178	60	12	2	3000

For More Information:

Americas - prodinfo_power_americas@yageo.com | Europe - prodinfo_power_emea@yageo.com | Asia - prodinfo_power_asia@yageo.com

Performance warranty of products offered on this data sheet is limited to the parameters specified. Data is subject to change without notice. Other brand and product names mentioned herein may be trademarks or registered trademarks of their respective owners. © Copyright, 2022. Pulse Electronics, Inc. All rights reserved.

X-ON Electronics

Largest Supplier of Electrical and Electronic Components

Click to view similar products for [Ferrite Beads](#) category:

Click to view products by [Chilisin](#) manufacturer:

Other Similar products are found below :

[CZB1JGTTD152P](#) [CZB2AFTTD800P](#) [CZB2AGTTD121P](#) [PE-0402FB121ST](#) [AB 3X2X3SM](#) [DER0705-2.2](#) [NCB0603R301TR050F](#)
[NCB0805A320TR050F](#) [NCB-H1206B680TR300F](#) [CZB1JGTTD221P](#) [CZB1JGTTD600P](#) [CZB2AGTTD301P](#) [CZB2BFTTE301P](#)
[CZB2BFTTE601P](#) [4221R-1](#) [EMI0805R-600](#) [SBY100505T-100Y-N](#) [NCB-GH0402D121TR060F](#) [NCB0402P301TR005F](#)
[NCB0603R152TR030F](#) [NCB0805A121TR050F](#) [NCB0805A301TR070F](#) [NCB3312K900TR500F](#) [NCB-H0805A221TR300F](#)
[NCB0402P221TR030F](#) [NCB0805A102TR040F](#) [NCB1806E151TR020F](#) [NCB-H0402P100TR200F](#) [NCB-H0603R121TR300F](#) [NCB-](#)
[H0805A220TR600F](#) [NCB-H1206B601TR200F](#) [CZB1JGTTD202P](#) [CBH160808W221T](#) [WLBD1005HCU330TL](#) [WLBD2012HCU121TH](#)
[WLBD2012HCU221TH](#) [WQBD1608HCU121TH](#) [WLBD1608K2U252TB](#) [VLU0810-102KBC12](#) [WLBD1608K2U800TP](#) [BMB2A0080AN4](#)
[SZ1608F470TF](#) [FBSHC0805-331-302R](#) [HFJ100505T-601Y-N](#) [HFY100505T-221Y-N](#) [PBY201209T-110Y-N](#) [SBY060303T-121Y-N](#)
[BBPY00160808301Y00](#) [SBY100505T-750Y-N](#) [BBPY00100505102Y00](#)