

Power Inductor AMRx Series

**Automotive
AEC-Q200**

RoHS Compliant
Halogen Free
REACH Compliant



- Power Circuit
- Shield
- Wire Wound
- Metal
- Ultra High Current

Part Numbering

A	MRU	00	040420	1R0	M	A1
Grade	Series Name	Control Code	Dimensions Code (mm)	Inductance (uH)	Tolerance	
			040412 4.2x4.7x1.2	R22 0.22	M ±20%	
			040420 4.2x4.7x1.8	1R0 1.0		
			060630 6.8x7.3x2.8	3R3 3.3		
			101040 10.2x11.6x3.8			
			131365 12.8x13.8x6.5			

Power Inductor AMRx Series

**Automotive
AEC-Q200**

AMRU00040412 Type

■ Dimensions

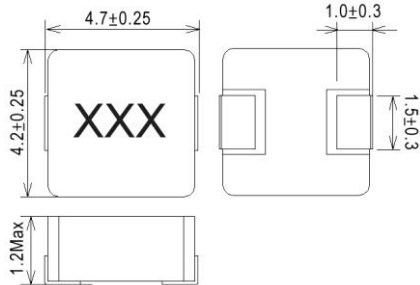

unit:mm

■ Recommended Land Pattern

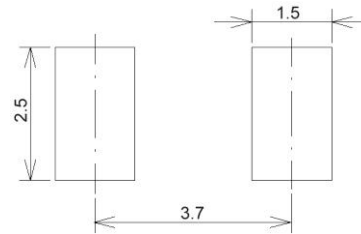

unit:mm

■ Electrical Characteristics

Part No.	Inductance (uH)	Test Freq.	RDC(mΩ) Max(Typ)	Isat (A)Typ.	Irms (A)Typ.	Tolerance (±%)	Marking
AMRU00040412R22MA1	0.22	100kHz/0.5V	12(11)	15	8.5	20	R22
AMRU00040412R47MA1	0.47	100kHz/0.5V	20(18)	9	5	20	R47
AMRU000404121R0MA1	1.0	100kHz/0.5V	43(39)	6	4	20	1R0

Note: When ordering, please specify tolerance code. Tolerance: M=±20%

1. Operating temperature range - 40°C ~ 125°C
2. Isat for Inductance drop 30% from its value without current
3. I rms for a 40°C temprature rise from 25°C ambient with current
4. Absolute maximum voltage 30VDC
5. Measure Equipment:
 L: WK3260B or WK6500P
 RDC: CHEN HWA502 or 16502
 Isat: WK3260B+WK3265B
 I rms: CHROMA 1810

Power Inductor AMRx Series

Automotive
AEC-Q200

AMRU00040412 Type

■ Characteristics Graph

Inductance vs. DC Current

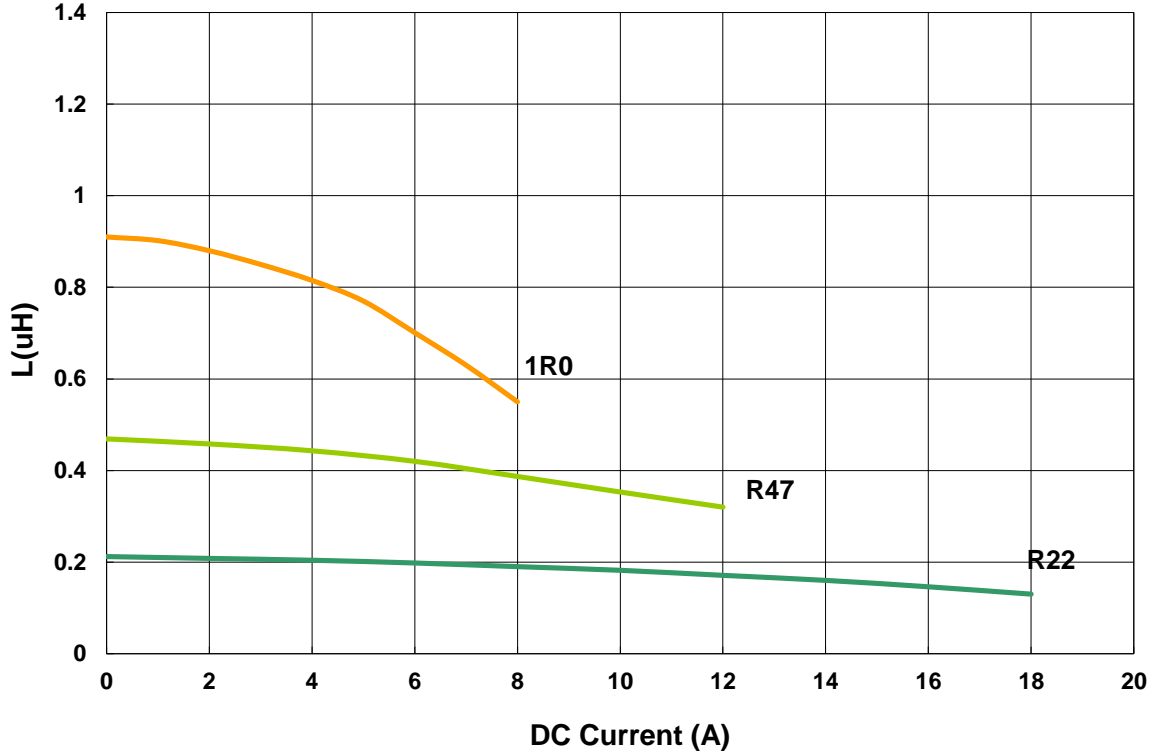

Temperature Change vs. DC Current

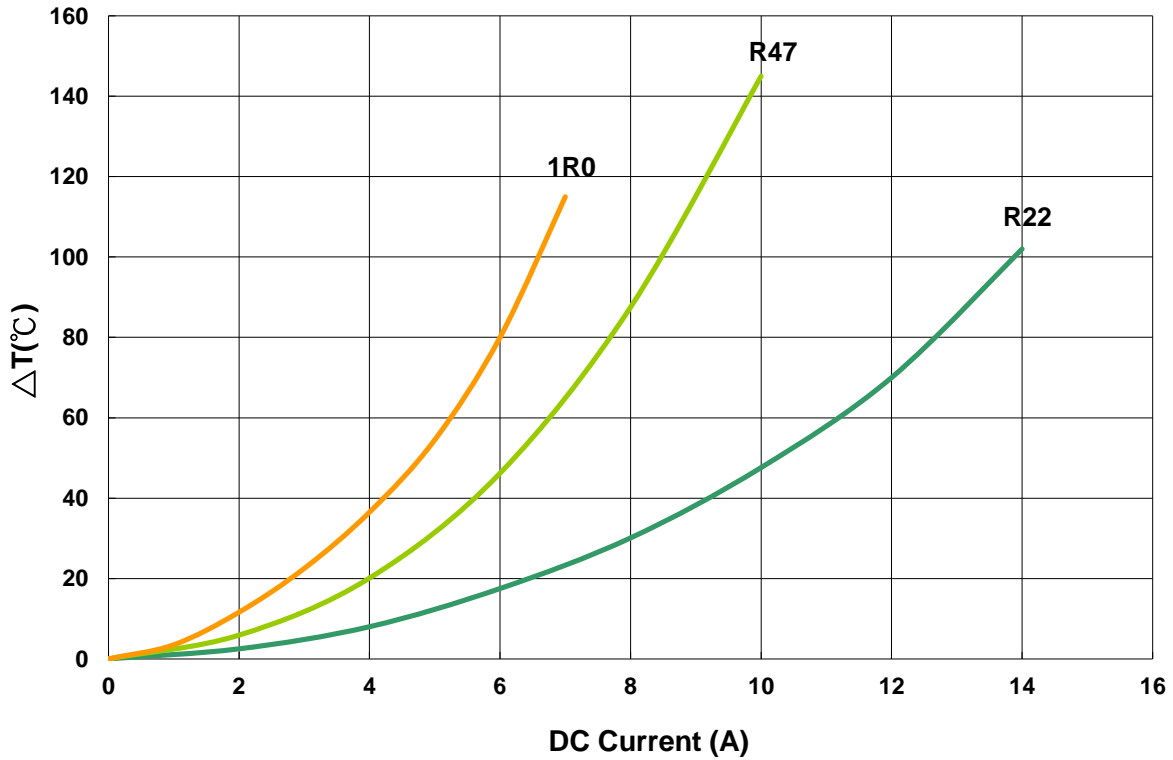

Power Inductor AMRx Series

**Automotive
AEC-Q200**

AMRU00040420 Type

■ Dimensions

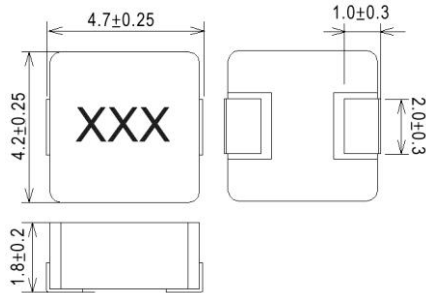

unit:mm

■ Recommended Land Pattern

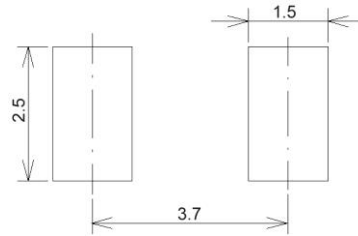

unit:mm

■ Electrical Characteristics

Part No.	Inductance (uH)	Test Freq.	RDC(mΩ) Max(Typ)	Isat (A)Typ.	Irms (A)Typ.	Tolerance (±%)	Marking
AMRU00040420R47MB1	0.47	100kHz/0.5V	14(12)	10	7	20	R47
AMRU000404201R0MB1	1	100kHz/0.5V	27(24)	7	4.5	20	1R0
AMRU000404201R5MB1	1.5	100kHz/0.5V	46(38)	6	4	20	1R5
AMRU000404202R2MB1	2.2	100kHz/0.5V	55(50)	5	3	20	2R2
AMRU000404204R7MB1	4.7	100kHz/0.5V	105(95)	3.5	2.2	20	4R7

Note: When ordering, please specify tolerance code. Tolerance: M=±20%

1. Operating temperature range - 40°C ~ 125°C
2. Isat for Inductance drop 30% from its value without current
3. I rms for a 40°C temprature rise from 25°C ambient with current
4. Absolute maximum voltage 30VDC
5. Measure Equipment:

L: WK3260B or WK6500P
 RDC: CHEN HWA502 or 16502
 Isat: WK3260B+WK3265B
 I rms: CHROMA 1810

Power Inductor AMRx Series

**Automotive
AEC-Q200**

AMRU00040420 Type

Characteristics Graph

Inductance vs. DC Current

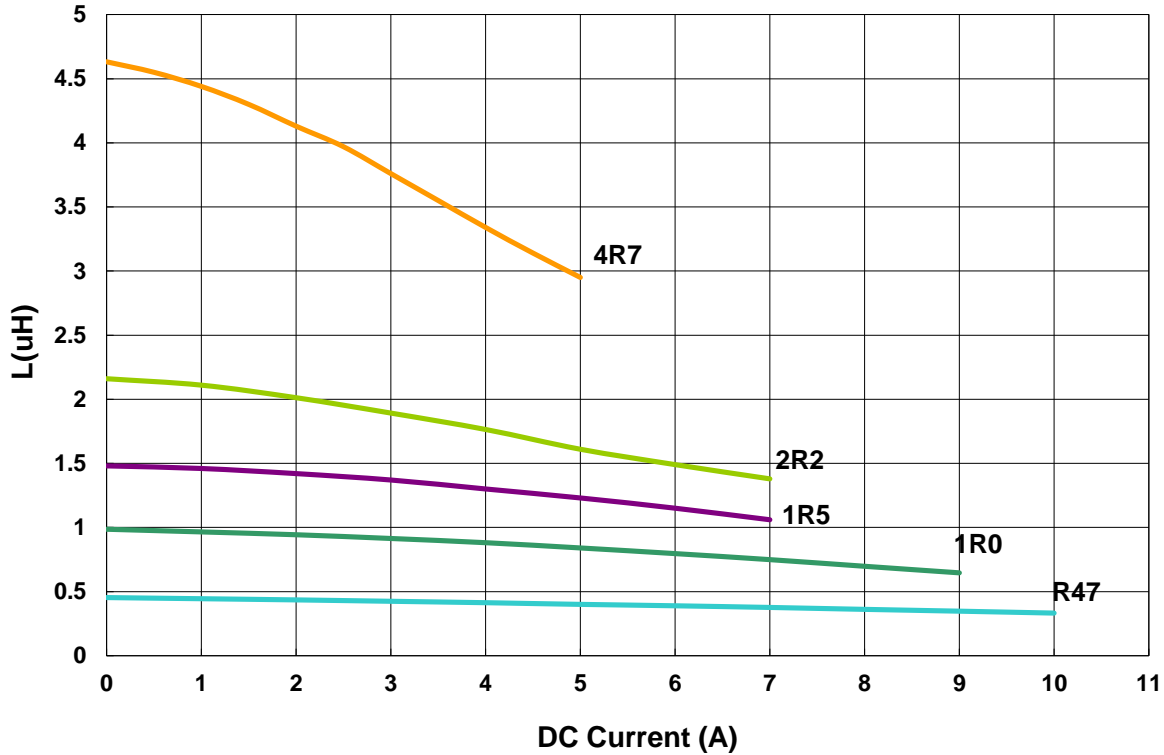

Temperature Change vs. DC Current

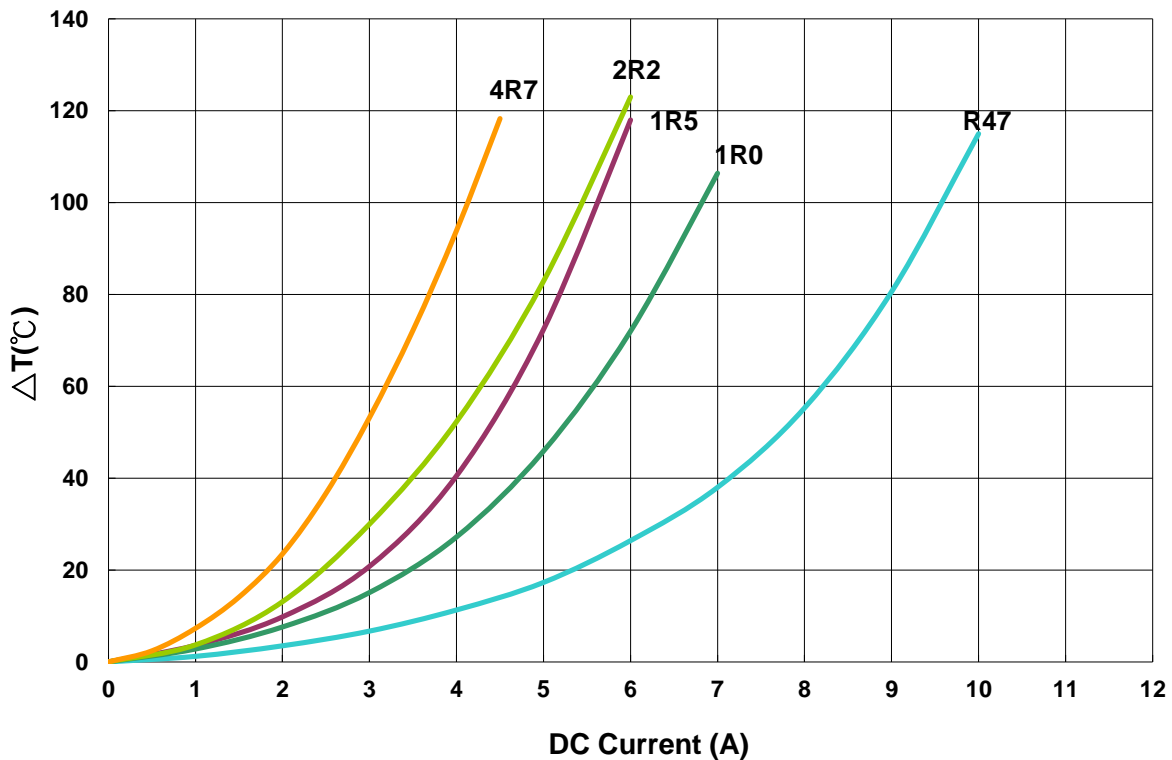

Power Inductor AMRx Series

**Automotive
AEC-Q200**

AMRU00060630 Type

■ Dimensions

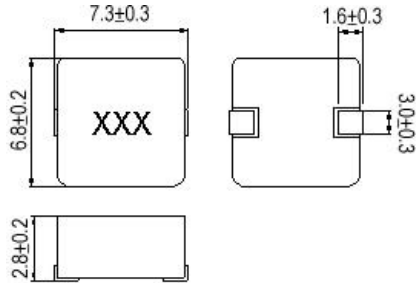

unit:mm

■ Recommended Land Pattern

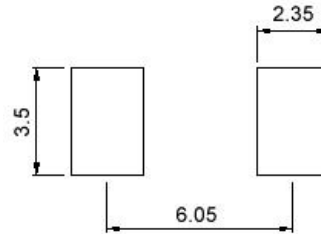

unit:mm

■ Electrical Characteristics

Part No.	Inductance (uH)	Test Freq.	RDC(mΩ) Max(Typ)	Isat (A)Typ.	Irms (A)Typ.	Tolerance (±%)	Marking
AMRU00060630R47MA1	0.47	100kHz,0.5V	4.3(3.9)	20	16.5	20	R47
AMRU000606301R0MA1	1	100kHz,0.5V	10(9)	18	10	20	1R0
AMRU000606301R5MA1	1.5	100kHz,0.5V	14(13)	13	9	20	1R5
AMRU000606302R2MA1	2.2	100kHz,0.5V	20(18)	10	8	20	2R2
AMRU000606303R3MA1	3.3	100kHz,0.5V	28(25)	9	6.5	20	3R3
AMRU000606304R7MA1	4.7	100kHz,0.5V	40(35)	8	5.5	20	4R7
AMRU000606305R6MA1	5.6	100kHz,0.5V	45(38)	7	5	20	5R6
AMRU000606306R8MA1	6.8	100kHz,0.5V	49.5(45)	6	4.5	20	6R8
AMRU000606308R2MA1	8.2	100kHz,0.5V	55(50)	5.2	4.3	20	8R2
AMRU00060630100MA1	10	100kHz,0.5V	68(62)	5	4	20	100
AMRU00060630150MA1	15	100kHz,0.5V	125(110)	4.5	3.2	20	150
AMRU00060630220MA1	22	100kHz,0.5V	145(130)	3.5	3	20	220

Note: When ordering, please specify tolerance code. Tolerance: M=±20%

1. Operating temperature range - 40°C ~ 125°C
2. Isat for Inductance drop 30% from its value without current
3. Iirms for a 40°C temprature rise from 25°C ambient with current
4. Absolute maximum voltage 30VDC
5. Measure Equipment:
 L: WK3260B or WK6500P
 RDC: CHEN HWA502 or 16502
 Isat: WK3260B+WK3265B
 Iirms: CHROMA 1810

Power Inductor AMRx Series

**Automotive
AEC-Q200**

AMRU00060630 Type

Characteristics Graph

Inductance vs. DC Current

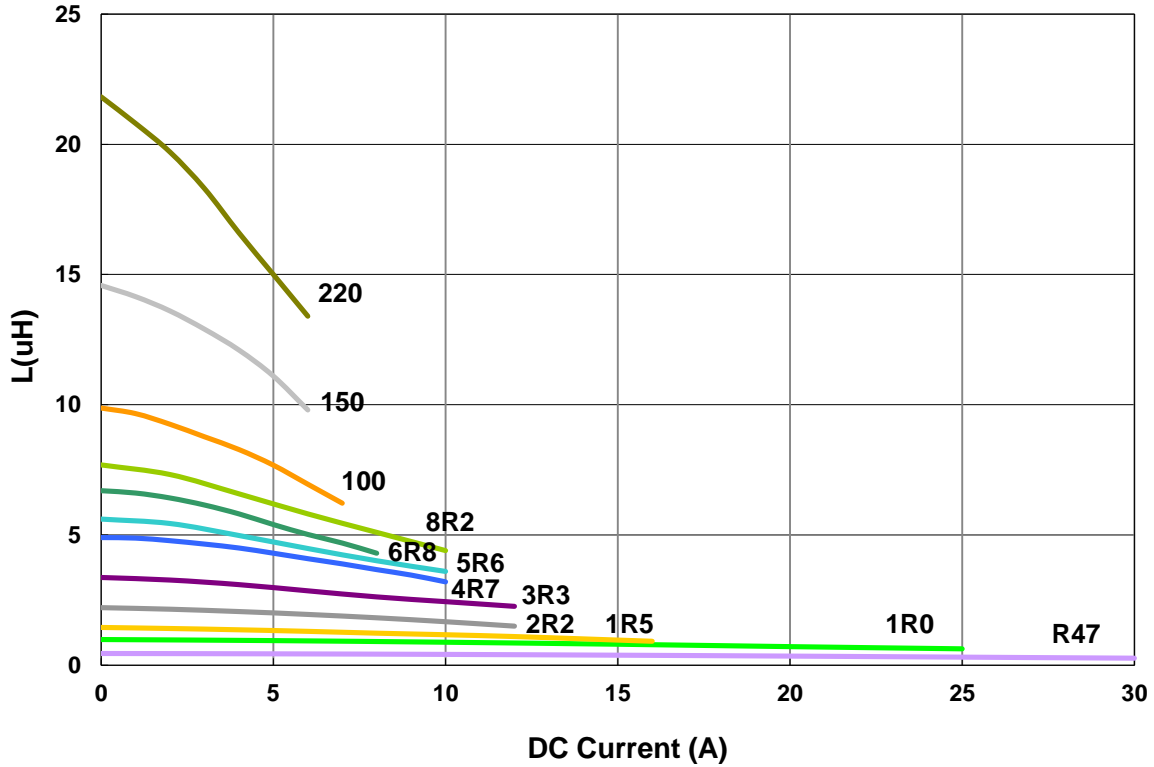

Temperature Change vs. DC Current

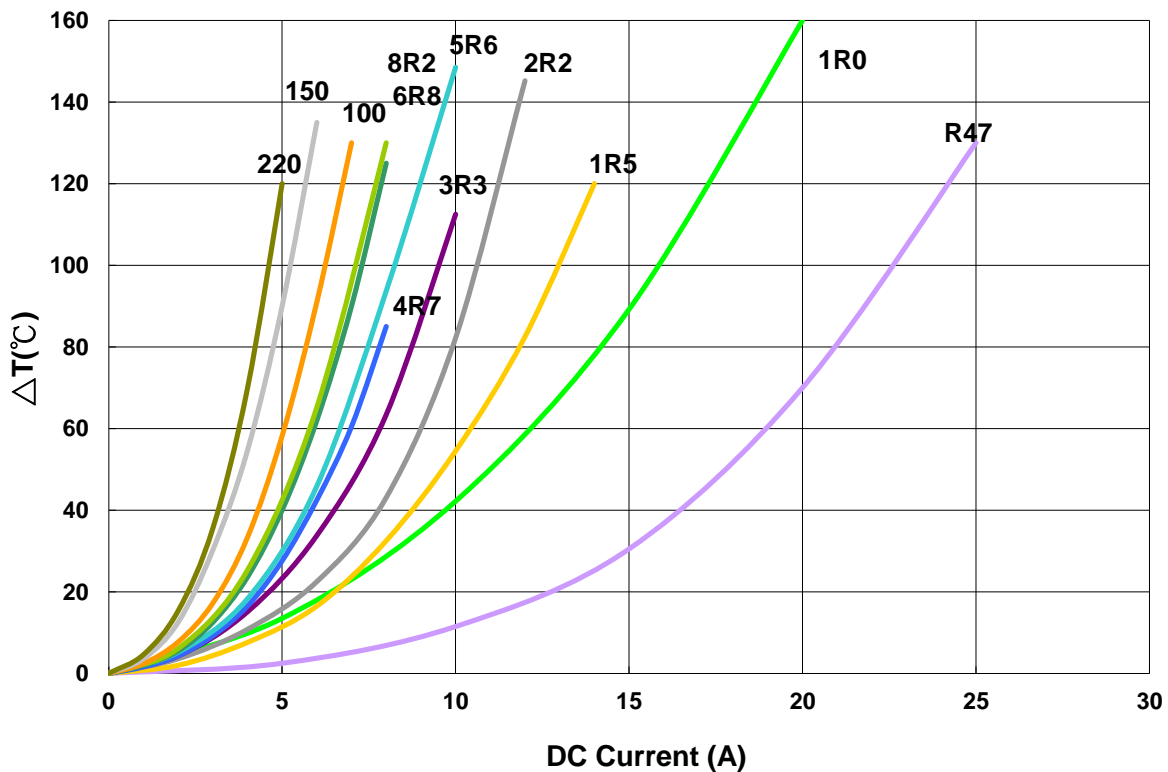

Power Inductor AMRx Series

**Automotive
AEC-Q200**

AMRU00101040 Type

■ Dimensions

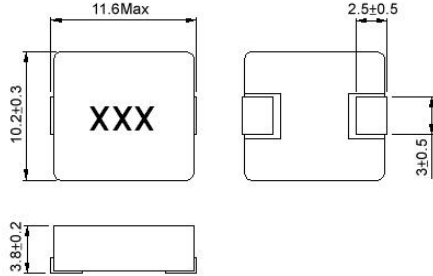

unit:mm

■ Recommended Land Pattern

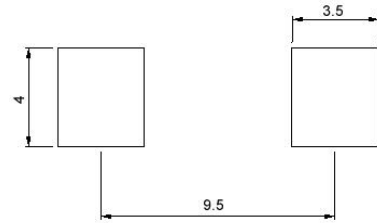

unit:mm

■ Electrical Characteristics

Part No.	Inductance (uH)	Test Freq.	RDC(mΩ) Max(Typ)	Isat (A)Typ.	Irms (A)Typ.	Tolerance (±%)	Marking
AMRU001010401R0MA1	1	100kHz/0.5V	3.3(3.0)	20	18	20	1R0
AMRU001010402R2MA1	2.2	100kHz/0.5V	6.8(6.0)	16	14	20	2R2
AMRU001010403R3MA1	3.3	100kHz/0.5V	11(10)	13	11	20	3R3
AMRU001010404R7MA1	4.7	100kHz/0.5V	16(14.5)	11	9	20	4R7
AMRU001010406R8MA1	6.8	100kHz/0.5V	24(20)	9	8	20	6R8
AMRU00101040100MA1	10	100kHz/0.5V	30(27)	7	6.5	20	100
AMRU00101040150MA1	15	100kHz/0.5V	45(40)	6.25	6	20	150
AMRU00101040220MA1	22	100kHz/0.5V	66(60)	5	4.5	20	220
AMRU00101040330MA1	33	100kHz/0.5V	100(90)	4	3.5	20	330
AMRU00101040470MA1	47	100kHz/0.5V	165(150)	3.5	3	20	470

Note: When ordering, please specify tolerance code. Tolerance: M=±20%

- Operating temperature range - 40°C ~ 125°C
- Isat for Inductance drop 30% from its value without current
- Irms for a 40°C temprature rise from 25°C ambient with current
- Absolute maximum voltage 30VDC
- Measure Equipment:
 - L: WK3260B or WK6500P
 - RDC: CHEN HWA502 or 16502
 - Isat: WK3260B+WK3265B
 - Irms: CHROMA 1810

Power Inductor AMRx Series

**Automotive
AEC-Q200**

AMRU00101040 Type

Characteristics Graph

Inductance vs. DC Current

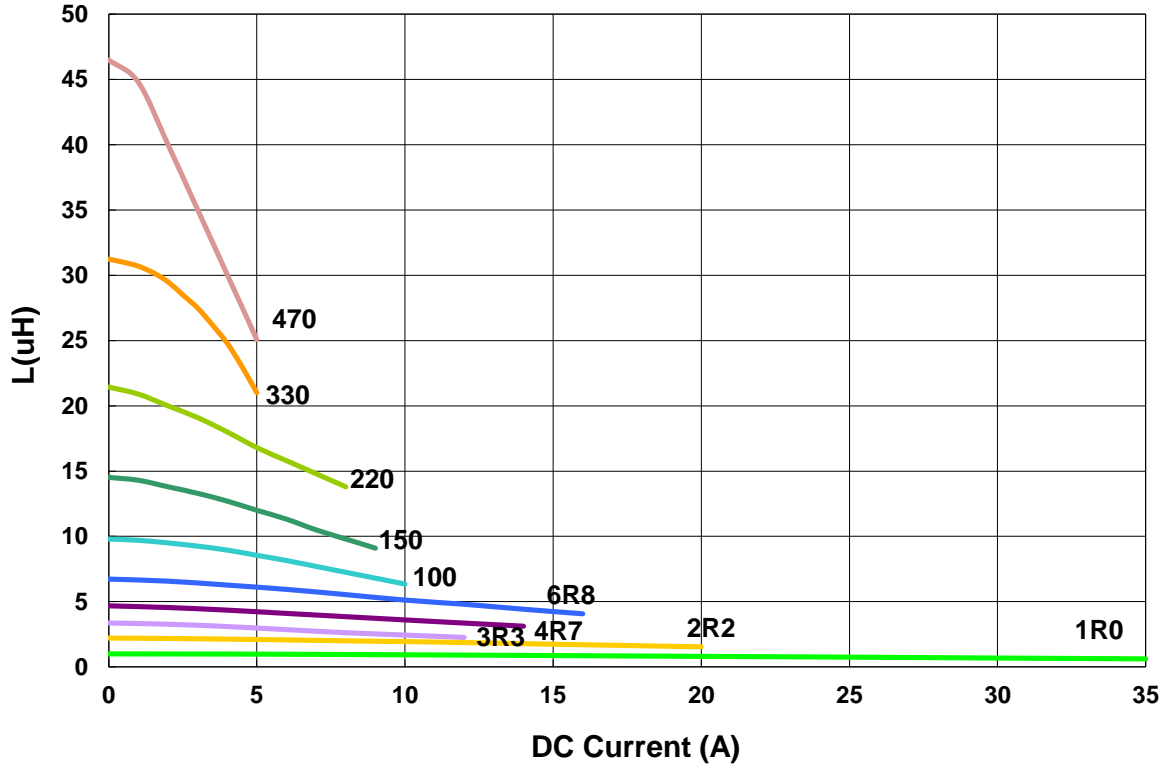

Temperature Change vs. DC Current

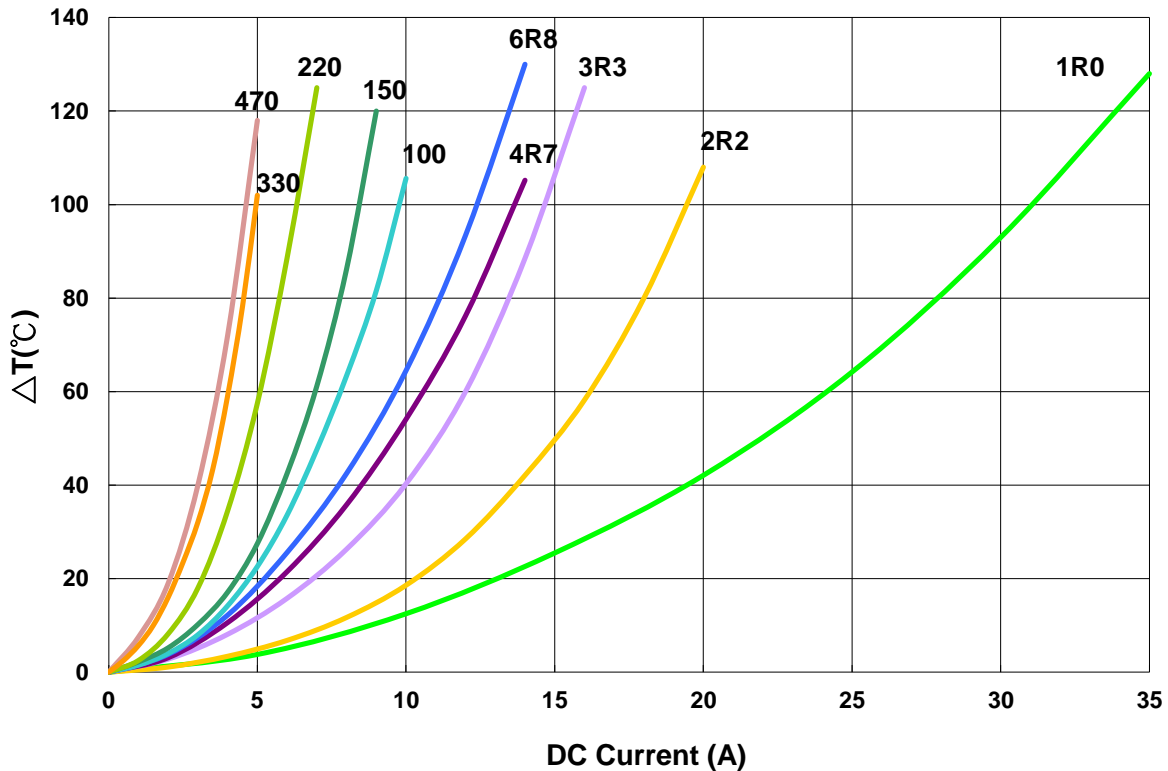

Power Inductor AMRx Series

**Automotive
AEC-Q200**

AMRU00131365 Type

■ Dimensions

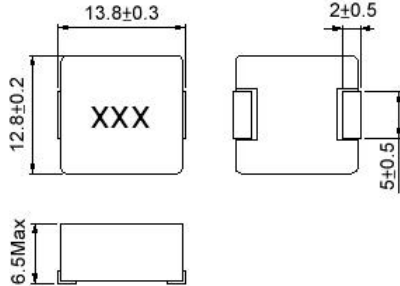

unit:mm

■ Recommended Land Pattern

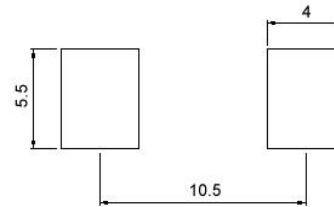

unit:mm

■ Electrical Characteristics

Part No.	Inductance (uH)	Test Freq.	RDC(mΩ) Max(Typ)	Isat (A)Typ.	Irms (A)Typ.	Tolerance (±%)	Marking
AMRU001313651R0MA1	1	100kHz/0.5V	2.1(1.9)	30	28	20	1R0
AMRU001313651R5MA1	1.5	100kHz/0.5V	3.0(2.7)	28	23	20	1R5
AMRU001313652R2MA1	2.2	100kHz/0.5V	4.4(3.7)	25	18	20	2R2
AMRU001313653R3MA1	3.3	100kHz/0.5V	6.8(5.7)	22	16	20	3R3
AMRU001313654R7MA1	4.7	100kHz/0.5V	7.7(7.0)	18	14	20	4R7
AMRU00131365100MA1	10	100kHz/0.5V	18(16.5)	12	10	20	100
AMRU00131365220MA1	22	100kHz/0.5V	40(35)	7	6	20	220
AMRU00131365330MA1	33	100kHz/0.5V	55(50)	6	5	20	330
AMRU00131365470MA1	47	100kHz/0.5V	100(80)	5	4	20	470

Note: When ordering, please specify tolerance code. Tolerance: M=±20%

1. Operating temperature range - 40°C ~ 125°C
2. Isat for Inductance drop 30% from its value without current
3. Irms for a 40°C temprature rise from 25°C ambient with current
4. Absolute maximum voltage 30VDC
5. Measure Equipment:
 L: WK3260B or WK6500P
 RDC: CHEN HWA502 or 16502
 Isat: WK3260B+WK3265B
 Irms: CHROMA 1810

Power Inductor AMRx Series

**Automotive
AEC-Q200**

AMRU00131365 Type

Characteristics Graph

Inductance vs. DC Current

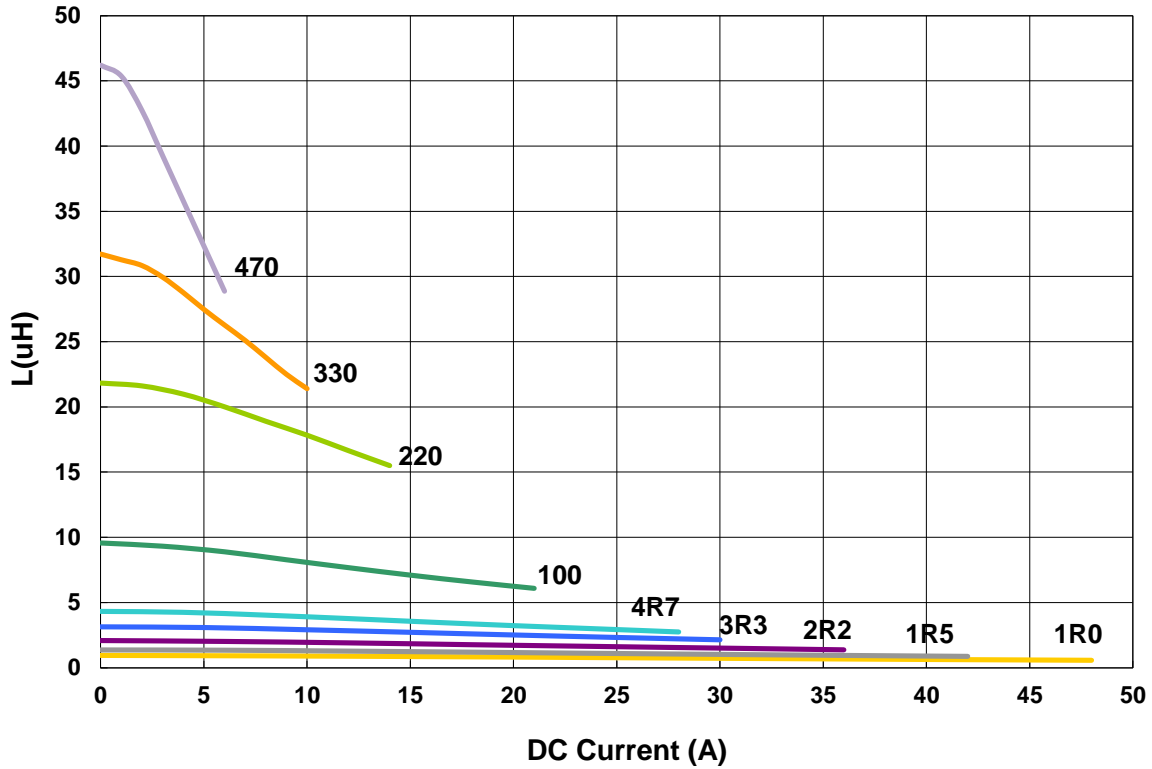

Temperature Change vs. DC Current

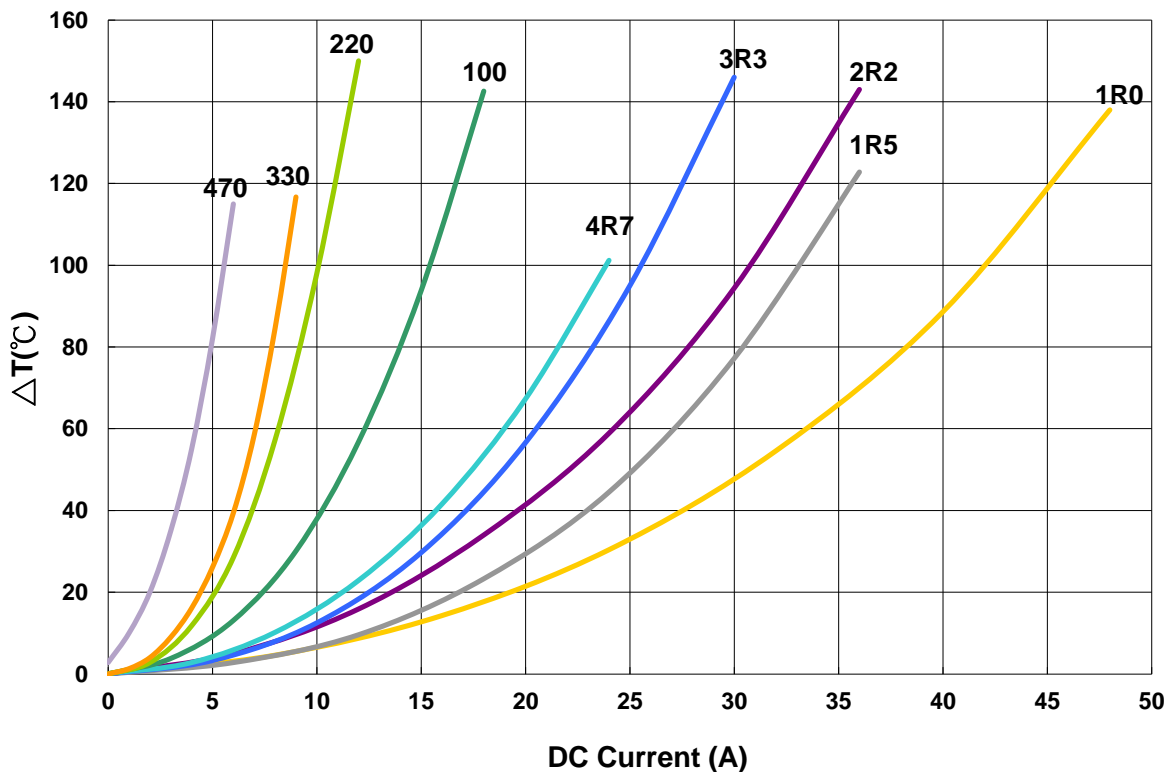

Power Inductor AMRx Series

**Automotive
AEC-Q200**

■ Packaging

Tape Dimensions

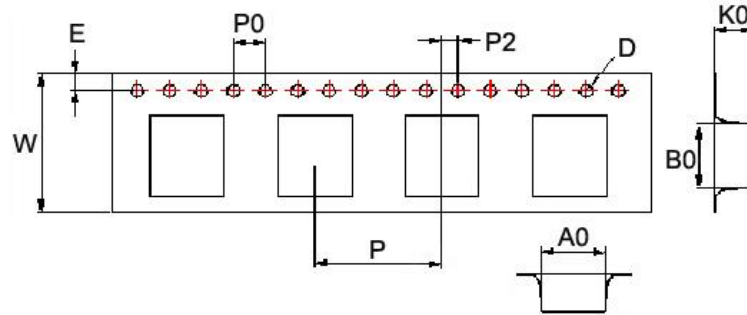

Reel Dimensions

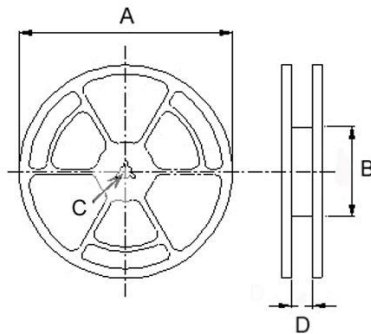

Dimensions in mm

TYPE	Tape Dimensions									Reel Dimensions				Quantity
	A0	B0	K0	D	E	W	P	P0	P2	A	B	C	D	PCS / REEL
AMRU00040412	4.4	4.9	1.5	1.55	1.75	12	8	4	2	330	100	13	13.4	2000
AMRU00040420	4.3	4.9	2.4	1.55	1.75	12	8	4	2	330	100	13	13.4	2000
AMRU00060630	7.1	7.6	3.4	1.55	1.75	16	12	4	2	330	100	13	16	1000
AMRU00101040	10.6	11.7	4.25	1.55	1.75	24	16	4	2	330	100	13	24.4	500
AMRU00131365	13.1	14.6	6.75	1.55	1.75	24	16	4	2	330	100	13	24.4	500

X-ON Electronics

Largest Supplier of Electrical and Electronic Components

Click to view similar products for [Fixed Inductors](#) category:

Click to view products by [Chilisin](#) manufacturer:

Other Similar products are found below :

[CR32NP-100KC](#) [CR54NP-470LC](#) [70F224AI](#) [MGDQ4-00004-P](#) [MHQ1005P10NJ](#) [MHQ1005P1N0S](#) [MHQ1005P2N4S](#) [MHQ1005P3N6S](#)
[MHQ1005P5N1S](#) [MHQ1005P8N2J](#) [PE-53601NL](#) [PE-53602NL](#) [PG0936.113NLT](#) [9220-20](#) [9310-16](#) [PM06-2N7](#) [PM06-39NJ](#) [A01TK](#)
[1206CS-471XJ](#) [HC2-R47-R](#) [HC8-1R2-R](#) [HCF1305-3R3-R](#) [1206CS-151XG](#) [RCH664NP-140L](#) [RCH664NP-4R7M](#) [RCP1317NP-391L](#)
[RCR110DNP-331L](#) [DH2280-4R7M](#) [DS1608C-106](#) [B10TJ](#) [B82498B3101J000](#) [ELJ-RE27NJF2](#) [1812CS-153XJ](#) [1812CS-183XJ](#) [1812CS-](#)
[223XJ](#) [1812LS-104XJ](#) [1812LS-105XJ](#) [1812LS-124XJ](#) [1812LS-154XJ](#) [1812LS-223XJ](#) [1812LS-224XJ](#) [1812LS-563XJ](#) [1812LS-683XJ](#)
[1812LS-824XJ](#) [NIN-FB101JTR110F](#) [NIN-FB471JTR62F](#) [NIN-FC1R5JTR220F](#) [NIN-HCR15JTRF](#) [NIN-HCR33JTRF](#) [NIN-HDR22JTRF](#)