

Power Inductor AMRx Series **Automotive AEC-Q200**

RoHS Compliant
Halogen Free
REACH Compliant



- Power Circuit
- Shield
- Wire Wound
- Metal
- Ultra High Current

Part Numbering

A	MRU	00	040420	1R0	M	A1
Grade	Series Name	Control Code	Dimensions Code (mm)	Inductance (uH)	Tolerance	
			040412 4.2x4.7x1.2	R22 0.22	M ±20%	
			040420 4.2x4.7x1.8	1R0 1.0		
			060630 6.8x7.3x2.8	3R3 3.3		
			101040 10.2x11.6x3.8			
			131365 12.8x13.8x6.5			

Power Inductor AMRx Series

**Automotive
AEC-Q200**

AMRU00040412 Type

■ Dimensions

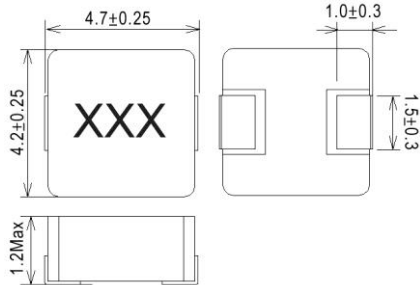

unit:mm

■ Recommended Land Pattern

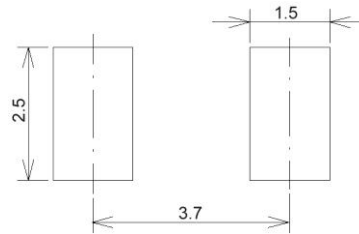

unit:mm

■ Electrical Characteristics

Part No.	Inductance (uH)	Test Freq.	RDC(mΩ) Max(Typ)	Isat (A)Typ.	Irms (A)Typ.	Tolerance (±%)	Marking
AMRU00040412R22MA1	0.22	100kHz/0.5V	12(11)	15	8.5	20	R22
AMRU00040412R47MA1	0.47	100kHz/0.5V	20(18)	9	5	20	R47
AMRU000404121R0MA1	1.0	100kHz/0.5V	43(39)	6	4	20	1R0

Note: When ordering, please specify tolerance code. Tolerance: M=±20%

1. Operating temperature range - 40°C ~ 125°C
2. Isat for Inductance drop 30% from its value without current
3. I rms for a 40°C temprature rise from 25°C ambient with current
4. Absolute maximum voltage 30VDC
5. Measure Equipment:
 L: WK3260B or WK6500P
 RDC: CHEN HWA502 or 16502
 Isat: WK3260B+WK3265B
 I rms: CHROMA 1810

Power Inductor AMRx Series

**Automotive
AEC-Q200**

AMRU00040412 Type

■ Characteristics Graph

Inductance vs. DC Current

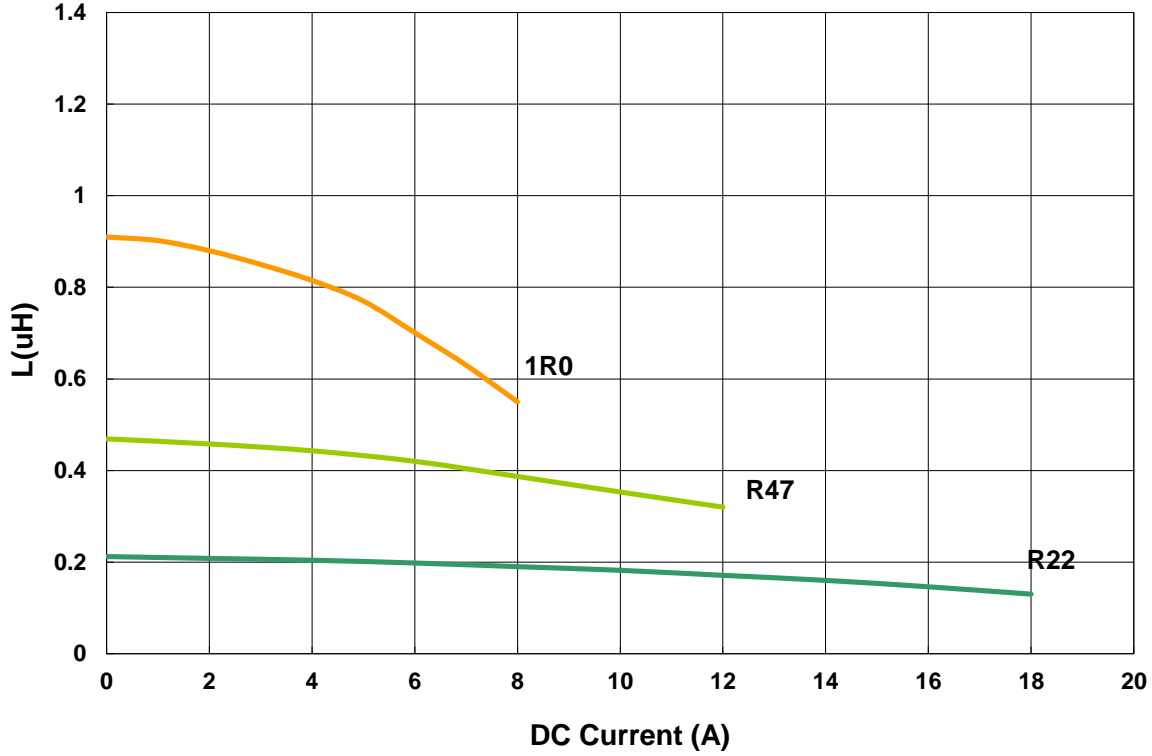

Temperature Change vs. DC Current

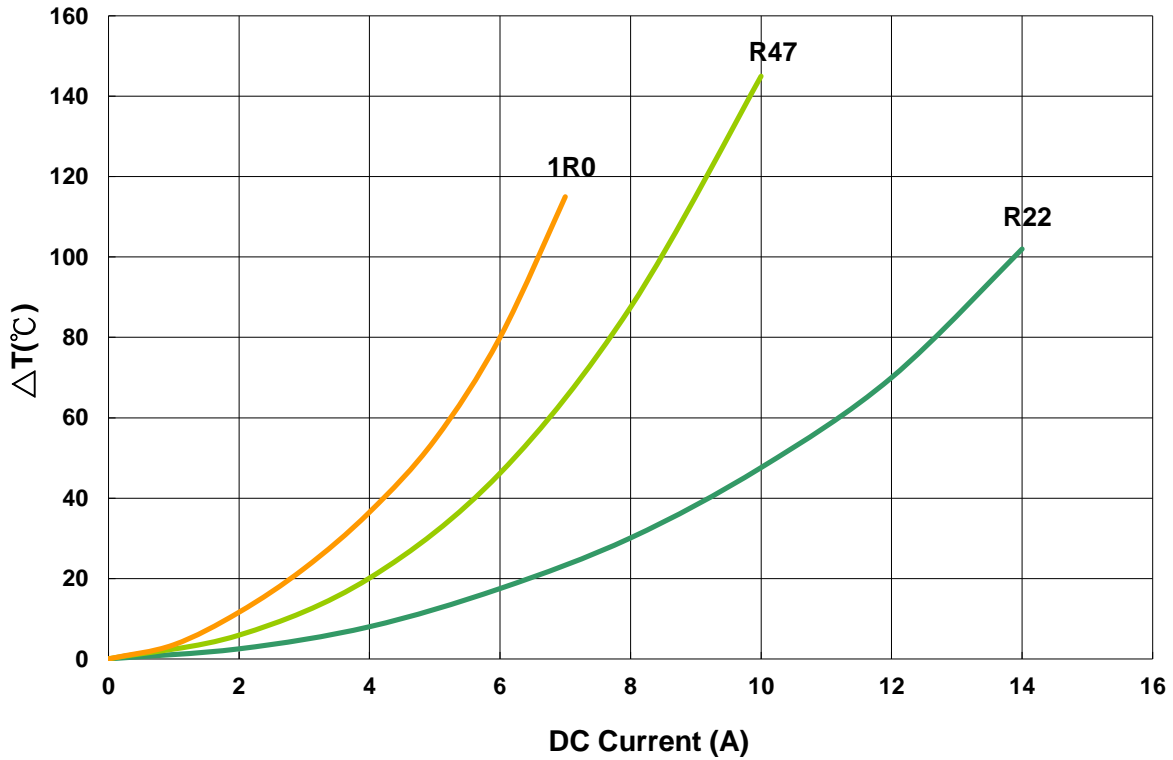

Power Inductor AMRx Series

**Automotive
AEC-Q200**

AMRU00040420 Type

Dimensions

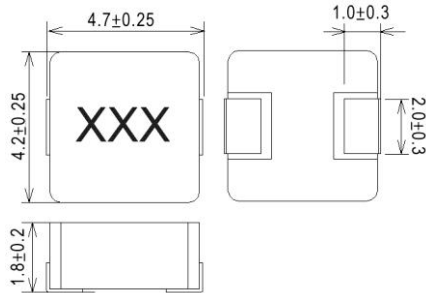

unit:mm

Recommended Land Pattern

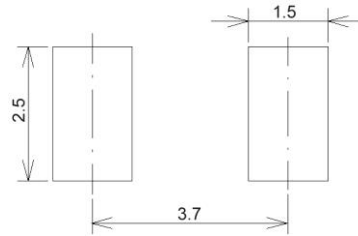

unit:mm

Electrical Characteristics

Part No.	Inductance (uH)	Test Freq.	RDC(mΩ) Max(Typ)	Isat (A)Typ.	Irms (A)Typ.	Tolerance (±%)	Marking
AMRU00040420R47MB1	0.47	100kHz/0.5V	14(12)	10	7	20	R47
AMRU000404201R0MB1	1	100kHz/0.5V	27(24)	7	4.5	20	1R0
AMRU000404201R5MB1	1.5	100kHz/0.5V	46(38)	6	4	20	1R5
AMRU000404202R2MB1	2.2	100kHz/0.5V	55(50)	5	3	20	2R2
AMRU000404204R7MB1	4.7	100kHz/0.5V	105(95)	3.5	2.2	20	4R7

Note: When ordering, please specify tolerance code. Tolerance: M=±20%

- Operating temperature range - 40°C ~ 125°C
- Isat for Inductance drop 30% from its value without current
- Irms for a 40°C temprature rise from 25°C ambient with current
- Absolute maximum voltage 30VDC
- Measure Equipment:

L: WK3260B or WK6500P
 RDC: CHEN HWA502 or 16502
 Isat: WK3260B+WK3265B
 Irms: CHROMA 1810

Power Inductor AMRx Series

**Automotive
AEC-Q200**

AMRU00040420 Type

Characteristics Graph

Inductance vs. DC Current

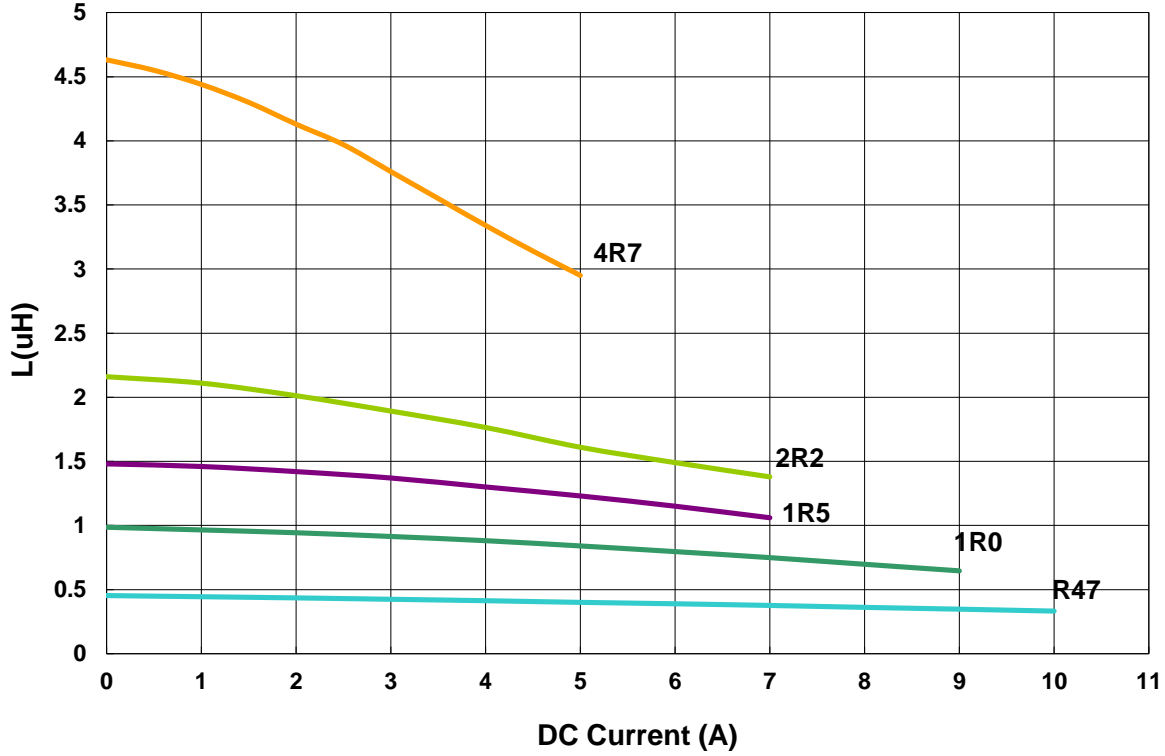

Temperature Change vs. DC Current

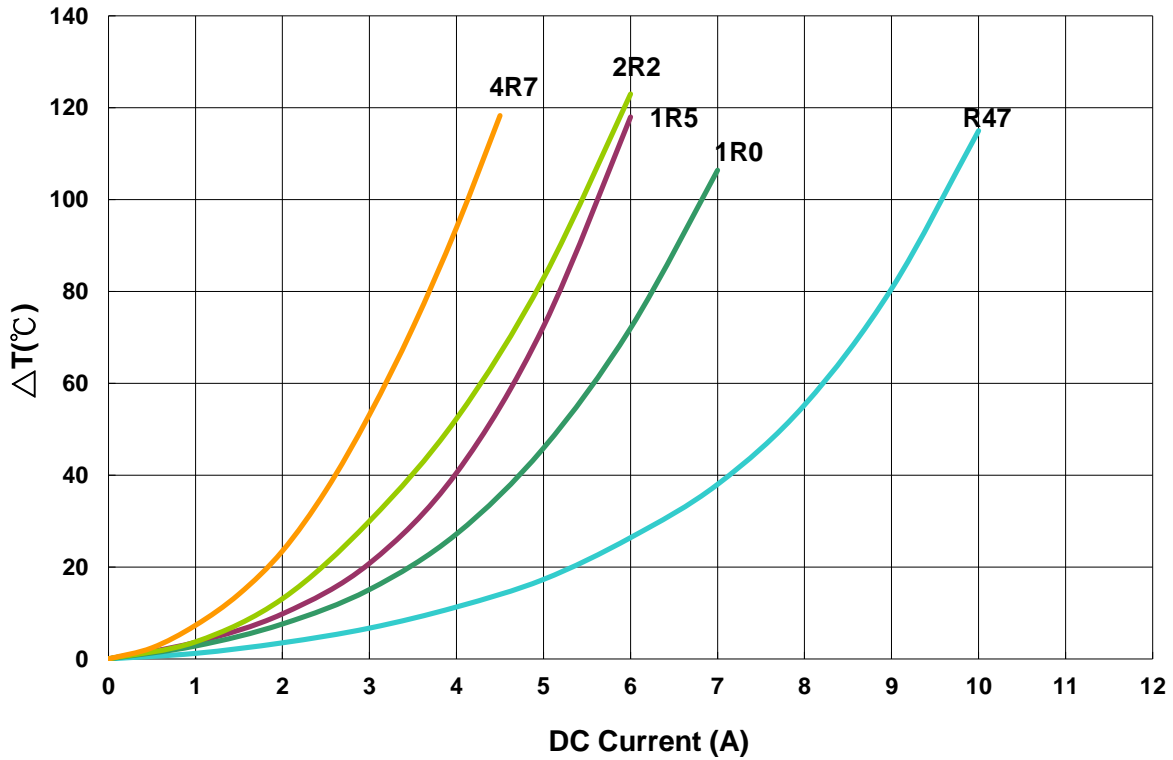

Power Inductor AMRx Series

**Automotive
AEC-Q200**

AMRU00060630 Type

Dimensions

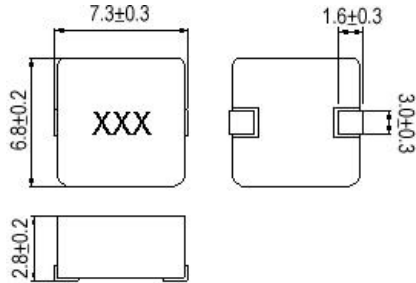

unit:mm

Recommended Land Pattern

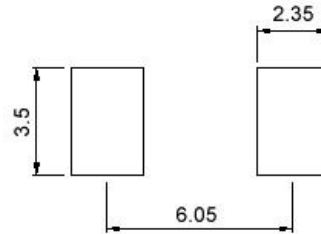

unit:mm

Electrical Characteristics

Part No.	Inductance (uH)	Test Freq.	RDC(mΩ) Max(Typ)	Isat (A)Typ.	Irms (A)Typ.	Tolerance (±%)	Marking
AMRU00060630R47MA1	0.47	100kHz,0.5V	4.3(3.9)	20	16.5	20	R47
AMRU000606301R0MA1	1	100kHz,0.5V	10(9)	18	10	20	1R0
AMRU000606301R5MA1	1.5	100kHz,0.5V	14(13)	13	9	20	1R5
AMRU000606302R2MA1	2.2	100kHz,0.5V	20(18)	10	8	20	2R2
AMRU000606303R3MA1	3.3	100kHz,0.5V	28(25)	9	6.5	20	3R3
AMRU000606304R7MA1	4.7	100kHz,0.5V	40(35)	8	5.5	20	4R7
AMRU000606305R6MA1	5.6	100kHz,0.5V	45(38)	7	5	20	5R6
AMRU000606306R8MA1	6.8	100kHz,0.5V	49.5(45)	6	4.5	20	6R8
AMRU000606308R2MA1	8.2	100kHz,0.5V	55(50)	5.2	4.3	20	8R2
AMRU00060630100MA1	10	100kHz,0.5V	68(62)	5	4	20	100
AMRU00060630150MA1	15	100kHz,0.5V	125(110)	4.5	3.2	20	150
AMRU00060630220MA1	22	100kHz,0.5V	145(130)	3.5	3	20	220

Note: When ordering, please specify tolerance code. Tolerance: M=±20%

1. Operating temperature range - 40°C ~ 125°C
2. Isat for Inductance drop 30% from its value without current
3. Iirms for a 40°C temprature rise from 25°C ambient with current
4. Absolute maximum voltage 30VDC
5. Measure Equipment:
 - L: WK3260B or WK6500P
 - RDC: CHEN HWA502 or 16502
 - Isat: WK3260B+WK3265B
 - Iirms: CHROMA 1810

Power Inductor AMRx Series

**Automotive
AEC-Q200**

AMRU00060630 Type

Characteristics Graph

Inductance vs. DC Current

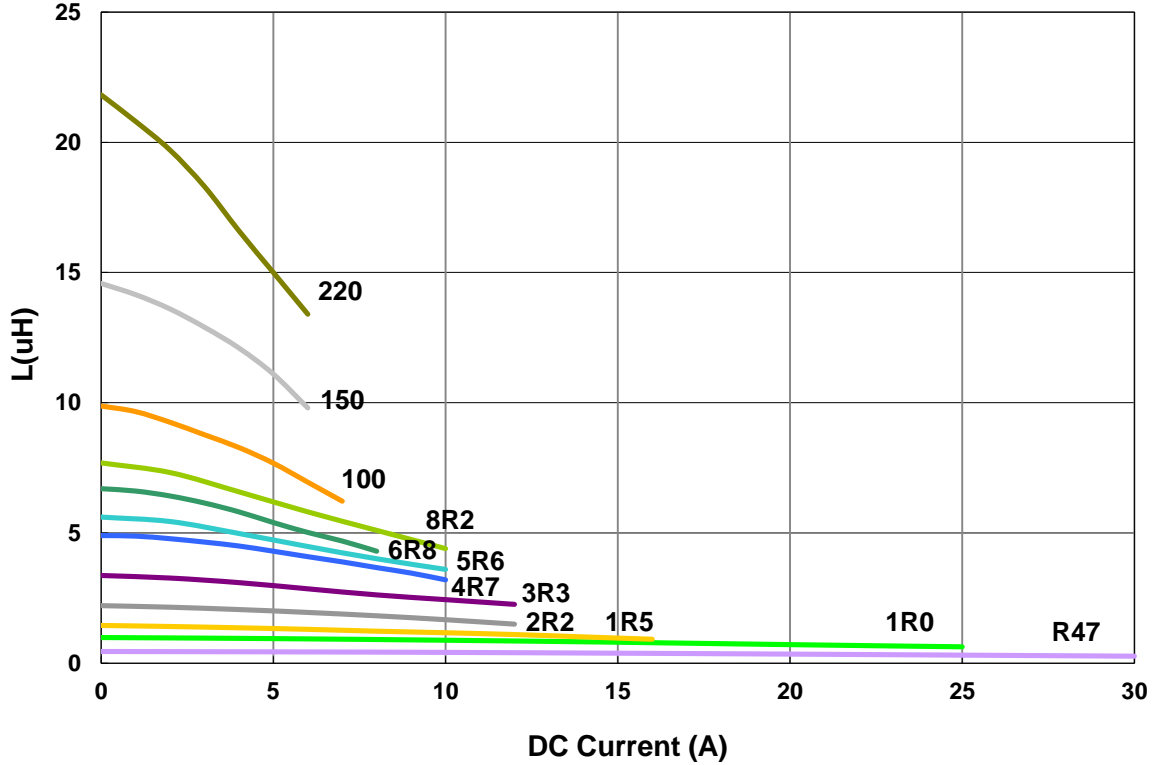

Temperature Change vs. DC Current

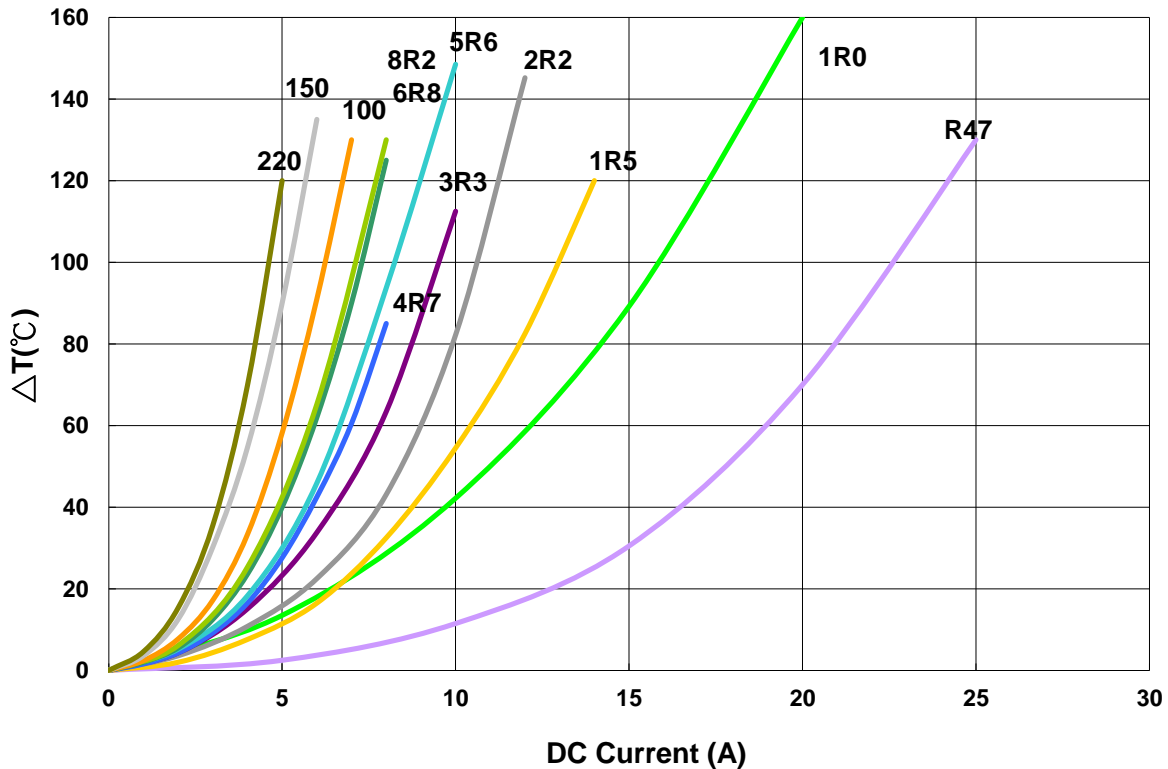

Power Inductor AMRx Series

**Automotive
AEC-Q200**

AMRU00101040 Type

■ Dimensions

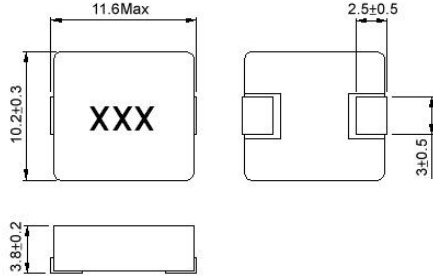

unit:mm

■ Recommended Land Pattern

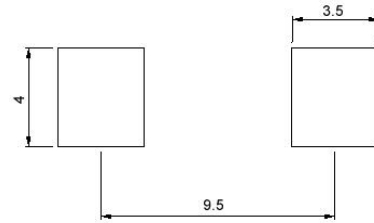

unit:mm

■ Electrical Characteristics

Part No.	Inductance (uH)	Test Freq.	RDC(mΩ) Max(Typ)	Isat (A)Typ.	Irms (A)Typ.	Tolerance (±%)	Marking
AMRU001010401R0MA1	1	100kHz/0.5V	3.3(3.0)	20	18	20	1R0
AMRU001010402R2MA1	2.2	100kHz/0.5V	6.8(6.0)	16	14	20	2R2
AMRU001010403R3MA1	3.3	100kHz/0.5V	11(10)	13	11	20	3R3
AMRU001010404R7MA1	4.7	100kHz/0.5V	16(14.5)	11	9	20	4R7
AMRU001010406R8MA1	6.8	100kHz/0.5V	24(20)	9	8	20	6R8
AMRU00101040100MA1	10	100kHz/0.5V	30(27)	7	6.5	20	100
AMRU00101040150MA1	15	100kHz/0.5V	45(40)	6.25	6	20	150
AMRU00101040220MA1	22	100kHz/0.5V	66(60)	5	4.5	20	220
AMRU00101040330MA1	33	100kHz/0.5V	100(90)	4	3.5	20	330
AMRU00101040470MA1	47	100kHz/0.5V	165(150)	3.5	3	20	470

Note: When ordering, please specify tolerance code. Tolerance: M=±20%

1. Operating temperature range - 40°C ~ 125°C
2. Isat for Inductance drop 30% from its value without current
3. I rms for a 40°C temprature rise from 25°C ambient with current
4. Absolute maximum voltage 30VDC
5. Measure Equipment:
 L: WK3260B or WK6500P
 RDC: CHEN HWA502 or 16502
 Isat: WK3260B+WK3265B
 I rms: CHROMA 1810

Power Inductor AMRx Series

**Automotive
AEC-Q200**

AMRU00101040 Type

Characteristics Graph

Inductance vs. DC Current

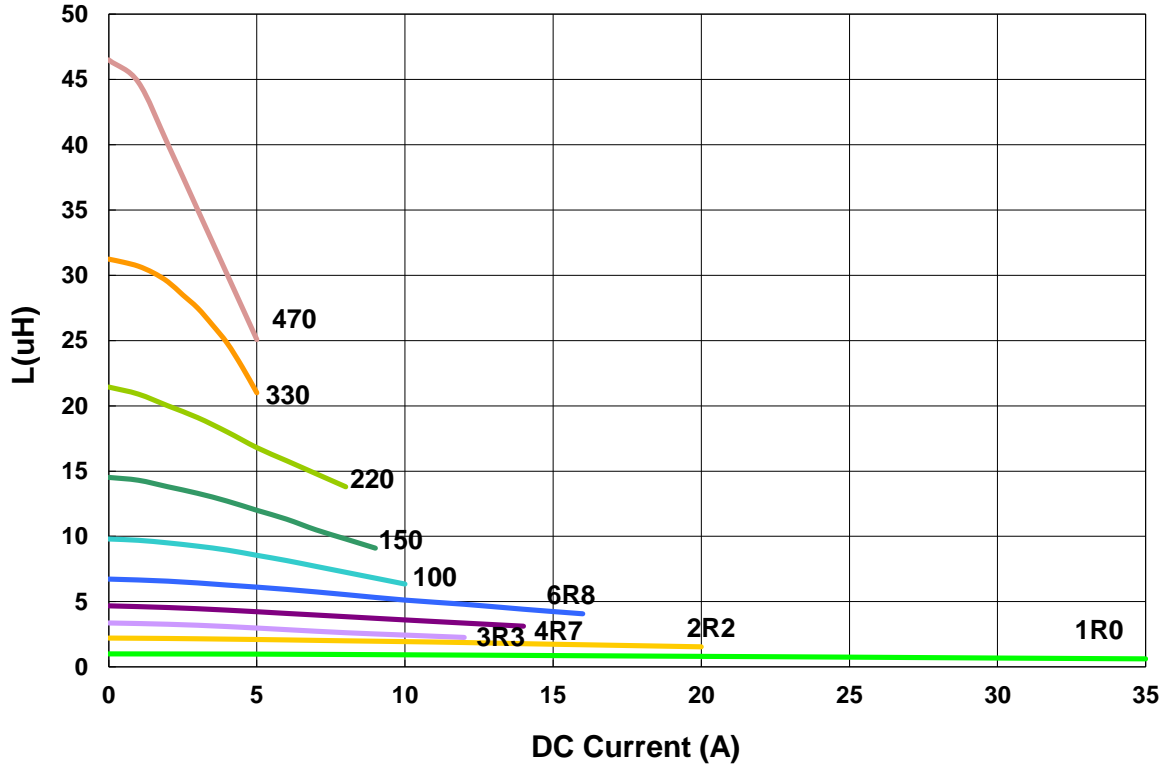

Temperature Change vs. DC Current

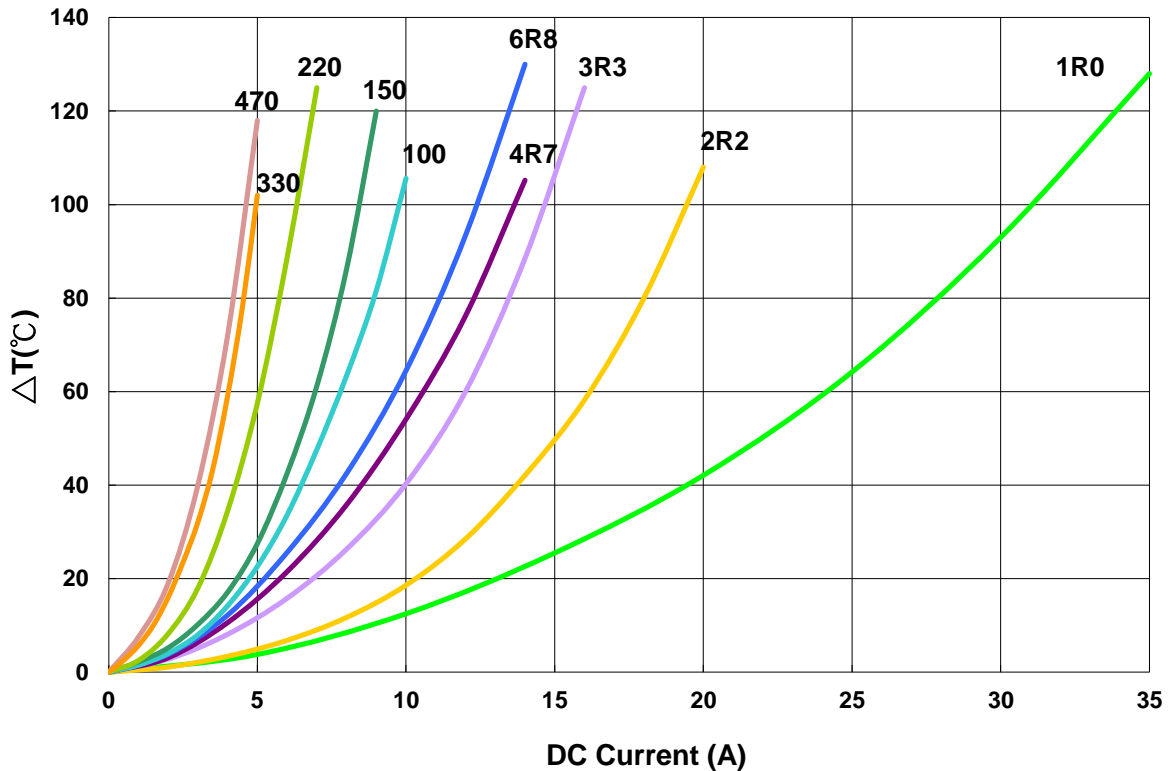

Power Inductor AMRx Series

**Automotive
AEC-Q200**

AMRU00131365 Type

Dimensions

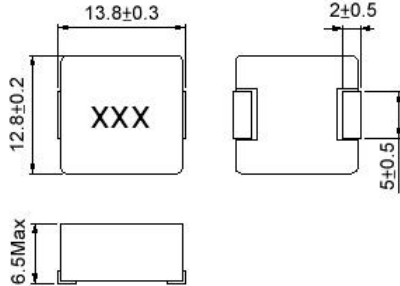

unit:mm

Recommended Land Pattern

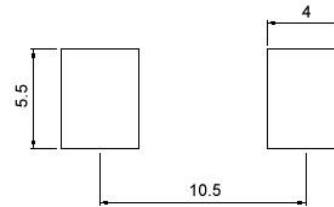

unit:mm

Electrical Characteristics

Part No.	Inductance (uH)	Test Freq.	RDC(mΩ) Max(Typ)	Isat (A)Typ.	Irms (A)Typ.	Tolerance (±%)	Marking
AMRU001313651R0MA1	1	100kHz/0.5V	2.1(1.9)	30	28	20	1R0
AMRU001313651R5MA1	1.5	100kHz/0.5V	3.0(2.7)	28	23	20	1R5
AMRU001313652R2MA1	2.2	100kHz/0.5V	4.4(3.7)	25	18	20	2R2
AMRU001313653R3MA1	3.3	100kHz/0.5V	6.8(5.7)	22	16	20	3R3
AMRU001313654R7MA1	4.7	100kHz/0.5V	7.7(7.0)	18	14	20	4R7
AMRU00131365100MA1	10	100kHz/0.5V	18(16.5)	12	10	20	100
AMRU00131365220MA1	22	100kHz/0.5V	40(35)	7	6	20	220
AMRU00131365330MA1	33	100kHz/0.5V	55(50)	6	5	20	330
AMRU00131365470MA1	47	100kHz/0.5V	100(80)	5	4	20	470

Note: When ordering, please specify tolerance code. Tolerance: M=±20%

1. Operating temperature range - 40°C ~ 125°C
2. Isat for Inductance drop 30% from its value without current
3. Irms for a 40°C temprature rise from 25°C ambient with current
4. Absolute maximum voltage 30VDC
5. Measure Equipment:
 - L: WK3260B or WK6500P
 - RDC: CHEN HWA502 or 16502
 - Isat: WK3260B+WK3265B
 - Irms: CHROMA 1810

Power Inductor AMRx Series

**Automotive
AEC-Q200**

AMRU00131365 Type

Characteristics Graph

Inductance vs. DC Current

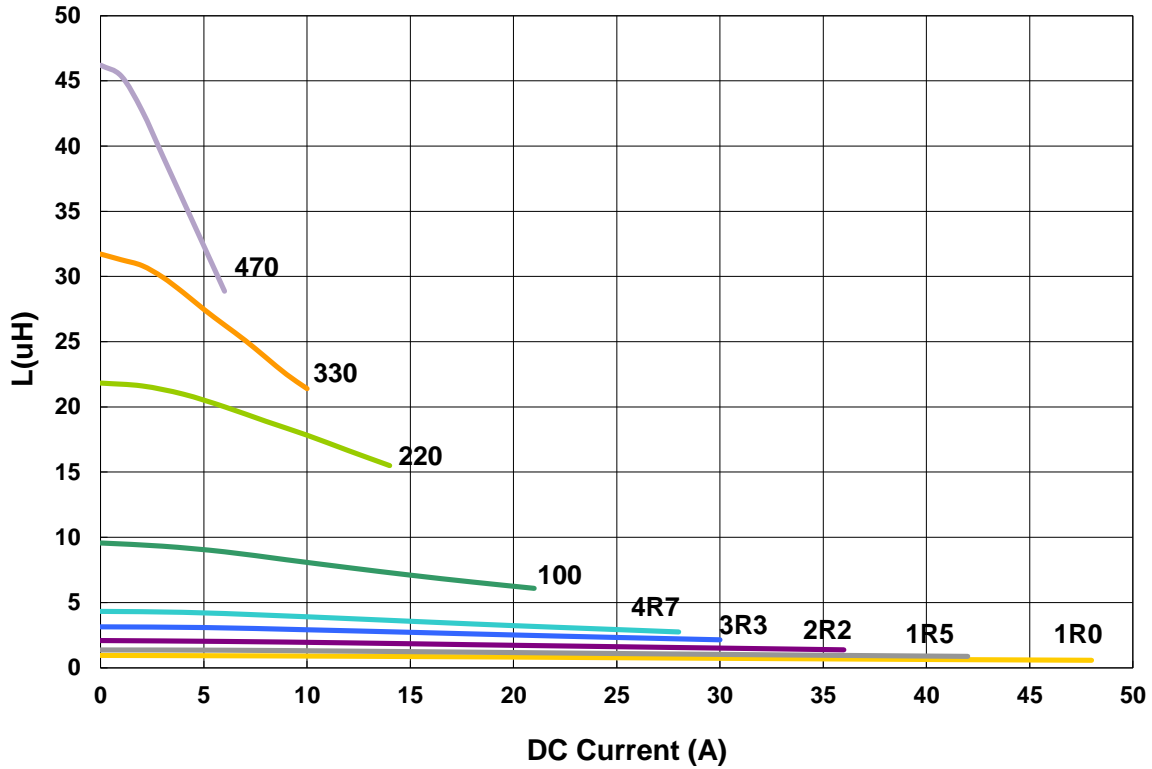

Temperature Change vs. DC Current

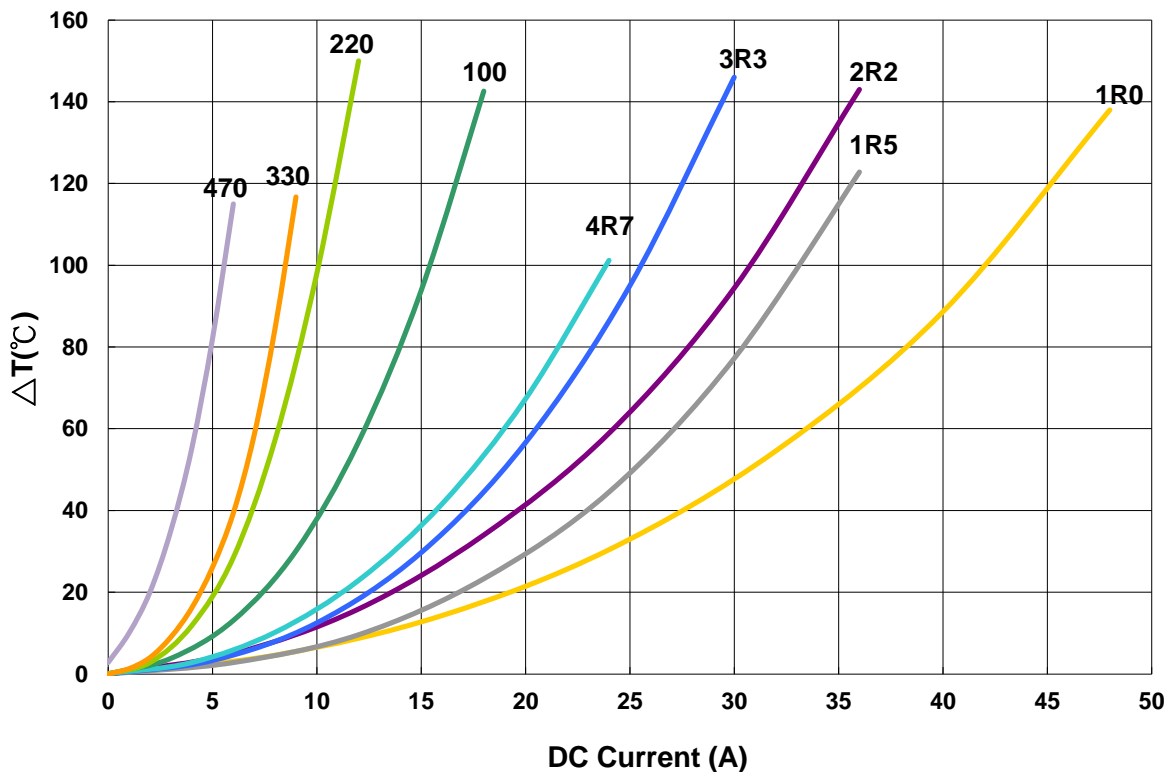

Please be sure to request approval specifications that provide further details of the products. Kindly note that the content of these specifications are subject to change or may be discontinued without prior notice. This product may not be designed/used in medical or high risk applications without Chilisin approval. Please contact our sales department before ordering.

Power Inductor AMRx Series

**Automotive
AEC-Q200**

■ Packaging

Tape Dimensions

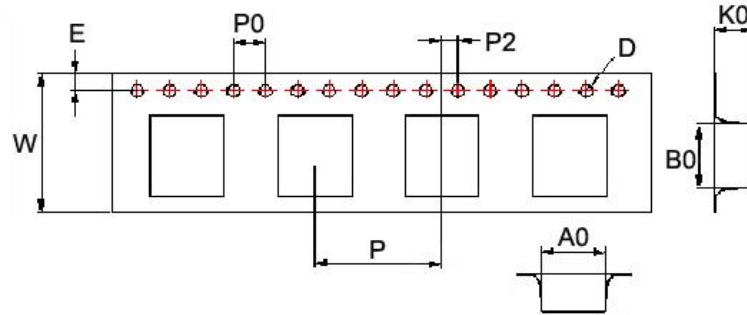

Reel Dimensions

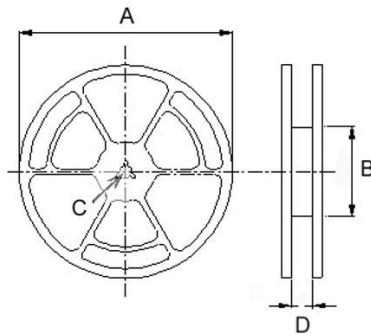

Dimensions in mm

TYPE	Tape Dimensions									Reel Dimensions				Quantity
	A0	B0	K0	D	E	W	P	P0	P2	A	B	C	D	PCS / REEL
AMRU00040412	4.4	4.9	1.5	1.55	1.75	12	8	4	2	330	100	13	13.4	2000
AMRU00040420	4.3	4.9	2.4	1.55	1.75	12	8	4	2	330	100	13	13.4	2000
AMRU00060630	7.1	7.6	3.4	1.55	1.75	16	12	4	2	330	100	13	16	1000
AMRU00101040	10.6	11.7	4.25	1.55	1.75	24	16	4	2	330	100	13	24.4	500
AMRU00131365	13.1	14.6	6.75	1.55	1.75	24	16	4	2	330	100	13	24.4	500

X-ON Electronics

Largest Supplier of Electrical and Electronic Components

Click to view similar products for [Fixed Inductors](#) category:

Click to view products by [Chilisin](#) manufacturer:

Other Similar products are found below :

[CR32NP-100KC](#) [CR54NP-470LC](#) [70F224AI](#) [MGDQ4-00004-P](#) [MHQ1005P10NJ](#) [MHQ1005P1N0S](#) [MHQ1005P2N4S](#) [MHQ1005P3N6S](#)
[MHQ1005P5N1S](#) [MHQ1005P8N2J](#) [PE-53601NL](#) [PE-53602NL](#) [PG0936.113NLT](#) [9220-20](#) [9310-16](#) [PM06-2N7](#) [PM06-39NJ](#) [A01TK](#)
[1206CS-471XJ](#) [HC2-R47-R](#) [HC8-1R2-R](#) [HCF1305-3R3-R](#) [1206CS-151XG](#) [RCH664NP-140L](#) [RCH664NP-4R7M](#) [RCP1317NP-391L](#)
[RCR110DNP-331L](#) [DH2280-4R7M](#) [DS1608C-106](#) [B10TJ](#) [B82498B3101J000](#) [ELJ-RE27NJF2](#) [1812CS-153XJ](#) [1812CS-183XJ](#) [1812CS-](#)
[223XJ](#) [1812LS-104XJ](#) [1812LS-105XJ](#) [1812LS-124XJ](#) [1812LS-154XJ](#) [1812LS-223XJ](#) [1812LS-224XJ](#) [1812LS-563XJ](#) [1812LS-683XJ](#)
[1812LS-824XJ](#) [NIN-FB101JTR110F](#) [NIN-FB471JTR62F](#) [NIN-FC1R5JTR220F](#) [NIN-HCR15JTRF](#) [NIN-HCR33JTRF](#) [NIN-HDR22JTRF](#)