

BDCD Series



BDCD Series provides high current in compact package size with magnetically shielded construction. This power inductor is an excellent power solution for space-limited devices.

Features

- RoHS, Halogen Free and REACH Compliance
- Monolithic, magnetically shielded
- Capable for large current

Applications

- Smartphones, tablets and wearable devices
- HDD, SSD and PC peripheral devices
- DSC, camcoders
- PND
- DC/DC converters

Product Identification

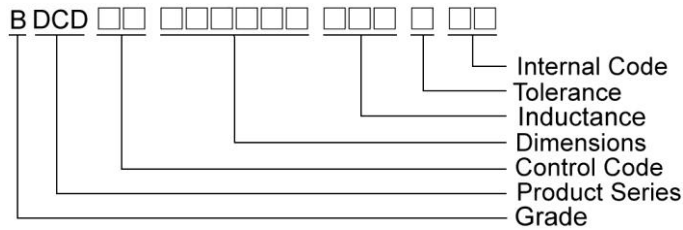

Shape and Dimensions

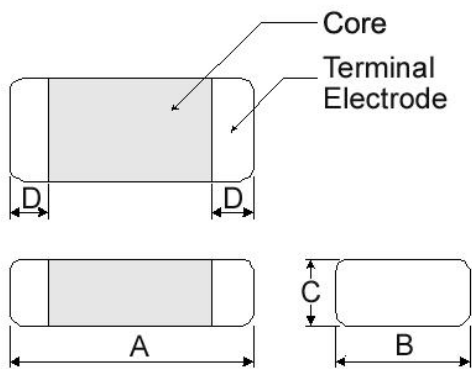

Dimensions in mm

TYPE	A	B	C	D
BDCD00201610	2.0±0.2	1.6±0.2	1.0Max	0.5±0.3
BDCD00201612	2.0±0.2	1.6±0.2	1.2Max	0.5±0.3
BDCD00252010	2.5±0.2	2.0±0.2	1.0Max	0.6±0.3
BDCD00252012	2.5±0.2	2.0±0.2	1.2Max	0.6±0.3
BDCD00322510	3.2±0.3	2.5±0.3	1.0Max	0.5±0.3
BDCD00322512	3.2±0.3	2.5±0.3	1.2Max	0.5±0.3

Recommended Pattern

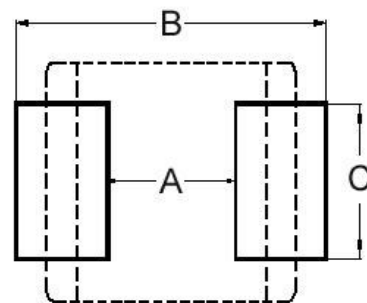

Dimensions in mm

TYPE	A	B	C
BDCD00201610	0.7	2.3	1.8
BDCD00201612	0.7	2.3	1.8
BDCD00252010	1.2	2.8	2.3
BDCD00252012	1.2	2.8	2.3
BDCD00322510	1.7	3.5	2.8
BDCD00322512	1.7	3.5	2.8

Molding Power Inductors – BDCD Series

Electrical Characteristics

Part Number	Inductance (uH)	Tolerance (±%)	Test Frequency (MHz)	RDC(mΩ) Max(Typ.)	Isat(A) Max(Typ.)	Irms(A) Max(Typ.)
BDCD00201610R24MS1	0.24	20	2	40(28)	4.2(6.0)	4.0(4.5)
BDCD00201610R33MS1	0.33	20	2	48(40)	4.0(5.5)	3.5(3.8)
BDCD00201610R47MS1	0.47	20	2	54(44)	3.2(5.0)	3.0(3.6)
BDCD00201610R56MS1	0.56	20	2	59(46)	2.8(4.6)	2.8(3.3)
BDCD00201610R68MS1	0.68	20	2	72(55)	2.7(4.2)	2.4(3.0)
BDCD002016101R0MS1	1.0	20	2	96(81)	2.2(3.4)	2.0(2.3)
BDCD002016101R5MS1	1.5	20	2	150(122)	2.1(2.8)	1.6(2.0)
BDCD002016102R2MS1	2.2	20	2	204(170)	2.0(2.4)	1.3(1.6)

Note: When ordering, please specify tolerance code. Tolerance: M=±20%

- Operating temperature range - 40°C ~ 125°C(Including self - temperature rise)
- Isat for Inductance drop 30% from its value without current
- I rms for a 40°C temperature rise from 25°C ambient with current
- Absolute maximum voltage 25VDC
- Measure Equipment :
 L : Agilent E4991/HP4286A+16197A (or equivalent), 2MHz 0.2V
 RDC : CHEN HWA502BC/HP4338B (or equivalent)
 Isat : Agilent E4980A+HP42841A (or equivalent)
 I rms : Agilent 6641 SYSTEM DC POWER SUPPLY (or equivalent)

Test Instruments : E4991A Impedance / Material Analyzer

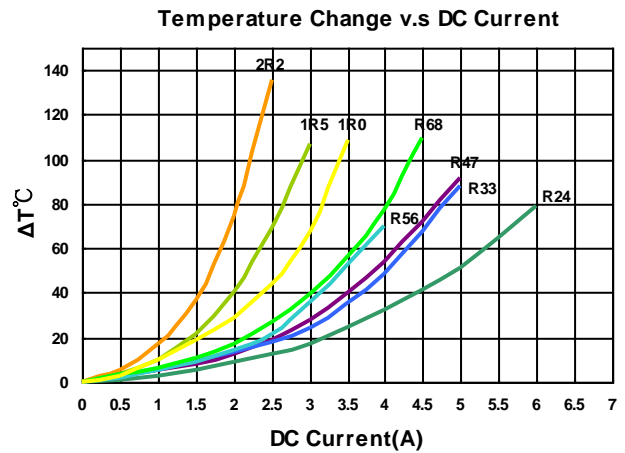
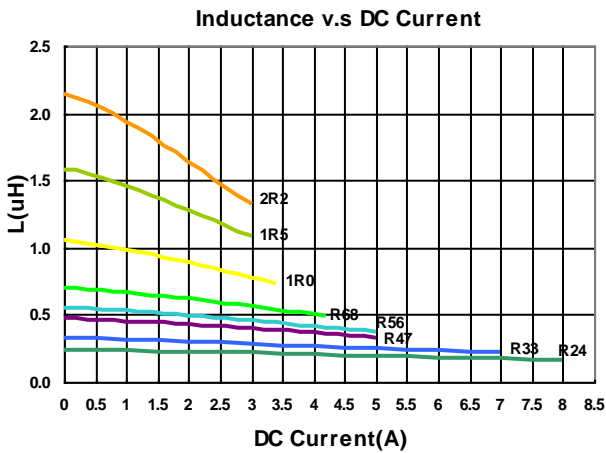

Molding Power Inductors – BDCD Series

Electrical Characteristics

Part Number	Inductance (uH)	Tolerance (±%)	Test Frequency (MHz)	RDC(mΩ) Max(Typ.)	Isat(A) Max(Typ.)	Irms(A) Max(Typ.)
BDCD00201610R24ML1	0.24	20	2	30(23)	5.0(6.0)	3.8(4.4)
BDCD00201610R33ML1	0.33	20	2	35(27)	4.5(5.0)	3.4(3.8)
BDCD00201610R47ML1	0.47	20	2	41(34)	4.0(4.5)	2.9(3.3)
BDCD00201610R68ML1	0.68	20	2	53(44)	3.3(3.6)	2.5(2.9)
BDCD002016101R0ML1	1.0	20	2	72(60)	2.8(3.2)	2.2(2.5)
BDCD002016101R5ML1	1.5	20	2	110(92)	2.2(2.8)	1.8(2.1)
BDCD002016102R2ML1	2.2	20	2	170(142)	1.8(2.1)	1.5(1.7)

Note: When ordering, please specify tolerance code. Tolerance: M=±20%

- Operating temperature range - 40°C ~ 125°C(Including self - temperature rise)
- Isat for Inductance drop 30% from its value without current
- I rms for a 40°C temperature rise from 25°C ambient with current
- Absolute maximum voltage 25VDC
- Measure Equipment :
 L : Agilent E4991/HP4286A+16197A (or equivalent), 2MHz 0.2V
 RDC : CHEN HWA502BC/HP4338B (or equivalent)
 Isat : Agilent E4980A+HP42841A (or equivalent)
 I rms : Agilent 6641 SYSTEM DC POWER SUPPLY (or equivalent)

Test Instruments : E4991A Impedance / Material Analyzer

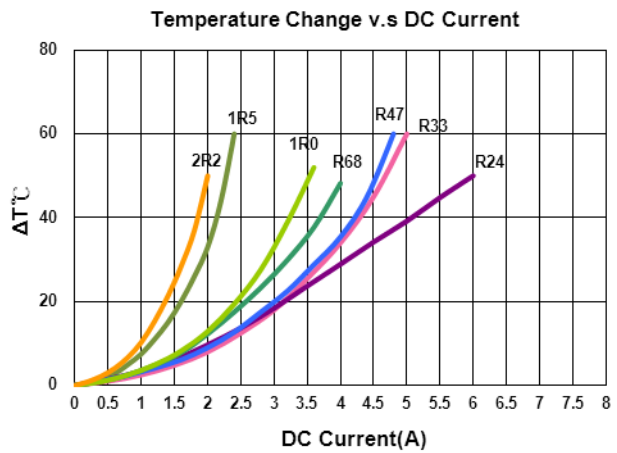
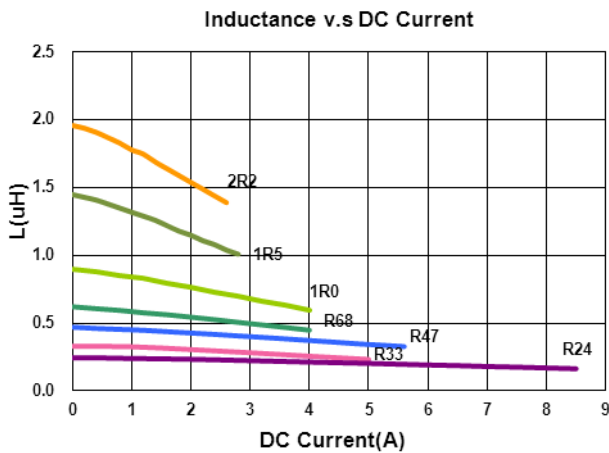

Molding Power Inductors – BDCD Series

Electrical Characteristics

Part Number	Inductance (uH)	Tolerance (±%)	Test Frequency (MHz)	RDC(mΩ) Max(Typ.)	Isat(A) Max(Typ.)	Irms(A) Max(Typ.)
BDCD00201612R24MS1	0.24	20	2	35(25)	5.5(6.5)	4.2(4.8)
BDCD00201612R47MS1	0.47	20	2	52(40)	3.8(5.1)	3.2(3.8)
BDCD00201612R68MS1	0.68	20	2	70(53)	3.3(4.8)	2.6(3.2)
BDCD002016121R0MS1	1.0	20	2	82(67)	3.1(3.9)	2.3(2.7)
BDCD002016121R5MS1	1.5	20	2	120(95)	2.6(3.2)	2.2(2.6)
BDCD002016122R2MS1	2.2	20	2	195(165)	2.0(2.6)	1.3(1.7)

Note: When ordering, please specify tolerance code. Tolerance: M=±20%

- Operating temperature range - 40°C ~ 125°C(Including self - temperature rise)
- Isat for Inductance drop 30% from its value without current
- I rms for a 40°C temperature rise from 25°C ambient with current
- Absolute maximum voltage 25VDC
- Measure Equipment :
 L : Agilent E4991/HP4286A+16197A (or equivalent), 2MHz 0.2V
 RDC : CHEN HWA502BC/HP4338B (or equivalent)
 Isat : Agilent E4980A+HP42841A (or equivalent)
 I rms : Agilent 6641 SYSTEM DC POWER SUPPLY (or equivalent)

Test Instruments : E4991A Impedance / Material Analyzer

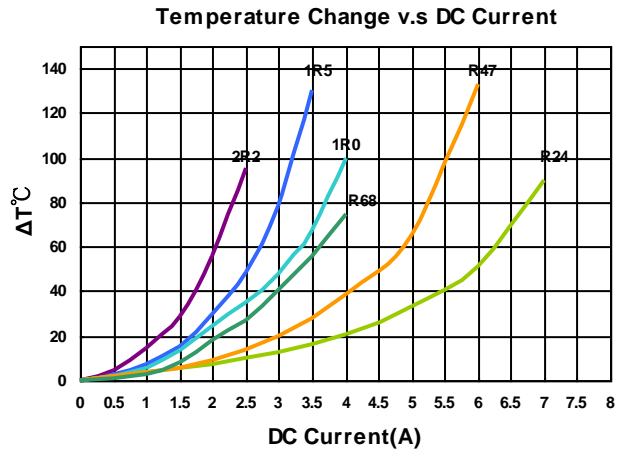
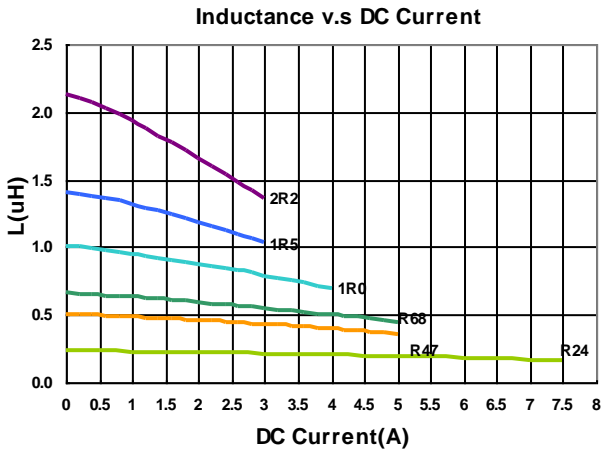

Molding Power Inductors – BDCD Series

Electrical Characteristics

Part Number	Inductance (uH)	Tolerance (±%)	Test Frequency (MHz)	RDC(mΩ) Max(Typ.)	Isat(A) Max(Typ.)	Irms(A) Max(Typ.)
BDCD00252010R24MS1	0.24	20	2	40(24)	7.5(9.5)	4.5(5.0)
BDCD00252010R47MS1	0.47	20	2	46(36)	5.2(6.5)	3.1(3.6)
BDCD00252010R68MS1	0.68	20	2	65(49)	3.8(5.0)	2.9(3.3)
BDCD002520101R0MS1	1.0	20	2	78(60)	3.4(4.3)	2.5(3.0)
BDCD002520101R5MS1	1.5	20	2	105(82)	3.2(4.0)	2.2(2.9)
BDCD002520102R2MS1	2.2	20	2	156(130)	2.6(3.2)	1.4(1.8)

Note: When ordering, please specify tolerance code. Tolerance: M=±20%

- Operating temperature range - 40°C ~ 125°C(Including self - temperature rise)
- Isat for Inductance drop 30% from its value without current
- I rms for a 40°C temperature rise from 25°C ambient with current
- Absolute maximum voltage 25VDC
- Measure Equipment :
 L : Agilent E4991/HP4286A+16197A (or equivalent), 2MHz 0.2V
 RDC : CHEN HWA502BC/HP4338B (or equivalent)
 Isat : Agilent E4980A+HP42841A (or equivalent)
 I rms : Agilent 6641 SYSTEM DC POWER SUPPLY (or equivalent)

Test Instruments : E4991A Impedance / Material Analyzer

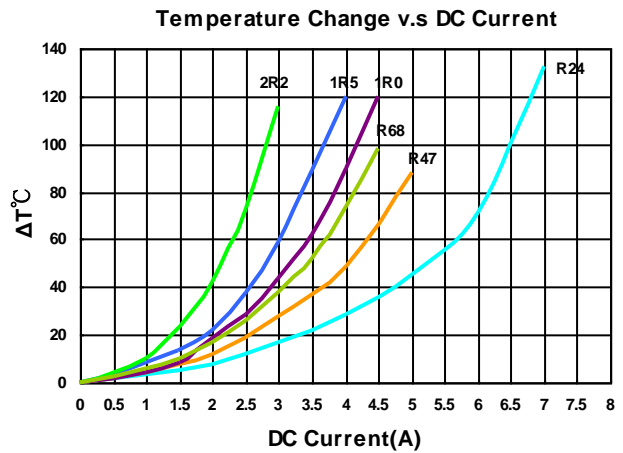
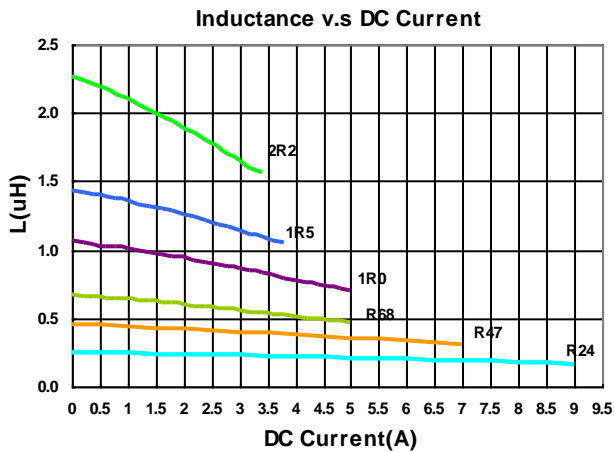

Molding Power Inductors – BDCD Series

Electrical Characteristics

Part Number	Inductance (uH)	Tolerance (±%)	Test Frequency (MHz)	RDC(mΩ) Max(Typ.)	Isat(A) Max(Typ.)	Irms(A) Max(Typ.)
BDCD00252010R33ML1	0.33	20	2	31(25)	5.0(6.0)	3.8(4.4)
BDCD00252010R47ML1	0.47	20	2	35(29)	4.2(4.7)	3.4(3.9)
BDCD00252010R68ML1	0.68	20	2	48(40)	3.7(4.0)	3.0(3.5)
BDCD002520101R0ML1	1.0	20	2	65(54)	3.2(3.6)	2.6(3.0)
BDCD002520101R5ML1	1.5	20	2	94(78)	2.9(3.3)	2.1(2.4)
BDCD002520102R2ML1	2.2	20	2	120(100)	2.3(2.7)	1.8(2.1)

Note: When ordering, please specify tolerance code. Tolerance: M=±20%

- Operating temperature range - 40°C ~ 125°C(Including self - temperature rise)
- Isat for Inductance drop 30% from its value without current
- I rms for a 40°C temperature rise from 25°C ambient with current
- Absolute maximum voltage 25VDC
- Measure Equipment :
 L : Agilent E4991/HP4286A+16197A (or equivalent), 2MHz 0.2V
 RDC : CHEN HWA502BC/HP4338B (or equivalent)
 Isat : Agilent E4980A+HP42841A (or equivalent)
 I rms : Agilent 6641 SYSTEM DC POWER SUPPLY (or equivalent)

Test Instruments : E4991A Impedance / Material Analyzer

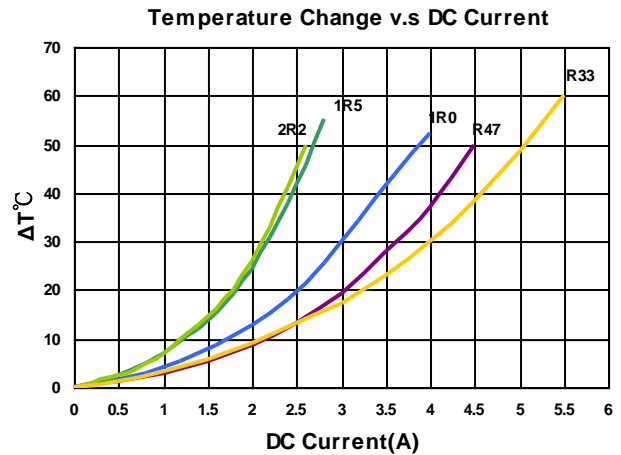
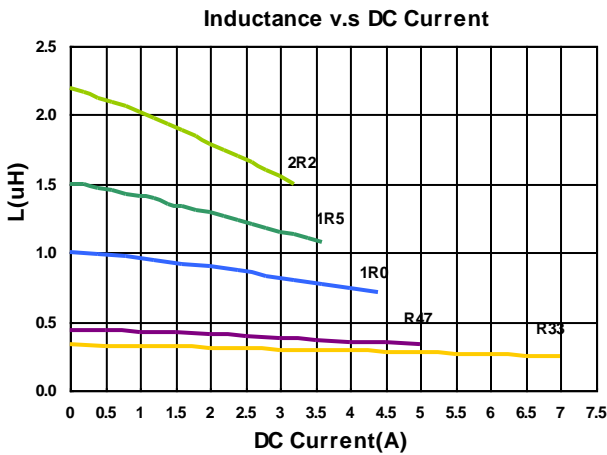

Molding Power Inductors – BDCD Series

Electrical Characteristics

Part Number	Inductance (uH)	Tolerance (±%)	Test Frequency (MHz)	RDC(mΩ) Max(Typ.)	Isat(A) Max(Typ.)	Irms(A) Max(Typ.)
BDCD00252012R33MS1	0.33	20	2	35(27)	6.8(8.5)	4.0(4.6)
BDCD00252012R47MS1	0.47	20	2	39(29)	6.2(7.8)	3.7(4.4)
BDCD00252012R68MS1	0.68	20	2	46(40)	5.5(6.5)	3.3(3.7)
BDCD002520121R0MS1	1.0	20	2	59(45)	4.0(5.0)	3.0(3.5)
BDCD002520121R5MS1	1.5	20	2	70(62)	3.4(4.0)	2.5(2.7)
BDCD002520122R2MS1	2.2	20	2	115(102)	3.3(3.8)	2.0(2.3)

Note: When ordering, please specify tolerance code. Tolerance: M=±20%

- Operating temperature range - 40°C ~ 125°C(Including self - temperature rise)
- Isat for Inductance drop 30% from its value without current
- I rms for a 40°C temperature rise from 25°C ambient with current
- Absolute maximum voltage 25VDC
- Measure Equipment :
 L : Agilent E4991/HP4286A+16197A (or equivalent), 2MHz 0.2V
 RDC : CHEN HWA502BC/HP4338B (or equivalent)
 Isat : Agilent E4980A+HP42841A (or equivalent)
 I rms : Agilent 6641 SYSTEM DC POWER SUPPLY (or equivalent)

Test Instruments : E4991A Impedance / Material Analyzer

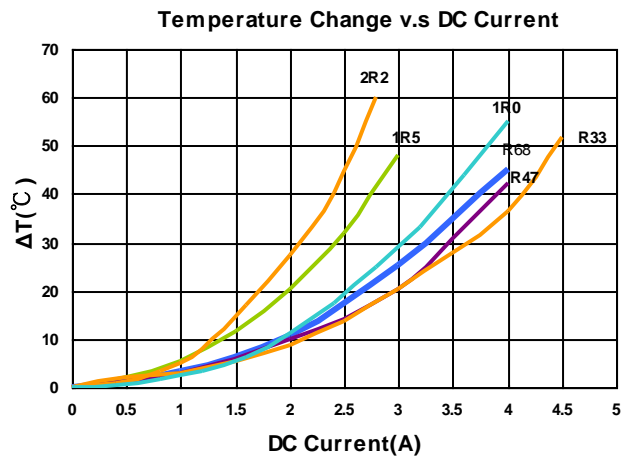
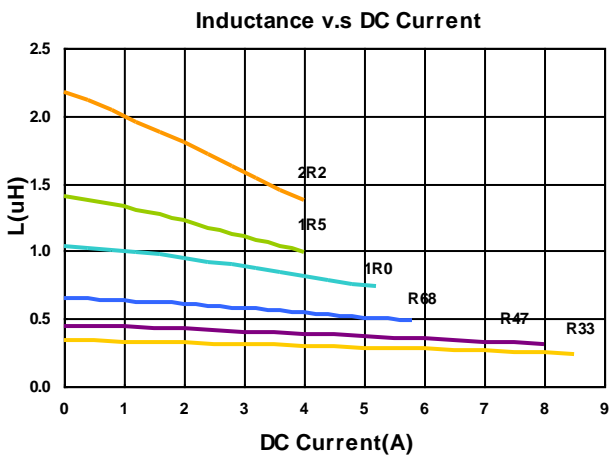

Molding Power Inductors – BDCD Series

Electrical Characteristics

Part Number	Inductance (uH)	Tolerance (±%)	Test Frequency (MHz)	RDC(mΩ) Max(Typ.)	Isat(A) Max(Typ.)	Irms(A) Max(Typ.)
BDCD00252012R47ML1	0.47	20	2	34(30)	5.2(6.0)	4.1(4.7)
BDCD002520121R0ML1	1.0	20	2	56(45)	3.6(4.5)	3.2(3.7)
BDCD002520122R2ML1	2.2	20	2	102(80)	2.5(3.0)	2.2(2.6)

Note: When ordering, please specify tolerance code. Tolerance: M=±20%

- Operating temperature range - 40°C ~ 125°C(Including self - temperature rise)
- Isat for Inductance drop 30% from its value without current
- I rms for a 40°C temperature rise from 25°C ambient with current
- Absolute maximum voltage 25VDC
- Measure Equipment :
 L : Agilent E4991/HP4286A+16197A (or equivalent), 2MHz 0.2V
 RDC : CHEN HWA502BC/HP4338B (or equivalent)
 Isat : Agilent E4980A+HP42841A (or equivalent)
 I rms : Agilent 6641 SYSTEM DC POWER SUPPLY (or equivalent)

Test Instruments : E4991A Impedance / Material Analyzer

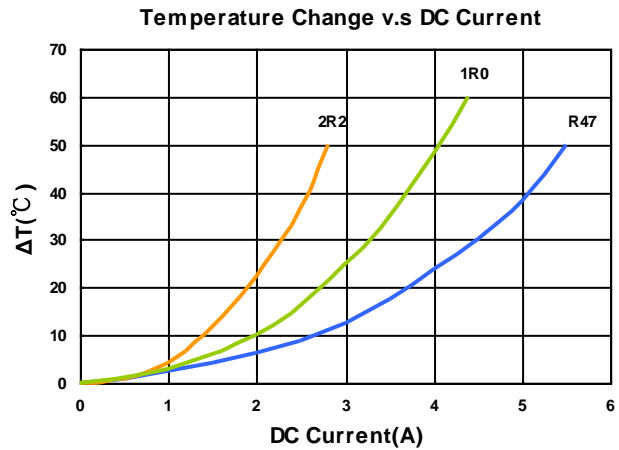
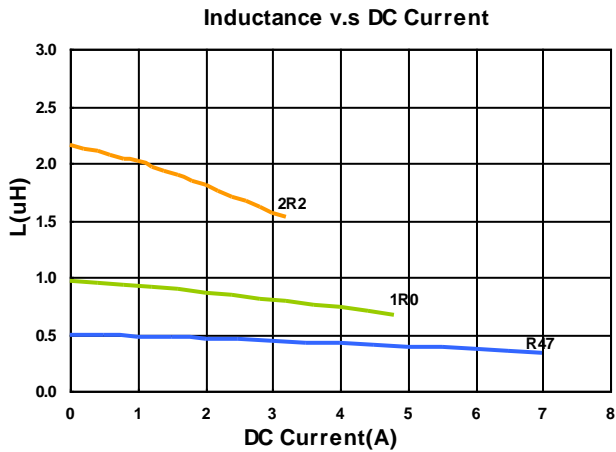

Molding Power Inductors – BDCD Series

Electrical Characteristics

Part Number	Inductance (uH)	Tolerance (±%)	Test Frequency (MHz)	RDC(mΩ) Max(Typ.)	Isat(A) Max(Typ.)	Irms(A) Max(Typ.)
BDCD00322510R47MS1	0.47	20	2	37(30)	5.8(6.6)	3.6(4.2)
BDCD003225101R0MS1	1.0	20	2	56(49)	4.0(4.6)	3.0(3.3)
BDCD003225101R5MS1	1.5	20	2	75(66)	3.4(4.0)	2.6(3.0)
BDCD003225102R2MS1	2.2	20	2	108(95)	2.7(3.2)	2.2(2.5)

Note: When ordering, please specify tolerance code. Tolerance: M=±20%

- Operating temperature range - 40°C ~ 125°C(Including self - temperature rise)
- Isat for Inductance drop 30% from its value without current
- I rms for a 40°C temperature rise from 25°C ambient with current
- Absolute maximum voltage 25VDC
- Measure Equipment :
 L : Agilent E4991/HP4286A+16197A (or equivalent), 2MHz 0.2V
 RDC : CHEN HWA502BC/HP4338B (or equivalent)
 Isat : Agilent E4980A+HP42841A (or equivalent)
 I rms : Agilent 6641 SYSTEM DC POWER SUPPLY (or equivalent)

Test Instruments : E4991A Impedance / Material Analyzer

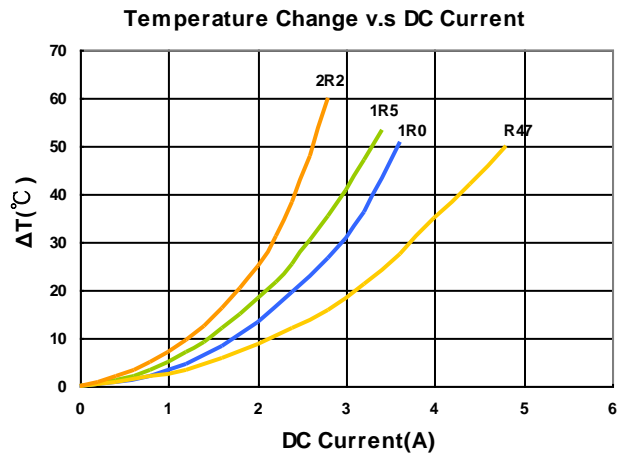
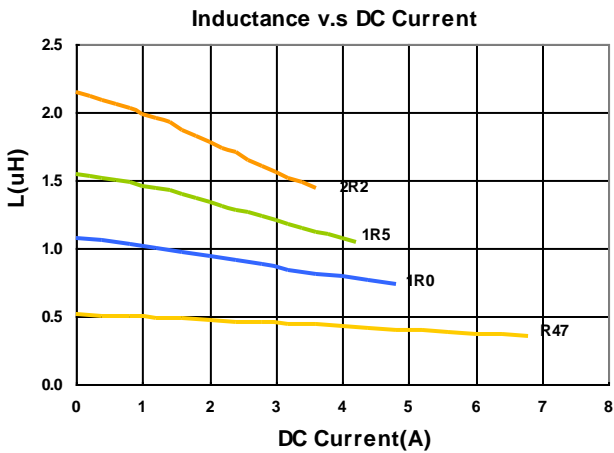

Molding Power Inductors – BDCD Series

Electrical Characteristics

Part Number	Inductance (uH)	Tolerance (±%)	Test Frequency (MHz)	RDC(mΩ) Max(Typ.)	Isat(A) Max(Typ.)	Irms(A) Max(Typ.)
BDCD00322512R47MS1	0.47	20	2	27(21)	8.0(9.0)	5.0(5.8)
BDCD00322512R68MS1	0.68	20	2	34(26)	6.3(7.5)	4.0(4.6)
BDCD003225121R0MS1	1.0	20	2	42(34)	5.8(6.3)	3.8(4.2)
BDCD003225121R5MS1	1.5	20	2	68(58)	4.0(4.5)	2.8(3.2)
BDCD003225122R2MS1	2.2	20	2	85(75)	3.6(4.0)	2.4(2.7)

Note: When ordering, please specify tolerance code. Tolerance: M=±20%

- Operating temperature range - 40°C ~ 125°C(Including self - temperature rise)
- Isat for Inductance drop 30% from its value without current
- I rms for a 40°C temperature rise from 25°C ambient with current
- Absolute maximum voltage 25VDC
- Measure Equipment :
 L : Agilent E4991/HP4286A+16197A (or equivalent), 2MHz 0.2V
 RDC : CHEN HWA502BC/HP4338B (or equivalent)
 Isat : Agilent E4980A+HP42841A (or equivalent)
 I rms : Agilent 6641 SYSTEM DC POWER SUPPLY (or equivalent)

Test Instruments : E4991A Impedance / Material Analyzer

Inductance v.s DC Current

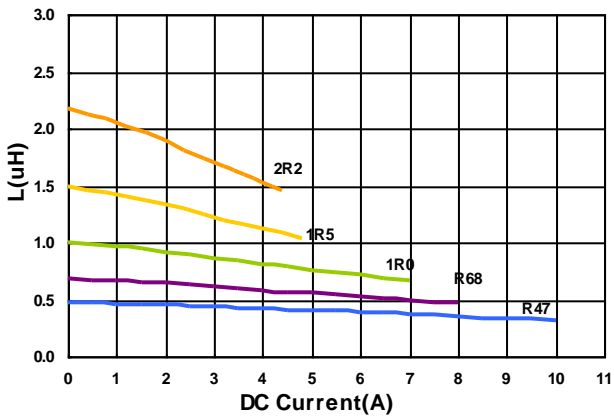

Temperature Change v.s DC Current

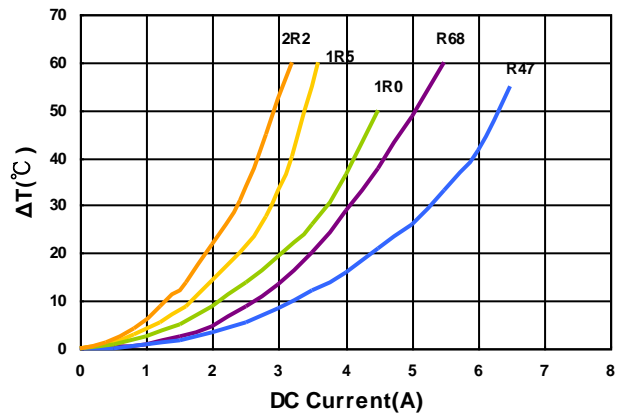

Packaging Specifications

Tape Dimensions

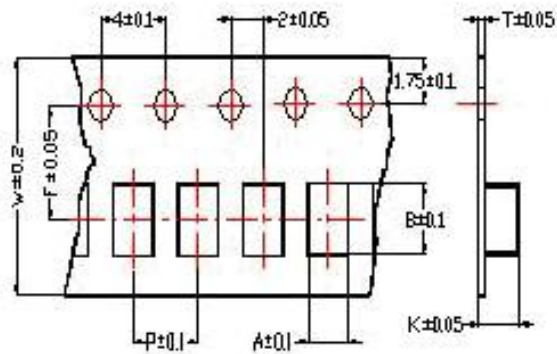

Tape Material

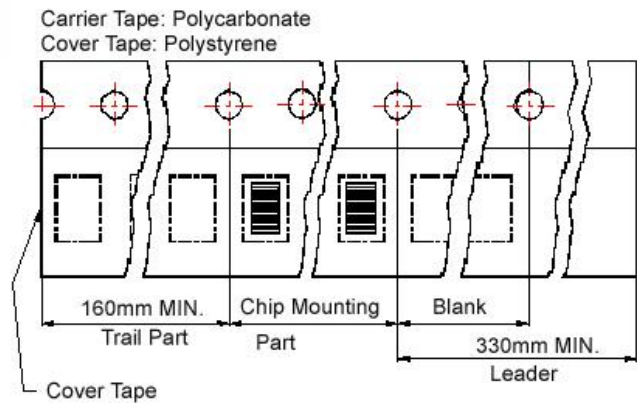

Reel Dimensions

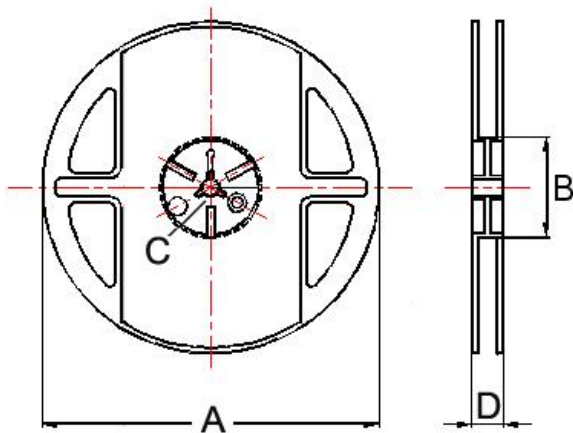

Dimensions in mm

TYPE	Tape Dimensions							Reel Dimensions				Quantity PCS / REEL
	A	B	T	W	P	F	K	A	B	C	D	
BDCD00201610	1.80	2.20	0.22	8	4	3.5	1.15	178	60	12	1.5	3000
BDCD00201612	1.80	2.20	0.22	8	4	3.5	1.15	178	60	12	1.5	3000
BDCD00252010	2.25	2.80	0.22	8	4	3.5	1.15	178	60	12	1.5	3000
BDCD00252012	2.25	2.80	0.22	8	4	3.5	1.35	178	60	12	1.5	3000
BDCD00322510	2.80	3.55	0.23	8	4	3.5	1.20	178	60	12	1.5	3000
BDCD00322512	2.80	3.50	0.23	8	4	3.5	1.34	178	60	12	1.5	3000

X-ON Electronics

Largest Supplier of Electrical and Electronic Components

Click to view similar products for [Fixed Inductors](#) category:

Click to view products by [Chilisin](#) manufacturer:

Other Similar products are found below :

[CR43NP-680KC](#) [CR54NP-470LC](#) [CR54NP-820KC](#) [CR54NP-8R5MC](#) [70F224AI](#) [MGDQ4-00004-P](#) [MHL1ECTTP18NJ](#) [MHQ1005P10NJ](#)
[MHQ1005P1N0S](#) [MHQ1005P2N4S](#) [MHQ1005P3N6S](#) [MHQ1005P5N1S](#) [MHQ1005P8N2J](#) [PE-51506NL](#) [PE-53601NL](#) [PE-53602NL](#) [PE-53630NL](#) [PE-53824SNLT](#) [PE-92100NL](#) [PG0434.801NLT](#) [PG0936.113NLT](#) [9220-20](#) [9310-16](#) [PM06-2N7](#) [PM06-39NJ](#) [A01TK](#) [1206CS-471XJ](#) [HC2LP-R47-R](#) [HC2-R47-R](#) [HC3-2R2-R](#) [HC3-R50-R](#) [HC8-1R2-R](#) [HCF1305-3R3-R](#) [1206CS-151XG](#) [RCH664NP-140L](#) [RCH664NP-4R7M](#) [RCH8011NP-221L](#) [RCP1317NP-332L](#) [RCP1317NP-391L](#) [RCR1010NP-470M](#) [RCR110DNP-331L](#) [DH2280-4R7M](#) [DS1608C-106](#)
[ASPI-4020HI-R10M-T](#) [B10TJ](#) [B82498B3680J000](#) [ELJ-RE27NJF2](#) [1812CS-153XJ](#) [1812CS-183XJ](#) [1812CS-223XJ](#)