

## BDHE Series



The BDHE Series is designed specifically to enhance both PFM and PWM application performance. Q(Rac) value at light load and the RDC value at heavy load are both exceptional. Furthermore, the saturated current performance is also optimal, helping to reduce the ripple current and enhance the efficiency.

### Features

- RoHS, Halogen Free and REACH Compliance
- High Efficiency
- Excellent Q, RDC and saturation current
- Low profile and miniature size down to 1.6\*0.8\*0.8mm

### Applications

- Smartphones, tablets and wearable devices
- HDD, SSD and PC peripheral devices
- DSC, camcorders
- PND
- DC/DC converters

### Product Identification

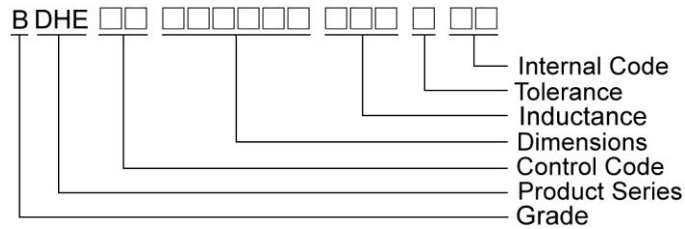

### Shape and Dimensions

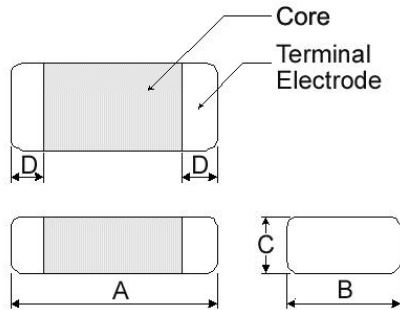

Dimensions in mm

| TYPE         | A       | B        | C        | D       |
|--------------|---------|----------|----------|---------|
| BDHE00160808 | 1.6±0.2 | 0.80±0.2 | 0.8Max   | 0.3±0.2 |
| BDHE00201208 | 2.0±0.2 | 1.25±0.2 | 0.8Max   | 0.5±0.3 |
| BDHE00201210 | 2.0±0.2 | 1.25±0.2 | 1.0Max   | 0.5±0.3 |
| BDHE00201608 | 2.0±0.2 | 1.60±0.2 | 0.8Max   | 0.5±0.3 |
| BDHE00201610 | 2.0±0.2 | 1.60±0.2 | 1.0Max   | 0.5±0.3 |
| BDHE00201612 | 2.0±0.2 | 1.60±0.2 | 1.2Max   | 0.5±0.3 |
| BDHE00252010 | 2.5±0.3 | 2.00±0.3 | 1.0Max   | 0.6±0.3 |
| BDHE00252012 | 2.5±0.3 | 2.00±0.3 | 1.2Max   | 0.6±0.3 |
| BDHE00322510 | 3.2±0.3 | 2.50±0.3 | 1.0Max   | 0.5±0.3 |
| BDHE00322512 | 3.2±0.3 | 2.50±0.3 | 1.2Max   | 0.5±0.3 |
| BDHE00322525 | 3.2±0.3 | 2.50±0.3 | 2.50±0.3 | 0.5±0.3 |

### Recommended Pattern

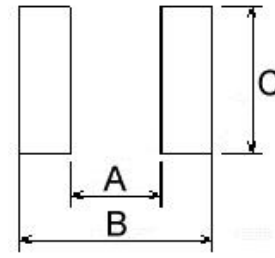

Dimensions in mm

| TYPE         | A   | B   | C    |
|--------------|-----|-----|------|
| BDHE00160808 | 0.7 | 1.8 | 1    |
| BDHE00201208 | 0.8 | 2.4 | 1.45 |
| BDHE00201210 | 0.8 | 2.4 | 1.45 |
| BDHE00201608 | 0.7 | 2.3 | 1.8  |
| BDHE00201610 | 0.7 | 2.3 | 1.8  |
| BDHE00201612 | 0.7 | 2.3 | 1.8  |
| BDHE00252010 | 1.2 | 2.8 | 2.3  |
| BDHE00252012 | 1.2 | 2.8 | 2.3  |
| BDHE00322510 | 1.7 | 3.5 | 2.8  |
| BDHE00322512 | 1.7 | 3.5 | 2.8  |
| BDHE00322525 | 1.7 | 3.5 | 2.8  |

# Molding Power Inductors – BDHE Series

## Electrical Characteristics

| Part Number        | Inductance (uH) | Tolerance (±%) | Test Frequency (MHz) | RDC(mΩ) Max(Typ.) | Isat(A) Max(Typ.) | Irms(A) Max(Typ.) |
|--------------------|-----------------|----------------|----------------------|-------------------|-------------------|-------------------|
| BDHE00160808R47MQ1 | 0.47            | 20             | 2                    | 100(87)           | 2.2(2.6)          | 1.6(2.0)          |
| BDHE001608081R0MQ1 | 1.0             | 20             | 2                    | 195(170)          | 1.6(1.8)          | 1.5(1.7)          |

**Note: When ordering, please specify tolerance code. Tolerance: M=±20%**

- Operating temperature range - 40°C ~ 125°C(Including self - temperature rise)
- Isat for Inductance drop 30% from its value without current
- Irms for a 40°C temperature rise from 25°C ambient with current
- Rated current : Isat or Irms, whichever is smaller
- Absolute maximum voltage 15VDC
- Measure Equipment :
  - L : Agilent E4991/HP4286A+16197A (or equivalent), 2MHz 0.2V
  - RDC : CHEN HWA502BC/HP4338B (or equivalent)
  - Isat : Agilent E4980A+HP42841A (or equivalent)
  - Irms : Agilent 6641 SYSTEM DC POWER SUPPLY (or equivalent)

**Test Instruments : E4991A Impedance / Material Analyzer**

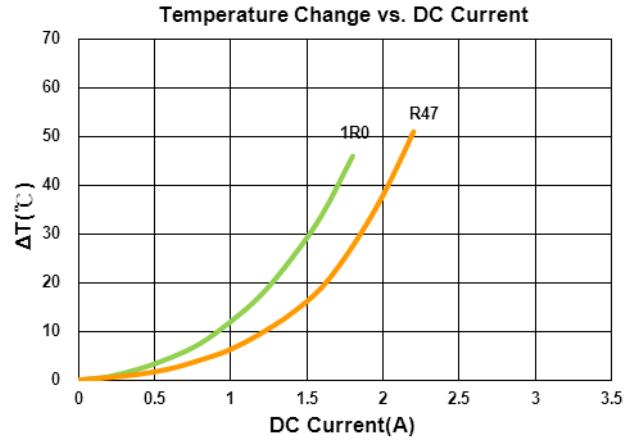
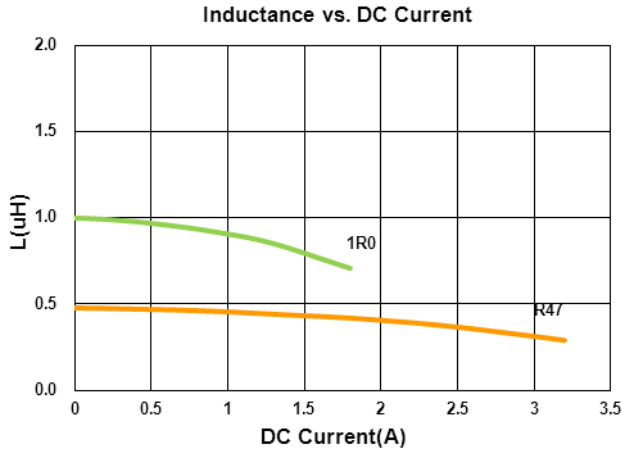

# Molding Power Inductors – BDHE Series

## Electrical Characteristics

| Part Number        | Inductance (uH) | Tolerance (±%) | Test Frequency (MHz) | RDC(mΩ) Max(Typ.) | Isat(A) Max(Typ.) | Irms(A) Max(Typ.) |
|--------------------|-----------------|----------------|----------------------|-------------------|-------------------|-------------------|
| BDHE00201208R24MQ1 | 0.24            | 20             | 2                    | 25(19)            | 4.8(5.4)          | 4.2(4.8)          |
| BDHE00201208R47MQ1 | 0.47            | 20             | 2                    | 48(40)            | 3.2(3.6)          | 3.0(3.4)          |

**Note: When ordering, please specify tolerance code. Tolerance: M=±20%**

- Operating temperature range - 40°C ~ 125°C(Including self - temperature rise)
- Isat for Inductance drop 30% from its value without current
- I rms for a 40°C temperature rise from 25°C ambient with current
- Rated current : Isat or I rms, whichever is smaller
- Absolute maximum voltage 20VDC
- Measure Equipment :  
 L : Agilent E4991/HP4286A+16197A (or equivalent), 2MHz 0.2V  
 RDC : CHEN HWA502BC/HP4338B (or equivalent)  
 Isat : Agilent E4980A+HP42841A (or equivalent)  
 I rms : Agilent 6641 SYSTEM DC POWER SUPPLY (or equivalent)

**Test Instruments :** E4991A Impedance / Material Analyzer

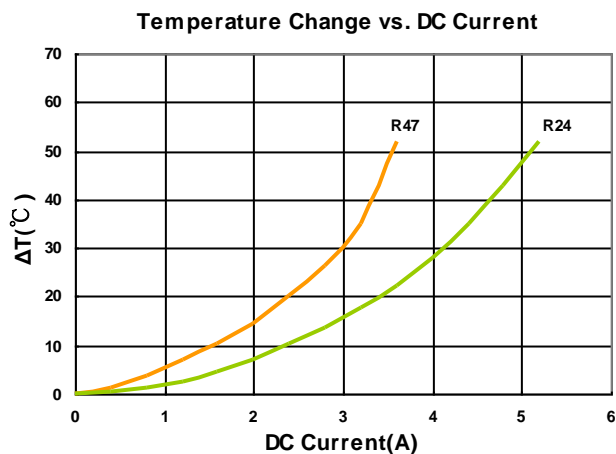
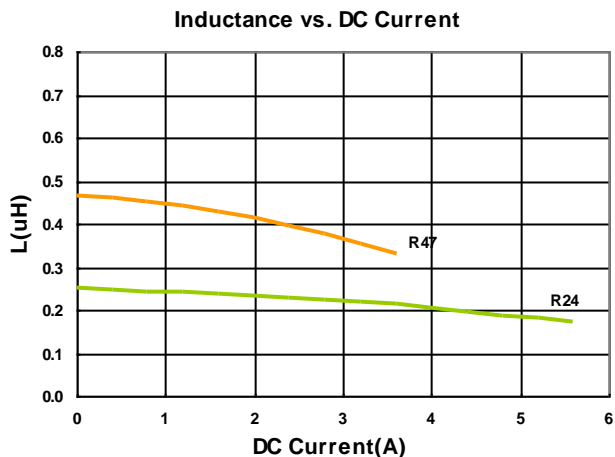

# Molding Power Inductors – BDHE Series

## Electrical Characteristics

| Part Number        | Inductance (uH) | Tolerance (±%) | Test Frequency (MHz) | RDC(mΩ) Max(Typ.) | Isat(A) Max(Typ.) | Irms(A) Max(Typ.) |
|--------------------|-----------------|----------------|----------------------|-------------------|-------------------|-------------------|
| BDHE00201210R24MQ1 | 0.24            | 20             | 2                    | 28(22)            | 4.5(5.7)          | 3.7(4.6)          |
| BDHE00201210R47MQ1 | 0.47            | 20             | 2                    | 42(33)            | 3.3(4.2)          | 3.0(3.7)          |
| BDHE002012101R0MQ1 | 1.0             | 20             | 2                    | 78(69)            | 2.3(2.8)          | 2.2(2.7)          |
| BDHE002012101R5MQ1 | 1.5             | 20             | 2                    | 126(108)          | 1.7(2.2)          | 1.6(2.1)          |
| BDHE002012102R2MQ1 | 2.2             | 20             | 2                    | 176(166)          | 1.6(1.7)          | 1.4(1.5)          |

**Note: When ordering, please specify tolerance code. Tolerance: M=±20%**

- Operating temperature range - 40°C ~ 125°C(Including self - temperature rise)
- Isat for Inductance drop 30% from its value without current
- Irms for a 40°C temperature rise from 25°C ambient with current
- Rated current : Isat or Irms, whichever is smaller
- Absolute maximum voltage 20VDC
- Measure Equipment :  
 L : Agilent E4991/HP4286A+16197A (or equivalent), 2MHz 0.2V  
 RDC : CHEN HWA502BC/HP4338B (or equivalent)  
 Isat : Agilent E4980A+HP42841A (or equivalent)  
 Irms : Agilent 6641 SYSTEM DC POWER SUPPLY (or equivalent)

**Test Instruments :** E4991A Impedance / Material Analyzer

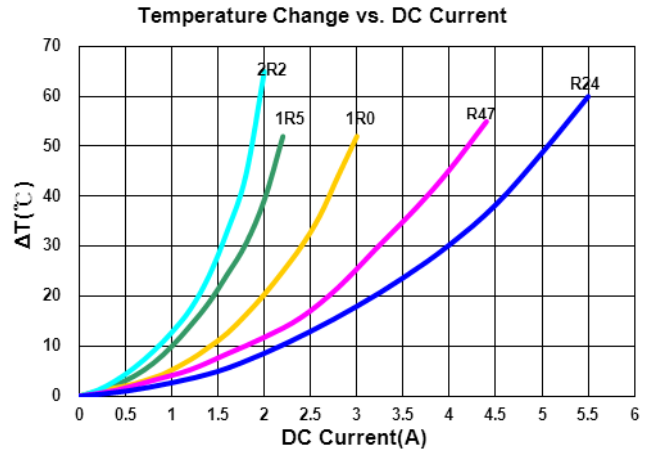
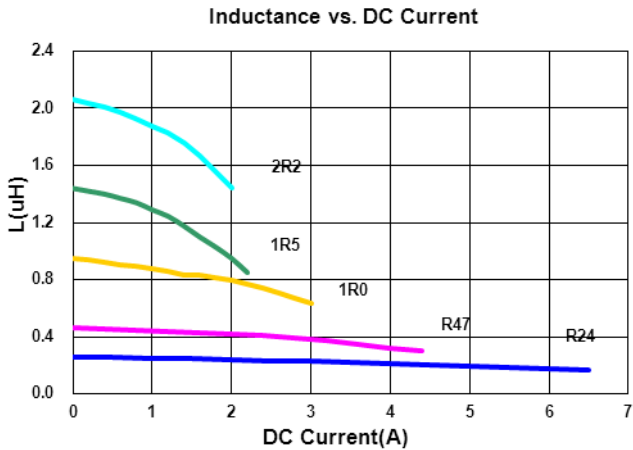

## Electrical Characteristics

| Part Number        | Inductance (uH) | Tolerance (±%) | Test Frequency (MHz) | RDC(mΩ)<br>Max(Typ.) | Isat(A)<br>Max(Typ.) | Irms(A)<br>Max(Typ.) |
|--------------------|-----------------|----------------|----------------------|----------------------|----------------------|----------------------|
| BDHE00201608R47MQ1 | 0.47            | 20             | 2                    | 51(42)               | 3.3(3.6)             | 3.1(3.4)             |
| BDHE002016081R0MQ1 | 1.0             | 20             | 2                    | 87(76)               | 2.5(2.8)             | 2.3(2.7)             |

**Note: When ordering, please specify tolerance code. Tolerance: M=±20%**

- Operating temperature range - 40°C ~ 125°C(Including self - temperature rise)
- Isat for Inductance drop 30% from its value without current
- Irms for a 40°C temperature rise from 25°C ambient with current
- Rated current : Isat or Irms, whichever is smaller
- Absolute maximum voltage 20VDC
- Measure Equipment :  
 L : Agilent E4991/HP4286A+16197A (or equivalent), 2MHz 0.2V  
 RDC : CHEN HWA502BC/HP4338B (or equivalent)  
 Isat : Agilent E4980A+HP42841A (or equivalent)  
 Irms : Agilent 6641 SYSTEM DC POWER SUPPLY (or equivalent)

**Test Instruments :** E4991A Impedance / Material Analyzer

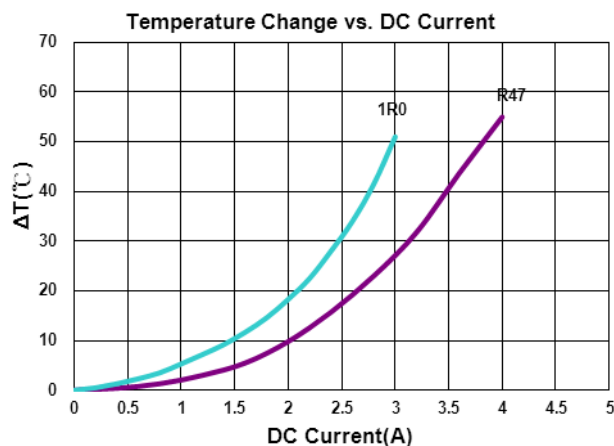
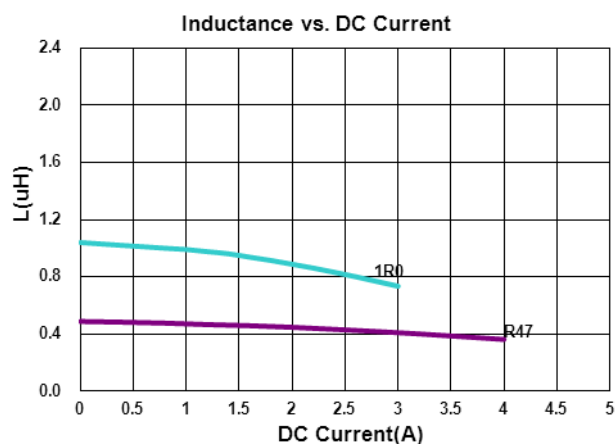

# Molding Power Inductors – BDHE Series

## Electrical Characteristics

| Part Number        | Inductance (uH) | Tolerance (±%) | Test Frequency (MHz) | RDC(mΩ) Max(Typ.) | Isat(A) Max(Typ.) | Irms(A) Max(Typ.) |
|--------------------|-----------------|----------------|----------------------|-------------------|-------------------|-------------------|
| BDHE00201610R24MQ1 | 0.24            | 20             | 2                    | 27(21)            | 5.6(7.0)          | 3.9(4.8)          |
| BDHE00201610R47MQ1 | 0.47            | 20             | 2                    | 42(33)            | 3.9(4.8)          | 3.5(4.2)          |
| BDHE00201610R68MQ1 | 0.68            | 20             | 2                    | 56(43)            | 3.2(4.0)          | 2.7(3.4)          |
| BDHE002016101R0MQ1 | 1.0             | 20             | 2                    | 65(53)            | 2.9(3.6)          | 2.5(3.1)          |
| BDHE002016101R5MQ1 | 1.5             | 20             | 2                    | 85(75)            | 2.5(2.8)          | 2.3(2.7)          |
| BDHE002016102R2MQ1 | 2.2             | 20             | 2                    | 135(112)          | 2.4(2.7)          | 1.8(2.2)          |

**Note: When ordering, please specify tolerance code. Tolerance: M=±20%**

- Operating temperature range - 40°C ~ 125°C(Including self - temperature rise)
- Isat for Inductance drop 30% from its value without current
- I rms for a 40°C temperature rise from 25°C ambient with current
- Rated current : Isat or I rms, whichever is smaller
- Absolute maximum voltage 20VDC
- Measure Equipment :  
 L : Agilent E4991/HP4286A+16197A (or equivalent), 2MHz 0.2V  
 RDC : CHEN HWA502BC/HP4338B (or equivalent)  
 Isat : Agilent E4980A+HP42841A (or equivalent)  
 I rms : Agilent 6641 SYSTEM DC POWER SUPPLY (or equivalent)

**Test Instruments :** E4991A Impedance / Material Analyzer

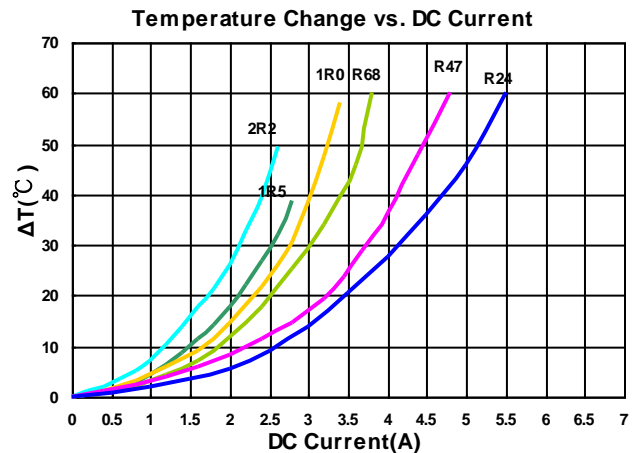
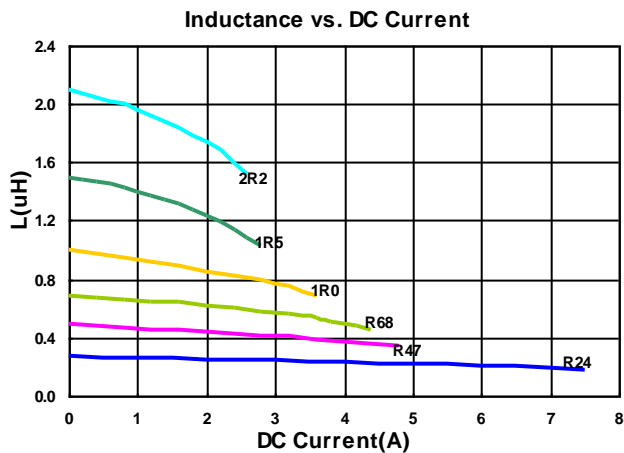

# Molding Power Inductors – BDHE Series

## Electrical Characteristics

| Part Number        | Inductance (uH) | Tolerance (±%) | Test Frequency (MHz) | RDC(mΩ) Max(Typ.) | Isat(A) Max(Typ.) | Irms(A) Max(Typ.) |
|--------------------|-----------------|----------------|----------------------|-------------------|-------------------|-------------------|
| BDHE002016121R0MQ1 | 1.0             | 20             | 2                    | 52(43)            | 3.2(3.8)          | 3.0(3.5)          |
| BDHE002016121R2MQ1 | 1.2             | 20             | 2                    | 78(69)            | 3.0(3.4)          | 2.7(3.1)          |

**Note: When ordering, please specify tolerance code. Tolerance: M=±20%**

- Operating temperature range - 40°C ~ 125°C(Including self - temperature rise)
- Isat for Inductance drop 30% from its value without current
- Irms for a 40°C temperature rise from 25°C ambient with current
- Rated current : Isat or Irms, whichever is smaller
- Absolute maximum voltage 20VDC
- Measure Equipment :
  - L : Agilent E4991/HP4286A+16197A (or equivalent), 2MHz 0.2V
  - RDC : CHEN HWA502BC/HP4338B (or equivalent)
  - Isat : Agilent E4980A+HP42841A (or equivalent)
  - Irms : Agilent 6641 SYSTEM DC POWER SUPPLY (or equivalent)

## Test Instruments : E4991A Impedance / Material Analyzer

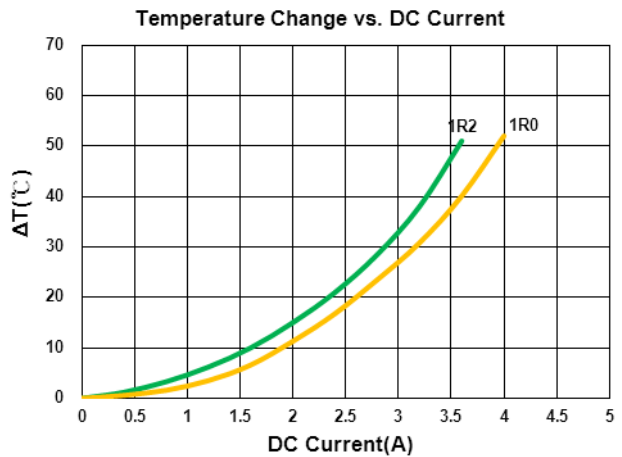
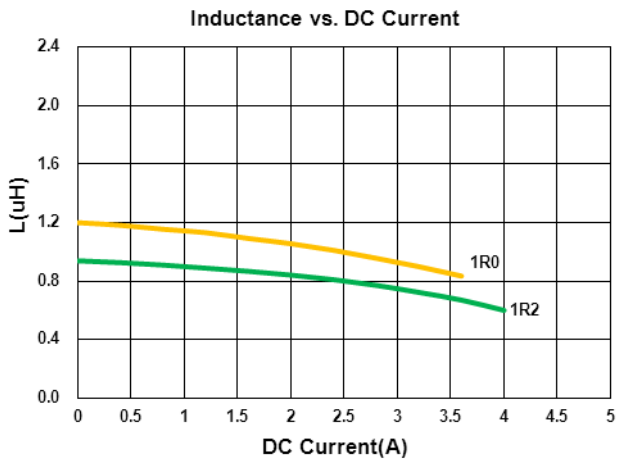

# Molding Power Inductors – BDHE Series

## Electrical Characteristics

| Part Number        | Inductance (uH) | Tolerance (±%) | Test Frequency (MHz) | RDC(mΩ) Max(Typ.) | Isat(A) Max(Typ.) | Irms(A) Max(Typ.) |
|--------------------|-----------------|----------------|----------------------|-------------------|-------------------|-------------------|
| BDHE00252010R24MQ1 | 0.24            | 20             | 2                    | 18(13)            | 8.0(9.5)          | 5.5(6.5)          |
| BDHE00252010R33MQ1 | 0.33            | 20             | 2                    | 24(18)            | 6.5(8.0)          | 4.8(5.5)          |
| BDHE00252010R47MQ1 | 0.47            | 20             | 2                    | 35(27)            | 5.0(6.2)          | 3.9(4.5)          |
| BDHE00252010R68MQ1 | 0.68            | 20             | 2                    | 40(32)            | 4.5(5.6)          | 3.7(4.2)          |
| BDHE002520101R0MQ1 | 1.0             | 20             | 2                    | 53(45)            | 3.7(4.6)          | 3.0(3.5)          |
| BDHE002520101R5MQ1 | 1.5             | 20             | 2                    | 75(68)            | 3.1(3.8)          | 2.4(2.8)          |
| BDHE002520102R2MQ1 | 2.2             | 20             | 2                    | 97(87)            | 2.5(3.0)          | 2.2(2.5)          |

**Note: When ordering, please specify tolerance code. Tolerance: M=±20%**

- Operating temperature range - 40°C ~ 125°C(Including self - temperature rise)
- Isat for Inductance drop 30% from its value without current
- I rms for a 40°C temperature rise from 25°C ambient with current
- Rated current : Isat or I rms, whichever is smaller
- Absolute maximum voltage 20VDC
- Measure Equipment :
  - L : Agilent E4991/HP4286A+16197A (or equivalent), 2MHz 0.2V
  - RDC : CHEN HWA502BC/HP4338B (or equivalent)
  - Isat : Agilent E4980A+HP42841A (or equivalent)
  - I rms : Agilent 6641 SYSTEM DC POWER SUPPLY (or equivalent)

**Test Instruments : E4991A Impedance / Material Analyzer**

**Inductance vs. DC Current**

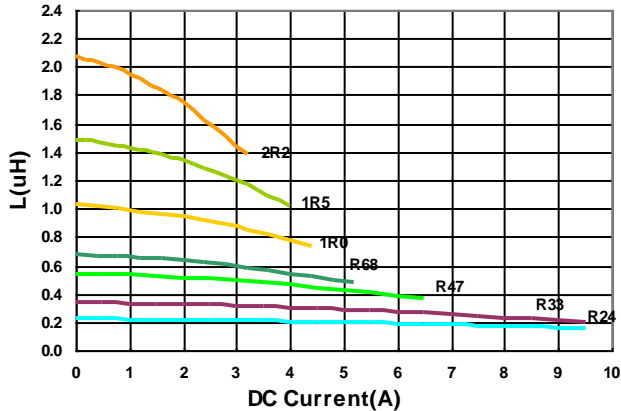

**Temperature Change vs. DC Current**

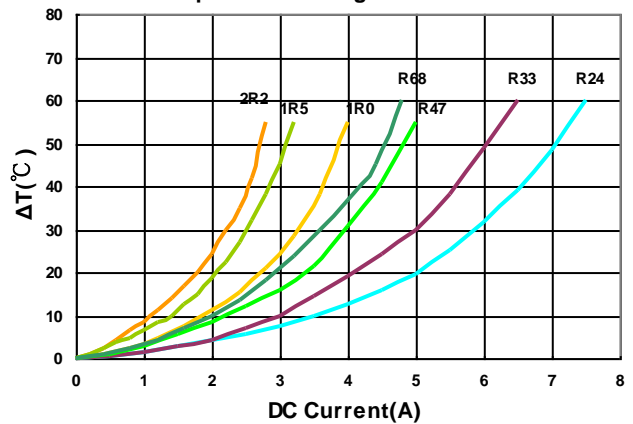



# Molding Power Inductors – BDHE Series

## Electrical Characteristics

| Part Number        | Inductance (uH) | Tolerance (±%) | Test Frequency (MHz) | RDC(mΩ)<br>Max(Typ.) | Isat(A)<br>Max(Typ.) | Irms(A)<br>Max(Typ.) |
|--------------------|-----------------|----------------|----------------------|----------------------|----------------------|----------------------|
| BDHE00252012R24MQ1 | 0.24            | 20             | 2                    | 15(11.5)             | 9.0(10.5)            | 6.2(7.3)             |
| BDHE00252012R33MQ1 | 0.33            | 20             | 2                    | 18(14.5)             | 8.5(10)              | 5.8(6.4)             |
| BDHE00252012R47MQ1 | 0.47            | 20             | 2                    | 33(28)               | 5.6(7.0)             | 3.8(4.5)             |
| BDHE00252012R68MQ1 | 0.68            | 20             | 2                    | 36(30)               | 5.0(6.2)             | 3.8(4.4)             |
| BDHE002520121R0MQ1 | 1.0             | 20             | 2                    | 42(35)               | 4.4(5.5)             | 3.6(4.1)             |
| BDHE002520121R2MQ1 | 1.2             | 20             | 2                    | 54(45)               | 3.9(4.4)             | 3.2(3.8)             |
| BDHE002520121R5MQ1 | 1.5             | 20             | 2                    | 65(57)               | 3.4(4.2)             | 2.7(3.1)             |
| BDHE002520122R2MQ1 | 2.2             | 20             | 2                    | 83(74)               | 3.0(3.7)             | 2.5(2.9)             |

**Note: When ordering, please specify tolerance code. Tolerance: M=±20%**

- Operating temperature range - 40°C ~ 125°C(Including self - temperature rise)
- Isat for Inductance drop 30% from its value without current
- Irms for a 40°C temperature rise from 25°C ambient with current
- Rated current : Isat or Irms, whichever is smaller
- Absolute maximum voltage 20VDC
- Measure Equipment :  
 L : Agilent E4991/HP4286A+16197A (or equivalent), 2MHz 0.2V  
 RDC : CHEN HWA502BC/HP4338B (or equivalent)  
 Isat : Agilent E4980A+HP42841A (or equivalent)  
 Irms : Agilent 6641 SYSTEM DC POWER SUPPLY (or equivalent)

**Test Instruments : E4991A Impedance / Material Analyzer**

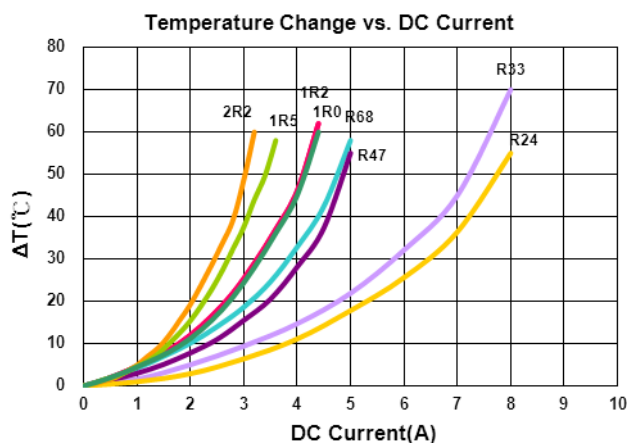
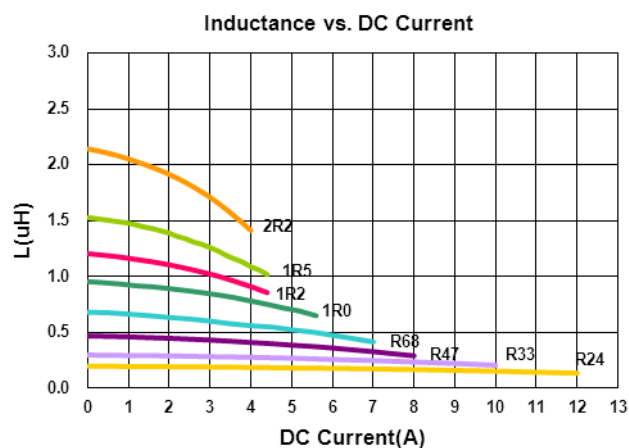

# Molding Power Inductors – BDHE Series

## Electrical Characteristics

| Part Number        | Inductance (uH) | Tolerance (±%) | Test Frequency (MHz) | RDC(mΩ) Max(Typ.) | Isat(A) Max(Typ.) | Irms(A) Max(Typ.) |
|--------------------|-----------------|----------------|----------------------|-------------------|-------------------|-------------------|
| BDHE00322510R24MQ1 | 0.24            | 20             | 2                    | 16(12)            | 9.0(11.5)         | 6.0(6.8)          |
| BDHE00322510R33MQ1 | 0.33            | 20             | 2                    | 17(12.5)          | 8.0(9.5)          | 5.8(6.5)          |
| BDHE00322510R47MQ1 | 0.47            | 20             | 2                    | 24(19)            | 6.0(7.3)          | 4.5(5.4)          |
| BDHE003225101R0MQ1 | 1.0             | 20             | 2                    | 46(39)            | 4.1(4.7)          | 3.3(3.7)          |
| BDHE003225101R5MQ1 | 1.5             | 20             | 2                    | 58(50)            | 3.5(4.0)          | 3.2(3.5)          |
| BDHE003225102R2MQ1 | 2.2             | 20             | 2                    | 85(73)            | 3.0(3.5)          | 2.5(2.8)          |

**Note: When ordering, please specify tolerance code. Tolerance: M=±20%**

- Operating temperature range - 40°C ~ 125°C(Including self - temperature rise)
- Isat for Inductance drop 30% from its value without current
- I rms for a 40°C temperature rise from 25°C ambient with current
- Rated current : Isat or I rms, whichever is smaller
- Absolute maximum voltage 20VDC
- Measure Equipment :  
 L : Agilent E4991/HP4286A+16197A (or equivalent), 2MHz 0.2V  
 RDC : CHEN HWA502BC/HP4338B (or equivalent)  
 Isat : Agilent E4980A+HP42841A (or equivalent)  
 I rms : Agilent 6641 SYSTEM DC POWER SUPPLY (or equivalent)

## Test Instruments : E4991A Impedance / Material Analyzer

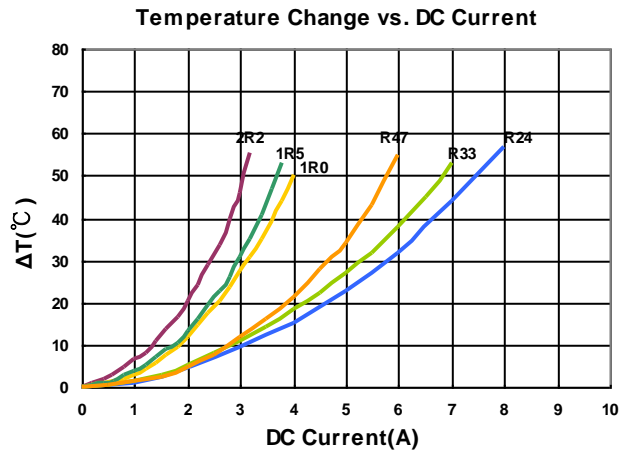
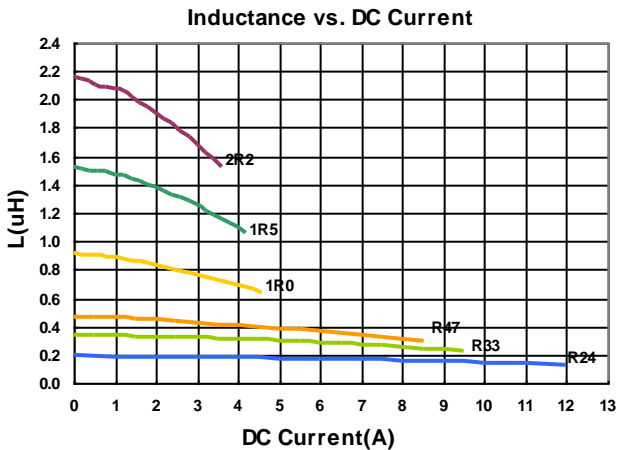

# Molding Power Inductors – BDHE Series

## Electrical Characteristics

| Part Number        | Inductance (uH) | Tolerance (±%) | Test Frequency (MHz) | RDC(mΩ)<br>Max(Typ.) | Isat(A)<br>Max(Typ.) | Irms(A)<br>Max(Typ.) |
|--------------------|-----------------|----------------|----------------------|----------------------|----------------------|----------------------|
| BDHE00322512R47MQ1 | 0.47            | 20             | 2                    | 25(19)               | 7.0(8.2)             | 4.6(5.2)             |
| BDHE003225121R0MQ1 | 1.0             | 20             | 2                    | 34(27.5)             | 5.7(6.5)             | 3.7(4.2)             |
| BDHE003225121R5MQ1 | 1.5             | 20             | 2                    | 59(51)               | 4.0(4.6)             | 2.8(3.2)             |
| BDHE003225122R2MQ1 | 2.2             | 20             | 2                    | 73(64)               | 3.5(4.0)             | 2.7(3.0)             |

**Note: When ordering, please specify tolerance code. Tolerance: M=±20%**

- Operating temperature range - 40°C ~ 125°C(Including self - temperature rise)
- Isat for Inductance drop 30% from its value without current
- I rms for a 40°C temperature rise from 25°C ambient with current
- Rated current : Isat or I rms, whichever is smaller
- Absolute maximum voltage 20VDC
- Measure Equipment :  
 L : Agilent E4991/HP4286A+16197A (or equivalent), 2MHz 0.2V  
 RDC : CHEN HWA502BC/HP4338B (or equivalent)  
 Isat : Agilent E4980A+HP42841A (or equivalent)  
 I rms : Agilent 6641 SYSTEM DC POWER SUPPLY (or equivalent)

**Test Instruments :** E4991A Impedance / Material Analyzer

**Inductance vs. DC Current**

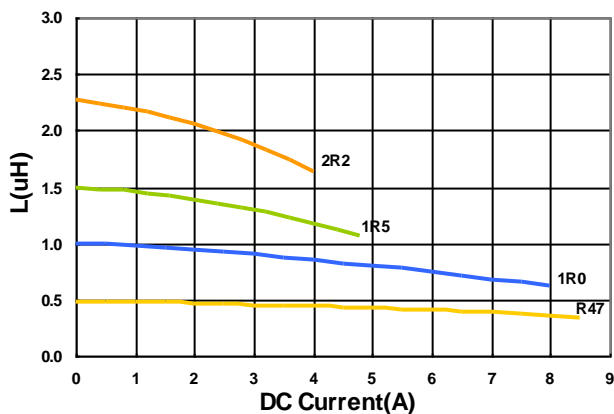

**Temperature Change vs. DC Current**

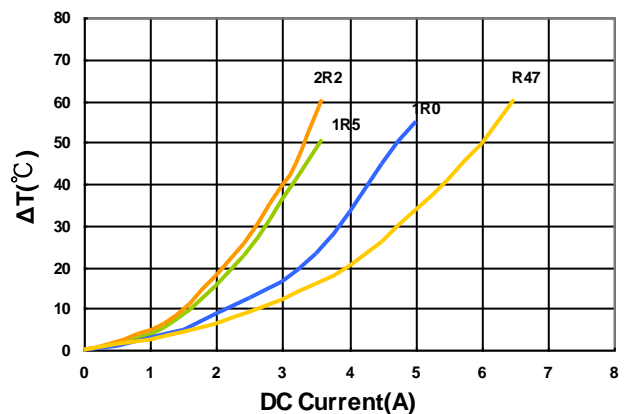

# Molding Power Inductors – BDHE Series

## Electrical Characteristics

| Part Number        | Inductance (uH) | Tolerance (±%) | Test Frequency (MHz) | RDC(mΩ) Max(Typ.) | Isat(A) Max(Typ.) | Irms(A) Max(Typ.) |
|--------------------|-----------------|----------------|----------------------|-------------------|-------------------|-------------------|
| BDHE003225251R0MQ1 | 1.0             | 20             | 2                    | 34(28)            | 6.0(8.0)          | 3.5(4.3)          |
| BDHE003225251R5MQ1 | 1.5             | 20             | 2                    | 45(35)            | 5.5(7.5)          | 3.2(3.9)          |
| BDHE003225252R2MQ1 | 2.2             | 20             | 2                    | 60(49)            | 4.8(6.5)          | 3.0(3.3)          |

**Note: When ordering, please specify tolerance code. Tolerance: M=±20%**

- Operating temperature range - 40°C ~ 125°C(Including self - temperature rise)
- Isat for Inductance drop 30% from its value without current
- Irms for a 40°C temperature rise from 25°C ambient with current
- Rated current : Isat or Irms, whichever is smaller
- Absolute maximum voltage 20VDC
- Measure Equipment :  
 L : Agilent E4991/HP4286A+16197A (or equivalent), 2MHz 0.2V  
 RDC : CHEN HWA502BC/HP4338B (or equivalent)  
 Isat : Agilent E4980A+HP42841A (or equivalent)  
 Irms : Agilent 6641 SYSTEM DC POWER SUPPLY (or equivalent)

**Test Instruments :** E4991A Impedance / Material Analyzer

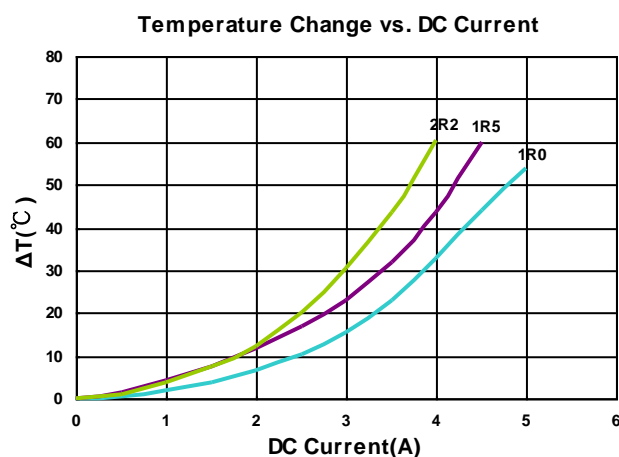
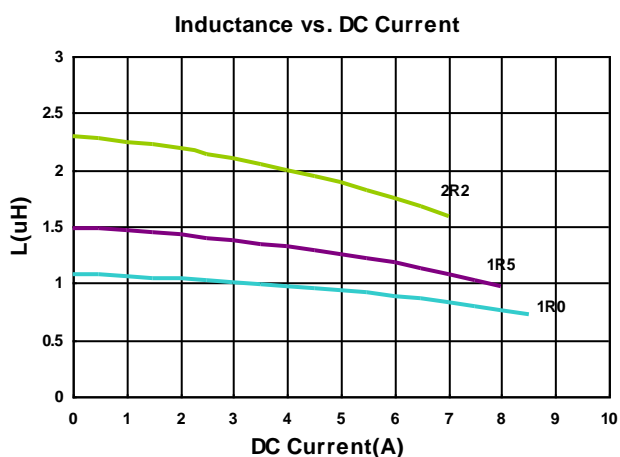

## Packaging Specifications

### Tape Dimensions

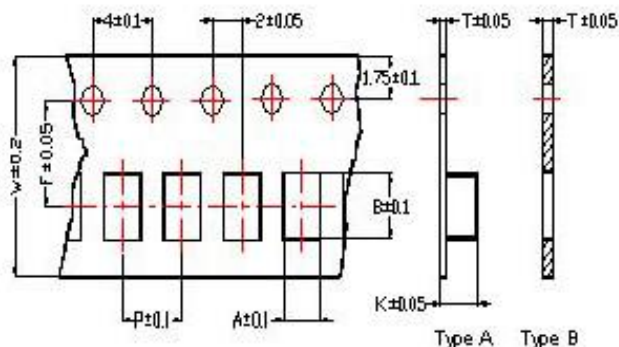

### Tape Material

Carrier Tape: Polycarbonate (Tape A)  
 Carrier Tape: Paper (Tape B)  
 Cover Tape: Polystyrene

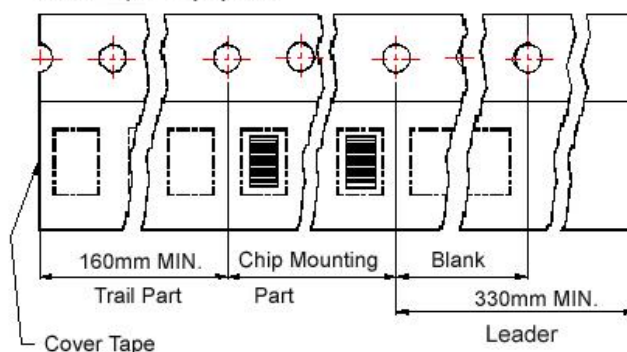

### Reel Dimensions

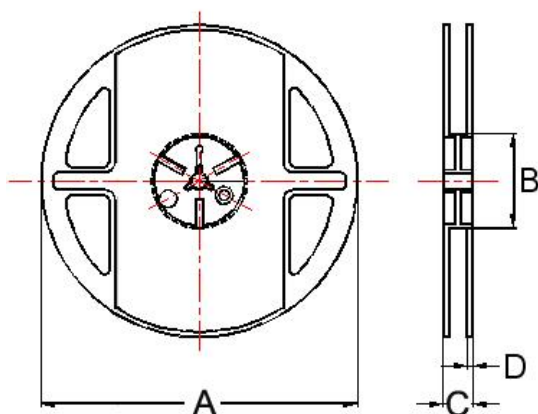

Dimensions in mm

| TYPE         | Tape Dimensions |      |      |      |   |   |     |      | Reel Dimensions |    |    |     | Quantity<br>PCS / REEL |
|--------------|-----------------|------|------|------|---|---|-----|------|-----------------|----|----|-----|------------------------|
|              | Tape            | A    | B    | T    | W | P | F   | K    | A               | B  | C  | D   |                        |
| BDHE00160808 | B               | 1.20 | 1.88 | 0.95 | 8 | 4 | 3.5 | -    | 178             | 60 | 12 | 1.5 | 4000                   |
| BDHE00201208 | A               | 1.45 | 2.25 | 0.22 | 8 | 4 | 3.5 | 1.04 | 178             | 60 | 12 | 1.5 | 3000                   |
| BDHE00201210 | A               | 1.50 | 2.25 | 0.22 | 8 | 4 | 3.5 | 1.15 | 178             | 60 | 12 | 1.5 | 3000                   |
| BDHE00201608 | A               | 1.80 | 2.35 | 0.23 | 8 | 4 | 3.5 | 0.85 | 178             | 60 | 12 | 1.5 | 3000                   |
| BDHE00201610 | A               | 1.90 | 2.30 | 0.22 | 8 | 4 | 3.5 | 1.15 | 178             | 60 | 12 | 1.5 | 3000                   |
| BDHE00201612 | A               | 1.90 | 2.30 | 0.22 | 8 | 4 | 3.5 | 1.15 | 178             | 60 | 12 | 1.5 | 3000                   |
| BDHE00252010 | A               | 2.25 | 2.80 | 0.22 | 8 | 4 | 3.5 | 1.15 | 178             | 60 | 12 | 1.5 | 3000                   |
| BDHE00252012 | A               | 2.30 | 2.80 | 0.22 | 8 | 4 | 3.5 | 1.35 | 178             | 60 | 12 | 1.5 | 3000                   |
| BDHE00322510 | A               | 2.80 | 3.55 | 0.23 | 8 | 4 | 3.5 | 1.20 | 178             | 60 | 12 | 1.5 | 3000                   |
| BDHE00322512 | A               | 2.80 | 3.50 | 0.23 | 8 | 4 | 3.5 | 1.34 | 178             | 60 | 12 | 1.5 | 3000                   |
| BDHE00322525 | A               | 2.90 | 3.50 | 0.23 | 8 | 4 | 3.5 | 2.90 | 178             | 60 | 12 | 1.5 | 1500                   |

## X-ON Electronics

Largest Supplier of Electrical and Electronic Components

*Click to view similar products for [Fixed Inductors](#) category:*

*Click to view products by [Chilisin](#) manufacturer:*

Other Similar products are found below :

[CR43NP-680KC](#) [CR54NP-470LC](#) [CR54NP-820KC](#) [CR54NP-8R5MC](#) [70F224AI](#) [MGDQ4-00004-P](#) [MHL1ECTTP18NJ](#) [MHQ1005P10NJ](#)  
[MHQ1005P1N0S](#) [MHQ1005P2N4S](#) [MHQ1005P3N6S](#) [MHQ1005P5N1S](#) [MHQ1005P8N2J](#) [PE-51506NL](#) [PE-53601NL](#) [PE-53602NL](#) [PE-53630NL](#) [PE-53824SNLT](#) [PE-92100NL](#) [PG0434.801NLT](#) [PG0936.113NLT](#) [9220-20](#) [9310-16](#) [PM06-2N7](#) [PM06-39NJ](#) [A01TK](#) [1206CS-471XJ](#) [HC2LP-R47-R](#) [HC2-R47-R](#) [HC3-2R2-R](#) [HC3-R50-R](#) [HC8-1R2-R](#) [HCF1305-3R3-R](#) [1206CS-151XG](#) [RCH664NP-140L](#) [RCH664NP-4R7M](#) [RCH8011NP-221L](#) [RCP1317NP-332L](#) [RCP1317NP-391L](#) [RCR1010NP-470M](#) [RCR110DNP-331L](#) [DH2280-4R7M](#) [DS1608C-106](#)  
[ASPI-4020HI-R10M-T](#) [B10TJ](#) [B82498B3680J000](#) [ELJ-RE27NJF2](#) [1812CS-153XJ](#) [1812CS-183XJ](#) [1812CS-223XJ](#)