

BDHE Series



The BDHE Series is designed specifically to enhance both PFM and PWM application performance. Q(Rac) value at light load and the RDC value at heavy load are both exceptional. Furthermore, the saturated current performance is also optimal, helping to reduce the ripple current and enhance the efficiency.

Features

- RoHS, Halogen Free and REACH Compliance
- High Efficiency
- Excellent Q, RDC and saturation current
- Low profile and miniature size down to 1.6*0.8*0.8mm

Applications

- Smartphones, tablets and wearable devices
- HDD, SSD and PC peripheral devices
- DSC, camcorders
- PND
- DC/DC converters

Product Identification

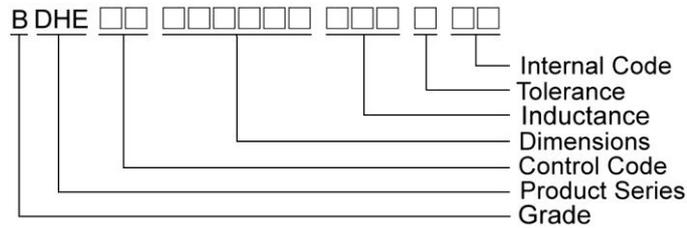

Shape and Dimensions

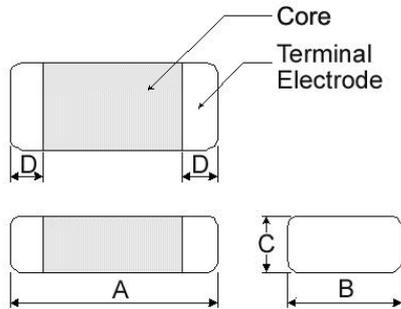

Dimensions in mm

TYPE	A	B	C	D
BDHE00160808	1.6±0.2	0.80±0.2	0.8Max	0.3±0.2
BDHE00201208	2.0±0.2	1.25±0.2	0.8Max	0.5±0.3
BDHE00201210	2.0±0.2	1.25±0.2	1.0Max	0.5±0.3
BDHE00201608	2.0±0.2	1.60±0.2	0.8Max	0.5±0.3
BDHE00201610	2.0±0.2	1.60±0.2	1.0Max	0.5±0.3
BDHE00201612	2.0±0.2	1.60±0.2	1.2Max	0.5±0.3
BDHE00252010	2.5±0.3	2.00±0.3	1.0Max	0.6±0.3
BDHE00252012	2.5±0.3	2.00±0.3	1.2Max	0.6±0.3
BDHE00322510	3.2±0.3	2.50±0.3	1.0Max	0.5±0.3
BDHE00322512	3.2±0.3	2.50±0.3	1.2Max	0.5±0.3
BDHE00322525	3.2±0.3	2.50±0.3	2.50±0.3	0.5±0.3

Recommended Pattern

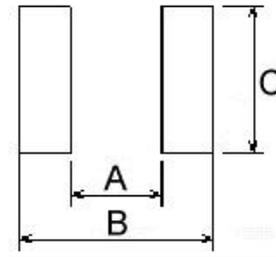

Dimensions in mm

TYPE	A	B	C
BDHE00160808	0.7	1.8	1
BDHE00201208	0.8	2.4	1.45
BDHE00201210	0.8	2.4	1.45
BDHE00201608	0.7	2.3	1.8
BDHE00201610	0.7	2.3	1.8
BDHE00201612	0.7	2.3	1.8
BDHE00252010	1.2	2.8	2.3
BDHE00252012	1.2	2.8	2.3
BDHE00322510	1.7	3.5	2.8
BDHE00322512	1.7	3.5	2.8
BDHE00322525	1.7	3.5	2.8

Molding Power Inductors – BDHE Series

Electrical Characteristics

Part Number	Inductance (uH)	Tolerance (±%)	Test Frequency (MHz)	RDC(mΩ) Max(Typ.)	Isat(A) Max(Typ.)	Irms(A) Max(Typ.)
BDHE00160808R47MQ1	0.47	20	2	100(87)	2.2(2.6)	1.6(2.0)
BDHE001608081R0MQ1	1.0	20	2	195(170)	1.6(1.8)	1.5(1.7)

Note: When ordering, please specify tolerance code. Tolerance: M=±20%

- Operating temperature range - 40°C ~ 125°C(Including self - temperature rise)
- Isat for Inductance drop 30% from its value without current
- Irms for a 40°C temperature rise from 25°C ambient with current
- Rated current : Isat or Irms, whichever is smaller
- Absolute maximum voltage 15VDC
- Measure Equipment :
 - L : Agilent E4991/HP4286A+16197A (or equivalent), 2MHz 0.2V
 - RDC : CHEN HWA502BC/HP4338B (or equivalent)
 - Isat : Agilent E4980A+HP42841A (or equivalent)
 - Irms : Agilent 6641 SYSTEM DC POWER SUPPLY (or equivalent)

Test Instruments : E4991A Impedance / Material Analyzer

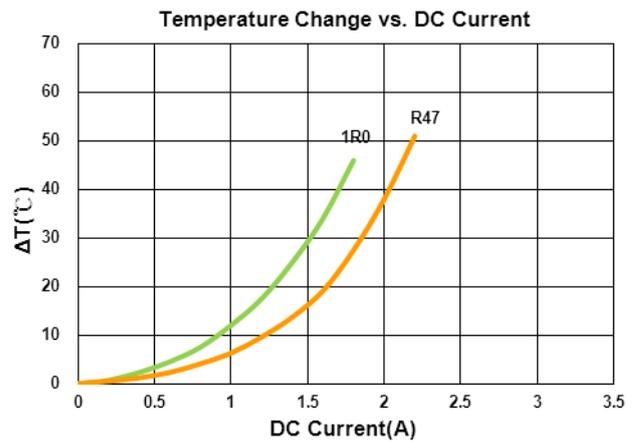
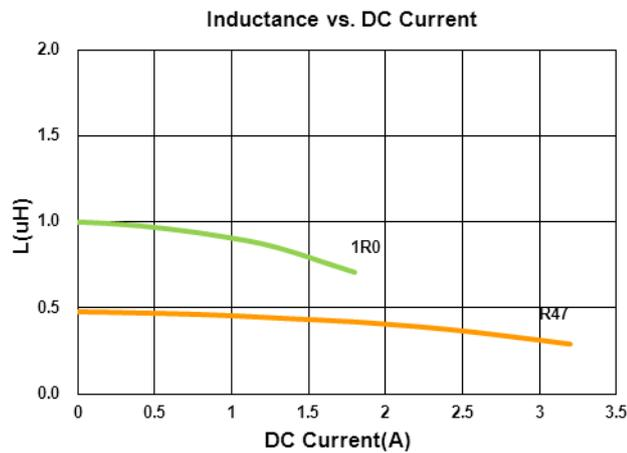

Molding Power Inductors – BDHE Series

Electrical Characteristics

Part Number	Inductance (uH)	Tolerance (±%)	Test Frequency (MHz)	RDC(mΩ) Max(Typ.)	Isat(A) Max(Typ.)	Irms(A) Max(Typ.)
BDHE00201208R24MQ1	0.24	20	2	25(19)	4.8(5.4)	4.2(4.8)
BDHE00201208R47MQ1	0.47	20	2	48(40)	3.2(3.6)	3.0(3.4)

Note: When ordering, please specify tolerance code. Tolerance: M=±20%

- Operating temperature range - 40°C ~ 125°C(Including self - temperature rise)
- Isat for Inductance drop 30% from its value without current
- Irms for a 40°C temperature rise from 25°C ambient with current
- Rated current : Isat or Irms, whichever is smaller
- Absolute maximum voltage 20VDC
- Measure Equipment :
 L : Agilent E4991/HP4286A+16197A (or equivalent), 2MHz 0.2V
 RDC : CHEN HWA502BC/HP4338B (or equivalent)
 Isat : Agilent E4980A+HP42841A (or equivalent)
 Irms : Agilent 6641 SYSTEM DC POWER SUPPLY (or equivalent)

Test Instruments : E4991A Impedance / Material Analyzer

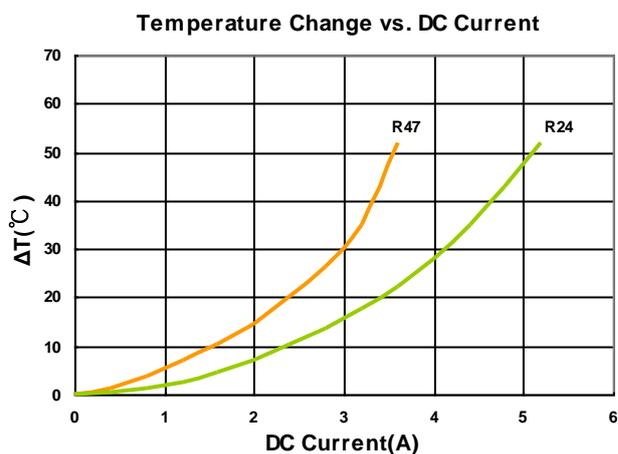
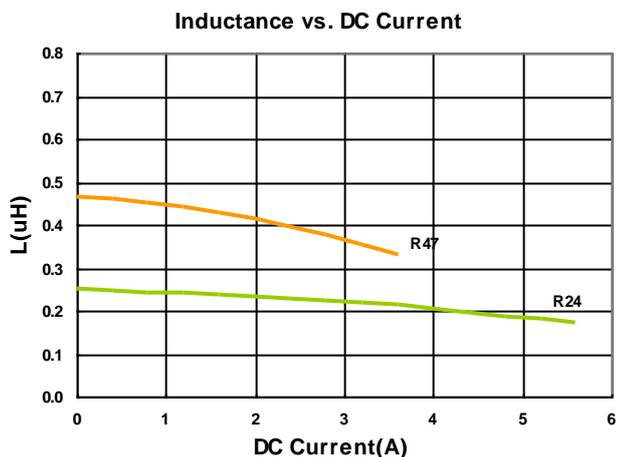

Molding Power Inductors – BDHE Series

Electrical Characteristics

Part Number	Inductance (uH)	Tolerance (±%)	Test Frequency (MHz)	RDC(mΩ) Max(Typ.)	Isat(A) Max(Typ.)	Irms(A) Max(Typ.)
BDHE00201210R24MQ1	0.24	20	2	28(22)	4.5(5.7)	3.7(4.6)
BDHE00201210R47MQ1	0.47	20	2	42(33)	3.3(4.2)	3.0(3.7)
BDHE002012101R0MQ1	1.0	20	2	78(69)	2.3(2.8)	2.2(2.7)
BDHE002012101R5MQ1	1.5	20	2	126(108)	1.7(2.2)	1.6(2.1)
BDHE002012102R2MQ1	2.2	20	2	176(166)	1.6(1.7)	1.4(1.5)

Note: When ordering, please specify tolerance code. Tolerance: M=±20%

- Operating temperature range - 40°C ~ 125°C(Including self - temperature rise)
- Isat for Inductance drop 30% from its value without current
- Irms for a 40°C temperature rise from 25°C ambient with current
- Rated current : Isat or Irms, whichever is smaller
- Absolute maximum voltage 20VDC
- Measure Equipment :
 L : Agilent E4991/HP4286A+16197A (or equivalent), 2MHz 0.2V
 RDC : CHEN HWA502BC/HP4338B (or equivalent)
 Isat : Agilent E4980A+HP42841A (or equivalent)
 Irms : Agilent 6641 SYSTEM DC POWER SUPPLY (or equivalent)

Test Instruments : E4991A Impedance / Material Analyzer

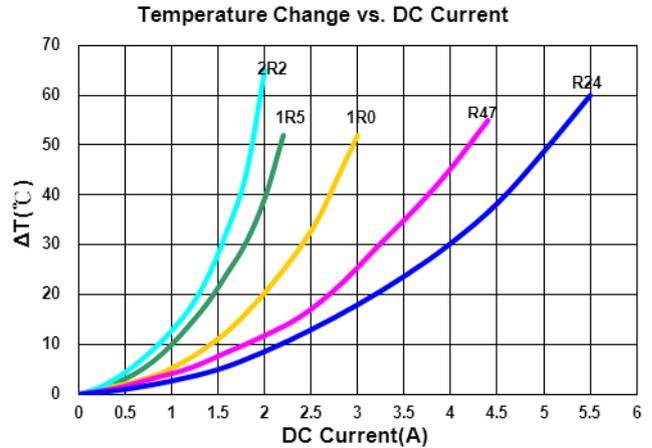
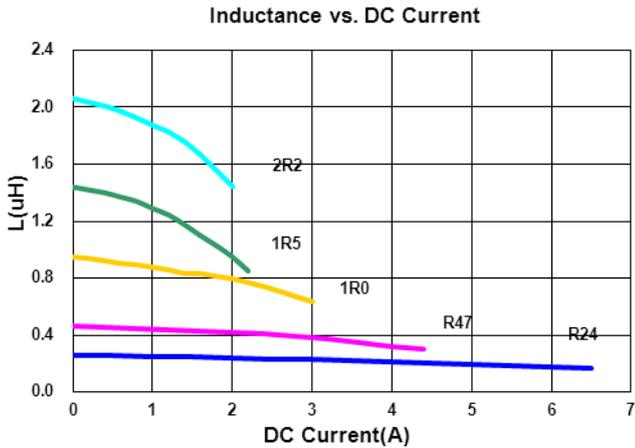

Electrical Characteristics

Part Number	Inductance (uH)	Tolerance (±%)	Test Frequency (MHz)	RDC(mΩ) Max(Typ.)	Isat(A) Max(Typ.)	Irms(A) Max(Typ.)
BDHE00201608R47MQ1	0.47	20	2	51(42)	3.3(3.6)	3.1(3.4)
BDHE002016081R0MQ1	1.0	20	2	87(76)	2.5(2.8)	2.3(2.7)

Note: When ordering, please specify tolerance code. Tolerance: M=±20%

- Operating temperature range - 40°C ~ 125°C(Including self - temperature rise)
- Isat for Inductance drop 30% from its value without current
- Irms for a 40°C temperature rise from 25°C ambient with current
- Rated current : Isat or Irms, whichever is smaller
- Absolute maximum voltage 20VDC
- Measure Equipment :
 L : Agilent E4991/HP4286A+16197A (or equivalent), 2MHz 0.2V
 RDC : CHEN HWA502BC/HP4338B (or equivalent)
 Isat : Agilent E4980A+HP42841A (or equivalent)
 Irms : Agilent 6641 SYSTEM DC POWER SUPPLY (or equivalent)

Test Instruments : E4991A Impedance / Material Analyzer

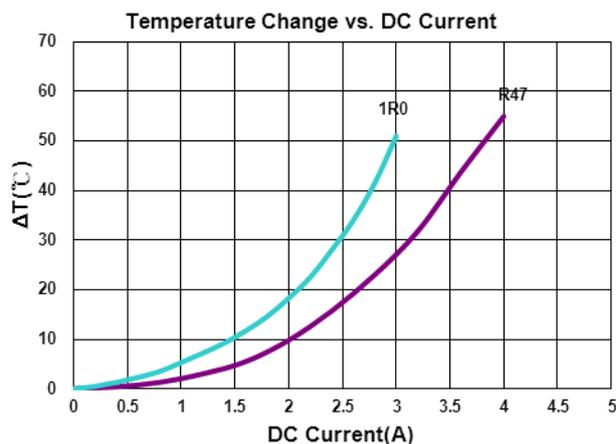
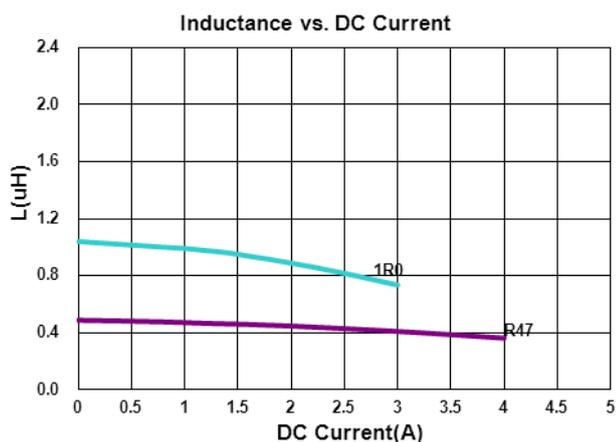

Molding Power Inductors – BDHE Series

Electrical Characteristics

Part Number	Inductance (uH)	Tolerance (±%)	Test Frequency (MHz)	RDC(mΩ) Max(Typ.)	Isat(A) Max(Typ.)	Irms(A) Max(Typ.)
BDHE00201610R24MQ1	0.24	20	2	27(21)	5.6(7.0)	3.9(4.8)
BDHE00201610R47MQ1	0.47	20	2	42(33)	3.9(4.8)	3.5(4.2)
BDHE00201610R68MQ1	0.68	20	2	56(43)	3.2(4.0)	2.7(3.4)
BDHE002016101R0MQ1	1.0	20	2	65(53)	2.9(3.6)	2.5(3.1)
BDHE002016101R5MQ1	1.5	20	2	85(75)	2.5(2.8)	2.3(2.7)
BDHE002016102R2MQ1	2.2	20	2	135(112)	2.4(2.7)	1.8(2.2)

Note: When ordering, please specify tolerance code. Tolerance: M=±20%

- Operating temperature range - 40°C ~ 125°C(Including self - temperature rise)
- Isat for Inductance drop 30% from its value without current
- I rms for a 40°C temperature rise from 25°C ambient with current
- Rated current : Isat or I rms, whichever is smaller
- Absolute maximum voltage 20VDC
- Measure Equipment :
 - L : Agilent E4991/HP4286A+16197A (or equivalent), 2MHz 0.2V
 - RDC : CHEN HWA502BC/HP4338B (or equivalent)
 - Isat : Agilent E4980A+HP42841A (or equivalent)
 - I rms : Agilent 6641 SYSTEM DC POWER SUPPLY (or equivalent)

Test Instruments : E4991A Impedance / Material Analyzer

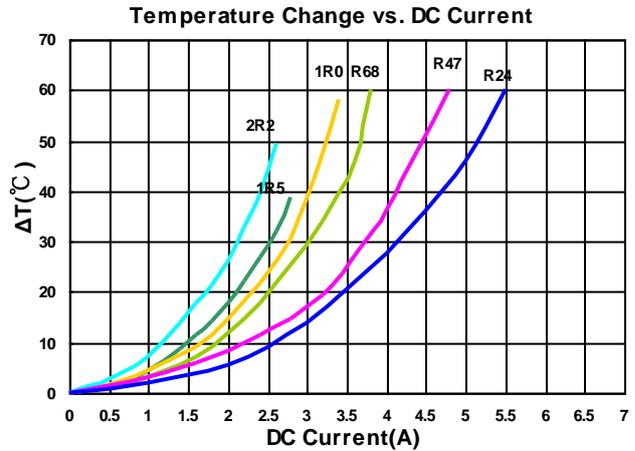
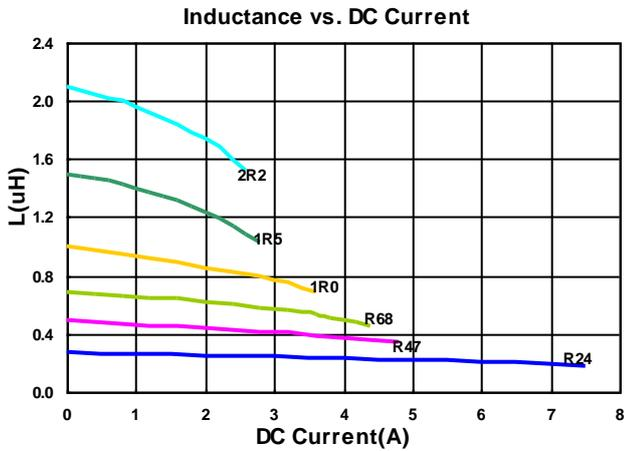

Molding Power Inductors – BDHE Series

Electrical Characteristics

Part Number	Inductance (uH)	Tolerance (±%)	Test Frequency (MHz)	RDC(mΩ) Max(Typ.)	Isat(A) Max(Typ.)	Irms(A) Max(Typ.)
BDHE002016121R0MQ1	1.0	20	2	52(43)	3.2(3.8)	3.0(3.5)
BDHE002016121R2MQ1	1.2	20	2	78(69)	3.0(3.4)	2.7(3.1)

Note: When ordering, please specify tolerance code. Tolerance: M=±20%

- Operating temperature range - 40°C ~ 125°C(Including self - temperature rise)
- Isat for Inductance drop 30% from its value without current
- I rms for a 40°C temperature rise from 25°C ambient with current
- Rated current : Isat or I rms, whichever is smaller
- Absolute maximum voltage 20VDC
- Measure Equipment :
 - L : Agilent E4991/HP4286A+16197A (or equivalent), 2MHz 0.2V
 - RDC : CHEN HWA502BC/HP4338B (or equivalent)
 - Isat : Agilent E4980A+HP42841A (or equivalent)
 - I rms : Agilent 6641 SYSTEM DC POWER SUPPLY (or equivalent)

Test Instruments : E4991A Impedance / Material Analyzer

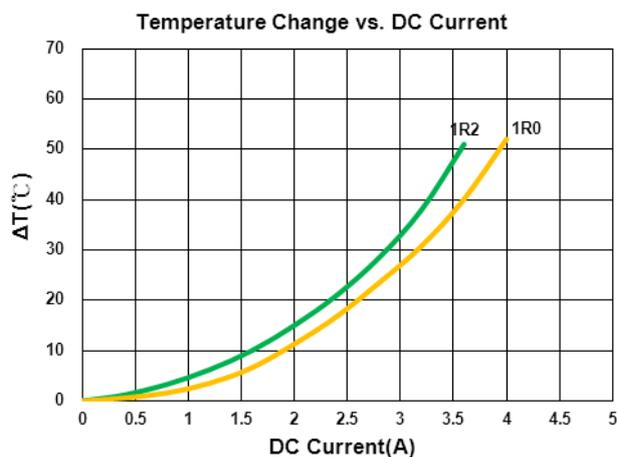
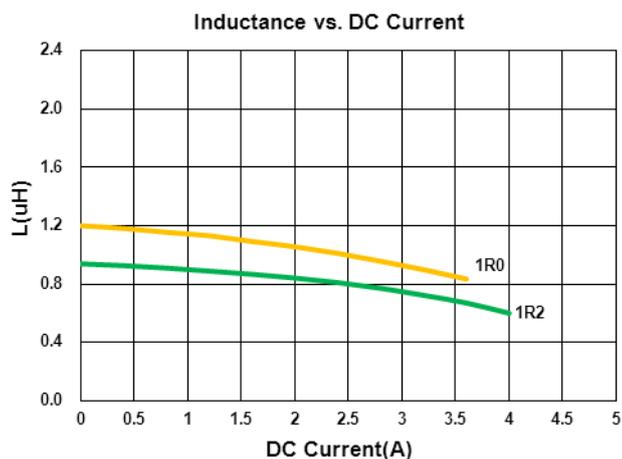

Molding Power Inductors – BDHE Series

Electrical Characteristics

Part Number	Inductance (uH)	Tolerance (±%)	Test Frequency (MHz)	RDC(mΩ) Max(Typ.)	Isat(A) Max(Typ.)	Irms(A) Max(Typ.)
BDHE00252010R24MQ1	0.24	20	2	18(13)	8.0(9.5)	5.5(6.5)
BDHE00252010R33MQ1	0.33	20	2	24(18)	6.5(8.0)	4.8(5.5)
BDHE00252010R47MQ1	0.47	20	2	35(27)	5.0(6.2)	3.9(4.5)
BDHE00252010R68MQ1	0.68	20	2	40(32)	4.5(5.6)	3.7(4.2)
BDHE002520101R0MQ1	1.0	20	2	53(45)	3.7(4.6)	3.0(3.5)
BDHE002520101R5MQ1	1.5	20	2	75(68)	3.1(3.8)	2.4(2.8)
BDHE002520102R2MQ1	2.2	20	2	97(87)	2.5(3.0)	2.2(2.5)

Note: When ordering, please specify tolerance code. Tolerance: M=±20%

- Operating temperature range - 40°C ~ 125°C(Including self - temperature rise)
- Isat for Inductance drop 30% from its value without current
- I rms for a 40°C temperature rise from 25°C ambient with current
- Rated current : Isat or I rms, whichever is smaller
- Absolute maximum voltage 20VDC
- Measure Equipment :
 - L : Agilent E4991/HP4286A+16197A (or equivalent), 2MHz 0.2V
 - RDC : CHEN HWA502BC/HP4338B (or equivalent)
 - Isat : Agilent E4980A+HP42841A (or equivalent)
 - I rms : Agilent 6641 SYSTEM DC POWER SUPPLY (or equivalent)

Test Instruments : E4991A Impedance / Material Analyzer

Inductance vs. DC Current

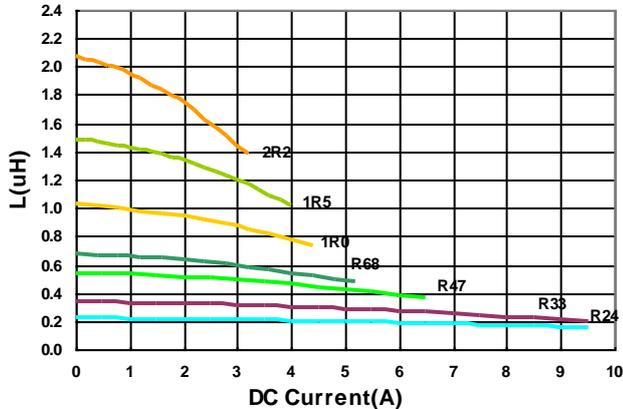

Temperature Change vs. DC Current

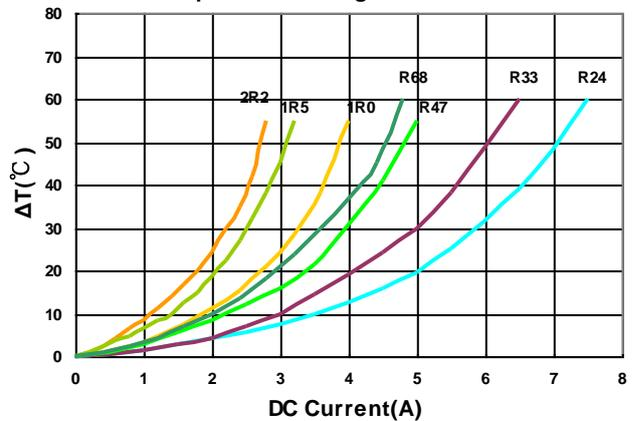

Molding Power Inductors – BDHE Series

Electrical Characteristics

Part Number	Inductance (uH)	Tolerance (±%)	Test Frequency (MHz)	RDC(mΩ) Max(Typ.)	Isat(A) Max(Typ.)	Irms(A) Max(Typ.)
BDHE00252012R24MQ1	0.24	20	2	15(11.5)	9.0(10.5)	6.2(7.3)
BDHE00252012R33MQ1	0.33	20	2	18(14.5)	8.5(10)	5.8(6.4)
BDHE00252012R47MQ1	0.47	20	2	33(28)	5.6(7.0)	3.8(4.5)
BDHE00252012R68MQ1	0.68	20	2	36(30)	5.0(6.2)	3.8(4.4)
BDHE002520121R0MQ1	1.0	20	2	42(35)	4.4(5.5)	3.6(4.1)
BDHE002520121R2MQ1	1.2	20	2	54(45)	3.9(4.4)	3.2(3.8)
BDHE002520121R5MQ1	1.5	20	2	65(57)	3.4(4.2)	2.7(3.1)
BDHE002520122R2MQ1	2.2	20	2	83(74)	3.0(3.7)	2.5(2.9)

Note: When ordering, please specify tolerance code. Tolerance: M=±20%

- Operating temperature range - 40°C ~ 125°C(Including self - temperature rise)
- Isat for Inductance drop 30% from its value without current
- Irms for a 40°C temperature rise from 25°C ambient with current
- Rated current : Isat or Irms, whichever is smaller
- Absolute maximum voltage 20VDC
- Measure Equipment :
 L : Agilent E4991/HP4286A+16197A (or equivalent), 2MHz 0.2V
 RDC : CHEN HWA502BC/HP4338B (or equivalent)
 Isat : Agilent E4980A+HP42841A (or equivalent)
 Irms : Agilent 6641 SYSTEM DC POWER SUPPLY (or equivalent)

Test Instruments : E4991A Impedance / Material Analyzer

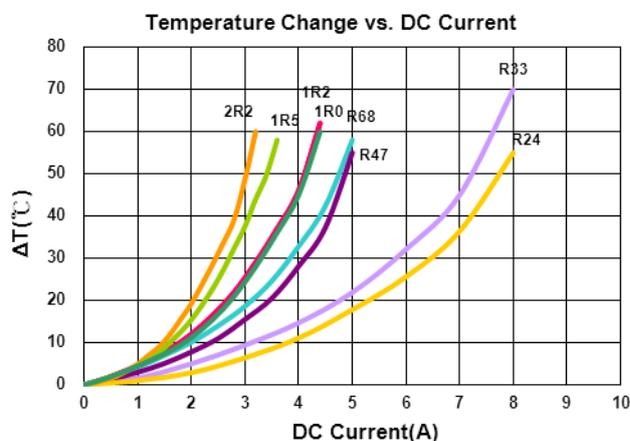
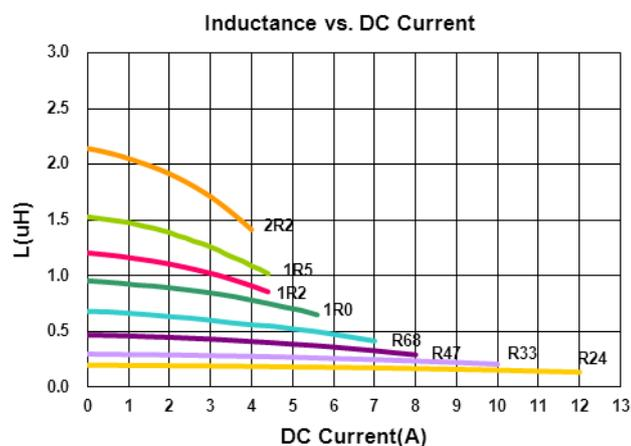

Molding Power Inductors – BDHE Series

Electrical Characteristics

Part Number	Inductance (uH)	Tolerance (±%)	Test Frequency (MHz)	RDC(mΩ) Max(Typ.)	Isat(A) Max(Typ.)	Irms(A) Max(Typ.)
BDHE00322510R24MQ1	0.24	20	2	16(12)	9.0(11.5)	6.0(6.8)
BDHE00322510R33MQ1	0.33	20	2	17(12.5)	8.0(9.5)	5.8(6.5)
BDHE00322510R47MQ1	0.47	20	2	24(19)	6.0(7.3)	4.5(5.4)
BDHE003225101R0MQ1	1.0	20	2	46(39)	4.1(4.7)	3.3(3.7)
BDHE003225101R5MQ1	1.5	20	2	58(50)	3.5(4.0)	3.2(3.5)
BDHE003225102R2MQ1	2.2	20	2	85(73)	3.0(3.5)	2.5(2.8)

Note: When ordering, please specify tolerance code. Tolerance: M=±20%

- Operating temperature range - 40°C ~ 125°C(Including self - temperature rise)
- Isat for Inductance drop 30% from its value without current
- I rms for a 40°C temperature rise from 25°C ambient with current
- Rated current : Isat or I rms, whichever is smaller
- Absolute maximum voltage 20VDC
- Measure Equipment :
 L : Agilent E4991/HP4286A+16197A (or equivalent), 2MHz 0.2V
 RDC : CHEN HWA502BC/HP4338B (or equivalent)
 Isat : Agilent E4980A+HP42841A (or equivalent)
 I rms : Agilent 6641 SYSTEM DC POWER SUPPLY (or equivalent)

Test Instruments : E4991A Impedance / Material Analyzer

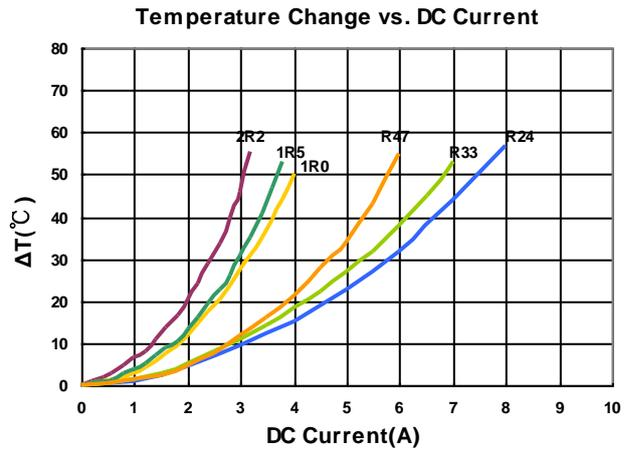
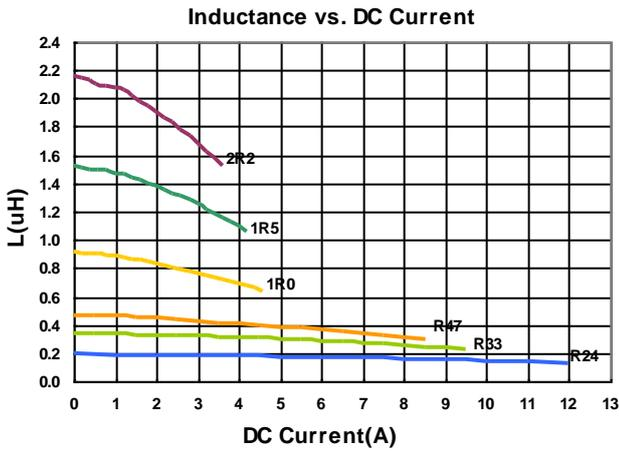

Molding Power Inductors – BDHE Series

Electrical Characteristics

Part Number	Inductance (uH)	Tolerance (±%)	Test Frequency (MHz)	RDC(mΩ) Max(Typ.)	Isat(A) Max(Typ.)	Irms(A) Max(Typ.)
BDHE00322512R47MQ1	0.47	20	2	25(19)	7.0(8.2)	4.6(5.2)
BDHE003225121R0MQ1	1.0	20	2	34(27.5)	5.7(6.5)	3.7(4.2)
BDHE003225121R5MQ1	1.5	20	2	59(51)	4.0(4.6)	2.8(3.2)
BDHE003225122R2MQ1	2.2	20	2	73(64)	3.5(4.0)	2.7(3.0)

Note: When ordering, please specify tolerance code. Tolerance: M=±20%

- Operating temperature range - 40°C ~ 125°C(Including self - temperature rise)
- Isat for Inductance drop 30% from its value without current
- I rms for a 40°C temperature rise from 25°C ambient with current
- Rated current : Isat or I rms, whichever is smaller
- Absolute maximum voltage 20VDC
- Measure Equipment :
 L : Agilent E4991/HP4286A+16197A (or equivalent), 2MHz 0.2V
 RDC : CHEN HWA502BC/HP4338B (or equivalent)
 Isat : Agilent E4980A+HP42841A (or equivalent)
 I rms : Agilent 6641 SYSTEM DC POWER SUPPLY (or equivalent)

Test Instruments : E4991A Impedance / Material Analyzer

Inductance vs. DC Current

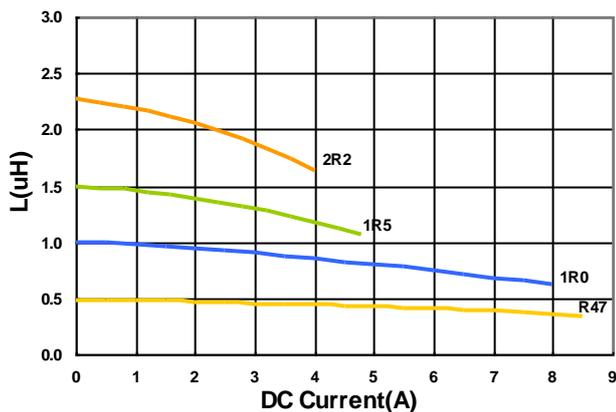

Temperature Change vs. DC Current

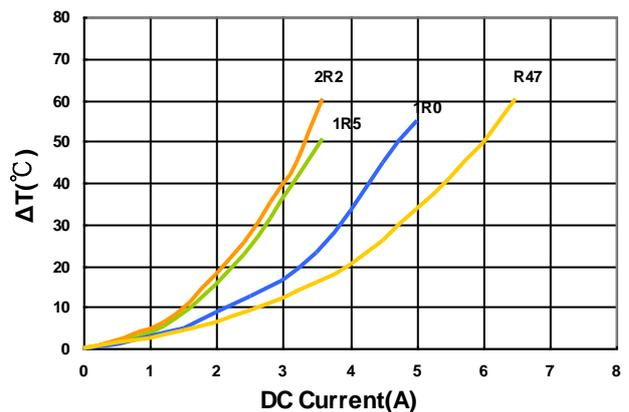

Molding Power Inductors – BDHE Series

Electrical Characteristics

Part Number	Inductance (uH)	Tolerance (±%)	Test Frequency (MHz)	RDC(mΩ) Max(Typ.)	Isat(A) Max(Typ.)	Irms(A) Max(Typ.)
BDHE003225251R0MQ1	1.0	20	2	34(28)	6.0(8.0)	3.5(4.3)
BDHE003225251R5MQ1	1.5	20	2	45(35)	5.5(7.5)	3.2(3.9)
BDHE003225252R2MQ1	2.2	20	2	60(49)	4.8(6.5)	3.0(3.3)

Note: When ordering, please specify tolerance code. Tolerance: M=±20%

- Operating temperature range - 40°C ~ 125°C(Including self - temperature rise)
- Isat for Inductance drop 30% from its value without current
- I rms for a 40°C temperature rise from 25°C ambient with current
- Rated current : Isat or I rms, whichever is smaller
- Absolute maximum voltage 20VDC
- Measure Equipment :
 L : Agilent E4991/HP4286A+16197A (or equivalent), 2MHz 0.2V
 RDC : CHEN HWA502BC/HP4338B (or equivalent)
 Isat : Agilent E4980A+HP42841A (or equivalent)
 I rms : Agilent 6641 SYSTEM DC POWER SUPPLY (or equivalent)

Test Instruments : E4991A Impedance / Material Analyzer

Inductance vs. DC Current

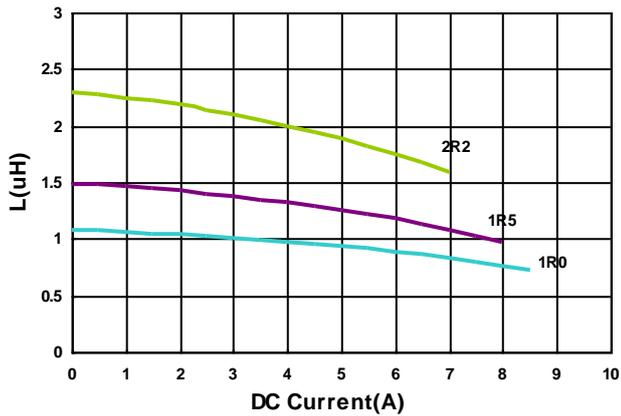

Temperature Change vs. DC Current

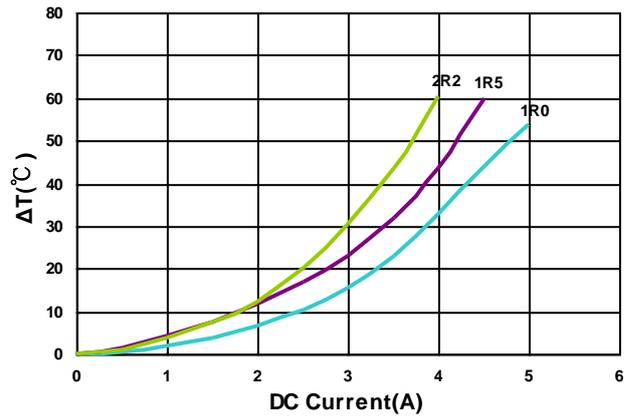

Packaging Specifications

Tape Dimensions

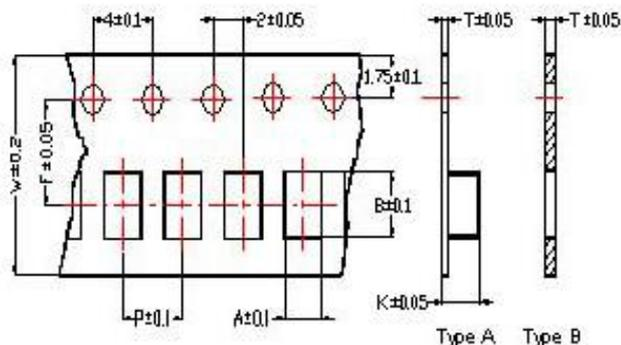

Tape Material

Carrier Tape: Polycarbonate (Tape A)
 Carrier Tape: Paper (Tape B)
 Cover Tape: Polystyrene

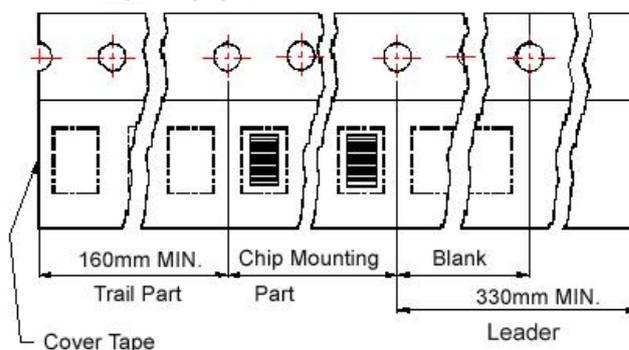

Reel Dimensions

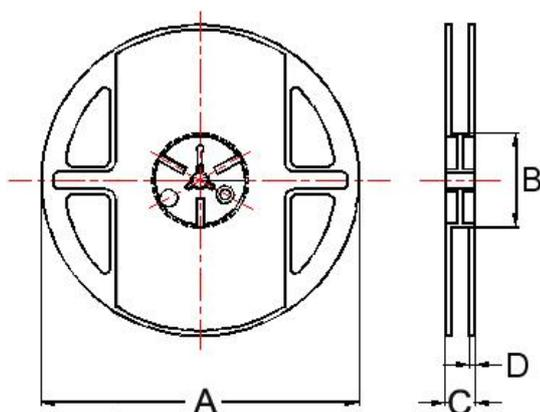

Dimensions in mm

TYPE	Tape Dimensions								Reel Dimensions				Quantity PCS / REEL
	Tape	A	B	T	W	P	F	K	A	B	C	D	
BDHE00160808	B	1.20	1.88	0.95	8	4	3.5	-	178	60	12	1.5	4000
BDHE00201208	A	1.45	2.25	0.22	8	4	3.5	1.04	178	60	12	1.5	3000
BDHE00201210	A	1.50	2.25	0.22	8	4	3.5	1.15	178	60	12	1.5	3000
BDHE00201608	A	1.80	2.35	0.23	8	4	3.5	0.85	178	60	12	1.5	3000
BDHE00201610	A	1.90	2.30	0.22	8	4	3.5	1.15	178	60	12	1.5	3000
BDHE00201612	A	1.90	2.30	0.22	8	4	3.5	1.15	178	60	12	1.5	3000
BDHE00252010	A	2.25	2.80	0.22	8	4	3.5	1.15	178	60	12	1.5	3000
BDHE00252012	A	2.30	2.80	0.22	8	4	3.5	1.35	178	60	12	1.5	3000
BDHE00322510	A	2.80	3.55	0.23	8	4	3.5	1.20	178	60	12	1.5	3000
BDHE00322512	A	2.80	3.50	0.23	8	4	3.5	1.34	178	60	12	1.5	3000
BDHE00322525	A	2.90	3.50	0.23	8	4	3.5	2.90	178	60	12	1.5	1500

X-ON Electronics

Largest Supplier of Electrical and Electronic Components

Click to view similar products for [Fixed Inductors](#) category:

Click to view products by [Chilisin](#) manufacturer:

Other Similar products are found below :

[CR32NP-100KC](#) [70F224AI](#) [MHQ1005P10NJ](#) [MHQ1005P1N0S](#) [MHQ1005P2N4S](#) [MHQ1005P3N6S](#) [MHQ1005P5N1S](#) [MHQ1005P8N2J](#)
[PE-53601NL](#) [PE-53602NL](#) [PG0936.113NLT](#) [9220-20](#) [9310-16](#) [PM06-2N7](#) [PM06-39NJ](#) [A01TK](#) [1206CS-471XJ](#) [HC2-R47-R](#) [HC8-1R2-R](#)
[HCF1305-3R3-R](#) [1206CS-151XG](#) [RCH664NP-4R7M](#) [RCP1317NP-391L](#) [DH2280-4R7M](#) [DS1608C-106](#) [B10TJ](#) [B82498B3101J000](#) [ELJ-](#)
[RE27NJF2](#) [1812CS-153XJ](#) [1812CS-183XJ](#) [1812CS-223XJ](#) [1812LS-104XJ](#) [1812LS-105XJ](#) [1812LS-124XJ](#) [1812LS-154XJ](#) [1812LS-223XJ](#)
[1812LS-224XJ](#) [1812LS-563XJ](#) [1812LS-683XJ](#) [1812LS-824XJ](#) [NIN-FB101JTR110F](#) [NIN-FB471JTR62F](#) [NIN-FC1R5JTR220F](#) [NIN-](#)
[HCR15JTRF](#) [NIN-HCR33JTRF](#) [NIN-HDR22JTRF](#) [NIN-HDR82JTRF](#) [NIN-HK2N7STRF](#) [NIN-PA150KTR370F](#) [NIN-PB100KTR550F](#)