

BMQx Series



BMQx series is low profile molding power choke with low RDC and high Q factor, so the efficiency performance is also superior. Its molded magnetic shielded type is suitable for high-density mounting and ultra-low buzz noise. Soldering conditions can be easily confirmed when mounting onto the board. This series also provides customers with embossed carrier type packaging for automatic mounting machine.

Features

- RoHS, Halogen Free and REACH Compliance
- Low RDC
- High Q
- High Efficiency
- Ultra-low buzz noise

Applications

- Laptops and PCs
- Switches and servers
- Base stations
- DC/DC converters

Product Identification

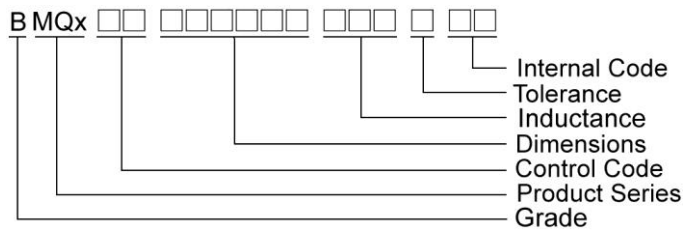

Shape and Dimensions

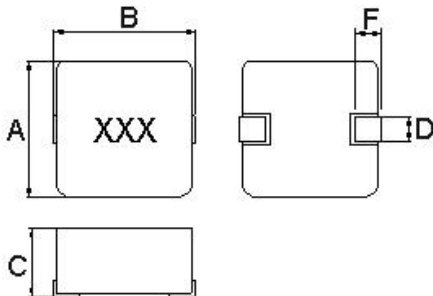

Recommended Pattern

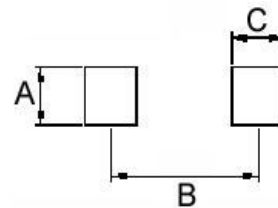

Dimensions in mm

TYPE	A	B	C	D	F
BMQE00040410	4.1±0.2	4.6±0.2	1.0Max	1.5±0.3	1.0±0.3
BMQE00040411	4.1±0.2	4.6±0.2	1.1Max	1.5±0.3	1.0±0.3
BMQA00040420	4.2±0.2	4.8±0.2	1.8±0.2	1.5±0.3	1.1±0.3
BMQE00050511	5.5±0.2	5.7±0.2	1.1Max	2.0±0.3	1.5±0.3
BMQA00050530	5.5±0.25	5.85±0.25	2.8±0.2	2.0±0.25	1.5±0.25
BMQE00060611	6.6±0.2	6.95±0.35	1.1Max	3.0±0.3	1.6±0.3
BMQA00060620	6.8±0.2	6.95±0.35	1.8±0.2	3.0±0.3	1.6±0.3
BMQA00060630	6.8±0.2	7.3±0.2	2.8±0.2	3.0±0.3	1.6±0.3
BMQA00101040	10.2±0.3	11.3±0.3	3.8±0.2	3.0±0.5	2.5±0.5

Dimensions in mm

TYPE	A	B	C
BMQE00040410	2.5	3.7	1.5
BMQE00040411	2.5	3.7	1.5
BMQA00040420	2.5	3.7	1.5
BMQE00050511	2.5	4.1	1.9
BMQA00050530	2.5	4.6	1.9
BMQE00060611	3.5	6.05	2.35
BMQA00060620	3.5	6.05	2.35
BMQA00060630	3.5	6.05	2.35
BMQA00101040	4.0	9.50	3.50

Molding Power Inductors – BMQx Series

Electrical Characteristics

Part Number	Inductance (uH)	Tolerance (±%)	Test Frequency (kHz)	RDC(mΩ) Max(Typ.)	Isat(A) Max(Typ.)	Irms(A) Max(Typ.)	Marking
BMQE0004010R33MAA	0.33	20	100	14(12)	9.0(11)	6.0(7.0)	R33
BMQE00040101R0MAA	1.0	20	100	43(39)	4.0(5.0)	4.0(4.5)	1R0

Note: When ordering, please specify tolerance code. Tolerance: M=±20%

- Operating temperature range - 55°C ~ 125°C(Including self - temperature rise)
- Isat for Inductance drop 30% from its value without current
- I rms for a 40°C temperature rise from 25°C ambient with current
- Absolute maximum voltage 30VDC
- Measure Equipment :
 - L : WK 3260B or WK 6500P, 100kHz 0.5V
 - RDC : CHEN HWA 502 or CHEN HWA 46502B
 - I rms : CHROMA 1810

Test Instruments : WK3260B Impedance / Material Analyzer

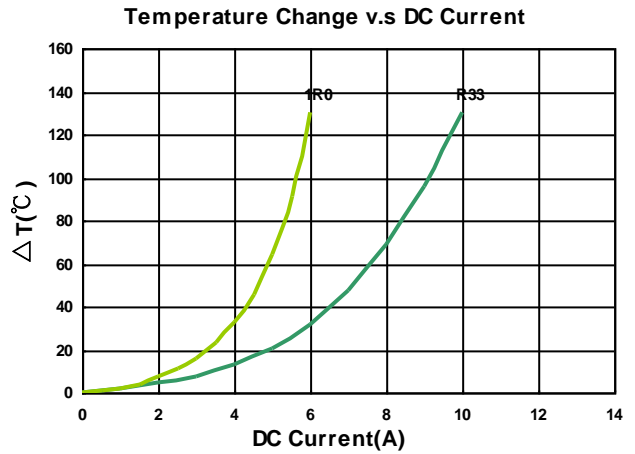
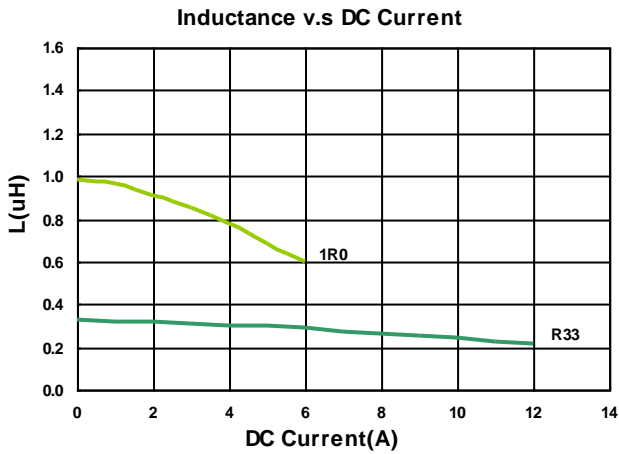

Molding Power Inductors – BMQx Series

Electrical Characteristics

Part Number	Inductance (uH)	Tolerance (±%)	Test Frequency (kHz)	RDC(mΩ) Max(Typ.)	Isat(A) Max(Typ.)	Irms(A) Max(Typ.)	Marking
BMQE000404111R0MAA	1.0	20	100	38.5(35)	5.4(6.0)	4.3(4.8)	1R0
BMQE000404112R2MAA	2.2	20	100	82(75)	3.5(4.0)	3.0(3.3)	2R2

Note: When ordering, please specify tolerance code. Tolerance: M=±20%

- Operating temperature range - 55°C ~ 125°C(Including self - temperature rise)
- Isat for Inductance drop 30% from its value without current
- I rms for a 40°C temperature rise from 25°C ambient with current
- Absolute maximum voltage 30VDC
- Measure Equipment :
 L : WK 3260B or WK 6500P, 100kHz 0.5V
 RDC : CHEN HWA 502 or CHEN HWA 46502B
 I rms : CHROMA 1810

Test Instruments : WK3260B Impedance / Material Analyzer

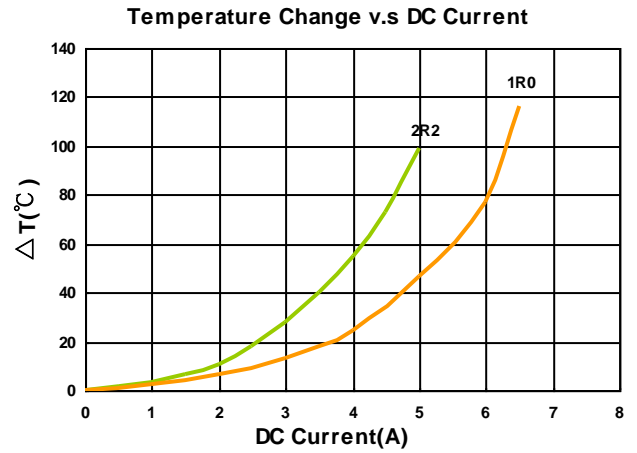
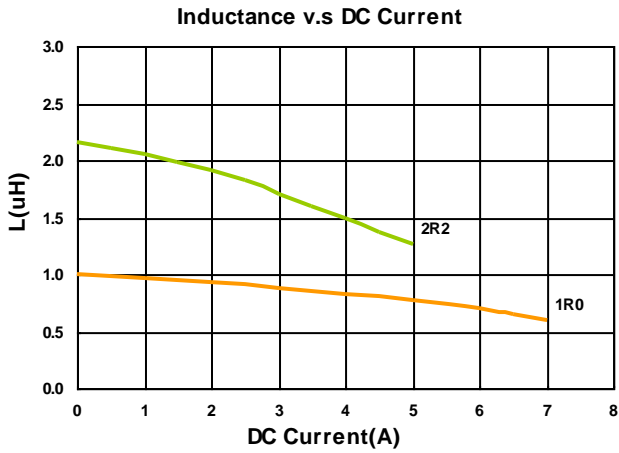

Molding Power Inductors – BMQx Series

Electrical Characteristics

Part Number	Inductance (uH)	Tolerance (±%)	Test Frequency (kHz)	RDC(mΩ) Max(Typ.)	Isat(A) Max(Typ.)	Irms(A) Max(Typ.)	Marking
BMQA00040420R22MA1	0.22	20	100	5.5(5.0)	18(20)	10(11)	R22
BMQA000404201R0MA1	1.0	20	100	17(16)	8.0(8.5)	5.5(6.0)	1R0
BMQA000404202R2MA1	2.2	20	100	38.5(35)	6.0(6.5)	4.0(4.5)	2R2
BMQA000404204R7MA1	4.7	20	100	85(77)	4.0(4.5)	2.5(2.8)	4R7

Note: When ordering, please specify tolerance code. Tolerance: M=±20%

- Operating temperature range - 55°C ~ 125°C(Including self - temperature rise)
- Isat for Inductance drop 30% from its value without current
- I rms for a 40°C temperature rise from 25°C ambient with current
- Absolute maximum voltage 30VDC
- Measure Equipment :
 L : WK 3260B or WK 6500P, 100kHz 0.5V
 RDC : CHEN HWA 502 or CHEN HWA 46502B
 I rms : CHROMA 1810

Test Instruments : WK3260B Impedance / Material Analyzer

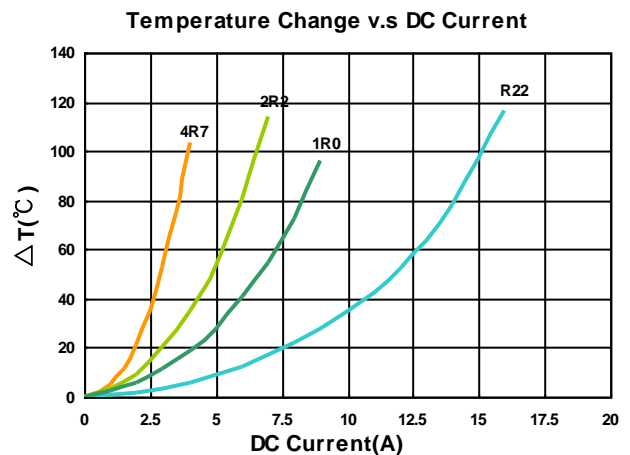
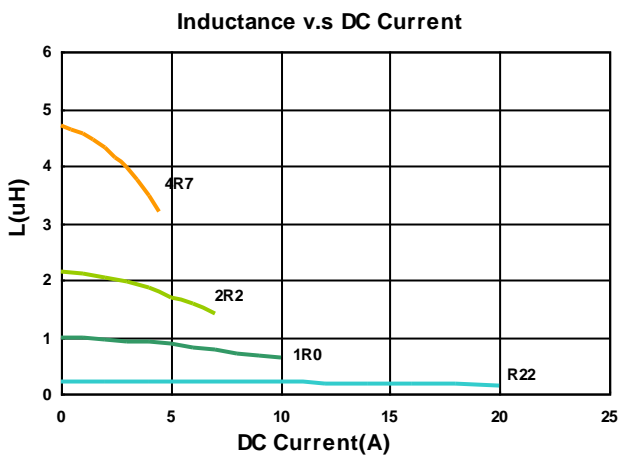

Molding Power Inductors – BMQx Series

Electrical Characteristics

Part Number	Inductance (uH)	Tolerance (±%)	Test Frequency (kHz)	RDC(mΩ) Max(Typ.)	Isat(A) Max(Typ.)	Irms(A) Max(Typ.)	Marking
BMQE000505111R0MAA	1.0	20	100	33(30)	7.0(7.5)	4.8(5.3)	1R0

Note: When ordering, please specify tolerance code. Tolerance: M=±20%

- Operating temperature range - 55°C ~ 125°C(Including self - temperature rise)
- Isat for Inductance drop 30% from its value without current
- I rms for a 40°C temperature rise from 25°C ambient with current
- Absolute maximum voltage 30VDC
- Measure Equipment :
 L : WK 3260B or WK 6500P, 100kHz 0.5V
 RDC : CHEN HWA 502 or CHEN HWA 46502B
 I rms : CHROMA 1810

Test Instruments : WK3260B Impedance / Material Analyzer

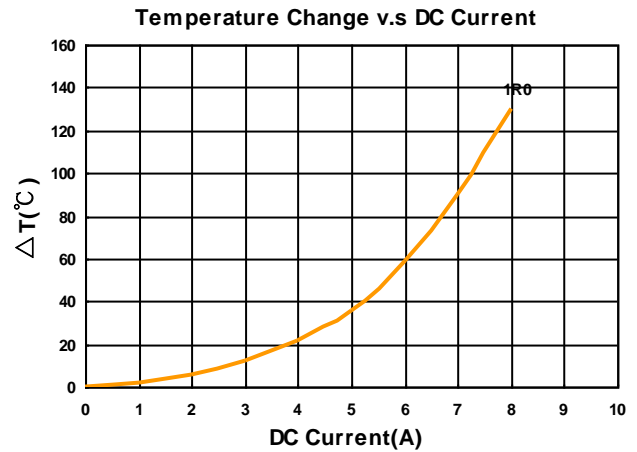
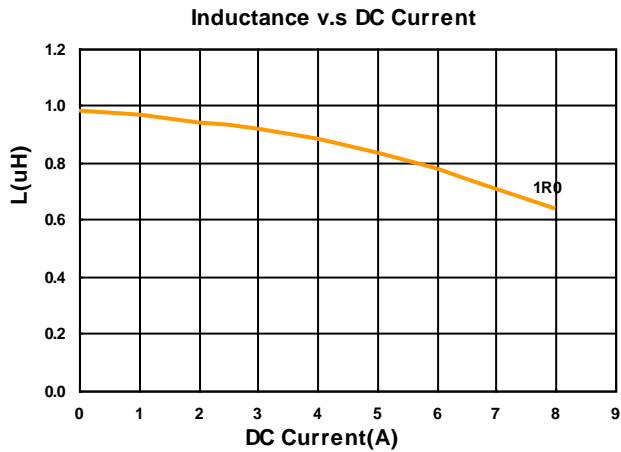

Molding Power Inductors – BMQx Series

Electrical Characteristics

Part Number	Inductance (uH)	Tolerance (±%)	Test Frequency (kHz)	RDC(mΩ) Max(Typ.)	Isat(A) Max(Typ.)	Irms(A) Max(Typ.)	Marking
BMQA00050530R22MA1	0.22	20	100	3.90(3.5)	28(32)	18.0(20.0)	R22
BMQA00050530R36MA1	0.36	20	100	4.95(4.5)	23(25)	12.5(13.5)	R36
BMQA00050530R68MA1	0.68	20	100	6.30(5.7)	17(18)	11.0(12.0)	R68
BMQA000505301R0MA1	1.0	20	100	9.8(8.9)	16(18)	9.00(9.50)	1R0
BMQA000505301R5MA1	1.5	20	100	15(13.5)	12.5(13.5)	7.50(8.0)	1R5
BMQA000505302R2MA1	2.2	20	100	20(18)	11.5(12.5)	6.00(6.5)	2R2
BMQA000505304R7MA1	4.7	20	100	40(37)	6.5(7.50)	4.50(5.0)	4R7

Note: When ordering, please specify tolerance code. Tolerance: M=±20%

- Operating temperature range - 55°C ~ 125°C(Including self - temperature rise)
- Isat for Inductance drop 30% from its value without current
- Irms for a 40°C temperature rise from 25°C ambient with current
- Absolute maximum voltage 30VDC
- Measure Equipment :
 L : WK 3260B or WK 6500P, 100kHz 0.5V
 RDC : CHEN HWA 502 or CHEN HWA 46502B
 Irms : CHROMA 1810

Test Instruments : WK3260B Impedance / Material Analyzer

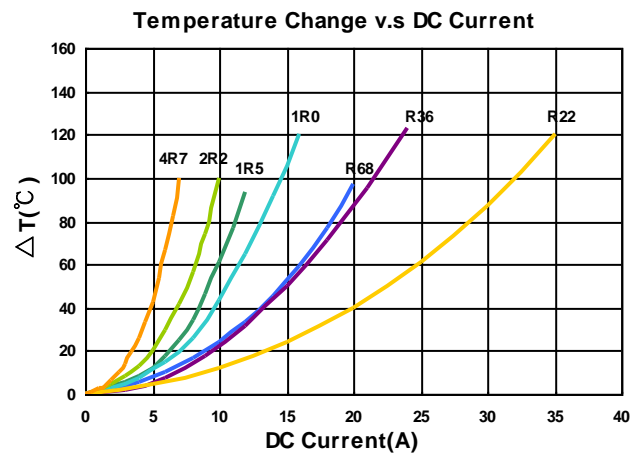
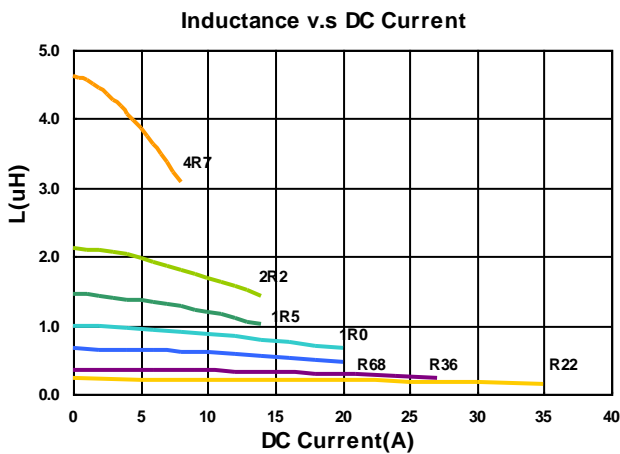

Molding Power Inductors – BMQx Series

Electrical Characteristics

Part Number	Inductance (uH)	Tolerance (±%)	Test Frequency (kHz)	RDC(mΩ) Max(Typ.)	Isat(A) Max(Typ.)	Irms(A) Max(Typ.)	Marking
BMQE000606111R0MAA	1.0	20	100	26(24.5)	7.0(7.8)	6.8(7.3)	1R0
BMQE000606112R2MAA	2.2	20	100	57(52)	5.0(6.0)	4.2(4.6)	2R2

Note: When ordering, please specify tolerance code. Tolerance: M=±20%

- Operating temperature range - 55°C ~ 125°C(Including self - temperature rise)
- Isat for Inductance drop 30% from its value without current
- I rms for a 40°C temperature rise from 25°C ambient with current
- Absolute maximum voltage 30VDC
- Measure Equipment :
 L : WK 3260B or WK 6500P, 100kHz 0.5V
 RDC : CHEN HWA 502 or CHEN HWA 46502B
 I rms : CHROMA 1810

Test Instruments : WK3260B Impedance / Material Analyzer

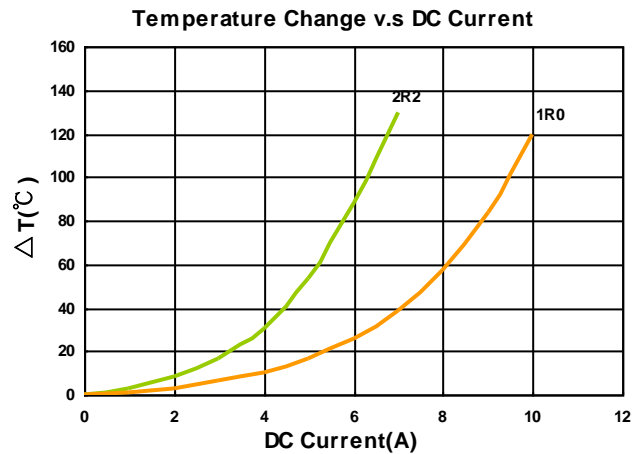
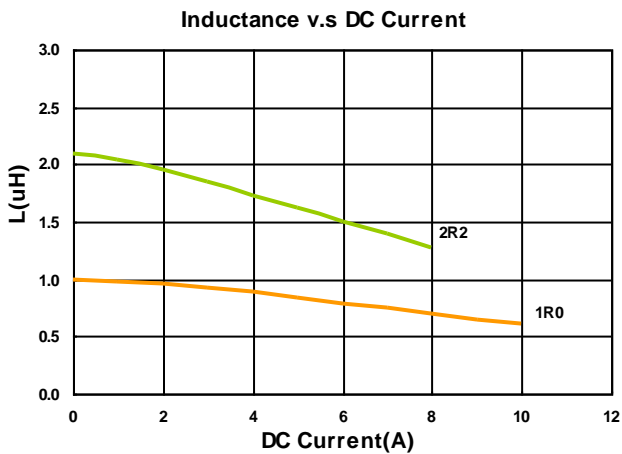

Molding Power Inductors – BMQx Series

Electrical Characteristics

Part Number	Inductance (uH)	Tolerance (±%)	Test Frequency (kHz)	RDC(mΩ) Max(Typ.)	Isat(A) Max(Typ.)	Irms(A) Max(Typ.)	Marking
BMQA000606204R7MA1	4.7	20	100	48(43.7)	6.0(6.8)	4.2(4.7)	4R7

Note: When ordering, please specify tolerance code. Tolerance: M=±20%

- Operating temperature range - 55°C ~ 125°C(Including self - temperature rise)
- Isat for Inductance drop 30% from its value without current
- I rms for a 40°C temperature rise from 25°C ambient with current
- Absolute maximum voltage 30VDC
- Measure Equipment :
 L : WK 3260B or WK 6500P, 100kHz 0.5V
 RDC : CHEN HWA 502 or CHEN HWA 46502B
 I rms : CHROMA 1810

Test Instruments : WK3260B Impedance / Material Analyzer

Inductance v.s DC Current

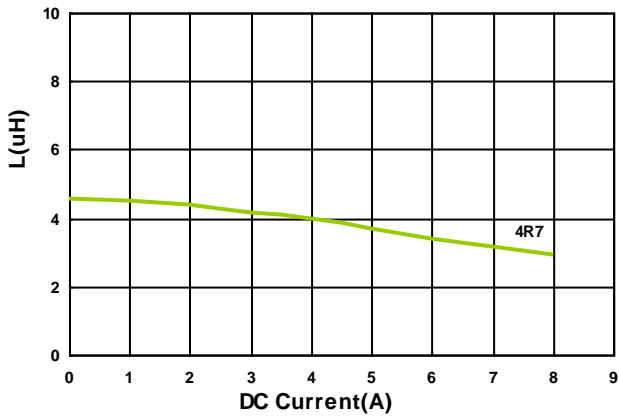

Temperature Change v.s DC Current

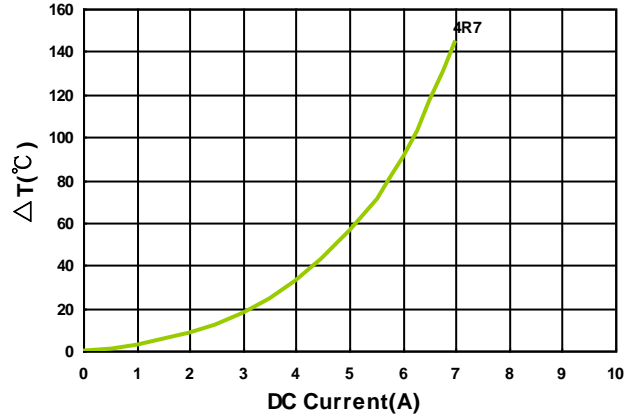

Molding Power Inductors – BMQx Series

Electrical Characteristics

Part Number	Inductance (uH)	Tolerance (±%)	Test Frequency (kHz)	RDC(mΩ) Max(Typ.)	Isat(A) Max(Typ.)	Irms(A) Max(Typ.)	Marking
BMQA00060630R22MA1	0.22	20	100	2.0(1.8)	35(40)	25(27)	R22
BMQA00060630R36MA1	0.36	20	100	2.6(2.3)	27(32)	23(25)	R36
BMQA00060630R47MA1	0.47	20	100	3.3(2.9)	25(27)	19(20)	R47
BMQA00060630R56MA1	0.56	20	100	3.9(3.5)	23(25)	17(18)	R56
BMQA00060630R68MA1	0.68	20	100	4.2(3.8)	18(20)	16(17)	R68
BMQA00060630R1R0MA1	1.0	20	100	5.3(4.8)	17(19)	14(15)	1R0
BMQA00060630R1R5MA1	1.5	20	100	7.7(7.0)	15(17)	11(11.5)	1R5
BMQA00060630R2R2MA1	2.2	20	100	9.4(8.5)	12(12.5)	10.5(11)	2R2
BMQA00060630R3R3MA1	3.3	20	100	15(13.5)	9.0(9.5)	8.0(8.5)	3R3
BMQA00060630R4R7MA1	4.7	20	100	22.0(20)	6.5(7.0)	6.0(6.5)	4R7
BMQA00060630R6R8MA1	6.8	20	100	38.5(35)	6.0(6.5)	5.3(5.8)	6R8
BMQA00060630R8R2MA1	8.2	20	100	47.0(43)	5.5(6.0)	5.0(5.4)	8R2
BMQA00060630R100MA1	10	20	100	47.0(43)	5.0(5.5)	4.8(5.3)	100

Note: When ordering, please specify tolerance code. Tolerance: M=±20%

- Operating temperature range - 55°C ~ 125°C(Including self - temperature rise)
- Isat for Inductance drop 30% from its value without current
- Irms for a 40°C temperature rise from 25°C ambient with current
- Absolute maximum voltage 30VDC
- Measure Equipment :
 L : WK 3260B or WK 6500P, 100kHz 0.5V
 RDC : CHEN HWA 502 or CHEN HWA 46502B
 Irms : CHROMA 1810

Test Instruments : WK3260B Impedance / Material Analyzer

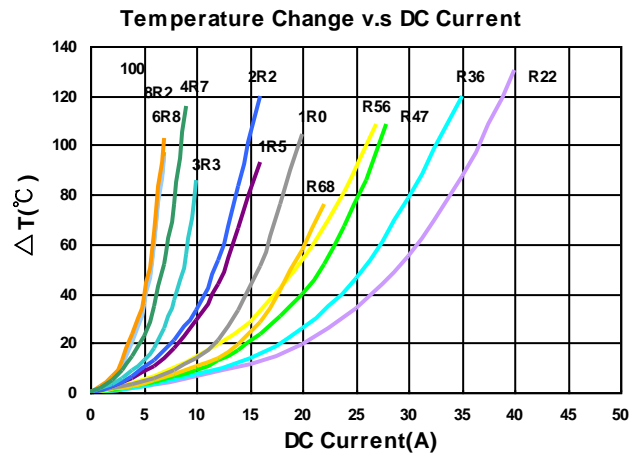
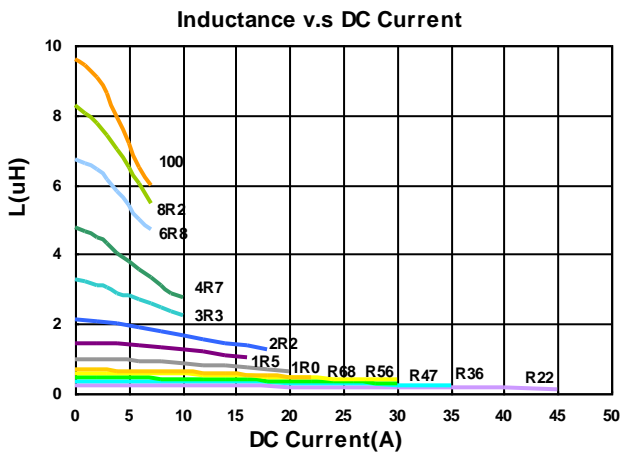

Molding Power Inductors – BMQx Series

Electrical Characteristics

Part Number	Inductance (uH)	Tolerance (±%)	Test Frequency (kHz)	RDC(mΩ) Max(Typ.)	Isat(A) Max(Typ.)	Irms(A) Max(Typ.)	Marking
BMQA00101040R22MD1	0.22	20	100	0.54(0.45)	55(60)	40(42)	R22
BMQA00101040R33MD1	0.33	20	100	0.68(0.62)	45(50)	32(35)	R33
BMQA00101040R68MD1	0.68	20	100	1.5(1.3)	32(37)	25(27)	R68
BMQA001010401R0MD1	1.0	20	100	2.4(2.2)	26(30)	23(25)	1R0
BMQA001010402R2MA1	2.2	20	100	4.7(4.3)	17(20)	15(15.6)	2R2
BMQA001010403R3MA1	3.3	20	100	7.9(7.2)	16(18)	12(12.5)	3R3
BMQA001010404R7MA1	4.7	20	100	10.5(9.5)	13(14)	10.5(11)	4R7
BMQA001010406R8MA1	6.8	20	100	16.5(15)	9.0(10)	8.5(9.0)	6R8
BMQA00101040100MA1	10	20	100	24(22)	8.5(9.0)	8.0(8.5)	100

Note: When ordering, please specify tolerance code. Tolerance: M=±20%

- Operating temperature range - 55°C ~ 125°C(Including self - temperature rise)
- Isat for Inductance drop 30% from its value without current
- I rms for a 40°C temperature rise from 25°C ambient with current
- Absolute maximum voltage 30VDC
- Measure Equipment :
 L : WK 3260B or WK 6500P, 100kHz 0.5V
 RDC : CHEN HWA 502 or CHEN HWA 46502B
 I rms : CHROMA 1810

Test Instruments : WK3260B Impedance / Material Analyzer

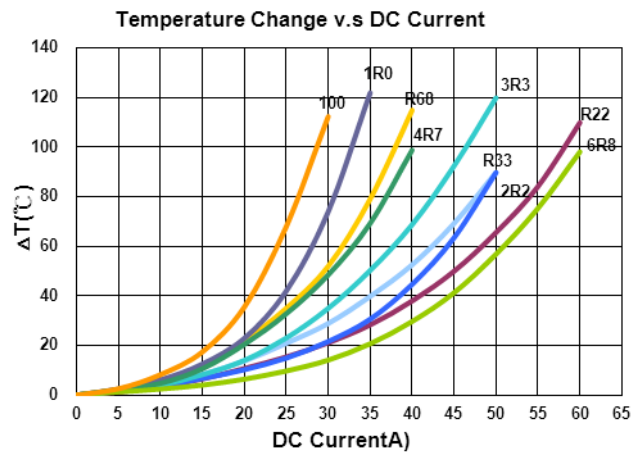
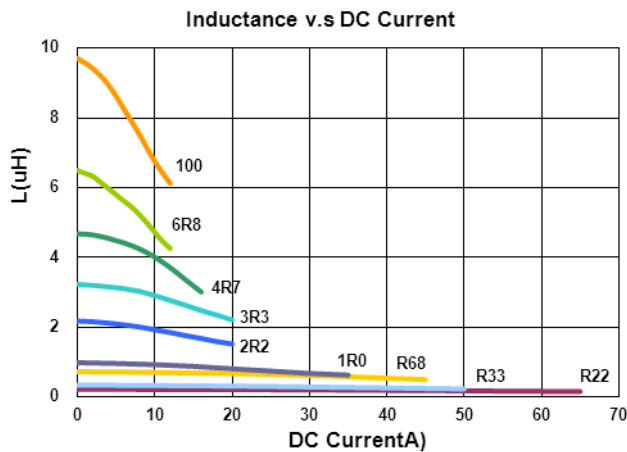

Packaging Specifications

Tape Dimensions

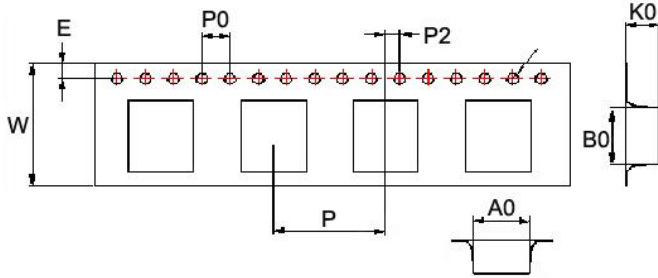

Tape Material

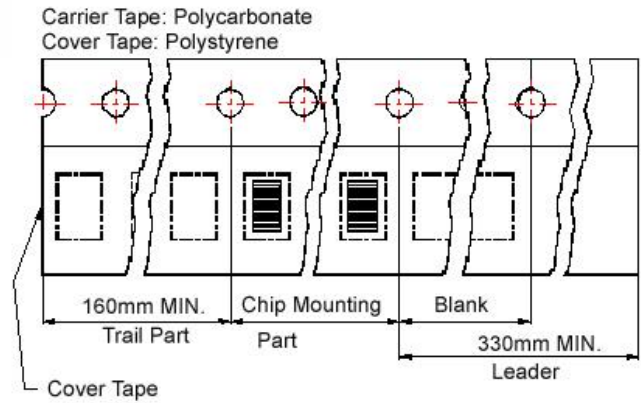

Reel Dimensions

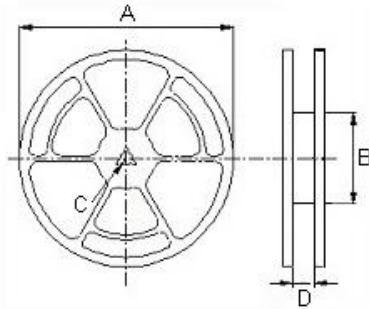

Dimensions in mm

TYPE	Tape Dimensions									Reel Dimensions				Quantity PCS / REEL
	A0	B0	K0	D	E	W	P	P0	P2	A	B	C	D	
BMQE00040410	4.4	4.9	1.4	1.55	1.75	12	8	4	2	330	100	13	13.4	2000
BMQE00040411	4.4	4.9	1.5	1.55	1.75	12	8	4	2	330	100	13	13.4	2000
BMQA00040420	4.5	5.1	2.4	1.55	1.75	12	8	4	2	330	100	13	13.4	2000
BMQE00050511	5.9	6.2	1.5	1.55	1.75	16	12	4	2	330	100	13	16	2000
BMQA00050530	5.9	6.25	3.4	1.55	1.75	16	12	4	2	330	100	13	16	1000
BMQE00060611	6.9	7.4	1.5	1.55	1.75	16	12	4	2	330	100	13	16	1000
BMQA00060620	7.05	7.6	2.7	1.55	1.75	16	12	4	2	330	100	13	16	1000
BMQA00060630	7.0	7.6	3.4	1.55	1.75	16	12	4	2	330	100	13	16	1000
BMQA00101040	10.6	11.7	4.25	1.55	1.75	24	16	4	2	330	100	13	24.4	500

X-ON Electronics

Largest Supplier of Electrical and Electronic Components

Click to view similar products for [Fixed Inductors](#) category:

Click to view products by [Chilisin](#) manufacturer:

Other Similar products are found below :

[CR32NP-100KC](#) [CR54NP-470LC](#) [70F224AI](#) [MGDQ4-00004-P](#) [MHQ1005P10NJ](#) [MHQ1005P1N0S](#) [MHQ1005P2N4S](#) [MHQ1005P3N6S](#)
[MHQ1005P5N1S](#) [MHQ1005P8N2J](#) [PE-53601NL](#) [PE-53602NL](#) [PG0936.113NLT](#) [9220-20](#) [9310-16](#) [PM06-2N7](#) [PM06-39NJ](#) [A01TK](#)
[1206CS-471XJ](#) [HC2-R47-R](#) [HC8-1R2-R](#) [HCF1305-3R3-R](#) [1206CS-151XG](#) [RCH664NP-140L](#) [RCH664NP-4R7M](#) [RCP1317NP-391L](#)
[RCR110DNP-331L](#) [DH2280-4R7M](#) [DS1608C-106](#) [B10TJ](#) [B82498B3101J000](#) [ELJ-RE27NJF2](#) [1812CS-153XJ](#) [1812CS-183XJ](#) [1812CS-](#)
[223XJ](#) [1812LS-104XJ](#) [1812LS-105XJ](#) [1812LS-124XJ](#) [1812LS-154XJ](#) [1812LS-223XJ](#) [1812LS-224XJ](#) [1812LS-563XJ](#) [1812LS-683XJ](#)
[1812LS-824XJ](#) [NIN-FB101JTR110F](#) [NIN-FB471JTR62F](#) [NIN-FC1R5JTR220F](#) [NIN-HCR15JTRF](#) [NIN-HCR33JTRF](#) [NIN-HDR22JTRF](#)