

BSCQ Series



BSCQ Series supports miniaturized devices. Its low inductance, high precision and high Q enables easy impedance matching at both RF and IF circuits and compact high frequency circuit designing.

Features

- Excellent high frequency application
- High Q factor and SRF value
- Miniaturization
- Tight tolerance
- Wide inductance range

Applications

- RF matching circuit requiring Q value
- Bluetooth, WLAN, UWB, digital TV tuners and high-frequency circuit and module

Product Identification

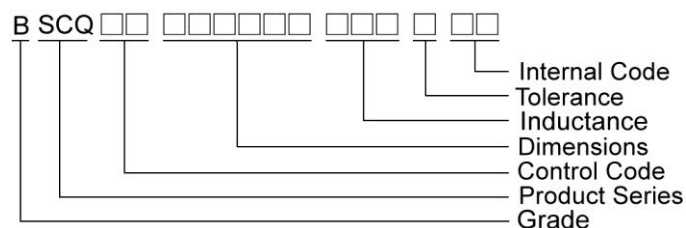

Shape and Dimensions

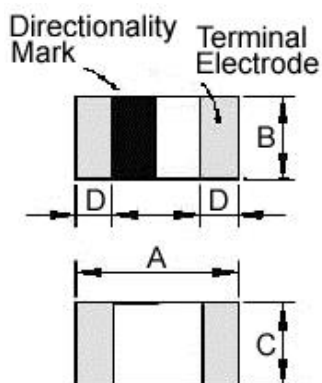

Dimensions in mm

| TYPE | A | B | C | D |
|--------------|----------|----------|----------|-----------|
| BSCQ00060303 | 0.6±0.03 | 0.3±0.03 | 0.3±0.03 | 0.15±0.05 |

Recommended Pattern

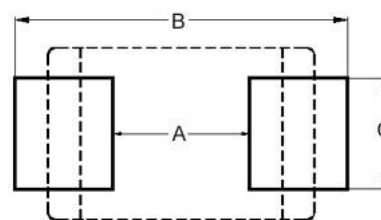

Dimensions in mm

| TYPE | A | B | C |
|--------------|-----|-------------|-----|
| BSCQ00060303 | 0.3 | 0.75 ~ 1.05 | 0.3 |

SMD Ceramic Multilayer Chip Inductors – BSCQ Series

Electrical Characteristics

| Part Number | Inductance (nH) | Tolerance (±%) | Q Min | Test Freq. (MHz) | Q Typical | | | | | SRF (MHz) Min | RDC (Ω) Max | IDC (mA) Max |
|--------------------|-----------------|----------------------|-------|------------------|-----------|---------|---------|---------|---------|---------------|-------------|--------------|
| | | | | | 500 MHz | 800 MHz | 1.8 GHz | 2.0 GHz | 2.4 GHz | | | |
| BSCQ000603030N6□00 | 0.6 | ±0.1nH/±0.2nH/±0.3nH | 14 | 500 | >24 | >32 | >54 | >57 | >65 | 10000 | 0.06 | 900 |
| BSCQ000603030N7□00 | 0.7 | ±0.1nH/±0.2nH/±0.3nH | 14 | 500 | >24 | >32 | >54 | >57 | >65 | 10000 | 0.06 | 900 |
| BSCQ000603030N8□00 | 0.8 | ±0.1nH/±0.2nH/±0.3nH | 14 | 500 | >24 | >32 | >54 | >57 | >65 | 10000 | 0.06 | 900 |
| BSCQ000603030N9□00 | 0.9 | ±0.1nH/±0.2nH/±0.3nH | 14 | 500 | >24 | >32 | >54 | >57 | >65 | 10000 | 0.06 | 900 |
| BSCQ000603031N0□00 | 1.0 | ±0.1nH/±0.2nH/±0.3nH | 14 | 500 | 23 | 32 | 54 | 57 | 65 | 10000 | 0.07 | 850 |
| BSCQ000603031N1□00 | 1.1 | ±0.1nH/±0.2nH/±0.3nH | 14 | 500 | 22 | 26 | 45 | 47 | 55 | 10000 | 0.07 | 850 |
| BSCQ000603031N2□00 | 1.2 | ±0.1nH/±0.2nH/±0.3nH | 14 | 500 | 22 | 25 | 43 | 44 | 52 | 10000 | 0.08 | 800 |
| BSCQ000603031N3□00 | 1.3 | ±0.1nH/±0.2nH/±0.3nH | 14 | 500 | 19 | 25 | 40 | 42 | 47 | 10000 | 0.09 | 760 |
| BSCQ000603031N4□00 | 1.4 | ±0.1nH/±0.2nH/±0.3nH | 14 | 500 | 19 | 24 | 339 | 41 | 47 | 10000 | 0.12 | 640 |
| BSCQ000603031N5□00 | 1.5 | ±0.1nH/±0.2nH/±0.3nH | 14 | 500 | 19 | 24 | 39 | 41 | 46 | 10000 | 0.15 | 600 |
| BSCQ000603031N6□00 | 1.6 | ±0.1nH/±0.2nH/±0.3nH | 14 | 500 | 19 | 24 | 39 | 41 | 46 | 10000 | 0.19 | 510 |
| BSCQ000603031N7□00 | 1.7 | ±0.1nH/±0.2nH/±0.3nH | 14 | 500 | 19 | 24 | 39 | 41 | 46 | 10000 | 0.11 | 680 |
| BSCQ000603031N8□00 | 1.8 | ±0.1nH/±0.2nH/±0.3nH | 14 | 500 | 19 | 24 | 39 | 41 | 46 | 10000 | 0.12 | 640 |
| BSCQ000603031N9□00 | 1.9 | ±0.1nH/±0.2nH/±0.3nH | 14 | 500 | 18 | 24 | 38 | 40 | 45 | 10000 | 0.13 | 620 |
| BSCQ000603032N0□00 | 2.0 | ±0.1nH/±0.2nH/±0.3nH | 14 | 500 | 17 | 24 | 38 | 39 | 44 | 10000 | 0.15 | 600 |
| BSCQ000603032N1□00 | 2.1 | ±0.1nH/±0.2nH/±0.3nH | 14 | 500 | 17 | 24 | 37 | 39 | 44 | 10000 | 0.16 | 550 |
| BSCQ000603032N2□00 | 2.2 | ±0.1nH/±0.2nH/±0.3nH | 14 | 500 | 17 | 24 | 38 | 40 | 43 | 10000 | 0.20 | 500 |
| BSCQ000603032N3□00 | 2.3 | ±0.1nH/±0.2nH/±0.3nH | 14 | 500 | 17 | 24 | 37 | 39 | 43 | 10000 | 0.24 | 460 |
| BSCQ000603032N4□00 | 2.4 | ±0.1nH/±0.2nH/±0.3nH | 14 | 500 | 17 | 23 | 36 | 38 | 42 | 10000 | 0.26 | 430 |
| BSCQ000603032N5□00 | 2.5 | ±0.1nH/±0.2nH/±0.3nH | 14 | 500 | 17 | 23 | 35 | 36 | 40 | 10000 | 0.28 | 415 |
| BSCQ000603032N6□00 | 2.6 | ±0.1nH/±0.2nH/±0.3nH | 14 | 500 | 17 | 22 | 34 | 35 | 39 | 10000 | 0.30 | 405 |
| BSCQ000603032N7□00 | 2.7 | ±0.1nH/±0.2nH/±0.3nH | 14 | 500 | 17 | 22 | 34 | 35 | 39 | 10000 | 0.32 | 400 |
| BSCQ000603032N8□00 | 2.8 | ±0.1nH/±0.2nH/±0.3nH | 14 | 500 | 17 | 22 | 34 | 35 | 39 | 9500 | 0.20 | 500 |
| BSCQ000603032N9□00 | 2.9 | ±0.1nH/±0.2nH/±0.3nH | 14 | 500 | 17 | 22 | 34 | 35 | 39 | 9300 | 0.22 | 480 |
| BSCQ000603033N0□00 | 3.0 | ±0.1nH/±0.2nH/±0.3nH | 14 | 500 | 17 | 22 | 34 | 35 | 39 | 9100 | 0.24 | 460 |
| BSCQ000603033N1□00 | 3.1 | ±0.1nH/±0.2nH/±0.3nH | 14 | 500 | 17 | 22 | 34 | 35 | 39 | 8900 | 0.25 | 450 |
| BSCQ000603033N2□00 | 3.2 | ±0.1nH/±0.2nH/±0.3nH | 14 | 500 | 17 | 22 | 33 | 35 | 39 | 8700 | 0.28 | 415 |
| BSCQ000603033N3□00 | 3.3 | ±0.1nH/±0.2nH/±0.3nH | 14 | 500 | 18 | 23 | 34 | 36 | 40 | 8600 | 0.28 | 415 |
| BSCQ000603033N4□00 | 3.4 | ±0.1nH/±0.2nH/±0.3nH | 14 | 500 | 17 | 23 | 33 | 35 | 39 | 8400 | 0.29 | 410 |
| BSCQ000603033N5□00 | 3.5 | ±0.1nH/±0.2nH/±0.3nH | 14 | 500 | 17 | 23 | 33 | 35 | 39 | 8200 | 0.30 | 405 |
| BSCQ000603033N6□00 | 3.6 | ±0.1nH/±0.2nH/±0.3nH | 14 | 500 | 16 | 23 | 33 | 35 | 39 | 8100 | 0.32 | 400 |
| BSCQ000603033N7□00 | 3.7 | ±0.1nH/±0.2nH/±0.3nH | 14 | 500 | 16 | 23 | 33 | 35 | 38 | 8000 | 0.36 | 370 |
| BSCQ000603033N8□00 | 3.8 | ±0.1nH/±0.2nH/±0.3nH | 14 | 500 | 16 | 22 | 33 | 35 | 38 | 7800 | 0.40 | 355 |
| BSCQ000603033N9□00 | 3.9 | ±0.1nH/±0.2nH/±0.3nH | 14 | 500 | 16 | 22 | 33 | 35 | 38 | 7700 | 0.41 | 350 |

Note: When ordering, please specify tolerance code. Tolerance : B=±0.1nH , C=±0.2nH , S=±0.3nH , H=±3% , J=±5%

- Operating temperature range - 55°C ~ 125°C(Including self - temperature rise)
- IDC : Applied the current to coils, the inductance shall be less than 10% initial value
- Residual impedance of short chip : 0.48nH
- Measure Equipment :

L & Q : Agilent E4991A+Agilent 16197A

SRF : Agilent E4991A or HP19196C

RDC : HP4338B or CHEN HWA 502

Please be sure to request approval specifications that provide further details of the products. Kindly note that the content of these specifications are subject to change or may be discontinued without prior notice. This product may not be designed/used in medical or high risk applications without Chilisin approval. Please contact our sales department before ordering.

SMD Ceramic Multilayer Chip Inductors – BSCQ Series

Electrical Characteristics

| Part Number | Inductance (nH) | Tolerance (±%) | Q Min | Test Freq. (MHz) | Q Typical | | | | | SRF (MHz) Min | RDC (Ω) Max | IDC (mA) Max |
|--------------------|-----------------|----------------|-------|------------------|-----------|---------|---------|---------|---------|---------------|-------------|--------------|
| | | | | | 500 MHz | 800 MHz | 1.8 GHz | 2.0 GHz | 2.4 GHz | | | |
| BSCQ000603034N3□00 | 4.3 | ±0.2nH/±0.3nH | 14 | 500 | 16 | 21 | 32 | 34 | 37 | 6500 | 0.48 | 320 |
| BSCQ000603034N7□00 | 4.7 | ±0.2nH/±0.3nH | 14 | 500 | 16 | 22 | 33 | 35 | 38 | 6400 | 0.42 | 350 |
| BSCQ000603035N1□00 | 5.1 | ±0.2nH/±0.3nH | 14 | 500 | 17 | 22 | 34 | 36 | 38 | 6100 | 0.45 | 330 |
| BSCQ000603035N6□00 | 5.6 | ±0.2nH/±0.3nH | 14 | 500 | 16 | 21 | 33 | 34 | 37 | 5500 | 0.47 | 325 |
| BSCQ000603036N2□00 | 6.2 | ±0.2nH/±0.3nH | 14 | 500 | 18 | 23 | 34 | 35 | 37 | 5100 | 0.52 | 305 |
| BSCQ000603036N8□00 | 6.8 | 3 / 5 | 14 | 500 | 17 | 22 | 32 | 33 | 35 | 4800 | 0.55 | 305 |
| BSCQ000603037N5□00 | 7.5 | 3 / 5 | 14 | 500 | 16 | 21 | 31 | 33 | 34 | 4600 | 0.55 | 305 |
| BSCQ000603038N2□00 | 8.2 | 3 / 5 | 14 | 500 | 16 | 21 | 31 | 32 | 34 | 4300 | 0.57 | 290 |
| BSCQ000603039N1□00 | 9.1 | 3 / 5 | 14 | 500 | 16 | 20 | 30 | 31 | 32 | 4000 | 0.65 | 270 |
| BSCQ0006030310N□00 | 10 | 3 / 5 | 14 | 500 | 16 | 20 | 28 | 29 | 31 | 3800 | 0.85 | 230 |
| BSCQ0006030312N□00 | 12 | 3 / 5 | 12 | 500 | 16 | 20 | 27 | 28 | 28 | 3300 | 0.85 | 230 |
| BSCQ0006030315N□00 | 15 | 3 / 5 | 12 | 500 | 15 | 19 | 24 | 24 | 23 | 2600 | 0.89 | 220 |
| BSCQ0006030318N□00 | 18 | 3 / 5 | 12 | 500 | 15 | 19 | 23 | 24 | 22 | 2300 | 1.05 | 205 |
| BSCQ0006030322N□00 | 22 | 3 / 5 | 12 | 500 | 15 | 19 | 22 | 23 | 20 | 1900 | 1.29 | 190 |

Note: When ordering, please specify tolerance code. Tolerance : B=±0.1nH , C=±0.2nH , S=±0.3nH , H=±3% , J=±5%

- Operating temperature range - 55°C ~ 125°C(Including self - temperature rise)
- IDC : Applied the current to coils, the inductance shall be less than 10% initial value
- Residual impedance of short chip : 0.48nH
- Measure Equipment :
 L & Q : Agilent E4991A+Agilent 16197A
 SRF : Agilent E4991A or HP19196C
 RDC : HP4338B or CHEN HWA 502

Test Instruments : Agilent E4991A Material/Impedance Analyzer

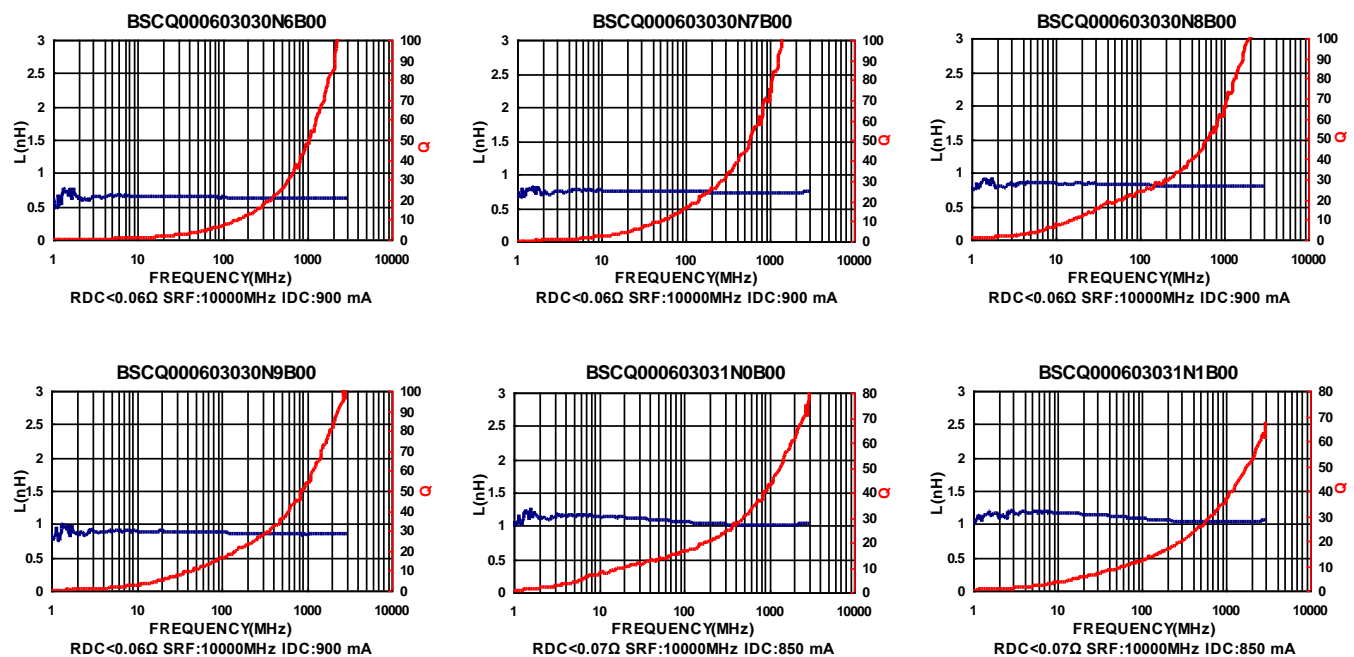

Please be sure to request approval specifications that provide further details of the products. Kindly note that the content of these specifications are subject to change or may be discontinued without prior notice. This product may not be designed/used in medical or high risk applications without Chilisin approval. Please contact our sales department before ordering.

SMD Ceramic Multilayer Chip Inductors – BSCQ Series

Test Instruments : Agilent E4991A Material/Impedance Analyzer

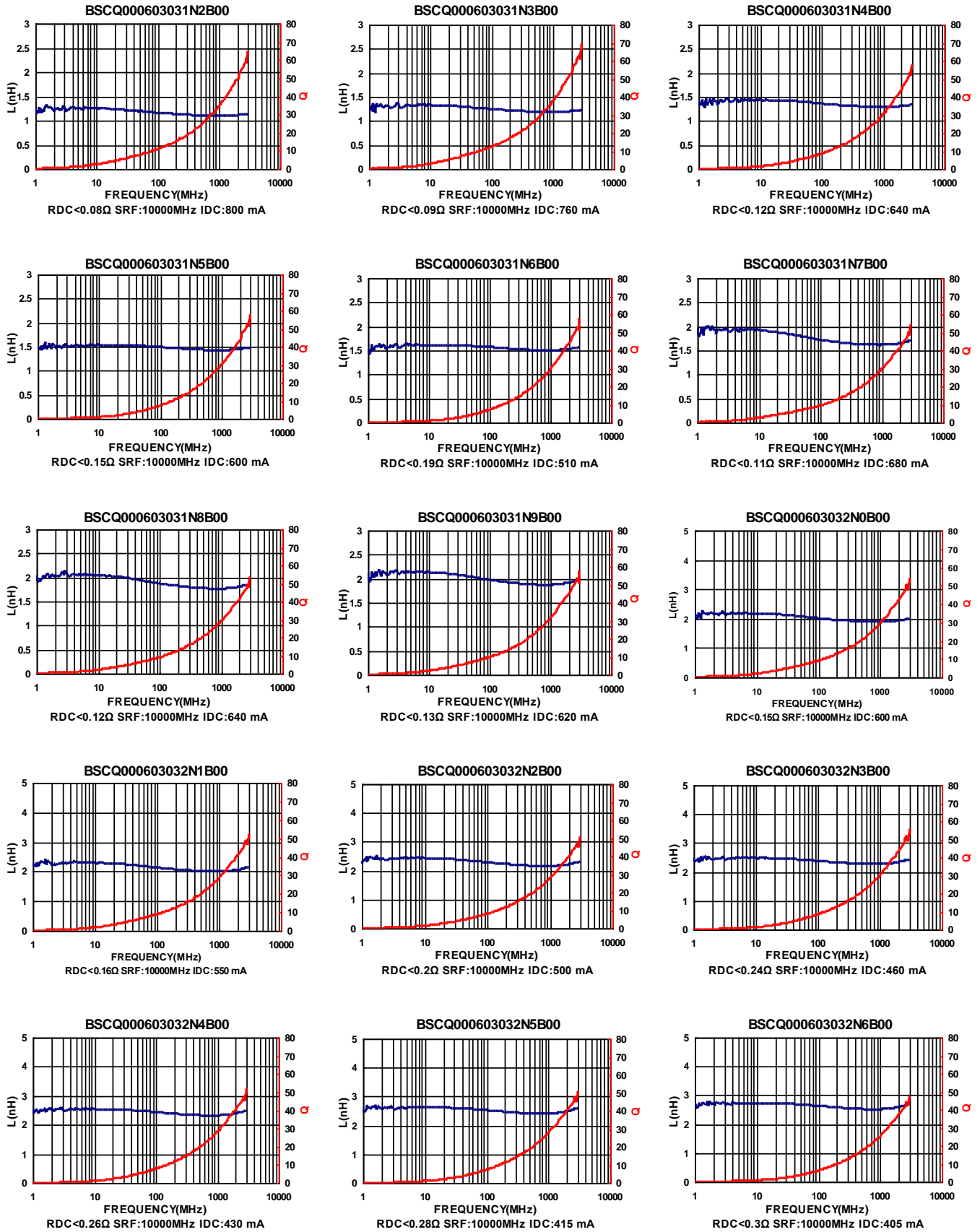

Please be sure to request approval specifications that provide further details of the products. Kindly note that the content of these specifications are subject to change or may be discontinued without prior notice. This product may not be designed/used in medical or high risk applications without Chilisin approval. Please contact our sales department before ordering.

SMD Ceramic Multilayer Chip Inductors – BSCQ Series

Test Instruments : Agilent E4991A Material/Impedance Analyzer

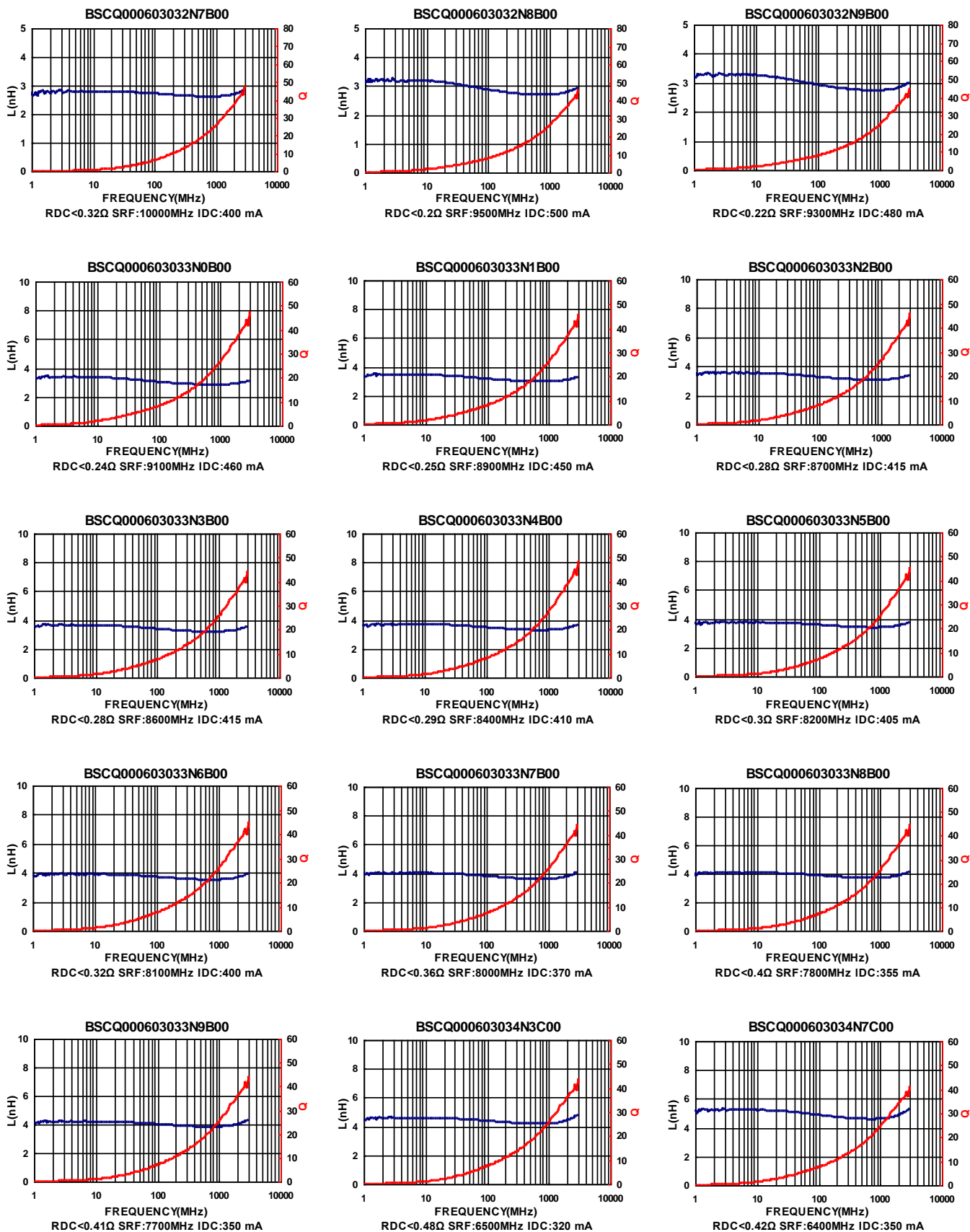

Please be sure to request approval specifications that provide further details of the products. Kindly note that the content of these specifications are subject to change or may be discontinued without prior notice. This product may not be designed/used in medical or high risk applications without Chilisin approval. Please contact our sales department before ordering.

SMD Multilayer Ceramic Chip Inductors – BSCQ Series

Test Instruments : Agilent E4991A Material/Impedance Analyzer

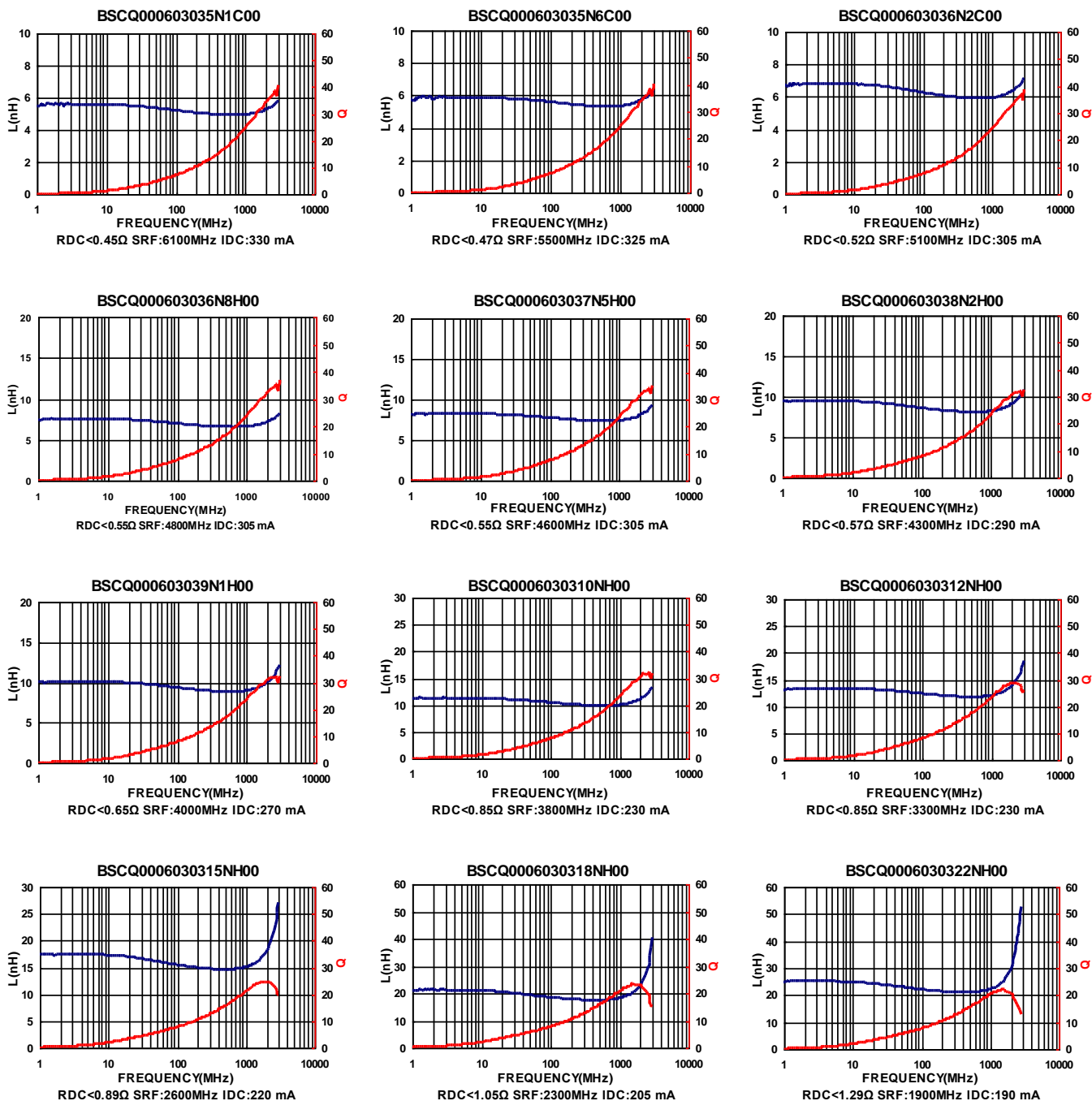

Please be sure to request approval specifications that provide further details of the products. Kindly note that the content of these specifications are subject to change or may be discontinued without prior notice. This product may not be designed/used in medical or high risk applications without Chilisin approval. Please contact our sales department before ordering.

SMD Ceramic Multilayer Chip Inductors – BSCQ Series

Electrical Characteristics

| Part Number | Inductance (nH) | Tolerance (±%) | Q Min | Test Frequency (MHz) | SRF (MHz) Min | RDC (Ω) Max | IDC (mA) Max |
|--------------------|-----------------|----------------------|-------|----------------------|---------------|-------------|--------------|
| BSCQ000603030N1□HR | 0.1 | ±0.1nH/±0.2nH/±0.3nH | 14 | 500 | 10000 | 0.06 | 900 |
| BSCQ000603030N2□HR | 0.2 | ±0.1nH/±0.2nH/±0.3nH | 14 | 500 | 10000 | 0.06 | 900 |
| BSCQ000603030N3□HR | 0.3 | ±0.1nH/±0.2nH/±0.3nH | 14 | 500 | 10000 | 0.06 | 900 |
| BSCQ000603030N4□HR | 0.4 | ±0.1nH/±0.2nH/±0.3nH | 14 | 500 | 10000 | 0.06 | 900 |
| BSCQ000603030N5□HR | 0.5 | ±0.1nH/±0.2nH/±0.3nH | 14 | 500 | 10000 | 0.07 | 850 |
| BSCQ000603030N6□HR | 0.6 | ±0.1nH/±0.2nH/±0.3nH | 14 | 500 | 10000 | 0.07 | 850 |
| BSCQ000603030N7□HR | 0.7 | ±0.1nH/±0.2nH/±0.3nH | 14 | 500 | 10000 | 0.08 | 800 |
| BSCQ000603030N8□HR | 0.8 | ±0.1nH/±0.2nH/±0.3nH | 14 | 500 | 10000 | 0.09 | 760 |
| BSCQ000603030N9□HR | 0.9 | ±0.1nH/±0.2nH/±0.3nH | 14 | 500 | 10000 | 0.12 | 640 |
| BSCQ000603031N0□HR | 1.0 | ±0.1nH/±0.2nH/±0.3nH | 14 | 500 | 10000 | 0.15 | 600 |
| BSCQ000603031N1□HR | 1.1 | ±0.1nH/±0.2nH/±0.3nH | 14 | 500 | 10000 | 0.19 | 510 |
| BSCQ000603031N2□HR | 1.2 | ±0.1nH/±0.2nH/±0.3nH | 14 | 500 | 10000 | 0.11 | 680 |
| BSCQ000603031N3□HR | 1.3 | ±0.1nH/±0.2nH/±0.3nH | 14 | 500 | 10000 | 0.12 | 640 |
| BSCQ000603031N4□HR | 1.4 | ±0.1nH/±0.2nH/±0.3nH | 14 | 500 | 10000 | 0.13 | 620 |
| BSCQ000603031N5□HR | 1.5 | ±0.1nH/±0.2nH/±0.3nH | 14 | 500 | 10000 | 0.15 | 600 |
| BSCQ000603031N6□HR | 1.6 | ±0.1nH/±0.2nH/±0.3nH | 14 | 500 | 10000 | 0.16 | 550 |
| BSCQ000603031N7□HR | 1.7 | ±0.1nH/±0.2nH/±0.3nH | 14 | 500 | 10000 | 0.20 | 500 |
| BSCQ000603031N8□HR | 1.8 | ±0.1nH/±0.2nH/±0.3nH | 14 | 500 | 10000 | 0.24 | 460 |
| BSCQ000603031N9□HR | 1.9 | ±0.1nH/±0.2nH/±0.3nH | 14 | 500 | 10000 | 0.26 | 430 |
| BSCQ000603032N0□HR | 2.0 | ±0.1nH/±0.2nH/±0.3nH | 14 | 500 | 10000 | 0.28 | 415 |
| BSCQ000603032N1□HR | 2.1 | ±0.1nH/±0.2nH/±0.3nH | 14 | 500 | 10000 | 0.30 | 405 |
| BSCQ000603032N2□HR | 2.2 | ±0.1nH/±0.2nH/±0.3nH | 14 | 500 | 10000 | 0.32 | 400 |
| BSCQ000603032N3□HR | 2.3 | ±0.1nH/±0.2nH/±0.3nH | 14 | 500 | 9500 | 0.20 | 500 |
| BSCQ000603032N4□HR | 2.4 | ±0.1nH/±0.2nH/±0.3nH | 14 | 500 | 9300 | 0.22 | 480 |
| BSCQ000603032N5□HR | 2.5 | ±0.1nH/±0.2nH/±0.3nH | 14 | 500 | 9100 | 0.24 | 460 |
| BSCQ000603032N6□HR | 2.6 | ±0.1nH/±0.2nH/±0.3nH | 14 | 500 | 8900 | 0.25 | 450 |
| BSCQ000603032N7□HR | 2.7 | ±0.1nH/±0.2nH/±0.3nH | 14 | 500 | 8700 | 0.28 | 415 |
| BSCQ000603032N8□HR | 2.8 | ±0.1nH/±0.2nH/±0.3nH | 14 | 500 | 8600 | 0.28 | 415 |
| BSCQ000603032N9□HR | 2.9 | ±0.1nH/±0.2nH/±0.3nH | 14 | 500 | 8400 | 0.29 | 410 |
| BSCQ000603033N0□HR | 3.0 | ±0.1nH/±0.2nH/±0.3nH | 14 | 500 | 8200 | 0.30 | 405 |
| BSCQ000603033N1□HR | 3.1 | ±0.1nH/±0.2nH/±0.3nH | 14 | 500 | 8100 | 0.32 | 400 |
| BSCQ000603033N2□HR | 3.2 | ±0.1nH/±0.2nH/±0.3nH | 14 | 500 | 8000 | 0.36 | 370 |

Note: When ordering, please specify tolerance code. Tolerance : B=±0.1nH , C=±0.2nH , S=±0.3nH , H=±3% , J=±5%

- Operating temperature range - 55°C ~ 125°C(Including self - temperature rise)
- IDC : Applied the current to coils, the inductance shall be less than 10% initial value
- Residual impedance of short chip : 0nH
- Measure Equipment :
 L & Q : Agilent E4991A+Agilent 16197A
 SRF : Agilent E4991A or HP19196C
 RDC : HP4338B or CHEN HWA 502

SMD Ceramic Multilayer Chip Inductors – BSCQ Series

Electrical Characteristics

| Part Number | Inductance (nH) | Tolerance (±%) | Q Min | Test Frequency (MHz) | SRF (MHz) Min | RDC (Ω) Max | IDC (mA) Max |
|--------------------|-----------------|----------------------|-------|----------------------|---------------|-------------|--------------|
| BSCQ000603033N3□HR | 3.3 | ±0.1nH/±0.2nH/±0.3nH | 14 | 500 | 7800 | 0.40 | 355 |
| BSCQ000603033N4□HR | 3.4 | ±0.1nH/±0.2nH/±0.3nH | 14 | 500 | 7700 | 0.41 | 350 |
| BSCQ000603033N5□HR | 3.5 | ±0.1nH/±0.2nH/±0.3nH | 14 | 500 | 7700 | 0.41 | 350 |
| BSCQ000603033N6□HR | 3.6 | ±0.1nH/±0.2nH/±0.3nH | 14 | 500 | 6500 | 0.48 | 320 |
| BSCQ000603033N7□HR | 3.7 | ±0.1nH/±0.2nH/±0.3nH | 14 | 500 | 6500 | 0.48 | 320 |
| BSCQ000603033N8□HR | 3.8 | ±0.1nH/±0.2nH/±0.3nH | 14 | 500 | 6500 | 0.48 | 320 |
| BSCQ000603033N9□HR | 3.9 | ±0.1nH/±0.2nH/±0.3nH | 14 | 500 | 6500 | 0.48 | 320 |
| BSCQ000603034N3□HR | 4.3 | ±0.2nH/±0.3nH | 14 | 500 | 6400 | 0.42 | 350 |
| BSCQ000603034N7□HR | 4.7 | ±0.2nH/±0.3nH | 14 | 500 | 6100 | 0.45 | 330 |
| BSCQ000603035N1□HR | 5.1 | ±0.2nH/±0.3nH | 14 | 500 | 5500 | 0.47 | 325 |
| BSCQ000603035N6□HR | 5.6 | ±0.2nH/±0.3nH | 14 | 500 | 5100 | 0.52 | 305 |
| BSCQ000603036N2□HR | 6.2 | ±0.2nH/±0.3nH | 14 | 500 | 4800 | 0.55 | 305 |
| BSCQ000603036N8□HR | 6.8 | 3 / 5 | 14 | 500 | 4600 | 0.55 | 305 |
| BSCQ000603037N5□HR | 7.5 | 3 / 5 | 14 | 500 | 4300 | 0.57 | 290 |
| BSCQ000603038N2□HR | 8.2 | 3 / 5 | 14 | 500 | 4000 | 0.65 | 270 |
| BSCQ000603039N1□HR | 9.1 | 3 / 5 | 14 | 500 | 3800 | 0.85 | 230 |
| BSCQ0006030310N□HR | 10 | 3 / 5 | 14 | 500 | 3800 | 0.85 | 230 |
| BSCQ0006030312N□HR | 12 | 3 / 5 | 12 | 500 | 3300 | 0.85 | 230 |
| BSCQ0006030315N□HR | 15 | 3 / 5 | 12 | 500 | 2600 | 0.89 | 220 |
| BSCQ0006030318N□HR | 18 | 3 / 5 | 12 | 500 | 2300 | 1.05 | 205 |
| BSCQ0006030322N□HR | 22 | 3 / 5 | 12 | 500 | 1900 | 1.29 | 190 |

Note: When ordering, please specify tolerance code. Tolerance : B=±0.1nH , C=±0.2nH , S=±0.3nH , H=±3% , J=±5%

- Operating temperature range - 55°C ~ 125°C(Including self - temperature rise)
- IDC : Applied the current to coils, the inductance shall be less than 10% initial value
- Residual impedance of short chip : 0nH
- Measure Equipment :
 L & Q : Agilent E4991A+Agilent 16197A
 SRF : Agilent E4991A or HP19196C
 RDC : HP4338B or CHEN HWA 502

Test Instruments : Agilent E4991A Material/Impedance Analyzer

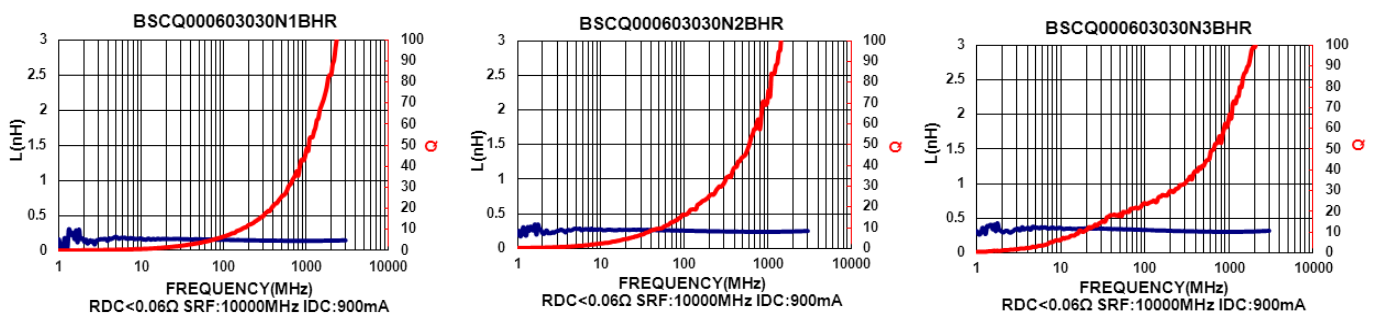

Please be sure to request approval specifications that provide further details of the products. Kindly note that the content of these specifications are subject to change or may be discontinued without prior notice. This product may not be designed/used in medical or high risk applications without Chilisin approval. Please contact our sales department before ordering.

SMD Ceramic Multilayer Chip Inductors – BSCQ Series

Test Instruments : Agilent E4991A Material/Impedance Analyzer

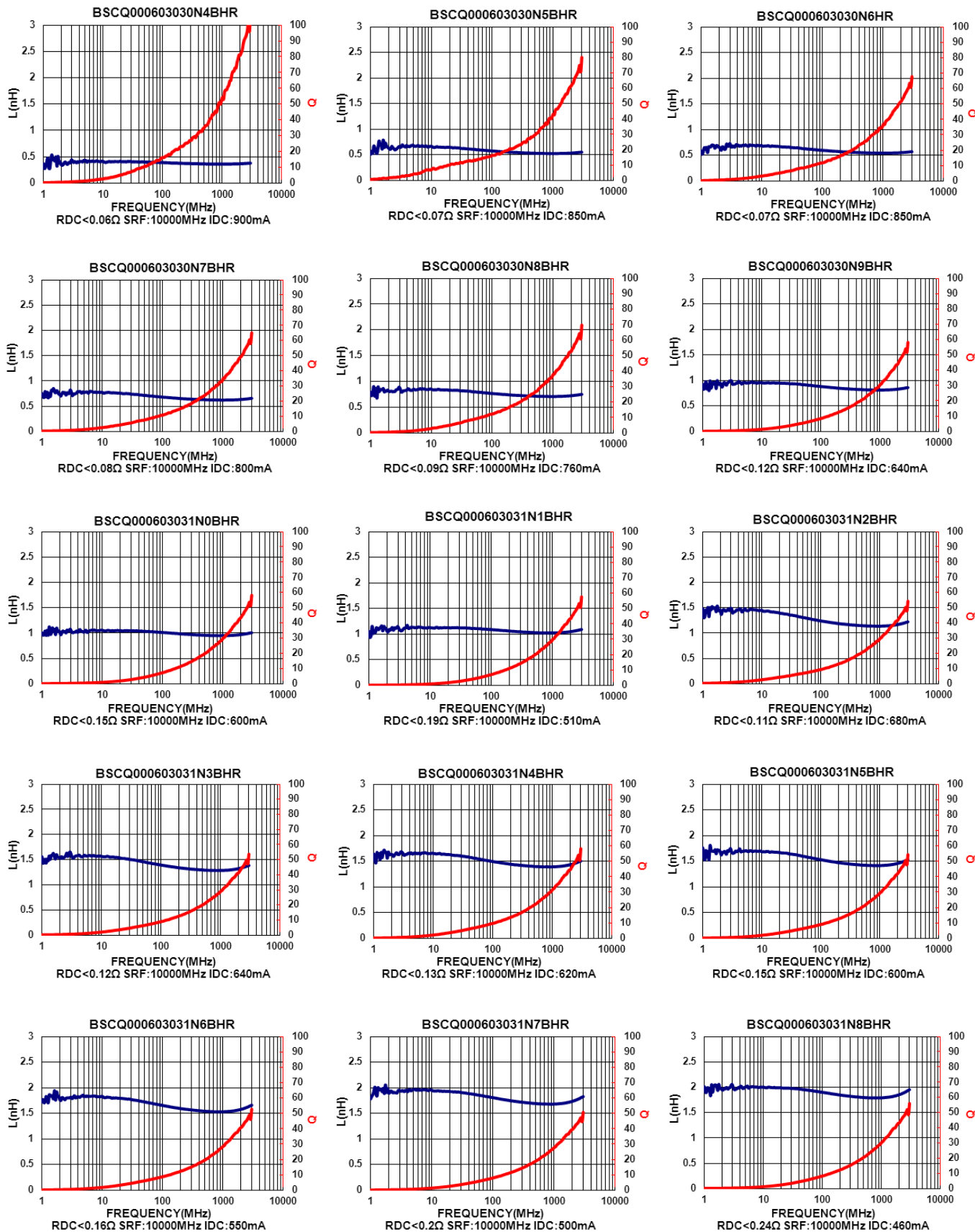

Please be sure to request approval specifications that provide further details of the products. Kindly note that the content of these specifications are subject to change or may be discontinued without prior notice. This product may not be designed/used in medical or high risk applications without Chilisin approval. Please contact our sales department before ordering.

SMD Ceramic Multilayer Chip Inductors – BSCQ Series

Test Instruments : Agilent E4991A Material/Impedance Analyzer

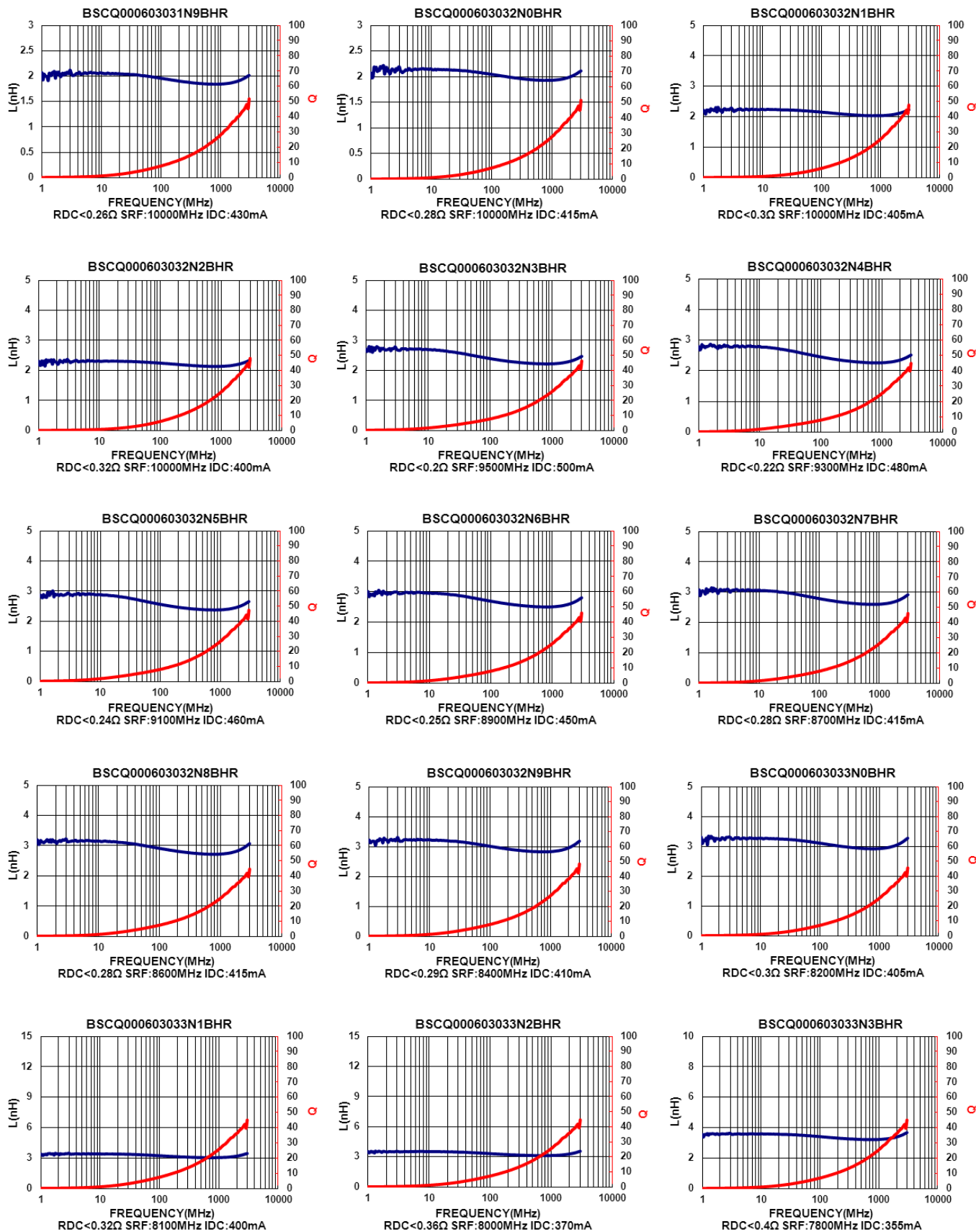

Please be sure to request approval specifications that provide further details of the products. Kindly note that the content of these specifications are subject to change or may be discontinued without prior notice. This product may not be designed/used in medical or high risk applications without Chilisin approval. Please contact our sales department before ordering.

SMD Multilayer Ceramic Chip Inductors – BSCQ Series

Test Instruments : Agilent E4991A Material/Impedance Analyzer

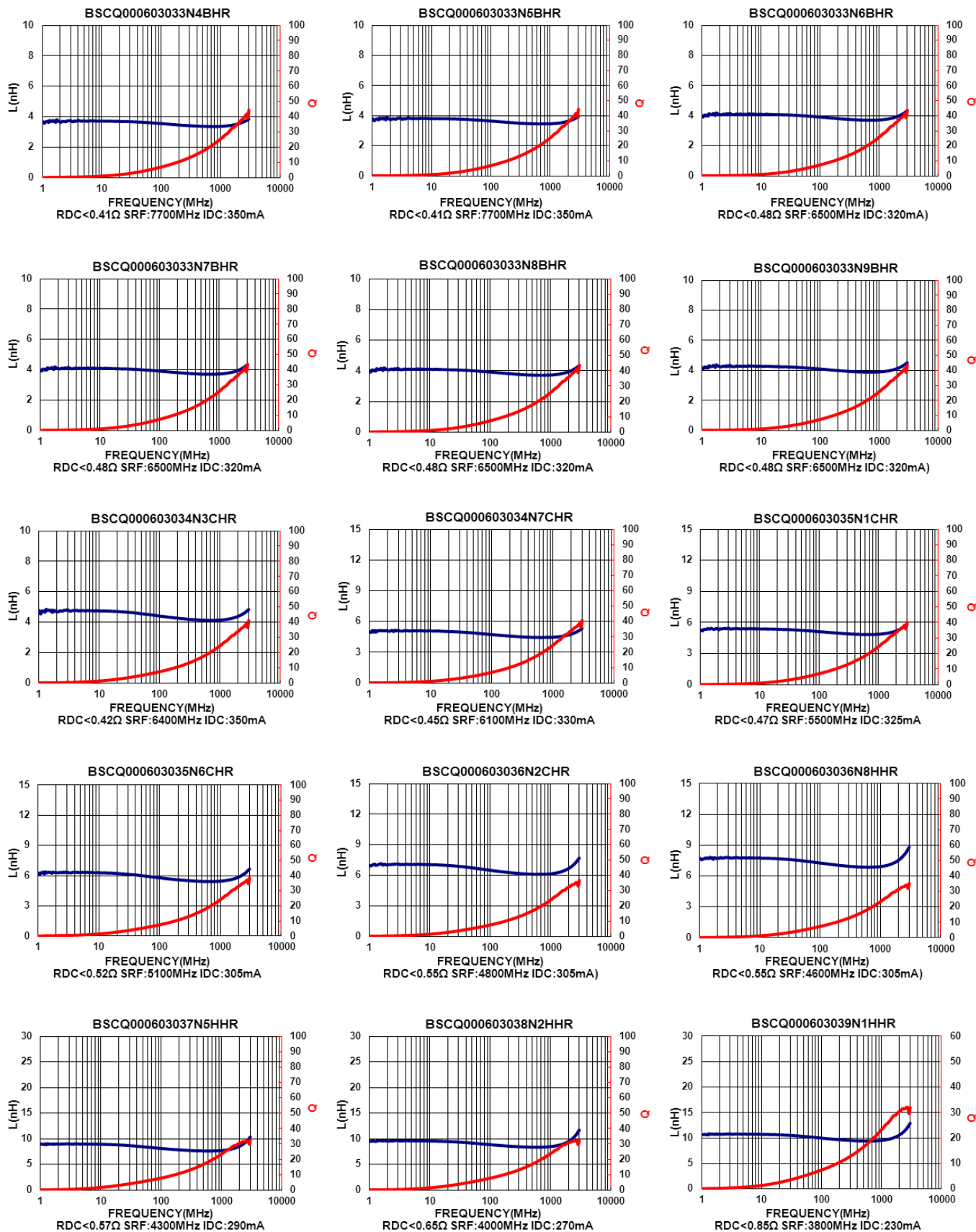

Please be sure to request approval specifications that provide further details of the products. Kindly note that the content of these specifications are subject to change or may be discontinued without prior notice. This product may not be designed/used in medical or high risk applications without Chilisin approval. Please contact our sales department before ordering.

SMD Multilayer Ceramic Chip Inductors – BSCQ Series

Test Instruments : Agilent E4991A Material/Impedance Analyzer

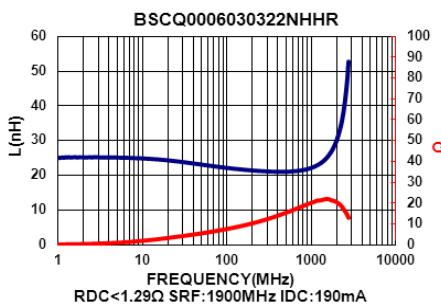
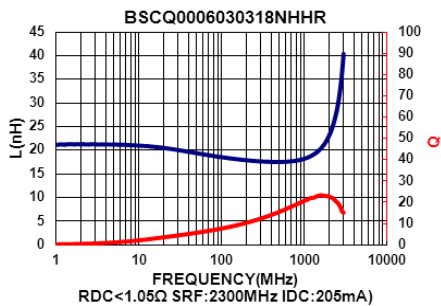
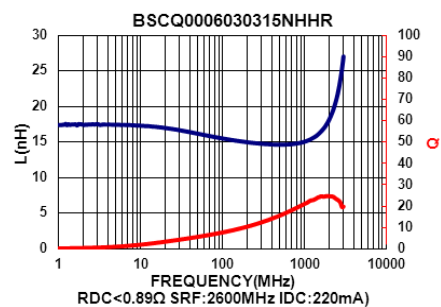
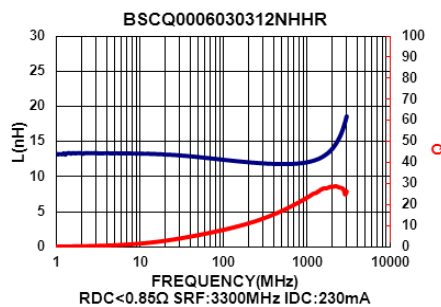
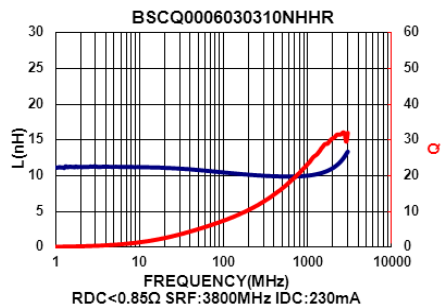

Please be sure to request approval specifications that provide further details of the products. Kindly note that the content of these specifications are subject to change or may be discontinued without prior notice. This product may not be designed/used in medical or high risk applications without Chilisin approval. Please contact our sales department before ordering.

Packaging Specifications

Tape Dimensions

Figure A

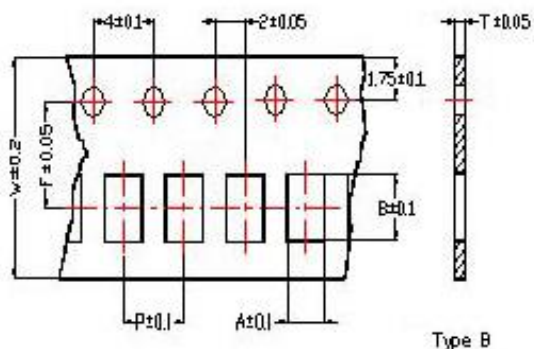

Tape Material

Figure A

Carrier Tape: Polycarbonate (Tape A)
Carrier Tape: Paper (Tape B)
Cover Tape: Polystyrene

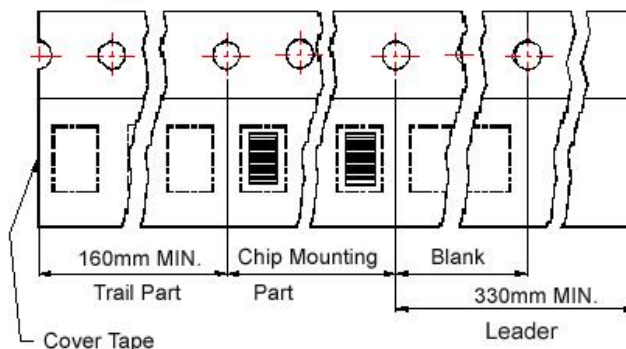
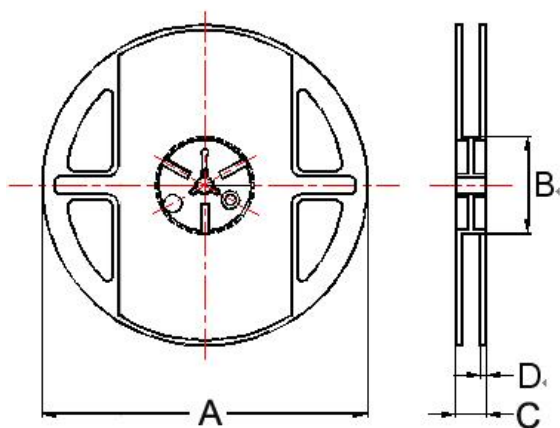
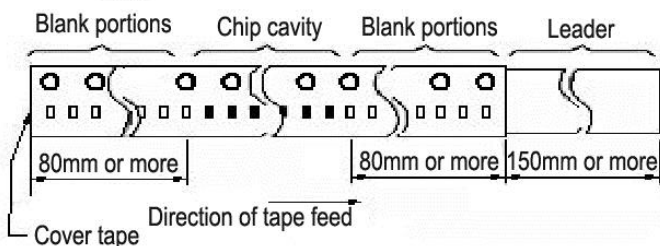

Figure B

Carrier tape : Paper
Cover tape : Polyethylene



Dimensions in mm

| TYPE | Tape Dimensions | | | | | | Tape | Tape Material | Reel Dimensions | | | | Quantity PCS / Reel |
|--------------|-----------------|------|------|---|---|-----|------|---------------|-----------------|----|----|-----|---------------------|
| | A | B | T | W | P | F | | | A | B | C | D | |
| BSCQ00060303 | 0.37 | 0.67 | 0.42 | 8 | 2 | 3.5 | A | B | 180 | 60 | 13 | 1.5 | 15000 |

X-ON Electronics

Largest Supplier of Electrical and Electronic Components

Click to view similar products for [Fixed Inductors](#) category:

Click to view products by [Chilisin](#) manufacturer:

Other Similar products are found below :

[CR43NP-680KC](#) [CR54NP-470LC](#) [CR54NP-820KC](#) [CR54NP-8R5MC](#) [70F224AI](#) [MGDQ4-00004-P](#) [MHL1ECTTP18NJ](#) [MHQ1005P10NJ](#)
[MHQ1005P1N0S](#) [MHQ1005P2N4S](#) [MHQ1005P3N6S](#) [MHQ1005P5N1S](#) [MHQ1005P8N2J](#) [PE-51506NL](#) [PE-53601NL](#) [PE-53602NL](#) [PE-](#)
[53630NL](#) [PE-53824SNLT](#) [PE-92100NL](#) [PG0434.801NLT](#) [PG0936.113NLT](#) [9220-20](#) [9310-16](#) [PM06-2N7](#) [PM06-39NJ](#) [A01TK](#) [1206CS-](#)
[471XJ](#) [HC2LP-R47-R](#) [HC2-R47-R](#) [HC3-2R2-R](#) [HC3-R50-R](#) [HC8-1R2-R](#) [HCF1305-3R3-R](#) [1206CS-151XG](#) [RCH664NP-140L](#) [RCH664NP-](#)
[4R7M](#) [RCH8011NP-221L](#) [RCP1317NP-332L](#) [RCP1317NP-391L](#) [RCR1010NP-470M](#) [RCR110DNP-331L](#) [DH2280-4R7M](#) [DS1608C-106](#)
[ASPI-4020HI-R10M-T](#) [B10TJ](#) [B82498B3680J000](#) [ELJ-RE27NJF2](#) [1812CS-153XJ](#) [1812CS-183XJ](#) [1812CS-223XJ](#)