

BTLB Series



Chilisin offer multilayer devices of Low-Temperature Cofired Ceramics (LTCC) for applications in wireless communication as WLAN, Bluetooth etc. Our commitment is to meet your goals through extensive technological innovation, excellent quality, short lead time and high volume production capability.

Features

- RoHS, Halogen Free and REACH Compliance
- Miniaturized.
- Low insertion loss, high attenuation.
- Eliminate noise over a wide frequency range. Idea for high frequency and space limited designs.

Applications

- WLAN ,Home RF, Bluetooth Module, WiMAX Modules, etc.

Product Identification

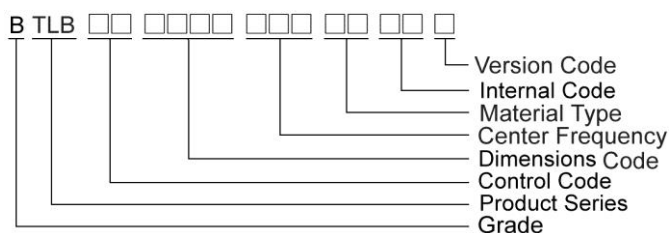

Shapes and Dimensions

FIG 1

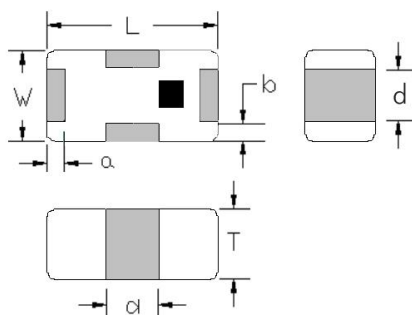

Terminal Configuration

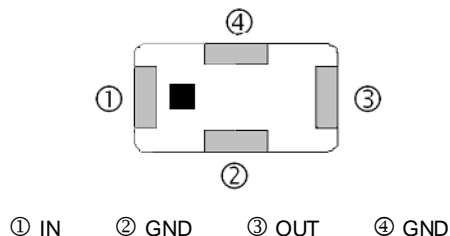
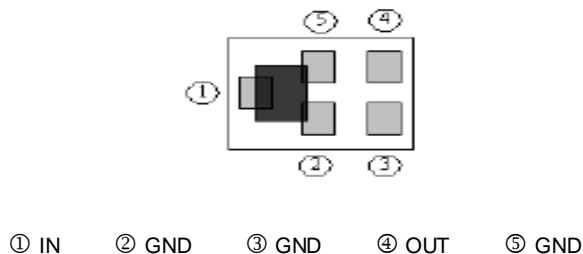
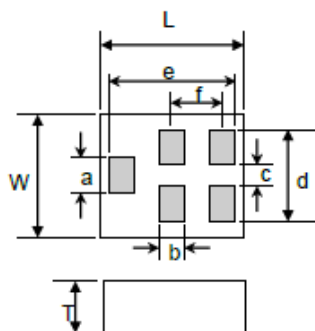

FIG 2



Dimension in mm

TYPE	FIG	L	W	T	a	b	c	d		
BTLB0010052G4H6A40	1	1.0±0.1	0.5±0.1	0.4±0.1	0.1±0.05	0.1±0.05	0.3±0.1	0.3±0.1		
BTLB0010052G4H6B60	1	1.0±0.1	0.5±0.1	0.4±0.1	0.1±0.05	0.1±0.05	0.3±0.1	0.3±0.1		
TYPE	FIG	L	W	T	a	b	c	d	e	f
BTLB0014112G4H6A30	2	1.4±0.1	1.2±0.1	0.5±0.05	0.325±0.05	0.25±0.05	0.25±0.05	0.9±0.1	1.25±0.1	0.5±0.05

Shapes and Dimensions

Terminal Configuration

FIG 3

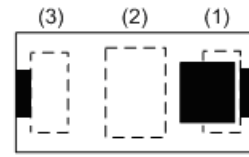
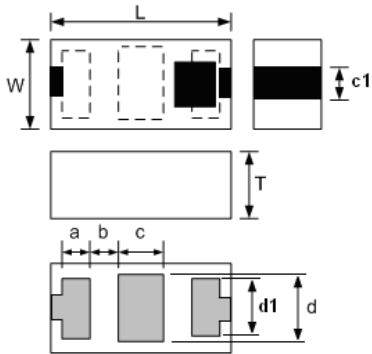

① IN ② GND ③ OUT

FIG 4

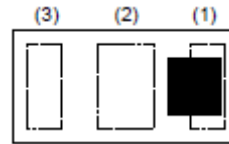
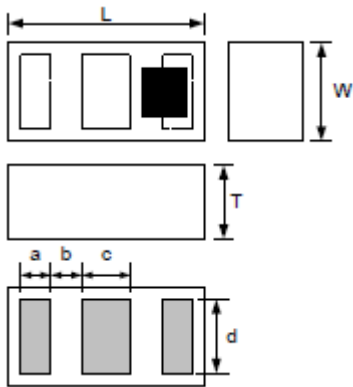

① IN ② GND ③ OUT

FIG 5

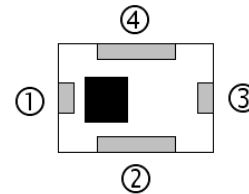
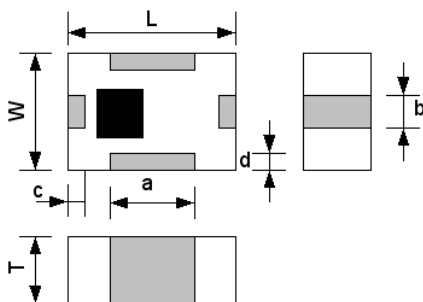

① IN ② GND ③ OUT ④ GND

FIG 6

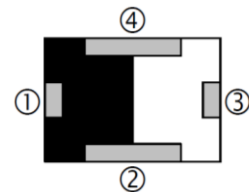
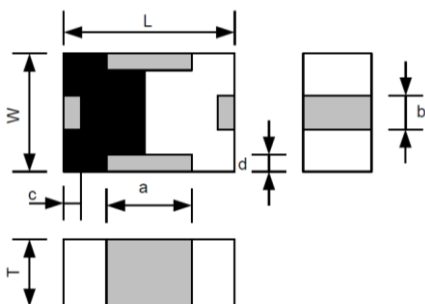

① IN ② GND ③ OUT ④ GND

Shapes and Dimensions

Terminal Configuration

FIG 7

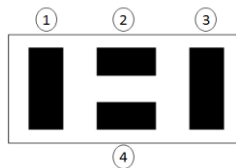
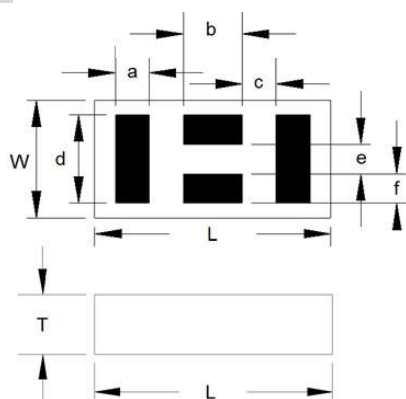

- 7.1 ① I/O ② GND ③ I/O ④ GND
- 7.2 ① IN ② GND ③ OUT ④ GND

FIG 8

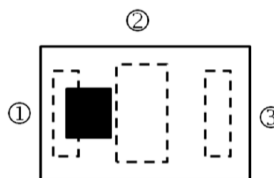
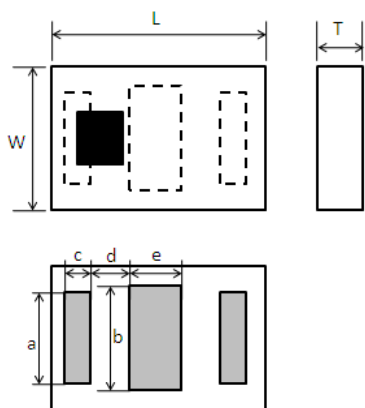

- 8.1 ① IN ② GND ③ OUT
- 8.2 ① I/O ② GND ③ I/O

FIG 9

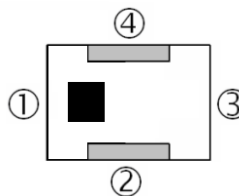
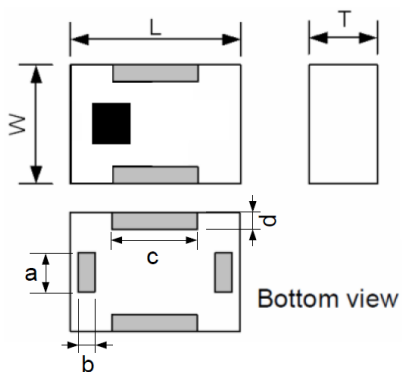

- ① IN ② GND ③ OUT ④ GND

Low Temperature Cofired Ceramic - BTLB Series

Dimension in mm

TYPE	FIG	L	W	T	a	b	c	c1	d	d1
BTLB0016082G4H6BU0	3	1.6±0.1	0.8±0.1	0.6±0.05	0.25±0.1	0.23±0.1	0.4±0.1	0.3±0.15	0.6±0.1	0.55±0.
TYPE	FIG	L	W	T	a	b	c	d	e	f
BTLB0016082G4H6DN0	4	1.6±0.1	0.8±0.1	0.6±0.1	0.25±0.1	0.25±0.1	0.5±0.1	0.6±0.1	-	-
BTLB0016082G4H6DQ0	5	1.6±0.1	0.8±0.1	0.6±0.1	0.7±0.15	0.3 ^{+0.1} _{-0.15}	0.15±0.1	0.15±0.1	-	-
BTLB0016082G4H6H10	5	1.6±0.1	0.8±0.1	0.6±0.1	0.7±0.15	0.3 ^{+0.1} _{-0.15}	0.15±0.1	0.15±0.1	-	-
BTLB0016082G4S1A10	6	1.6±0.1	0.8±0.1	0.6±0.1	0.7±0.15	0.3 ^{+0.1} _{-0.15}	0.15±0.1	0.15±0.1	-	-
BTLB001608HXVHBA10	7.1	1.6±0.1	0.8±0.1	0.7±0.05	0.23±0.5	0.4±0.1	0.23±0.1	0.6±0.1	0.2±0.05	0.2±0.0
BTLB001608HXVHBA20	7.2	1.6±0.15	0.8±0.15	0.7±0.05	0.25±0.5	0.4±0.1	0.23±0.1	0.55±0.1	0.21±0.05	0.2±0.0
BTLB0016083G6H6C10	6	1.6±0.1	0.8±0.1	0.6±0.1	0.7±0.15	0.3 ^{+0.1} _{-0.15}	0.15±0.1	0.15±0.1	-	-
BTLB0016085G5H6A00	5	1.6±0.1	0.8±0.1	0.6±0.1	0.7±0.15	0.3 ^{+0.1} _{-0.15}	0.15±0.1	0.15±0.1	-	-
BTLB0016085G5H6A80	8	1.6±0.1	0.8±0.1	0.6±0.1	0.55±0.1	0.6±0.1	0.25±0.1	0.23±0.1	0.4±0.1	
BTLB0016085G5H6A90	8	1.6±0.1	0.8±0.1	0.6Max	0.55±0.1	0.6±0.1	0.25±0.1	0.23±0.1	0.4±0.1	
BTLB0016085G5H6F90	8	1.6±0.1	0.8±0.1	0.6±0.1	0.55±0.1	0.6±0.1	0.25±0.1	0.23±0.1	0.4±0.1	
BTLB001608LXVKBA10	8	1.6±0.15	0.8±0.15	0.6±0.1	0.55±0.1	0.6±0.1	0.25±0.1	0.23±0.05	0.4±0.1	-
BTLB001608LXVKBA20	8	1.6±0.1	0.8±0.1	0.65Max	0.55±0.1	0.6±0.1	0.25±0.1	0.23±0.1	0.4±0.1	-
BTLB001608LXVKBB20	8	1.6±0.1	0.8±0.1	0.65Max	0.55±0.1	0.6±0.1	0.25±0.1	0.23±0.1	0.4±0.1	-
BTLB001608LXVKBA30	4	1.6±0.15	0.8±0.1	0.65Max	0.25±0.1	0.23±0.1	0.4±0.1	0.55±0.1	-	-
BTLB0016085G5S1B10	9	1.6±0.1	0.8±0.1	0.6±0.1	0.3±0.1	0.15±0.05	0.7±0.15	0.15±0.1	-	-
BTLB001608OXVHBA10	8.2	1.6±0.1	0.8±0.1	0.35Max	0.55±0.05	0.6±0.05	0.25±0.05	0.23±0.05	0.4±0.05	-
BTLB001608NXVHBA10	8.2	1.6±0.1	0.8±0.1	0.35Max	0.55±0.05	0.6±0.05	0.25±0.05	0.23±0.05	0.4±0.05	-

Shapes and Dimensions

Terminal Configuration

FIG 10

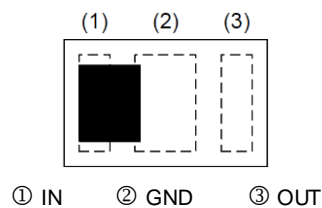
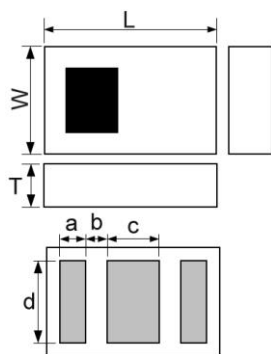

FIG 11

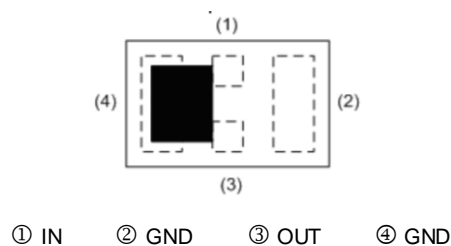
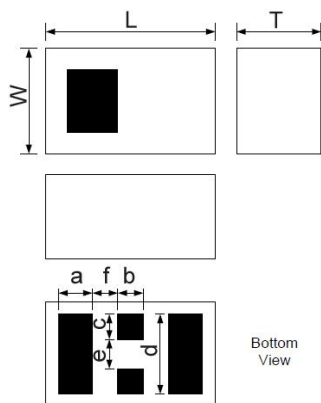

FIG 5

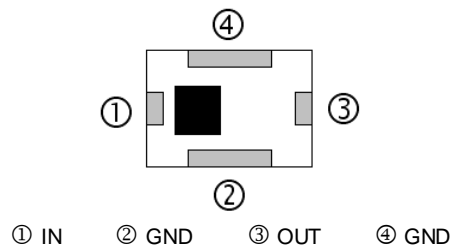
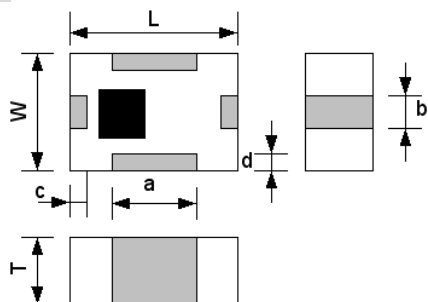

FIG 12

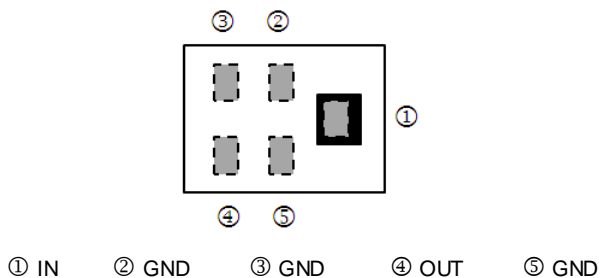
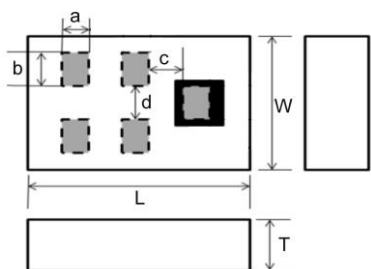
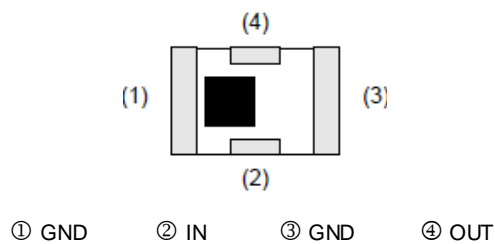
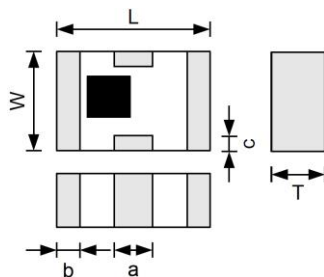

FIG 13



Low Temperature Cofired Ceramic - BTLB Series

Dimension in mm

TYPE	FIG	L	W	T	a1	a2	a3	e1		
BTLB0020122G4H6A00	10	2±0.15	1.25±0.1	0.45±0.05	0.275±0.1	0.6±0.1	0.95±0.1	0.25±0.05		
BTLB0020122G4H6BD0	10	2±0.15	1.25±0.1	0.8±0.05	0.275±0.1	0.6±0.1	0.95±0.1	0.25±0.05		
BTLB0020122G4H6C00	10	2±0.15	1.25±0.1	0.45±0.05	0.275±0.1	0.6±0.1	0.95±0.1	0.25±0.05		
TYPE	FIG	L	W	T	a	b	c	d	e	f
BTLB0020122G4H6A80	11	2±0.15	1.25±0.1	0.9±0.1	0.4	0.3	0.3	0.95	0.35	0.3
BTLB0020122G4H6A90	5	2±0.15	1.25±0.15	0.95±0.1	1.6 ^{+0.1} _{-0.15}	0.3 ^{+0.1} _{-0.15}	0.3±0.2	0.3±0.2	-	-
BTLB0020122G4H6AH0	5	2±0.15	1.25±0.15	0.95±0.1	1.6 ^{+0.1} _{-0.15}	0.3 ^{+0.1} _{-0.15}	0.3±0.2	0.3±0.2	-	-
BTLB0020122G4H6AS0	12	2±0.15	1.25±0.1	1.0Max	0.175±0.1	0.275±0.1	0.25±0.05	0.25±0.05	-	-
BTLB0020122G4H6AR0	12	2±0.2	1.25±0.2	0.6Max	0.25±0.05	0.325±0.05	0.25±0.05	0.25±0.05	-	-
BTLB0020122G4H6B50	13	2±0.15	1.25±0.1	0.55±0.1	0.4±0.2	0.3±0.2	0.3±0.2	-	-	-
BTLB0020122G4H6B90	5	2±0.15	1.25±0.15	0.95±0.1	1.6 ^{+0.1} _{-0.15}	0.3 ^{+0.1} _{-0.15}	0.3±0.2	0.3±0.2	-	-
BTLB0020122G4H6D30	5	2±0.15	1.25±0.15	0.95±0.1	1.6 ^{+0.1} _{-0.15}	0.3 ^{+0.1} _{-0.15}	0.3±0.2	0.3±0.2	-	-
BTLB0020122G4S1A10	5	2±0.15	1.25±0.15	0.95±0.1	1.6 ^{+0.1} _{-0.15}	0.3 ^{+0.1} _{-0.15}	0.3±0.2	0.3±0.2	-	-
BTLB0020125G5H6A80	5	2±0.15	1.25±0.15	0.95±0.1	1.6 ^{+0.1} _{-0.15}	0.3 ^{+0.1} _{-0.15}	0.3±0.2	0.3±0.2	-	-
BTLB0020125G5H6B30	5	2±0.15	1.25±0.15	0.95±0.1	1.6 ^{+0.1} _{-0.15}	0.3 ^{+0.1} _{-0.15}	0.3±0.2	0.3±0.2	-	-
BTLB0020125G5H6C50	5	2±0.15	1.25±0.15	0.95±0.1	1.6 ^{+0.1} _{-0.15}	0.3 ^{+0.1} _{-0.15}	0.3±0.2	0.3±0.2	-	-
BTLB0020125G5H6C80	5	2±0.15	1.25±0.15	0.95±0.1	1.6 ^{+0.1} _{-0.15}	0.3 ^{+0.1} _{-0.15}	0.3±0.2	0.3±0.2	-	-
BTLB0020125G5H6D10	5	2±0.15	1.25±0.15	0.95±0.1	1.6 ^{+0.1} _{-0.15}	0.3 ^{+0.1} _{-0.15}	0.3 ^{+0.1} _{-0.15}	0.3±0.2	-	-
BTLB0020125G5H6D80	5	2±0.15	1.25±0.15	0.95±0.1	1.6 ^{+0.1} _{-0.15}	0.3 ^{+0.1} _{-0.15}	0.3±0.2	0.3±0.2	-	-
BTLB0020125G5H6E80	5	2±0.15	1.25±0.15	0.95±0.1	1.6 ^{+0.1} _{-0.15}	0.3 ^{+0.1} _{-0.15}	0.3±0.2	0.3±0.2	-	-

Electrical Characteristics

Part Number	Pass Band (MHz)	Insertion Loss (dB)Max	Return Loss (dB)Min	Attenuation	Application
BTLB0010052G4H6A40	2400~2500	1.5	9	13dB Min.@ 824~915 MHz 5dB Min.@ 15451605 MHz 3.5dB Min.@ 1710~1785 MHz 2dB Min.@ 1850~1910 MHz 1.5dB Min.@ 1920~1980 MHz 0.5dB Min.@ 2110~2170 MHz 34dB Min.@ 4800~5000 MHz 27dB Min.@ 7200~7500 MHz	WLAN/BT
BTLB0010052G4H6B60	2400~2500	2.5	10	25dB Min.@ 824~960 MHz 20dB Min.@ 1710~1910 MHz 30dB Min.@ 4800~5000 MHz 18dB Min.@ 7200~7500 MHz	WLAN/BT

- Operating temperature range -40°C ~85°C

Test Instruments : Agilent E5071C Network Analyzer

BTLB0010052G4H6A40

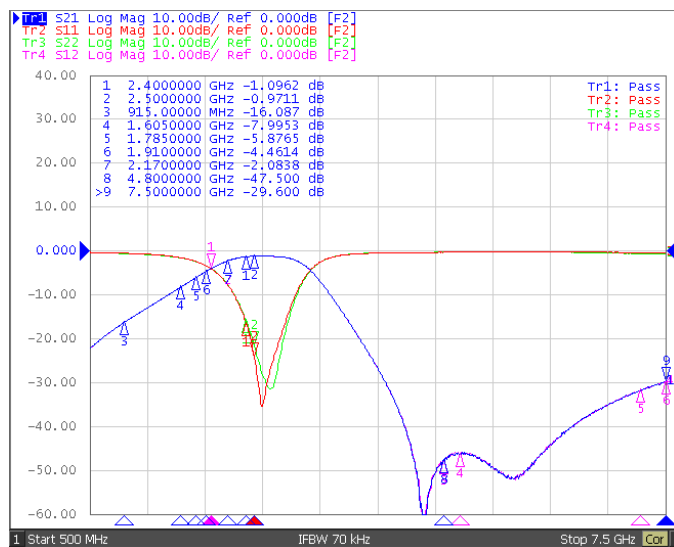

BTLB0010052G4 H6B60

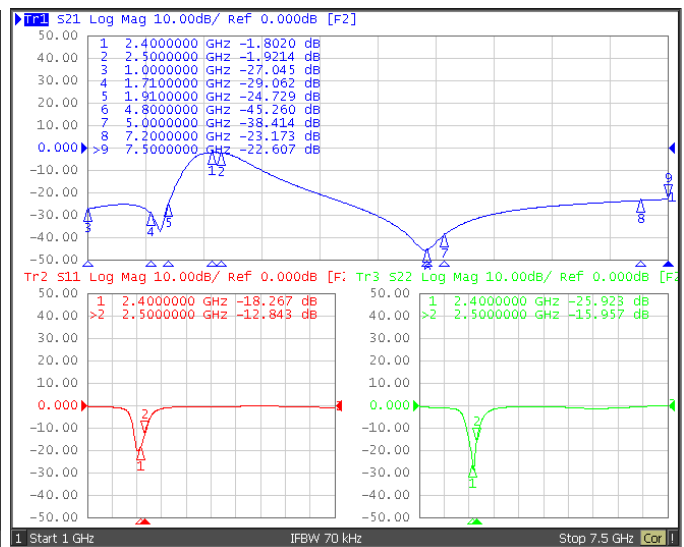

Please be sure to request approval specifications that provide further details of the products. Kindly note that the content of these specifications are subject to change or may be discontinued without prior notice. This product may not be designed/used in medical or high risk applications without Chilisin approval. Please contact our sales department before ordering.

Low Temperature Cofired Ceramic - BTLB Series

Electrical Characteristics

Part Number	Pass Band (MHz)	Insertion Loss (dB)Max	Return Loss (dB)Min	Attenuation	Application
BTLB0014112G4H6A30	2400~2500	1.1	14	20dB Min. @ 50~960 MHz 10dB Min. @ 1710~1990 MHz 15dB Min. @ 3600 MHz 25dB Min. @ 4800~7200 MHz	WLAN/BT

- Operating temperature range $-40^{\circ}\text{C} \sim 85^{\circ}\text{C}$

Test Instruments : Agilent E5071C Network Analyzer

BTLB0014112G4H6A30

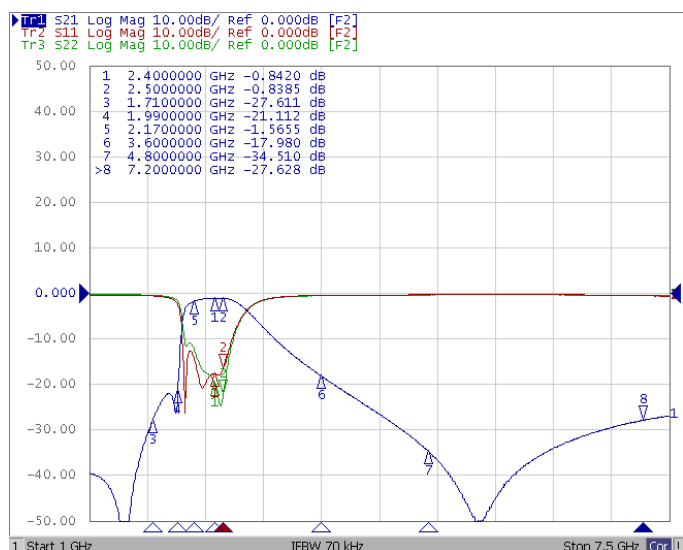

Low Temperature Cofired Ceramic - BTLB Series

Electrical Characteristics

Part Number	Pass Band (MHz)	Insertion Loss (dB)Max	Return Loss (dB)Min	Ripple (dB)Max	Attenuation	Application
BTLB0016082G4H6BU0	2400~2500	25°C 0.95 -40~85°C 1.35	10	0.5	20dB Min. @ 500~960 MHz 23dB Min. @ 3200 MHz 30dB Min. @ 4800~5000 MHz 32dB Min. @ 7200~7500 MHz	WLAN/BT
BTLB0016082G4H6DN0	2400~2500	1.3	10	-	25dB Min. @ 500~960 MHz 18dB Min. @ 3200 MHz 30dB Min. @ 4800~5000 MHz 23dB Min. @ 7200~7500 MHz	WLAN/BT
BTLB0016082G4H6DQ0	2400~2500	1.5	10.03	-	30dB Min. @ 800~960 MHz 34dB Min. @ 4800~5000 MHz 34dB Min. @ 7200~7500 MHz	WLAN/BT
BTLB0016082G4H6H10	2400~2500	1.8	10	-	35dB Min. @ 860~910 MHz 20dB Min. @ 1710~1910 MHz 25dB Min. @ 4800~5000 MHz 34dB Min. @ 7200~7500 MHz	WLAN/BT
BTLB0016082G4S1A10	2400~2500	3	10	-	25dB Min. @ 695~800 MHz 20dB Min. @ 1710~1910 MHz 35dB Min. @ 3200 MHz 20dB Min. @ 4800~5000 MHz	WLAN/BT
BTLB001608HXVHBA10	1880~2025	1.9(1.8Typ)	10(21.2Typ)	-	20dB Min./28.5dB Typ. @ 1545~1610 MHz 25dB Min./27.6dB Typ. @ 2400~2500 MHz 25B Min./32.6dB Typ. @ 5150~5850 MHz	GSM WCDMA LTE
BTLB001608HXVHBA20	1805~2025	2.1	10	-	30dB Min. @ 700~950 MHz 15dB Min. @ 950~1050 MHz 35dB Min. @ 2400~2500 MHz 35dB Min. @ 2700~5150 MHz 35dB Min. @ 5150~5850 MHz 32dB Min. @ 5850~12750 MHz	GSM WCDMA LTE
BTLB0016083G6H6C10	3300~3900	2	10	-	30dB Min. @ 806~915 MHz 30dB Min. @ 1710~1980 MHz 25dB Min. @ 2400~2500 MHz 7dB Min. @ 4900~5900 MHz	WiMAX
BTLB0016085G5H6A00	4900~5840	25°C 1.5 -40~8°C 1.7	10	-	33dB Min. @ 100~2170 MHz 29dB Min. @ 2170~2500 MHz 32dB Min. @ 9800~12000 MHz	WLAN
BTLB0016085G5H6A80	4900~5950	1.3	11	-	38dB Min. @ 30~2700 MHz 16dB Min. @ 3453~3547 MHz 33dB Min. @ 3667~3883 MHz 9dB Min. @ 6900~7093 MHz 32dB Min. @ 7333~7750 MHz 40dB Min. @ 10600~11650 MHz 18dB Min. @ 15540~17760 MHz	WLAN

- Operating temperature range -40°C ~85°C

Please be sure to request approval specifications that provide further details of the products. Kindly note that the content of these specifications are subject to change or may be discontinued without prior notice. This product may not be designed/used in medical or high risk applications without Chilisin approval. Please contact our sales department before ordering.

Low Temperature Cofired Ceramic - BTLB Series

Electrical Characteristics

Part Number	Pass Band (MHz)	Insertion Loss (dB)Max	Return Loss (dB)Min	Attenuation	Application
BTLB0016085G5H6A90	5150~5950	0.8	10	40dB Min. @ 30~2700 MHz 45dB Min. @ 3400~3800 MHz 12dB Min. @ 7250~7800 MHz 30dB Min. @ 10300~11700 MHz	WLAN
BTLB0016085G5H6F90	4900~5950	1	10	38dB Min. @ 30~2700 MHz 16dB Min. @ 3453~3547 MHz 33dB Min. @ 3667~3883 MHz 9dB Min. @ 6900~7093 MHz 20dB Min. @ 7333~7750 MHz 38dB Min. @ 10600~11650 MHz 18dB Min. @ 15540~17760 MHz	WLAN
BTLB0016085G5S1B10	4900~5850	1.7	10	42.5dB Min. @ 824~960 MHz 19.5dB Min. @ 1570~1580 MHz 43.5dB Min. @ 1710~1910 MHz 30.5dB Min. @ 1920~1990 MHz 21.5dB Min. @ 2110~2170 MHz 40dB Min. @ 2400~2500 MHz 25dB Min. @ 9800~11700 MHz 10dB Min. @ 14700~17550 MHz	WLAN
BTLB001608LXVKBA10	5150~5950	0.6(0.36Typ)	13(17.8Typ)	35dB Min./39dB Typ. @ 2400~2500 MHz 30dB Min./ 45dB Typ. @ 1.03~1.19 GHz 25dB Min./ 27dB Typ. @ 1.545~1.785 GHz	WLAN
BTLB001608LXVKBB20	5150~5950	0.7	12(17.7Typ)	35dB Min./ 44.1dB Typ. @ 700~2690 MHz 30dB Min./ 36.7dB Typ. @ 3300~3800 MHz 12dB Min./ 30.2dB Typ. @ 7250~7800 MHz 20dB Min./ 36.7dB Typ. @ 1.03~1.17 GHz	WLAN
BTLB001608LXVKBA20	5150~5925	25°C 0.85(0.66Typ) -40~85°C 1.0(0.66Typ)	12(17.7Typ)	33dB Min./ 43dB Typ. @ 100~960 MHz 33dB Min./ 41.5dB Typ. @ 1166~1249 MHz 33dB Min./ 40.6dB Typ. @ 1427~1610 MHz 33dB Min./ 39.7dB Typ. @ 1695~2200 MHz 33dB Min./ 39.7dB Typ. @ 2300~2370 MHz 33dB Min./ 40dB Typ. @ 2400~2484 MHz 33dB Min./ 40.2dB Typ. @ 2496~2690 MHz 30dB Min./ 36.7dB Typ. @ 3400~3800 MHz 30dB Min./ 30.7dB Typ. @ 7250~7800 MHz 25dB Min./ 35.9dB Typ. @ 1.03~1.185 GHz 25dB Min./ 28.3dB Typ. @ 1.545~1.7775 GHz	WLAN

- Operating temperature range -40°C ~85°C

Low Temperature Cofired Ceramic - BTLB Series

Electrical Characteristics

Part Number	Pass Band (MHz)	Insertion Loss (dB)Max	Return Loss (dB)Min	Attenuation	Application
BTLB001608LXVKBA30				40dB Min./ 46.5dB Typ. @ 100~960 MHz 40dB Min./ 45.2dB Typ. @ 1166~1249 MHz 40dB Min./ 44.5dB Typ. @ 1427~1610 MHz 40dB Min./ 44.4dB Typ. @ 1695~2200 MHz 40dB Min./ 48.4dB Typ. @ 2300~2370 MHz	Wi-Fi 6E
	5150~5710	25°C 0.9(0.7Typ) -40~85°C 1.2	10(17.1Typ)	40dB Min./ 49.9dB Typ. @ 2400~2483 MHz 40dB Min./ 52.8dB Typ. @ 2496~2690 MHz	
	5710~5925	25°C 0.8(0.55Typ) -40~85°C 1.1		30dB Min./ 35.1dB Typ. @ 3300~3800 MHz 7dB Min./ 22.8dB Typ. @ 3800~4200 MHz	
	5925~6425	25°C 0.9(0.50Typ) -40~85°C 1.2		3dB Min./ 4dB Typ. @ 7600~8400 MHz 25dB Min./ 32.9dB Typ. @ 9000~9200 MHz	
	6425~7125	25°C 1.5(0.75Typ) -40~85°C 1.8		25dB Min./ 28.6dB Typ. @ 9600~9800 MHz 25dB Min./ 27.8dB Typ. @ 1.03~1.185 GHz 25dB Min./ 31.6dB Typ. @ 1.185~1.425 GHz	
BTLB001608NXVHBA10	3300~4200	-40~85°C 2.5	10(18.22Typ)	10dB Min./ 37.2dB Typ. @ 100~2570 MHz 25dB Min./ 27.7dB Typ. @ 2620~2690 MHz 15dB Min./ 24.8dB Typ. @ 5150~5925 MHz 25dB Min./ 43.5dB Typ. @ 6600~8400 MHz 25dB Min./ 28.3dB Typ. @ ref 0.99~1.26 GHz	LTE/5G
BTLB001608OXVHBA10	4400~5000	-40~85°C 1.9	10(19.73Typ)	35dB Min./ 46.5dB Typ. @ 400~915 MHz 30dB Min./ 45.6dB Typ. @ 925~2485 MHz 20dB Min./ 32.3dB Typ. @ 2485~3600 MHz 7dB Min./ 19.6dB Typ. @ 5850~6100 MHz 15dB Min./ 24.7dB Typ. @ 6100~6890 MHz 25dB Min./ 33.8dB Typ. @ 0.88~1 GHz 20dB Min./ 29.8dB Typ. @ ref 1.32~1.5 GHz	LTE/5G

- Operating temperature range -40°C ~85°C

Low Temperature Cofired Ceramic - BTLB Series

Test Instruments : Agilent E5071 Network Analyzer

BTLB0016082G4H6BU0

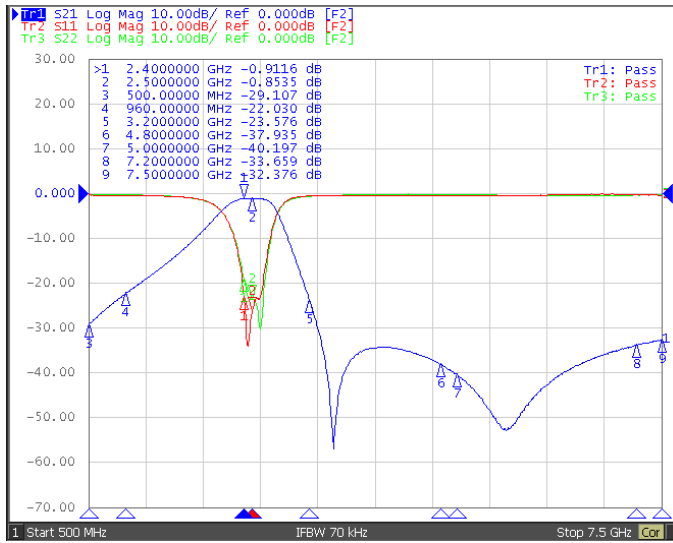

BTLB0016082G4H6DN0

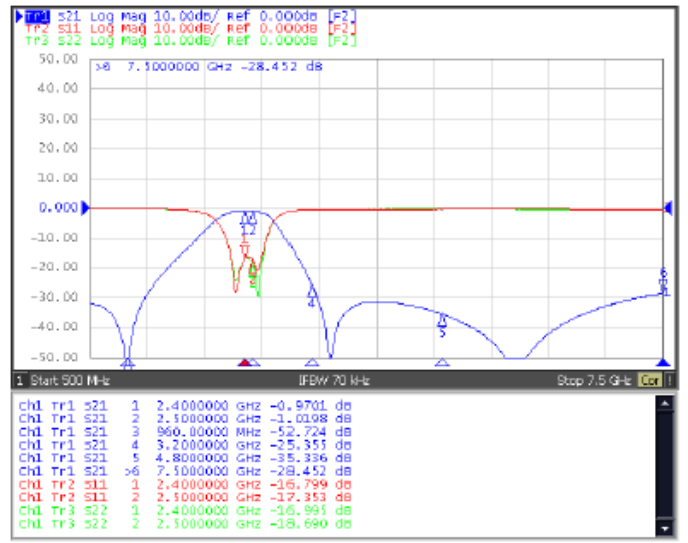

BTLB0016082G4H6DQ0

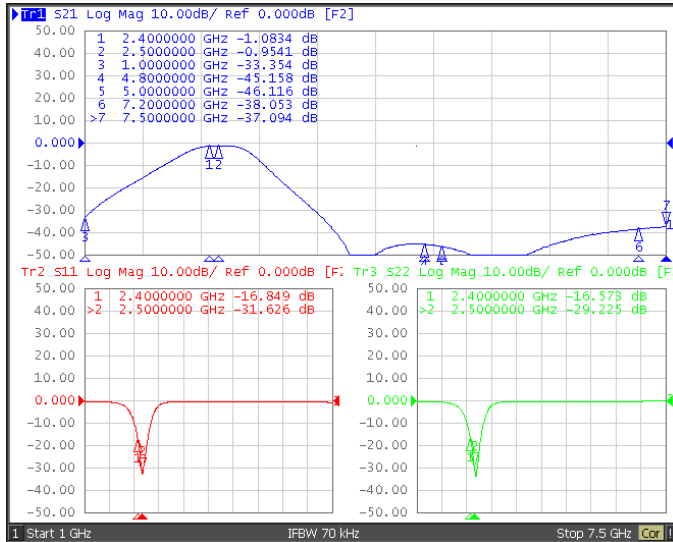

BTLB0016082G4H6H10

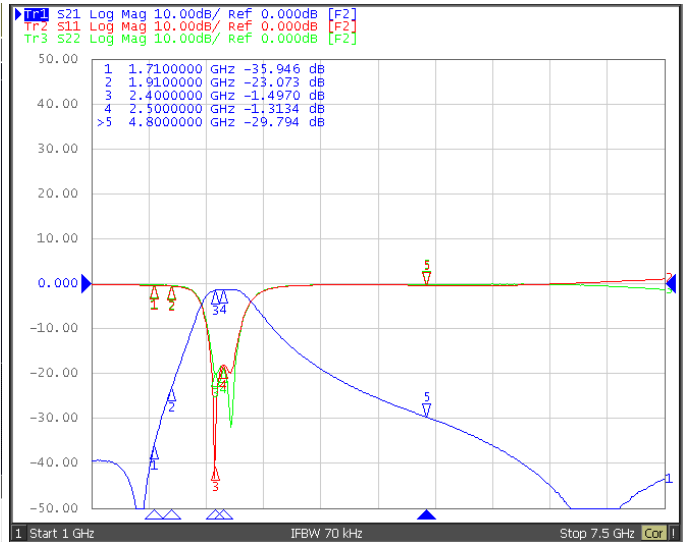

BTLB0016082G4S1A10

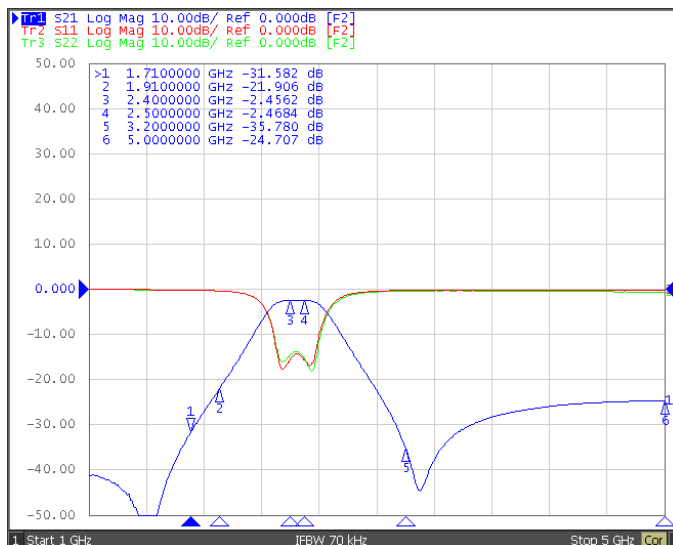

BTLB001608HXVHBA10

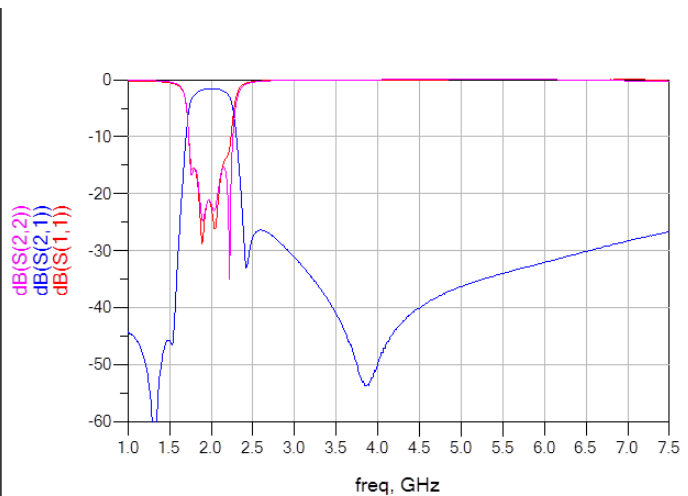

Please be sure to request approval specifications that provide further details of the products. Kindly note that the content of these specifications are subject to change or may be discontinued without prior notice. This product may not be designed/used in medical or high risk applications without Chilsin approval. Please contact our sales department before ordering.

Low Temperature Cofired Ceramic - BTLB Series

Test Instruments : Agilent E5071 Network Analyzer

BTLB001608HXVHBA20

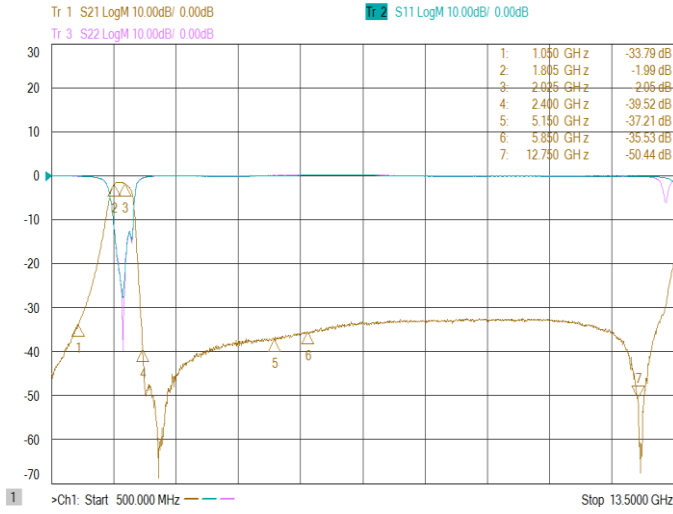

BTLB0016083G6H6C10

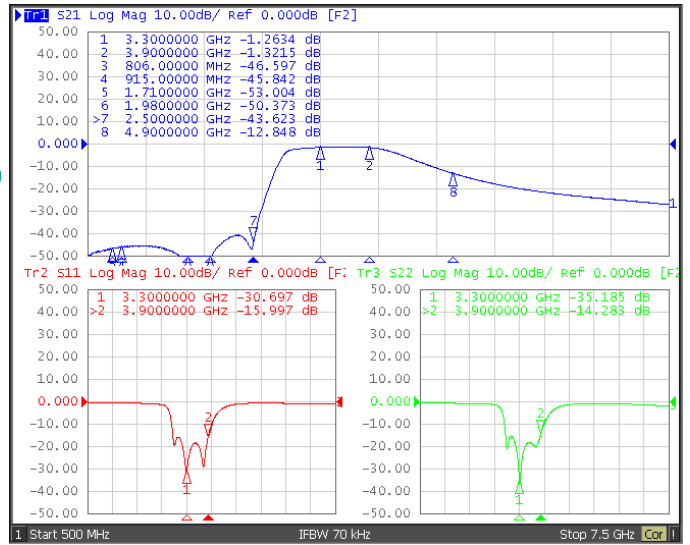

BTLB0016085G5H6A00

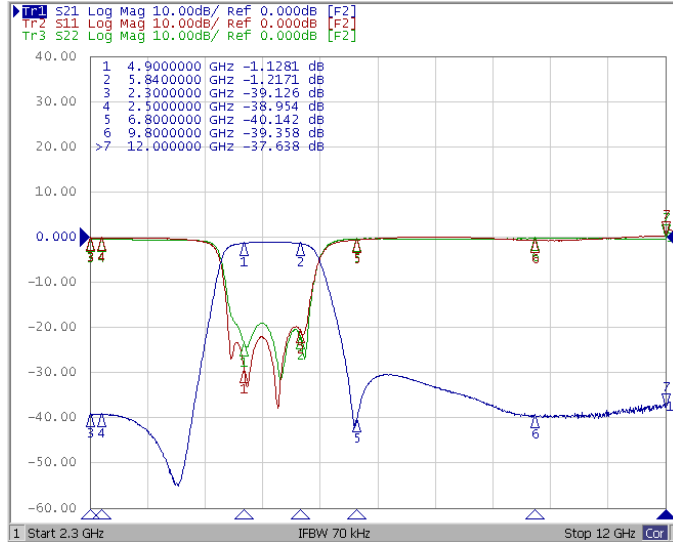

BTLB0016085G5H6A80

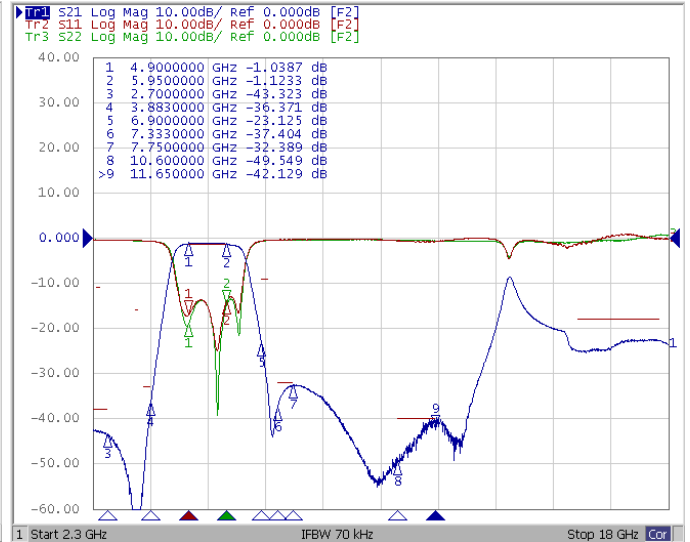

BTLB0016085G5H6A90

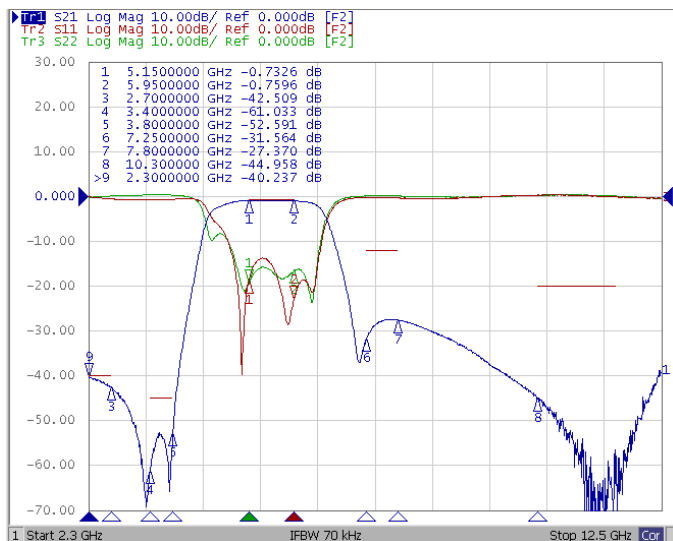

BTLB0016085G5H6F90

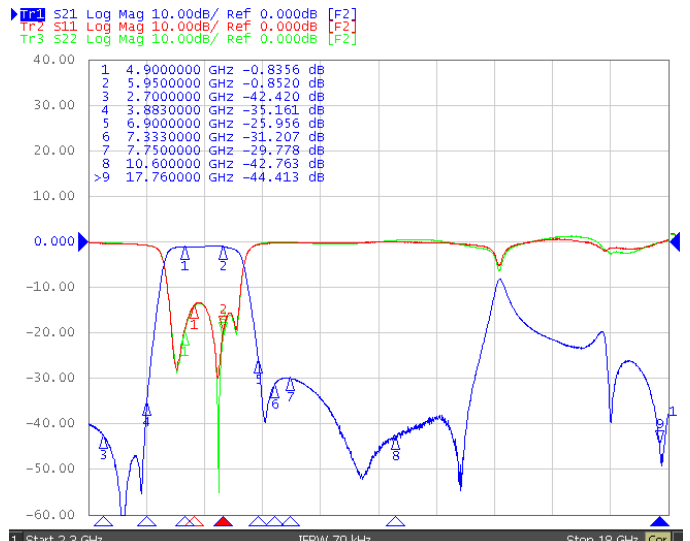

Please be sure to request approval specifications that provide further details of the products. Kindly note that the content of these specifications are subject to change or may be discontinued without prior notice. This product may not be designed/used in medical or high risk applications without Chilisin approval. Please contact our sales department before ordering.

Low Temperature Cofired Ceramic - BTLB Series

Test Instruments : Agilent E5071 Network Analyzer

BTLB0016085G5S1B10

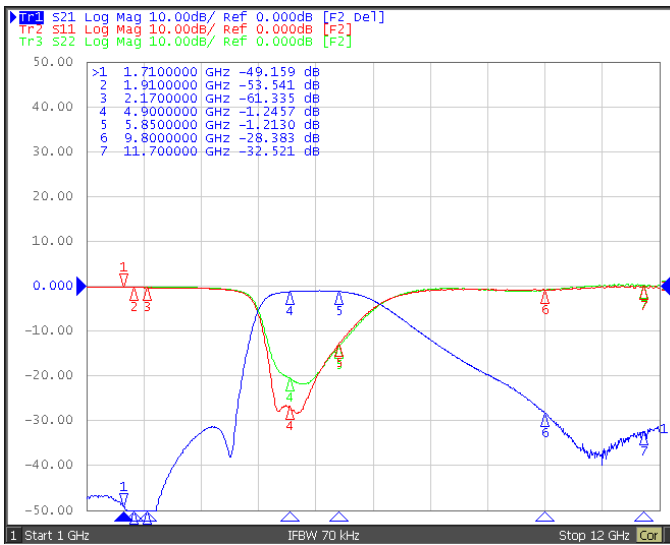

BTLB001608LXVKBA10

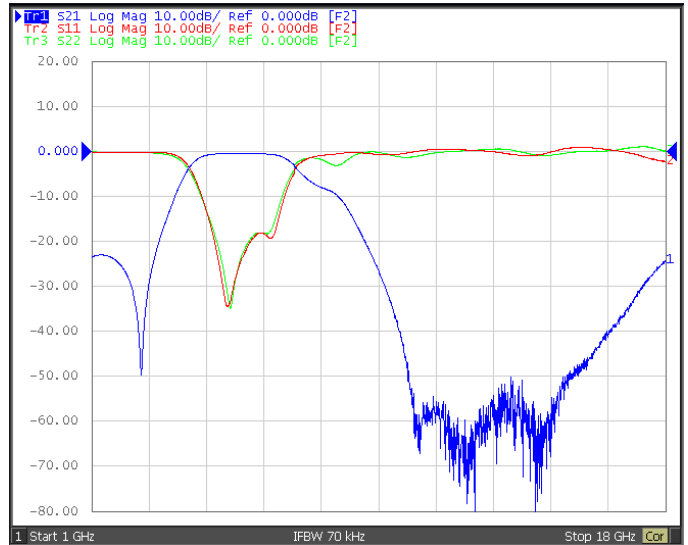

BTLB001608LXVKBA20

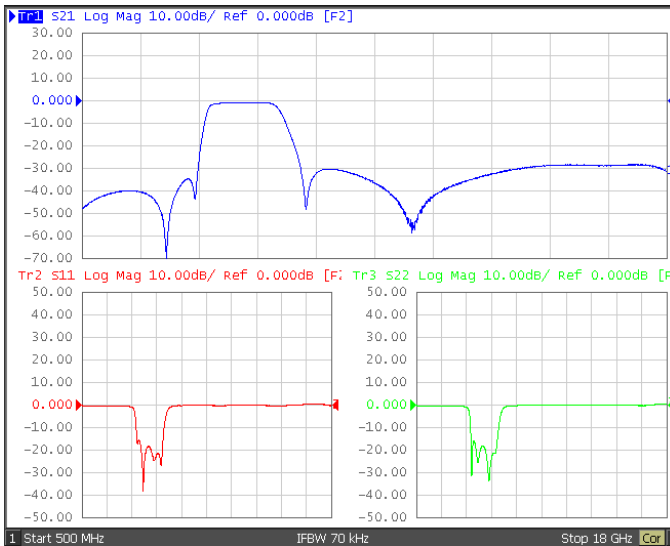

BTLB001608LXVKBB20

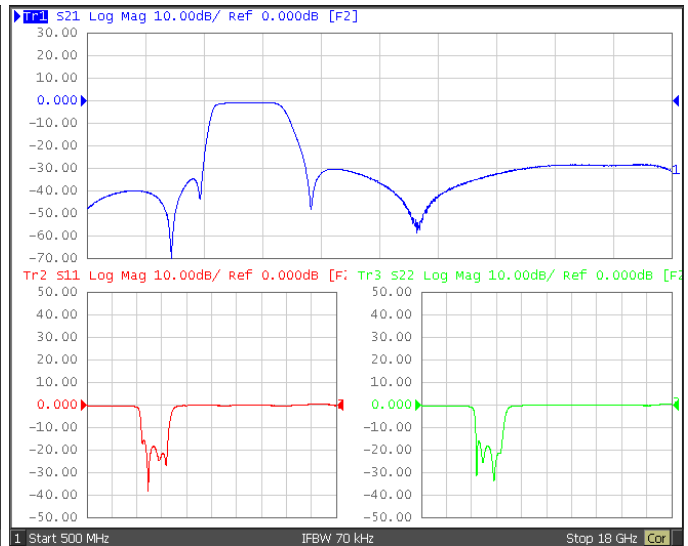

BTLB001608LXVKBA30

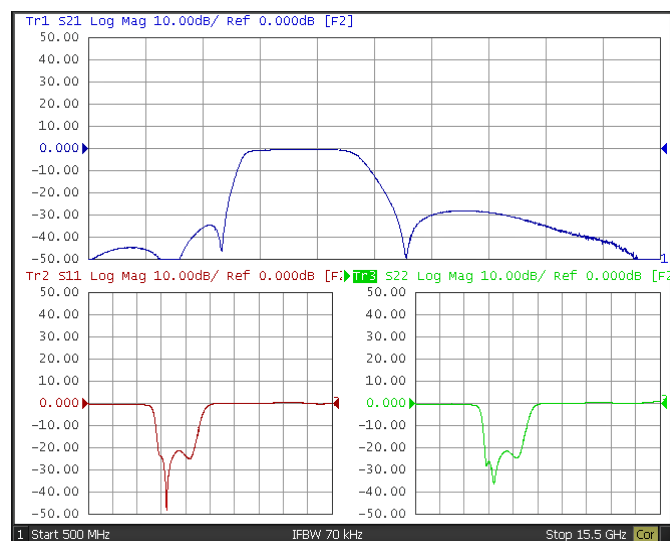

BTLB001608NXVHBA10

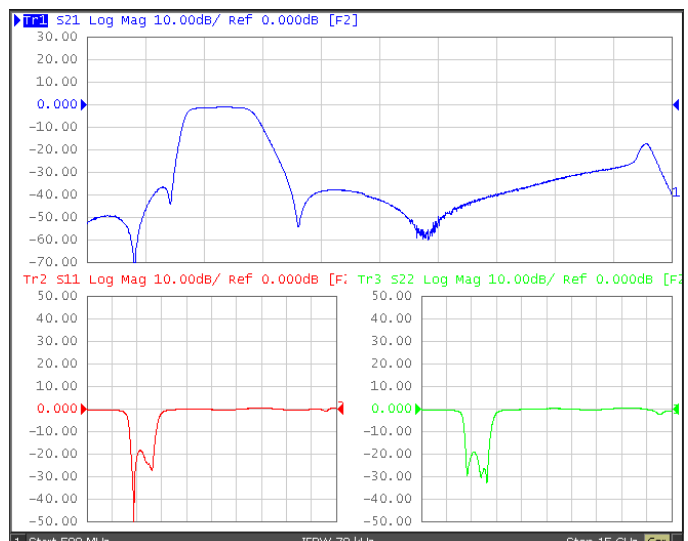

Please be sure to request approval specifications that provide further details of the products. Kindly note that the content of these specifications are subject to change or may be discontinued without prior notice. This product may not be designed/used in medical or high risk applications without Chilisin approval. Please contact our sales department before ordering.

Low Temperature Cofired Ceramic - BTLB Series

Test Instruments : Agilent E5071 Network Analyzer

BTLB0016080XVHBA10

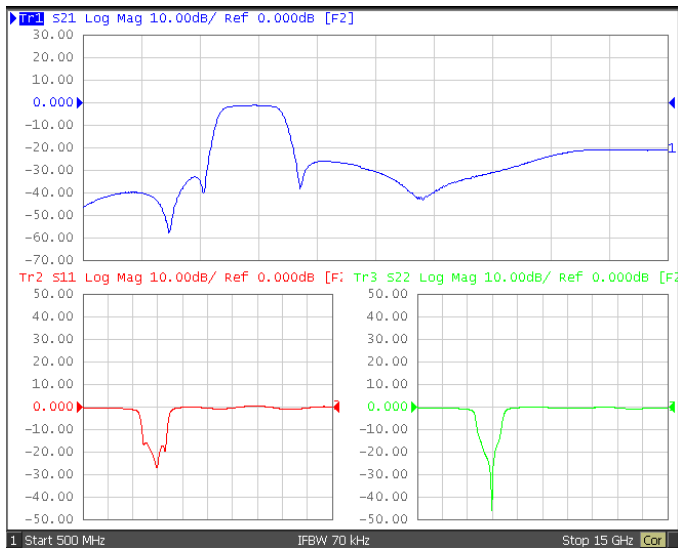

Please be sure to request approval specifications that provide further details of the products. Kindly note that the content of these specifications are subject to change or may be discontinued without prior notice. This product may not be designed/used in medical or high risk applications without Chilisin approval. Please contact our sales department before ordering.

Low Temperature Cofired Ceramic - BTLB Series

Electrical Characteristics

Part Number	Pass Band (MHz)	Insertion Loss (dB)Max	Return Loss (dB)Min	Ripple (dB)Max	Attenuation	Application
BTLB0020122G4H6A00	2400~2500	25°C 2.5 -40~85°C 2.8	10	-	30dB Min. @ 824~849 MHz 30dB Min. @ 880~915 MHz 30dB Min. @ 1545~1605 MHz 30dB Min. @ 1565~1585 MHz 35dB Min. @ 1710~1785 MHz 40dB Min. @ 1850~1910 MHz 32dB Min. @ 1920~1980 MHz 7dB Min. @ 3168~4752 MHz 11dB Min. @ 3300~3800 MHz 35dB Min. @ 4800~4967 MHz 26dB Min. @ 5150~6000 MHz 23dB Min. @ 7200~7450.5 MHz	WLAN/BT
BTLB0020122G4H6A80	2400~2500	1.2	10	-	28dB Min. @ 824~960 MHz 28dB Min. @ 1570~1580 MHz 23dB Min. @ 1710~1910 MHz 17dB Min. @ 1920~1990 MHz 25dB Min. @ 4800~5000 MHz 25dB Min. @ 7200~7500 MHz	WLAN/BT
BTLB0020122G4H6A90	2400~2500	2.6	10	-	40dB Min. @ 824~894 MHz 40dB Min. @ 880~960 MHz 38dB Min. @ 1710~1990 MHz 25dB Min. @ 2100~2170 MHz 30dB Min. @ 4800~5000 MHz 25dB Min. @ 7200~7500 MHz	WLAN/BT
BTLB0020122G4H6A0	2400~2500	1.2	10	0.5	15dB Min. @ 1600 MHz 20dB Min. @ 3200 MHz 40dB Min. @ 4800~5000 MHz	WLAN/BT
BTLB0020122G4H6A0	2400~2500	1.3	10	-	38dB Min. @ 50~960 MHz 17dB Min. @ 1710~1990 MHz 5dB Min. @ 3200~3300 MHz 30dB Min. @ 4800~5000 MHz 25dB Min. @ 7200~7500 MHz	WLAN/BT
BTLB0020122G4H6AS0	2400~2500	1.1(0.8Typ)	10	-	30dB Min./ 43dB Typ. @ 500~960MHz 26dB Min./ 33dB Typ. @ 1500~1650 MHz 22dB Min./ 32dB Typ. @ 3200~3300 MHz 35dB Min./ 44dB Typ. @ 4800~5000 MHz 20dB Min. / 28dB Typ. @ 7200~7500 MHz	WLAN/BT

- Operating temperature range $-40^{\circ}\text{C} \sim 85^{\circ}\text{C}$

Low Temperature Cofired Ceramic - BTLB Series

Electrical Characteristics

Part Number	Pass Band (MHz)	Insertion Loss (dB)Max	Return Loss (dB)Min	Ripple (dB)Max	Attenuation	Application
BTLB0020122G4H6B50	2400~2500	2.5	10	-	35dB Min. @ 824~960 MHz 38dB Min. @ 1710~1910 MHz 25dB Min. @ 4800~5000 MHz 20dB Min. @ 7200~7500 MHz	WLAN/BT
BTLB0020122G4H6B90	2400~2500	25°C 2.5 -40~85°C 2.8	10	-	40dB Min. @ 880~960 MHz 38dB Min. @ 1710~1990 MHz 16dB Min. @ 2100~2170 MHz 30dB Min. @ 4800~5000 MHz 25dB Min. @ 7200~7500 MHz	WLAN/BT
BTLB0020122G4H6BD0	2400~2500	25°C 1.8 -40~85°C 2	10	-	30dB Min. @ 824~915 MHz 30dB Min. @ 1545~1605 MHz 35dB Min. @ 1710~1990 MHz 30dB Min. @ 2170 MHz 30dB Min. @ 4800~4967 MHz 25dB Min. @ 5150~6000 MHz 20dB Min. @ 7200~7450.5 MHz	WLAN/BT
BTLB0020122G4H6C00	2400~2500	25°C 2.5 -40~85°C 2.8	10	-	30dB Min. @ 824~849 MHz 30dB Min. @ 880~915 MHz 30dB Min. @ 1545~1605 MHz 30dB Min. @ 1565~1585 MHz 35dB Min. @ 1710~1785 MHz 40dB Min. @ 1850~1910 MHz 32dB Min. @ 1920~1980 MHz 16dB Min. @ 2110~2170 MHz 7dB Min. @ 3168~4752 MHz 11dB Min. @ 3300~3800 MHz 30dB Min. @ 4800~4967 MHz 26dB Min. @ 5150~6000 MHz 23dB Min. @ 7200~7450.5 MHz	WLAN/BT
BTLB0020122G4H6D30	2400~2500	1.4	10	-	30dB Min. @ 880~915 MHz 25dB Min. @ 1710~1910 MHz 6dB Min. @ 2110~2170 MHz 23dB Min. @ 4800~5000 MHz	WLAN/BT
BTLB0020122G4S1A10	2400~2500	2.5	10	-	35dB Min. @ 880~915 MHz 15dB Min. @ 1710~1910 MHz 35dB Min. @ 3200 MHz 22dB Min. @ 4800~5000 MHz 22dB Min. @ 7200~7500 MHz	WLAN/BT
BTLB0020125G5H6A80	4900~5920	1.5	10	-	30dB Min. @ 3500 MHz	WLAN
BTLB0020125G5H6B30	5150~5850	2	10	-	30dB Min. @ 2400~3800 MHz 18dB Min. @ 10300~11700 MHz	WLAN

- Operating temperature range -40°C ~85°C

Please be sure to request approval specifications that provide further details of the products. Kindly note that the content of these specifications are subject to change or may be discontinued without prior notice. This product may not be designed/used in medical or high risk applications without Chilisin approval. Please contact our sales department before ordering.

Low Temperature Cofired Ceramic - BTLB Series

Electrical Characteristics

Part Number	Pass Band (MHz)	Insertion Loss (dB)Max	Return Loss (dB)Min	Ripple (dB)Max	Attenuation	Application
BTLB0020125G5H6C50	5150~5850	3.5	7.36	-	30dB Min. @ 4000 MHz 35dB Min. @ 4200 MHz 42dB Min. @ 4600 MHz	WLAN
BTLB0020125G5H6C80	4900~5950	1.5	10	-	35dB Min. @ 500~1900 MHz 30dB Min. @ 2140~3300 MHz 30dB Min. @ 3450 MHz 17dB Min. @ 9800~11900 MHz	WLAN
BTLB0020125G5H6D10	4900~5850	2.2	8	-	30dB Min. @ 340~1195 MHz 15dB Min. @ 2140~3580 MHz 25dB Min. @ 6855~7150 MHz 20dB Min. @ 8570~8930 MHz	WLAN
BTLB0020125G5H6D80	4900~5950	25°C 1.8 -40~85°C 2	10	1.5	33dB Min. @ 1280~3300 MHz 30dB Min. @ 3300~4000 MHz 15dB Min. @ 4375~4465 MHz 7dB Min. @ 7300~8930 MHz 20dB Min. @ 9800~11900 MHz	WLAN
BTLB0020125G5H6E80	4900~5875	2	8.52	-	30dB Min. @ 500~4000 MHz 30dB Min. @ 4200 MHz 15dB Min. @ 9800~11750 MHz	WLAN

- Operating temperature range -40°C ~85°C

Test Instruments : Agilent E5071 Network Analyzer

BTLB0020122G4H6A00

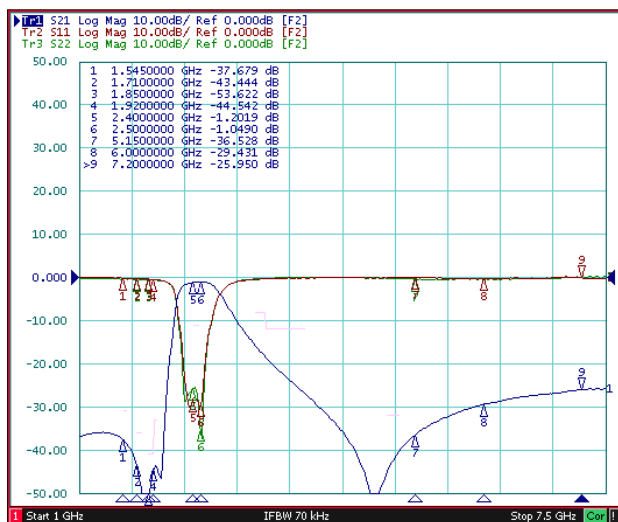

BTLB0020122G4H6A80

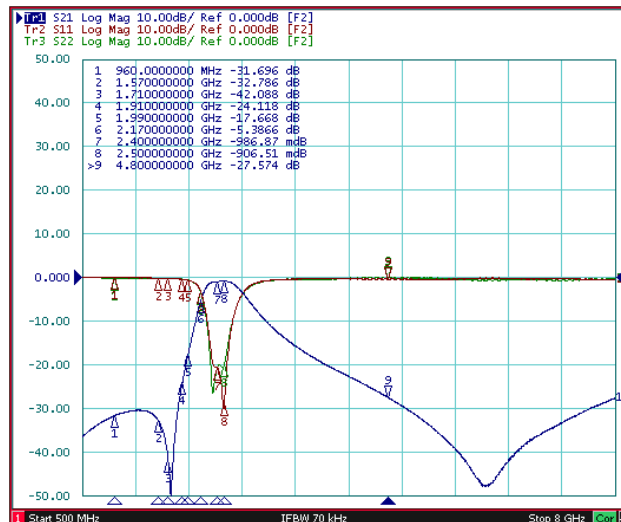

Please be sure to request approval specifications that provide further details of the products. Kindly note that the content of these specifications are subject to change or may be discontinued without prior notice. This product may not be designed/used in medical or high risk applications without Chilisin approval. Please contact our sales department before ordering.

Low Temperature Cofired Ceramic - BTLB Series

Test Instruments : Agilent E5071 Network Analyzer

BTLB0020122G4H6A90

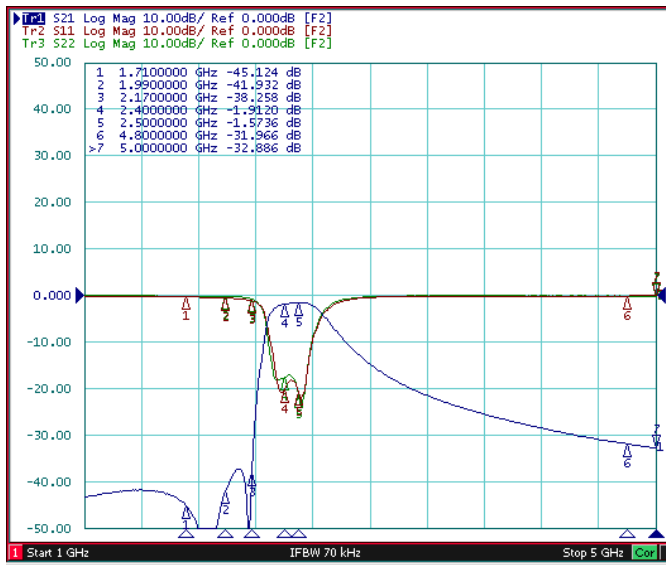

BTLB0020122G4H6A90

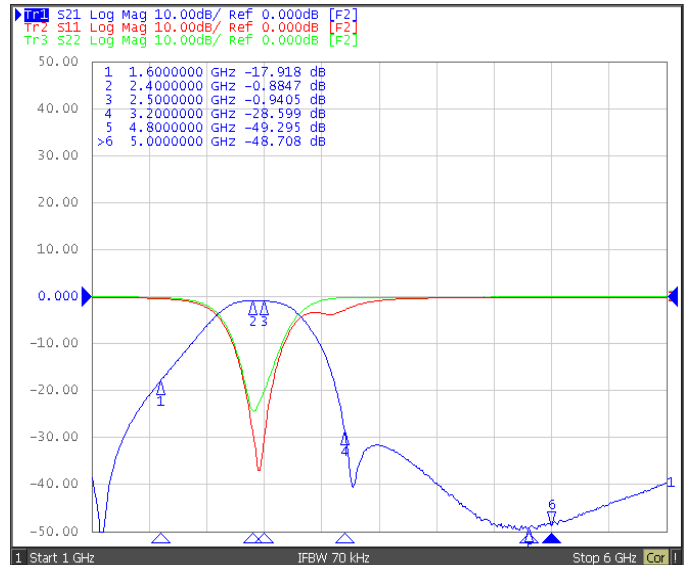

BTLB0020122G4H6AR0

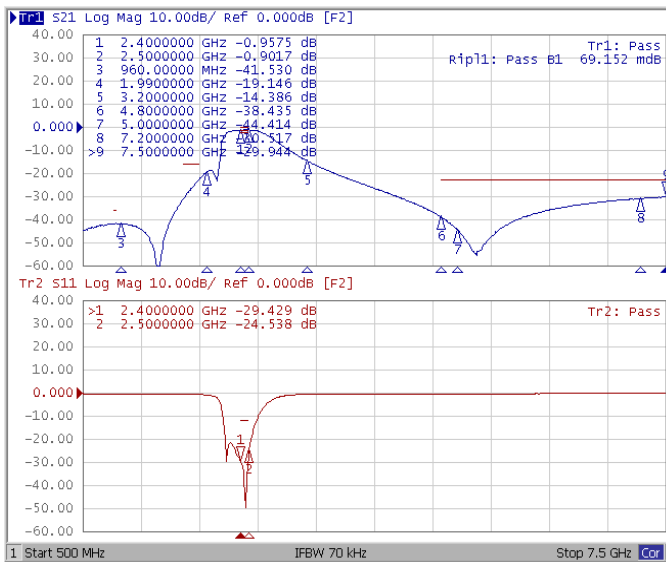

BTLB0020122G4H6AS0

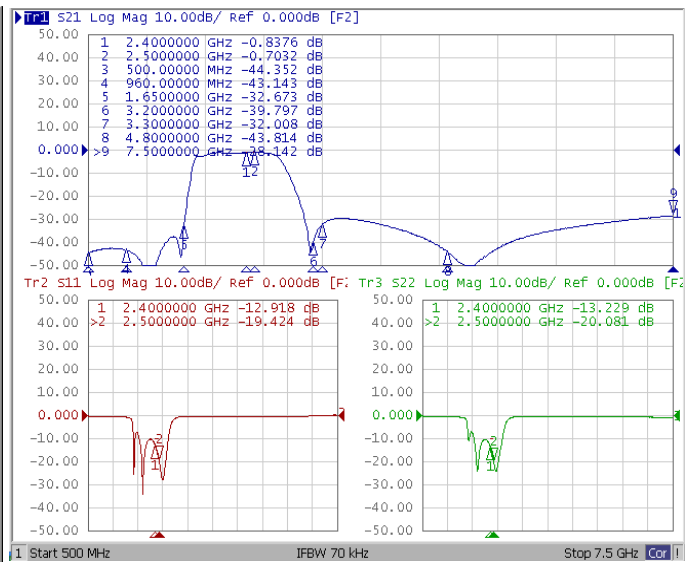

BTLB0020122G4H6B50

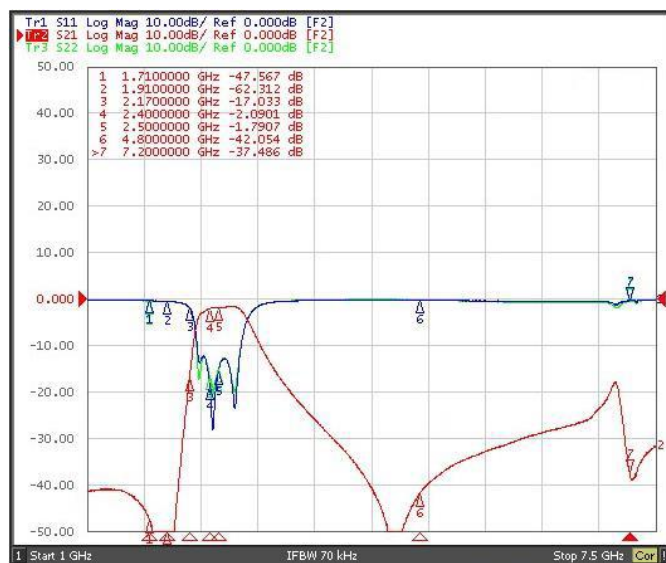

BTLB0020122G4H6B90

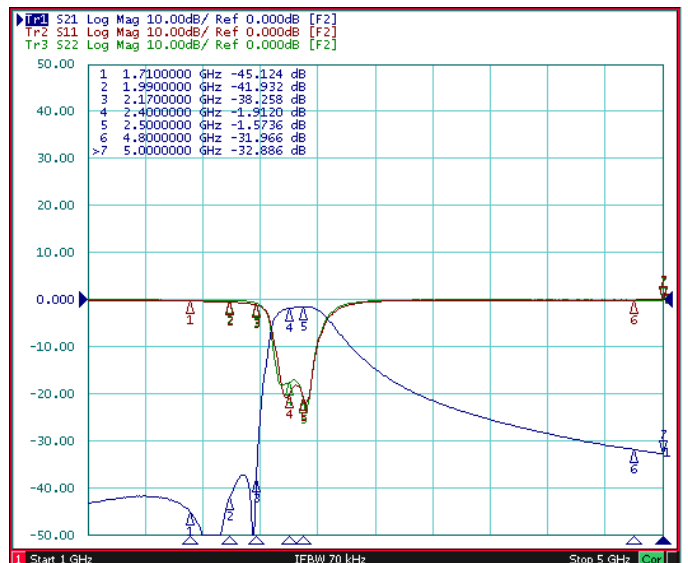

Please be sure to request approval specifications that provide further details of the products. Kindly note that the content of these specifications are subject to change or may be discontinued without prior notice. This product may not be designed/used in medical or high risk applications without Chilisin approval. Please contact our sales department before ordering.

Low Temperature Cofired Ceramic - BTLB Series

Test Instruments : Agilent E5071 Network Analyzer

BTLB0020122G4H6BD0

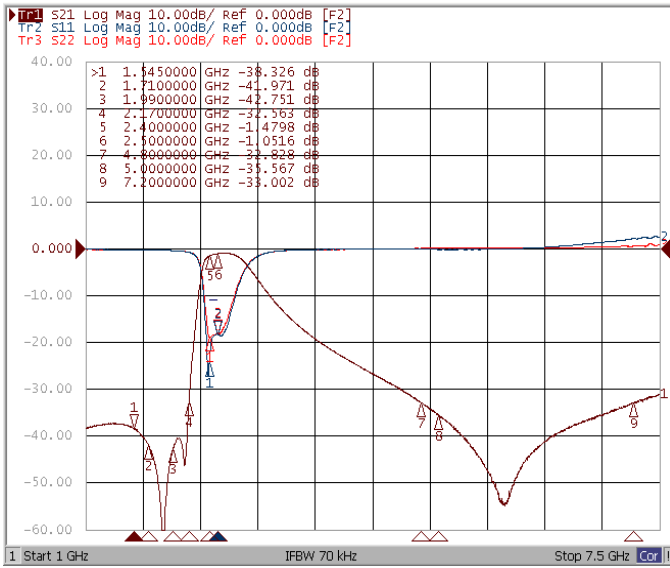

BTLB0020122G4H6C00

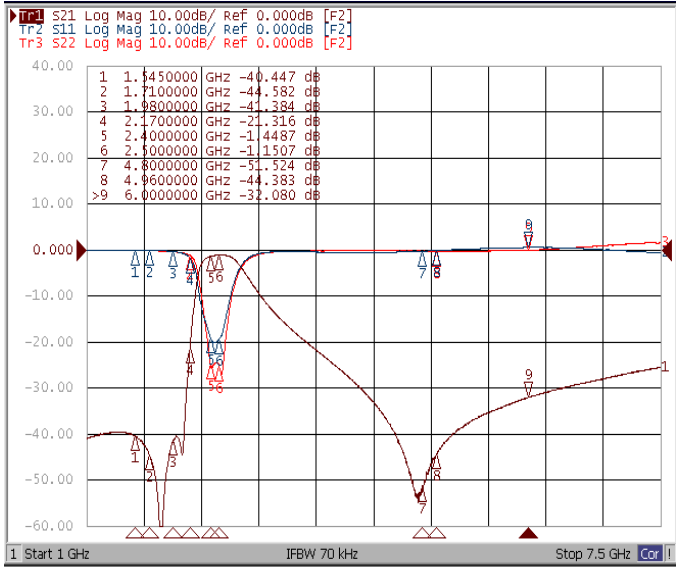

BTLB0020122G4S1A10

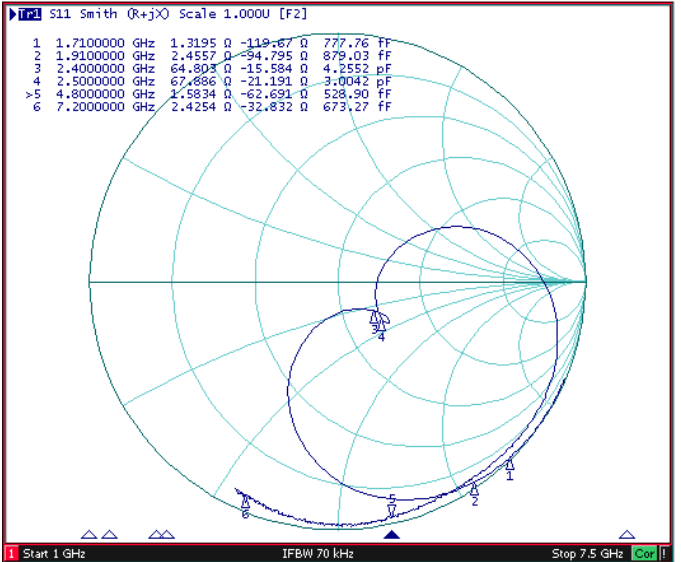
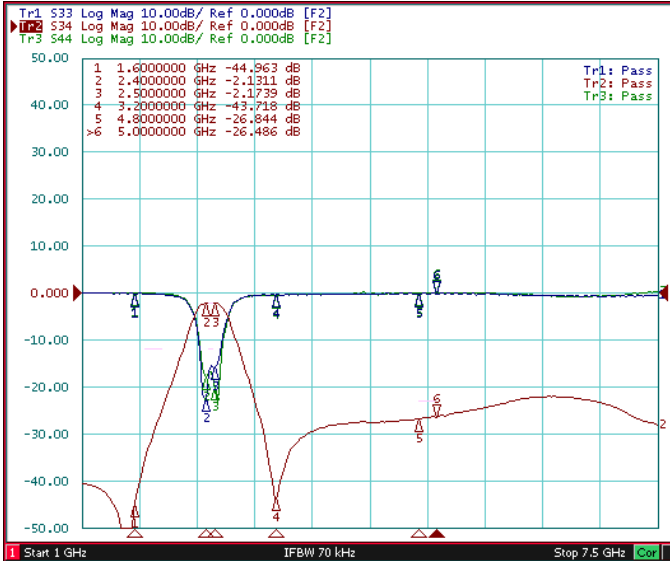

BTLB0020122G4S1A10

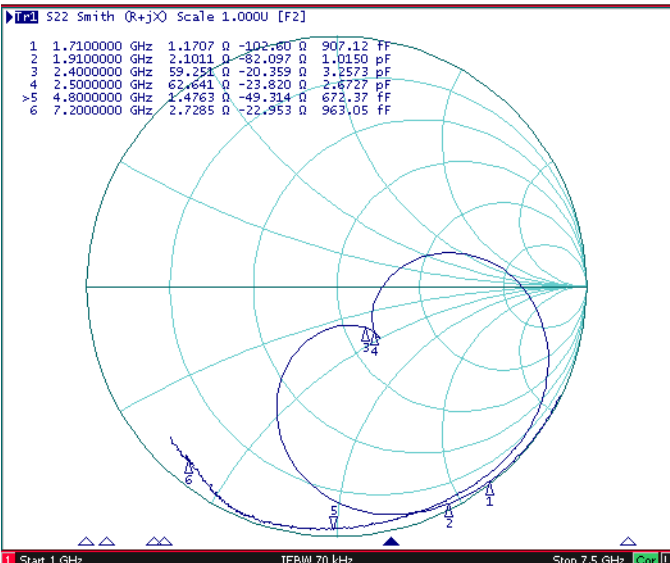

BTLB0020125G5H6A80

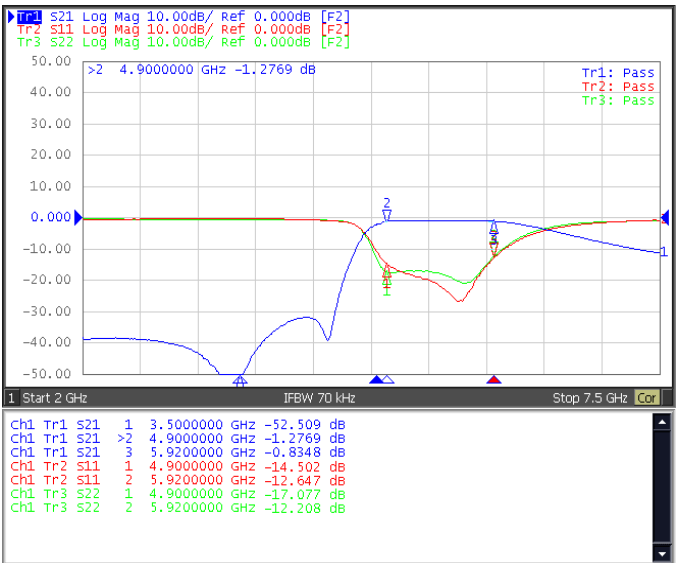

Please be sure to request approval specifications that provide further details of the products. Kindly note that the content of these specifications are subject to change or may be discontinued without prior notice. This product may not be designed/used in medical or high risk applications without Chilisin approval. Please contact our sales department before ordering.

Low Temperature Cofired Ceramic - BTLB Series

Test Instruments : Agilent E5071 Network Analyzer

BTLB0020125G5H6B30

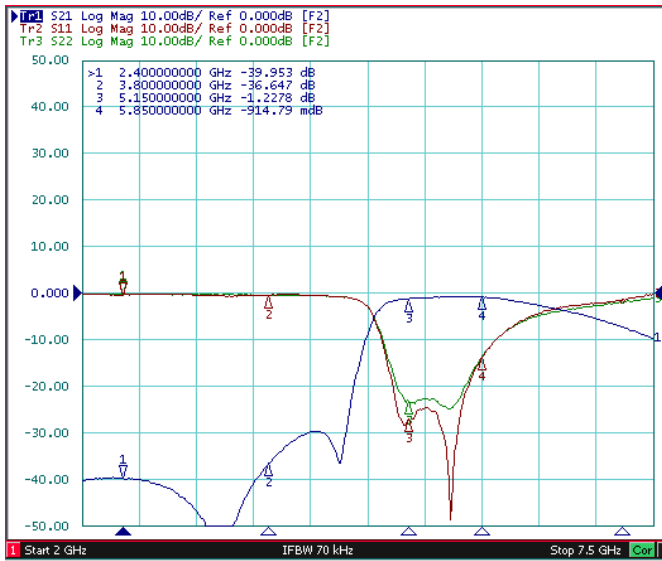

BTLB0020125G5H6C50

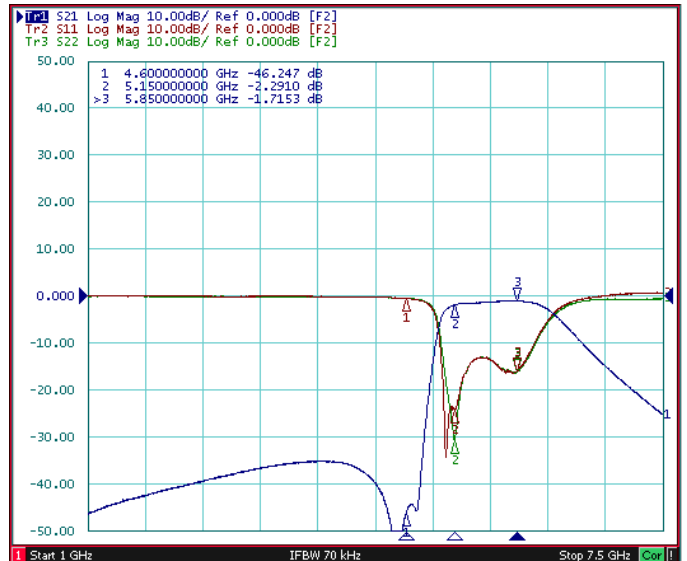

BTLB0020125G5H6C80

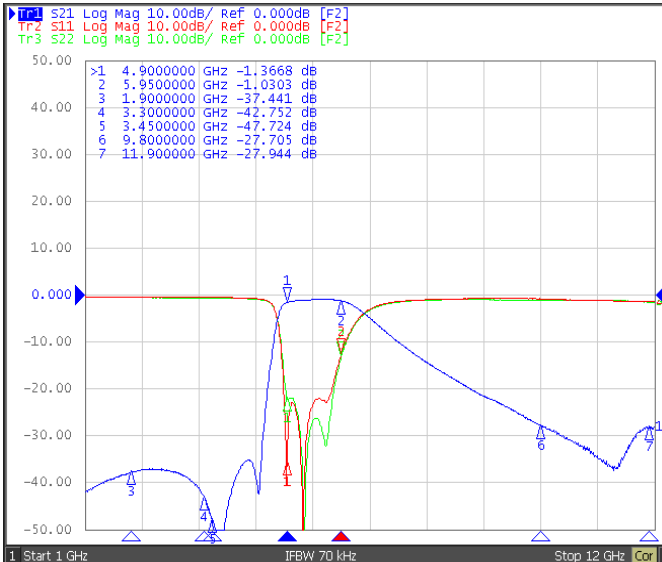

BTLB0020125G5H6D10

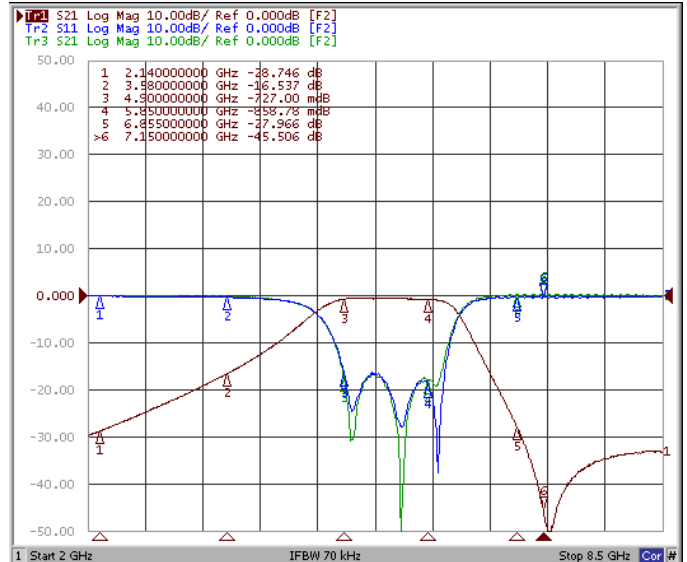

BTLB0020125G5H6D80



BTLB0020125G5H6E80

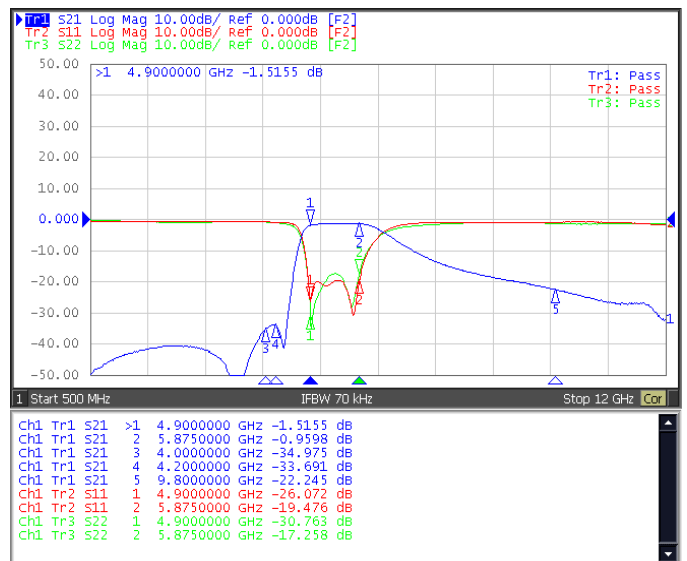

Please be sure to request approval specifications that provide further details of the products. Kindly note that the content of these specifications are subject to change or may be discontinued without prior notice. This product may not be designed/used in medical or high risk applications without Chilisin approval. Please contact our sales department before ordering.

Low Temperature Cofired Ceramic - BTLB Series

Packaging Specifications

Tape Dimensions

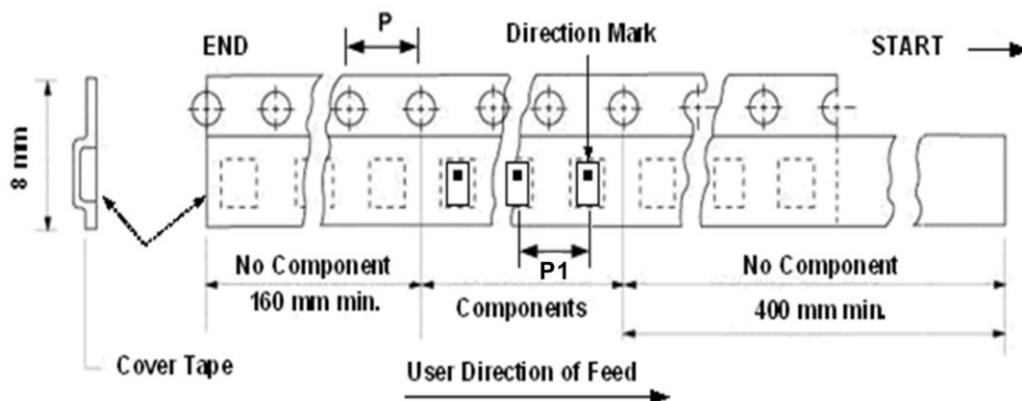

Reel Dimensions

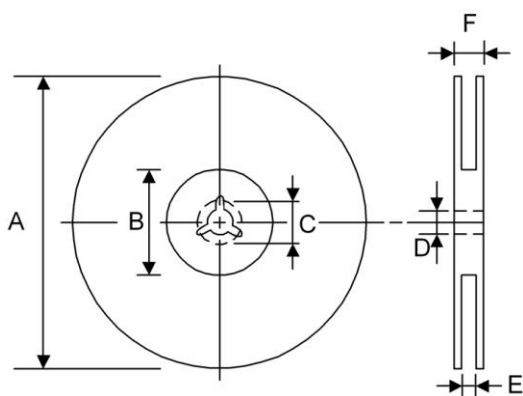

Dimensions in mm

TYPE	Tape Dimensions		Reel Dimensions						Quantity PCS / REEL
	P	P1	A	B	C	D	E	F	
BTLB001005	4	2	178	60	-	13	9	12	10000
BTLB001411	4	2	178	60	-	13	9	12	10000
BTLB001608	4	4	178	60	-	13	9	12	4000
BTLB002012	4	4	178	60	-	13	9	12	4000

X-ON Electronics

Largest Supplier of Electrical and Electronic Components

Click to view similar products for [Signal Conditioning](#) category:

Click to view products by [Chilisin](#) manufacturer:

Other Similar products are found below :

[MAPDCC0001](#) [MAPDCC0004](#) [PD0409J5050S2HF](#) [HHS-109-PIN](#) [AFS14A35-1591.50-T3](#) [DS-323-PIN](#) [1A0220-3](#) [JP510S](#)
[LFB212G45SG8C341](#) [LFB322G45SN1A504](#) [LFL182G45TC3B746](#) [SF2159E](#) [30057](#) [AFS1575.42S4-T](#) [FM-104-PIN](#) [CER0813B](#)
[MAPDCC0005](#) [3A325](#) [40287](#) [ATB3225-75032NCT](#) [BD0810N50100AHF](#) [JHS-115-PIN](#) [DC0710J5005AHF](#) [DC2327J5005AHF](#) [43020](#)
[LFB2H2G60BB1C106](#) [LFL15869MTC1B787](#) [X3C19F1-20S](#) [XC3500P-20S](#) [10013-20](#) [SF2194E](#) [CDBLB455KCAX39-B0](#) [RF1353C](#)
[051157-0000](#) [PD0922J5050D2HF](#) [1E1305-3](#) [1F1304-3S](#) [1G1304-30](#) [B0922J7575AHF](#) [10017-3](#) [TP-103-PIN](#) [BD1222J50200AHF](#)
[BD1722J50100AHF](#) [2450DP39K5400E](#) [BD0810J50150AHF](#) [BD1722J50200AHF](#) [DSS-113-PIN](#) [DS-327-PIN](#) [MACP-008125-CK07F0](#) [DS-329-PIN](#)