

BWMR Series



BWMR series, metal alloy wire wound power inductor, its rated current could be increased up to 35% compare to ferrite base power inductor.

Features

- RoHS, Halogen Free and REACH Compliance
- Constructure Low RDC and high rated current.
- Wide inductance range
- Shielded and miniature package design

Applications

- Smartphones, tablets and wearable devices
- DSC, camcorders
- DC/DC converters

Product Identification

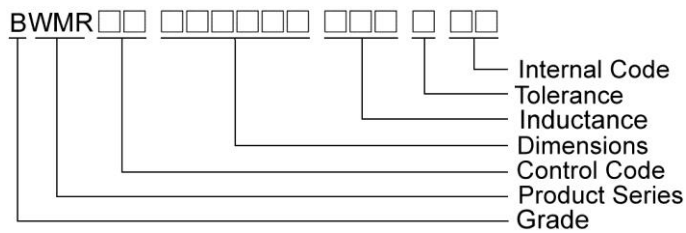

Shape and Dimensions

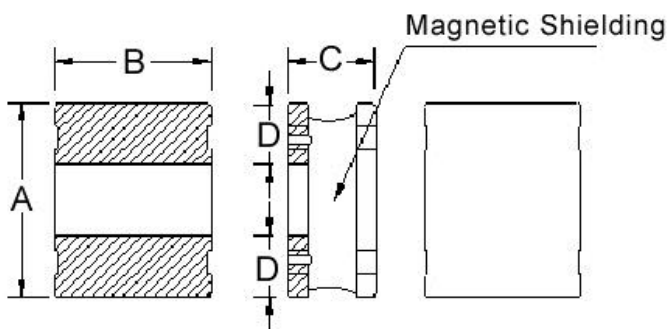

Recommended Pattern

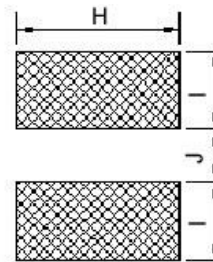

Dimensions in mm

TYPE	A	B	C	D	H	I	J
BWMR00201610	2.0±0.2	1.6±0.2	1.0 Max	0.65	1.7	0.7	0.7
BWMR00201612	2.0±0.2	1.6±0.2	1.2 Max	0.50	1.7	0.6	0.9
BWMR00252010	2.5±0.2	2.0±0.2	1.0 Max	0.85	2.1	0.9	0.8
BWMR00252012	2.5±0.2	2.0±0.2	1.2 Max	0.85	2.1	0.9	0.8
BWMR00302712	3.0±0.2	2.7±0.2	1.2 Max	1.00	2.9	1.1	1.0

Electrical Characteristics

Part Number	Inductance (uH)	Test Frequency (MHz)	Tolerance (±%)	SRF (MHz) Min	RDC(mΩ) (Max) Typ	Isat (A) (Max) Typ	Irms (A) (Max) Typ
BWMR002016104R7□00	4.7	1	20, 30	25	370(308)	1.00(1.20)	0.86(0.96)
BWMR002016106R8□00	6.8	1	20, 30	19	526(438)	0.86(0.96)	0.73(0.82)
BWMR00201610100□00	10	1	20, 30	15	768(640)	0.70(0.78)	0.64(0.72)
BWMR00201610220□00	22	1	20, 30	9	1560(1300)	0.49(0.55)	0.40(0.45)

Note: When ordering, please specify tolerance code. Tolerance: M=±20% , T =±30%

- Operating temperature range - 40°C ~ 125°C(Including self - temperature rise)
- Isat for Inductance drop 30% from its value without current
- I rms for a 40°C temperature rise from 25°C ambient with current
- Measure Equipment :
- L : Agilent 4285A+Agilent 42841A, or equivalent,1MHz 200mV
- RDC : DIGITAL MILLINHM METER CHROMA 16502, or equivalent
- Isat & I rms : Agilent/HP4285A+Agilent 42841A
- SRF : HP4294A+16092A

Test Instruments : HP4285A Material/Impedance Analyzer

Inductance vs. DC Current

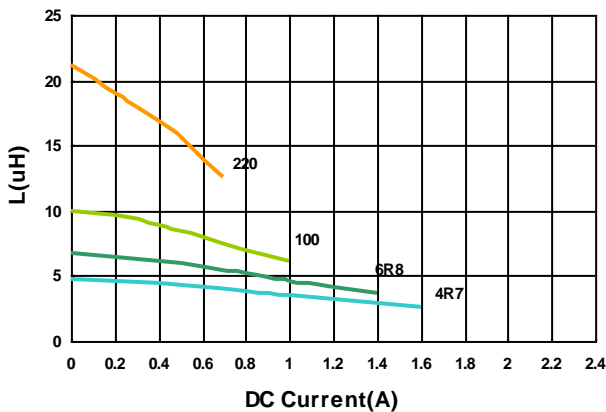

Temperature Change vs. DC Current

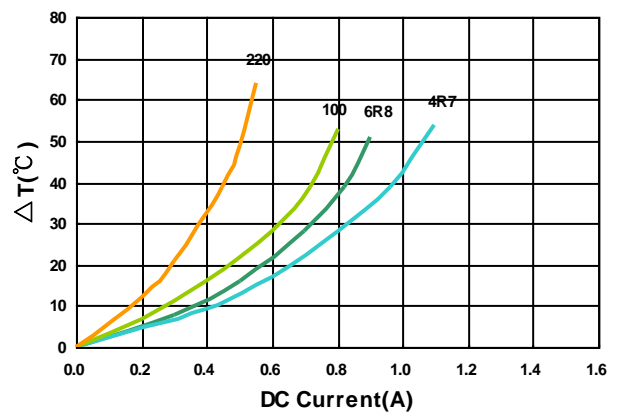

Electrical Characteristics

Part Number	Inductance (uH)	Test Frequency (MHz)	Tolerance (±%)	SRF (MHz) Min	RDC(mΩ) (Max) Typ	Isat (A) (Max) Typ	Irms (A) (Max) Typ
BWMR00201612-4R7□00	4.7	1	20, 30	26	324(270)	1.20(1.40)	1.00(1.20)
BWMR00201612-6R8□00	6.8	1	20, 30	20	456(380)	1.00(1.20)	0.78(0.92)
BWMR00201612-100□00	10	1	20, 30	16	720(600)	0.85(0.95)	0.65(0.73)
BWMR00201612-220□00	22	1	20, 30	10	1500(1250)	0.57(0.64)	0.41(0.46)

Note: When ordering, please specify tolerance code. Tolerance: M=±20% , T =±30%

- Operating temperature range - 40°C ~ 125°C(Including self - temperature rise)
- Isat for Inductance drop 30% from its value without current
- I rms for a 40°C temperature rise from 25°C ambient with current
- Measure Equipment :
- L : Agilent 4285A+Agilent 42841A, or equivalent,1MHz 200mV
- RDC : DIGITAL MILLINHM METER CHROMA 16502, or equivalent
- Isat & I rms : Agilent/HP4285A+Agilent 42841A
- SRF : HP4294A+16092A

Test Instruments : HP4285A Material/Impedance Analyzer

Inductance vs. DC Current

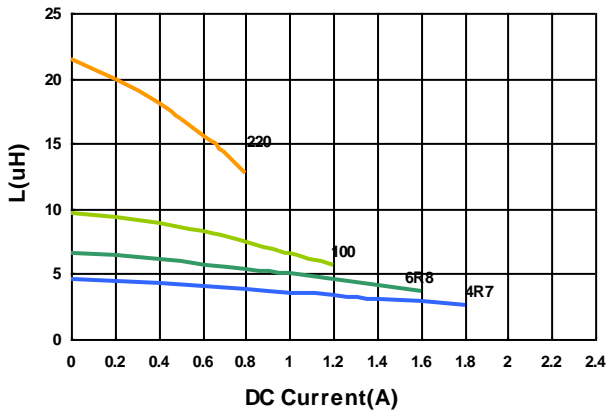

Temperature Change vs. DC Current

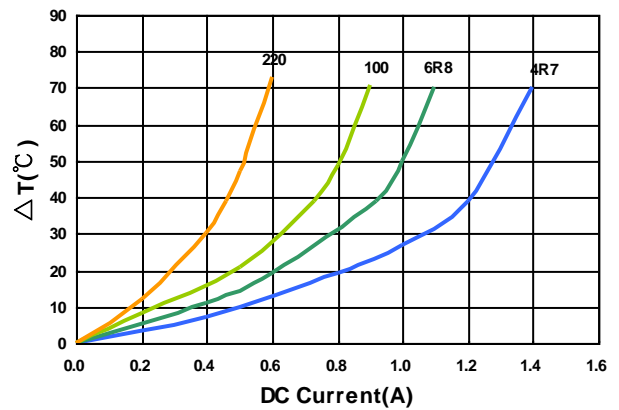

Electrical Characteristics

Part Number	Inductance (uH)	Test Frequency (MHz)	Tolerance (±%)	SRF (MHz) Min	RDC(mΩ) (Max) Typ	Isat (A) (Max) Typ	Irms (A) (Max) Typ
BWMR002520101R5□00	1.5	1	20, 30	40	111.6(93)	2.20(2.80)	1.80(1.95)
BWMR002520102R2□00	2.2	1	20, 30	31	145(121)	1.90(2.30)	1.70(1.90)
BWMR002520103R3□00	3.3	1	20, 30	24	198(165)	1.40(1.60)	1.20(1.40)
BWMR002520104R7□00	4.7	1	20, 30	19	264(220)	1.30(1.40)	1.10(1.20)
BWMR002520106R8□00	6.8	1	20, 30	15	396(330)	1.00(1.10)	0.90(1.00)
BWMR00252010100□00	10	1	20, 30	12	500(435)	0.90(1.00)	0.80(0.90)
BWMR00252010220□00	22	1	20, 30	8	1260(1050)	0.56(0.63)	0.45(0.50)

Note: When ordering, please specify tolerance code. Tolerance: M=±20% , T =±30%

- Operating temperature range - 40°C ~ 125°C(Including self - temperature rise)
- Isat for Inductance drop 30% from its value without current
- Irms for a 40°C temperature rise from 25°C ambient with current
- Measure Equipment :
- L : Agilent 4285A+Agilent 42841A, or equivalent,1MHz 200mV
- RDC : DIGITAL MILLINHM METER CHROMA 16502, or equivalent
- Isat & Irms : Agilent/HP4285A+Agilent 42841A
- SRF : HP4294A+16092A

Test Instruments : HP4285A Material/Impedance Analyzer

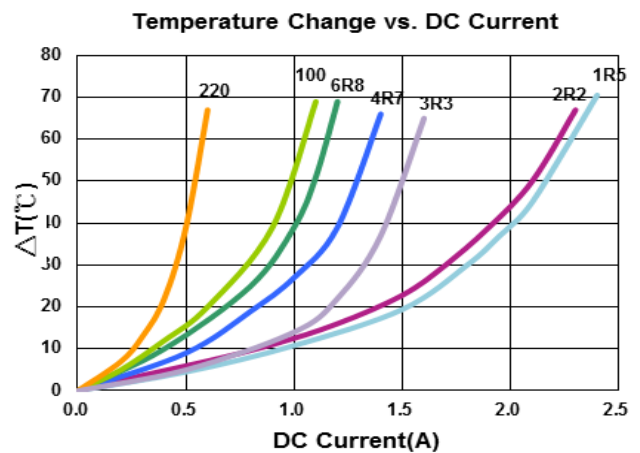
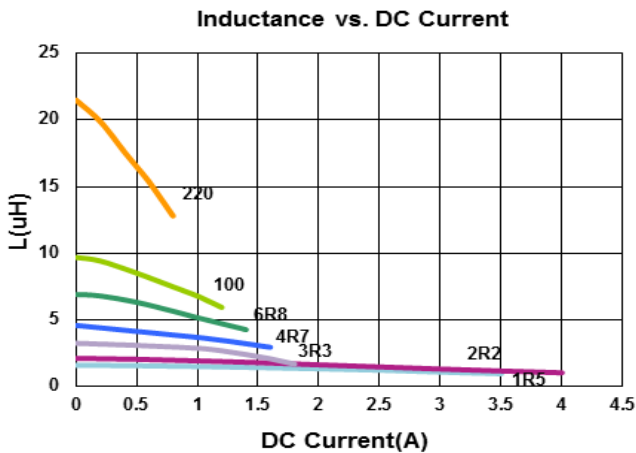

Electrical Characteristics

Part Number	Inductance (uH)	Test Frequency (MHz)	Tolerance (±%)	SRF (MHz) Min	RDC(mΩ) (Max) Typ	Isat (A) (Max) Typ	Irms (A) (Max) Typ
BWMR002520122R2□00	2.2	1	20, 30	32	110(92)	2.40(2.70)	1.90(2.20)
BWMR002520123R3□00	3.3	1	20, 30	25	186(155)	1.80(2.10)	1.45(1.65)
BWMR002520124R7□00	4.7	1	20, 30	23	240(200)	1.70(1.90)	1.30(1.50)
BWMR002520126R8□00	6.8	1	20, 30	16	345(285)	1.30(1.60)	1.00(1.20)
BWMR00252012100□00	10	1	20, 30	14	480(400)	1.00(1.30)	0.85(1.00)
BWMR00252012220□00	22	1	20, 30	8	1090(910)	0.74(0.83)	0.54(0.60)

Note: When ordering, please specify tolerance code. Tolerance: M=±20% , T =±30%

- Operating temperature range - 40°C ~ 125°C(Including self - temperature rise)
- Isat for Inductance drop 30% from its value without current
- Irms for a 40°C temperature rise from 25°C ambient with current
- Measure Equipment :
- L : Agilent 4285A+Agilent 42841A, or equivalent,1MHz 200mV
- RDC : DIGITAL MILLINHM METER CHROMA 16502, or equivalent
- Isat & Irms : Agilent/HP4285A+Agilent 42841A
- SRF : HP4294A+16092A

Test Instruments : HP4285A Material/Impedance Analyzer

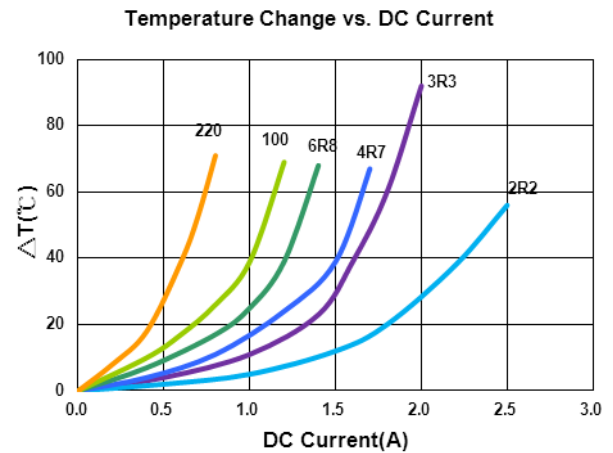
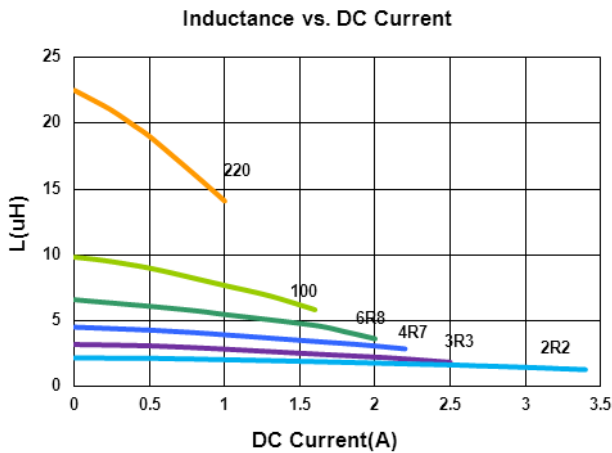

Sealed Power Inductors - BWMR Series

Electrical Characteristics

Part Number	Inductance (uH)	Test Frequency (MHz)	Tolerance (±%)	SRF (MHz) Min	RDC(mΩ) (Max) Typ	Isat (A) (Max) Typ	Irms (A) (Max) Typ
BWMR003027121R0□00	1.0	1	20, 30	52	64(54)	4.8(5.4)	2.7(3.0)
BWMR003027122R2□00	2.2	1	20, 30	28	114(95)	3.3(3.7)	2.0(2.3)
BWMR003027123R3□00	3.3	1	20, 30	25	165(138)	2.7(3.0)	1.7(1.9)
BWMR003027124R7□00	4.7	1	20, 30	20	234(195)	2.2(2.5)	1.3(1.5)
BWMR003027126R8□00	6.8	1	20, 30	16	318(265)	1.8(2.1)	1.1(1.3)
BWMR00302712100□00	10	1	20, 30	12	444(370)	1.5(1.7)	1.0(1.15)
BWMR00302712220□00	22	1	20, 30	7	954(795)	1.0(1.2)	0.63(0.7)

Note: When ordering, please specify tolerance code. Tolerance: M=±20% , T =±30%

- Operating temperature range - 40°C ~ 125°C(Including self - temperature rise)
- Isat for Inductance drop 30% from its value without current
- I rms for a 40°C temperature rise from 25°C ambient with current
- Measure Equipment :
- L : Agilent 4285A+Agilent 42841A, or equivalent,1MHz 200mV
RDC : DIGITAL MILLINHM METER CHROMA 16502, or equivalent
Isat & I rms : Agilent/HP4285A+Agilent 42841A
SRF : HP4294A+16092A

Test Instruments : HP4285A Material/Impedance Analyzer

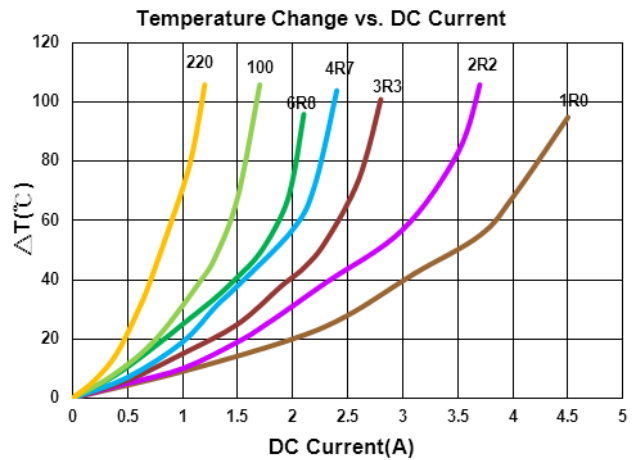
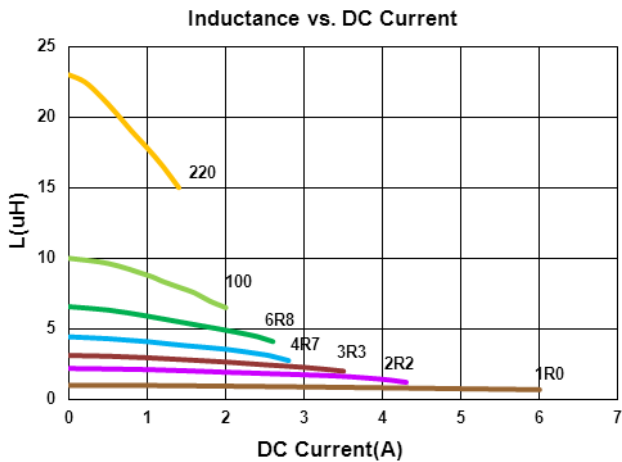

Sealed Power Inductors - BWMR Series

Packaging Specifications

Tape Dimensions

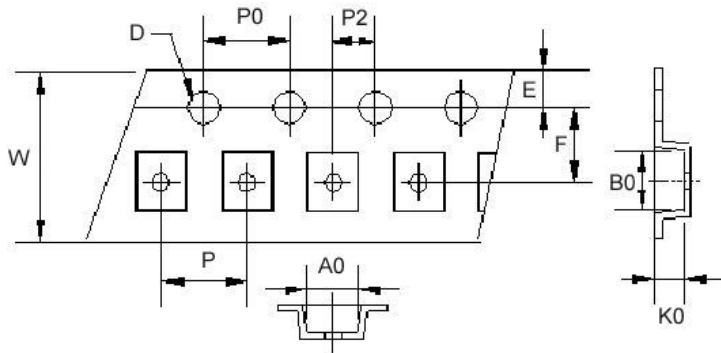

Reel Dimensions

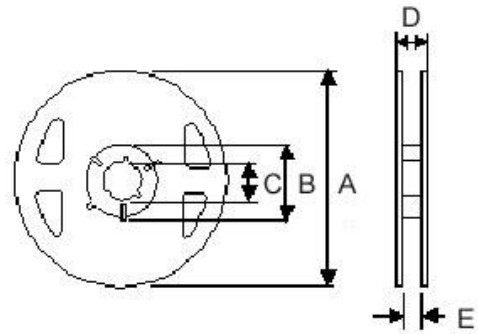

Dimensions in mm

TYPE	Tape Dimensions										Reel Dimensions					Quantity
	A0	B0	K0	D	E	F	W	P	P0	P2	A	B	C	D	E	PCS / Reel
BWMR00201610	1.90	2.20	1.15	1.55	1.75	3.5	8	4	4	2	180	60	13	14.4	8.4	2000
BWMR00201612	1.95	2.20	1.35	1.55	1.75	3.5	8	4	4	2	180	60	13	14.4	8.4	2000
BWMR00252010	2.35	2.80	1.15	1.55	1.75	3.5	8	4	4	2	180	60	13	14.4	8.4	2000
BWMR00252012	2.35	2.80	1.35	1.55	1.75	3.5	8	4	4	2	180	60	13	14.4	8.4	2000
BWMR00302712	2.90	3.20	1.35	1.55	1.75	3.5	8	4	4	2	180	60	13	14.4	8.4	2000

X-ON Electronics

Largest Supplier of Electrical and Electronic Components

Click to view similar products for [Fixed Inductors](#) category:

Click to view products by [Chilisin](#) manufacturer:

Other Similar products are found below :

[CR32NP-100KC](#) [70F224AI](#) [MHQ1005P10NJ](#) [MHQ1005P1N0S](#) [MHQ1005P2N4S](#) [MHQ1005P3N6S](#) [MHQ1005P5N1S](#) [MHQ1005P8N2J](#)
[PE-53601NL](#) [PE-53602NL](#) [PG0936.113NLT](#) [9220-20](#) [9310-16](#) [PM06-2N7](#) [PM06-39NJ](#) [A01TK](#) [1206CS-471XJ](#) [HC2-R47-R](#) [HC8-1R2-R](#)
[HCF1305-3R3-R](#) [1206CS-151XG](#) [RCH664NP-4R7M](#) [RCP1317NP-391L](#) [DH2280-4R7M](#) [DS1608C-106](#) [B10TJ](#) [B82498B3101J000](#) [ELJ-](#)
[RE27NJF2](#) [1812CS-153XJ](#) [1812CS-183XJ](#) [1812CS-223XJ](#) [1812LS-104XJ](#) [1812LS-105XJ](#) [1812LS-124XJ](#) [1812LS-154XJ](#) [1812LS-223XJ](#)
[1812LS-224XJ](#) [1812LS-563XJ](#) [1812LS-683XJ](#) [1812LS-824XJ](#) [NIN-FB101JTR110F](#) [NIN-FB471JTR62F](#) [NIN-FC1R5JTR220F](#) [NIN-](#)
[HCR15JTRF](#) [NIN-HCR33JTRF](#) [NIN-HDR22JTRF](#) [NIN-HDR82JTRF](#) [NIN-HK2N7STRF](#) [NIN-PA150KTR370F](#) [NIN-PB100KTR550F](#)