

## BWVF Series



BWVF series, an automatic assembly constructed power inductor, is shielded with magnetic resin and suitable for portable DC-DC converter applications.

### Features

- RoHS, Halogen Free and REACH Compliance
- Shielded with magnetic resin
- Various package size and wide inductance range
- Optimize electrical characteristics by using different ferrite core figures

### Applications

- Smartphones, tablets and wearable devices
- DSC, camcorders
- AP Routers
- STBs
- LCD TVs, monitors and panels
- Game consoles
- DC/DC converters

### Product Identification

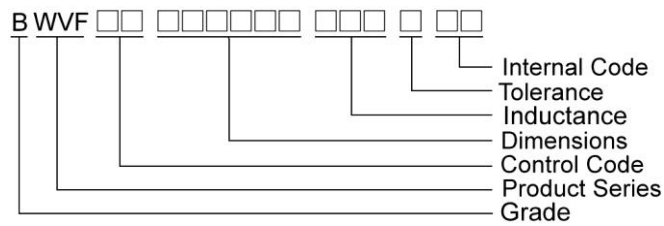

### Shape and Dimensions

Figure 1

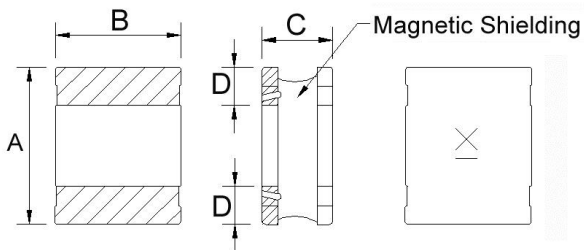
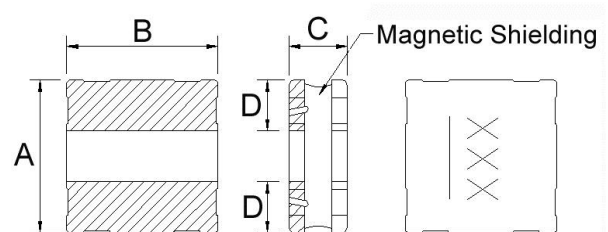

Figure 2



Dimensions in mm

TYPE	FIG	A	B	C	D	H	I	J
BWVF00201612	1	2.0±0.25	1.6±0.25	1.2±0.05	0.6	1.8	0.8	0.8
BWVF00252010	1	2.5±0.25	2.0±0.25	1.02 Max	0.8	2.2	0.85	0.8
BWVF00252012	1	2.5±0.25	2.0±0.25	1.2±0.05	0.8	2.2	0.85	0.8
BWVF00303010	2	3.0±0.20	3.0±0.20	1.02 Max	1.0	3.2	1.1	1.0
BWVF00303012	2	3.0±0.20	3.0±0.20	1.2 Max	1.0	3.2	1.1	1.0
BWVF00303015	2	3.0±0.20	3.0±0.20	1.5 Max	1.0	3.2	1.1	1.0
BWVF00404012	2	4.0±0.20	4.0±0.20	1.2±0.1	1.5	4.2	1.5	1.2

### Recommended Pattern

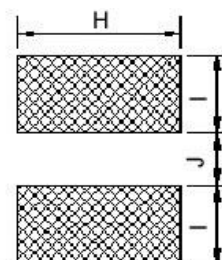

## Shape and Dimensions

Figure 3

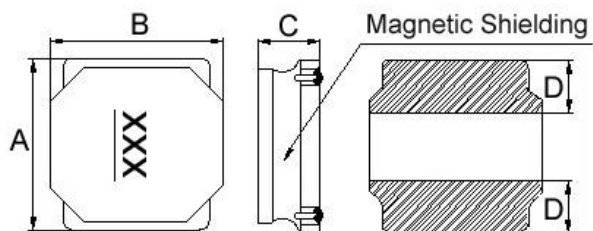
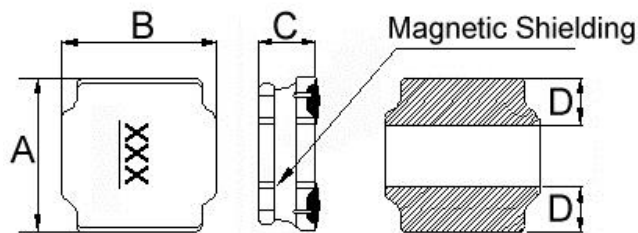

Figure 4



Dimensions in mm

TYPE	FIG	A	B	C	D	H	I	J
BWVF00404015	3	4.0±0.25	4.0±0.25	1.5±0.2	1.3	3.7	1.5	1.2
BWVF00404018	3	4.0±0.20	4.0±0.20	1.9 Max	1.3	3.7	1.5	1.2
BWVF00404026	3	4.0±0.20	4.0±0.25	2.6±0.2	1.4	3.7	1.6	1.2
BWVF00505020	4	5.0±0.20	5.0±0.20	2.0±0.2	1.8±0.3	4.2	1.6	2.0
BWVF00606020	4	6.0±0.20	6.0±0.20	2.0±0.2	1.7±0.3	5.7	1.7	2.8
BWVF00606028	4	6.0±0.20	6.0±0.20	2.8±0.2	1.9±0.3	5.7	1.8	2.6
BWVF00808040	4	8.0±0.20	8.0±0.20	4.0 <sup>+0.2</sup> <sub>-0.30</sub>	2.3±0.3	7.5	2.5	3.4

## Recommended Pattern

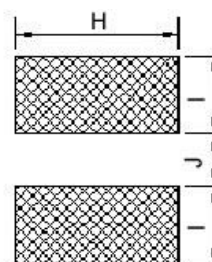

## Electrical Characteristics

Part Number	Inductance (uH)	Tolerance (±%)	Test Frequency (MHz)	RDC (Ω) ±30%	Isat (A) Typ. (Max)	Irms (A) Typ. (Max)	Marking
BWVF00201612R47□00	0.47	20, 30	1	0.051	2.70(2.43)	2.30(2.07)	A
BWVF00201612R68□00	0.68	20, 30	1	0.074	2.20(1.98)	2.00(1.80)	L
BWVF002016121R5□00	1.5	20, 30	1	0.130	1.60(1.44)	1.45(1.30)	D
BWVF002016126R8□00	6.8	20, 30	1	0.465	0.82(0.73)	0.78(0.70)	H

**Note:** When ordering, please specify tolerance code. Tolerance: M=±20% , T =±30%

- Operating temperature range - 55°C ~ 125°C(Including self - temperature rise)
- Isat for Inductance drop 30% from its value without current
- I rms for a 40°C temperature rise from 25°C ambient with current
- Measure Equipment :  
 L : Agilent HP4287A+Agilent HP16197A, 1MHz 200mV  
 RDC : DIGITAL MILLINHM METER CHROMA 16502, or equivalent  
 Isat & I rms : Agilent HP4284A

**Test Instruments :** HP4284A Material/Impedance Analyzer

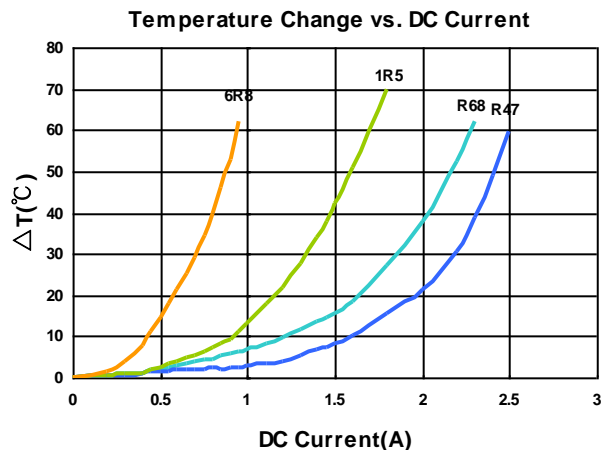
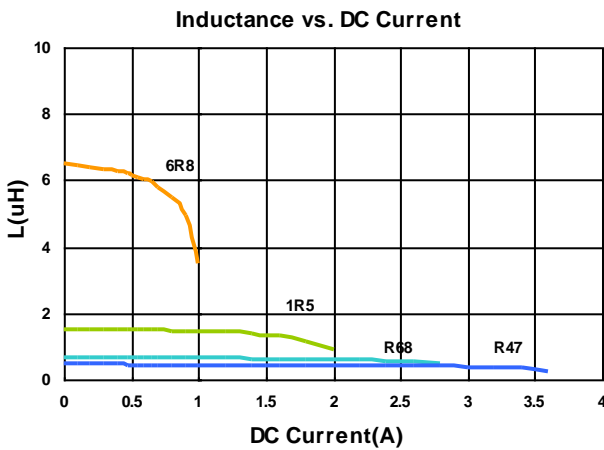

## Electrical Characteristics

Part Number	Inductance (uH)	Tolerance (±%)	Test Frequency (MHz)	RDC (Ω) ±30%	Isat (A) Typ. (Max)	Irms (A) Typ. (Max)	Marking
BWVF00252010R47□00	0.47	20, 30	1	0.045	2.80(2.52)	2.30(2.07)	A
BWVF002520101R0□00	1.0	20, 30	1	0.066	1.98(1.78)	2.05(1.84)	B
BWVF002520101R5□00	1.5	20, 30	1	0.095	1.70(1.53)	1.85(1.66)	C
BWVF002520104R7□00	4.7	20, 30	1	0.285	0.92(0.82)	0.95(0.85)	F
BWVF00252010100□00	10	20, 30	1	0.535	0.60(0.54)	0.70(0.63)	H
BWVF00252010150□00	15	20, 30	1	0.810	0.50(0.45)	0.55(0.49)	I
BWVF00252010220□00	22	20, 30	1	1.200	0.40(0.36)	0.44(0.39)	J

**Note: When ordering, please specify tolerance code. Tolerance: M=±20% , T =±30%**

- Operating temperature range - 55°C ~ 125°C(Including self - temperature rise)
- Isat for Inductance drop 30% from its value without current
- I rms for a 40°C temperature rise from 25°C ambient with current
- Measure Equipment :  
 L : Agilent HP4287A+Agilent HP16197A, 1MHz 200mV  
 RDC : DIGITAL MILLINHM METER CHROMA 16502, or equivalent  
 Isat & I rms : Agilent HP4284A

**Test Instruments :** HP4284A Material/Impedance Analyzer

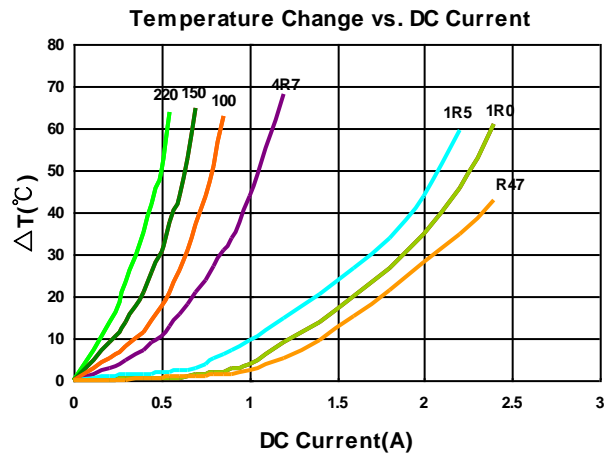
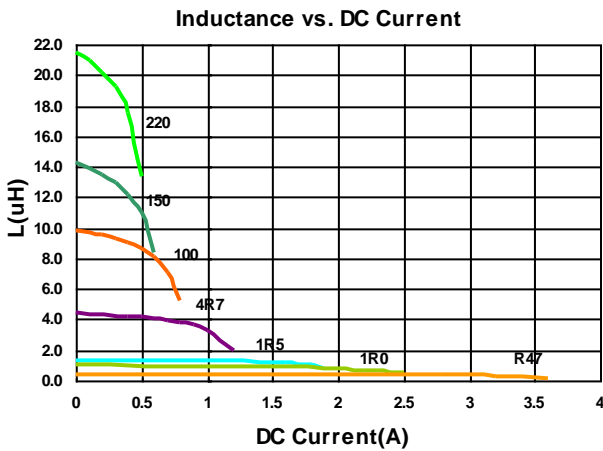

## Electrical Characteristics

Part Number	Inductance (uH)	Tolerance (±%)	Test Frequency (MHz)	RDC (Ω) ±30%	Isat (A) Typ. (Max)	Irms (A) Typ. (Max)	Marking
BWVF00252012R50□00	0.50	20, 30	1	0.028	3.50(3.15)	3.00(2.70)	B
BWVF002520121R0□00	1.0	20, 30	1	0.050	2.50(2.25)	2.40(2.16)	C
BWVF002520121R2□00	1.2	20, 30	1	0.053	2.10(1.89)	2.35(2.11)	D
BWVF002520121R5□00	1.5	20, 30	1	0.068	1.95(1.75)	2.30(2.07)	E
BWVF002520122R2□00	2.2	20, 30	1	0.080	1.80(1.62)	1.80(1.62)	F
BWVF002520123R3□00	3.3	20, 30	1	0.130	1.45(1.30)	1.50(1.35)	G
BWVF002520124R7□00	4.7	20, 30	1	0.190	1.10(0.99)	1.10(0.99)	H
BWVF002520125R6□00	5.6	20, 30	1	0.210	1.05(0.94)	1.00(0.90)	I
BWVF002520126R8□00	6.8	20, 30	1	0.300	0.95(0.85)	0.80(0.72)	J
BWVF00252012100□00	10	20, 30	1	0.385	0.88(0.79)	0.70(0.63)	K
BWVF00252012150□00	15	20, 30	1	0.570	0.68(0.61)	0.62(0.55)	L
BWVF00252012220□00	22	20, 30	1	0.810	0.55(0.49)	0.53(0.47)	M

**Note:** When ordering, please specify tolerance code. Tolerance: M=±20% , T =±30%

- Operating temperature range - 55°C ~ 125°C(Including self - temperature rise)
- Isat for Inductance drop 30% from its value without current
- Irms for a 40°C temperature rise from 25°C ambient with current
- Measure Equipment :  
 L : Agilent HP4287A+Agilent HP16197A, 1MHz 200mV  
 RDC : DIGITAL MILLINHM METER CHROMA 16502, or equivalent  
 Isat & Irms : Agilent HP4284A

**Test Instruments :** HP4284A Material/Impedance Analyzer

**Inductance vs. DC Current**

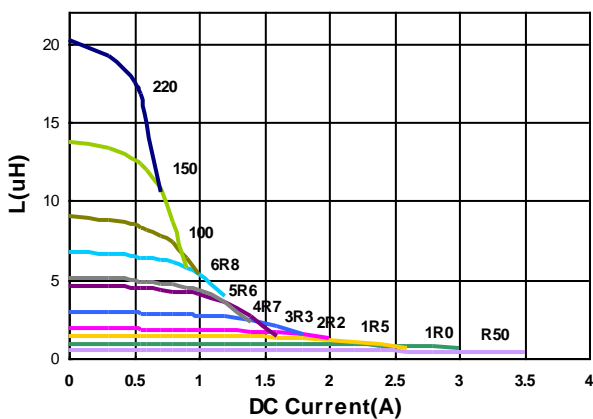

**Temperature Change vs. DC Current**

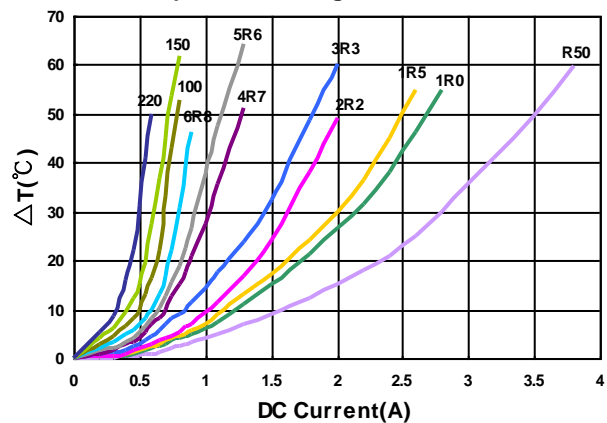

## Electrical Characteristics

Part Number	Inductance (uH)	Tolerance (±%)	Test Frequency (MHz)	RDC (Ω) ±30%	Isat (A) Typ. (Max)	Irms (A) Typ. (Max)	Marking
BWVF003030101R5□00	1.5	20, 30	1	0.085	1.80(1.62)	1.70(1.53)	1R5
BWVF003030102R2□00	2.2	20, 30	1	0.100	1.50(1.35)	1.40(1.26)	2R2
BWVF003030104R7□00	4.7	20, 30	1	0.205	1.00(0.90)	0.95(0.85)	4R7
BWVF003030106R8□00	6.8	20, 30	1	0.310	0.87(0.78)	0.85(0.76)	6R8
BWVF00303010100□00	10	20, 30	1	0.430	0.64(0.57)	0.63(0.56)	100
BWVF00303010150□00	15	20, 30	1	0.625	0.56(0.50)	0.55(0.49)	150
BWVF00303010220□00	22	20, 30	1	0.870	0.47(0.42)	0.46(0.41)	220
BWVF00303010470□00	47	20, 30	1	1.750	0.29(0.26)	0.28(0.25)	470

**Note: When ordering, please specify tolerance code. Tolerance: M=±20% , T =±30%**

- Operating temperature range - 55°C ~ 125°C(Including self - temperature rise)
- Isat for Inductance drop 30% from its value without current
- Irms for a 40°C temperature rise from 25°C ambient with current
- Measure Equipment :  
 L : Agilent HP4287A+Agilent HP16197A, 1MHz 200mV  
 RDC : DIGITAL MILLINHM METER CHROMA 16502, or equivalent  
 Isat & Irms : Agilent HP4284A

## Test Instruments : HP4284A Material/Impedance Analyzer

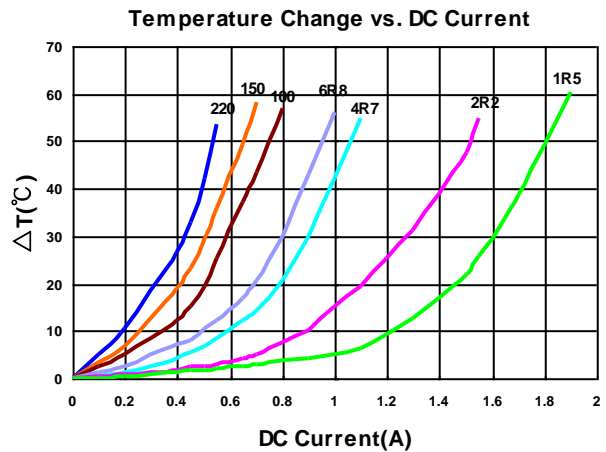
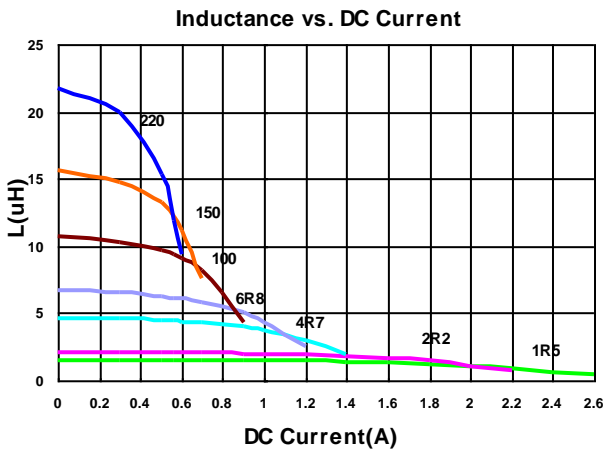

## Electrical Characteristics

Part Number	Inductance (uH)	Tolerance (±%)	Test Frequency (MHz)	RDC (Ω) ±30%	Isat (A) Typ. (Max)	Irms (A) Typ. (Max)	Marking
BWVF003030122R2□00	2.2	20, 30	1	0.092	2.10(1.89)	2.00(1.80)	2R2
BWVF003030123R3□00	3.3	20, 30	1	0.13	1.84(1.65)	1.80(1.62)	3R3
BWVF003030124R7□00	4.7	20, 30	1	0.18	1.56(1.40)	1.52(1.36)	4R7
BWVF003030126R8□00	6.8	20, 30	1	0.25	1.32(1.18)	1.30(1.17)	6R8
BWVF00303012100□00	10	20, 30	1	0.42	1.06(0.95)	1.00(0.90)	100
BWVF00303012150□00	15	20, 30	1	0.56	0.82(0.73)	0.80(0.72)	150
BWVF00303012220□00	22	20, 30	1	0.86	0.64(0.57)	0.62(0.55)	220
BWVF00303012470□00	47	20, 30	1	1.82	0.49(0.44)	0.43(0.38)	470

**Note: When ordering, please specify tolerance code. Tolerance: M=±20% , T =±30%**

- Operating temperature range - 55°C ~ 125°C(Including self - temperature rise)
- Isat for Inductance drop 30% from its value without current
- I rms for a 40°C temperature rise from 25°C ambient with current
- Measure Equipment :  
 L : Agilent HP4287A+Agilent HP16197A, 1MHz 200mV  
 RDC : DIGITAL MILLINHM METER CHROMA 16502, or equivalent  
 Isat & I rms : Agilent HP4284A

## Test Instruments : HP4284A Material/Impedance Analyzer

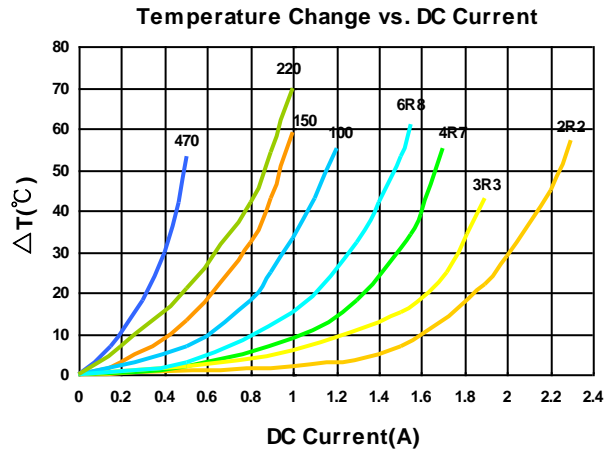
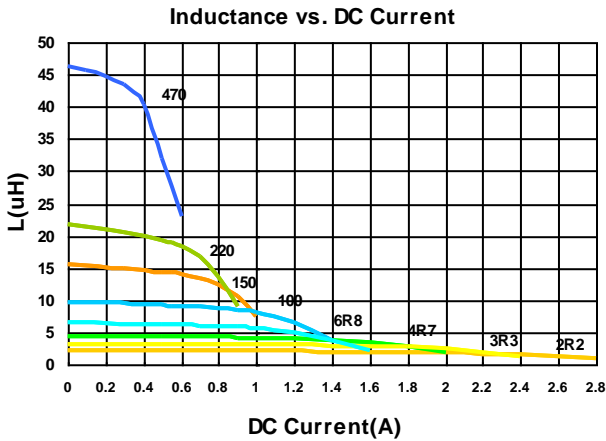

# Sealed Power Inductors – BWVF Series

## Electrical Characteristics

Part Number	Inductance (uH)	Tolerance (±%)	Test Frequency (MHz)	RDC (Ω) ±30%	Isat (A) Typ. (Max)	Irms (A) Typ. (Max)	Marking
BWVF00303015R47□00	0.47	20, 30	1	0.036	4.7(4.23)	4.0(3.60)	R47
BWVF003030151R0□00	1.0	20, 30	1	0.054	3.4(3.06)	3.0(2.70)	1R0
BWVF003030151R5□00	1.5	20, 30	1	0.063	3.0(2.70)	2.6(2.34)	1R5
BWVF003030152R2□00	2.2	20, 30	1	0.090	2.3(2.07)	2.0(1.80)	2R2
BWVF003030153R3□00	3.3	20, 30	1	0.125	1.9(1.71)	1.80(1.62)	3R3
BWVF003030154R7□00	4.7	20, 30	1	0.170	1.58(1.42)	1.52(1.36)	4R7
BWVF003030156R8□00	6.8	20, 30	1	0.235	1.34(1.20)	1.30(1.17)	6R8
BWVF00303015100□00	10	20, 30	1	0.360	1.06(0.95)	1.00(0.90)	100
BWVF00303015150□00	15	20, 30	1	0.550	0.90(0.81)	0.80(0.72)	150
BWVF00303015220□00	22	20, 30	1	0.770	0.76(0.68)	0.65(0.58)	220
BWVF00303015330□00	33	20, 30	1	0.930	0.65(0.58)	0.60(0.54)	330
BWVF00303015470□00	47	20, 30	1	1.500	0.52(0.46)	0.42(0.37)	470
BWVF00303015101□00	100	20, 30	1	2.700	0.36(0.32)	0.3(0.27)	101

**Note: When ordering, please specify tolerance code. Tolerance: M=±20% , T =±30%**

- Operating temperature range - 55°C ~ 125°C(Including self - temperature rise)
- Isat for Inductance drop 30% from its value without current
- Irms for a 40°C temperature rise from 25°C ambient with current
- Measure Equipment :  
 L : Agilent HP4287A+Agilent HP16197A, 1MHz 200mV  
 RDC : DIGITAL MILLINHM METER CHROMA 16502, or equivalent  
 Isat & Irms : Agilent HP4284A

## Test Instruments : HP4284A Material/Impedance Analyzer

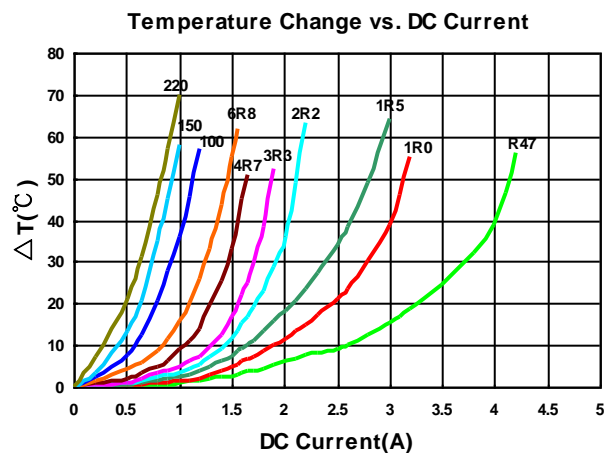
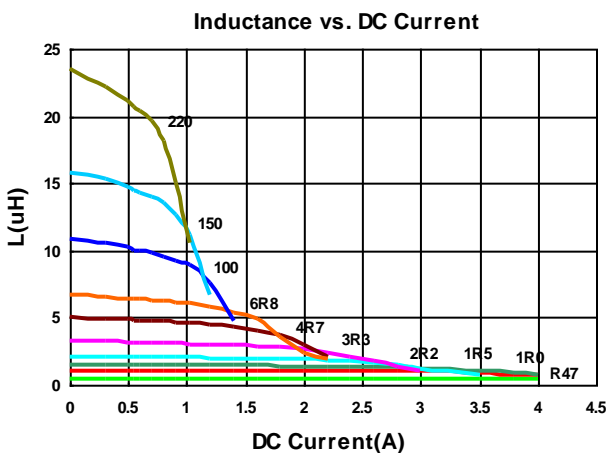



## Electrical Characteristics

Part Number	Inductance (uH)	Tolerance (±%)	Test Frequency (MHz)	RDC (Ω) ±30%	Isat (A) Typ. (Max)	Irms (A) Typ. (Max)	Marking
BWVF004040123R3□00	3.3	20, 30	1	0.072	1.52(1.36)	2.10(1.89)	3R3
BWVF00404012100□00	10	20, 30	1	0.190	0.90(0.81)	1.20(1.08)	100

**Note: When ordering, please specify tolerance code. Tolerance: M=±20% , T =±30%**

- Operating temperature range - 55°C ~ 125°C(Including self - temperature rise)
- Isat for Inductance drop 30% from its value without current
- Irms for a 40°C temperature rise from 25°C ambient with current
- Measure Equipment :  
 L : Agilent HP4284A+Agilent HP42841A.1MHz 200mV  
 RDC : DIGITAL MILLINHM METER CHROMA 16502, or equivalent  
 Isat & Irms : Agilent HP4284A

## Test Instruments : HP4284A Material/Impedance Analyzer

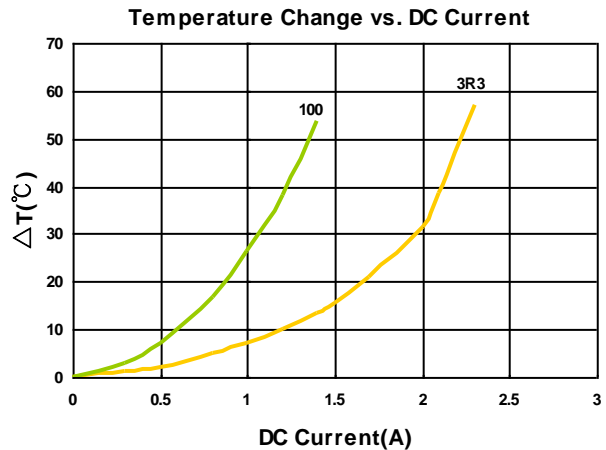
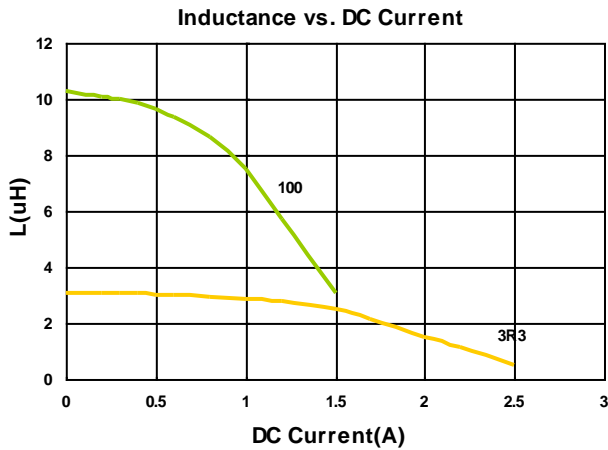

## Electrical Characteristics

Part Number	Inductance (uH)	Tolerance (±%)	Test Frequency (MHz)	RDC (Ω) ±30%	Isat (A) Typ. (Max)	Irms (A) Typ. (Max)	Marking
BWVF00404015R47□00	0.47	20, 30	1	0.019	4.00(3.60)	4.20(3.78)	R47
BWVF004040151R5□00	1.5	20, 30	1	0.041	3.00(2.70)	3.2(2.88)	1R5
BWVF004040152R2□00	2.2	20, 30	1	0.054	2.30(2.07)	2.60(2.34)	2R2
BWVF004040154R7□00	4.7	20, 30	1	0.100	1.60(1.44)	1.80(1.62)	4R7
BWVF004040156R8□00	6.8	20, 30	1	0.138	1.40(1.26)	1.60(1.44)	6R8
BWVF00404015100□00	10	20, 30	1	0.200	1.00(0.90)	1.20(1.08)	100
BWVF00404015150□00	15	20, 30	1	0.300	0.92(0.82)	1.05(0.94)	150
BWVF00404015220□00	22	20, 30	1	0.400	0.72(0.64)	0.85(0.76)	220

**Note: When ordering, please specify tolerance code. Tolerance: M=±20% , T =±30%**

- Operating temperature range - 55°C ~ 125°C(Including self - temperature rise)
- Isat for Inductance drop 30% from its value without current
- Irms for a 40°C temperature rise from 25°C ambient with current
- Measure Equipment :
  - L : Agilent HP4284A+Agilent HP42841A.1MHz 200mV
  - RDC : DIGITAL MILLINHM METER CHROMA 16502, or equivalent
  - Isat & Irms : Agilent HP4284A

## Test Instruments : HP4284A Material/Impedance Analyzer

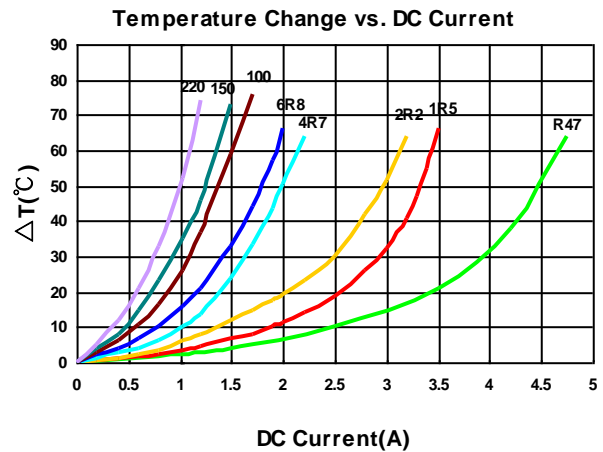
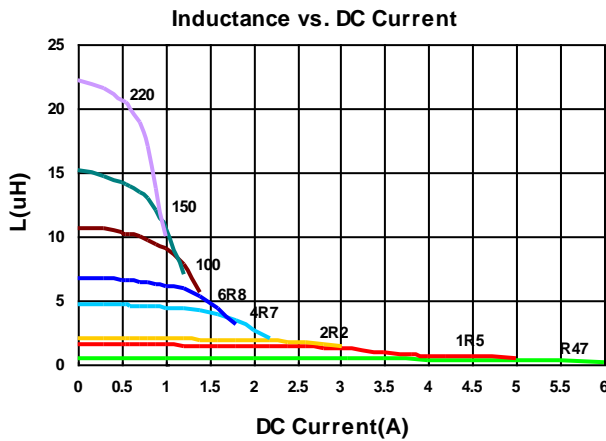

## Electrical Characteristics

Part Number	Inductance (uH)	Tolerance (±%)	Test Frequency (kHz)	RDC (Ω) ±30%	Isat (A) Typ. (Max)	Irms (A) Typ. (Max)	Marking
BWVF004040181R0□00	1.0	20, 30	100	0.0265	4.2(3.78)	3.8(3.42)	1R0
BWVF004040181R5□00	1.5	20, 30	100	0.0370	3.5(3.15)	3.2(2.88)	1R5
BWVF004040182R2□00	2.2	20, 30	100	0.0470	3.0(2.70)	2.7(2.43)	2R2
BWVF004040183R3□00	3.3	20, 30	100	0.0625	2.3(2.07)	2.1(1.89)	3R3
BWVF00404018220□00	22	20, 30	100	0.335	0.90(0.81)	0.88(0.79)	220

**Note: When ordering, please specify tolerance code. Tolerance: M=±20% , T =±30%**

- Operating temperature range - 55°C ~ 125°C(Including self - temperature rise)
- Isat for Inductance drop 30% from its value without current
- Irms for a 40°C temperature rise from 25°C ambient with current
- Measure Equipment :  
 L : Agilent HP4284A+Agilent HP42841A, 100kHz 1V  
 RDC : DIGITAL MILLINHM METER CHROMA 16502, or equivalent  
 Isat & Irms : Agilent HP4284A

## Test Instruments : HP4284A Material/Impedance Analyzer

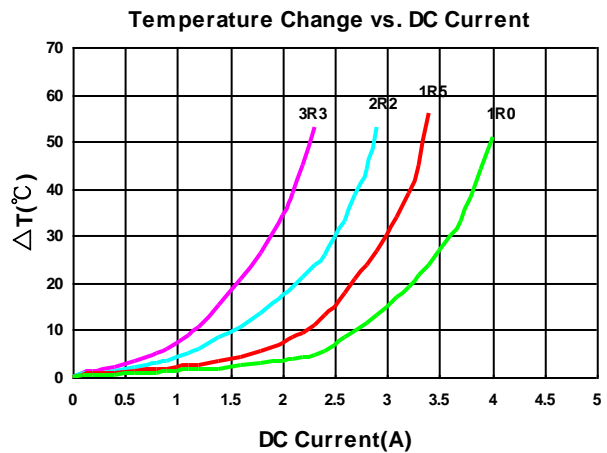
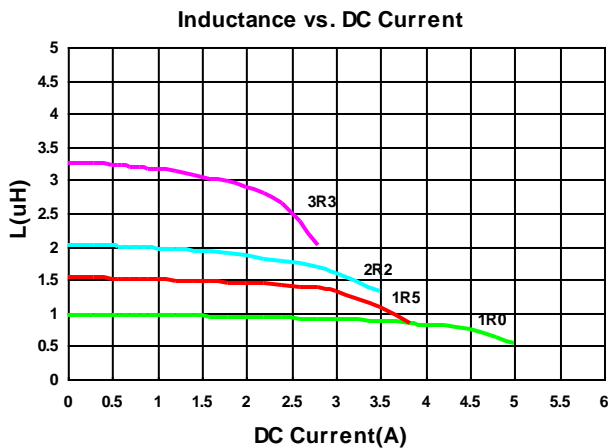

## Electrical Characteristics

Part Number	Inductance (uH)	Tolerance (±%)	Test Frequency (kHz)	RDC (Ω) ±30%	Isat (A) Typ. (Max)	Irms (A) Typ. (Max)	Marking
BWVF004040261R0□00	1.0	20, 30	100	0.030	5.00(4.50)	4.00(3.60)	1R0
BWVF004040261R5□00	1.5	20, 30	100	0.035	4.20(3.78)	3.70(3.33)	1R5
BWVF004040262R2□00	2.2	20, 30	100	0.045	3.80(3.42)	3.50(3.15)	2R2
BWVF004040263R3□00	3.3	20, 30	100	0.067	3.00(2.70)	2.50(2.25)	3R3
BWVF004040264R7□00	4.7	20, 30	100	0.092	2.60(2.34)	2.00(1.80)	4R7
BWVF004040265R6□00	5.6	20, 30	100	0.110	2.30(2.07)	1.90(1.71)	5R6
BWVF004040266R8□00	6.8	20, 30	100	0.130	2.00(1.80)	1.70(1.53)	6R8
BWVF00404026100□00	10	20, 30	100	0.188	1.90(1.71)	1.40(1.26)	100
BWVF00404026150□00	15	20, 30	100	0.240	1.45(1.30)	1.20(1.08)	150
BWVF00404026220□00	22	20, 30	100	0.330	1.22(1.09)	1.00(0.90)	220
BWVF00404026330□00	33	20, 30	100	0.480	1.00(0.90)	0.82(0.73)	330
BWVF00404026470□00	47	20, 30	100	0.735	0.88(0.79)	0.64(0.57)	470
BWVF00404026101□00	100	20, 30	100	1.380	0.58(0.52)	0.50(0.45)	101
BWVF00404026331□00	330	20, 30	100	4.600	0.31(0.27)	0.25(0.22)	331

**Note: When ordering, please specify tolerance code. Tolerance: M=±20% , T =±30%**

- Operating temperature range - 55°C ~ 125°C(Including self - temperature rise)
- Isat for Inductance drop 30% from its value without current
- Irms for a 40°C temperature rise from 25°C ambient with current
- Measure Equipment :
- L : Agilent HP4284A+Agilent HP42841A, 100kHz 1V
- RDC : DIGITAL MILLINHM METER CHROMA 16502, or equivalent
- Isat & Irms : Agilent HP4284A

**Test Instruments : HP4284A Material/Impedance Analyzer**

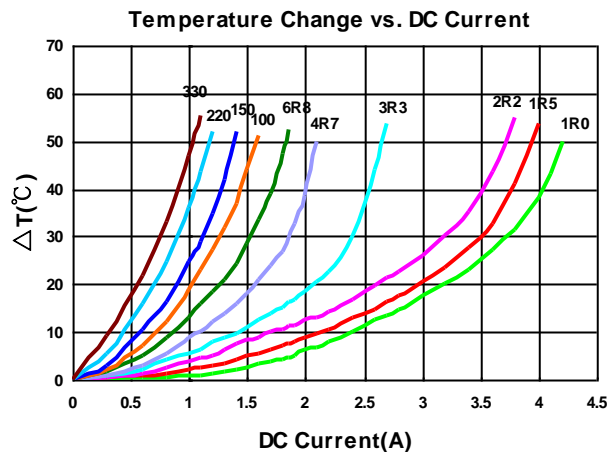
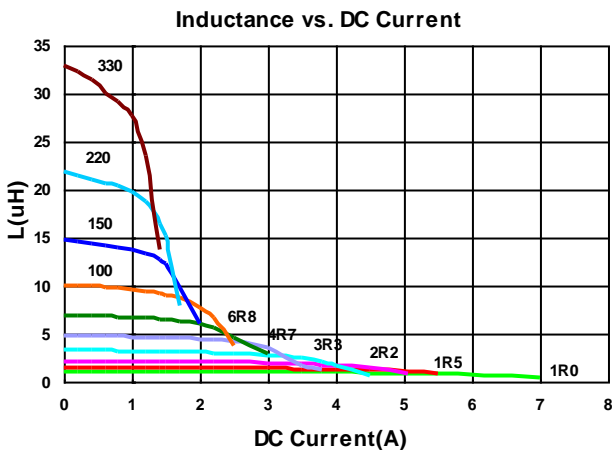

# Sealed Power Inductors – BWVF Series

## Electrical Characteristics

Part Number	Inductance (uH)	Tolerance (±%)	Test Frequency (kHz)	RDC (Ω) ±30%	Isat (A) Typ. (Max)	Irms (A) Typ. (Max)	Marking
BWVF005050201R0□00	1.0	20, 30	100	0.018	6.0(5.40)	4.1(3.69)	1R0
BWVF005050201R5□00	1.5	20, 30	100	0.023	4.9(4.41)	3.5(3.15)	1R5
BWVF005050201R8□00	1.8	20, 30	100	0.026	4.1(3.60)	3.4(3.00)	1R8
BWVF005050202R2□00	2.2	20, 30	100	0.030	4.0(3.60)	3.3(2.97)	2R2
BWVF005050203R6□00	3.6	20, 30	100	0.050	3.1(2.70)	2.7(2.40)	3R6
BWVF005050203R9□00	3.9	20, 30	100	0.053	2.9(2.61)	2.6(2.34)	3R9
BWVF005050204R7□00	4.7	20, 30	100	0.060	2.7(2.43)	2.2(1.98)	4R7
BWVF005050206R8□00	6.8	20, 30	100	0.093	2.2(1.98)	1.8(1.62)	6R8
BWVF00505020100□00	10	20, 30	100	0.125	1.8(1.62)	1.6(1.44)	100
BWVF00505020150□00	15	20, 30	100	0.195	1.4(1.26)	1.2(1.08)	150
BWVF00505020220□00	22	20, 30	100	0.265	1.2(1.08)	1.0(0.90)	220

**Note:** When ordering, please specify tolerance code. Tolerance: M=±20% , T =±30%

- Operating temperature range - 55°C ~ 125°C(Including self - temperature rise)
- Isat for Inductance drop 30% from its value without current
- Irms for a 40°C temperature rise from 25°C ambient with current
- Measure Equipment :
- L : Agilent HP4284A+Agilent HP42841A, 100kHz 1V  
RDC : DIGITAL MILLINHM METER CHROMA 16502, or equivalent  
Isat & Irms : Agilent HP4284A

## Test Instruments : HP4284A Material/Impedance Analyzer

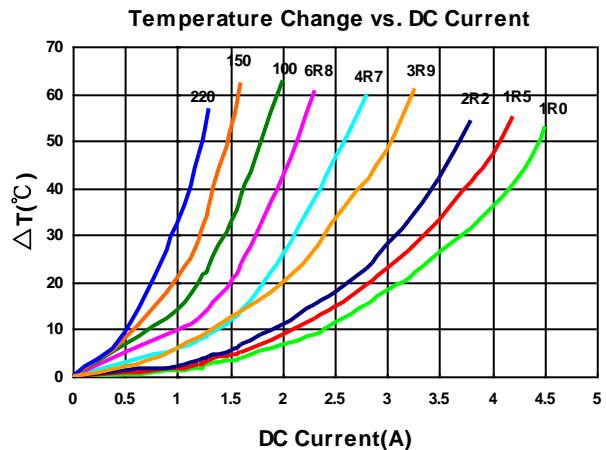
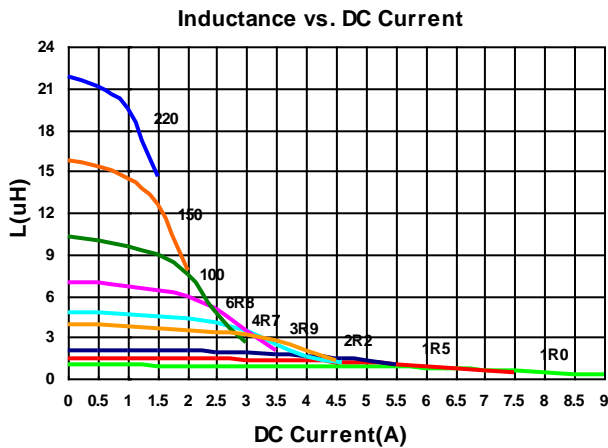

## Electrical Characteristics

Part Number	Inductance (uH)	Tolerance (±%)	Test Frequency (kHz)	RDC (Ω) ±30%	Isat (A) Typ. (Max)	Irms (A) Typ. (Max)	Marking
BWVF006060204R7□00	4.7	20, 30	100	0.058	3.0(2.70)	2.3(2.07)	4R7
BWVF00606020100□00	10	20, 30	100	0.130	2.1(1.89)	1.6(1.44)	100
BWVF00606020150□00	15	20, 30	100	0.195	1.6(1.44)	1.3(1.17)	150
BWVF00606020220□00	22	20, 30	100	0.260	1.3(1.17)	1.1(0.99)	220
BWVF00606020470□00	47	20, 30	100	0.510	0.9(0.80)	0.8(0.72)	470

**Note:** When ordering, please specify tolerance code. Tolerance: M=±20% , T =±30%

- Operating temperature range - 55°C ~ 125°C(Including self - temperature rise)
- Isat for Inductance drop 30% from its value without current
- Irms for a 40°C temperature rise from 25°C ambient with current
- Measure Equipment :
- L : Agilent HP4284A+Agilent HP42841A, 100kHz 1V
- RDC : DIGITAL MILLINHM METER CHROMA 16502, or equivalent
- Isat & Irms : Agilent HP4284A

## Test Instruments : HP4284A Material/Impedance Analyzer

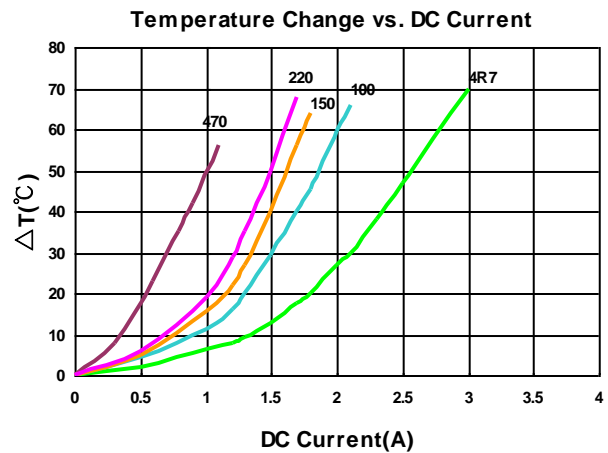
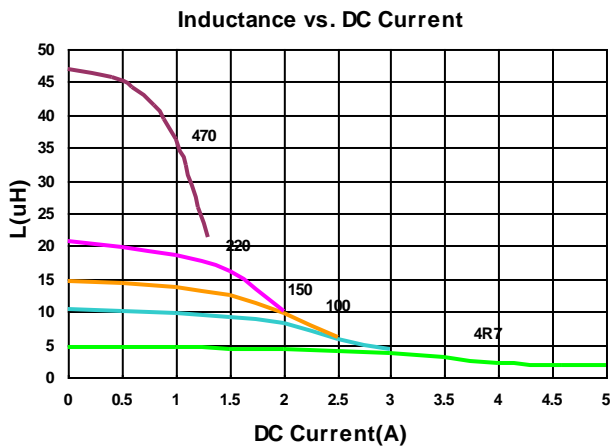

## Electrical Characteristics

Part Number	Inductance (uH)	Tolerance (±%)	Test Frequency (kHz)	RDC (Ω) ±30%	Isat (A) Typ. (Max)	Irms (A) Typ. (Max)	Marking
BWVF006060281R0□00	1.0	20, 30	100	0.012	7.9(7.11)	6.3(5.67)	1R0
BWVF006060281R5□00	1.5	20, 30	100	0.015	7.0(6.30)	5.5(4.95)	1R5
BWVF006060282R2□00	2.2	20, 30	100	0.020	6.0(5.40)	5.0(4.50)	2R2
BWVF006060284R7□00	4.7	20, 30	100	0.036	4.0(3.60)	3.4(3.06)	4R7
BWVF006060286R8□00	6.8	20, 30	100	0.048	3.2(2.88)	3.0(2.70)	6R8

**Note: When ordering, please specify tolerance code. Tolerance: M=±20% , T =±30%**

- Operating temperature range - 55°C ~ 125°C(Including self - temperature rise)
- Isat for Inductance drop 30% from its value without current
- Irms for a 40°C temperature rise from 25°C ambient with current
- Measure Equipment :
- L : Agilent HP4284A+Agilent HP42841A, 100kHz 1V
- RDC : DIGITAL MILLINHM METER CHROMA 16502, or equivalent
- Isat & Irms : Agilent HP4284A

## Test Instruments : HP4284A Material/Impedance Analyzer

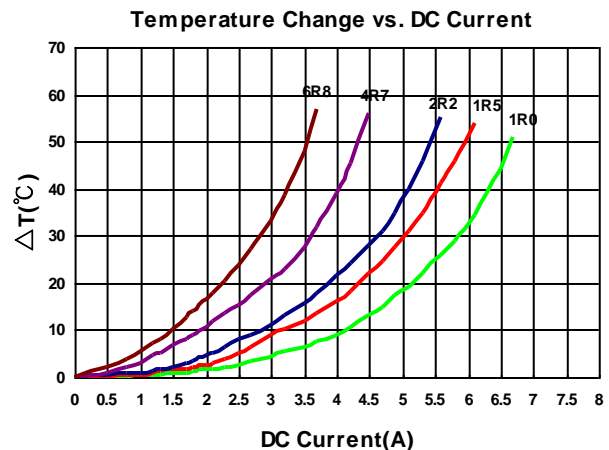
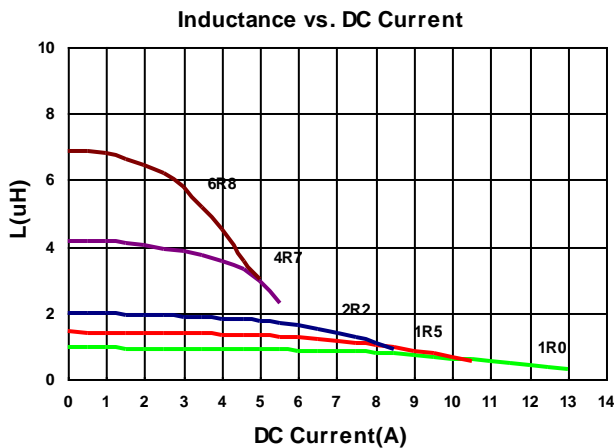

# Sealed Power Inductors – BWVF Series

## Electrical Characteristics

Part Number	Inductance (uH)	Tolerance (±%)	Test Frequency (kHz)	RDC (Ω) ±30%	Isat (A) Typ. (Max)	Irms (A) Typ. (Max)	Marking
BWVF008080404R7□00	4.7	20, 30	100	0.020	6.8(6.12)	5.5(4.95)	4R7
BWVF00808040100□00	10	20, 30	100	0.038	5.0(4.50)	3.8(3.42)	100
BWVF00808040150□00	15	20, 30	100	0.057	4.0(3.60)	3.2(2.88)	150
BWVF00808040220□00	22	20, 30	100	0.082	3.4(3.06)	2.7(2.43)	220

**Note:** When ordering, please specify tolerance code. Tolerance: M=±20% , T =±30%

- Operating temperature range - 55°C ~ 125°C(Including self - temperature rise)
- Isat for Inductance drop 30% from its value without current
- I rms for a 40°C temperature rise from 25°C ambient with current
- Measure Equipment :
- L : Agilent HP4284A+Agilent HP42841A, 100kHz 1V  
RDC : DIGITAL MILLINHM METER CHROMA 16502, or equivalent  
Isat & I rms : Agilent HP4284A

**Test Instruments :** HP4284A Material/Impedance Analyzer

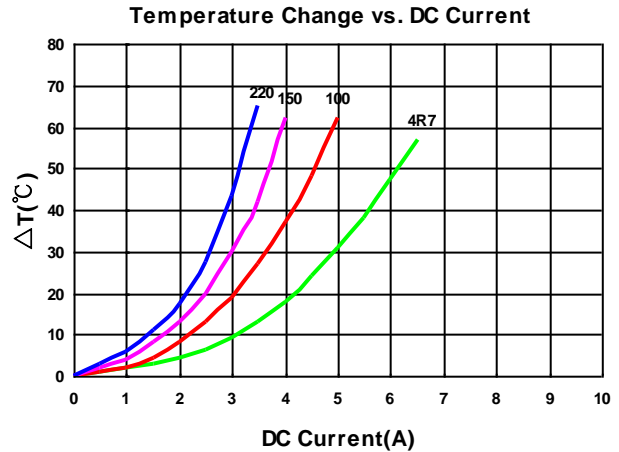
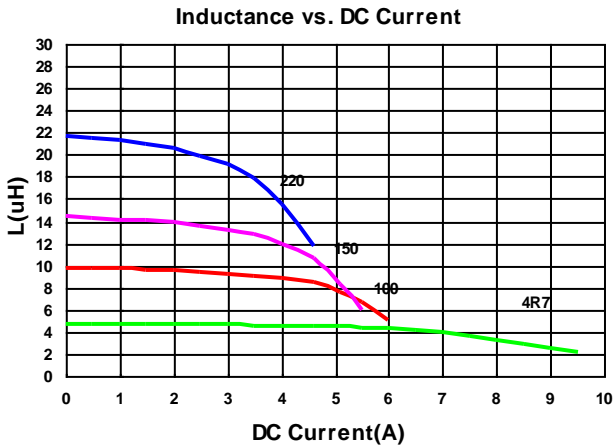



# Sealed Power Inductors – BWVF Series

## Packaging Specifications

Tape Dimensions

Figure 1

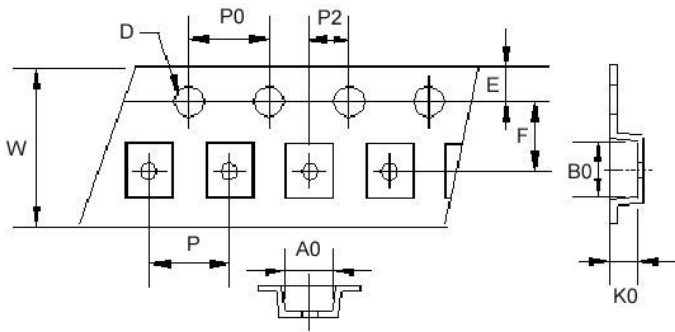

Tape Dimensions

Figure 2

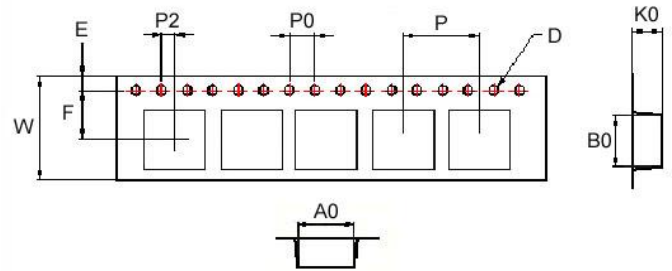

Reel Dimensions

Figure 1

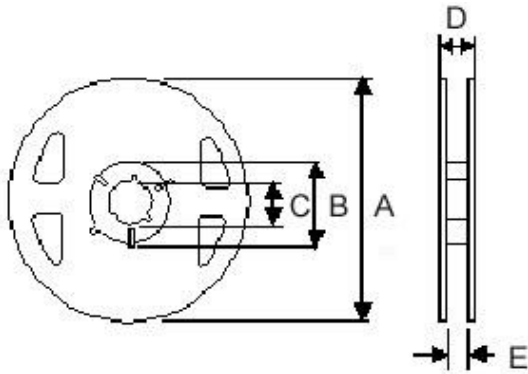

Reel Dimensions

Figure 2

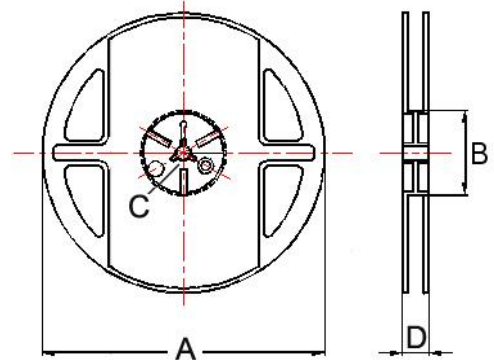

### Dimensions in mm

TYPE	Fig	Tape Dimensions										Reel Dimensions					Quantity PCS / Reel
		A0	B0	K0	D	E	F	W	P	P0	P2	A	B	C	D	E	
BWVF00201B12	1	1.90	2.20	1.30	1.55	1.75	3.5	8	4	4	2	180	60	13	14.4	8.4	2000
BWVF00252A10	1	2.40	2.70	1.15	1.55	1.75	3.5	8	4	4	2	180	60	13	14.4	8.4	2000
BWVF00252A12	1	2.40	2.70	1.35	1.55	1.75	3.5	8	4	4	2	180	60	13	14.4	8.4	2000
BWVF00303010	1	3.20	3.20	1.40	1.55	1.75	3.5	8	4	4	2	180	60	13	14.4	8.4	2000
BWVF00303012	1	3.20	3.20	1.40	1.55	1.75	3.5	8	4	4	2	180	60	13	14.4	8.4	2000
BWVF00303015	1	3.15	3.15	1.60	1.55	1.75	3.5	8	4	4	2	180	60	13	14.4	8.4	2000
BWVF00404012	2	4.25	4.25	1.30	1.55	1.75	5.5	12	8	4	2	178	60	13	13.2	-	1000
BWVF00404015	2	4.25	4.25	1.70	1.55	1.75	5.5	12	8	4	2	178	60	13	13.2	-	1000
BWVF00404018	2	4.25	4.25	2.10	1.55	1.75	5.5	12	8	4	2	178	60	13	13.2	-	800
BWVF00404026	2	4.25	4.25	3.00	1.55	1.75	5.5	12	8	4	2	178	60	13	13.2	-	500
BWVF00505020	2	5.25	5.25	2.20	1.55	1.75	5.5	12	8	4	2	330	100	13	13.4	-	2000
BWVF00606020	2	6.25	6.25	2.20	1.55	1.75	7.5	16	12	4	2	330	100	13	16.0	-	2000
BWVF00606028	2	6.25	6.25	3.00	1.55	1.75	7.5	16	12	4	2	330	100	13	16.0	-	1500
BWVF00808040	2	8.25	8.25	4.15	1.55	1.75	7.5	16	12	4	2	330	100	13	16.0	-	1000

单击下面可查看定价，库存，交付和生命周期等信息

[>>CHILISIN\(奇力新\)](#)

## X-ON Electronics

Largest Supplier of Electrical and Electronic Components

*Click to view similar products for [Fixed Inductors](#) category:*

*Click to view products by [Chilisin](#) manufacturer:*

Other Similar products are found below :

[CR32NP-100KC](#) [70F224AI](#) [MHQ1005P10NJ](#) [MHQ1005P1N0S](#) [MHQ1005P2N4S](#) [MHQ1005P3N6S](#) [MHQ1005P5N1S](#) [MHQ1005P8N2J](#)  
[PE-53601NL](#) [PE-53602NL](#) [PG0936.113NLT](#) [9220-20](#) [9310-16](#) [PM06-2N7](#) [PM06-39NJ](#) [A01TK](#) [1206CS-471XJ](#) [HC2-R47-R](#) [HC8-1R2-R](#)  
[HCF1305-3R3-R](#) [1206CS-151XG](#) [RCH664NP-4R7M](#) [RCP1317NP-391L](#) [DH2280-4R7M](#) [DS1608C-106](#) [B10TJ](#) [B82498B3101J000](#) [ELJ-](#)  
[RE27NJF2](#) [1812CS-153XJ](#) [1812CS-183XJ](#) [1812CS-223XJ](#) [1812LS-104XJ](#) [1812LS-105XJ](#) [1812LS-124XJ](#) [1812LS-154XJ](#) [1812LS-223XJ](#)  
[1812LS-224XJ](#) [1812LS-563XJ](#) [1812LS-683XJ](#) [1812LS-824XJ](#) [NIN-FB101JTR110F](#) [NIN-FB471JTR62F](#) [NIN-FC1R5JTR220F](#) [NIN-](#)  
[HCR15JTRF](#) [NIN-HCR33JTRF](#) [NIN-HDR22JTRF](#) [NIN-HDR82JTRF](#) [NIN-HK2N7STRF](#) [NIN-PA150KTR370F](#) [NIN-PB100KTR550F](#)