

## Cautions and Warnings

Please be noted that this spec is only for reference if you have projects designed with the product number listed in. If you are looking for new project design-in, please find BSCQ Series specification/datasheet on Chilisin website. Or you may find our sales contact for more information on old part number at your convenience. Appreciated your attention and understanding.

**Note:** Please be sure to request approval specifications that provide further details of the products. Kindly note that the content of these specifications are subject to change or may be discontinued without prior notice. This product may not be designed/used in medical or high risk applications without Chilisin approval. Please contact our sales department before ordering.

## CHQ Series



CHQ Series supports miniaturized devices. Its low inductance, high precision and high Q enables easy impedance matching at both RF and IF circuits and compact high frequency circuit designing.

### Features

- Excellent high frequency application
- High Q factor and SRF value
- Miniaturization
- Tight tolerance
- Wide inductance range

### Applications

- RF matching circuit requiring Q value
- Bluetooth, WLAN, UWB, digital TV tuners and high-frequency circuit and module

### Product Identification

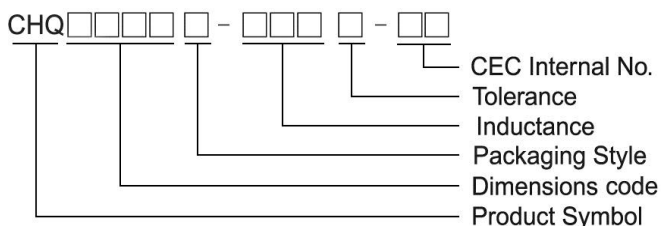

### Shape and Dimensions

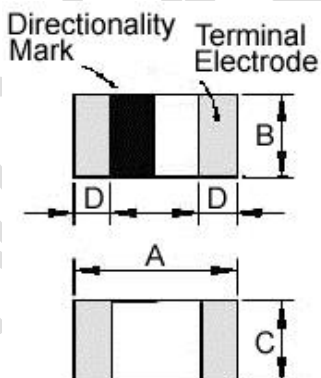

Dimensions in mm

| TYPE    | A        | B        | C        | D         |
|---------|----------|----------|----------|-----------|
| CHQ0603 | 0.6±0.03 | 0.3±0.03 | 0.3±0.03 | 0.15±0.05 |
| CHQ1005 | 1.0±0.10 | 0.5±0.10 | 0.5±0.10 | 0.25±0.10 |

### Recommended Pattern

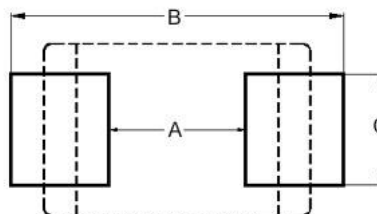

Dimensions in mm

| TYPE    | A   | B           | C   |
|---------|-----|-------------|-----|
| CHQ0603 | 0.3 | 0.75 ~ 1.05 | 0.3 |
| CHQ1005 | 0.4 | 1.2 ~ 1.4   | 0.5 |

# SMD Ceramic Multilayer Chip Inductors – CHQ Series

## Electrical Characteristics

| Part Number      | Inductance<br>(nH) | Tolerance<br>(±%)    | Q<br>Min | Test<br>Frequency<br>(MHz) | Q Typical  |            |            |            |            | SRF<br>(MHz)<br>Min | RDC<br>(Ω) Max | IDC<br>(mA) Max |
|------------------|--------------------|----------------------|----------|----------------------------|------------|------------|------------|------------|------------|---------------------|----------------|-----------------|
|                  |                    |                      |          |                            | 500<br>MHz | 800<br>MHz | 1.8<br>GHz | 2.0<br>GHz | 2.4<br>GHz |                     |                |                 |
| CHQ0603T-0N6□-HU | 0.6                | ±0.1nH/±0.2nH/±0.3nH | 14       | 500                        | >35        | >47        | >75        | >80        | >88        | 10000               | 0.06           | 900             |
| CHQ0603T-0N7□-HU | 0.7                | ±0.1nH/±0.2nH/±0.3nH | 14       | 500                        | >35        | >47        | >75        | >80        | >88        | 10000               | 0.06           | 900             |
| CHQ0603T-0N8□-HU | 0.8                | ±0.1nH/±0.2nH/±0.3nH | 14       | 500                        | >35        | >47        | >75        | >80        | >88        | 10000               | 0.06           | 900             |
| CHQ0603T-0N9□-HU | 0.9                | ±0.1nH/±0.2nH/±0.3nH | 14       | 500                        | >35        | >47        | >75        | >80        | >88        | 10000               | 0.06           | 900             |
| CHQ0603T-1N0□-HU | 1.0                | ±0.1nH/±0.2nH/±0.3nH | 14       | 500                        | >35        | >47        | >75        | >80        | >88        | 10000               | 0.07           | 850             |
| CHQ0603T-1N1□-HU | 1.1                | ±0.1nH/±0.2nH/±0.3nH | 14       | 500                        | >35        | >47        | >75        | >80        | >88        | 10000               | 0.07           | 850             |
| CHQ0603T-1N2□-HU | 1.2                | ±0.1nH/±0.2nH/±0.3nH | 14       | 500                        | 35         | 47         | 75         | 80         | 88         | 10000               | 0.08           | 800             |
| CHQ0603T-1N3□-HU | 1.3                | ±0.1nH/±0.2nH/±0.3nH | 14       | 500                        | 32         | 43         | 70         | 74         | 82         | 10000               | 0.09           | 760             |
| CHQ0603T-1N4□-HU | 1.4                | ±0.1nH/±0.2nH/±0.3nH | 14       | 500                        | 29         | 39         | 63         | 67         | 75         | 10000               | 0.12           | 640             |
| CHQ0603T-1N5□-HU | 1.5                | ±0.1nH/±0.2nH/±0.3nH | 14       | 500                        | 27         | 36         | 59         | 62         | 69         | 10000               | 0.15           | 600             |
| CHQ0603T-1N6□-HU | 1.6                | ±0.1nH/±0.2nH/±0.3nH | 14       | 500                        | 25         | 33         | 54         | 57         | 63         | 10000               | 0.19           | 510             |
| CHQ0603T-1N7□-HU | 1.7                | ±0.1nH/±0.2nH/±0.3nH | 14       | 500                        | 25         | 32         | 52         | 54         | 61         | 10000               | 0.11           | 680             |
| CHQ0603T-1N8□-HU | 1.8                | ±0.1nH/±0.2nH/±0.3nH | 14       | 500                        | 25         | 32         | 51         | 53         | 59         | 10000               | 0.12           | 640             |
| CHQ0603T-1N9□-HU | 1.9                | ±0.1nH/±0.2nH/±0.3nH | 14       | 500                        | 24         | 31         | 50         | 53         | 58         | 10000               | 0.13           | 620             |
| CHQ0603T-2N0□-HU | 2.0                | ±0.1nH/±0.2nH/±0.3nH | 14       | 500                        | 24         | 31         | 50         | 53         | 58         | 10000               | 0.15           | 600             |
| CHQ0603T-2N1□-HU | 2.1                | ±0.1nH/±0.2nH/±0.3nH | 14       | 500                        | 24         | 31         | 50         | 53         | 58         | 10000               | 0.16           | 550             |
| CHQ0603T-2N2□-HU | 2.2                | ±0.1nH/±0.2nH/±0.3nH | 14       | 500                        | 24         | 31         | 50         | 53         | 58         | 10000               | 0.20           | 500             |
| CHQ0603T-2N3□-HU | 2.3                | ±0.1nH/±0.2nH/±0.3nH | 14       | 500                        | 24         | 31         | 49         | 52         | 58         | 10000               | 0.24           | 460             |
| CHQ0603T-2N4□-HU | 2.4                | ±0.1nH/±0.2nH/±0.3nH | 14       | 500                        | 22         | 28         | 45         | 48         | 53         | 10000               | 0.26           | 430             |
| CHQ0603T-2N5□-HU | 2.5                | ±0.1nH/±0.2nH/±0.3nH | 14       | 500                        | 22         | 29         | 46         | 49         | 54         | 10000               | 0.28           | 415             |
| CHQ0603T-2N6□-HU | 2.6                | ±0.1nH/±0.2nH/±0.3nH | 14       | 500                        | 21         | 27         | 44         | 46         | 51         | 10000               | 0.30           | 405             |
| CHQ0603T-2N7□-HU | 2.7                | ±0.1nH/±0.2nH/±0.3nH | 14       | 500                        | 20         | 26         | 41         | 43         | 48         | 10000               | 0.32           | 400             |
| CHQ0603T-2N8□-HU | 2.8                | ±0.1nH/±0.2nH/±0.3nH | 14       | 500                        | 20         | 26         | 41         | 43         | 47         | 9500                | 0.20           | 500             |
| CHQ0603T-2N9□-HU | 2.9                | ±0.1nH/±0.2nH/±0.3nH | 14       | 500                        | 20         | 26         | 41         | 43         | 47         | 9300                | 0.22           | 480             |
| CHQ0603T-3N0□-HU | 3.0                | ±0.1nH/±0.2nH/±0.3nH | 14       | 500                        | 20         | 26         | 41         | 43         | 47         | 9100                | 0.24           | 460             |
| CHQ0603T-3N1□-HU | 3.1                | ±0.1nH/±0.2nH/±0.3nH | 14       | 500                        | 20         | 26         | 41         | 43         | 47         | 8900                | 0.25           | 450             |
| CHQ0603T-3N2□-HU | 3.2                | ±0.1nH/±0.2nH/±0.3nH | 14       | 500                        | 20         | 26         | 40         | 43         | 47         | 8700                | 0.28           | 415             |
| CHQ0603T-3N3□-HU | 3.3                | ±0.1nH/±0.2nH/±0.3nH | 14       | 500                        | 20         | 26         | 40         | 43         | 47         | 8600                | 0.28           | 415             |
| CHQ0603T-3N4□-HU | 3.4                | ±0.1nH/±0.2nH/±0.3nH | 14       | 500                        | 20         | 25         | 40         | 43         | 47         | 8400                | 0.29           | 410             |
| CHQ0603T-3N5□-HU | 3.5                | ±0.1nH/±0.2nH/±0.3nH | 14       | 500                        | 20         | 25         | 40         | 42         | 46         | 8200                | 0.30           | 405             |
| CHQ0603T-3N6□-HU | 3.6                | ±0.1nH/±0.2nH/±0.3nH | 14       | 500                        | 19         | 25         | 40         | 42         | 46         | 8100                | 0.32           | 400             |
| CHQ0603T-3N7□-HU | 3.7                | ±0.1nH/±0.2nH/±0.3nH | 14       | 500                        | 19         | 25         | 40         | 42         | 46         | 8000                | 0.36           | 370             |
| CHQ0603T-3N8□-HU | 3.8                | ±0.1nH/±0.2nH/±0.3nH | 14       | 500                        | 19         | 25         | 39         | 41         | 45         | 7800                | 0.40           | 355             |
| CHQ0603T-3N9□-HU | 3.9                | ±0.1nH/±0.2nH/±0.3nH | 14       | 500                        | 19         | 25         | 39         | 41         | 45         | 7700                | 0.41           | 350             |
| CHQ0603T-4N3□-HU | 4.3                | ±0.2nH/±0.3nH        | 14       | 500                        | 18         | 24         | 37         | 39         | 43         | 6500                | 0.48           | 320             |
| CHQ0603T-4N7□-HU | 4.7                | ±0.2nH/±0.3nH        | 14       | 500                        | 19         | 24         | 37         | 39         | 42         | 6400                | 0.42           | 350             |
| CHQ0603T-5N1□-HU | 5.1                | ±0.2nH/±0.3nH        | 14       | 500                        | 19         | 24         | 37         | 39         | 42         | 6100                | 0.45           | 330             |
| CHQ0603T-5N6□-HU | 5.6                | ±0.2nH/±0.3nH        | 14       | 500                        | 18         | 24         | 36         | 37         | 41         | 5500                | 0.47           | 325             |
| CHQ0603T-6N2□-HU | 6.2                | ±0.2nH/±0.3nH        | 14       | 500                        | 18         | 23         | 35         | 36         | 39         | 5100                | 0.52           | 305             |
| CHQ0603T-6N8□-HU | 6.8                | 3 / 5                | 14       | 500                        | 18         | 23         | 35         | 36         | 39         | 4800                | 0.55           | 305             |
| CHQ0603T-7N5□-HU | 7.5                | 3 / 5                | 14       | 500                        | 18         | 23         | 34         | 35         | 38         | 4600                | 0.55           | 305             |
| CHQ0603T-8N2□-HU | 8.2                | 3 / 5                | 14       | 500                        | 17         | 22         | 33         | 34         | 36         | 4300                | 0.57           | 290             |
| CHQ0603T-9N1□-HU | 9.1                | 3 / 5                | 14       | 500                        | 17         | 22         | 33         | 34         | 36         | 4000                | 0.65           | 270             |
| CHQ0603T-10N□-HU | 10                 | 3 / 5                | 14       | 500                        | 17         | 22         | 33         | 34         | 36         | 3800                | 0.85           | 230             |
| CHQ0603T-12N□-HU | 12                 | 3 / 5                | 14       | 500                        | 17         | 22         | 31         | 32         | 33         | 3300                | 0.85           | 230             |
| CHQ0603T-15N□-HU | 15                 | 3 / 5                | 14       | 500                        | 17         | 21         | 28         | 29         | 29         | 2600                | 0.89           | 220             |
| CHQ0603T-18N□-HU | 18                 | 3 / 5                | 14       | 500                        | 16         | 21         | 26         | 26         | 25         | 2300                | 1.05           | 205             |
| CHQ0603T-22N□-HU | 22                 | 3 / 5                | 14       | 500                        | 16         | 21         | 26         | 26         | 24         | 1900                | 1.29           | 190             |

**Note:** When ordering, please specify tolerance code. Tolerance : B=±0.1nH , C=±0.2nH , S=±0.3nH , H=±3% , J=±5%

- Operating temperature range - 55°C ~ 125°C(Including self - temperature rise)
- IDC : Applied the current to coils, the inductance shall be less than 10% initial value
- Residual impedance of short chip : 0.48nH
- Measure Equipment :

L & Q : Agilent E4991A+Agilent 16197A

SRF : Agilent E4991A or HP19196C

RDC : HP4338B or CHEN HWA 502

# SMD Ceramic Multilayer Chip Inductors – CHQ Series

Test Instruments : Agilent E4991A Material/Impedance Analyzer

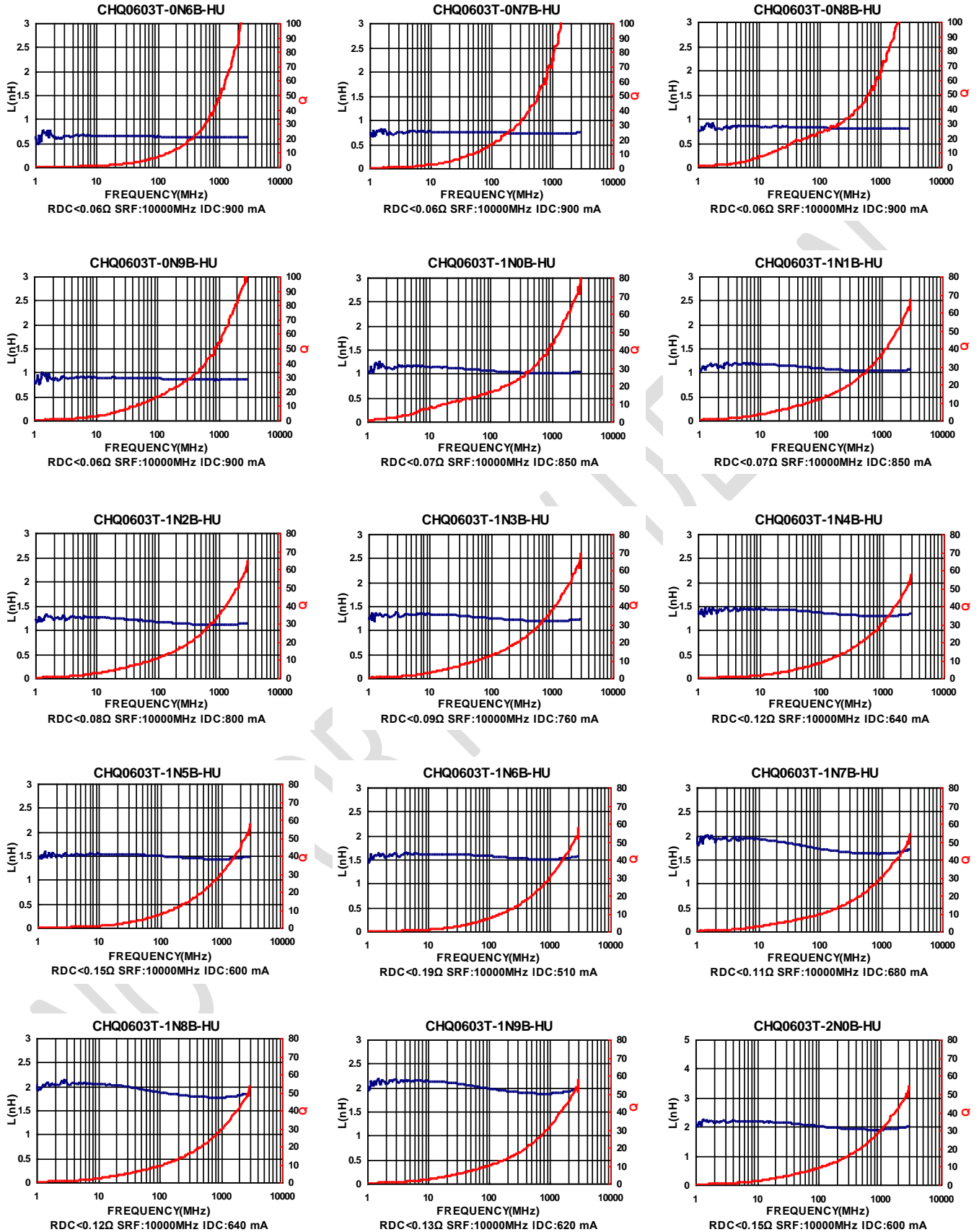

Please be sure to request approval specifications that provide further details of the products. Kindly note that the content of these specifications are subject to change or may be discontinued without prior notice. This product may not be designed/used in medical or high risk applications without Chilisin approval. Please contact our sales department before ordering.

# SMD Ceramic Multilayer Chip Inductors – CHQ Series

Test Instruments : Agilent E4991A Material/Impedance Analyzer

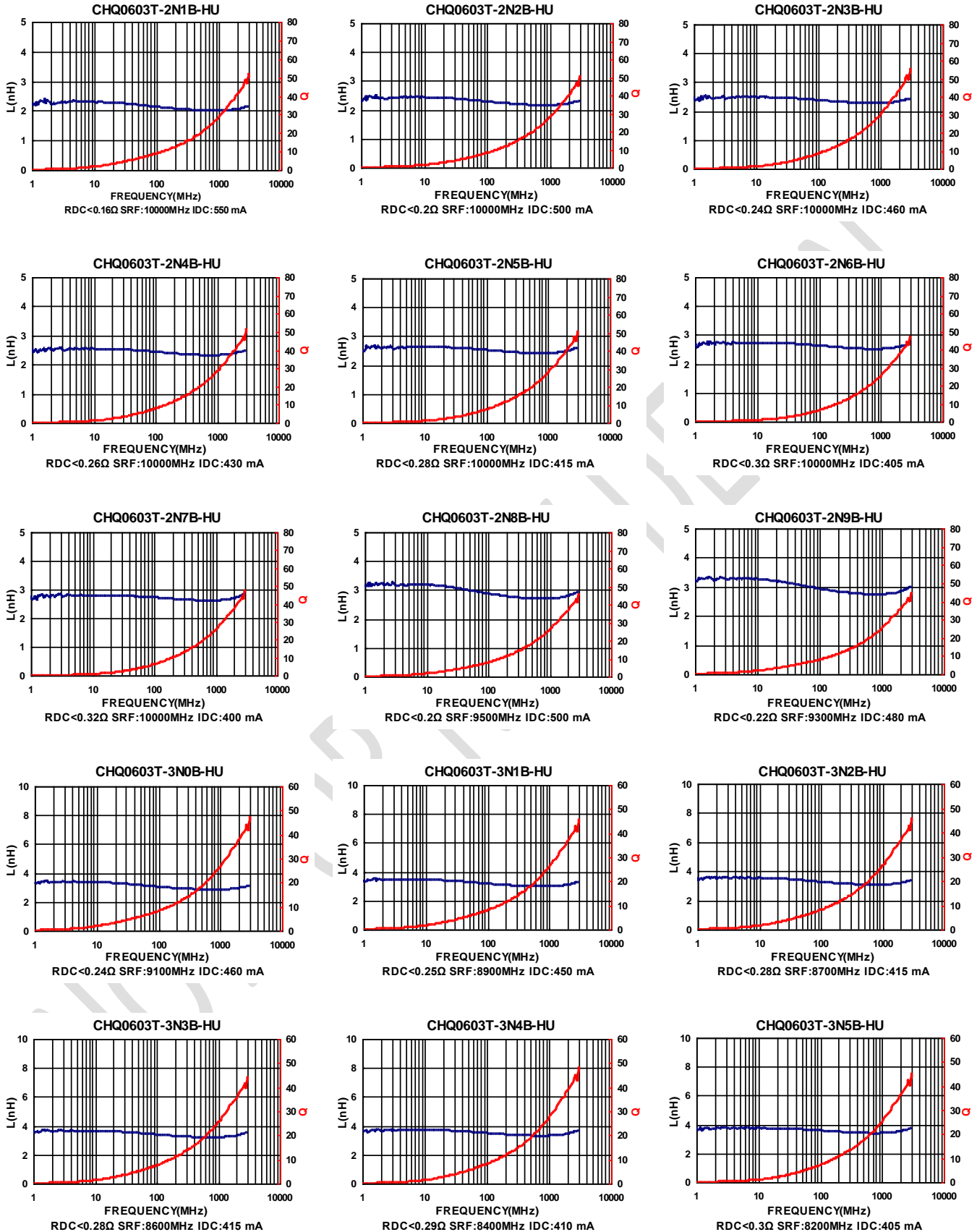

Please be sure to request approval specifications that provide further details of the products. Kindly note that the content of these specifications are subject to change or may be discontinued without prior notice. This product may not be designed/used in medical or high risk applications without Chilisin approval. Please contact our sales department before ordering.

# SMD Ceramic Multilayer Chip Inductors – CHQ Series

Test Instruments : Agilent E4991A Material/Impedance Analyzer

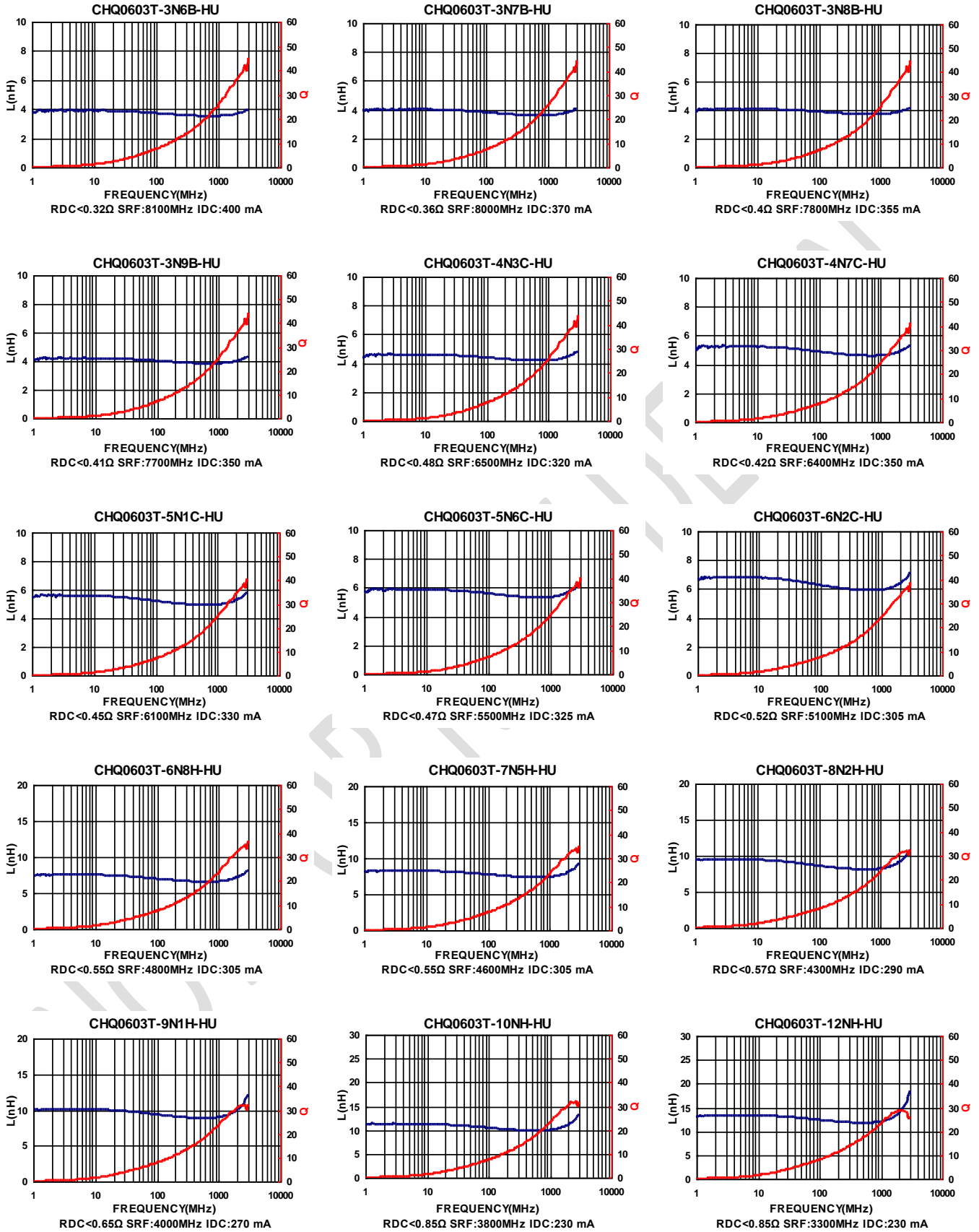

Please be sure to request approval specifications that provide further details of the products. Kindly note that the content of these specifications are subject to change or may be discontinued without prior notice. This product may not be designed/used in medical or high risk applications without Chilisin approval. Please contact our sales department before ordering.

Test Instruments : Agilent E4991A Material/Impedance Analyzer

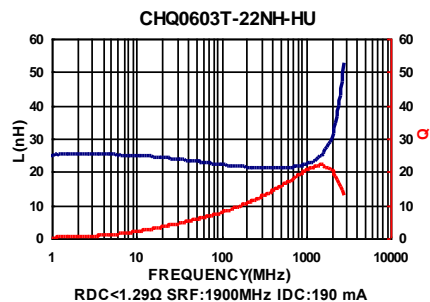
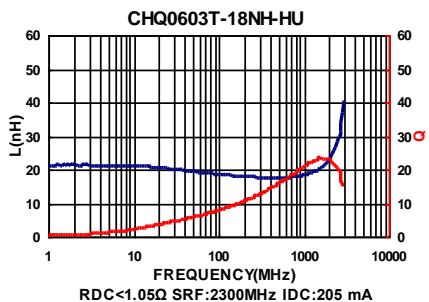
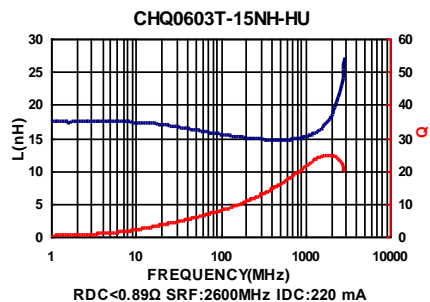

# SMD Ceramic Multilayer Chip Inductors – CHQ Series

## Electrical Characteristics

| Part Number        | Inductance (nH) | Tolerance (±%) | Test Frequency (MHz) | Q          |            | SRF (MHz) Min | RDC (Ω) Max | IDC (mA) Max |
|--------------------|-----------------|----------------|----------------------|------------|------------|---------------|-------------|--------------|
|                    |                 |                |                      | Min 100MHz | Typ 250MHz |               |             |              |
| CHQ1005T-1N0□-S-NP | 1.0             | ±0.3nH         | 100                  | 8          | 23         | 10000         | 0.07        | 710          |
| CHQ1005T-1N2□-S-NP | 1.2             | ±0.3nH         | 100                  | 8          | 23         | 10000         | 0.07        | 710          |
| CHQ1005T-1N5□-S-NP | 1.5             | ±0.3nH         | 100                  | 8          | 20         | 8000          | 0.07        | 710          |
| CHQ1005T-1N8□-S-NP | 1.8             | ±0.3nH         | 100                  | 8          | 20         | 6000          | 0.07        | 710          |
| CHQ1005T-2N0□-S-NP | 2.0             | ±0.3nH         | 100                  | 8          | 20         | 6000          | 0.08        | 660          |
| CHQ1005T-2N2□-S-NP | 2.2             | ±0.3nH         | 100                  | 8          | 20         | 6000          | 0.08        | 660          |
| CHQ1005T-2N4□-S-NP | 2.4             | ±0.3nH         | 100                  | 8          | 18         | 6000          | 0.09        | 630          |
| CHQ1005T-2N7□-S-NP | 2.7             | ±0.3nH         | 100                  | 8          | 18         | 6000          | 0.09        | 630          |
| CHQ1005T-3N0□-S-NP | 3.0             | ±0.3nH         | 100                  | 8          | 18         | 6000          | 0.11        | 570          |
| CHQ1005T-3N3□-S-NP | 3.3             | ±0.3nH         | 100                  | 8          | 18         | 6000          | 0.12        | 540          |
| CHQ1005T-3N6□-S-NP | 3.6             | ±0.3nH         | 100                  | 8          | 18         | 5000          | 0.14        | 500          |
| CHQ1005T-3N9□-S-NP | 3.9             | ±0.3nH         | 100                  | 8          | 18         | 4000          | 0.15        | 490          |

**Note:** When ordering, please specify tolerance code. Tolerance : S=±0.3nH

- Operating temperature range - 55°C ~ 125°C(Including self - temperature rise)
- IDC : Applied the current to coils, the inductance shall be less than 10% initial value
- Residual impedance of short chip : 0.19nH(Inductance ≤ 4.3nH) or 0.48nH(Inductance > 4.3nH)
- Measure Equipment :  
L & Q : Agilent E4991A+Agilent 16197A  
SRF : Agilent E4991A or HP19196C  
RDC : HP4338B or CHEN HWA 502

**Test Instruments :** Agilent E4991A Material/Impedance Analyzer

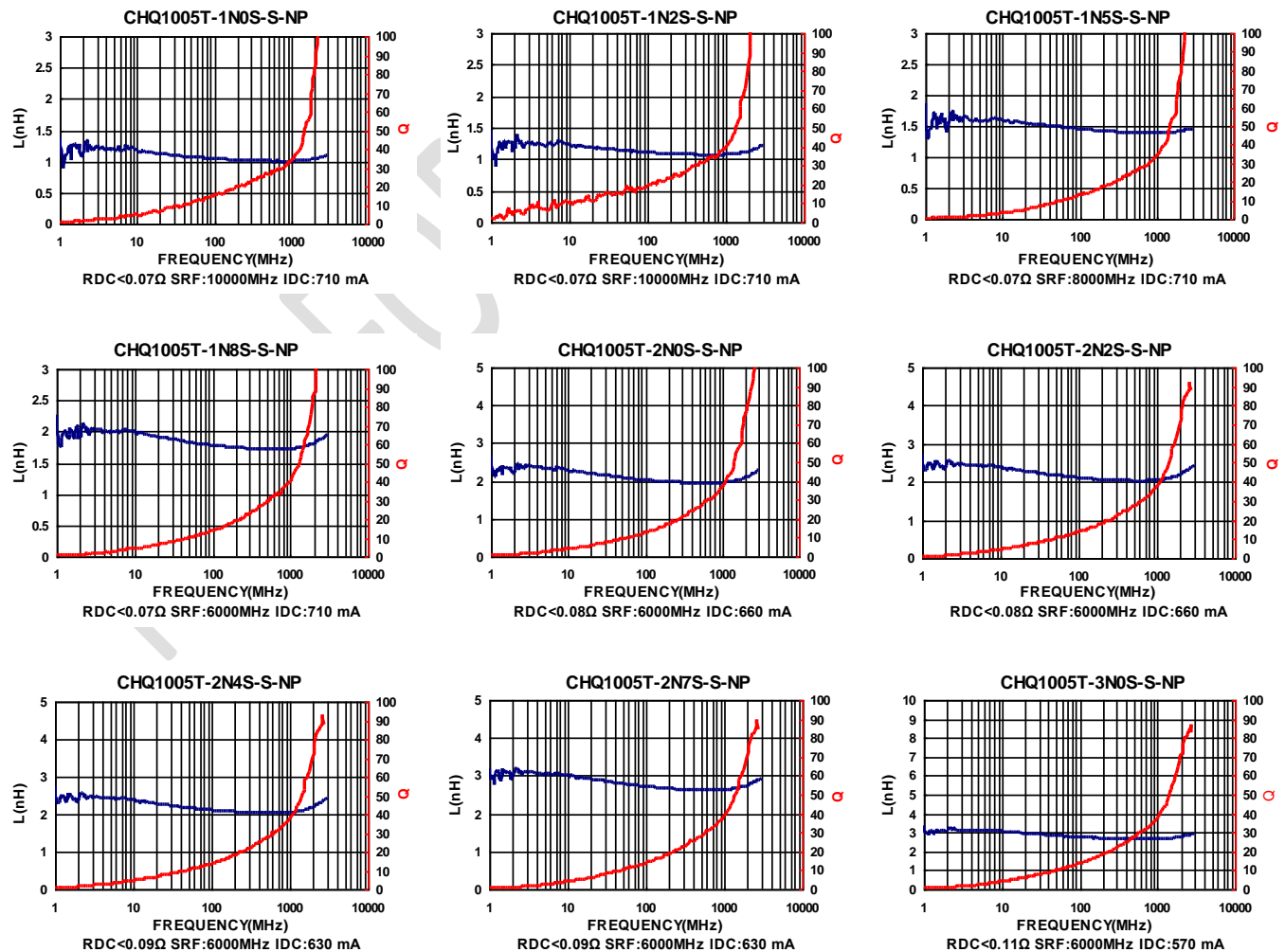



# SMD Ceramic Multilayer Chip Inductors – CHQ Series

Test Instruments : Agilent E4991A Material/Impedance Analyzer

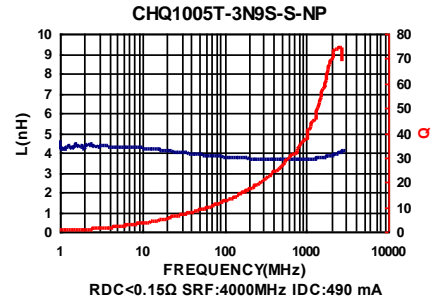
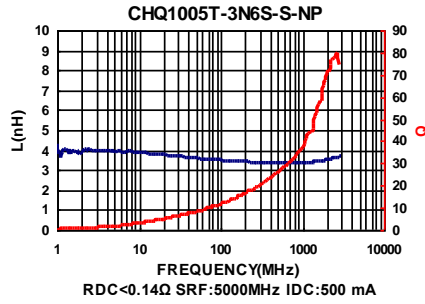
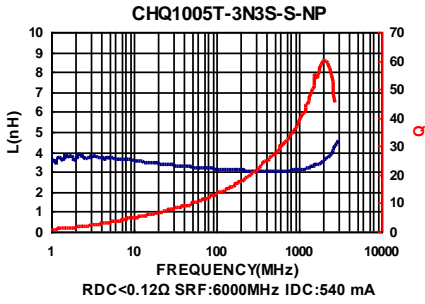

NOT FOR NEW DESIGN

**Test Instruments** : Agilent E4991A Material/Impedance Analyzer

NOT FOR NEW DESIGN

**Test Instruments** : Agilent E4991A Material/Impedance Analyzer

NOT FOR NEW DESIGN

## Packaging Specifications

### Tape Dimensions

Figure A

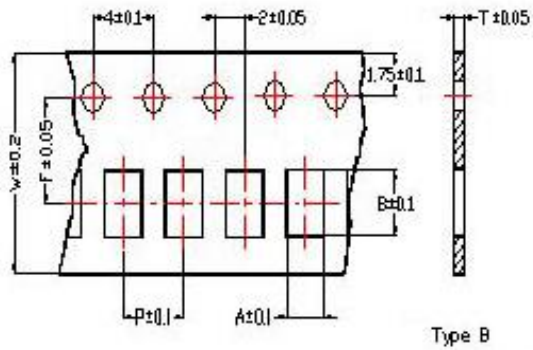

### Tape Material

Figure A

Carrier Tape: Polycarbonate (Tape A)  
Carrier Tape: Paper (Tape B)  
Cover Tape: Polystyrene



Figure B

Carrier tape : Paper  
Cover tape : Polyethylene

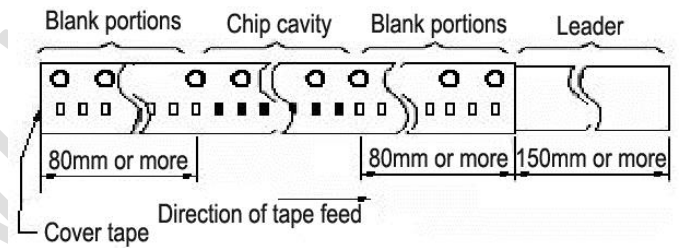

Dimensions in mm

| TYPE    | Tape Dimensions |      |      |   |   |     |   | Tape Material | Reel Dimensions |    |    |     | Quantity PCS / Reel |
|---------|-----------------|------|------|---|---|-----|---|---------------|-----------------|----|----|-----|---------------------|
|         | A               | B    | T    | W | P | F   | A |               | B               | C  | D  |     |                     |
| CHQ0603 | 0.37            | 0.67 | 0.42 | 8 | 2 | 3.5 | A | B             | 180             | 60 | 13 | 1.5 | 15000               |
| CHQ1005 | 0.62            | 1.12 | 0.60 | 8 | 2 | 3.5 | A | A             | 178             | 60 | 12 | 1.5 | 10000               |

## X-ON Electronics

Largest Supplier of Electrical and Electronic Components

*Click to view similar products for [Fixed Inductors](#) category:*

*Click to view products by [Chilisin](#) manufacturer:*

Other Similar products are found below :

[CR32NP-151KC](#) [CR32NP-180KC](#) [CR32NP-181KC](#) [CR32NP-1R5MC](#) [CR32NP-390KC](#) [CR32NP-3R9MC](#) [CR32NP-680KC](#) [CR32NP-820KC](#) [CR32NP-8R2MC](#) [CR43NP-390KC](#) [CR43NP-560KC](#) [CR43NP-680KC](#) [CR54NP-181KC](#) [CR54NP-470LC](#) [CR54NP-820KC](#) [CR54NP-8R5MC](#) [70F224AI](#) [MGDQ4-00004-P](#) [MHL1ECTTP18NJ](#) [MHQ1005P10NJ](#) [MHQ1005P1N0S](#) [MHQ1005P2N4S](#) [MHQ1005P3N6S](#) [MHQ1005P5N1S](#) [MHQ1005P8N2J](#) [PE-51506NL](#) [PE-53601NL](#) [PE-53602NL](#) [PE-53630NL](#) [PE-53824SNLT](#) [PE-92100NL](#) [PG0434.801NLT](#) [PG0936.113NLT](#) [9220-20](#) [9310-16](#) [PM06-2N7](#) [PM06-39NJ](#) [A01TK](#) [1206CS-471XJ](#) [HC2LP-R47-R](#) [HC2-R47-R](#) [HC3-2R2-R](#) [HCF1305-3R3-R](#) [1206CS-151XG](#) [RCH664NP-140L](#) [RCH664NP-4R7M](#) [RCH8011NP-221L](#) [RCP1317NP-332L](#) [RCP1317NP-391L](#) [RCR1010NP-470M](#)