

Cautions and Warnings

Please be noted that this spec is only for reference if you have projects designed with the product number listed in. If you are looking for new project design-in, please find BWCS Series specification/datasheet on Chilisin website. Or you may find our sales contact for more information on old part number at your convenience. Appreciated your attention and understanding.

Note: Please be sure to request approval specifications that provide further details of the products. Kindly note that the content of these specifications are subject to change or may be discontinued without prior notice. This product may not be designed/used in medical or high risk applications without Chilisin approval. Please contact our sales department before ordering.

CS Series



Due to accurate wire winding technology, these chip inductors are designed for filtering, impedance matching, resonance and choke circuits for RF designer. Both standard series custom designs are available.

Features

- RoHS Compliant
- Ceramic body and wire wound construction provide high SRFs
- Exceptional Q values even at high frequencies
- Highest possible SRFs as well as excellent Q values
- The non-magnetic coil form assures utmost thermal stability, predictability and batch consistency
- CS series is standard for RF designers

Applications

- RF products for cellular phone
- GPS receiver
- Base Station
- Repeater
- Wireless LAN/ mouse/ keyboard/ earphone
- Remote control
- Security system and other RF modules

Product Identification

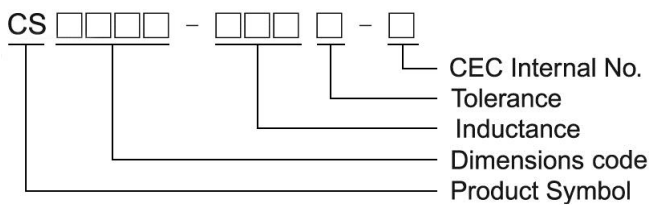

Shape and Dimensions / Recommended Pattern

CS0201

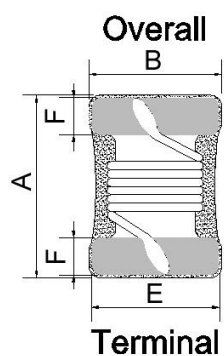

Dimensions

CS0402

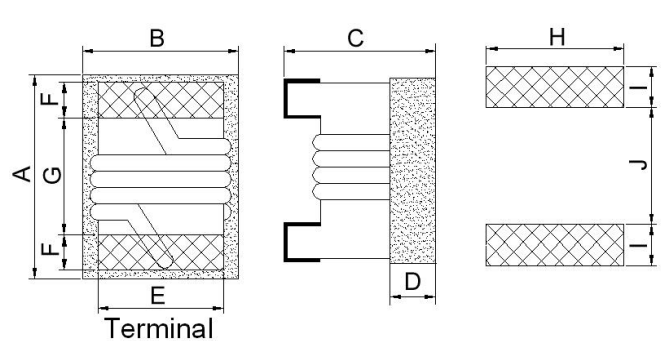

| | | A Max | B Max | C Max | D | E | F | G | H | I | J |
|--------|------|-------|-------|-------|-------|-------|-------|-------|-------|-------|-------|
| CS0201 | inch | 0.023 | 0.018 | 0.018 | - | 0.015 | 0.004 | - | 0.018 | 0.007 | 0.009 |
| | mm | 0.58 | 0.46 | 0.45 | - | 0.38 | 0.1 | - | 0.46 | 0.18 | 0.23 |
| CS0402 | inch | 0.047 | 0.028 | 0.026 | 0.010 | 0.020 | 0.009 | 0.022 | 0.026 | 0.014 | 0.018 |
| | mm | 1.19 | 0.70 | 0.66 | 0.25 | 0.51 | 0.23 | 0.56 | 0.66 | 0.36 | 0.46 |

SMD Wire Wound Ceramic Chip Inductors - CS Series

CS0603/0805/1008

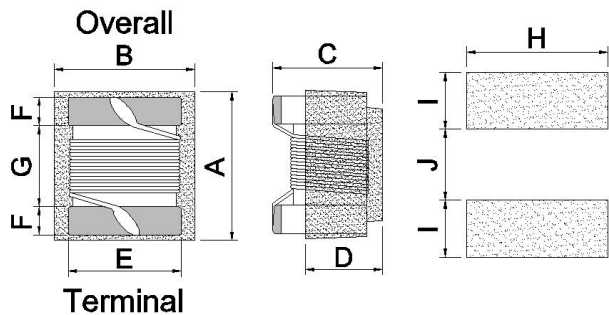

CS1812

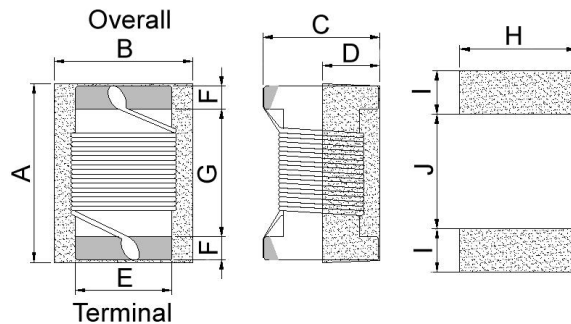

Dimensions

| | | A | B | C | D | E | F | G | H | I | J |
|---------------|------|-------------------------------------|----------|--------------------------------------|-------|------|-------|-------|------|-------|-------|
| CS0603 | mm | 1.6 ^{+0.2} _{-0.1} | 1.02±0.1 | 0.82 ^{+0.2} _{-0.1} | 0.51 | 0.76 | 0.33 | 0.86 | 1.02 | 0.64 | 0.64 |
| | | A Max | B Max | C Max | D | E | F | G | H | I | J |
| CS0805 | inch | 0.093 | 0.068 | 0.06 | 0.028 | 0.05 | 0.02 | 0.04 | 0.07 | 0.04 | 0.03 |
| | mm | 2.35 | 1.73 | 1.52 | 0.71 | 1.27 | 0.51 | 1.02 | 1.78 | 1.02 | 0.76 |
| CS1008 | inch | 0.115 | 0.11 | 0.083 | 0.046 | 0.08 | 0.02 | 0.06 | 0.10 | 0.04 | 0.05 |
| | mm | 2.92 | 2.79 | 2.1 | 1.16 | 2.03 | 0.51 | 1.52 | 2.54 | 1.02 | 1.27 |
| CS1812 | inch | 0.197 | 0.154 | 0.135 | 0.07 | 0.1 | 0.025 | 0.128 | 0.12 | 0.045 | 0.118 |
| | mm | 4.95 | 3.81 | 3.43 | 1.78 | 2.54 | 0.64 | 3.25 | 3.05 | 1.14 | 3.00 |

NOT FOR NEW DESIGN

SMD Wire Wound Ceramic Chip Inductors - CS Series

Electrical Characteristics

| Part Number | Inductance (nH) | Tolerance (±%) | Test Frequency (MHz) | Q Min | SRF (GHz) Typ | RDC (Ω) Max | Irms (mA) Typ |
|---------------|-----------------|----------------|----------------------|-------|---------------|-------------|---------------|
| CS0201-0N5□-S | 0.5 | 10 | 250 | 4 | 23.5 | 0.02 | 1250 |
| CS0201-0N6□-S | 0.6 | 10 | 250 | 6 | 24.5 | 0.03 | 1000 |
| CS0201-1N2□-S | 1.2 | 5 | 250 | 13 | 17.9 | 0.042 | 870 |
| CS0201-1N3□-S | 1.3 | 5 | 250 | 11 | 17.6 | 0.048 | 820 |
| CS0201-1N4□-S | 1.4 | 5 | 250 | 14 | 17 | 0.08 | 630 |
| CS0201-1N5□-S | 1.5 | 5 | 250 | 11 | 17 | 0.09 | 600 |
| CS0201-2N2□-S | 2.2 | 5 | 250 | 15 | 16.7 | 0.07 | 700 |
| CS0201-2N3□-S | 2.3 | 5 | 250 | 18 | 16.5 | 0.07 | 670 |
| CS0201-2N4□-S | 2.4 | 5 | 250 | 13 | 13 | 0.082 | 620 |
| CS0201-2N5□-S | 2.5 | 5 | 250 | 16 | 12.5 | 0.165 | 440 |
| CS0201-3N3□-S | 3.3 | 5 | 250 | 14 | 12.8 | 0.08 | 630 |
| CS0201-3N4□-S | 3.4 | 5 | 250 | 11 | 12.7 | 0.08 | 630 |
| CS0201-3N5□-S | 3.5 | 5 | 250 | 16 | 12.4 | 0.08 | 630 |
| CS0201-3N6□-S | 3.6 | 5 | 250 | 18 | 12.5 | 0.105 | 550 |
| CS0201-3N7□-S | 3.7 | 5 | 250 | 15 | 10.6 | 0.105 | 550 |
| CS0201-3N8□-S | 3.8 | 5 | 250 | 16 | 10.2 | 0.18 | 420 |
| CS0201-3N9□-S | 3.9 | 5 | 250 | 12 | 11.2 | 0.24 | 360 |
| CS0201-4N8□-S | 4.8 | 5 | 250 | 17 | 11 | 0.096 | 570 |
| CS0201-4N9□-S | 4.9 | 5 | 250 | 18 | 11.7 | 0.13 | 510 |
| CS0201-5N0□-S | 5.0 | 5 | 250 | 18 | 11.5 | 0.13 | 510 |
| CS0201-5N1□-S | 5.1 | 5 | 250 | 18 | 11.1 | 0.13 | 510 |
| CS0201-5N2□-S | 5.2 | 5 | 250 | 18 | 10 | 0.17 | 430 |
| CS0201-5N3□-S | 5.3 | 5 | 250 | 18 | 10.6 | 0.13 | 510 |
| CS0201-5N4□-S | 5.4 | 5 | 250 | 18 | 10.2 | 0.13 | 510 |
| CS0201-5N5□-S | 5.5 | 5 | 250 | 16 | 9.5 | 0.285 | 330 |
| CS0201-6N7□-S | 6.7 | 5 | 250 | 18 | 6.8 | 0.15 | 460 |
| CS0201-6N8□-S | 6.8 | 5 | 250 | 18 | 9.5 | 0.15 | 460 |
| CS0201-6N9□-S | 6.9 | 5 | 250 | 18 | 9.3 | 0.15 | 460 |
| CS0201-7N0□-S | 7.0 | 5 | 250 | 18 | 6.7 | 0.21 | 390 |
| CS0201-7N1□-S | 7.1 | 5 | 250 | 18 | 9.5 | 0.25 | 390 |
| CS0201-7N2□-S | 7.2 | 5 | 250 | 18 | 9.4 | 0.25 | 390 |
| CS0201-7N3□-S | 7.3 | 5 | 250 | 18 | 9.3 | 0.25 | 390 |
| CS0201-7N4□-S | 7.4 | 5 | 250 | 18 | 9.1 | 0.25 | 390 |
| CS0201-7N5□-S | 7.5 | 5 | 250 | 15 | 6.8 | 0.34 | 300 |
| CS0201-7N6□-S | 7.6 | 5 | 250 | 17 | 9.3 | 0.3 | 340 |
| CS0201-7N7□-S | 7.7 | 5 | 250 | 17 | 9.2 | 0.3 | 340 |
| CS0201-7N8□-S | 7.8 | 5 | 250 | 17 | 9.2 | 0.3 | 340 |
| CS0201-7N9□-S | 7.9 | 5 | 250 | 17 | 9.1 | 0.3 | 340 |
| CS0201-8N0□-S | 8.0 | 5 | 250 | 17 | 9.2 | 0.3 | 340 |
| CS0201-8N1□-S | 8.1 | 5 | 250 | 17 | 9.1 | 0.3 | 340 |
| CS0201-8N2□-S | 8.2 | 5 | 250 | 17 | 6.4 | 0.27 | 340 |

Note: When ordering, please specify tolerance code. Tolerance : J=±5% , K=±10%

- Operating temperature range - 40°C ~ 125°C(Including self - temperature rise)
- Irms for a 15°C temperature rise from 25°C ambient with current
- Measure Equipment :
L & Q : HP4286A/HP4287A/AgilentE4991/Keysight E4982A
SRF : Agilent HP8753D/Agilent HP8722ES
RDC : HP4287A/Keysight E4982A
Irms : HP4284A+HP42841A/HP4285A+HP42841A

Please be sure to request approval specifications that provide further details of the products. Kindly note that the content of these specifications are subject to change or may be discontinued without prior notice. This product may not be designed/used in medical or high risk applications without Chilisin approval. Please contact our sales department before ordering.



CHILISIN ELECTRONICS CORP.

SMD Wire Wound Ceramic Chip Inductors - CS Series

Electrical Characteristics

| Part Number | Inductance (nH) | Tolerance (±%) | Test Frequency (MHz) | Q Min | SRF (GHz) Typ | RDC (Ω) Max | Irms (mA) Typ |
|---------------|-----------------|----------------|----------------------|-------|---------------|-------------|---------------|
| CS0201-8N3□-S | 8.3 | 5 | 250 | 17 | 8.9 | 0.3 | 340 |
| CS0201-8N4□-S | 8.4 | 5 | 250 | 15 | 8.9 | 0.38 | 300 |
| CS0201-8N5□-S | 8.5 | 5 | 250 | 15 | 8.9 | 0.38 | 300 |
| CS0201-8N7□-S | 8.7 | 5 | 250 | 15 | 6.3 | 0.38 | 300 |
| CS0201-9N0□-S | 9.0 | 5 | 250 | 15 | 6.4 | 0.38 | 300 |
| CS0201-9N4□-S | 9.4 | 5 | 250 | 16 | 6.4 | 0.4 | 280 |
| CS0201-9N6□-S | 9.6 | 5 | 250 | 16 | 6.2 | 0.4 | 280 |
| CS0201-11N□-S | 11 | 5 | 250 | 16 | 5.7 | 0.44 | 280 |
| CS0201-12N□-S | 12 | 5 | 250 | 17 | 5.6 | 0.36 | 300 |
| CS0201-13N□-S | 13 | 5 | 250 | 16 | 6.7 | 0.5 | 270 |
| CS0201-14N□-S | 14 | 5 | 250 | 16 | 5.1 | 0.5 | 270 |

Note: When ordering, please specify tolerance code. Tolerance : J=±5% , K=±10%

- Operating temperature range - 40°C ~ 125°C(Including self - temperature rise)
- Irms for a 15°C temperature rise from 25°C ambient with current
- Measure Equipment :
 L & Q : HP4286A/HP4287A/AgilentE4991/Keysight E4982A
 SRF : Agilent HP8753D/Agilent HP8722ES
 RDC : HP4287A/Keysight E4982A
 Irms : HP4284A+HP42841A/HP4285A+HP42841A

Typical L vs. Frequency

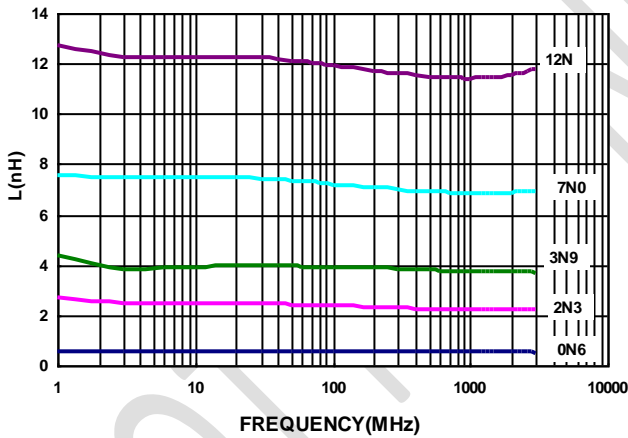

Typical Q vs. Frequency

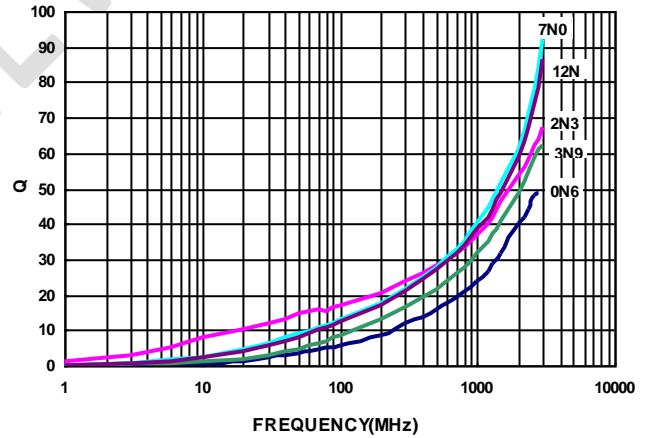

SMD Wire Wound Ceramic Chip Inductors - CS Series

Electrical Characteristics

| Part Number | Inductance (nH) | Tolerance (±%) | Test Frequency (MHz) | Q Min | SRF (GHz) Min | RDC (Ω) Max | Irms (mA) Max |
|---------------|-----------------|-----------------|----------------------|-------|---------------|-------------|---------------|
| CS0402-1N0□-S | 1.0 | 10 / 5 / ±0.1nH | 250 | 16 | 12.7 | 0.045 | 1360 |
| CS0402-1N2□-S | 1.2 | 10 / 5 / ±0.1nH | 250 | 10 | 10.4 | 0.140 | 640 |
| CS0402-1N3□-S | 1.3 | 10 / ±0.1nH | 250 | 10 | 10.4 | 0.140 | 640 |
| CS0402-1N9□-S | 1.9 | 10 / 5 / ±0.1nH | 250 | 16 | 11.3 | 0.070 | 1040 |
| CS0402-2N0□-S | 2.0 | 10 / 5 / ±0.1nH | 250 | 16 | 11.1 | 0.070 | 1040 |
| CS0402-2N2□-S | 2.2 | 10 / 5 / ±0.1nH | 250 | 19 | 10.8 | 0.070 | 960 |
| CS0402-2N4□-S | 2.4 | 10 / 5 / ±0.1nH | 250 | 15 | 10.5 | 0.068 | 790 |
| CS0402-2N5□-S | 2.5 | 10 / 5 / ±0.1nH | 250 | 13 | 10.4 | 0.150 | 640 |
| CS0402-2N7□-S | 2.7 | 10 / 5 / ±0.1nH | 250 | 16 | 10.4 | 0.120 | 640 |
| CS0402-3N3□-S | 3.3 | 10 / 5 / 3 | 250 | 19 | 7.00 | 0.066 | 840 |
| CS0402-3N6□-S | 3.6 | 10 / 5 / 3 | 250 | 19 | 6.80 | 0.066 | 840 |
| CS0402-3N9□-S | 3.9 | 10 / 5 / 3 | 250 | 19 | 6.00 | 0.066 | 840 |
| CS0402-4N3□-S | 4.3 | 10 / 5 / 3 | 250 | 18 | 6.00 | 0.091 | 700 |
| CS0402-4N7□-S | 4.7 | 10 / 5 / 3 | 250 | 15 | 4.77 | 0.130 | 640 |
| CS0402-5N1□-S | 5.1 | 10 / 5 / 3 | 250 | 20 | 4.80 | 0.083 | 800 |
| CS0402-5N6□-S | 5.6 | 10 / 5 / 3 | 250 | 20 | 4.80 | 0.083 | 760 |
| CS0402-5N8□-S | 5.8 | 10 / 5 / 3 | 250 | 20 | 4.80 | 0.083 | 760 |
| CS0402-6N2□-S | 6.2 | 10 / 5 / 3 | 250 | 20 | 4.80 | 0.083 | 760 |
| CS0402-6N8□-S | 6.8 | 10 / 5 / 3 | 250 | 20 | 4.80 | 0.083 | 680 |
| CS0402-7N3□-S | 7.3 | 10 / 5 / 3 | 250 | 20 | 4.80 | 0.12 | 680 |
| CS0402-7N5□-S | 7.5 | 10 / 5 / 3 | 250 | 22 | 4.80 | 0.10 | 680 |
| CS0402-8N2□-S | 8.2 | 10 / 5 / 3 | 250 | 22 | 4.40 | 0.10 | 680 |
| CS0402-8N7□-S | 8.7 | 10 / 5 / 3 | 250 | 18 | 4.10 | 0.20 | 480 |
| CS0402-9N0□-S | 9.0 | 10 / 5 / 3 | 250 | 22 | 4.16 | 0.10 | 680 |
| CS0402-9N1□-S | 9.1 | 10 / 5 / 3 | 250 | 22 | 4.16 | 0.10 | 680 |
| CS0402-9N5□-S | 9.5 | 10 / 5 / 3 | 250 | 18 | 4.00 | 0.20 | 480 |
| CS0402-10N□-S | 10 | 10 / 5 / 3 / 2 | 250 | 21 | 3.90 | 0.20 | 480 |
| CS0402-11N□-S | 11 | 10 / 5 / 3 / 2 | 250 | 24 | 3.68 | 0.12 | 640 |
| CS0402-12N□-S | 12 | 10 / 5 / 3 / 2 | 250 | 24 | 3.60 | 0.12 | 640 |
| CS0402-13N□-S | 13 | 10 / 5 / 3 / 2 | 250 | 24 | 3.45 | 0.21 | 440 |
| CS0402-15N□-S | 15 | 10 / 5 / 3 / 2 | 250 | 24 | 3.28 | 0.17 | 560 |
| CS0402-16N□-S | 16 | 10 / 5 / 3 / 2 | 250 | 24 | 3.10 | 0.22 | 560 |
| CS0402-18N□-S | 18 | 10 / 5 / 3 / 2 | 250 | 25 | 3.10 | 0.23 | 420 |
| CS0402-19N□-S | 19 | 10 / 5 / 3 / 2 | 250 | 24 | 3.04 | 0.20 | 480 |
| CS0402-20N□-S | 20 | 10 / 5 / 3 / 2 | 250 | 25 | 3.00 | 0.25 | 420 |
| CS0402-22N□-S | 22 | 10 / 5 / 3 / 2 | 250 | 25 | 2.80 | 0.30 | 400 |
| CS0402-23N□-S | 23 | 10 / 5 / 3 / 2 | 250 | 22 | 2.72 | 0.30 | 400 |
| CS0402-24N□-S | 24 | 10 / 5 / 3 / 2 | 250 | 25 | 2.70 | 0.30 | 400 |
| CS0402-27N□-S | 27 | 10 / 5 / 3 / 2 | 250 | 24 | 2.48 | 0.30 | 400 |
| CS0402-30N□-S | 30 | 10 / 5 / 3 / 2 | 250 | 25 | 2.35 | 0.35 | 400 |

Note: When ordering, please specify tolerance code. Tolerance : B=±0.1nH , G=±2% , H=±3% , J=±5% , K=±10%

- Operating temperature range - 40°C ~ 125°C(Including self - temperature rise)
- Irms for a 15°C temperature rise from 25°C ambient with current
- Measure Equipment :
 L & Q : Agilent E4991A+Agilent HP16197A
 SRF : Agilent HP8753D/Agilent HP8722ES
 RDC : HP4287A
 Irms : HP4284A+HP42841A/HP4285A+HP42841A

SMD Wire Wound Ceramic Chip Inductors - CS Series

Electrical Characteristics

| Part Number | Inductance (nH) | Tolerance (±%) | Test Frequency (MHz) | Q Min | SRF (GHz) Min | RDC (Ω) Max | Irms (mA) Max |
|---------------|-----------------|----------------|----------------------|-------|---------------|-------------|---------------|
| CS0402-33N□-S | 33 | 10 / 5 / 3 / 2 | 250 | 24 | 2.35 | 0.40 | 400 |
| CS0402-36N□-S | 36 | 10 / 5 / 3 / 2 | 250 | 24 | 2.32 | 0.44 | 320 |
| CS0402-39N□-S | 39 | 10 / 5 / 3 / 2 | 250 | 25 | 2.10 | 0.55 | 200 |
| CS0402-40N□-S | 40 | 10 / 5 / 3 / 2 | 250 | 24 | 2.24 | 0.65 | 320 |
| CS0402-43N□-S | 43 | 10 / 5 / 3 / 2 | 250 | 25 | 2.03 | 0.81 | 100 |
| CS0402-47N□-S | 47 | 10 / 5 / 3 / 2 | 250 | 20 | 2.10 | 0.83 | 150 |
| CS0402-51N□-S | 51 | 10 / 5 / 3 / 2 | 250 | 25 | 1.75 | 0.82 | 100 |
| CS0402-56N□-S | 56 | 10 / 5 / 3 / 2 | 250 | 22 | 1.76 | 0.97 | 100 |
| CS0402-68N□-S | 68 | 10 / 5 / 3 / 2 | 250 | 22 | 1.62 | 1.12 | 100 |
| CS0402-82N□-S | 82 | 10 / 5 / 3 / 2 | 250 | 20 | 1.26 | 1.55 | 50 |
| CS0402-R10□-S | 100 | 10 / 5 / 3 / 2 | 250 | 20 | 1.16 | 2.00 | 30 |
| CS0402-R18□-S | 180 | 10 / 5 / 3 / 2 | 100 | 8 | 0.70 | 2.70 | 50 |
| CS0402-R22□-S | 220 | 10 / 5 / 3 / 2 | 100 | 8 | 0.70 | 4.00 | 50 |

Note: When ordering, please specify tolerance code. Tolerance : B=±0.1nH , G=±2% , H=±3% , J=±5% , K=±10%

- Operating temperature range - 40°C ~ 125°C(Including self - temperature rise)
- I_{rms} for a 15°C temperature rise from 25°C ambient with current
- Measure Equipment :
 L & Q : Agilent E4991A+Agilent HP16197A
 SRF : Agilent HP8753D/Agilent HP8722ES
 RDC : HP4287A
 I_{rms} : HP4284A+HP42841A/HP4285A+HP42841A

Typical L vs. Frequency

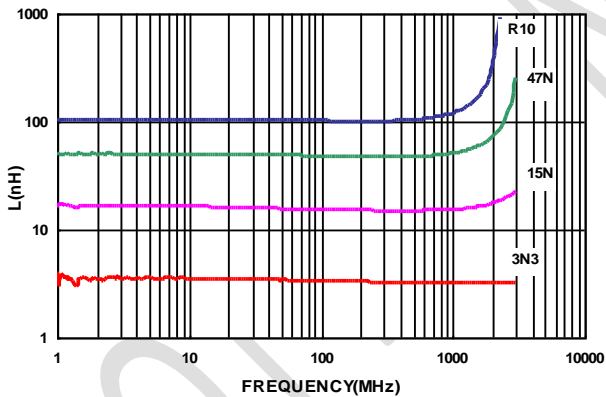

Typical Q vs. Frequency

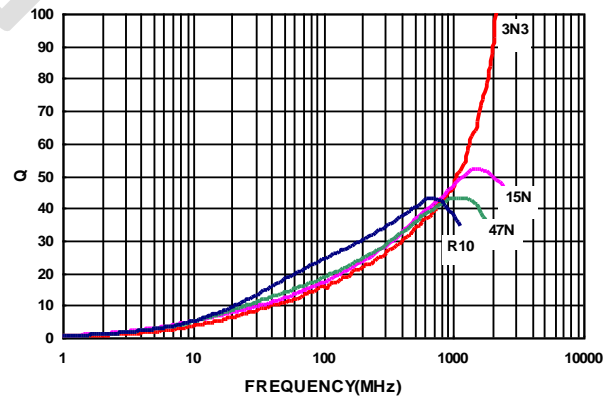

SMD Wire Wound Ceramic Chip Inductors – CS Series

Electrical Characteristics

| Part Number | Inductance (nH) | Tolerance (±%) | Test Frequency (MHz) | Q Min | SRF (MHz) Min | RDC (Ω) Max | Irms (mA) Max | Color |
|---------------|-----------------|-----------------|----------------------|-------|---------------|-------------|---------------|--------|
| CS0603-1N6□-S | 1.6 | 10 / 5 / ±0.1nH | 250 | 24 | 12500 | 0.030 | 700 | Red |
| CS0603-1N8□-S | 1.8 | 10 / 5 / ±0.1nH | 250 | 16 | 12500 | 0.045 | 700 | Black |
| CS0603-2N2□-S | 2.2 | 10 / 5 / ±0.1nH | 250 | 13 | 12500 | 0.250 | 700 | Yellow |
| CS0603-3N3□-S | 3.3 | 10 / 5 / 3 | 250 | 35 | 5900 | 0.045 | 700 | Blue |
| CS0603-3N6□-S | 3.6 | 10 / 5 / 3 / 2 | 250 | 22 | 5900 | 0.063 | 700 | Red |
| CS0603-3N9□-S | 3.9 | 10 / 5 / 3 / 2 | 250 | 22 | 6900 | 0.080 | 700 | Brown |
| CS0603-4N3□-S | 4.3 | 10 / 5 / 3 / 2 | 250 | 22 | 5900 | 0.063 | 700 | Orange |
| CS0603-4N7□-S | 4.7 | 10 / 5 / 3 / 2 | 250 | 20 | 5800 | 0.116 | 700 | Violet |
| CS0603-5N1□-S | 5.1 | 10 / 5 / 3 / 2 | 250 | 20 | 5700 | 0.140 | 700 | Green |
| CS0603-5N6□-S | 5.6 | 10 / 5 / 3 / 2 | 250 | 20 | 5800 | 0.170 | 700 | Yellow |
| CS0603-6N3□-S | 6.3 | 10 / 5 / 3 / 2 | 250 | 20 | 5700 | 0.140 | 700 | White |
| CS0603-6N8□-S | 6.8 | 10 / 5 / 3 / 2 | 250 | 27 | 5800 | 0.110 | 700 | Red |
| CS0603-7N5□-S | 7.5 | 10 / 5 / 3 / 2 | 250 | 28 | 4800 | 0.106 | 700 | Brown |
| CS0603-8N2□-S | 8.2 | 10 / 5 / 3 / 2 | 250 | 28 | 4700 | 0.109 | 700 | White |
| CS0603-8N7□-S | 8.7 | 10 / 5 / 3 / 2 | 250 | 28 | 4600 | 0.109 | 700 | Yellow |
| CS0603-9N1□-S | 9.1 | 10 / 5 / 3 / 2 | 250 | 28 | 4800 | 0.120 | 700 | Violet |
| CS0603-9N5□-S | 9.5 | 10 / 5 / 3 / 2 | 250 | 28 | 5400 | 0.135 | 700 | Blue |
| CS0603-10N□-S | 10 | 10 / 5 / 3 / 2 | 250 | 31 | 4800 | 0.130 | 700 | Orange |
| CS0603-11N□-S | 11 | 10 / 5 / 3 / 2 | 250 | 33 | 4000 | 0.086 | 700 | Gray |
| CS0603-12N□-S | 12 | 10 / 5 / 3 / 2 | 250 | 35 | 4000 | 0.130 | 700 | Yellow |
| CS0603-13N□-S | 13 | 10 / 5 / 3 / 2 | 250 | 30 | 4000 | 0.160 | 700 | Black |
| CS0603-15N□-S | 15 | 10 / 5 / 3 / 2 | 250 | 35 | 4000 | 0.170 | 700 | Green |
| CS0603-16N□-S | 16 | 10 / 5 / 3 / 2 | 250 | 34 | 3300 | 0.104 | 700 | White |
| CS0603-18N□-S | 18 | 10 / 5 / 3 / 2 | 250 | 35 | 3100 | 0.170 | 700 | Blue |
| CS0603-20N□-S | 20 | 10 / 5 / 3 / 2 | 250 | 38 | 3000 | 0.190 | 700 | Red |
| CS0603-22N□-S | 22 | 10 / 5 / 3 / 2 | 250 | 38 | 3000 | 0.190 | 700 | Violet |
| CS0603-23N□-S | 23 | 10 / 5 / 3 / 2 | 250 | 38 | 2850 | 0.190 | 700 | Orange |
| CS0603-24N□-S | 24 | 10 / 5 / 3 / 2 | 250 | 37 | 2650 | 0.135 | 700 | Black |
| CS0603-27N□-S | 27 | 10 / 5 / 3 / 2 | 250 | 40 | 2800 | 0.220 | 600 | Gray |
| CS0603-30N□-S | 30 | 10 / 5 / 3 / 2 | 250 | 37 | 2250 | 0.144 | 600 | Brown |
| CS0603-33N□-S | 33 | 10 / 5 / 3 / 2 | 250 | 40 | 2300 | 0.220 | 600 | White |
| CS0603-36N□-S | 36 | 10 / 5 / 3 / 2 | 250 | 38 | 2080 | 0.250 | 600 | Red |
| CS0603-39N□-S | 39 | 10 / 5 / 3 / 2 | 250 | 40 | 2200 | 0.250 | 600 | Black |
| CS0603-43N□-S | 43 | 10 / 5 / 3 / 2 | 250 | 39 | 2000 | 0.280 | 600 | Orange |
| CS0603-47N□-S | 47 | 10 / 5 / 3 / 2 | 200 | 38 | 2000 | 0.280 | 600 | Brown |
| CS0603-51N□-S | 51 | 10 / 5 / 3 / 2 | 200 | 38 | 1900 | 0.310 | 600 | Brown |
| CS0603-56N□-S | 56 | 10 / 5 / 3 / 2 | 200 | 38 | 1900 | 0.310 | 600 | Red |
| CS0603-68N□-S | 68 | 10 / 5 / 3 / 2 | 200 | 37 | 1700 | 0.340 | 600 | Orange |
| CS0603-72N□-S | 72 | 10 / 5 / 3 / 2 | 150 | 34 | 1700 | 0.490 | 400 | Yellow |
| CS0603-82N□-S | 82 | 10 / 5 / 3 / 2 | 150 | 34 | 1700 | 0.540 | 400 | Green |
| CS0603-91N□-S | 91 | 10 / 5 / 3 / 2 | 150 | 34 | 1400 | 0.580 | 400 | Black |

Note: When ordering, please specify tolerance code. Tolerance : B=±0.1nH , G=±2% , H=±3% , J=±5% , K=±10%

- Operating temperature range - 40°C ~ 125°C(Including self - temperature rise)
- Irms for a 15°C temperature rise from 25°C ambient with current
- Measure Equipment :

L & Q : Agilent E4991A+Agilent HP16197A

SRF : Agilent HP8753D/Agilent E4991A

RDC : Chroma 16502

Irms : HP4284A+HP42841A/HP4285A+HP42841A

Please be sure to request approval specifications that provide further details of the products. Kindly note that the content of these specifications are subject to change or may be discontinued without prior notice. This product may not be designed/used in medical or high risk applications without Chilisin approval. Please contact our sales department before ordering.



CHILISIN ELECTRONICS CORP.

SMD Wire Wound Ceramic Chip Inductors – CS Series

Electrical Characteristics

| Part Number | Inductance (nH) | Tolerance (±%) | Test Frequency (MHz) | Q Min | SRF (MHz) Min | RDC (Ω) Max | Irms (mA) Max | Color |
|---------------|-----------------|----------------|----------------------|-------|---------------|-------------|---------------|--------|
| CS0603-R10□-S | 100 | 10 / 5 / 3 / 2 | 150 | 34 | 1400 | 0.580 | 400 | Blue |
| CS0603-R11□-S | 110 | 10 / 5 / 3 / 2 | 150 | 32 | 1350 | 0.610 | 300 | Violet |
| CS0603-R12□-S | 120 | 10 / 5 / 3 / 2 | 150 | 32 | 1300 | 0.750 | 300 | Gray |
| CS0603-R15□-S | 150 | 10 / 5 / 3 / 2 | 150 | 28 | 990 | 0.920 | 280 | White |
| CS0603-R16□-S | 160 | 10 / 5 / 3 / 2 | 100 | 25 | 990 | 1.250 | 240 | Yellow |
| CS0603-R18□-S | 180 | 10 / 5 / 3 / 2 | 100 | 25 | 990 | 1.250 | 240 | Black |
| CS0603-R20□-S | 200 | 10 / 5 / 3 / 2 | 100 | 25 | 900 | 2.100 | 200 | Red |
| CS0603-R21□-S | 210 | 10 / 5 / 3 / 2 | 100 | 27 | 895 | 2.060 | 200 | Gray |
| CS0603-R22□-S | 220 | 10 / 5 / 3 / 2 | 100 | 25 | 900 | 2.100 | 200 | Brown |
| CS0603-R24□-S | 240 | 10 / 5 / 3 / 2 | 100 | 25 | 900 | 2.200 | 200 | Green |
| CS0603-R25□-S | 250 | 10 / 5 / 3 / 2 | 100 | 25 | 822 | 3.550 | 120 | Violet |
| CS0603-R27□-S | 270 | 10 / 5 / 3 / 2 | 100 | 24 | 900 | 2.800 | 170 | Red |
| CS0603-R33□-S | 330 | 10 / 5 / 3 / 2 | 100 | 25 | 900 | 3.890 | 100 | Orange |
| CS0603-R39□-S | 390 | 10 / 5 / 3 / 2 | 100 | 25 | 900 | 4.350 | 100 | Yellow |
| CS0603-R47□-S | 470 | 10 / 5 / 3 / 2 | 100 | 25 | 500 | 4.500 | 100 | Brown |
| CS0603-R56□-S | 560 | 10 / 5 / 3 / 2 | 100 | 23 | 460 | 4.700 | 90 | Blue |

Note: When ordering, please specify tolerance code. Tolerance : B=±0.1nH , G=±2% , H=±3% , J=±5% , K=±10%

- Operating temperature range - 40°C ~ 125°C(Including self - temperature rise)
- Irms for a 15°C temperature rise from 25°C ambient with current
- Measure Equipment :

L & Q : Agilent E4991A+Agilent HP16197A

SRF : Agilent HP8753D/Agilent E4991A

RDC : Chroma 16502

Irms : HP4284A+HP42841A/HP4285A+HP42841A

Typical L vs. Frequency

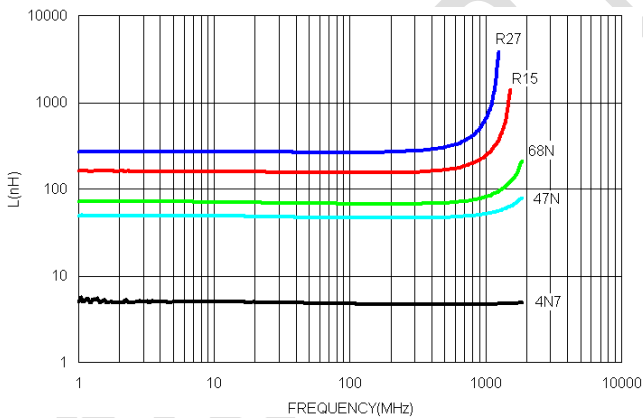

Typical Q vs. Frequency

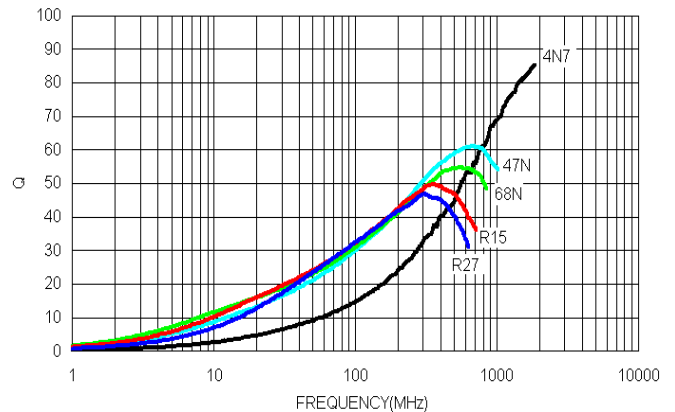

Please be sure to request approval specifications that provide further details of the products. Kindly note that the content of these specifications are subject to change or may be discontinued without prior notice. This product may not be designed/used in medical or high risk applications without Chilisin approval. Please contact our sales department before ordering.



CHILISIN ELECTRONICS CORP.

SMD Wire Wound Ceramic Chip Inductors – CS Series

Electrical Characteristics

| Part Number | Inductance (nH) | Tolerance (±%) | Test Frequency (MHz) | Q Min | Test Frequency (MHz) | SRF (MHz) Min | RDC (Ω) Max | I _{rms} (mA) Max | Color |
|---------------|--------------------|-------------------|----------------------------|----------|----------------------------|------------------|----------------|------------------------------|--------|
| CS0805-2N7□-S | 2.7 | 10 / 5 / 2 | 250 | 50 | 1500 | 7900 | 0.06 | 800 | Yellow |
| CS0805-2N8□-S | 2.8 | 10 / 5 / 2 | 250 | 80 | 1500 | 7900 | 0.06 | 800 | Gray |
| CS0805-3N0□-S | 3.0 | 10 / 5 / 2 | 250 | 65 | 1500 | 7900 | 0.06 | 800 | White |
| CS0805-3N3□-S | 3.3 | 10 / 5 / 2 | 250 | 50 | 1500 | 7900 | 0.08 | 600 | Black |
| CS0805-5N6□-S | 5.6 | 10 / 5 / 2 | 250 | 65 | 1000 | 5500 | 0.08 | 600 | Orange |
| CS0805-6N8□-S | 6.8 | 10 / 5 / 2 | 250 | 50 | 1000 | 5500 | 0.11 | 600 | Brown |
| CS0805-7N5□-S | 7.5 | 10 / 5 / 2 | 250 | 50 | 1000 | 4500 | 0.14 | 600 | Green |
| CS0805-8N2□-S | 8.2 | 10 / 5 / 2 | 250 | 50 | 1000 | 4700 | 0.12 | 600 | Red |
| CS0805-10N□-S | 10 | 10 / 5 / 2 | 250 | 60 | 500 | 4200 | 0.10 | 600 | Blue |
| CS0805-12N□-S | 12 | 10 / 5 / 2 | 250 | 50 | 500 | 4000 | 0.15 | 600 | Orange |
| CS0805-15N□-S | 15 | 10 / 5 / 2 | 250 | 50 | 500 | 3400 | 0.17 | 600 | Yellow |
| CS0805-18N□-S | 18 | 10 / 5 / 2 | 250 | 50 | 500 | 3300 | 0.20 | 600 | Green |
| CS0805-22N□-S | 22 | 10 / 5 / 2 | 250 | 55 | 500 | 2600 | 0.22 | 500 | Blue |
| CS0805-24N□-S | 24 | 10 / 5 / 2 | 250 | 50 | 500 | 2000 | 0.22 | 500 | Gray |
| CS0805-27N□-S | 27 | 10 / 5 / 2 | 250 | 55 | 500 | 2500 | 0.25 | 500 | Violet |
| CS0805-33N□-S | 33 | 10 / 5 / 2 | 250 | 60 | 500 | 2050 | 0.27 | 500 | Gray |
| CS0805-36N□-S | 36 | 10 / 5 / 2 | 250 | 55 | 500 | 1700 | 0.27 | 500 | Orange |
| CS0805-39N□-S | 39 | 10 / 5 / 2 | 250 | 60 | 500 | 2000 | 0.29 | 500 | White |
| CS0805-43N□-S | 43 | 10 / 5 / 2 | 200 | 60 | 500 | 1650 | 0.34 | 500 | Yellow |
| CS0805-47N□-S | 47 | 10 / 5 / 2 | 200 | 60 | 500 | 1650 | 0.31 | 500 | Black |
| CS0805-56N□-S | 56 | 10 / 5 / 2 | 200 | 60 | 500 | 1550 | 0.34 | 500 | Brown |
| CS0805-68N□-S | 68 | 10 / 5 / 2 | 200 | 60 | 500 | 1450 | 0.38 | 500 | Red |
| CS0805-82N□-S | 82 | 10 / 5 / 2 | 150 | 65 | 500 | 1300 | 0.42 | 400 | Orange |
| CS0805-91N□-S | 91 | 10 / 5 / 2 | 150 | 65 | 500 | 1200 | 0.48 | 400 | Black |
| CS0805-R10□-S | 100 | 10 / 5 / 2 | 150 | 65 | 500 | 1200 | 0.46 | 400 | Yellow |
| CS0805-R11□-S | 110 | 10 / 5 / 2 | 150 | 50 | 250 | 1000 | 0.48 | 400 | Brown |
| CS0805-R12□-S | 120 | 10 / 5 / 2 | 150 | 50 | 250 | 1100 | 0.51 | 400 | Green |
| CS0805-R15□-S | 150 | 10 / 5 / 2 | 100 | 50 | 250 | 920 | 0.56 | 400 | Blue |
| CS0805-R18□-S | 180 | 10 / 5 / 2 | 100 | 50 | 250 | 870 | 0.64 | 400 | Violet |
| CS0805-R20□-S | 200 | 10 / 5 / 2 | 100 | 50 | 250 | 860 | 0.68 | 400 | Red |
| CS0805-R22□-S | 220 | 10 / 5 / 2 | 100 | 50 | 250 | 850 | 0.70 | 400 | Gray |
| CS0805-R24□-S | 240 | 10 / 5 / 2 | 100 | 44 | 250 | 690 | 1.00 | 350 | Red |
| CS0805-R25□-S | 250 | 10 / 5 / 2 | 100 | 45 | 250 | 660 | 1.20 | 350 | Yellow |
| CS0805-R27□-S | 270 | 10 / 5 / 2 | 100 | 48 | 250 | 650 | 1.00 | 350 | White |
| CS0805-R30□-S | 300 | 10 / 5 / 2 | 100 | 25 | 250 | 450 | 1.40 | 310 | Orange |
| CS0805-R33□-S | 330 | 10 / 5 / 2 | 100 | 48 | 250 | 600 | 1.40 | 310 | Black |
| CS0805-R39□-S | 390 | 10 / 5 / 2 | 100 | 48 | 250 | 560 | 1.50 | 290 | Brown |
| CS0805-R47□-S | 470 | 10 / 5 / 2 | 50 | 33 | 100 | 450 | 1.76 | 250 | Violet |
| CS0805-R51□-S | 510 | 10 / 5 / 2 | 25 | 23 | 50 | 340 | 1.90 | 230 | Gray |
| CS0805-R56□-S | 560 | 10 / 5 / 2 | 25 | 23 | 50 | 340 | 1.90 | 230 | Orange |
| CS0805-R62□-S | 620 | 10 / 5 / 2 | 25 | 23 | 50 | 220 | 2.20 | 210 | Yellow |
| CS0805-R68□-S | 680 | 10 / 5 / 2 | 25 | 23 | 50 | 188 | 2.20 | 190 | Green |

Note: When ordering, please specify tolerance code. Tolerance : G=±2% , J=±5% , K=±10%

- Operating temperature range - 40°C ~ 125°C(Including self - temperature rise)
- I_{rms} for a 15°C temperature rise from 25°C ambient with current
- Measure Equipment :

L & Q : Agilent E4991A+Agilent HP16197A

SRF : Agilent HP8753D/Agilent E4991A

RDC : Chroma 16502

I_{rms} : HP4284A+HP42841A/HP4285A+HP42841A

Please be sure to request approval specifications that provide further details of the products. Kindly note that the content of these specifications are subject to change or may be discontinued without prior notice. This product may not be designed/used in medical or high risk applications without Chilisin approval. Please contact our sales department before ordering.



CHILISIN ELECTRONICS CORP.

SMD Wire Wound Ceramic Chip Inductors – CS Series

Electrical Characteristics

| Part Number | Inductance (nH) | Tolerance (±%) | Test Frequency (MHz) | Q Min | Test Frequency (MHz) | SRF (MHz) Min | RDC (Ω) Max | Irms (mA) Max | Color |
|---------------|-----------------|----------------|----------------------|-------|----------------------|---------------|-------------|---------------|--------|
| CS0805-R82□-S | 820 | 10 / 5 / 2 | 25 | 23 | 50 | 215 | 2.35 | 180 | Blue |
| CS0805-1R0□-S | 1000 | 10 / 5 / 2 | 25 | 20 | 50 | 100 | 2.50 | 170 | Gray |
| CS0805-1R2□-S | 1200 | 10 / 5 | 7.9 | 18 | 25 | 100 | 2.50 | 170 | White |
| CS0805-1R8□-S | 1800 | 10 / 5 / 2 | 7.9 | 16 | 7.9 | 80 | 2.50 | 170 | Orange |
| CS0805-3R3□-S | 3300 | 10 / 5 / 2 | 7.9 | 15 | 7.9 | 40 | 4.40 | 90 | Red |
| CS0805-4R7□-S | 4700 | 10 / 5 / 2 | 7.9 | 15 | 7.9 | 40 | 6.40 | 90 | Yellow |

Note: When ordering, please specify tolerance code. Tolerance : G=±2% , J=±5% , K=±10%

- Operating temperature range - 40°C ~ 125°C(Including self - temperature rise)
- I_{rms} for a 15°C temperature rise from 25°C ambient with current
- Measure Equipment :
 L & Q : Agilent E4991A+Agilent HP16197A
 SRF : Agilent HP8753D/Agilent E4991A
 RDC : Chroma 16502
 I_{rms} : HP4284A+HP42841A/HP4285A+HP42841A

Typical L vs. Frequency

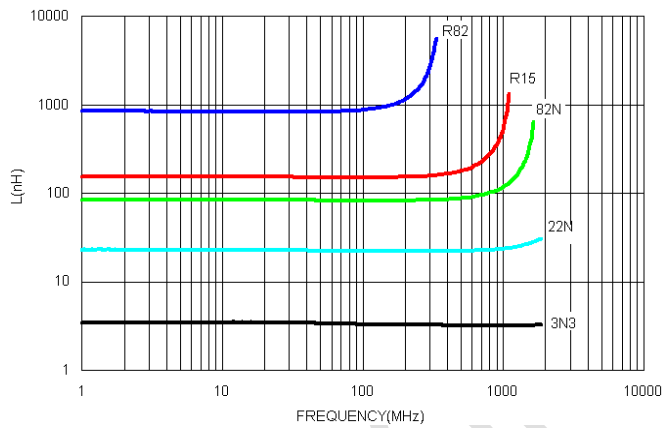

Typical Q vs. Frequency

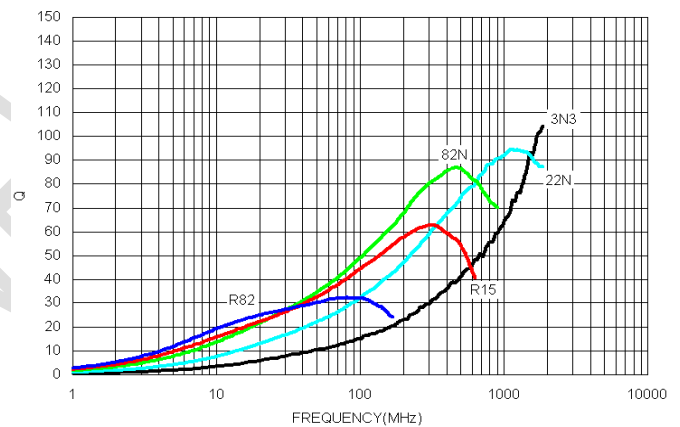

SMD Wire Wound Ceramic Chip Inductors – CS Series

Electrical Characteristics

| Part Number | Inductance (nH) | Tolerance (±%) | Test Frequency (MHz) | Q Min | Test Frequency (MHz) | SRF (MHz) Min | RDC (Ω) Max | I _{rms} (mA) Max | Color Coding | | |
|---------------|-----------------|----------------|----------------------|-------|----------------------|---------------|-------------|---------------------------|-----------------|-----------------|-----------------|
| | | | | | | | | | 1 ST | 2 ND | 3 RD |
| CS1008-10N□-S | 10 | 10 / 5 / 2 | 50 | 50 | 500 | 4100 | 0.08 | 1000 | Brown | Black | Black |
| CS1008-12N□-S | 12 | 10 / 5 / 2 | 50 | 50 | 500 | 3300 | 0.09 | 1000 | Brown | Red | Black |
| CS1008-15N□-S | 15 | 10 / 5 / 2 | 50 | 50 | 500 | 2500 | 0.10 | 1000 | Brown | Green | Black |
| CS1008-18N□-S | 18 | 10 / 5 / 2 | 50 | 50 | 350 | 2500 | 0.11 | 1000 | Brown | Gray | Black |
| CS1008-22N□-S | 22 | 10 / 5 / 2 | 50 | 55 | 350 | 2400 | 0.12 | 1000 | Red | Red | Black |
| CS1008-27N□-S | 27 | 10 / 5 / 2 | 50 | 55 | 350 | 1600 | 0.13 | 1000 | Red | Violet | Black |
| CS1008-33N□-S | 33 | 10 / 5 / 2 | 50 | 60 | 350 | 1600 | 0.14 | 1000 | Orange | Orange | Black |
| CS1008-39N□-S | 39 | 10 / 5 / 2 | 50 | 60 | 350 | 1500 | 0.15 | 1000 | Orange | White | Black |
| CS1008-47N□-S | 47 | 10 / 5 / 2 | 50 | 65 | 350 | 1500 | 0.16 | 1000 | Yellow | Violet | Black |
| CS1008-56N□-S | 56 | 10 / 5 / 2 | 50 | 65 | 350 | 1300 | 0.18 | 1000 | Green | Blue | Black |
| CS1008-68N□-S | 68 | 10 / 5 / 2 | 50 | 65 | 350 | 1300 | 0.20 | 1000 | Blue | Gray | Black |
| CS1008-82N□-S | 82 | 10 / 5 / 2 | 50 | 60 | 350 | 1000 | 0.22 | 1000 | Gray | Red | Black |
| CS1008-R10□-S | 100 | 10 / 5 / 2 | 25 | 60 | 350 | 1000 | 0.56 | 650 | Brown | Black | Brown |
| CS1008-R12□-S | 120 | 10 / 5 / 2 | 25 | 60 | 350 | 950 | 0.63 | 650 | Brown | Red | Brown |
| CS1008-R15□-S | 150 | 10 / 5 / 2 | 25 | 45 | 100 | 850 | 0.70 | 580 | Brown | Green | Brown |
| CS1008-R18□-S | 180 | 10 / 5 / 2 | 25 | 45 | 100 | 750 | 0.77 | 620 | Brown | Gray | Brown |
| CS1008-R20□-S | 200 | 10 / 5 / 2 | 25 | 45 | 100 | 700 | 0.84 | 500 | Red | Black | Brown |
| CS1008-R22□-S | 220 | 10 / 5 / 2 | 25 | 45 | 100 | 700 | 0.84 | 500 | Red | Red | Brown |
| CS1008-R27□-S | 270 | 10 / 5 / 2 | 25 | 45 | 100 | 600 | 0.91 | 500 | Red | Violet | Brown |
| CS1008-R33□-S | 330 | 10 / 5 / 2 | 25 | 45 | 100 | 570 | 1.05 | 450 | Orange | Orange | Brown |
| CS1008-R39□-S | 390 | 10 / 5 / 2 | 25 | 45 | 100 | 500 | 1.12 | 470 | Orange | White | Brown |
| CS1008-R47□-S | 470 | 10 / 5 / 2 | 25 | 45 | 100 | 450 | 1.19 | 470 | Yellow | Violet | Brown |
| CS1008-R56□-S | 560 | 10 / 5 / 2 | 25 | 45 | 100 | 415 | 1.33 | 400 | Green | Blue | Brown |
| CS1008-R62□-S | 620 | 10 / 5 / 2 | 25 | 45 | 100 | 375 | 1.40 | 300 | Blue | Red | Brown |
| CS1008-R68□-S | 680 | 10 / 5 / 2 | 25 | 45 | 100 | 375 | 1.47 | 400 | Blue | Gray | Brown |
| CS1008-R75□-S | 750 | 10 / 5 / 2 | 25 | 45 | 100 | 360 | 1.54 | 360 | Violet | Green | Brown |
| CS1008-R82□-S | 820 | 10 / 5 / 2 | 25 | 45 | 100 | 350 | 1.61 | 400 | Gray | Red | Brown |
| CS1008-R91□-S | 910 | 10 / 5 / 2 | 25 | 35 | 50 | 320 | 1.68 | 380 | White | Brown | Brown |
| CS1008-1R0□-S | 1000 | 10 / 5 / 2 | 25 | 35 | 50 | 290 | 1.75 | 370 | Brown | Black | Red |
| CS1008-1R2□-S | 1200 | 10 / 5 / 2 | 7.9 | 35 | 50 | 250 | 2.0 | 310 | Brown | Red | Red |
| CS1008-1R5□-S | 1500 | 10 / 5 / 2 | 7.9 | 28 | 50 | 200 | 2.3 | 330 | Brown | Green | Red |
| CS1008-1R8□-S | 1800 | 10 / 5 / 2 | 7.9 | 28 | 50 | 160 | 2.6 | 300 | Brown | Gray | Red |
| CS1008-2R2□-S | 2200 | 10 / 5 / 2 | 7.9 | 28 | 50 | 160 | 2.8 | 280 | Red | Red | Red |
| CS1008-2R7□-S | 2700 | 10 / 5 / 2 | 7.9 | 22 | 25 | 140 | 3.2 | 290 | Red | Violet | Red |
| CS1008-3R3□-S | 3300 | 10 / 5 / 2 | 7.9 | 22 | 25 | 110 | 3.4 | 290 | Orange | Orange | Red |
| CS1008-3R9□-S | 3900 | 10 / 5 / 2 | 7.9 | 20 | 25 | 100 | 3.6 | 260 | Orange | White | Red |
| CS1008-4R7□-S | 4700 | 10 / 5 / 2 | 7.9 | 20 | 25 | 90 | 4.0 | 260 | Yellow | Violet | Red |
| CS1008-5R6□-S | 5600 | 10 / 5 / 2 | 7.9 | 18 | 7.9 | 45 | 4.0 | 240 | Green | Blue | Red |
| CS1008-6R8□-S | 6800 | 10 / 5 / 2 | 7.9 | 18 | 7.9 | 40 | 4.9 | 200 | Blue | Gray | Red |
| CS1008-8R2□-S | 8200 | 10 / 5 / 2 | 7.9 | 18 | 7.9 | 25 | 6.0 | 170 | Gray | Red | Red |
| CS1008-100□-S | 10000 | 10 / 5 / 2 | 2.52 | 18 | 7.9 | 25 | 8.0 | 150 | Brown | Black | Orange |
| CS1008-150□-S | 15000 | 10 / 5 / 2 | 2.52 | 15 | 7.9 | 20 | 11 | 100 | Brown | Green | Orange |

Note: When ordering, please specify tolerance code. Tolerance : G=±2% , J=±5% , K=±10%

- Operating temperature range - 40°C ~ 125°C(Including self - temperature rise)
- I_{rms} for a 15°C temperature rise from 25°C ambient with current
- Measure Equipment :

L & Q : Agilent E4991A+Agilent HP16197A

SRF : Agilent HP8753D/Agilent E4991A

RDC : Chroma 16502

I_{rms} : HP4284A+HP42841A/HP4285A+HP42841A

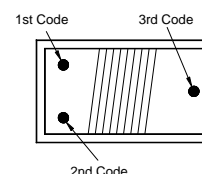

COLOR CODING

Please be sure to request approval specifications that provide further details of the products. Kindly note that the content of these specifications are subject to change or may be discontinued without prior notice. This product may not be designed/used in medical or high risk applications without Chilisin approval. Please contact our sales department before ordering.



CHILISIN ELECTRONICS CORP.

SMD Wire Wound Ceramic Chip Inductors – CS Series

Typical **L** vs. **F**requency

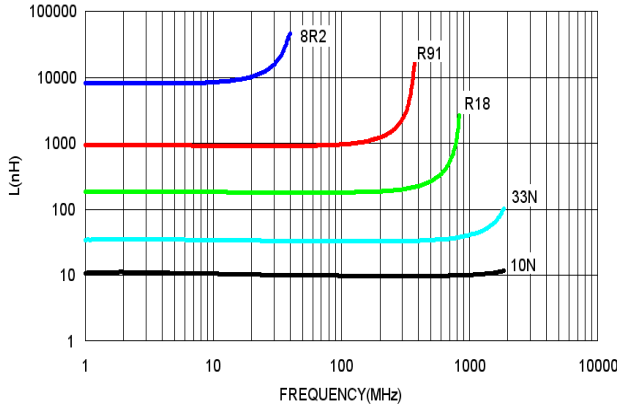

Typical **Q** vs. **F**requency

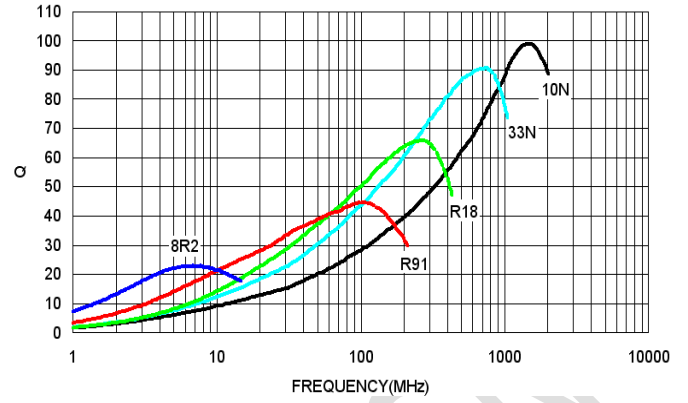

NOT FOR NEW DESIGN

Please be sure to request approval specifications that provide further details of the products. Kindly note that the content of these specifications are subject to change or may be discontinued without prior notice. This product may not be designed/used in medical or high risk applications without Chilisin approval. Please contact our sales department before ordering.

SMD Wire Wound Ceramic Chip Inductors – CS Series

Electrical Characteristics

| Part Number | Inductance (uH) | Tolerance (±%) | Test Frequency (MHz) | Q Min | Test Frequency (MHz) | SRF (MHz) Min | RDC (Ω) Max | Irms (mA) Typ |
|---------------|-----------------|----------------|----------------------|-------|----------------------|---------------|-------------|---------------|
| CS1812-1R0□-N | 1.0 | J | 7.9 | 60 | 50 | 310 | 1.2 | 480 |
| CS1812-1R2□-N | 1.2 | J | 7.9 | 62 | 50 | 230 | 1.2 | 480 |
| CS1812-1R5□-N | 1.5 | J | 7.9 | 65 | 50 | 210 | 1.6 | 430 |
| CS1812-1R8□-N | 1.8 | J | 7.9 | 68 | 50 | 190 | 2.0 | 380 |
| CS1812-2R2□-N | 2.2 | J | 7.9 | 63 | 50 | 170 | 2.2 | 340 |
| CS1812-2R7□-N | 2.7 | J | 7.9 | 60 | 50 | 160 | 3.2 | 300 |
| CS1812-3R3□-N | 3.3 | J | 7.9 | 60 | 50 | 145 | 3.8 | 270 |
| CS1812-3R9□-N | 3.9 | J | 7.9 | 61 | 50 | 130 | 5.0 | 240 |
| CS1812-4R7□-N | 4.7 | J | 7.9 | 60 | 50 | 115 | 5.4 | 230 |
| CS1812-5R6□-N | 5.6 | J | 7.9 | 42 | 50 | 100 | 5.7 | 220 |
| CS1812-6R8□-N | 6.8 | J | 7.9 | 32 | 50 | 90 | 6.6 | 210 |
| CS1812-8R2□-N | 8.2 | J | 7.9 | 35 | 50 | 80 | 7.0 | 200 |
| CS1812-100□-N | 10 | J | 7.9 | 27 | 50 | 70 | 7.7 | 190 |
| CS1812-120□-N | 12 | J | 2.5 | 34 | 10 | 58 | 8.7 | 180 |
| CS1812-150□-N | 15 | J | 2.5 | 32 | 10 | 48 | 9.6 | 170 |
| CS1812-180□-N | 18 | J | 2.5 | 28 | 10 | 36 | 10.5 | 160 |
| CS1812-220□-N | 22 | J | 2.5 | 28 | 10 | 34 | 11.5 | 155 |
| CS1812-270□-N | 27 | J | 2.5 | 28 | 10 | 30 | 12.5 | 150 |
| CS1812-330□-N | 33 | J | 2.5 | 20 | 10 | 20 | 13.5 | 145 |

Note: When ordering, please specify tolerance code. Tolerance : J=±5%

- Operating temperature range - 40°C ~ 125°C(Including self - temperature rise)
- Irms for a 15°C temperature rise from 25°C ambient with current
- Measure Equipment :
 L & Q : HP4286A/HP4287A/AgilentE4991/Keysight E4982A
 SRF : Agilent HP8753D/Agilent E4991A
 RDC : Chroma 16502
 Irms : HP4284A+HP42841A/HP4285A+HP42841A

Typical **L** vs. **F** Frequency

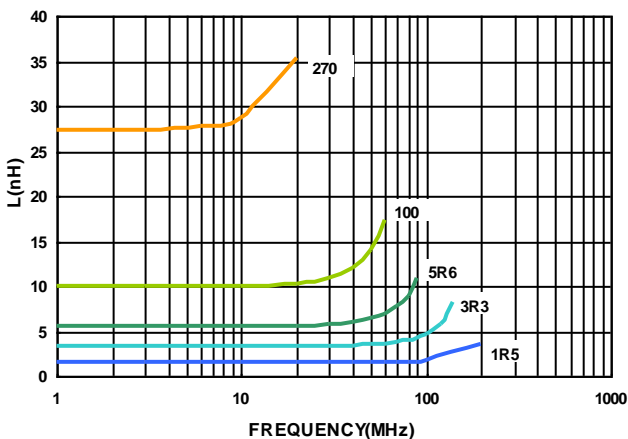

Typical **Q** vs. **F** Frequency

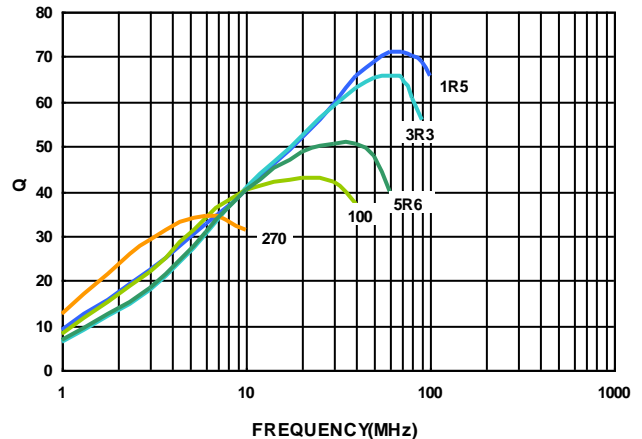

Please be sure to request approval specifications that provide further details of the products. Kindly note that the content of these specifications are subject to change or may be discontinued without prior notice. This product may not be designed/used in medical or high risk applications without Chilisin approval. Please contact our sales department before ordering.

Packaging Specifications

Tape Dimensions

Figure 1

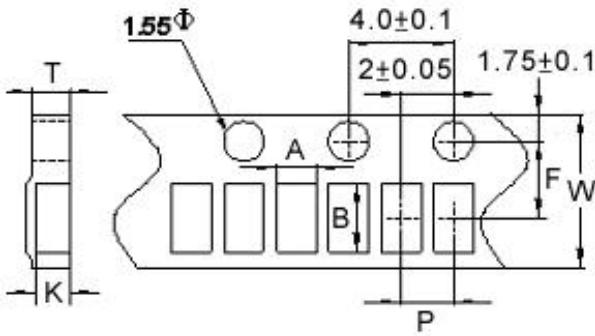

Figure 2

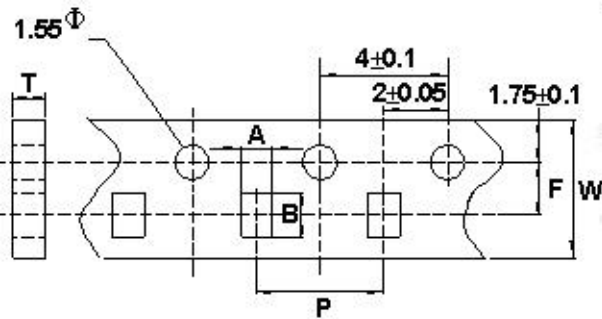
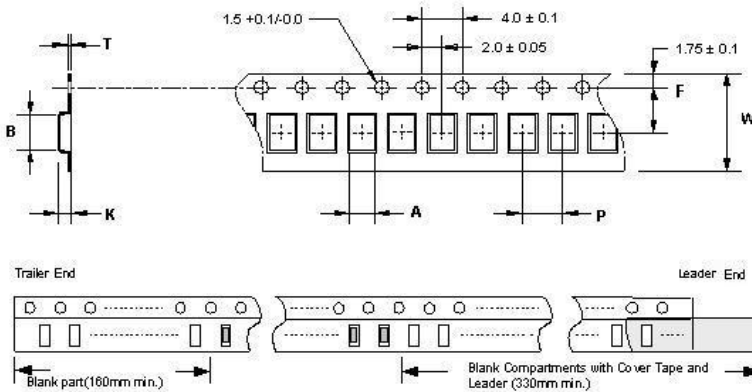
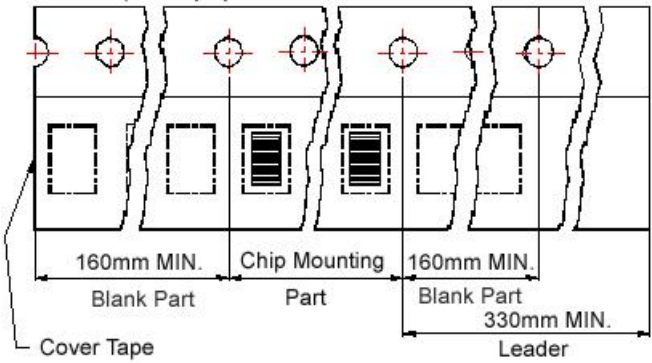

Figure 3



Tape Material

Carrier Tape: Paper
Cover Tape: Polystyrene



Carrier Tape: Paper
Cover Tape: Polystyrene

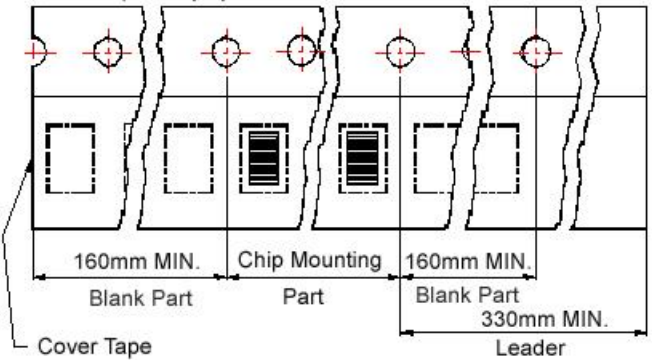

Reel Dimensions

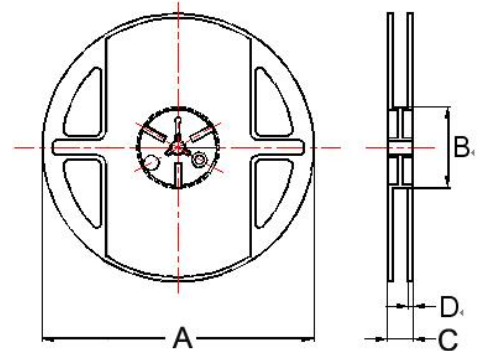

Dimensions in mm

| TYPE | Fig. | Tape Dimensions | | | | | | | Reel Dimensions | | | | Quantity PCS / Reel |
|--------|------|-----------------|------|------|----|---|-----|------|-----------------|----|----|-----|------------------------|
| | | A | B | T | W | P | F | K | A | B | C | D | |
| CS0201 | 1 | 0.47 | 0.57 | 0.65 | 8 | 2 | 3.5 | 0.45 | 178 | 60 | 12 | 1.5 | 4000 |
| CS0402 | 1 | 0.67 | 1.20 | 0.75 | 8 | 2 | 3.5 | 0.59 | 178 | 60 | 12 | 1.5 | 4000 |
| CS0603 | 2 | 1.25 | 1.90 | 1.05 | 8 | 4 | 3.5 | - | 178 | 60 | 12 | 1.5 | 4000 |
| CS0805 | 3 | 1.85 | 2.45 | 0.23 | 8 | 4 | 3.5 | 1.50 | 178 | 60 | 12 | 1.5 | 2000 |
| CS1008 | 3 | 2.80 | 2.95 | 0.23 | 8 | 4 | 3.5 | 2.20 | 178 | 60 | 12 | 1.5 | 2000 |
| CS1812 | 3 | 3.90 | 4.90 | 0.30 | 12 | 8 | 5.5 | 3.20 | 178 | 60 | 16 | 1.4 | 600 |

X-ON Electronics

Largest Supplier of Electrical and Electronic Components

Click to view similar products for [Fixed Inductors](#) category:

Click to view products by [Chilisin](#) manufacturer:

Other Similar products are found below :

[CR32NP-151KC](#) [CR32NP-180KC](#) [CR32NP-181KC](#) [CR32NP-1R5MC](#) [CR32NP-390KC](#) [CR32NP-3R9MC](#) [CR32NP-680KC](#) [CR32NP-820KC](#) [CR32NP-8R2MC](#) [CR43NP-390KC](#) [CR43NP-560KC](#) [CR43NP-680KC](#) [CR54NP-181KC](#) [CR54NP-470LC](#) [CR54NP-820KC](#) [CR54NP-8R5MC](#) [70F224AI](#) [MGDQ4-00004-P](#) [MHL1ECTTP18NJ](#) [MHQ1005P10NJ](#) [MHQ1005P1N0S](#) [MHQ1005P2N4S](#) [MHQ1005P3N6S](#) [MHQ1005P5N1S](#) [MHQ1005P8N2J](#) [PE-51506NL](#) [PE-53601NL](#) [PE-53602NL](#) [PE-53630NL](#) [PE-53824SNLT](#) [PE-92100NL](#) [PG0434.801NLT](#) [PG0936.113NLT](#) [9220-20](#) [9310-16](#) [PM06-2N7](#) [PM06-39NJ](#) [A01TK](#) [1206CS-471XJ](#) [HC2LP-R47-R](#) [HC2-R47-R](#) [HC3-2R2-R](#) [HCF1305-3R3-R](#) [1206CS-151XG](#) [RCH664NP-140L](#) [RCH664NP-4R7M](#) [RCH8011NP-221L](#) [RCP1317NP-332L](#) [RCP1317NP-391L](#) [RCR1010NP-470M](#)