

## Cautions and Warnings

Please be noted that this spec is only for reference if you have projects designed with the product number listed in. If you are looking for new project design-in, please find BDHE Series specification/datasheet on Chilisin website. Or you may find our sales contact for more information on old part number at your convenience. Appreciated your attention and understanding.

**Note:** Please be sure to request approval specifications that provide further details of the products. Kindly note that the content of these specifications are subject to change or may be discontinued without prior notice. This product may not be designed/used in medical or high risk applications without Chilisin approval. Please contact our sales department before ordering.

## HEI Series

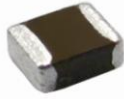

The HEI Series is designed specifically to enhance both PFM and PWM application performance. Q(Rac) value at light load and the RDC value at heavy load are both exceptional. Furthermore, the saturated current performance is also optimal, helping to reduce the ripple current and enhance the efficiency.

### Features

- RoHS, Halogen Free and REACH Compliance
- High Efficiency
- Excellent Q, RDC and saturation current
- Low profile and miniature size down to 1.6\*0.8\*0.8mm

### Applications

- Smartphones, tablets and wearable devices
- HDD, SSD and PC peripheral devices
- DSC, camcorders
- PND
- DC/DC converters

### Product Identification

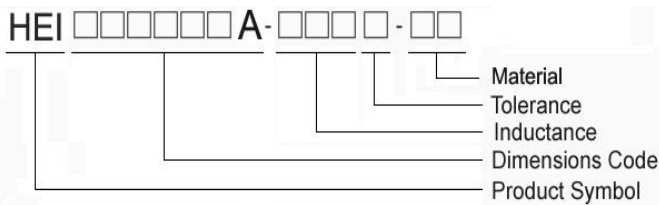

### Shape and Dimensions

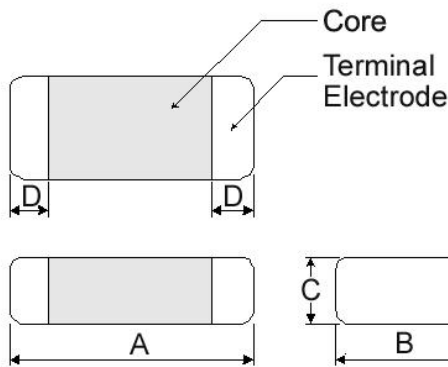

### Recommended Pattern

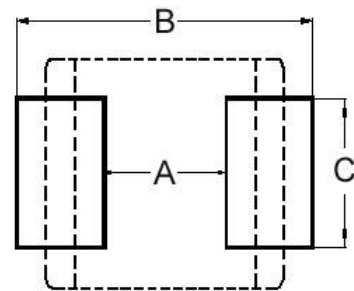

Dimensions in mm

TYPE	A	B	C	D
160808A	1.6±0.2	0.80±0.2	0.8Max	0.3±0.2
201208A	2.0±0.2	1.25±0.2	0.8Max	0.5±0.3
201210A	2.0±0.2	1.25±0.2	1.0Max	0.5±0.3
201608A	2.0±0.2	1.60±0.2	0.8Max	0.5±0.3
201610A	2.0±0.2	1.60±0.2	1.0Max	0.5±0.3
252010A	2.5±0.3	2.00±0.3	1.0Max	0.6±0.3
252012A	2.5±0.3	2.00±0.3	1.2Max	0.6±0.3
322510A	3.2±0.3	2.50±0.3	1.0Max	0.5±0.3
322512A	3.2±0.3	2.50±0.3	1.2Max	0.5±0.3
322525A	3.2±0.3	2.50±0.3	2.50±0.3	0.5±0.3

Dimensions in mm

TYPE	A	B	C
160808A	0.7~0.8	1.8~2.0	0.8~1.1
201208A	0.8~1.2	2.3~2.9	1.0~1.45
201210A	0.8~1.2	2.3~2.9	1.0~1.45
201608A	0.7	2.3	1.8
201610A	0.7	2.3	1.8
252010A	1.2	2.8	2.3
252012A	1.2	2.8	2.3
322510A	1.7	3.5	2.8
322512A	1.7	3.5	2.8
322525A	1.7	3.5	2.8

# Molding Power Inductors – HEI Series

## Electrical Characteristics

Part Number	Inductance (uH)	Tolerance (±%)	Test Frequency (MHz)	RDC(mΩ) Max(Typ.)	Isat(A) Max(Typ.)	Irms(A) Max(Typ.)
HEI160808A-R47M-Q8	0.47	20	2	100(87)	2.2(2.6)	1.6(2.0)

**Note: When ordering, please specify tolerance code. Tolerance: M=±20%**

- Operating temperature range - 40°C ~ 125°C(Including self - temperature rise)
- Isat for Inductance drop 30% from its value without current
- I rms for a 40°C temperature rise from 25°C ambient with current
- Absolute maximum voltage 20VDC
- Measure Equipment :  
 L : Agilent E4991/HP4286A+16197A (or equivalent), 2MHz 0.2V  
 RDC : CHEN HWA502BC/HP4338B (or equivalent)  
 Isat : Agilent E4980A+HP42841A (or equivalent)  
 I rms : Agilent 6641 SYSTEM DC POWER SUPPLY (or equivalent)

**Test Instruments :** E4991A Impedance / Material Analyzer

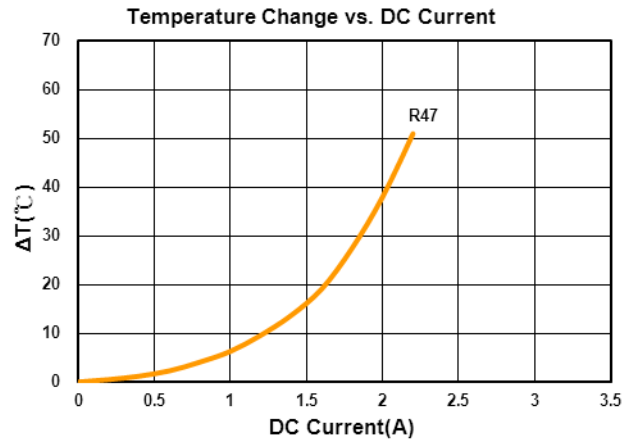
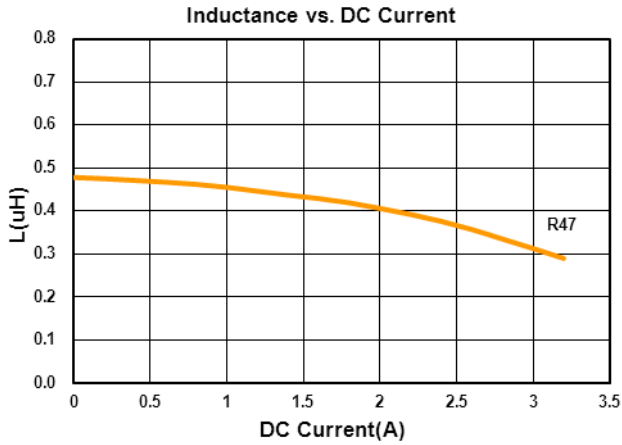

# Molding Power Inductors – HEI Series

## Electrical Characteristics

Part Number	Inductance (uH)	Tolerance (±%)	Test Frequency (MHz)	RDC(mΩ) Max(Typ.)	Isat(A) Max(Typ.)	Irms(A) Max(Typ.)
HEI201208A-R24M-Q8	0.24	20	2	25(19)	4.8(5.4)	4.2(4.8)
HEI201208A-R47M-Q8	0.47	20	2	48(40)	3.2(3.6)	3.0(3.4)

**Note: When ordering, please specify tolerance code. Tolerance: M=±20%**

- Operating temperature range - 40°C ~ 125°C(Including self - temperature rise)
- Isat for Inductance drop 30% from its value without current
- I rms for a 40°C temperature rise from 25°C ambient with current
- Absolute maximum voltage 20VDC
- Measure Equipment :  
 L : Agilent E4991/HP4286A+16197A (or equivalent), 2MHz 0.2V  
 RDC : CHEN HWA502BC/HP4338B (or equivalent)  
 Isat : Agilent E4980A+HP42841A (or equivalent)  
 I rms : Agilent 6641 SYSTEM DC POWER SUPPLY (or equivalent)

**Test Instruments :** E4991A Impedance / Material Analyzer

**Inductance vs. DC Current**

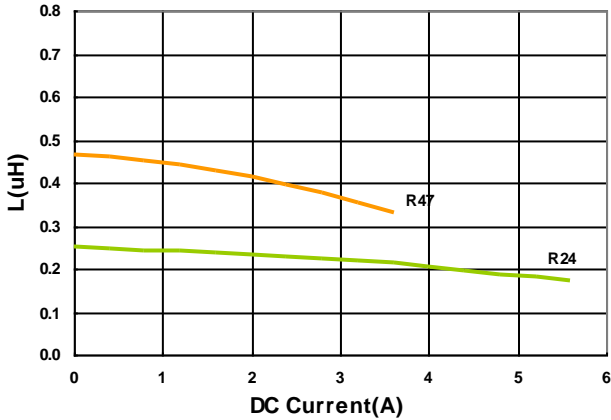

**Temperature Change vs. DC Current**

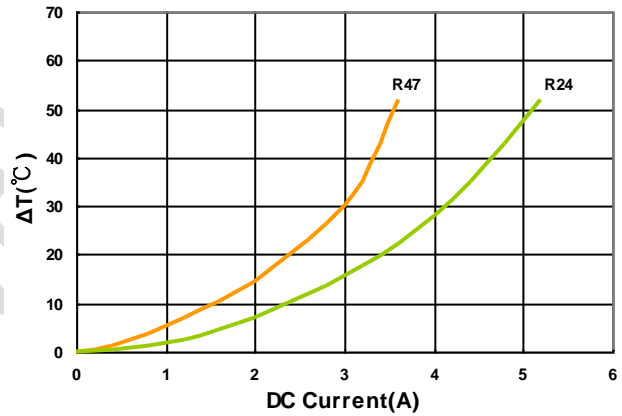

# Molding Power Inductors – HEI Series

## Electrical Characteristics

Part Number	Inductance (uH)	Tolerance (±%)	Test Frequency (MHz)	RDC(mΩ) Max(Typ.)	Isat(A) Max(Typ.)	Irms(A) Max(Typ.)
HEI201210A-R24M-Q8	0.24	20	2	28(22)	4.5(5.7)	3.7(4.6)
HEI201210A-R47M-Q8	0.47	20	2	42(33)	3.3(4.2)	3.0(3.7)
HEI201210A-1R0M-Q8	1.0	20	2	78(69)	2.3(2.8)	2.2(2.7)
HEI201210A-1R5M-Q8	1.5	20	2	126(108)	1.7(2.2)	1.6(2.1)
HEI201210A-2R2M-Q8	2.2	20	2	176(166)	1.6(1.7)	1.4(1.5)

**Note: When ordering, please specify tolerance code. Tolerance: M=±20%**

- Operating temperature range - 40°C ~ 125°C(Including self - temperature rise)
- Isat for Inductance drop 30% from its value without current
- I rms for a 40°C temperature rise from 25°C ambient with current
- Absolute maximum voltage 20VDC
- Measure Equipment :  
 L : Agilent E4991/HP4286A+16197A (or equivalent), 2MHz 0.2V  
 RDC : CHEN HWA502BC/HP4338B (or equivalent)  
 Isat : Agilent E4980A+HP42841A (or equivalent)  
 I rms : Agilent 6641 SYSTEM DC POWER SUPPLY (or equivalent)

**Test Instruments :** E4991A Impedance / Material Analyzer

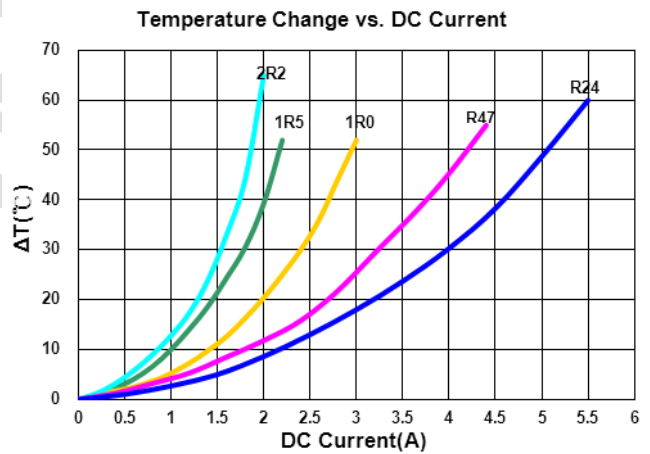
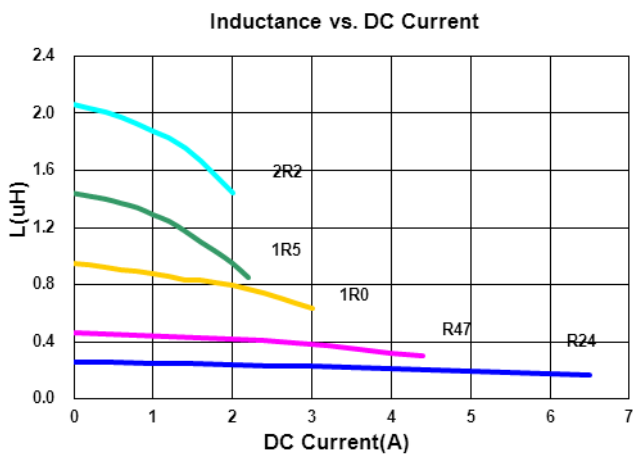

# Molding Power Inductors – HEI Series

## Electrical Characteristics

Part Number	Inductance (uH)	Tolerance (±%)	Test Frequency (MHz)	RDC(mΩ) Max(Typ.)	Isat(A) Max(Typ.)	Irms(A) Max(Typ.)
HEI201608A-R47M-Q8	0.47	20	2	51(42)	3.3(3.6)	3.1(3.4)
HEI201608A-1R0M-Q8	1.0	20	2	87(76)	2.5(2.8)	2.3(2.7)
HEI201608A-1R5M-Q8	1.5	20	2	115(102)	2.0(2.3)	2.1(2.4)

**Note: When ordering, please specify tolerance code. Tolerance: M=±20%**

- Operating temperature range - 40°C ~ 125°C(Including self - temperature rise)
- Isat for Inductance drop 30% from its value without current
- I rms for a 40°C temperature rise from 25°C ambient with current
- Absolute maximum voltage 25VDC
- Measure Equipment :  
 L : Agilent E4991/HP4286A+16197A (or equivalent), 2MHz 0.2V  
 RDC : CHEN HWA502BC/HP4338B (or equivalent)  
 Isat : Agilent E4980A+HP42841A (or equivalent)  
 I rms : Agilent 6641 SYSTEM DC POWER SUPPLY (or equivalent)

**Test Instruments : E4991A Impedance / Material Analyzer**

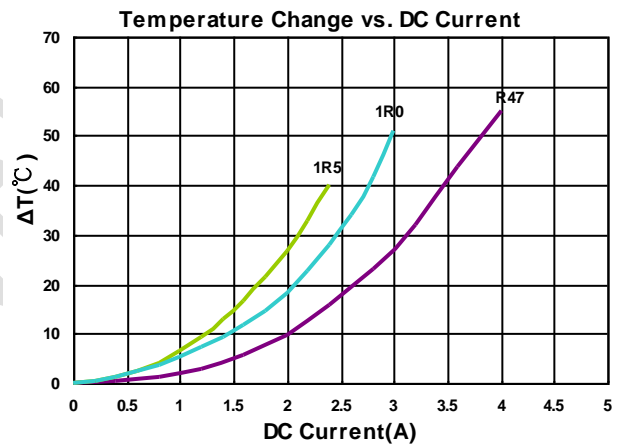
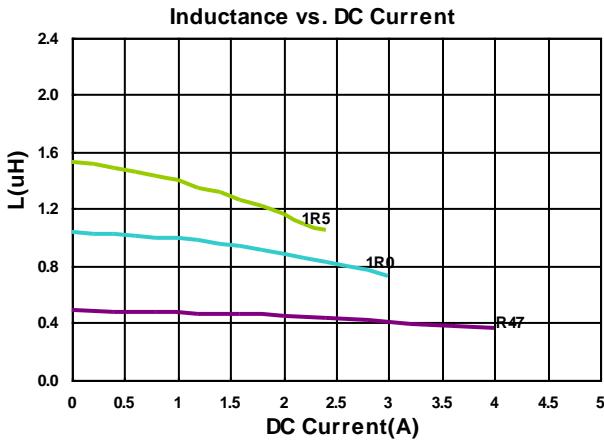

# Molding Power Inductors – HEI Series

## Electrical Characteristics

Part Number	Inductance (uH)	Tolerance (±%)	Test Frequency (MHz)	RDC(mΩ) Max(Typ.)	Isat(A) Max(Typ.)	Irms(A) Max(Typ.)
HEI201610A-R24M-Q8	0.24	20	2	27(21)	5.6(7.0)	3.9(4.8)
HEI201610A-R47M-Q8	0.47	20	2	42(33)	3.9(4.8)	3.5(4.2)
HEI201610A-R68M-Q8	0.68	20	2	56(43)	3.2(4.0)	2.7(3.4)
HEI201610A-1R0M-Q8	1.0	20	2	65(53)	2.9(3.6)	2.5(3.1)
HEI201610A-1R5M-Q8	1.5	20	2	85(75)	2.5(2.8)	2.3(2.7)
HEI201610A-2R2M-Q8	2.2	20	2	135(112)	2.4(2.7)	1.8(2.2)

**Note: When ordering, please specify tolerance code. Tolerance: M=±20%**

- Operating temperature range - 40°C ~ 125°C(Including self - temperature rise)
- Isat for Inductance drop 30% from its value without current
- I rms for a 40°C temperature rise from 25°C ambient with current
- Absolute maximum voltage 25VDC
- Measure Equipment :  
 L : Agilent E4991/HP4286A+16197A (or equivalent), 2MHz 0.2V  
 RDC : CHEN HWA502BC/HP4338B (or equivalent)  
 Isat : Agilent E4980A+HP42841A (or equivalent)  
 I rms : Agilent 6641 SYSTEM DC POWER SUPPLY (or equivalent)

**Test Instruments :** E4991A Impedance / Material Analyzer

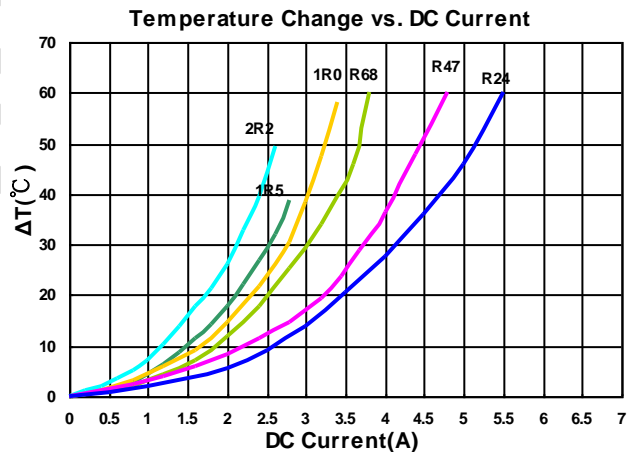
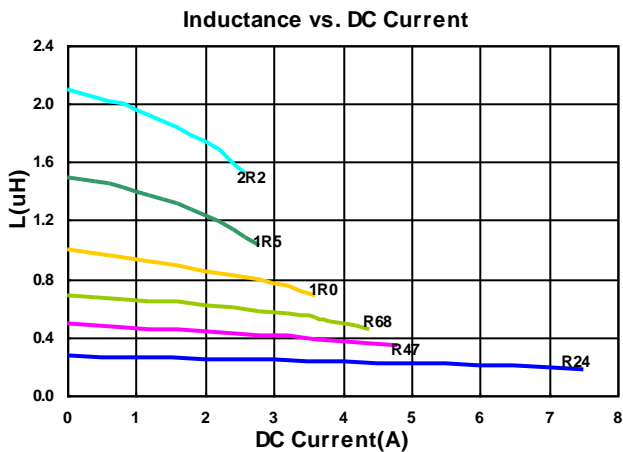

# Molding Power Inductors – HEI Series

## Electrical Characteristics

Part Number	Inductance (uH)	Tolerance (±%)	Test Frequency (MHz)	RDC(mΩ) Max(Typ.)	Isat(A) Max(Typ.)	Irms(A) Max(Typ.)
HEI252010A-R24M-Q8	0.24	20	2	18(13)	8.0(9.5)	5.5(6.5)
HEI252010A-R33M-Q8	0.33	20	2	24(18)	6.5(8.0)	4.8(5.5)
HEI252010A-R47M-Q8	0.47	20	2	35(27)	5.0(6.2)	3.9(4.5)
HEI252010A-R68M-Q8	0.68	20	2	40(32)	4.5(5.6)	3.7(4.2)
HEI252010A-1R0M-Q8	1.0	20	2	53(45)	3.7(4.6)	3.0(3.5)
HEI252010A-1R5M-Q8	1.5	20	2	75(68)	3.1(3.8)	2.4(2.8)
HEI252010A-2R2M-Q8	2.2	20	2	97(87)	2.5(3.0)	2.2(2.5)

**Note: When ordering, please specify tolerance code. Tolerance: M=±20%**

- Operating temperature range - 40°C ~ 125°C(Including self - temperature rise)
- Isat for Inductance drop 30% from its value without current
- I rms for a 40°C temperature rise from 25°C ambient with current
- Absolute maximum voltage 25VDC
- Measure Equipment :  
 L : Agilent E4991/HP4286A+16197A (or equivalent), 2MHz 0.2V  
 RDC : CHEN HWA502BC/HP4338B (or equivalent)  
 Isat : Agilent E4980A+HP42841A (or equivalent)  
 I rms : Agilent 6641 SYSTEM DC POWER SUPPLY (or equivalent)

**Test Instruments : E4991A Impedance / Material Analyzer**

**Inductance vs. DC Current**

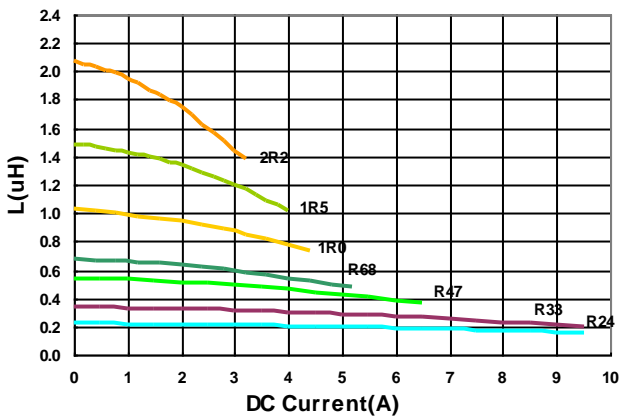

**Temperature Change vs. DC Current**

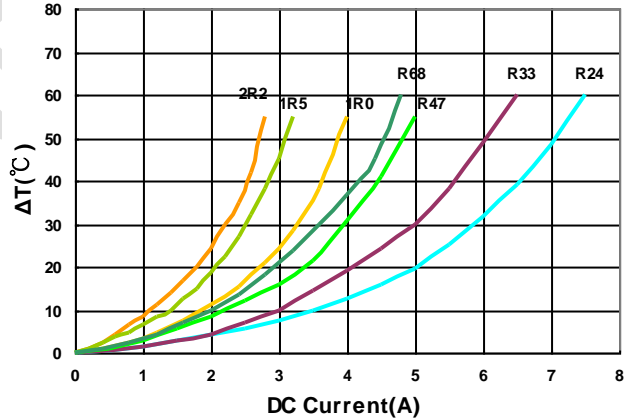



## Electrical Characteristics

Part Number	Inductance (uH)	Tolerance (±%)	Test Frequency (MHz)	RDC(mΩ) Max(Typ.)	Isat(A) Max(Typ.)	Irms(A) Max(Typ.)
HEI252012A-R24M-Q8	0.24	20	2	15(11.5)	9.0(10.5)	6.2(7.3)
HEI252012A-R33M-Q8	0.33	20	2	18(14.5)	8.5(10)	5.8(6.4)
HEI252012A-R47M-Q8	0.47	20	2	33(28)	5.6(7.0)	3.8(4.5)
HEI252012A-R68M-Q8	0.68	20	2	36(30)	5.0(6.2)	3.8(4.4)
HEI252012A-1R0M-Q8	1.0	20	2	42(35)	4.4(5.5)	3.6(4.1)
HEI252012A-1R5M-Q8	1.5	20	2	65(57)	3.4(4.2)	2.7(3.1)
HEI252012A-2R2M-Q8	2.2	20	2	83(74)	3.0(3.7)	2.5(2.9)

**Note: When ordering, please specify tolerance code. Tolerance: M=±20%**

- Operating temperature range - 40°C ~ 125°C(Including self - temperature rise)
- Isat for Inductance drop 30% from its value without current
- I rms for a 40°C temperature rise from 25°C ambient with current
- Absolute maximum voltage 25VDC
- Measure Equipment :  
 L : Agilent E4991/HP4286A+16197A (or equivalent), 2MHz 0.2V  
 RDC : CHEN HWA502BC/HP4338B (or equivalent)  
 Isat : Agilent E4980A+HP42841A (or equivalent)  
 I rms : Agilent 6641 SYSTEM DC POWER SUPPLY (or equivalent)

**Test Instruments :** E4991A Impedance / Material Analyzer

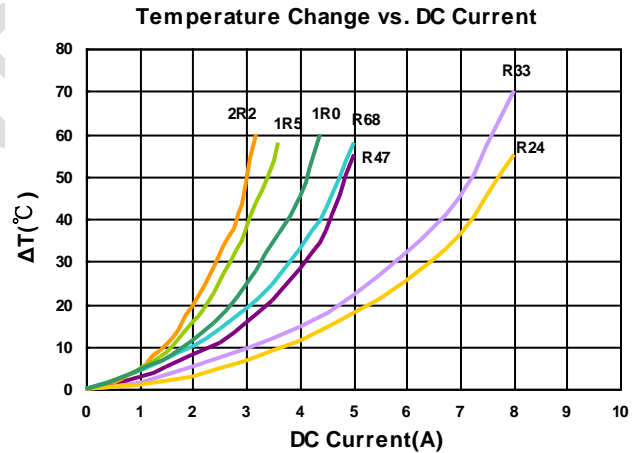
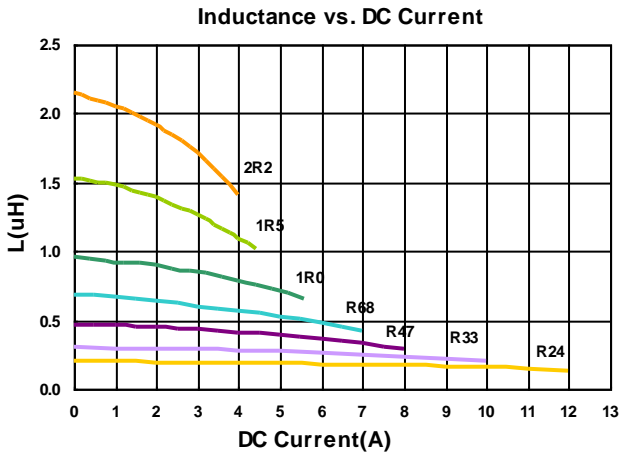

# Molding Power Inductors – HEI Series

## Electrical Characteristics

Part Number	Inductance (uH)	Tolerance (±%)	Test Frequency (MHz)	RDC(mΩ) Max(Typ.)	Isat(A) Max(Typ.)	Irms(A) Max(Typ.)
HEI322510A-R24M-Q8	0.24	20	2	16(12)	9.0(11.5)	6.0(6.8)
HEI322510A-R33M-Q8	0.33	20	2	17(12.5)	8.0(9.5)	5.8(6.5)
HEI322510A-R47M-Q8	0.47	20	2	24(19)	6.0(7.3)	4.5(5.4)
HEI322510A-1R0M-Q8	1.0	20	2	46(39)	4.1(4.7)	3.3(3.7)
HEI322510A-1R5M-Q8	1.5	20	2	58(50)	3.5(4.0)	3.2(3.5)
HEI322510A-2R2M-Q8	2.2	20	2	85(73)	3.0(3.5)	2.5(2.8)

**Note: When ordering, please specify tolerance code. Tolerance: M=±20%**

- Operating temperature range - 40°C ~ 125°C(Including self - temperature rise)
- Isat for Inductance drop 30% from its value without current
- I rms for a 40°C temperature rise from 25°C ambient with current
- Absolute maximum voltage 25VDC
- Measure Equipment :  
 L : Agilent E4991/HP4286A+16197A (or equivalent), 2MHz 0.2V  
 RDC : CHEN HWA502BC/HP4338B (or equivalent)  
 Isat : Agilent E4980A+HP42841A (or equivalent)  
 I rms : Agilent 6641 SYSTEM DC POWER SUPPLY (or equivalent)

**Test Instruments :** E4991A Impedance / Material Analyzer

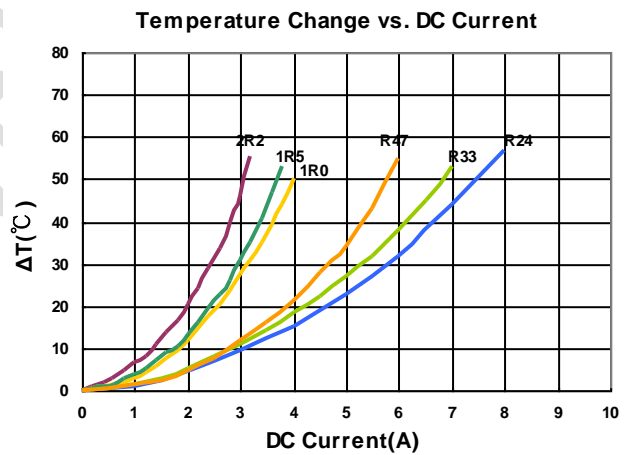
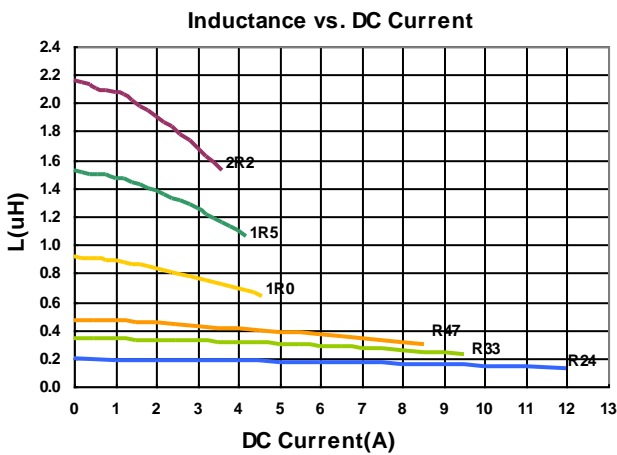

# Molding Power Inductors – HEI Series

## Electrical Characteristics

Part Number	Inductance (uH)	Tolerance (±%)	Test Frequency (MHz)	RDC(mΩ) Max(Typ.)	Isat(A) Max(Typ.)	Irms(A) Max(Typ.)
HEI322512A-R47M-Q8	0.47	20	2	25(19)	7.0(8.2)	4.6(5.2)
HEI322512A-1R0M-Q8	1.0	20	2	34(27.5)	5.7(6.5)	3.7(4.2)
HEI322512A-1R5M-Q8	1.5	20	2	59(51)	4.0(4.6)	2.8(3.2)
HEI322512A-2R2M-Q8	2.2	20	2	73(64)	3.5(4.0)	2.7(3.0)

**Note: When ordering, please specify tolerance code. Tolerance: M=±20%**

- Operating temperature range - 40°C ~ 125°C(Including self - temperature rise)
- Isat for Inductance drop 30% from its value without current
- I rms for a 40°C temperature rise from 25°C ambient with current
- Absolute maximum voltage 25VDC
- Measure Equipment :  
 L : Agilent E4991/HP4286A+16197A (or equivalent), 2MHz 0.2V  
 RDC : CHEN HWA502BC/HP4338B (or equivalent)  
 Isat : Agilent E4980A+HP42841A (or equivalent)  
 I rms : Agilent 6641 SYSTEM DC POWER SUPPLY (or equivalent)

**Test Instruments :** E4991A Impedance / Material Analyzer

**Inductance vs. DC Current**

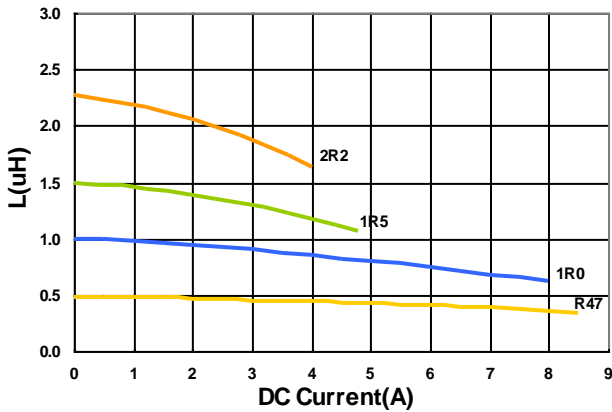

**Temperature Change vs. DC Current**

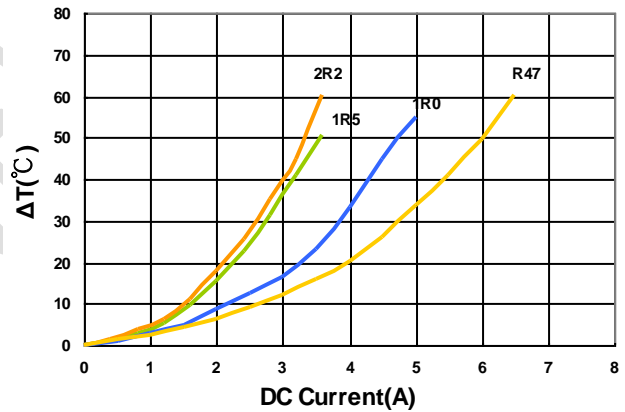

# Molding Power Inductors – HEI Series

## Electrical Characteristics

Part Number	Inductance (uH)	Tolerance (±%)	Test Frequency (MHz)	RDC(mΩ) Max(Typ.)	Isat(A) Max(Typ.)	Irms(A) Max(Typ.)
HEI322525A-1R0M-Q8	1.0	20	2	34(28)	6.0(8.0)	3.5(4.3)
HEI322525A-1R5M-Q8	1.5	20	2	45(35)	5.5(7.5)	3.2(3.9)
HEI322525A-2R2M-Q8	2.2	20	2	60(49)	4.8(6.5)	3.0(3.3)

**Note: When ordering, please specify tolerance code. Tolerance: M=±20%**

- Operating temperature range - 40°C ~ 125°C(Including self - temperature rise)
- Isat for Inductance drop 30% from its value without current
- I rms for a 40°C temperature rise from 25°C ambient with current
- Absolute maximum voltage 25VDC
- Measure Equipment :  
 L : Agilent E4991/HP4286A+16197A (or equivalent), 2MHz 0.2V  
 RDC : CHEN HWA502BC/HP4338B (or equivalent)  
 Isat : Agilent E4980A+HP42841A (or equivalent)  
 I rms : Agilent 6641 SYSTEM DC POWER SUPPLY (or equivalent)

**Test Instruments : E4991A Impedance / Material Analyzer**

**Inductance vs. DC Current**

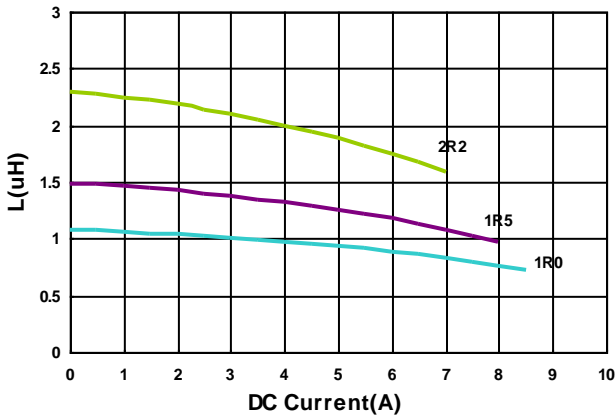

**Temperature Change vs. DC Current**

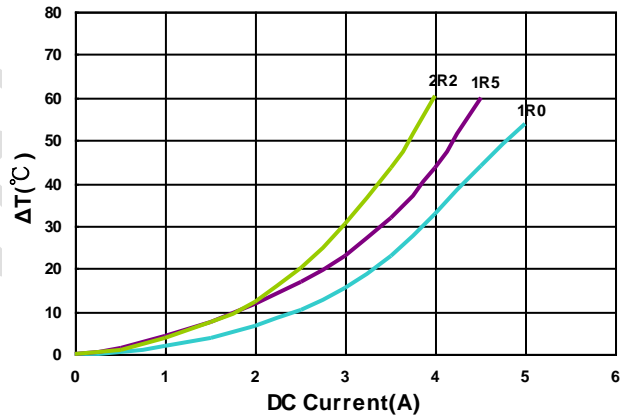

## Packaging Specifications

### Tape Dimensions

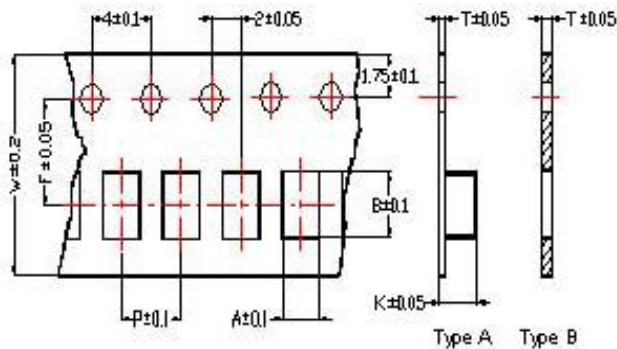

### Tape Material

Carrier Tape: Polycarbonate (Tape A)  
 Carrier Tape: Paper (Tape B)  
 Cover Tape: Polystyrene

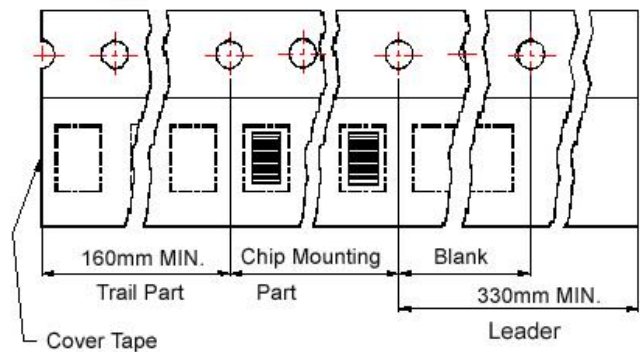

### Reel Dimensions

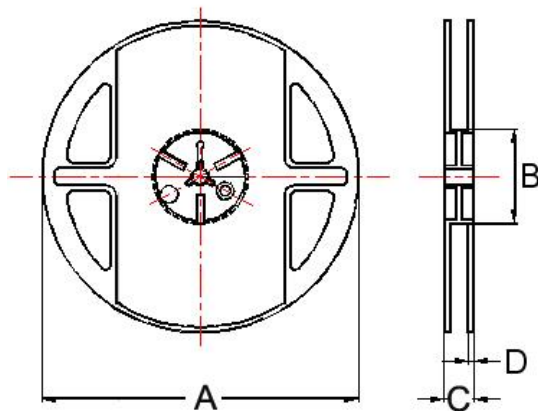

Dimensions in mm

TYPE	Tape Dimensions								Tape	Reel Dimensions				Quantity PCS / REEL
	A	B	T	W	P	F	K	A		B	C	D		
160808A	1.20	1.88	0.95	8	4	3.5	-	B	178	60	12	1.5	4000	
201208A	1.45	2.25	0.22	8	4	3.5	1.04	A	178	60	12	1.5	3000	
201210A	1.50	2.25	0.22	8	4	3.5	1.15	A	178	60	12	1.5	3000	
201608A	1.80	2.35	0.23	8	4	3.5	0.85	A	178	60	12	1.5	3000	
201610A	1.80	2.20	0.22	8	4	3.5	1.15	A	178	60	12	1.5	3000	
252010A	2.25	2.80	0.22	8	4	3.5	1.15	A	178	60	12	1.5	3000	
252012A	2.25	2.80	0.22	8	4	3.5	1.35	A	178	60	12	1.5	3000	
322510A	2.80	3.55	0.23	8	4	3.5	1.20	A	178	60	12	1.5	3000	
322512A	2.80	3.50	0.23	8	4	3.5	1.34	A	178	60	12	1.5	3000	
322525A	2.90	3.50	0.23	8	4	3.5	2.90	A	178	60	12	1.5	1500	

## X-ON Electronics

Largest Supplier of Electrical and Electronic Components

*Click to view similar products for [Fixed Inductors](#) category:*

*Click to view products by [Chilisin](#) manufacturer:*

Other Similar products are found below :

[CR32NP-100KC](#) [CR54NP-470LC](#) [70F224AI](#) [MGDQ4-00004-P](#) [MHQ1005P10NJ](#) [MHQ1005P1N0S](#) [MHQ1005P2N4S](#) [MHQ1005P3N6S](#)  
[MHQ1005P5N1S](#) [MHQ1005P8N2J](#) [PE-53601NL](#) [PE-53602NL](#) [PG0936.113NLT](#) [9220-20](#) [9310-16](#) [PM06-2N7](#) [PM06-39NJ](#) [A01TK](#)  
[1206CS-471XJ](#) [HC8-1R2-R](#) [HCF1305-3R3-R](#) [1206CS-151XG](#) [RCH664NP-140L](#) [RCP1317NP-391L](#) [RCR110DNP-331L](#) [DH2280-4R7M](#)  
[DS1608C-106](#) [B10TJ](#) [ELJ-RE27NJF2](#) [1812CS-153XJ](#) [1812CS-183XJ](#) [1812CS-223XJ](#) [1812LS-104XJ](#) [1812LS-105XJ](#) [1812LS-124XJ](#)  
[1812LS-154XJ](#) [1812LS-223XJ](#) [1812LS-224XJ](#) [1812LS-563XJ](#) [1812LS-683XJ](#) [1812LS-824XJ](#) [NIN-FA4R7JTR220F](#) [NIN-FB101JTR110F](#)  
[NIN-FB471JTR62F](#) [NIN-FC1R5JTR220F](#) [NIN-HCR15JTRF](#) [NIN-HCR33JTRF](#) [NIN-HDR22JTRF](#) [NIN-HDR82JTRF](#) [NIN-HK2N7STRF](#)