

Cautions and Warnings

Please be noted that this spec is only for reference if you have projects designed with the product number listed in. If you are looking for new project design-in, please find BWVS Series specification/datasheet on Chilisin website. Or you may find our sales contact for more information on old part number at your convenience. Appreciated your attention and understanding.

Note: Please be sure to request approval specifications that provide further details of the products. Kindly note that the content of these specifications are subject to change or may be discontinued without prior notice. This product may not be designed/used in medical or high risk applications without Chilisin approval. Please contact our sales department before ordering.

LVS Series



LVS series, an automatic assembly constructed power inductor, is shielded with magnetic resin and suitable for the portable DC-DC converter applications.

Features

- RoHS, Halogen Free and REACH Compliance
- Shielded with magnetic resin
- Various package size and wide inductance range
- Optimize electrical characteristics by using different ferrite core figures

Applications

- AP Routers
- STBs
- LCD TVs, monitors and panels
- Game consoles
- DC/DC converters

Product Identification

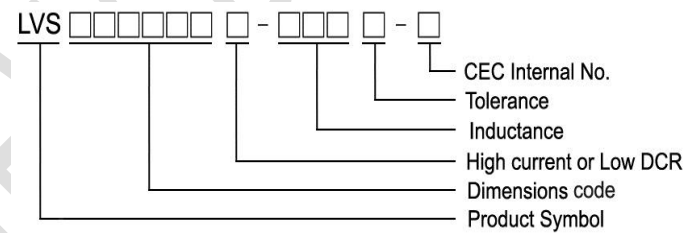

Shape and Dimensions

Figure 1

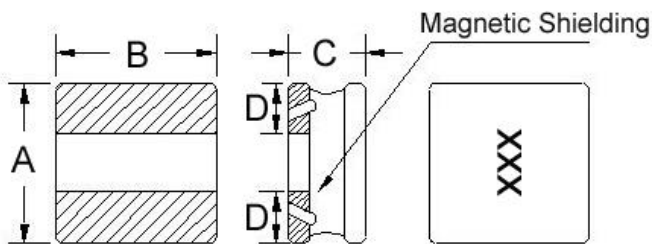

Recommended Pattern



Dimensions in mm

TYPE	FIG	A	B	C	D	H	I	J
LVS404012	1	4.0±0.2	4.0±0.2	1.20±0.1	1.5	4.2	1.5	1.2

Sealed Power Inductors - LVS Series

Shape and Dimensions

Figure 2



Recommended Pattern

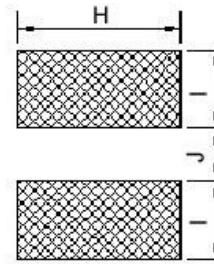

Dimensions in mm

TYPE	FIG	A	B	C	D	H	I	J
LVS404018	2	4.0±0.2	4.0±0.2	1.8 ^{+0.2} _{-0.30}	1.3±0.3	3.7	1.2	1.6
LVS404026	2	4.0±0.2	4.0±0.2	2.6±0.2	1.4	3.7	1.2	1.6

Shape and Dimensions

Figure 3

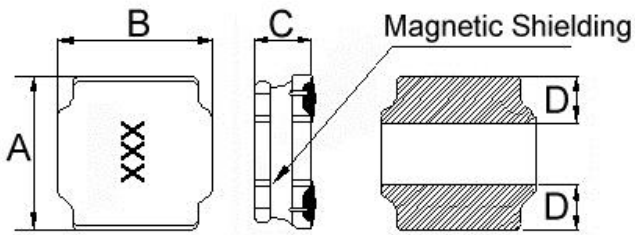

Recommended Pattern

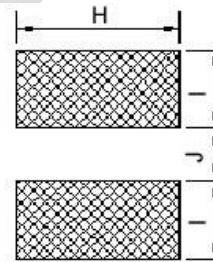

Dimensions in mm

TYPE	FIG	A	B	C	D	H	I	J
LVS505020	3	5.0±0.2	5.0±0.2	2.0 ^{+0.2} _{-0.30}	1.8±0.3	4.0	1.5	2.1
LVS505040	3	5.0±0.2	5.0±0.2	4.0 ^{+0.2} _{-0.30}	1.6±0.3	4.0	1.5	2.1
LVS606020	3	6.0±0.2	6.0±0.2	2.0 ^{+0.2} _{-0.30}	1.7±0.3	5.7	1.6	2.9
LVS606028	3	6.0±0.2	6.0±0.2	2.8 ^{+0.2} _{-0.30}	1.9±0.3	5.7	1.6	2.9
LVS606045	3	6.0±0.2	6.0±0.2	4.5 ^{+0.2} _{-0.30}	1.8±0.3	5.7	2.0	2.4
LVS606045L	3	6.0±0.2	6.0±0.2	4.5 ^{+0.2} _{-0.30}	1.8±0.3	5.7	2.0	2.4
LVS808040	3	8.0±0.2	8.0±0.2	4.0 ^{+0.2} _{-0.30}	2.3±0.3	7.5	2.5	3.4
LVS808040L	3	8.0±0.2	8.0±0.2	4.0 ^{+0.2} _{-0.30}	2.3±0.3	7.5	2.5	3.4

Electrical Characteristics

Part Number	Inductance (uH)	Tolerance (±%)	Test Frequency (kHz)	RDC (mΩ) ±30%	Isat (A) Typ. (Max)	Irms (A) Typ. (Max)	Marking
LVS404012-1R0□-N	1.0	20, 30	100	48	2.50(2.25)	1.70(1.53)	1R0
LVS404012-1R5□-N	1.5	20, 30	100	58	2.10(1.89)	1.60(1.44)	1R5
LVS404012-2R2□-N	2.2	20, 30	100	65	1.70(1.53)	1.50(1.35)	2R2
LVS404012-3R3□-N	3.3	20, 30	100	90	1.30(1.17)	1.40(1.26)	3R3
LVS404012-4R7□-N	4.7	20, 30	100	110	1.10(0.99)	1.20(1.08)	4R7
LVS404012-6R8□-N	6.8	20, 30	100	135	0.90(0.81)	1.05(0.94)	6R8
LVS404012-100□-N	10	20, 30	100	190	0.78(0.70)	0.90(0.81)	100
LVS404012-150□-N	15	20, 30	100	250	0.65(0.58)	0.85(0.76)	150
LVS404012-220□-N	22	20, 30	100	400	0.52(0.46)	0.75(0.67)	220
LVS404012-330□-N	33	20, 30	100	600	0.44(0.39)	0.70(0.63)	330
LVS404012-470□-N	47	20, 30	100	930	0.35(0.31)	0.50(0.45)	470

Note: When ordering, please specify tolerance code. Tolerance: M=±20% , T =±30%

- Operating temperature range - 55°C ~ 125°C(Including self - temperature rise)
- Isat for Inductance drop 30% from its value without current
- I rms for a 40°C temperature rise from 25°C ambient with current
- Measure Equipment :
 - L : Agilent HP4284A+Agilent HP42841A, 100kHz 1V
 - RDC : DIGITAL MILLINHM METER CHROMA 16502, or equivalent
 - Isat & I rms : Agilent HP4284A

Test Instruments : HP4284A Material/Impedance Analyzer

Inductance vs. DC Current

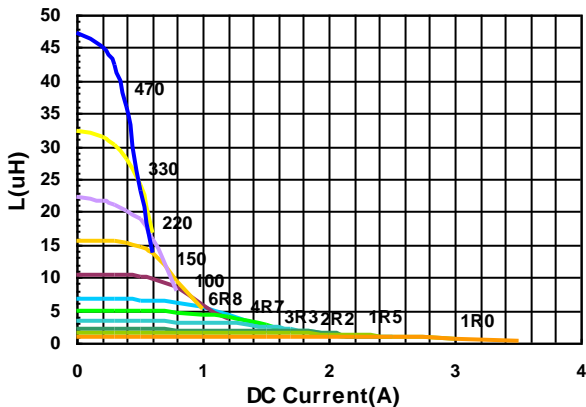

Temperature Change vs. DC Current

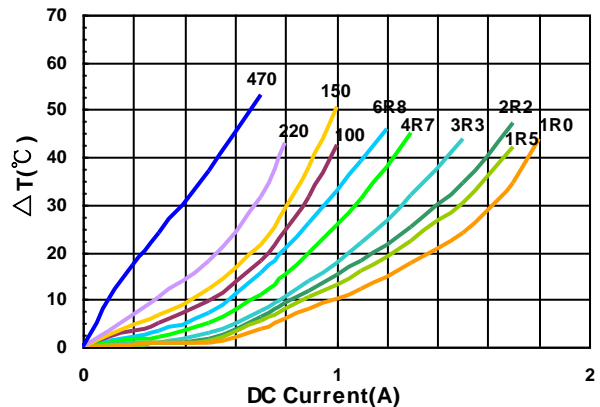

Electrical Characteristics

Part Number	Inductance (uH)	Tolerance (±%)	Test Frequency (kHz)	RDC (mΩ) ±20%	Isat (A) Typ. (Max)	Irms (A) Typ. (Max)	Marking
LVS404018-1R0□-N	1.0	20, 30	100	32	4.10(3.69)	2.80(2.52)	1R0
LVS404018-1R5□-N	1.5	20, 30	100	40	3.30(2.97)	2.60(2.34)	1R5
LVS404018-1R8□-N	1.8	20, 30	100	55	2.80(2.50)	2.50(2.20)	1R8
LVS404018-2R2□-N	2.2	20, 30	100	60	2.80(2.52)	2.50(2.25)	2R2
LVS404018-3R3□-N	3.3	20, 30	100	70	2.20(1.98)	2.10(1.89)	3R3
LVS404018-3R6□-N	3.6	20, 30	100	75	2.10(1.89)	1.90(1.71)	3R6
LVS404018-3R9□-N	3.9	20, 30	100	75	2.10(1.89)	1.90(1.71)	3R9
LVS404018-4R7□-N	4.7	20, 30	100	90	2.00(1.80)	1.70(1.53)	4R7
LVS404018-6R8□-N	6.8	20, 30	100	110	1.60(1.44)	1.50(1.35)	6R8
LVS404018-8R2□-N	8.2	20, 30	100	155	1.50(1.30)	1.30(1.10)	8R2
LVS404018-100□-N	10	20, 30	100	170	1.40(1.26)	1.20(1.08)	100
LVS404018-150□-N	15	20, 30	100	250	1.00(0.90)	1.00(0.90)	150
LVS404018-220□-N	22	20, 30	100	350	0.90(0.81)	0.85(0.76)	220
LVS404018-330□-N	33	20, 30	100	530	0.80(0.72)	0.70(0.63)	330
LVS404018-470□-N	47	20, 30	100	720	0.70(0.63)	0.56(0.50)	470
LVS404018-680□-N	68	20, 30	100	1000	0.56(0.50)	0.45(0.40)	680
LVS404018-101□-N	100	20, 30	100	1500	0.46(0.41)	0.38(0.34)	101
LVS404018-151□-N	150	20, 30	100	2500	0.35(0.31)	0.30(0.27)	151
LVS404018-221□-N	220	20, 30	100	4000	0.28(0.25)	0.23(0.20)	221

Note: When ordering, please specify tolerance code. Tolerance: M=±20% , T =±30%

- Operating temperature range - 55°C ~ 125°C(Including self - temperature rise)
- Isat for Inductance drop 30% from its value without current
- Irms for a 40°C temperature rise from 25°C ambient with current
- Measure Equipment :
 L : Agilent HP4284A+Agilent HP42841A, 100kHz 1V
 RDC : DIGITAL MILLINHM METER CHROMA 16502, or equivalent
 Isat & Irms : Agilent HP4284A

Test Instruments : HP4284A Material/Impedance Analyzer

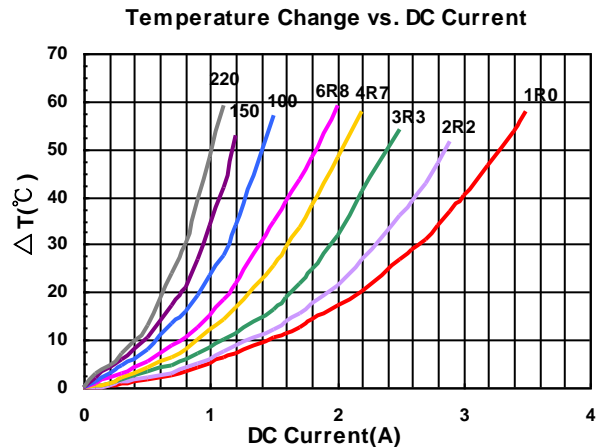
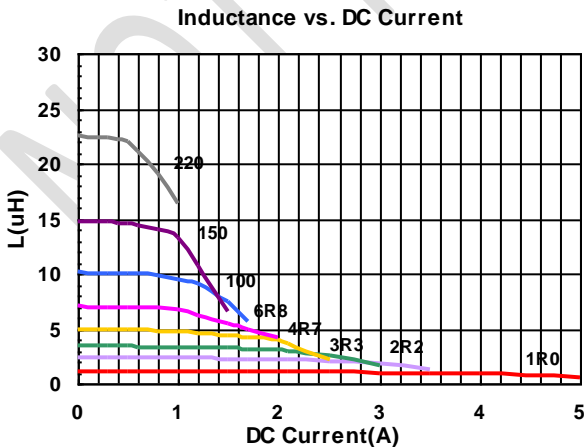

Electrical Characteristics

Part Number	Inductance (uH)	Tolerance (±%)	Test Frequency (kHz)	RDC (mΩ) ±30%	Isat (A) Typ. (Max)	Irms (A) Typ. (Max)	Marking
LVS404026-1R2□-N	1.2	20, 30	100	30	3.50(3.15)	3.30(2.97)	1R2
LVS404026-3R3□-N	3.3	20, 30	100	45	2.50(2.25)	2.50(2.25)	3R3
LVS404026-4R7□-N	4.7	20, 30	100	60	1.80(1.62)	1.80(1.62)	4R7
LVS404026-220□-N	22	20, 30	100	230	0.86(0.77)	1.00(0.90)	220

Note: When ordering, please specify tolerance code. Tolerance: M=±20% , T =±30%

- Operating temperature range - 55°C ~ 125°C(Including self - temperature rise)
- Isat for Inductance drop 30% from its value without current
- Irms for a 40°C temperature rise from 25°C ambient with current
- Measure Equipment :
 L : Agilent HP4284A+Agilent HP42841A, 100kHz 1V
 RDC : DIGITAL MILLINHM METER CHROMA 16502, or equivalent
 Isat & Irms : Agilent HP4284A

Test Instruments : HP4284A Material/Impedance Analyzer

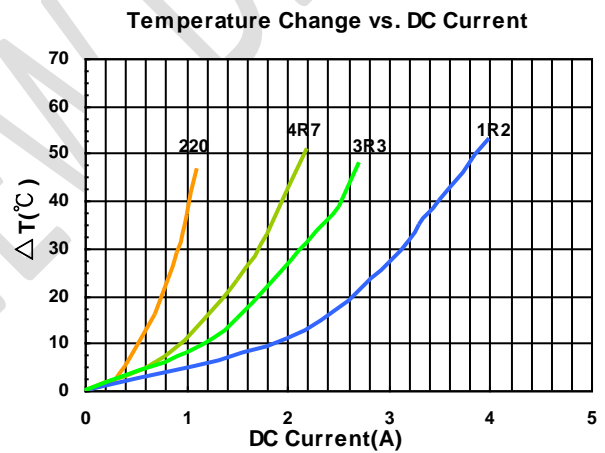
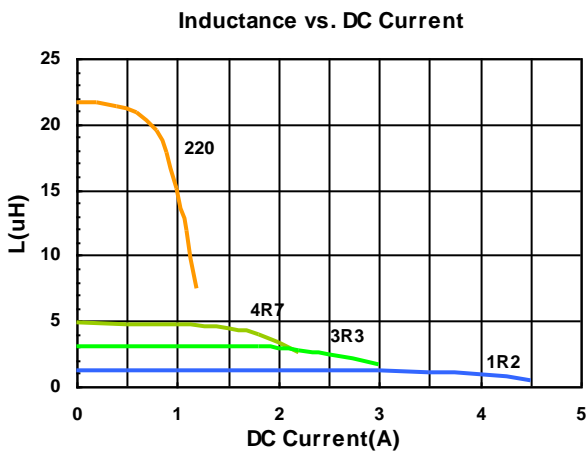

Electrical Characteristics

Part Number	Inductance (uH)	Tolerance (±%)	Test Frequency (kHz)	RDC (mΩ) ±20%	Isat (A) Typ. (Max)	Irms (A) Typ. (Max)	Marking
LVS505020-1R0□-N	1.0	20, 30	100	21	5.1(4.59)	4.0(3.60)	1R0
LVS505020-1R2□-N	1.2	30	100	21	4.8(4.32)	3.8(3.42)	1R2
LVS505020-1R5□-N	1.5	20, 30	100	26	4.2(3.78)	3.5(3.15)	1R5
LVS505020-2R2□-N	2.2	20, 30	100	35	3.4(3.06)	3.2(2.88)	2R2
LVS505020-2R7□-N	2.7	20, 30	100	38	3.05(2.7)	2.9(2.60)	2R7
LVS505020-3R3□-N	3.3	20, 30	100	48	3.0(2.70)	2.8(2.52)	3R3
LVS505020-4R7□-N	4.7	20, 30	100	60	2.2(1.98)	2.2(1.98)	4R7
LVS505020-5R6□-N	5.6	20, 30	100	82	2.05(1.84)	2.0(1.80)	5R6
LVS505020-6R8□-N	6.8	20, 30	100	90	2.0(1.80)	1.8(1.62)	6R8
LVS505020-100□-N	10	20, 30	100	120	1.6(1.44)	1.6(1.44)	100
LVS505020-150□-N	15	20, 30	100	190	1.3(1.17)	1.2(1.08)	150
LVS505020-220□-N	22	20, 30	100	260	1.0(0.90)	1.0(0.90)	220
LVS505020-330□-N	33	20, 30	100	460	0.8(0.72)	0.75(0.67)	330
LVS505020-470□-N	47	20, 30	100	580	0.65(0.58)	0.65(0.58)	470

Note: When ordering, please specify tolerance code. Tolerance: M=±20% , T =±30%

- Operating temperature range - 55°C ~ 125°C(Including self - temperature rise)
- Isat for Inductance drop 30% from its value without current
- I rms for a 40°C temperature rise from 25°C ambient with current
- Measure Equipment :
 L : Agilent HP4284A+Agilent HP42841A, 100kHz 1V
 RDC : DIGITAL MILLINHM METER CHROMA 16502, or equivalent
 Isat & I rms : Agilent HP4284A

Test Instruments : HP4284A Material/Impedance Analyzer

Inductance vs. DC Current



Temperature Change vs. DC Current

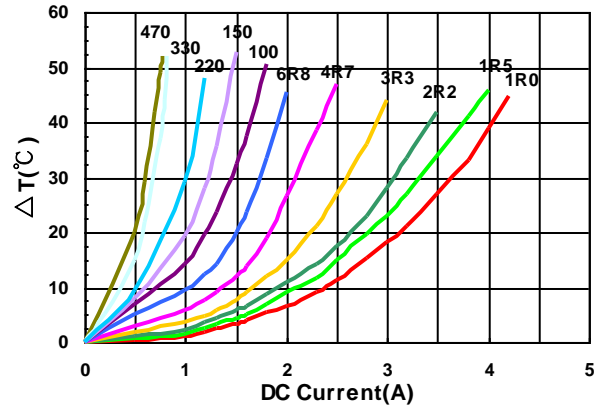

Electrical Characteristics

Part Number	Inductance (uH)	Tolerance (±%)	Test Frequency (kHz)	RDC (mΩ) ±30%	Isat (A) Typ. (Max)	Irms (A) Typ. (Max)	Marking
LVS505040-1R0□-N	1.0	20, 30	100	14	7.5(6.75)	4.6(4.14)	1R0
LVS505040-1R2□-N	1.2	20, 30	100	15	7.4(6.66)	4.5(4.05)	1R2
LVS505040-1R5□-N	1.5	20, 30	100	16	7.1(6.39)	4.4(3.96)	1R5
LVS505040-2R2□-N	2.2	20, 30	100	21	5.7(5.13)	3.7(3.33)	2R2
LVS505040-3R0□-N	2.2	20, 30	100	26	4.8(4.32)	3.5(3.15)	3R0
LVS505040-3R3□-N	3.3	20, 30	100	26	4.8(4.32)	3.5(3.15)	3R3
LVS505040-3R6□-N	3.6	20, 30	100	31	4.2(3.70)	3.3(2.90)	3R6
LVS505040-4R7□-N	4.7	20, 30	100	32	4.2(3.78)	3.2(2.88)	4R7
LVS505040-6R8□-N	6.8	20, 30	100	50	3.3(2.97)	2.4(2.16)	6R8
LVS505040-8R2□-N	8.2	20, 30	100	58	3.1(2.70)	2.3(2.00)	8R2
LVS505040-100□-N	10	20, 30	100	60	2.8(2.52)	2.2(1.98)	100
LVS505040-150□-N	15	20, 30	100	90	2.3(2.07)	1.8(1.62)	150
LVS505040-220□-N	22	20, 30	100	135	1.8(1.62)	1.4(1.26)	220
LVS505040-270□-N	27	20, 30	100	180	1.6(1.44)	1.2(1.08)	270
LVS505040-330□-N	33	20, 30	100	190	1.5(1.35)	1.1(0.99)	330
LVS505040-470□-N	47	20, 30	100	310	1.2(1.08)	0.9(0.81)	470
LVS505040-680□-N	68	20, 30	100	540	1.0(0.90)	0.78(0.7)	680
LVS505040-101□-N	100	20, 30	100	800	0.7(0.60)	0.6(0.50)	101

Note: When ordering, please specify tolerance code. Tolerance: M=±20% , T =±30%

- Operating temperature range - 55°C ~ 125°C(Including self - temperature rise)
- Isat for Inductance drop 30% from its value without current
- I rms for a 40°C temperature rise from 25°C ambient with current
- Measure Equipment :
 L : Agilent HP4284A+Agilent HP42841A, 100kHz 1V
 RDC : DIGITAL MILLINHM METER CHROMA 16502, or equivalent
 Isat & I rms : Agilent HP4284A

Test Instruments : HP4284A Material/Impedance Analyzer

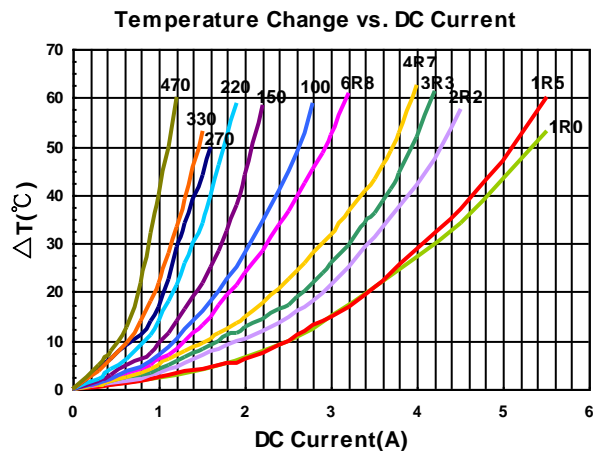
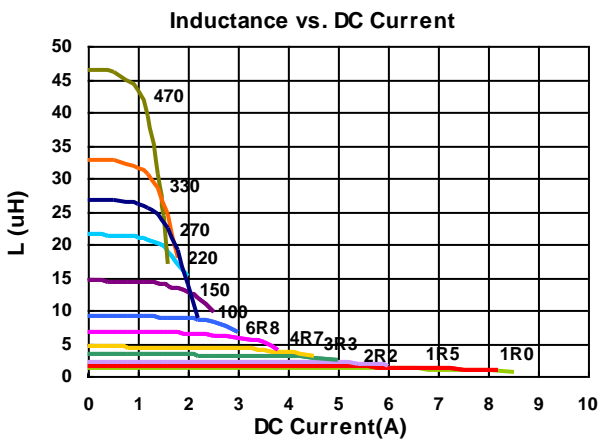

Electrical Characteristics

Part Number	Inductance (uH)	Tolerance (±%)	Test Frequency (kHz)	RDC (mΩ) ±30%	Isat (A) Typ. (Max)	Irms (A) Typ. (Max)	Marking
LVS606020-R50□-N	0.5	30	100	13	8.0(7.20)	5.3(4.77)	R50
LVS606020-R90□-N	0.9	30	100	18	6.3(5.67)	4.2(3.78)	R90
LVS606020-1R0□-N	1.0	30	100	19	6.2(5.58)	4.1(3.69)	1R0
LVS606020-1R5□-N	1.5	20, 30	100	26	5.0(4.50)	3.6(3.24)	1R5
LVS606020-2R2□-N	2.2	20, 30	100	34	4.2(3.78)	3.2(2.88)	2R2
LVS606020-3R3□-N	3.3	20, 30	100	40	3.2(2.88)	2.7(2.43)	3R3
LVS606020-4R7□-N	4.7	20, 30	100	58	2.5(2.25)	2.2(1.98)	4R7
LVS606020-6R8□-N	6.8	20, 30	100	85	2.2(1.98)	1.8(1.62)	6R8
LVS606020-100□-N	10	20, 30	100	125	2.0(1.80)	1.6(1.44)	100
LVS606020-150□-N	15	20, 30	100	190	1.3(1.17)	1.3(1.17)	150
LVS606020-220□-N	22	20, 30	100	260	1.1(0.99)	1.1(0.99)	220

Note: When ordering, please specify tolerance code. Tolerance: M=±20% , T =±30%

- Operating temperature range - 55°C ~ 125°C(Including self - temperature rise)
- Isat for Inductance drop 30% from its value without current
- Irms for a 40°C temperature rise from 25°C ambient with current
- Measure Equipment :
 - L : Agilent HP4284A+Agilent HP42841A, 100kHz 1V
 - RDC : DIGITAL MILLINHM METER CHROMA 16502, or equivalent
 - Isat & Irms : Agilent HP4284A

Test Instruments : HP4284A Material/Impedance Analyzer

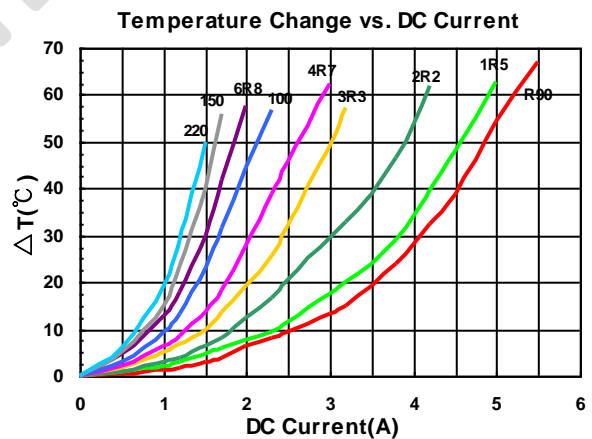
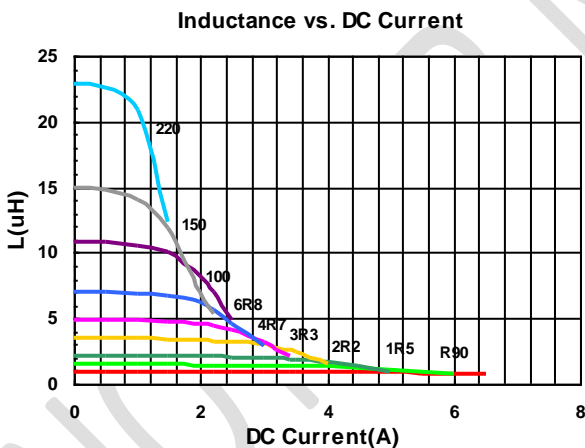

Electrical Characteristics

Part Number	Inductance (uH)	Tolerance (±%)	Test Frequency (kHz)	RDC (mΩ) ±30%	Isat (A) Typ. (Max)	Irms (A) Typ. (Max)	Marking
LVS606028-1R0□-N	1.0	20, 30	100	13	7.6(6.84)	5.2(4.68)	1R0
LVS606028-1R5□-N	1.5	30	100	16	6.3(5.67)	4.8(4.32)	1R5
LVS606028-2R2□-N	2.2	20, 30	100	20	5.4(4.86)	4.0(3.60)	2R2
LVS606028-2R7□-N	2.7	20, 30	100	26	4.9(4.41)	3.7(3.33)	2R7
LVS606028-3R3□-N	3.3	20, 30	100	28	4.3(3.87)	3.5(3.15)	3R3
LVS606028-4R7□-N	4.7	20, 30	100	38	3.7(3.33)	3.2(2.88)	4R7
LVS606028-6R0□-N	6.0	20, 30	100	45	3.3(2.97)	2.8(2.52)	6R0
LVS606028-6R8□-N	6.8	20, 30	100	50	3.1(2.79)	2.7(2.43)	6R8
LVS606028-100□-N	10	20, 30	100	65	2.5(2.25)	2.3(2.07)	100
LVS606028-150□-N	15	20, 30	100	95	2.0(1.80)	1.8(1.62)	150
LVS606028-220□-N	22	20, 30	100	135	1.6(1.44)	1.5(1.35)	220
LVS606028-330□-N	33	20, 30	100	220	1.3(1.17)	1.4(1.26)	330
LVS606028-470□-N	47	20, 30	100	320	1.1(0.99)	1.0(0.90)	470
LVS606028-680□-N	68	20, 30	100	420	0.98(0.88)	0.9(0.81)	680
LVS606028-101□-N	100	20, 30	100	600	0.82(0.73)	0.8(0.72)	101

Note: When ordering, please specify tolerance code. Tolerance: M=±20% , T =±30%

- Operating temperature range - 55°C ~ 125°C(Including self - temperature rise)
- Isat for Inductance drop 30% from its value without current
- Irms for a 40°C temperature rise from 25°C ambient with current
- Measure Equipment :
 L : Agilent HP4284A+Agilent HP42841A, 100kHz 1V
 RDC : DIGITAL MILLINHM METER CHROMA 16502, or equivalent
 Isat & Irms : Agilent HP4284A

Test Instruments : HP4284A Material/Impedance Analyzer

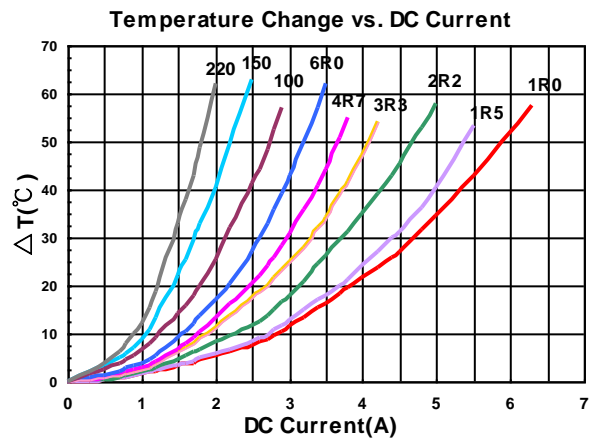

Sealed Power Inductors - LVS Series

Electrical Characteristics

Part Number	Inductance (uH)	Tolerance (±%)	Test Frequency (kHz)	RDC (mΩ) ±30%	Isat (A) Typ. (Max)	Irms (A) Typ. (Max)	Marking
LVS606045-1R0□-N	1.0	20, 30	100	12	12.2(10.98)	6.5(5.85)	1R0
LVS606045-1R2□-N	1.2	20, 30	100	13	10.6(9.50)	5.9(5.30)	1R2
LVS606045-1R5□-N	1.5	20, 30	100	15	10.4(9.36)	5.9(5.31)	1R5
LVS606045-1R8□-N	1.8	20, 30	100	17	9.6(8.64)	5.6(5.04)	1R8
LVS606045-2R2□-N	2.2	20, 30	100	18.4	8.8(7.92)	5.1(4.59)	2R2
LVS606045-2R3□-N	2.3	20, 30	100	19	8.8(7.92)	5.0(4.50)	2R3
LVS606045-3R0□-N	3.0	20, 30	100	22	7.8(7.02)	4.4(3.96)	3R0
LVS606045-3R3□-N	3.3	20, 30	100	24	7.5(6.75)	4.3(3.87)	3R3
LVS606045-3R6□-N	3.6	20, 30	100	24	7.5(6.75)	4.3(3.87)	3R6
LVS606045-3R9□-N	3.9	20, 30	100	26	7.0(6.30)	4.0(3.60)	3R9
LVS606045-4R5□-N	4.5	20, 30	100	31	6.7(6.03)	3.9(3.51)	4R5
LVS606045-4R7□-N	4.7	20, 30	100	31	6.7(6.03)	3.9(3.51)	4R7
LVS606045-5R1□-N	5.1	20, 30	100	33	6.0(5.40)	3.5(3.15)	5R1
LVS606045-5R6□-N	5.6	20, 30	100	40	5.5(4.95)	3.3(2.97)	5R6
LVS606045-6R3□-N	6.3	20, 30	100	40	5.5(4.95)	3.3(2.97)	6R3
LVS606045-6R8□-N	6.8	20, 30	100	43	5.3(4.77)	3.2(2.88)	6R8
LVS606045-8R2□-N	8.2	20, 30	100	53	4.6(4.10)	2.9(2.60)	8R2
LVS606045-100□-N	10	20, 30	100	57	4.5(4.05)	2.7(2.43)	100
LVS606045-150□-N	15	20, 30	100	80	3.4(3.06)	2.2(1.98)	150
LVS606045-180□-N	18	20, 30	100	100	3.1(2.79)	1.8(1.62)	180
LVS606045-220□-N	22	20, 30	100	125	3.0(2.70)	1.9(1.71)	220
LVS606045-270□-N	27	20, 30	100	160	2.5(2.25)	1.3(1.17)	270
LVS606045-330□-N	33	20, 30	100	165	2.3(2.07)	1.4(1.26)	330
LVS606045-470□-N	47	20, 30	100	245	1.9(1.71)	1.2(1.08)	470
LVS606045-560□-N	56	20, 30	100	310	1.7(1.50)	1.1(0.99)	560
LVS606045-680□-N	68	20, 30	100	330	1.6(1.44)	1.0(0.90)	680
LVS606045-101□-N	100	20, 30	100	500	1.3(1.17)	0.8(0.72)	101
LVS606045-221□-N	220	20, 30	100	1300	0.82(0.73)	0.38(0.34)	221
LVS606045-331□-N	330	20, 30	100	1800	0.7(0.63)	0.35(0.31)	331
LVS606045-102□-N	1000	20, 30	100	6000	0.4(0.36)	0.22(0.19)	102

Note: When ordering, please specify tolerance code. Tolerance: M=±20% , T =±30%

- Operating temperature range - 55°C ~ 125°C(Including self - temperature rise)
- Isat for Inductance drop 30% from its value without current
- I rms for a 40°C temperature rise from 25°C ambient with current
- Measure Equipment :
 L : Agilent HP4284A+Agilent HP42841A, 100kHz 1V
 RDC : DIGITAL MILLINHM METER CHROMA 16502, or equivalent
 Isat & I rms : Agilent HP4284A

Test Instruments : HP4284A Material/Impedance Analyzer

Inductance vs. DC Current

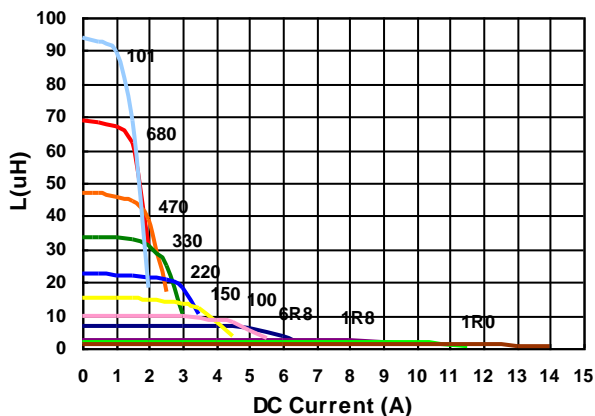

Temperature Change vs. DC Current

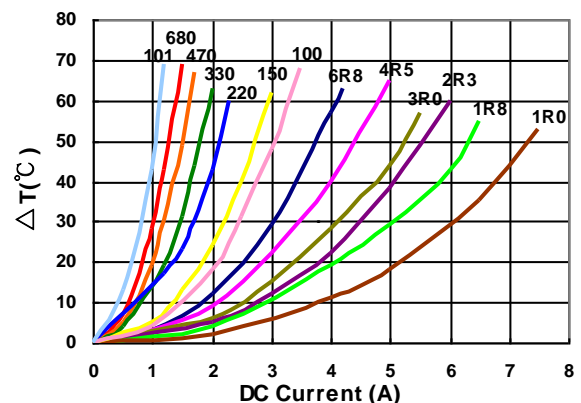

Please be sure to request approval specifications that provide further details of the products. Kindly note that the content of these specifications are subject to change or may be discontinued without prior notice. This product may not be designed/used in medical or high risk applications without Chilisin approval. Please contact our sales department before ordering.



CHILISIN ELECTRONICS CORP.

Electrical Characteristics

Part Number	Inductance (uH)	Tolerance (±%)	Test Frequency (kHz)	RDC (mΩ) Max	Isat (A) Typ. (Max)	Irms (A) Typ. (Max)	Marking
LVS606045L-R50□-N	0.5	30	100	9	11(9.90)	8.0(7.20)	R50
LVS606045L-2R2□-N	2.2	20, 30	100	17	6.8(6.12)	5.5(4.95)	2R2
LVS606045L-3R3□-N	3.3	20, 30	100	24	5.5(4.95)	4.7(4.23)	3R3
LVS606045L-4R7□-N	4.7	20, 30	100	30	4.6(4.14)	4.0(3.60)	4R7
LVS606045L-6R8□-N	6.8	20, 30	100	40	4.0(3.60)	3.5(3.15)	6R8
LVS606045L-100□-N	10	20, 30	100	50	3.2(2.88)	3.2(2.88)	100
LVS606045L-150□-N	15	20, 30	100	80	2.6(2.34)	2.5(2.25)	150
LVS606045L-220□-N	22	20, 30	100	120	2.1(1.89)	2.0(1.80)	220
LVS606045L-330□-N	33	20, 30	100	170	1.7(1.53)	1.6(1.44)	330
LVS606045L-101□-N	100	20, 30	100	595	0.95(0.85)	0.92(0.82)	101

Note: When ordering, please specify tolerance code. Tolerance: M=±20% , T =±30%

- Operating temperature range - 55°C ~ 125°C(Including self - temperature rise)
- Isat for Inductance drop 30% from its value without current
- Irms for a 40°C temperature rise from 25°C ambient with current
- Measure Equipment :
 L : Agilent HP4284A+Agilent HP42841A, 100kHz 1V
 RDC : DIGITAL MILLINHM METER CHROMA 16502, or equivalent
 Isat & Irms : Agilent HP4284A

Test Instruments : HP4284A Material/Impedance Analyzer

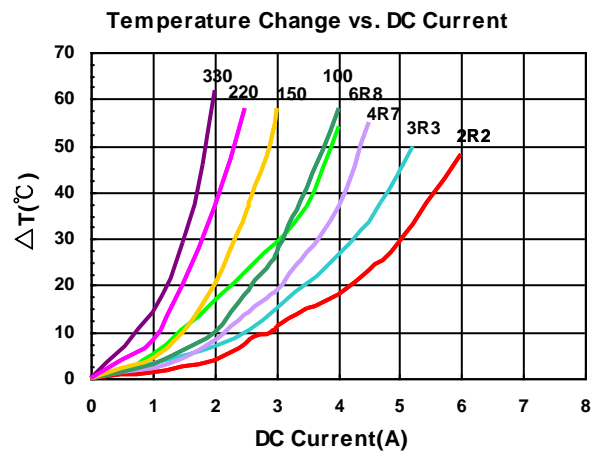
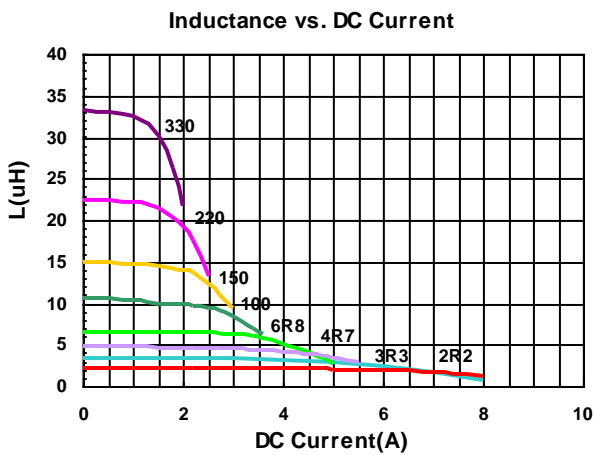

Electrical Characteristics

Part Number	Inductance (uH)	Tolerance (±%)	Test Frequency (kHz)	RDC (mΩ) ±30%	Isat (A) Typ. (Max)	Irms (A) Typ. (Max)	Marking
LVS808040-R90□-N	0.9	30	100	7	13.8(12.42)	8.05(7.24)	R90
LVS808040-1R0□-N	1.0	30	100	7.5	13.0(11.70)	7.95(7.15)	1R0
LVS808040-1R4□-N	1.4	30	100	9	10.8(9.72)	7.8(7.02)	1R4
LVS808040-1R5□-N	1.5	30	100	9.5	10.0(9.00)	7.7(6.93)	1R5
LVS808040-2R0□-N	2.0	20, 30	100	11	9.6(8.64)	7.4(6.66)	2R0
LVS808040-2R2□-N	2.2	20, 30	100	11.5	9.2(8.28)	7.2(6.48)	2R2
LVS808040-2R5□-N	2.5	20, 30	100	13	8.2(7.38)	6.3(5.67)	2R5
LVS808040-3R3□-N	3.3	20, 30	100	15	7.5(6.75)	6.0(5.40)	3R3
LVS808040-3R9□-N	3.9	20, 30	100	18	6.1(5.40)	5.5(4.90)	3R9
LVS808040-4R7□-N	4.7	20, 30	100	18	6.0(5.40)	5.5(4.95)	4R7
LVS808040-5R6□-N	5.6	20, 30	100	23	5.7(5.13)	5.2(4.68)	5R6
LVS808040-6R8□-N	6.8	20, 30	100	25	5.4(4.86)	5.1(4.59)	6R8
LVS808040-100□-N	10	20, 30	100	38	4.3(3.87)	3.8(3.42)	100
LVS808040-120□-N	12	20, 30	100	45	3.8(3.42)	3.5(3.15)	120
LVS808040-150□-N	15	20, 30	100	50	3.6(3.24)	3.2(2.88)	150
LVS808040-180□-N	18	20, 30	100	68	3.1(2.79)	2.7(2.43)	180
LVS808040-220□-N	22	20, 30	100	80	2.8(2.52)	2.6(2.34)	220
LVS808040-330□-N	33	20, 30	100	110	2.3(2.07)	2.0(1.80)	330
LVS808040-470□-N	47	20, 30	100	160	1.9(1.71)	1.75(1.57)	470
LVS808040-680□-N	68	20, 30	100	240	1.7(1.53)	1.45(1.30)	680
LVS808040-101□-N	100	20, 30	100	340	1.4(1.26)	1.10(0.99)	101
LVS808040-121□-N	120	20, 30	100	425	1.1(0.99)	1.0(0.90)	121
LVS808040-151□-N	150	20, 30	100	480	1.0(0.90)	0.9(0.81)	151
LVS808040-181□-N	180	20, 30	100	650	0.98(0.88)	0.7(0.63)	181
LVS808040-221□-N	220	20, 30	100	670	0.94(0.84)	0.60(0.54)	221
LVS808040-271□-N	270	20, 30	100	900	0.83(0.74)	0.55(0.49)	271
LVS808040-821□-N	820	20, 30	100	2800	0.40(0.36)	0.38(0.34)	821

Note: When ordering, please specify tolerance code. Tolerance: M=±20% , T =±30%

- Operating temperature range - 55°C ~ 125°C(Including self - temperature rise)
- Isat for Inductance drop 30% from its value without current
- Irms for a 40°C temperature rise from 25°C ambient with current
- Measure Equipment :
 L : Agilent HP4284A+Agilent HP42841A, 100kHz 1V
 RDC : DIGITAL MILLINHM METER CHROMA 16502, or equivalent
 Isat & Irms : Agilent HP4284A

Test Instruments : HP4284A Material/Impedance Analyzer

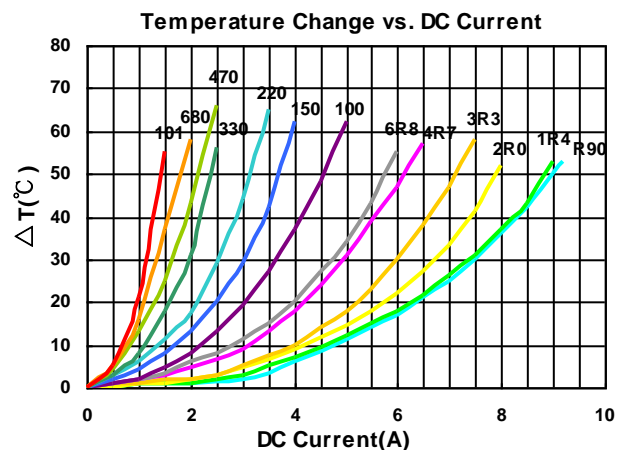
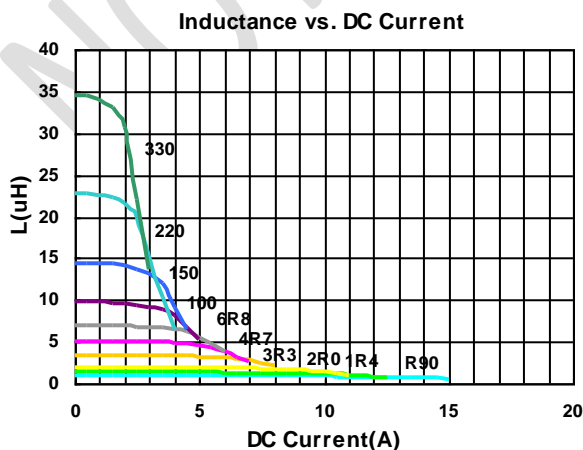

Electrical Characteristics

Part Number	Inductance (uH)	Tolerance (±%)	Test Frequency (kHz)	RDC (mΩ) Max	Isat (A) Typ. (Max)	Irms (A) Typ. (Max)	Marking
LVS808040L-1R0□-N	1.0	30	100	10	9.5(8.55)	8.5(7.65)	1R0
LVS808040L-2R2□-N	2.2	20,30	100	12	7.2(6.48)	7.3(6.57)	2R2
LVS808040L-3R3□-N	3.3	20,30	100	19	5.6(5.04)	6.0(5.40)	3R3
LVS808040L-4R7□-N	4.7	20,30	100	22	4.4(3.96)	5.0(4.50)	4R7
LVS808040L-8R2□-N	8.2	20,30	100	37	3.6(3.24)	3.8(3.42)	8R2
LVS808040L-100□-N	10	20,30	100	42	3.1(2.79)	3.5(3.15)	100
LVS808040L-150□-N	15	20,30	100	58	2.5(2.25)	3.0(2.70)	150
LVS808040L-220□-N	22	20,30	100	85	2.0(1.80)	2.5(2.25)	220

Note: When ordering, please specify tolerance code. Tolerance: M=±20% , T =±30%

- Operating temperature range - 55°C ~ 125°C(Including self - temperature rise)
- Isat for Inductance drop 30% from its value without current
- I rms for a 40°C temperature rise from 25°C ambient with current
- Measure Equipment :
 L : Agilent HP4284A+Agilent HP42841A, 100kHz 1V
 RDC : DIGITAL MILLINHM METER CHROMA 16502, or equivalent
 Isat & I rms : Agilent HP4284A

Test Instruments : HP4284A Material/Impedance Analyzer

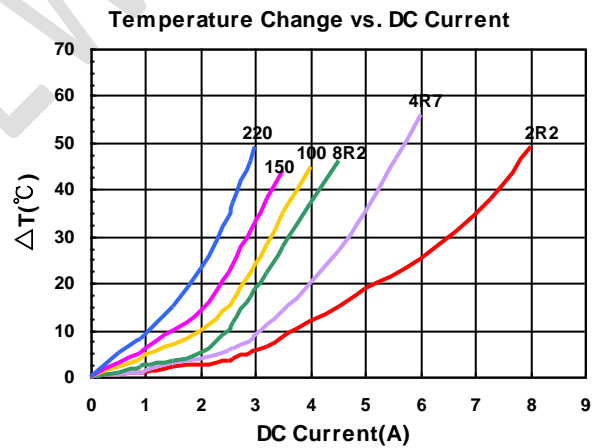
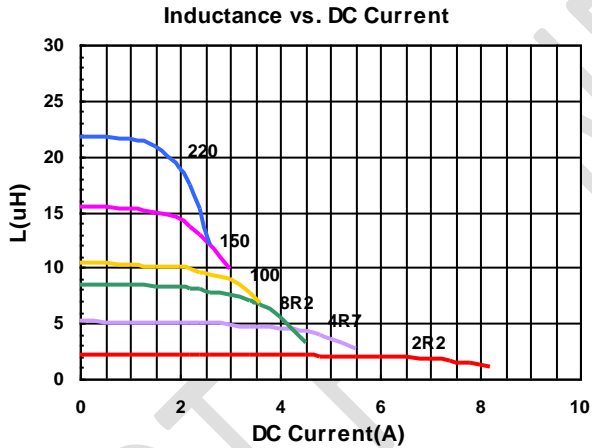

Sealed Power Inductors - LVS Series

Packaging Specifications

Tape Dimensions

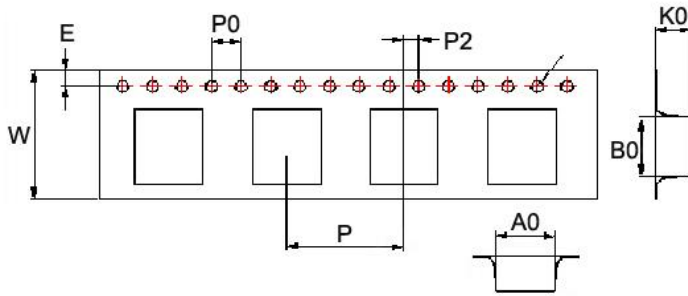

Reel Dimensions

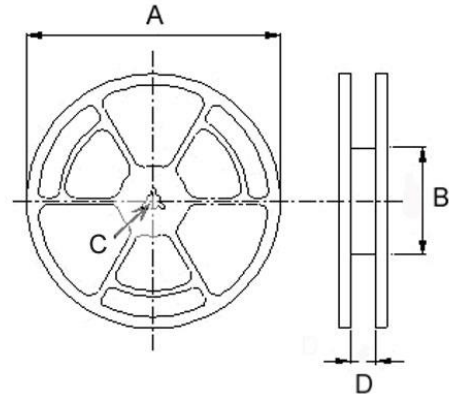

Dimensions in mm

TYPE	Tape Dimensions										Reel Dimensions				Quantity PCS / Reel
	A0	B0	K0	D	E	F	W	P	P0	P2	A	B	C	D	
LVS404012	4.25	4.25	1.30	1.55	1.75	5.5	12	8.1	4	2	180	60	13	13.2	1000
LVS404018	4.25	4.25	2.10	1.55	1.75	5.5	12	8.1	4	2	180	60	13	13.2	800
LVS404026	4.25	4.25	3.00	1.55	1.75	5.5	12	8.1	4	2	180	60	13	13.2	500
LVS505020	5.25	5.25	2.20	1.55	1.75	5.5	12	8.1	4	2	330	100	13	13.4	2000
LVS505040	5.20	5.20	4.20	1.55	1.75	5.5	12	8.1	4	2	330	100	13	13.4	1500
LVS606020	6.25	6.25	2.20	1.55	1.75	7.5	16	12	4	2	330	100	13	16.0	2000
LVS606028	6.25	6.25	3.00	1.55	1.75	7.5	16	12	4	2	330	100	13	16.0	1500
LVS606045	6.25	6.25	4.65	1.55	1.75	7.5	16	12	4	2	330	100	13	16.0	1000
LVS808040	8.25	8.25	4.15	1.55	1.75	7.5	16	12	4	2	330	100	13	16.0	1000

X-ON Electronics

Largest Supplier of Electrical and Electronic Components

Click to view similar products for [Fixed Inductors](#) category:

Click to view products by [Chilisin](#) manufacturer:

Other Similar products are found below :

[CR43NP-680KC](#) [CR54NP-470LC](#) [CR54NP-820KC](#) [CR54NP-8R5MC](#) [70F224AI](#) [MGDQ4-00004-P](#) [MHL1ECTTP18NJ](#) [MHQ1005P10NJ](#)
[MHQ1005P1N0S](#) [MHQ1005P2N4S](#) [MHQ1005P3N6S](#) [MHQ1005P5N1S](#) [MHQ1005P8N2J](#) [PE-51506NL](#) [PE-53601NL](#) [PE-53602NL](#) [PE-](#)
[53630NL](#) [PE-53824SNLT](#) [PE-92100NL](#) [PG0434.801NLT](#) [PG0936.113NLT](#) [9220-20](#) [9310-16](#) [PM06-2N7](#) [PM06-39NJ](#) [A01TK](#) [1206CS-](#)
[471XJ](#) [HC2LP-R47-R](#) [HC2-R47-R](#) [HC3-2R2-R](#) [HC3-R50-R](#) [HC8-1R2-R](#) [HCF1305-3R3-R](#) [1206CS-151XG](#) [RCH664NP-140L](#) [RCH664NP-](#)
[4R7M](#) [RCH8011NP-221L](#) [RCP1317NP-332L](#) [RCP1317NP-391L](#) [RCR1010NP-470M](#) [RCR110DNP-331L](#) [DH2280-4R7M](#) [DS1608C-106](#)
[ASPI-4020HI-R10M-T](#) [B10TJ](#) [B82498B3101J000](#) [B82498B3680J000](#) [ELJ-RE27NJF2](#) [1812CS-153XJ](#) [1812CS-183XJ](#)