

Cautions and Warnings

Please be noted that this spec is only for reference if you have projects designed with the product number listed in. If you are looking for new project design-in, please find BWVS Series specification/datasheet on Chilisin website. Or you may find our sales contact for more information on old part number at your convenience. Appreciated your attention and understanding.

Note: Please be sure to request approval specifications that provide further details of the products. Kindly note that the content of these specifications are subject to change or may be discontinued without prior notice. This product may not be designed/used in medical or high risk applications without Chilisin approval. Please contact our sales department before ordering.

LVS Series



LVS series, an automatic assembly constructed power inductor, is shielded with magnetic resin and suitable for the portable DC-DC converter applications.

Features

- RoHS, Halogen Free and REACH Compliance
- Shielded with magnetic resin
- Various package size and wide inductance range
- Optimize electrical characteristics by using different ferrite core figures

Applications

- AP Routers
- STBs
- LCD TVs, monitors and panels
- Game consoles
- DC/DC converters

Product Identification

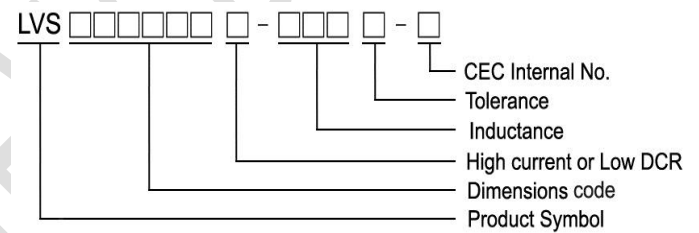

Shape and Dimensions

Figure 1

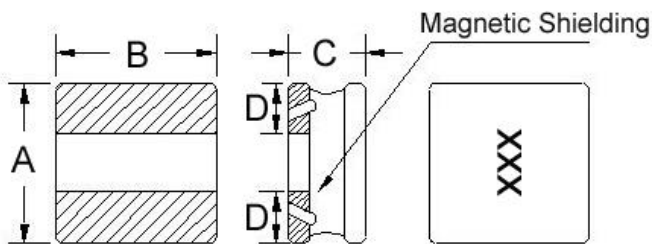

Recommended Pattern



Dimensions in mm

| TYPE | FIG | A | B | C | D | H | I | J |
|-----------|-----|---------|---------|----------|-----|-----|-----|-----|
| LVS404012 | 1 | 4.0±0.2 | 4.0±0.2 | 1.20±0.1 | 1.5 | 4.2 | 1.5 | 1.2 |

Sealed Power Inductors - LVS Series

Shape and Dimensions

Figure 2



Recommended Pattern

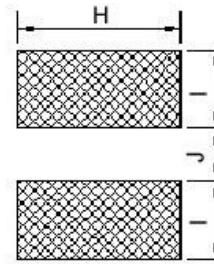

Dimensions in mm

| TYPE | FIG | A | B | C | D | H | I | J |
|-----------|-----|---------|---------|--------------------------------------|---------|-----|-----|-----|
| LVS404018 | 2 | 4.0±0.2 | 4.0±0.2 | 1.8 ^{+0.2} _{-0.30} | 1.3±0.3 | 3.7 | 1.2 | 1.6 |
| LVS404026 | 2 | 4.0±0.2 | 4.0±0.2 | 2.6±0.2 | 1.4 | 3.7 | 1.2 | 1.6 |

Shape and Dimensions

Figure 3

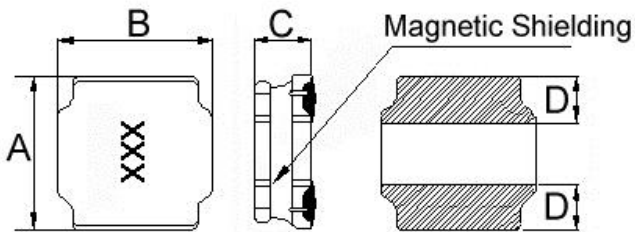

Recommended Pattern

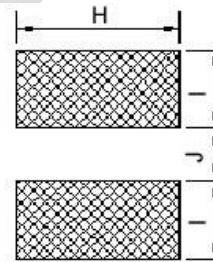

Dimensions in mm

| TYPE | FIG | A | B | C | D | H | I | J |
|------------|-----|---------|---------|--------------------------------------|---------|-----|-----|-----|
| LVS505020 | 3 | 5.0±0.2 | 5.0±0.2 | 2.0 ^{+0.2} _{-0.30} | 1.8±0.3 | 4.0 | 1.5 | 2.1 |
| LVS505040 | 3 | 5.0±0.2 | 5.0±0.2 | 4.0 ^{+0.2} _{-0.30} | 1.6±0.3 | 4.0 | 1.5 | 2.1 |
| LVS606020 | 3 | 6.0±0.2 | 6.0±0.2 | 2.0 ^{+0.2} _{-0.30} | 1.7±0.3 | 5.7 | 1.6 | 2.9 |
| LVS606028 | 3 | 6.0±0.2 | 6.0±0.2 | 2.8 ^{+0.2} _{-0.30} | 1.9±0.3 | 5.7 | 1.6 | 2.9 |
| LVS606045 | 3 | 6.0±0.2 | 6.0±0.2 | 4.5 ^{+0.2} _{-0.30} | 1.8±0.3 | 5.7 | 2.0 | 2.4 |
| LVS606045L | 3 | 6.0±0.2 | 6.0±0.2 | 4.5 ^{+0.2} _{-0.30} | 1.8±0.3 | 5.7 | 2.0 | 2.4 |
| LVS808040 | 3 | 8.0±0.2 | 8.0±0.2 | 4.0 ^{+0.2} _{-0.30} | 2.3±0.3 | 7.5 | 2.5 | 3.4 |
| LVS808040L | 3 | 8.0±0.2 | 8.0±0.2 | 4.0 ^{+0.2} _{-0.30} | 2.3±0.3 | 7.5 | 2.5 | 3.4 |

Electrical Characteristics

| Part Number | Inductance (uH) | Tolerance (±%) | Test Frequency (kHz) | RDC (mΩ) ±30% | Isat (A) Typ. (Max) | Irms (A) Typ. (Max) | Marking |
|------------------|-----------------|----------------|----------------------|---------------|---------------------|---------------------|---------|
| LVS404012-1R0□-N | 1.0 | 20, 30 | 100 | 48 | 2.50(2.25) | 1.70(1.53) | 1R0 |
| LVS404012-1R5□-N | 1.5 | 20, 30 | 100 | 58 | 2.10(1.89) | 1.60(1.44) | 1R5 |
| LVS404012-2R2□-N | 2.2 | 20, 30 | 100 | 65 | 1.70(1.53) | 1.50(1.35) | 2R2 |
| LVS404012-3R3□-N | 3.3 | 20, 30 | 100 | 90 | 1.30(1.17) | 1.40(1.26) | 3R3 |
| LVS404012-4R7□-N | 4.7 | 20, 30 | 100 | 110 | 1.10(0.99) | 1.20(1.08) | 4R7 |
| LVS404012-6R8□-N | 6.8 | 20, 30 | 100 | 135 | 0.90(0.81) | 1.05(0.94) | 6R8 |
| LVS404012-100□-N | 10 | 20, 30 | 100 | 190 | 0.78(0.70) | 0.90(0.81) | 100 |
| LVS404012-150□-N | 15 | 20, 30 | 100 | 250 | 0.65(0.58) | 0.85(0.76) | 150 |
| LVS404012-220□-N | 22 | 20, 30 | 100 | 400 | 0.52(0.46) | 0.75(0.67) | 220 |
| LVS404012-330□-N | 33 | 20, 30 | 100 | 600 | 0.44(0.39) | 0.70(0.63) | 330 |
| LVS404012-470□-N | 47 | 20, 30 | 100 | 930 | 0.35(0.31) | 0.50(0.45) | 470 |

Note: When ordering, please specify tolerance code. Tolerance: M=±20% , T =±30%

- Operating temperature range - 55°C ~ 125°C(Including self - temperature rise)
- Isat for Inductance drop 30% from its value without current
- I rms for a 40°C temperature rise from 25°C ambient with current
- Measure Equipment :
 - L : Agilent HP4284A+Agilent HP42841A, 100kHz 1V
 - RDC : DIGITAL MILLINHM METER CHROMA 16502, or equivalent
 - Isat & I rms : Agilent HP4284A

Test Instruments : HP4284A Material/Impedance Analyzer

Inductance vs. DC Current

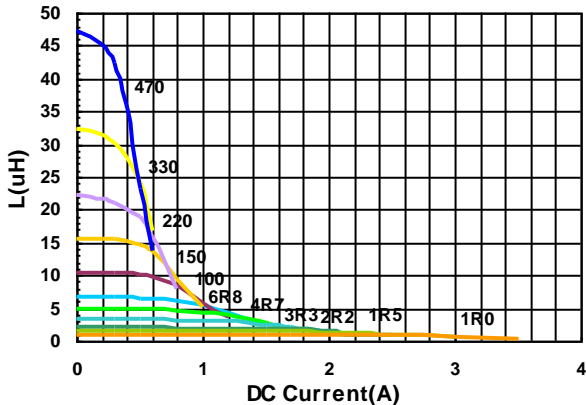

Temperature Change vs. DC Current

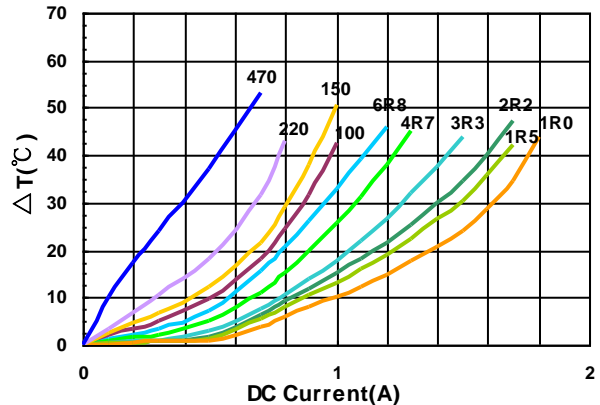

Electrical Characteristics

| Part Number | Inductance (uH) | Tolerance (±%) | Test Frequency (kHz) | RDC (mΩ) ±20% | Isat (A) Typ. (Max) | Irms (A) Typ. (Max) | Marking |
|------------------|-----------------|----------------|----------------------|---------------|---------------------|---------------------|---------|
| LVS404018-1R0□-N | 1.0 | 20, 30 | 100 | 32 | 4.10(3.69) | 2.80(2.52) | 1R0 |
| LVS404018-1R5□-N | 1.5 | 20, 30 | 100 | 40 | 3.30(2.97) | 2.60(2.34) | 1R5 |
| LVS404018-1R8□-N | 1.8 | 20, 30 | 100 | 55 | 2.80(2.50) | 2.50(2.20) | 1R8 |
| LVS404018-2R2□-N | 2.2 | 20, 30 | 100 | 60 | 2.80(2.52) | 2.50(2.25) | 2R2 |
| LVS404018-3R3□-N | 3.3 | 20, 30 | 100 | 70 | 2.20(1.98) | 2.10(1.89) | 3R3 |
| LVS404018-3R6□-N | 3.6 | 20, 30 | 100 | 75 | 2.10(1.89) | 1.90(1.71) | 3R6 |
| LVS404018-3R9□-N | 3.9 | 20, 30 | 100 | 75 | 2.10(1.89) | 1.90(1.71) | 3R9 |
| LVS404018-4R7□-N | 4.7 | 20, 30 | 100 | 90 | 2.00(1.80) | 1.70(1.53) | 4R7 |
| LVS404018-6R8□-N | 6.8 | 20, 30 | 100 | 110 | 1.60(1.44) | 1.50(1.35) | 6R8 |
| LVS404018-8R2□-N | 8.2 | 20, 30 | 100 | 155 | 1.50(1.30) | 1.30(1.10) | 8R2 |
| LVS404018-100□-N | 10 | 20, 30 | 100 | 170 | 1.40(1.26) | 1.20(1.08) | 100 |
| LVS404018-150□-N | 15 | 20, 30 | 100 | 250 | 1.00(0.90) | 1.00(0.90) | 150 |
| LVS404018-220□-N | 22 | 20, 30 | 100 | 350 | 0.90(0.81) | 0.85(0.76) | 220 |
| LVS404018-330□-N | 33 | 20, 30 | 100 | 530 | 0.80(0.72) | 0.70(0.63) | 330 |
| LVS404018-470□-N | 47 | 20, 30 | 100 | 720 | 0.70(0.63) | 0.56(0.50) | 470 |
| LVS404018-680□-N | 68 | 20, 30 | 100 | 1000 | 0.56(0.50) | 0.45(0.40) | 680 |
| LVS404018-101□-N | 100 | 20, 30 | 100 | 1500 | 0.46(0.41) | 0.38(0.34) | 101 |
| LVS404018-151□-N | 150 | 20, 30 | 100 | 2500 | 0.35(0.31) | 0.30(0.27) | 151 |
| LVS404018-221□-N | 220 | 20, 30 | 100 | 4000 | 0.28(0.25) | 0.23(0.20) | 221 |

Note: When ordering, please specify tolerance code. Tolerance: M=±20% , T =±30%

- Operating temperature range - 55°C ~ 125°C(Including self - temperature rise)
- Isat for Inductance drop 30% from its value without current
- Irms for a 40°C temperature rise from 25°C ambient with current
- Measure Equipment :
 L : Agilent HP4284A+Agilent HP42841A, 100kHz 1V
 RDC : DIGITAL MILLINHM METER CHROMA 16502, or equivalent
 Isat & Irms : Agilent HP4284A

Test Instruments : HP4284A Material/Impedance Analyzer

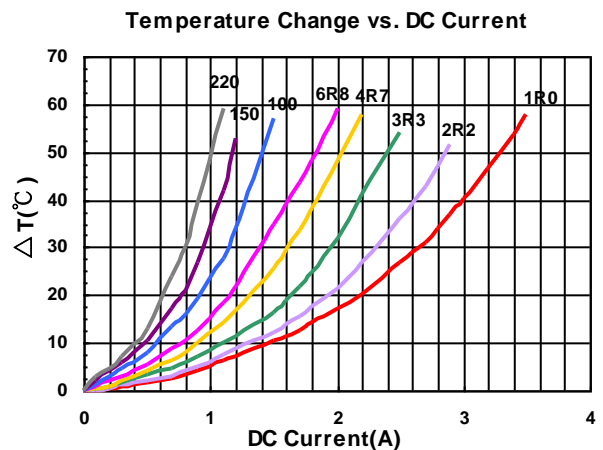
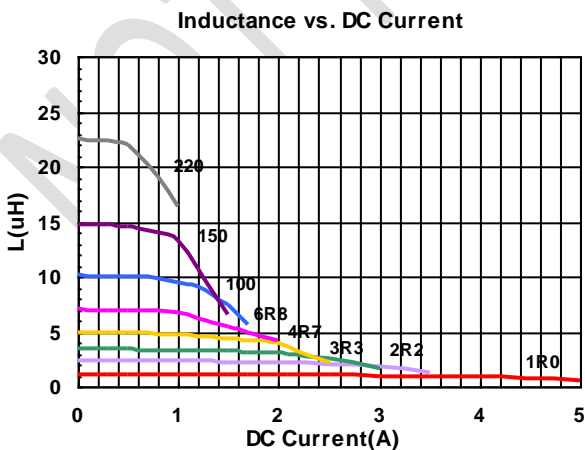

Electrical Characteristics

| Part Number | Inductance (uH) | Tolerance (±%) | Test Frequency (kHz) | RDC (mΩ) ±30% | Isat (A) Typ. (Max) | Irms (A) Typ. (Max) | Marking |
|------------------|-----------------|----------------|----------------------|---------------|---------------------|---------------------|---------|
| LVS404026-1R2□-N | 1.2 | 20, 30 | 100 | 30 | 3.50(3.15) | 3.30(2.97) | 1R2 |
| LVS404026-3R3□-N | 3.3 | 20, 30 | 100 | 45 | 2.50(2.25) | 2.50(2.25) | 3R3 |
| LVS404026-4R7□-N | 4.7 | 20, 30 | 100 | 60 | 1.80(1.62) | 1.80(1.62) | 4R7 |
| LVS404026-220□-N | 22 | 20, 30 | 100 | 230 | 0.86(0.77) | 1.00(0.90) | 220 |

Note: When ordering, please specify tolerance code. Tolerance: M=±20% , T =±30%

- Operating temperature range - 55°C ~ 125°C(Including self - temperature rise)
- Isat for Inductance drop 30% from its value without current
- Irms for a 40°C temperature rise from 25°C ambient with current
- Measure Equipment :
 L : Agilent HP4284A+Agilent HP42841A, 100kHz 1V
 RDC : DIGITAL MILLINHM METER CHROMA 16502, or equivalent
 Isat & Irms : Agilent HP4284A

Test Instruments : HP4284A Material/Impedance Analyzer

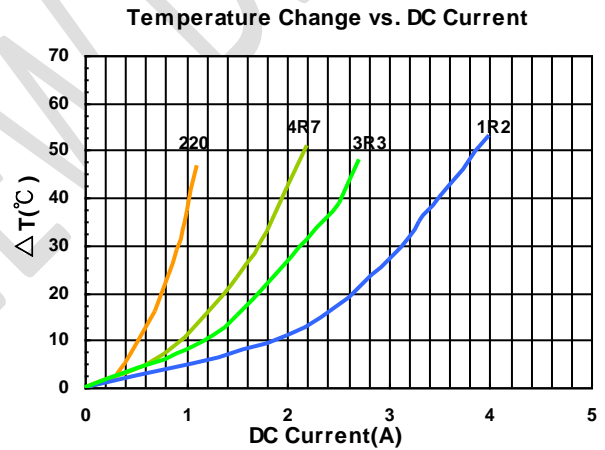
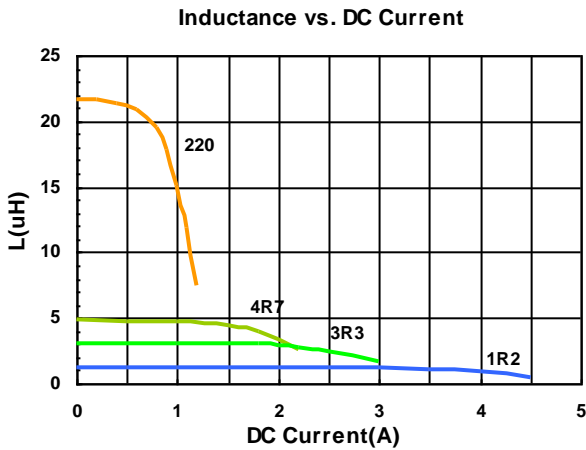

Electrical Characteristics

| Part Number | Inductance (uH) | Tolerance (±%) | Test Frequency (kHz) | RDC (mΩ) ±20% | Isat (A) Typ. (Max) | Irms (A) Typ. (Max) | Marking |
|------------------|-----------------|----------------|----------------------|---------------|---------------------|---------------------|---------|
| LVS505020-1R0□-N | 1.0 | 20, 30 | 100 | 21 | 5.1(4.59) | 4.0(3.60) | 1R0 |
| LVS505020-1R2□-N | 1.2 | 30 | 100 | 21 | 4.8(4.32) | 3.8(3.42) | 1R2 |
| LVS505020-1R5□-N | 1.5 | 20, 30 | 100 | 26 | 4.2(3.78) | 3.5(3.15) | 1R5 |
| LVS505020-2R2□-N | 2.2 | 20, 30 | 100 | 35 | 3.4(3.06) | 3.2(2.88) | 2R2 |
| LVS505020-2R7□-N | 2.7 | 20, 30 | 100 | 38 | 3.05(2.7) | 2.9(2.60) | 2R7 |
| LVS505020-3R3□-N | 3.3 | 20, 30 | 100 | 48 | 3.0(2.70) | 2.8(2.52) | 3R3 |
| LVS505020-4R7□-N | 4.7 | 20, 30 | 100 | 60 | 2.2(1.98) | 2.2(1.98) | 4R7 |
| LVS505020-5R6□-N | 5.6 | 20, 30 | 100 | 82 | 2.05(1.84) | 2.0(1.80) | 5R6 |
| LVS505020-6R8□-N | 6.8 | 20, 30 | 100 | 90 | 2.0(1.80) | 1.8(1.62) | 6R8 |
| LVS505020-100□-N | 10 | 20, 30 | 100 | 120 | 1.6(1.44) | 1.6(1.44) | 100 |
| LVS505020-150□-N | 15 | 20, 30 | 100 | 190 | 1.3(1.17) | 1.2(1.08) | 150 |
| LVS505020-220□-N | 22 | 20, 30 | 100 | 260 | 1.0(0.90) | 1.0(0.90) | 220 |
| LVS505020-330□-N | 33 | 20, 30 | 100 | 460 | 0.8(0.72) | 0.75(0.67) | 330 |
| LVS505020-470□-N | 47 | 20, 30 | 100 | 580 | 0.65(0.58) | 0.65(0.58) | 470 |

Note: When ordering, please specify tolerance code. Tolerance: M=±20% , T =±30%

- Operating temperature range - 55°C ~ 125°C(Including self - temperature rise)
- Isat for Inductance drop 30% from its value without current
- I rms for a 40°C temperature rise from 25°C ambient with current
- Measure Equipment :
 L : Agilent HP4284A+Agilent HP42841A, 100kHz 1V
 RDC : DIGITAL MILLINHM METER CHROMA 16502, or equivalent
 Isat & I rms : Agilent HP4284A

Test Instruments : HP4284A Material/Impedance Analyzer

Inductance vs. DC Current



Temperature Change vs. DC Current

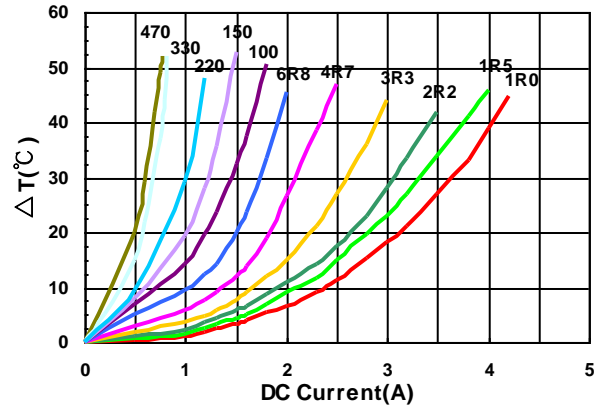

Electrical Characteristics

| Part Number | Inductance (uH) | Tolerance (±%) | Test Frequency (kHz) | RDC (mΩ) ±30% | Isat (A) Typ. (Max) | Irms (A) Typ. (Max) | Marking |
|------------------|-----------------|----------------|----------------------|---------------|---------------------|---------------------|---------|
| LVS505040-1R0□-N | 1.0 | 20, 30 | 100 | 14 | 7.5(6.75) | 4.6(4.14) | 1R0 |
| LVS505040-1R2□-N | 1.2 | 20, 30 | 100 | 15 | 7.4(6.66) | 4.5(4.05) | 1R2 |
| LVS505040-1R5□-N | 1.5 | 20, 30 | 100 | 16 | 7.1(6.39) | 4.4(3.96) | 1R5 |
| LVS505040-2R2□-N | 2.2 | 20, 30 | 100 | 21 | 5.7(5.13) | 3.7(3.33) | 2R2 |
| LVS505040-3R0□-N | 2.2 | 20, 30 | 100 | 26 | 4.8(4.32) | 3.5(3.15) | 3R0 |
| LVS505040-3R3□-N | 3.3 | 20, 30 | 100 | 26 | 4.8(4.32) | 3.5(3.15) | 3R3 |
| LVS505040-3R6□-N | 3.6 | 20, 30 | 100 | 31 | 4.2(3.70) | 3.3(2.90) | 3R6 |
| LVS505040-4R7□-N | 4.7 | 20, 30 | 100 | 32 | 4.2(3.78) | 3.2(2.88) | 4R7 |
| LVS505040-6R8□-N | 6.8 | 20, 30 | 100 | 50 | 3.3(2.97) | 2.4(2.16) | 6R8 |
| LVS505040-8R2□-N | 8.2 | 20, 30 | 100 | 58 | 3.1(2.70) | 2.3(2.00) | 8R2 |
| LVS505040-100□-N | 10 | 20, 30 | 100 | 60 | 2.8(2.52) | 2.2(1.98) | 100 |
| LVS505040-150□-N | 15 | 20, 30 | 100 | 90 | 2.3(2.07) | 1.8(1.62) | 150 |
| LVS505040-220□-N | 22 | 20, 30 | 100 | 135 | 1.8(1.62) | 1.4(1.26) | 220 |
| LVS505040-270□-N | 27 | 20, 30 | 100 | 180 | 1.6(1.44) | 1.2(1.08) | 270 |
| LVS505040-330□-N | 33 | 20, 30 | 100 | 190 | 1.5(1.35) | 1.1(0.99) | 330 |
| LVS505040-470□-N | 47 | 20, 30 | 100 | 310 | 1.2(1.08) | 0.9(0.81) | 470 |
| LVS505040-680□-N | 68 | 20, 30 | 100 | 540 | 1.0(0.90) | 0.78(0.7) | 680 |
| LVS505040-101□-N | 100 | 20, 30 | 100 | 800 | 0.7(0.60) | 0.6(0.50) | 101 |

Note: When ordering, please specify tolerance code. Tolerance: M=±20% , T =±30%

- Operating temperature range - 55°C ~ 125°C(Including self - temperature rise)
- Isat for Inductance drop 30% from its value without current
- I rms for a 40°C temperature rise from 25°C ambient with current
- Measure Equipment :
 L : Agilent HP4284A+Agilent HP42841A, 100kHz 1V
 RDC : DIGITAL MILLINHM METER CHROMA 16502, or equivalent
 Isat & I rms : Agilent HP4284A

Test Instruments : HP4284A Material/Impedance Analyzer

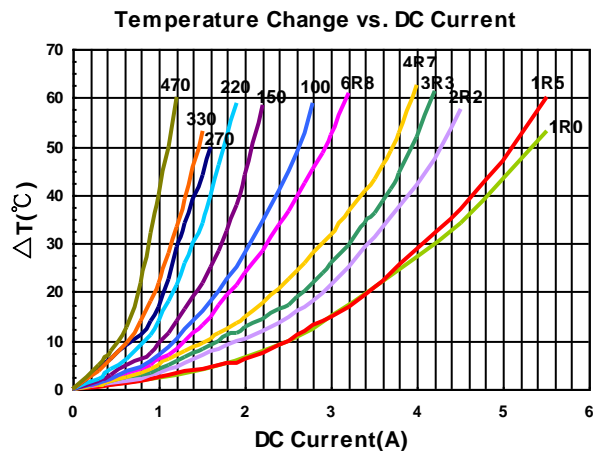
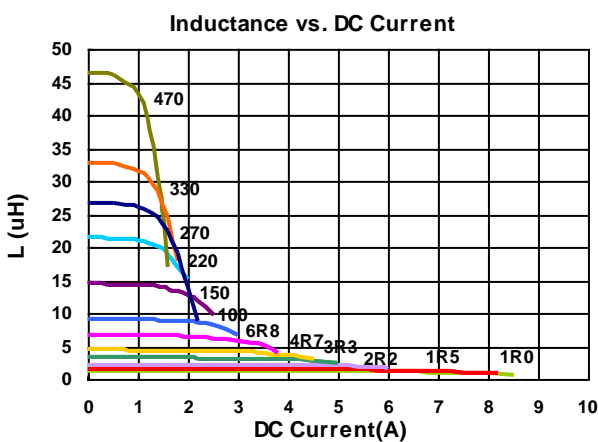

Electrical Characteristics

| Part Number | Inductance (uH) | Tolerance (±%) | Test Frequency (kHz) | RDC (mΩ) ±30% | Isat (A) Typ. (Max) | Irms (A) Typ. (Max) | Marking |
|------------------|-----------------|----------------|----------------------|---------------|---------------------|---------------------|---------|
| LVS606020-R50□-N | 0.5 | 30 | 100 | 13 | 8.0(7.20) | 5.3(4.77) | R50 |
| LVS606020-R90□-N | 0.9 | 30 | 100 | 18 | 6.3(5.67) | 4.2(3.78) | R90 |
| LVS606020-1R0□-N | 1.0 | 30 | 100 | 19 | 6.2(5.58) | 4.1(3.69) | 1R0 |
| LVS606020-1R5□-N | 1.5 | 20, 30 | 100 | 26 | 5.0(4.50) | 3.6(3.24) | 1R5 |
| LVS606020-2R2□-N | 2.2 | 20, 30 | 100 | 34 | 4.2(3.78) | 3.2(2.88) | 2R2 |
| LVS606020-3R3□-N | 3.3 | 20, 30 | 100 | 40 | 3.2(2.88) | 2.7(2.43) | 3R3 |
| LVS606020-4R7□-N | 4.7 | 20, 30 | 100 | 58 | 2.5(2.25) | 2.2(1.98) | 4R7 |
| LVS606020-6R8□-N | 6.8 | 20, 30 | 100 | 85 | 2.2(1.98) | 1.8(1.62) | 6R8 |
| LVS606020-100□-N | 10 | 20, 30 | 100 | 125 | 2.0(1.80) | 1.6(1.44) | 100 |
| LVS606020-150□-N | 15 | 20, 30 | 100 | 190 | 1.3(1.17) | 1.3(1.17) | 150 |
| LVS606020-220□-N | 22 | 20, 30 | 100 | 260 | 1.1(0.99) | 1.1(0.99) | 220 |

Note: When ordering, please specify tolerance code. Tolerance: M=±20% , T =±30%

- Operating temperature range - 55°C ~ 125°C(Including self - temperature rise)
- Isat for Inductance drop 30% from its value without current
- Irms for a 40°C temperature rise from 25°C ambient with current
- Measure Equipment :
 L : Agilent HP4284A+Agilent HP42841A, 100kHz 1V
 RDC : DIGITAL MILLINHM METER CHROMA 16502, or equivalent
 Isat & Irms : Agilent HP4284A

Test Instruments : HP4284A Material/Impedance Analyzer

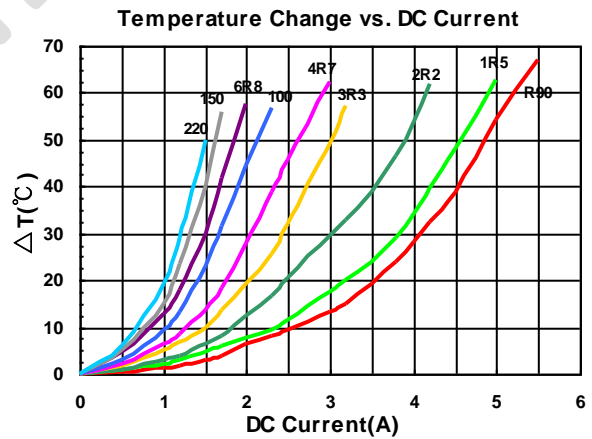
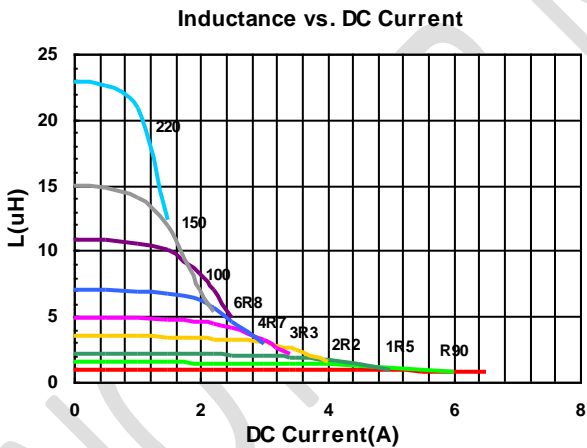

Electrical Characteristics

| Part Number | Inductance (uH) | Tolerance (±%) | Test Frequency (kHz) | RDC (mΩ) ±30% | Isat (A) Typ. (Max) | Irms (A) Typ. (Max) | Marking |
|------------------|-----------------|----------------|----------------------|---------------|---------------------|---------------------|---------|
| LVS606028-1R0□-N | 1.0 | 20, 30 | 100 | 13 | 7.6(6.84) | 5.2(4.68) | 1R0 |
| LVS606028-1R5□-N | 1.5 | 30 | 100 | 16 | 6.3(5.67) | 4.8(4.32) | 1R5 |
| LVS606028-2R2□-N | 2.2 | 20, 30 | 100 | 20 | 5.4(4.86) | 4.0(3.60) | 2R2 |
| LVS606028-2R7□-N | 2.7 | 20, 30 | 100 | 26 | 4.9(4.41) | 3.7(3.33) | 2R7 |
| LVS606028-3R3□-N | 3.3 | 20, 30 | 100 | 28 | 4.3(3.87) | 3.5(3.15) | 3R3 |
| LVS606028-4R7□-N | 4.7 | 20, 30 | 100 | 38 | 3.7(3.33) | 3.2(2.88) | 4R7 |
| LVS606028-6R0□-N | 6.0 | 20, 30 | 100 | 45 | 3.3(2.97) | 2.8(2.52) | 6R0 |
| LVS606028-6R8□-N | 6.8 | 20, 30 | 100 | 50 | 3.1(2.79) | 2.7(2.43) | 6R8 |
| LVS606028-100□-N | 10 | 20, 30 | 100 | 65 | 2.5(2.25) | 2.3(2.07) | 100 |
| LVS606028-150□-N | 15 | 20, 30 | 100 | 95 | 2.0(1.80) | 1.8(1.62) | 150 |
| LVS606028-220□-N | 22 | 20, 30 | 100 | 135 | 1.6(1.44) | 1.5(1.35) | 220 |
| LVS606028-330□-N | 33 | 20, 30 | 100 | 220 | 1.3(1.17) | 1.4(1.26) | 330 |
| LVS606028-470□-N | 47 | 20, 30 | 100 | 320 | 1.1(0.99) | 1.0(0.90) | 470 |
| LVS606028-680□-N | 68 | 20, 30 | 100 | 420 | 0.98(0.88) | 0.9(0.81) | 680 |
| LVS606028-101□-N | 100 | 20, 30 | 100 | 600 | 0.82(0.73) | 0.8(0.72) | 101 |

Note: When ordering, please specify tolerance code. Tolerance: M=±20% , T =±30%

- Operating temperature range - 55°C ~ 125°C(Including self - temperature rise)
- Isat for Inductance drop 30% from its value without current
- I rms for a 40°C temperature rise from 25°C ambient with current
- Measure Equipment :
 L : Agilent HP4284A+Agilent HP42841A, 100kHz 1V
 RDC : DIGITAL MILLINHM METER CHROMA 16502, or equivalent
 Isat & I rms : Agilent HP4284A

Test Instruments : HP4284A Material/Impedance Analyzer

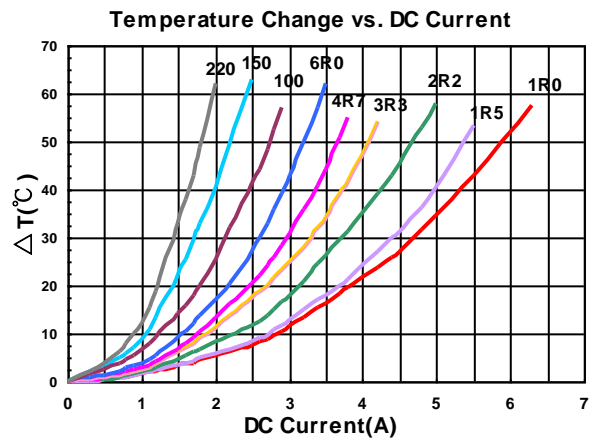

Electrical Characteristics

| Part Number | Inductance (uH) | Tolerance (±%) | Test Frequency (kHz) | RDC (mΩ) ±30% | Isat (A) Typ. (Max) | Irms (A) Typ. (Max) | Marking |
|------------------|-----------------|----------------|----------------------|---------------|---------------------|---------------------|---------|
| LVS606045-1R0□-N | 1.0 | 20, 30 | 100 | 12 | 12.2(10.98) | 6.5(5.85) | 1R0 |
| LVS606045-1R2□-N | 1.2 | 20, 30 | 100 | 13 | 10.6(9.50) | 5.9(5.30) | 1R2 |
| LVS606045-1R5□-N | 1.5 | 20, 30 | 100 | 15 | 10.4(9.36) | 5.9(5.31) | 1R5 |
| LVS606045-1R8□-N | 1.8 | 20, 30 | 100 | 17 | 9.6(8.64) | 5.6(5.04) | 1R8 |
| LVS606045-2R2□-N | 2.2 | 20, 30 | 100 | 18.4 | 8.8(7.92) | 5.1(4.59) | 2R2 |
| LVS606045-2R3□-N | 2.3 | 20, 30 | 100 | 19 | 8.8(7.92) | 5.0(4.50) | 2R3 |
| LVS606045-3R0□-N | 3.0 | 20, 30 | 100 | 22 | 7.8(7.02) | 4.4(3.96) | 3R0 |
| LVS606045-3R3□-N | 3.3 | 20, 30 | 100 | 24 | 7.5(6.75) | 4.3(3.87) | 3R3 |
| LVS606045-3R6□-N | 3.6 | 20, 30 | 100 | 24 | 7.5(6.75) | 4.3(3.87) | 3R6 |
| LVS606045-3R9□-N | 3.9 | 20, 30 | 100 | 26 | 7.0(6.30) | 4.0(3.60) | 3R9 |
| LVS606045-4R5□-N | 4.5 | 20, 30 | 100 | 31 | 6.7(6.03) | 3.9(3.51) | 4R5 |
| LVS606045-4R7□-N | 4.7 | 20, 30 | 100 | 31 | 6.7(6.03) | 3.9(3.51) | 4R7 |
| LVS606045-5R1□-N | 5.1 | 20, 30 | 100 | 33 | 6.0(5.40) | 3.5(3.15) | 5R1 |
| LVS606045-5R6□-N | 5.6 | 20, 30 | 100 | 40 | 5.5(4.95) | 3.3(2.97) | 5R6 |
| LVS606045-6R3□-N | 6.3 | 20, 30 | 100 | 40 | 5.5(4.95) | 3.3(2.97) | 6R3 |
| LVS606045-6R8□-N | 6.8 | 20, 30 | 100 | 43 | 5.3(4.77) | 3.2(2.88) | 6R8 |
| LVS606045-8R2□-N | 8.2 | 20, 30 | 100 | 53 | 4.6(4.10) | 2.9(2.60) | 8R2 |
| LVS606045-100□-N | 10 | 20, 30 | 100 | 57 | 4.5(4.05) | 2.7(2.43) | 100 |
| LVS606045-150□-N | 15 | 20, 30 | 100 | 80 | 3.4(3.06) | 2.2(1.98) | 150 |
| LVS606045-180□-N | 18 | 20, 30 | 100 | 100 | 3.1(2.79) | 1.8(1.62) | 180 |
| LVS606045-220□-N | 22 | 20, 30 | 100 | 125 | 3.0(2.70) | 1.9(1.71) | 220 |
| LVS606045-270□-N | 27 | 20, 30 | 100 | 160 | 2.5(2.25) | 1.3(1.17) | 270 |
| LVS606045-330□-N | 33 | 20, 30 | 100 | 165 | 2.3(2.07) | 1.4(1.26) | 330 |
| LVS606045-470□-N | 47 | 20, 30 | 100 | 245 | 1.9(1.71) | 1.2(1.08) | 470 |
| LVS606045-560□-N | 56 | 20, 30 | 100 | 310 | 1.7(1.50) | 1.1(0.99) | 560 |
| LVS606045-680□-N | 68 | 20, 30 | 100 | 330 | 1.6(1.44) | 1.0(0.90) | 680 |
| LVS606045-101□-N | 100 | 20, 30 | 100 | 500 | 1.3(1.17) | 0.8(0.72) | 101 |
| LVS606045-221□-N | 220 | 20, 30 | 100 | 1300 | 0.82(0.73) | 0.38(0.34) | 221 |
| LVS606045-331□-N | 330 | 20, 30 | 100 | 1800 | 0.7(0.63) | 0.35(0.31) | 331 |
| LVS606045-102□-N | 1000 | 20, 30 | 100 | 6000 | 0.4(0.36) | 0.22(0.19) | 102 |

Note: When ordering, please specify tolerance code. Tolerance: M=±20% , T =±30%

- Operating temperature range - 55°C ~ 125°C(Including self - temperature rise)
- Isat for Inductance drop 30% from its value without current
- Irms for a 40°C temperature rise from 25°C ambient with current
- Measure Equipment :
 L : Agilent HP4284A+Agilent HP42841A, 100kHz 1V
 RDC : DIGITAL MILLINHM METER CHROMA 16502, or equivalent
 Isat & Irms : Agilent HP4284A

Test Instruments : HP4284A Material/Impedance Analyzer

Inductance vs. DC Current

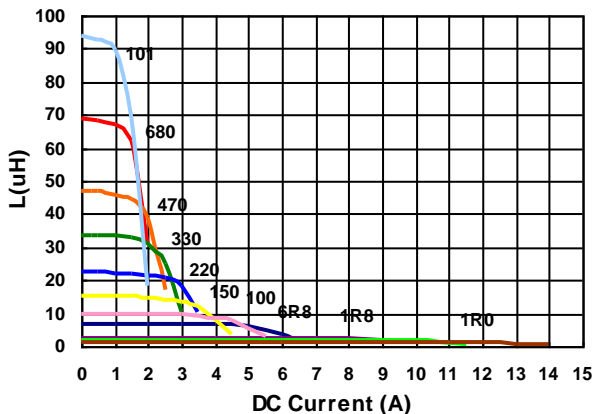

Temperature Change vs. DC Current

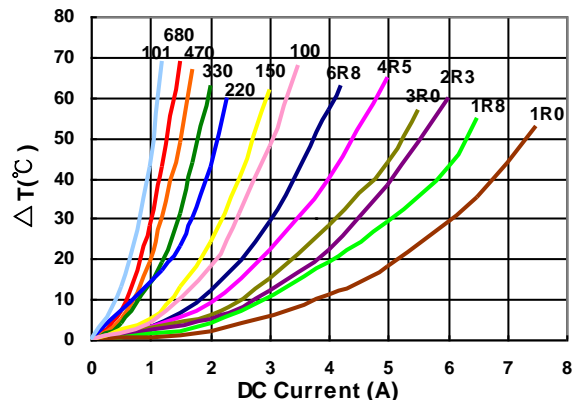

Electrical Characteristics

| Part Number | Inductance (uH) | Tolerance (±%) | Test Frequency (kHz) | RDC (mΩ) Max | Isat (A) Typ. (Max) | Irms (A) Typ. (Max) | Marking |
|-------------------|-----------------|----------------|----------------------|--------------|---------------------|---------------------|---------|
| LVS606045L-R50□-N | 0.5 | 30 | 100 | 9 | 11(9.90) | 8.0(7.20) | R50 |
| LVS606045L-2R2□-N | 2.2 | 20, 30 | 100 | 17 | 6.8(6.12) | 5.5(4.95) | 2R2 |
| LVS606045L-3R3□-N | 3.3 | 20, 30 | 100 | 24 | 5.5(4.95) | 4.7(4.23) | 3R3 |
| LVS606045L-4R7□-N | 4.7 | 20, 30 | 100 | 30 | 4.6(4.14) | 4.0(3.60) | 4R7 |
| LVS606045L-6R8□-N | 6.8 | 20, 30 | 100 | 40 | 4.0(3.60) | 3.5(3.15) | 6R8 |
| LVS606045L-100□-N | 10 | 20, 30 | 100 | 50 | 3.2(2.88) | 3.2(2.88) | 100 |
| LVS606045L-150□-N | 15 | 20, 30 | 100 | 80 | 2.6(2.34) | 2.5(2.25) | 150 |
| LVS606045L-220□-N | 22 | 20, 30 | 100 | 120 | 2.1(1.89) | 2.0(1.80) | 220 |
| LVS606045L-330□-N | 33 | 20, 30 | 100 | 170 | 1.7(1.53) | 1.6(1.44) | 330 |
| LVS606045L-101□-N | 100 | 20, 30 | 100 | 595 | 0.95(0.85) | 0.92(0.82) | 101 |

Note: When ordering, please specify tolerance code. Tolerance: M=±20% , T =±30%

- Operating temperature range - 55°C ~ 125°C(Including self - temperature rise)
- Isat for Inductance drop 30% from its value without current
- Irms for a 40°C temperature rise from 25°C ambient with current
- Measure Equipment :
 L : Agilent HP4284A+Agilent HP42841A, 100kHz 1V
 RDC : DIGITAL MILLINHM METER CHROMA 16502, or equivalent
 Isat & Irms : Agilent HP4284A

Test Instruments : HP4284A Material/Impedance Analyzer

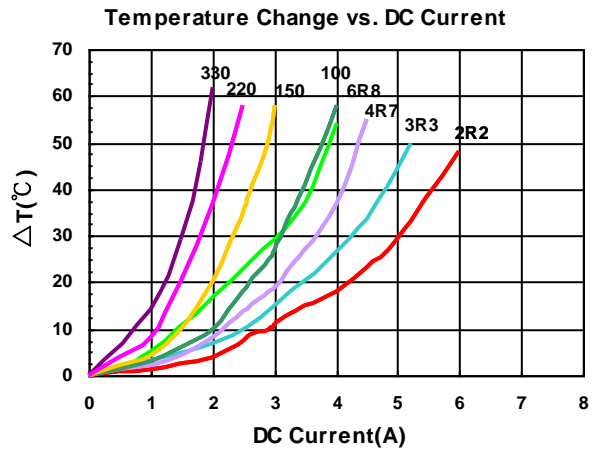
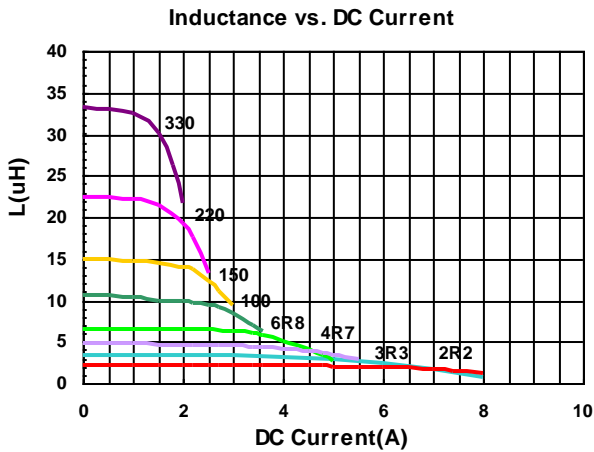

Electrical Characteristics

| Part Number | Inductance (uH) | Tolerance (±%) | Test Frequency (kHz) | RDC (mΩ) ±30% | Isat (A) Typ. (Max) | Irms (A) Typ. (Max) | Marking |
|------------------|-----------------|----------------|----------------------|---------------|---------------------|---------------------|---------|
| LVS808040-R90□-N | 0.9 | 30 | 100 | 7 | 13.8(12.42) | 8.05(7.24) | R90 |
| LVS808040-1R0□-N | 1.0 | 30 | 100 | 7.5 | 13.0(11.70) | 7.95(7.15) | 1R0 |
| LVS808040-1R4□-N | 1.4 | 30 | 100 | 9 | 10.8(9.72) | 7.8(7.02) | 1R4 |
| LVS808040-1R5□-N | 1.5 | 30 | 100 | 9.5 | 10.0(9.00) | 7.7(6.93) | 1R5 |
| LVS808040-2R0□-N | 2.0 | 20, 30 | 100 | 11 | 9.6(8.64) | 7.4(6.66) | 2R0 |
| LVS808040-2R2□-N | 2.2 | 20, 30 | 100 | 11.5 | 9.2(8.28) | 7.2(6.48) | 2R2 |
| LVS808040-2R5□-N | 2.5 | 20, 30 | 100 | 13 | 8.2(7.38) | 6.3(5.67) | 2R5 |
| LVS808040-3R3□-N | 3.3 | 20, 30 | 100 | 15 | 7.5(6.75) | 6.0(5.40) | 3R3 |
| LVS808040-3R9□-N | 3.9 | 20, 30 | 100 | 18 | 6.1(5.40) | 5.5(4.90) | 3R9 |
| LVS808040-4R7□-N | 4.7 | 20, 30 | 100 | 18 | 6.0(5.40) | 5.5(4.95) | 4R7 |
| LVS808040-5R6□-N | 5.6 | 20, 30 | 100 | 23 | 5.7(5.13) | 5.2(4.68) | 5R6 |
| LVS808040-6R8□-N | 6.8 | 20, 30 | 100 | 25 | 5.4(4.86) | 5.1(4.59) | 6R8 |
| LVS808040-100□-N | 10 | 20, 30 | 100 | 38 | 4.3(3.87) | 3.8(3.42) | 100 |
| LVS808040-120□-N | 12 | 20, 30 | 100 | 45 | 3.8(3.42) | 3.5(3.15) | 120 |
| LVS808040-150□-N | 15 | 20, 30 | 100 | 50 | 3.6(3.24) | 3.2(2.88) | 150 |
| LVS808040-180□-N | 18 | 20, 30 | 100 | 68 | 3.1(2.79) | 2.7(2.43) | 180 |
| LVS808040-220□-N | 22 | 20, 30 | 100 | 80 | 2.8(2.52) | 2.6(2.34) | 220 |
| LVS808040-330□-N | 33 | 20, 30 | 100 | 110 | 2.3(2.07) | 2.0(1.80) | 330 |
| LVS808040-470□-N | 47 | 20, 30 | 100 | 160 | 1.9(1.71) | 1.75(1.57) | 470 |
| LVS808040-680□-N | 68 | 20, 30 | 100 | 240 | 1.7(1.53) | 1.45(1.30) | 680 |
| LVS808040-101□-N | 100 | 20, 30 | 100 | 340 | 1.4(1.26) | 1.10(0.99) | 101 |
| LVS808040-121□-N | 120 | 20, 30 | 100 | 425 | 1.1(0.99) | 1.0(0.90) | 121 |
| LVS808040-151□-N | 150 | 20, 30 | 100 | 480 | 1.0(0.90) | 0.9(0.81) | 151 |
| LVS808040-181□-N | 180 | 20, 30 | 100 | 650 | 0.98(0.88) | 0.7(0.63) | 181 |
| LVS808040-221□-N | 220 | 20, 30 | 100 | 670 | 0.94(0.84) | 0.60(0.54) | 221 |
| LVS808040-271□-N | 270 | 20, 30 | 100 | 900 | 0.83(0.74) | 0.55(0.49) | 271 |
| LVS808040-821□-N | 820 | 20, 30 | 100 | 2800 | 0.40(0.36) | 0.38(0.34) | 821 |

Note: When ordering, please specify tolerance code. Tolerance: M=±20% , T =±30%

- Operating temperature range - 55°C ~ 125°C(Including self - temperature rise)
- Isat for Inductance drop 30% from its value without current
- Irms for a 40°C temperature rise from 25°C ambient with current
- Measure Equipment :
 L : Agilent HP4284A+Agilent HP42841A, 100kHz 1V
 RDC : DIGITAL MILLINHM METER CHROMA 16502, or equivalent
 Isat & Irms : Agilent HP4284A

Test Instruments : HP4284A Material/Impedance Analyzer

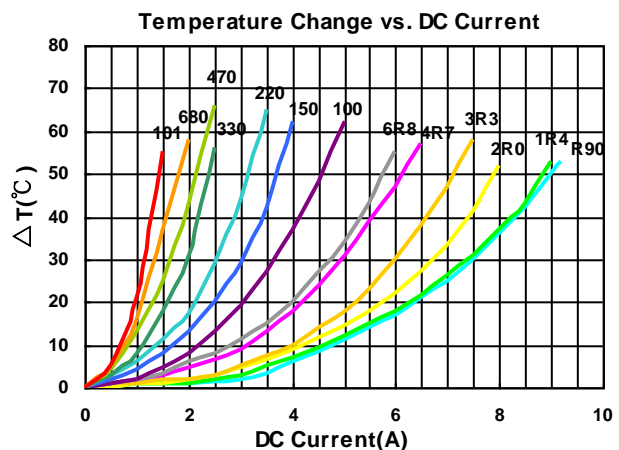
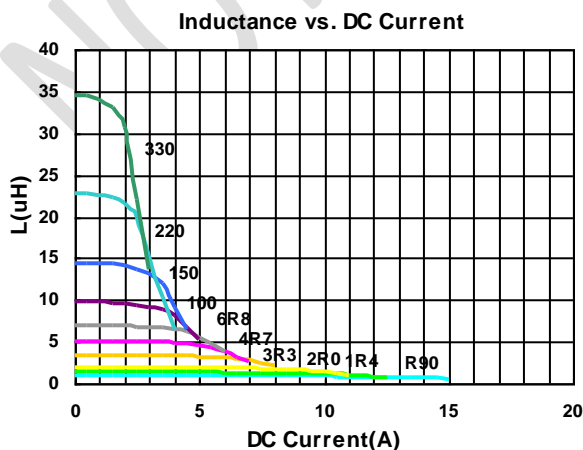

Electrical Characteristics

| Part Number | Inductance (uH) | Tolerance (±%) | Test Frequency (kHz) | RDC (mΩ) Max | Isat (A) Typ. (Max) | Irms (A) Typ. (Max) | Marking |
|-------------------|-----------------|----------------|----------------------|--------------|---------------------|---------------------|---------|
| LVS808040L-1R0□-N | 1.0 | 30 | 100 | 10 | 9.5(8.55) | 8.5(7.65) | 1R0 |
| LVS808040L-2R2□-N | 2.2 | 20,30 | 100 | 12 | 7.2(6.48) | 7.3(6.57) | 2R2 |
| LVS808040L-3R3□-N | 3.3 | 20,30 | 100 | 19 | 5.6(5.04) | 6.0(5.40) | 3R3 |
| LVS808040L-4R7□-N | 4.7 | 20,30 | 100 | 22 | 4.4(3.96) | 5.0(4.50) | 4R7 |
| LVS808040L-8R2□-N | 8.2 | 20,30 | 100 | 37 | 3.6(3.24) | 3.8(3.42) | 8R2 |
| LVS808040L-100□-N | 10 | 20,30 | 100 | 42 | 3.1(2.79) | 3.5(3.15) | 100 |
| LVS808040L-150□-N | 15 | 20,30 | 100 | 58 | 2.5(2.25) | 3.0(2.70) | 150 |
| LVS808040L-220□-N | 22 | 20,30 | 100 | 85 | 2.0(1.80) | 2.5(2.25) | 220 |

Note: When ordering, please specify tolerance code. Tolerance: M=±20% , T =±30%

- Operating temperature range - 55°C ~ 125°C(Including self - temperature rise)
- Isat for Inductance drop 30% from its value without current
- I rms for a 40°C temperature rise from 25°C ambient with current
- Measure Equipment :
 L : Agilent HP4284A+Agilent HP42841A, 100kHz 1V
 RDC : DIGITAL MILLINHM METER CHROMA 16502, or equivalent
 Isat & I rms : Agilent HP4284A

Test Instruments : HP4284A Material/Impedance Analyzer

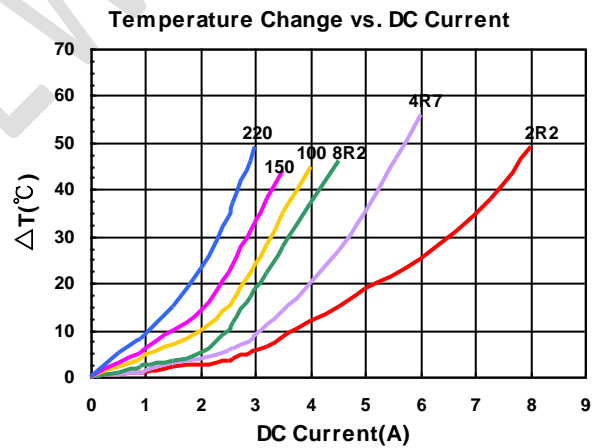
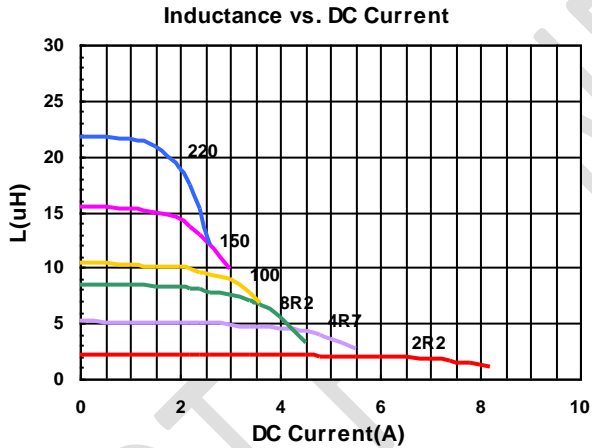

Sealed Power Inductors - LVS Series

Packaging Specifications

Tape Dimensions

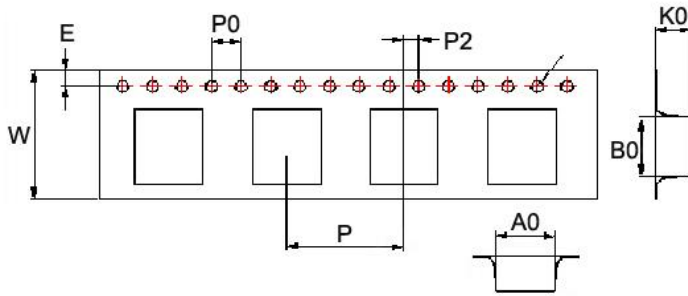

Reel Dimensions

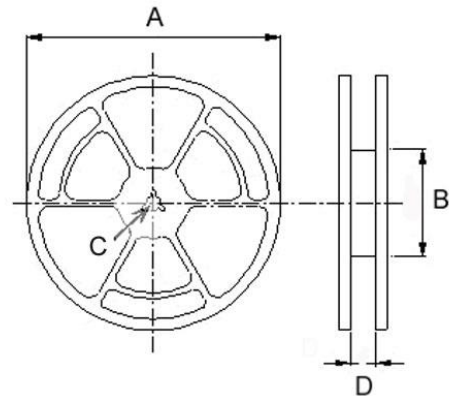

Dimensions in mm

| TYPE | Tape Dimensions | | | | | | | | | | Reel Dimensions | | | | Quantity PCS / Reel |
|-----------|-----------------|------|------|------|------|-----|----|-----|----|----|-----------------|-----|----|------|------------------------|
| | A0 | B0 | K0 | D | E | F | W | P | P0 | P2 | A | B | C | D | |
| LVS404012 | 4.25 | 4.25 | 1.30 | 1.55 | 1.75 | 5.5 | 12 | 8.1 | 4 | 2 | 180 | 60 | 13 | 13.2 | 1000 |
| LVS404018 | 4.25 | 4.25 | 2.10 | 1.55 | 1.75 | 5.5 | 12 | 8.1 | 4 | 2 | 180 | 60 | 13 | 13.2 | 800 |
| LVS404026 | 4.25 | 4.25 | 3.00 | 1.55 | 1.75 | 5.5 | 12 | 8.1 | 4 | 2 | 180 | 60 | 13 | 13.2 | 500 |
| LVS505020 | 5.25 | 5.25 | 2.20 | 1.55 | 1.75 | 5.5 | 12 | 8.1 | 4 | 2 | 330 | 100 | 13 | 13.4 | 2000 |
| LVS505040 | 5.20 | 5.20 | 4.20 | 1.55 | 1.75 | 5.5 | 12 | 8.1 | 4 | 2 | 330 | 100 | 13 | 13.4 | 1500 |
| LVS606020 | 6.25 | 6.25 | 2.20 | 1.55 | 1.75 | 7.5 | 16 | 12 | 4 | 2 | 330 | 100 | 13 | 16.0 | 2000 |
| LVS606028 | 6.25 | 6.25 | 3.00 | 1.55 | 1.75 | 7.5 | 16 | 12 | 4 | 2 | 330 | 100 | 13 | 16.0 | 1500 |
| LVS606045 | 6.25 | 6.25 | 4.65 | 1.55 | 1.75 | 7.5 | 16 | 12 | 4 | 2 | 330 | 100 | 13 | 16.0 | 1000 |
| LVS808040 | 8.25 | 8.25 | 4.15 | 1.55 | 1.75 | 7.5 | 16 | 12 | 4 | 2 | 330 | 100 | 13 | 16.0 | 1000 |

X-ON Electronics

Largest Supplier of Electrical and Electronic Components

Click to view similar products for [Fixed Inductors](#) category:

Click to view products by [Chilisin](#) manufacturer:

Other Similar products are found below :

[CR32NP-100KC](#) [CR32NP-151KC](#) [CR32NP-180KC](#) [CR32NP-181KC](#) [CR32NP-1R5MC](#) [CR32NP-390KC](#) [CR32NP-3R9MC](#) [CR32NP-680KC](#) [CR32NP-820KC](#) [CR32NP-8R2MC](#) [CR43NP-390KC](#) [CR43NP-560KC](#) [CR43NP-680KC](#) [CR54NP-181KC](#) [CR54NP-470LC](#) [CR54NP-820KC](#) [CR54NP-8R5MC](#) [70F224AI](#) [MGDQ4-00004-P](#) [MHL1ECTTP18NJ](#) [MHQ1005P10NJ](#) [MHQ1005P1N0S](#) [MHQ1005P2N4S](#) [MHQ1005P3N6S](#) [MHQ1005P5N1S](#) [MHQ1005P8N2J](#) [PE-51506NL](#) [PE-53601NL](#) [PE-53602NL](#) [PE-53630NL](#) [PE-53824SNLT](#) [PE-92100NL](#) [PG0434.801NLT](#) [PG0936.113NLT](#) [9220-20](#) [9310-16](#) [PM06-2N7](#) [PM06-39NJ](#) [A01TK](#) [1206CS-471XJ](#) [HC2LP-R47-R](#) [HC2-R47-R](#) [HC3-2R2-R](#) [HCF1305-3R3-R](#) [1206CS-151XG](#) [RCH664NP-140L](#) [RCH664NP-4R7M](#) [RCH8011NP-221L](#) [RCP1317NP-332L](#) [RCP1317NP-391L](#)