



ISO9001 ISO14001 IATF16949 CHILISIN ELECTRONICS CORP.

RoHS & Halogen Free & REACH Compliance.

## SPECIFICATION FOR APPROVAL

Customer : 各廠家

Customer P/N: \_\_\_\_\_

Drawing No : \_\_\_\_\_

Quantity : 0 Pcs. Date : 2018/11/13

Chilisin P/N : MHCH252010A-R33M-Q8

SPECIFICATION ACCEPTED BY:	
COMPONENT ENGINEER	
ELECTRICAL ENGINEER	
MECHANICAL ENGINEER	
APPROVED	
REJECTED	

**奇力新電子股份有限公司**  
Chilisin Electronics Corp  
No. 29, Alley 301, Tehhsin Rd.,  
Hukou, Hsinchu 303, Taiwan  
TEL : +886-3- 599-2646  
FAX : +886-3- 599-9176  
E-mail : sales@chilisin.com  
http : //www.chilisin.com

**東莞奇力新電子(東莞廠)有限公司**  
Chilisin Electronics (Dongguan) Co., Ltd.  
No. 78, Puxing Rd., Yuliangwei Administration Area,  
Qingxi Town, Dongguan City, Guangdong, China  
TEL : +86-769-8773-0251~3  
FAX : +86-769-8773-0232  
E-mail : cect@chilisin.com

**奇力新電子(越南廠)有限公司**  
Chilisin Electronics (Vietnam) Limited  
No 143 - 145, Road No 10, VSIP Hai Phong,  
Lap Le Commune, Thuy Nguyen Dist,  
Haiphong City, Vietnam  
Tel : 84-316 255 688 Fax : 84-316 255  
689  
E-mail : sales@chilisin.com

**奇力新電子(湖南廠)有限公司**  
HuNan Chilisin Electronics Technology Co., Ltd  
No. 8, Shaziao Liangshuijing Town, Yuanling  
County, Huaihua City, Hunan Province 419601,  
China  
Tel : 86-745-867-5882  
E-mail : cect@chilisin.com

Drawn by  
陳瑞揚 ryan.chen

Checked by  
溫美玲 ling

Approved by  
陳瑞揚 ryan.chen

# MHCH252010A Series Specification

**1 Scope:** This specification applies to Molding power inductors

**2 Part Numbering:**

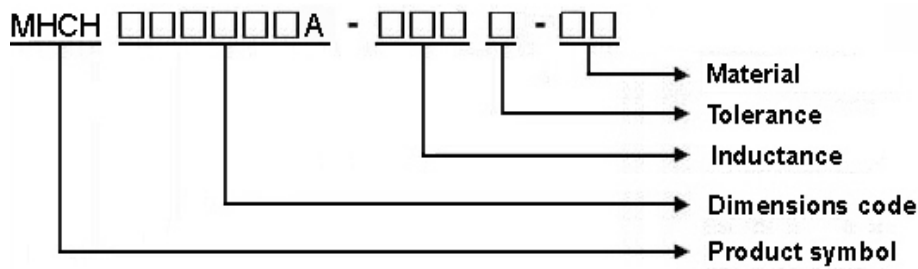

**3 Rating:**

Operating Temperature:  $-40^{\circ}\text{C} \sim 125^{\circ}\text{C}$  (Including self - temperature rise)

Storage Temperature:  $-40^{\circ}\text{C} \sim 125^{\circ}\text{C}$  (after PCB)

$-5^{\circ}\text{C} \sim 35^{\circ}\text{C}$ , Humidity 45%~85% (before PCB)

**4 Marking:**

No Marking

**5 Standard Testing Condition**

	Unless otherwise specified	In case of doubt
Temperature	Ordinary Temperature(15 to 35°C)	20 to 30°C
Humidity	Ordinary Humidity(25 to 85% RH)	50 to 80 %RH

## MHCH252010A Series Specification

### 6 Configuration and Dimensions:

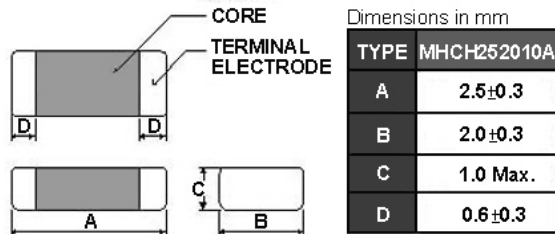

### 7 Electrical Characteristics:

Part No.	Inductance (uH)	Tolerance (±%)	Test Freq.	I <sub>rms</sub> (A) Max.(Typ)	I <sub>sat</sub> (A) Max.(Typ)	RDC(mΩ) Max.(Typ)
MHCH252010A-R24M-Q8	0.24	20	2MHz,0.2V	5.5(6.5)	8.0(9.5)	18(13)
MHCH252010A-R33M-Q8	0.33	20	2MHz,0.2V	4.8(5.5)	6.5(8.0)	24(18)
MHCH252010A-R47M-Q8	0.47	20	2MHz,0.2V	3.9(4.5)	5.0(6.2)	35(27)
MHCH252010A-R68M-Q8	0.68	20	2MHz,0.2V	3.7(4.2)	4.5(5.6)	40(32)
MHCH252010A-1R0M-Q8	1	20	2MHz,0.2V	3.0(3.5)	3.7(4.6)	53(45)
MHCH252010A-1R5M-Q8	1.5	20	2MHz,0.2V	2.4(2.8)	3.1(3.8)	75(68)
MHCH252010A-2R2M-Q8	2.2	20	2MHz,0.2V	2.2(2.5)	2.5(3.0)	105(87)

#### NOTE:

1. Operating temperature range - 40°C ~ 125°C (Including self - temperature rise)
2. I<sub>sat</sub> for Inductance drop 30% from its value without current.
3. I<sub>rms</sub> for a 40°C temperature rise from 25°C ambient.
4. All test data is referenced to 25°C ambient
5. Absolute maximum voltage 20VDC

# MHCH252010A Series Specification

## 8 MHCH252010A Series

### 8.1 Construction:

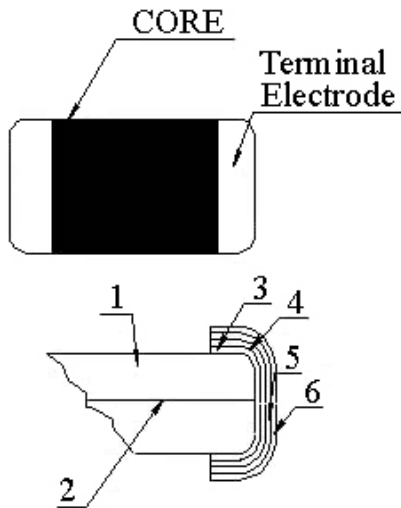

### 8.2 Material List:

No	Part	Material
1	Core	Metal Powder
2	Wire	Copper wire
3	Sputter/Plating	Cu
4	Silver Electrode	Ag
5	Plating	Ni
6	Plating	Sn

# MHCH252010A Series Specification

## 9 Packaging:

### 9.1 Packaging -Cover Tape

The force for tearing off cover tape is 10 to 100 grams in the arrow direction.



### 9.2 Packaging Quantity

TYPE	PCS/REEL
MHCH252010A	3000

### 9.3 Reel Dimensions

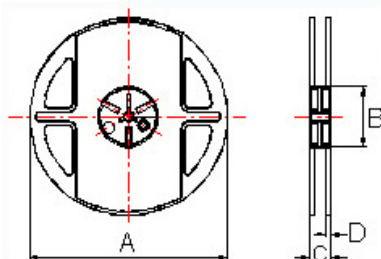

Dimensions in mm

TYPE	A	B	C	D
MHCH252010A	178	60	12	1.5

# MHCH252010A Series Specification

## 9 Packaging:

### 9.4 Tape Dimensions in mm

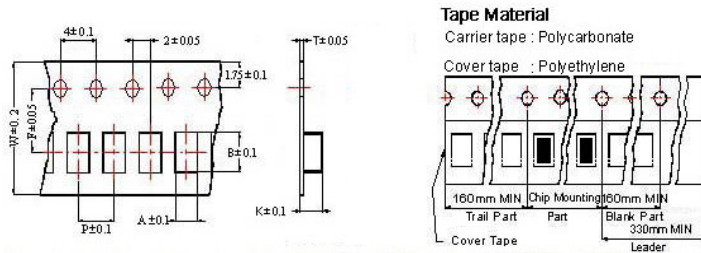

TYPE	A	B	T	W	P	F	K
MHCH252010A	2.25	2.8	0.22	8	4	3.5	1.15

## 10 Recommended Land Pattern:

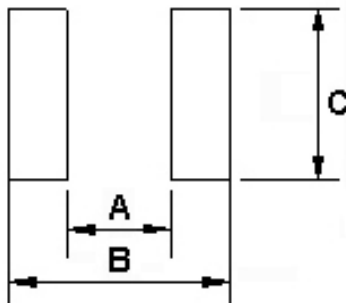

Dimensions in mm

TYPE	A	B	C
MHCH252010A	1.2	2.8	2.3

## 11 Note:

1. Please make sure that your product has been evaluated and confirmed against your specifications when our product is mounted to your product.
2. Do not knock nor drop.
3. All the items and parameters in this product specification have been prescribed on the premise that our product is used for the purpose, under the condition and in the environment agreed upon between you and us. You are requested not to use our product deviating from such agreement.
4. Please keep the distance between transformer/coil and other components (refer to the standard IEC 950)
5. After manufacturing process, there might be slight irregular shape on the edge of the products, and it's a normal phenomenon that can be neglected
6. The moisture sensitivity level (MSL) of products is classified as level 1.



ISO9001 ISO14001 IATF16949 CHILISIN ELECTRONICS CORP.

# MHCH252010A Series Specification

12 Graph: MHCH252010A-R33M-Q8

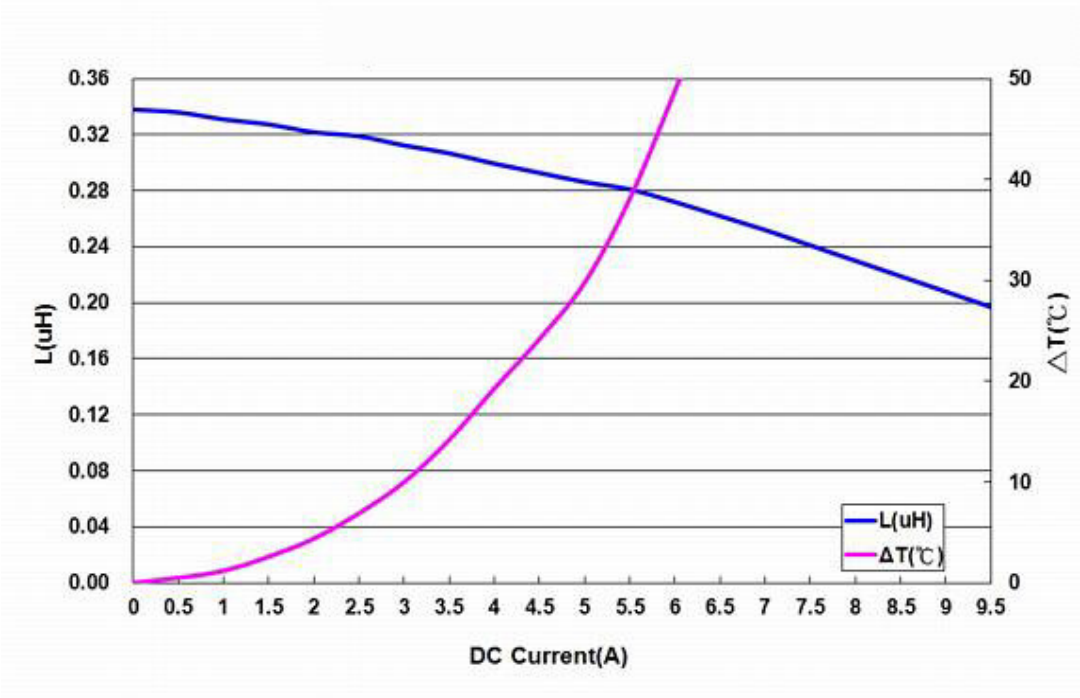

## X-ON Electronics

Largest Supplier of Electrical and Electronic Components

*Click to view similar products for [Fixed Inductors](#) category:*

*Click to view products by [Chilisin](#) manufacturer:*

Other Similar products are found below :

[CR43NP-680KC](#) [CR54NP-470LC](#) [CR54NP-820KC](#) [CR54NP-8R5MC](#) [70F224AI](#) [MGDQ4-00004-P](#) [MHL1ECTTP18NJ](#) [MHQ1005P10NJ](#)  
[MHQ1005P1N0S](#) [MHQ1005P2N4S](#) [MHQ1005P3N6S](#) [MHQ1005P5N1S](#) [MHQ1005P8N2J](#) [PE-51506NL](#) [PE-53601NL](#) [PE-53602NL](#) [PE-53630NL](#) [PE-53824SNLT](#) [PE-92100NL](#) [PG0434.801NLT](#) [PG0936.113NLT](#) [9220-20](#) [9310-16](#) [PM06-2N7](#) [PM06-39NJ](#) [A01TK](#) [1206CS-471XJ](#) [HC2LP-R47-R](#) [HC2-R47-R](#) [HC3-2R2-R](#) [HC3-R50-R](#) [HC8-1R2-R](#) [HCF1305-3R3-R](#) [1206CS-151XG](#) [RCH664NP-140L](#) [RCH664NP-4R7M](#) [RCH8011NP-221L](#) [RCP1317NP-332L](#) [RCP1317NP-391L](#) [RCR1010NP-470M](#) [RCR110DNP-331L](#) [DH2280-4R7M](#) [DS1608C-106](#)  
[ASPI-4020HI-R10M-T](#) [B10TJ](#) [B82498B3680J000](#) [ELJ-RE27NJF2](#) [1812CS-153XJ](#) [1812CS-183XJ](#) [1812CS-223XJ](#)