

## MHCC、MHCI Series



MHCC series is designed for low profile type with low RDC and ultra large current. Its molded magnetic shielded type is suitable for high-density mounting and ultra low buzz noise. Soldering conditions can be easily confirmed when mounting onto the board. This series also provides customers with embossed carrier type packaging for automatic mounting machine.

### Features

- RoHS, Halogen Free and REACH Compliance
- High rated current
- Ultra low buzz noise

### Applications

- Laptops and PCs
- Switches and servers
- Base stations
- DC/DC converters

### Product Identification

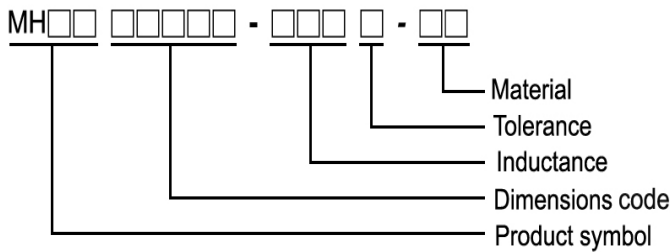

### Shape and Dimensions

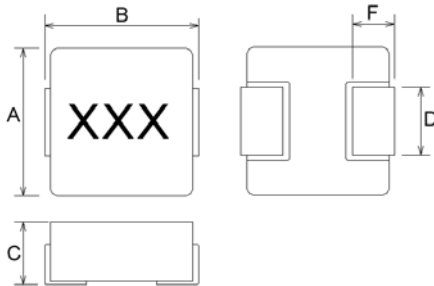

### Recommended Pattern

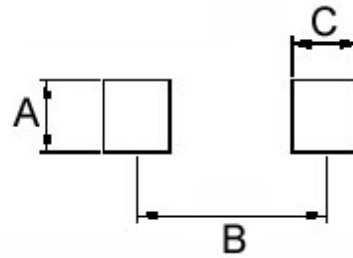

Dimensions in mm

| TYPE  | A        | B Max   | C Max   | D       | F       |
|-------|----------|---------|---------|---------|---------|
| 04012 | 4.1±0.2  | 4.6±0.2 | 1.2     | 1.5±0.3 | 1.0±0.5 |
| 04015 | 4.1±0.2  | 4.6±0.2 | 1.5     | 1.5±0.3 | 1.0±0.5 |
| 04020 | 4.1±0.2  | 4.6±0.2 | 2.0     | 1.5±0.3 | 1.0±0.5 |
| 05012 | 5.4±0.35 | 5.7±0.2 | 1.2     | 2.0±0.3 | 1.5±0.3 |
| 05015 | 5.4±0.35 | 5.7±0.2 | 1.5     | 2.0±0.3 | 1.5±0.3 |
| 05018 | 5.4±0.35 | 5.7±0.2 | 1.8     | 2.0±0.3 | 1.5±0.3 |
| 05020 | 5.4±0.35 | 5.7±0.2 | 1.8±0.2 | 2.0±0.3 | 1.5±0.3 |
| 05030 | 5.4±0.35 | 5.7±0.2 | 3.0     | 2.0±0.3 | 1.5±0.3 |
| 06012 | 6.6±0.2  | 7.3     | 1.2     | 2.9     | 1.6±0.5 |
| 06015 | 6.6±0.2  | 7.3     | 1.3±0.2 | 2.9     | 1.6±0.5 |
| 06018 | 6.6±0.2  | 7.3     | 1.6±0.2 | 2.9     | 1.6±0.5 |
| 06024 | 6.6±0.2  | 7.3     | 2.4     | 2.9     | 1.6±0.5 |
| 06030 | 6.6±0.2  | 7.3     | 3.0     | 2.9     | 1.6±0.5 |
| 06050 | 6.6±0.2  | 7.3     | 5.0     | 2.9     | 1.6±0.5 |
| 10030 | 10.1±0.3 | 11.6    | 3.0     | 3.0     | 2.5±0.5 |
| 10040 | 10.1±0.3 | 11.6    | 4.0     | 3.0     | 2.5±0.5 |
| 12050 | 12.6±0.2 | 13.8    | 5.0     | 3.7     | 2.7±0.7 |
| 12060 | 12.6±0.2 | 13.8    | 6.0     | 3.7     | 2.7±0.7 |

Dimensions in mm

| TYPE  | A   | B    | C    |
|-------|-----|------|------|
| 04012 | 2.5 | 3.7  | 1.5  |
| 04015 | 2.5 | 3.7  | 1.5  |
| 04020 | 2.5 | 3.7  | 1.5  |
| 05012 | 2.5 | 4.1  | 1.9  |
| 05015 | 2.5 | 4.1  | 1.9  |
| 05018 | 2.5 | 4.1  | 1.9  |
| 05020 | 2.5 | 4.1  | 1.9  |
| 05030 | 2.5 | 4.1  | 1.9  |
| 06012 | 3.5 | 6.05 | 2.35 |
| 06015 | 3.5 | 6.05 | 2.35 |
| 06018 | 3.5 | 6.05 | 2.35 |
| 06024 | 3.5 | 6.05 | 2.35 |
| 06030 | 3.5 | 6.05 | 2.35 |
| 06050 | 3.5 | 6.05 | 2.35 |
| 10030 | 4.0 | 9.5  | 3.5  |
| 10040 | 4.0 | 9.5  | 3.5  |
| 12050 | 5.0 | 10.5 | 4.0  |
| 12060 | 5.5 | 10.5 | 4.0  |

## Electrical Characteristics

| Part Number       | Inductance (uH) | Tolerance (±%) | Test Frequency (kHz) | RDC (mΩ) Max | Isat (A)Typ. | Irms (A)Typ. |
|-------------------|-----------------|----------------|----------------------|--------------|--------------|--------------|
| MHCI04012-R22M-R8 | 0.22            | 20             | 100                  | 12           | 11.5         | 8.5          |
| MHCI04012-R33M-R8 | 0.33            | 20             | 100                  | 19           | 8.5          | 6.5          |
| MHCI04012-R47M-R8 | 0.47            | 20             | 100                  | 25           | 7.0          | 5.0          |
| MHCI04012-R68M-R8 | 0.68            | 20             | 100                  | 36           | 6.0          | 4.5          |
| MHCI04012-1R0M-R8 | 1.0             | 20             | 100                  | 47           | 5.2          | 4.2          |
| MHCI04012-1R5M-R8 | 1.5             | 20             | 100                  | 75           | 4.0          | 3.25         |
| MHCI04012-2R2M-R8 | 2.2             | 20             | 100                  | 83.5         | 3.5          | 2.75         |
| MHCI04012-3R3M-R8 | 3.3             | 20             | 100                  | 165          | 3.0          | 2.0          |
| MHCI04012-4R7M-R8 | 4.7             | 20             | 100                  | 195          | 2.8          | 1.8          |

**Note: When ordering, please specify tolerance code. Tolerance: M=±20%**

- Operating temperature range - 55°C ~ 125°C(Including self - temperature rise)
- Isat for Inductance drop 30% from its value without current
- I rms for a 40°C temperature rise from 25°C ambient with current
- Absolute maximum voltage 30VDC
- Measure Equipment :
  - L : WK 3260B or WK 6500P, 100kHz 0.5V
  - RDC : CHEN HWA 502 or CHEN HWA 46502B

**Test Instruments :** WK3260B Impedance / Material Analyzer

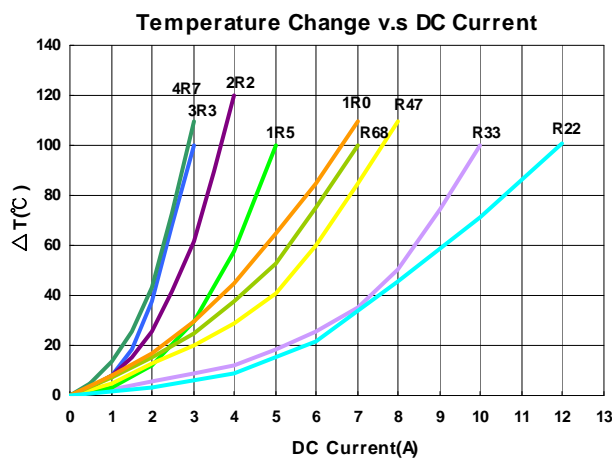
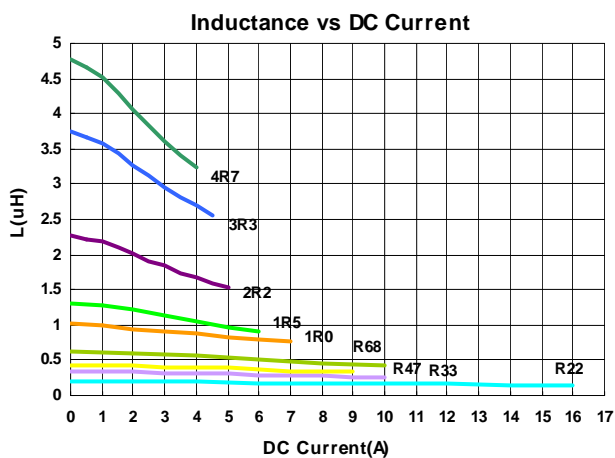

Please be sure to request approval specifications that provide further details of the products. Kindly note that the content of these specifications are subject to change or may be discontinued without advance notice. Please contact our sales department before ordering.

## Electrical Characteristics

| Part Number       | Inductance (uH) | Tolerance (±%) | Test Frequency (kHz) | RDC (mΩ) Max | Isat (A)Typ. | Irms (A)Typ. |
|-------------------|-----------------|----------------|----------------------|--------------|--------------|--------------|
| MHCI04015-1R0M-R8 | 1.0             | 20             | 100                  | 42           | 7            | 4            |
| MHCI04015-1R5M-R8 | 1.5             | 20             | 100                  | 50           | 6            | 3.5          |
| MHCI04015-2R2M-R8 | 2.2             | 20             | 100                  | 79           | 5            | 3            |
| MHCI04015-3R3M-R8 | 3.3             | 20             | 100                  | 132          | 4.5          | 2.3          |
| MHCI04015-4R7M-R8 | 4.7             | 20             | 100                  | 146          | 4            | 2            |

**Note: When ordering, please specify tolerance code. Tolerance: M=±20%**

- Operating temperature range - 55°C ~ 125°C(Including self - temperature rise)
- Isat for Inductance drop 30% from its value without current
- I rms for a 40°C temperature rise from 25°C ambient with current
- Absolute maximum voltage 30VDC
- Measure Equipment :  
 L : WK 3260B or WK 6500P, 100kHz 0.5V  
 RDC : CHEN HWA 502 or CHEN HWA 46502B

**Test Instruments : WK3260B Impedance / Material Analyzer**

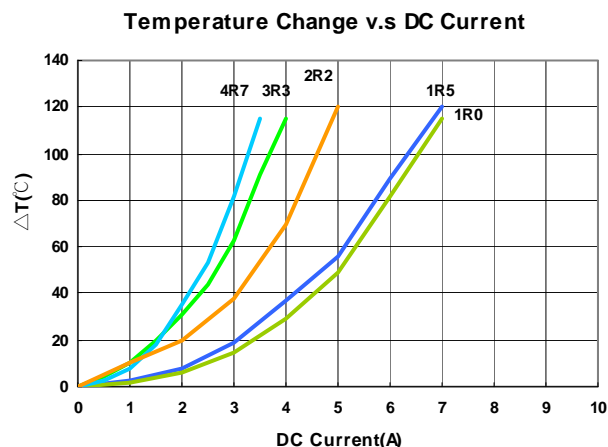
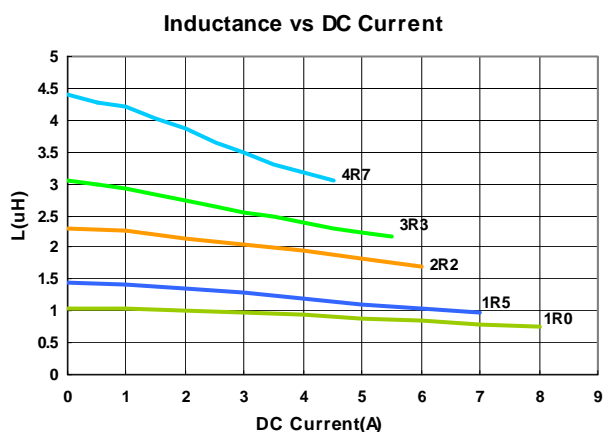

# Molding Power Choke – MHCC/MHCI Series

## Electrical Characteristics

| Part Number       | Inductance (uH) | Tolerance (±%) | Test Frequency (kHz) | RDC (mΩ) Max | Isat (A)Typ. | Irms (A)Typ. |
|-------------------|-----------------|----------------|----------------------|--------------|--------------|--------------|
| MHCI04020-R10M-R8 | 0.10            | 20             | 100                  | 4            | 25           | 12.0         |
| MHCI04020-R22M-R8 | 0.22            | 20             | 100                  | 6.6          | 12.5         | 9.0          |
| MHCI04020-R47M-R8 | 0.47            | 20             | 100                  | 14           | 9.5          | 7.0          |
| MHCI04020-R56M-R8 | 0.56            | 20             | 100                  | 16           | 10.0         | 6.5          |
| MHCI04020-R68M-R8 | 0.68            | 20             | 100                  | 21           | 8.0          | 5.2          |
| MHCI04020-1R0M-R8 | 1.0             | 20             | 100                  | 27           | 7.0          | 4.5          |
| MHCI04020-1R5M-R8 | 1.5             | 20             | 100                  | 46           | 6.0          | 4.0          |
| MHCI04020-2R2M-R8 | 2.2             | 20             | 100                  | 58           | 5.0          | 3.0          |
| MHCI04020-3R3M-R8 | 3.3             | 20             | 100                  | 87           | 4.0          | 2.5          |
| MHCI04020-4R7M-R8 | 4.7             | 20             | 100                  | 126          | 3.0          | 2.2          |
| MHCI04020-6R8M-R8 | 6.8             | 20             | 100                  | 135          | 2.5          | 2.0          |
| MHCI04020-8R2M-R8 | 8.2             | 20             | 100                  | 216          | 2.5          | 2.0          |
| MHCI04020-100M-R8 | 10              | 20             | 100                  | 258          | 2.0          | 1.6          |

**Note: When ordering, please specify tolerance code. Tolerance: M=±20%**

- Operating temperature range - 55°C ~ 125°C(Including self - temperature rise)
- Isat for Inductance drop 30% from its value without current
- Irms for a 40°C temperature rise from 25°C ambient with current
- Absolute maximum voltage 30VDC
- Measure Equipment :  
L : WK 3260B or WK 6500P, 100KHz 0.5V  
RDC : CHEN HWA 502 or CHEN HWA 46502B

**Test Instruments : WK3260B Impedance / Material Analyzer**

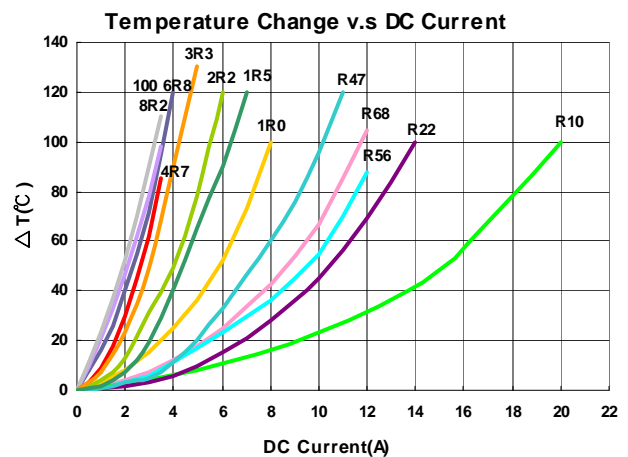
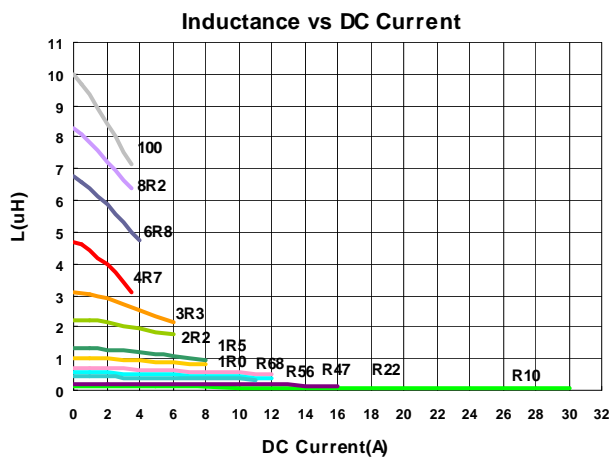

Please be sure to request approval specifications that provide further details of the products. Kindly note that the content of these specifications are subject to change or may be discontinued without advance notice. Please contact our sales department before ordering.

## Electrical Characteristics

| Part Number        | Inductance (uH) | Tolerance (±%) | Test Frequency (kHz) | RDC (mΩ) Max | Isat (A)Typ. | Irms (A)Typ. |
|--------------------|-----------------|----------------|----------------------|--------------|--------------|--------------|
| MHCI05012-1R0M-R8A | 1.0             | 20             | 100                  | 30           | 6.0          | 5.0          |
| MHCI05012-2R2M-R8A | 2.2             | 20             | 100                  | 76           | 4.0          | 3.5          |
| MHCI05012-6R8M-R8A | 6.8             | 20             | 100                  | 250          | 2.3          | 2.0          |

**Note: When ordering, please specify tolerance code. Tolerance: M=±20%**

- Operating temperature range - 55°C ~ 125°C(Including self - temperature rise)
- Isat for Inductance drop 30% from its value without current
- Irms for a 40°C temperature rise from 25°C ambient with current
- Absolute maximum voltage 30VDC
- Measure Equipment :  
 L : WK 3260B or WK 6500P, 100kHz 0.5V  
 RDC : CHEN HWA 502 or CHEN HWA 46502B

**Test Instruments :** WK3260B Impedance / Material Analyzer

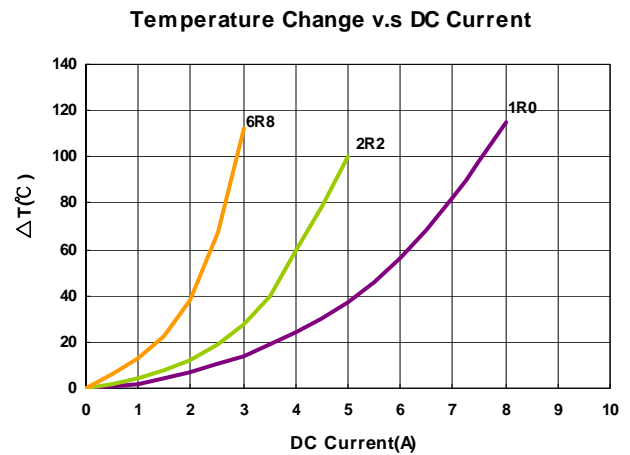
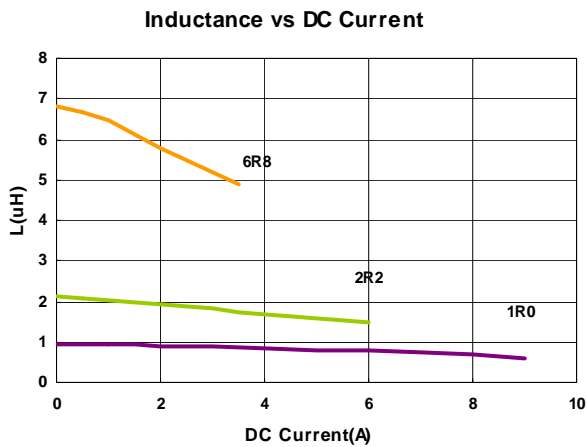

## Electrical Characteristics

| Part Number       | Inductance (uH) | Tolerance (±%) | Test Frequency (kHz) | RDC (mΩ) Max | Isat (A)Typ. | Irms (A)Typ. |
|-------------------|-----------------|----------------|----------------------|--------------|--------------|--------------|
| MHCI05015-R47M-R8 | 0.47            | 20             | 100                  | 16           | 12           | 8.0          |
| MHCI05015-R68M-R8 | 0.68            | 20             | 100                  | 23           | 10           | 6.0          |
| MHCI05015-1R0M-R8 | 1.0             | 20             | 100                  | 33           | 8.0          | 5.0          |
| MHCI05015-1R5M-R8 | 1.5             | 20             | 100                  | 50           | 6.0          | 4.0          |
| MHCI05015-2R2M-R8 | 2.2             | 20             | 100                  | 68           | 6.0          | 3.3          |
| MHCI05015-3R3M-R8 | 3.3             | 20             | 100                  | 84           | 5.0          | 3.0          |
| MHCI05015-4R7M-R8 | 4.7             | 20             | 100                  | 135          | 4.0          | 2.5          |
| MHCI05015-5R6M-R8 | 5.6             | 20             | 100                  | 175          | 3.5          | 2.2          |
| MHCI05015-6R8M-R8 | 6.8             | 20             | 100                  | 192          | 3.0          | 2.0          |
| MHCI05015-100M-R8 | 10              | 20             | 100                  | 195          | 2.0          | 1.5          |

**Note: When ordering, please specify tolerance code. Tolerance: M=±20%**

- Operating temperature range - 55°C ~ 125°C(Including self - temperature rise)
- Isat for Inductance drop 30% from its value without current
- I rms for a 40°C temperature rise from 25°C ambient with current
- Absolute maximum voltage 30VDC
- Measure Equipment :  
L : WK 3260B or WK 6500P, 100kHz 0.5V  
RDC : CHEN HWA 502 or CHEN HWA 46502B

**Test Instruments : WK3260B Impedance / Material Analyzer**

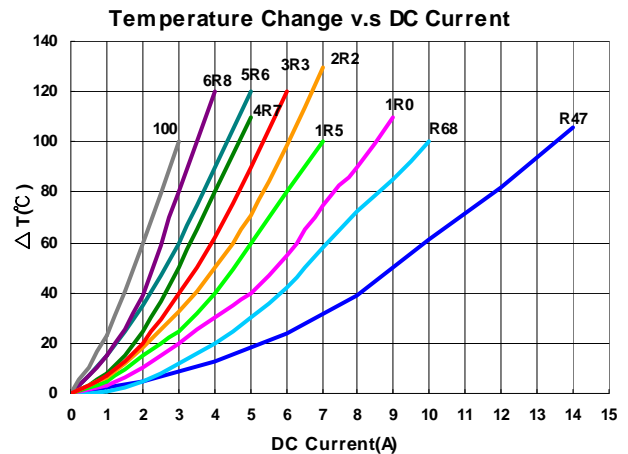
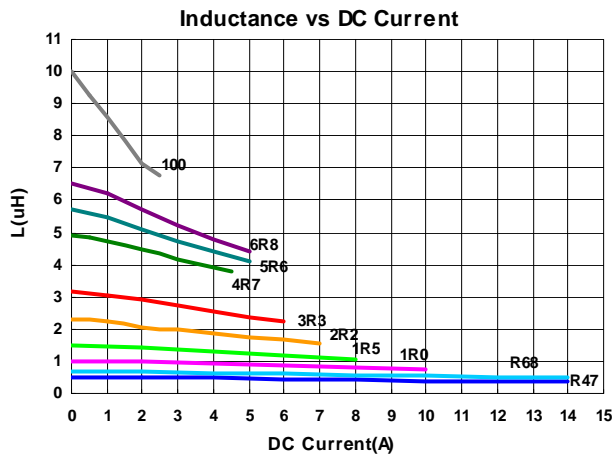

Please be sure to request approval specifications that provide further details of the products. Kindly note that the content of these specifications are subject to change or may be discontinued without advance notice. Please contact our sales department before ordering.

## Electrical Characteristics

| Part Number        | Inductance (uH) | Tolerance (±%) | Test Frequency (kHz) | RDC (mΩ) Max | Isat (A)Typ. | Irms (A)Typ. |
|--------------------|-----------------|----------------|----------------------|--------------|--------------|--------------|
| MHCI05015-1R0M-R8A | 1.0             | 20             | 100                  | 23           | 9            | 6.5          |
| MHCI05015-2R2M-R8A | 2.2             | 20             | 100                  | 64           | 6            | 3.3          |
| MHCI05015-4R7M-R8A | 4.7             | 20             | 100                  | 106          | 4            | 3.0          |
| MHCI05015-100M-R8A | 10              | 20             | 100                  | 170          | 3            | 2.0          |

**Note: When ordering, please specify tolerance code. Tolerance: M=±20%**

- Operating temperature range - 55°C ~ 125°C(Including self - temperature rise)
- Isat for Inductance drop 30% from its value without current
- I rms for a 40°C temperature rise from 25°C ambient with current
- Absolute maximum voltage 30VDC
- Measure Equipment :  
 L : WK 3260B or WK 6500P, 100kHz 0.5V  
 RDC : CHEN HWA 502 or CHEN HWA 46502B

**Test Instruments :** WK3260B Impedance / Material Analyzer

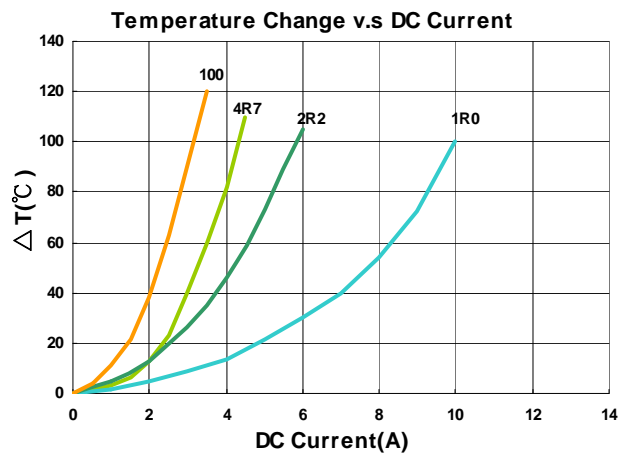
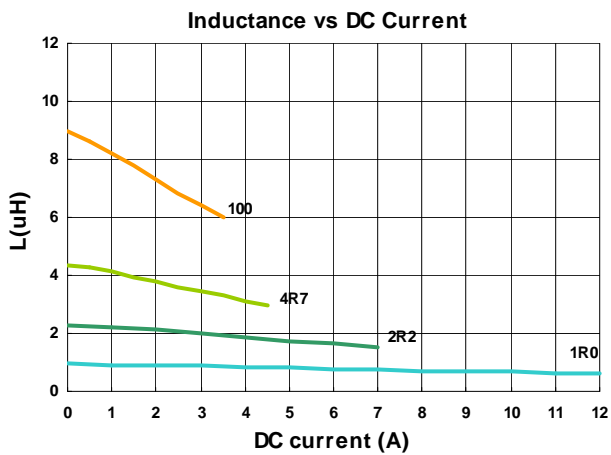

## Electrical Characteristics

| Part Number        | Inductance (uH) | Tolerance (±%) | Test Frequency (kHz) | RDC (mΩ) Max | Isat (A)Typ. | Irms (A)Typ. |
|--------------------|-----------------|----------------|----------------------|--------------|--------------|--------------|
| MHCI05018-R47M-R8A | 0.47            | 20             | 100                  | 9.0          | 15.5         | 10.5         |
| MHCI05018-1R0M-R8A | 1.0             | 20             | 100                  | 17           | 9.0          | 8.0          |
| MHCI05018-2R2M-R8A | 2.2             | 20             | 100                  | 35           | 6.5          | 5.0          |
| MHCI05018-3R3M-R8A | 3.3             | 20             | 100                  | 58           | 5.0          | 4.5          |
| MHCI05018-4R7M-R8A | 4.7             | 20             | 100                  | 85           | 4.0          | 3.5          |
| MHCI05018-6R8M-R8A | 6.8             | 20             | 100                  | 120          | 3.4          | 2.8          |
| MHCI05018-100M-R8A | 10              | 20             | 100                  | 155          | 3.0          | 2.5          |

**Note: When ordering, please specify tolerance code. Tolerance: M=±20%**

- Operating temperature range - 55°C ~ 125°C(Including self - temperature rise)
- Isat for Inductance drop 30% from its value without current
- I rms for a 40°C temperature rise from 25°C ambient with current
- Absolute maximum voltage 30VDC
- Measure Equipment :
  - L : WK 3260B or WK 6500P, 100kHz 0.5V
  - RDC : CHEN HWA 502 or CHEN HWA 46502B

**Test Instruments :** WK3260B Impedance / Material Analyzer

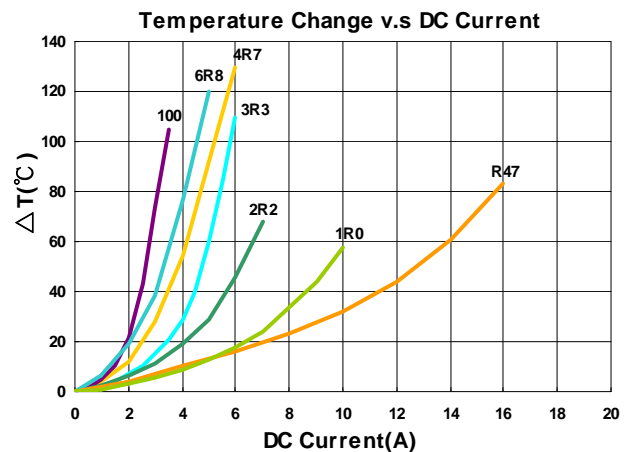
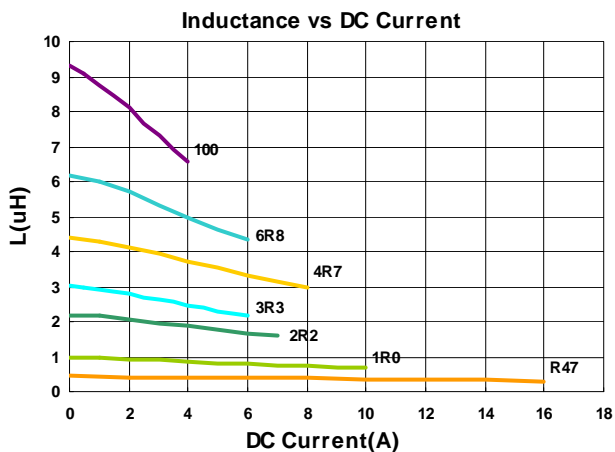



# Molding Power Choke – MHCC/MHCI Series

## Electrical Characteristics

| Part Number       | Inductance (uH) | Tolerance (±%) | Test Frequency (kHz) | RDC (mΩ) Max | Isat (A)Typ. | Irms (A)Typ. |
|-------------------|-----------------|----------------|----------------------|--------------|--------------|--------------|
| MHCI05020-R47M-R8 | 0.47            | 20             | 100                  | 9            | 15.5         | 10.5         |
| MHCI05020-1R0M-R8 | 1.0             | 20             | 100                  | 30           | 7.0          | 6.0          |
| MHCI05020-1R5M-R8 | 1.5             | 20             | 100                  | 35           | 6.5          | 5.5          |
| MHCI05020-2R2M-R8 | 2.2             | 20             | 100                  | 45           | 6.0          | 4.0          |
| MHCI05020-3R3M-R8 | 3.3             | 20             | 100                  | 60           | 5.5          | 3.5          |
| MHCI05020-4R7M-R8 | 4.7             | 20             | 100                  | 90           | 5.0          | 3.0          |
| MHCI05020-5R6M-R8 | 5.6             | 20             | 100                  | 120          | 4.5          | 2.8          |
| MHCI05020-6R8M-R8 | 6.8             | 20             | 100                  | 125          | 4.5          | 2.8          |
| MHCI05020-100M-R8 | 10              | 20             | 100                  | 180          | 4.0          | 2.3          |

**Note: When ordering, please specify tolerance code. Tolerance: M=±20%**

- Operating temperature range - 55°C ~ 125°C(Including self - temperature rise)
- Isat for Inductance drop 30% from its value without current
- I rms for a 40°C temperature rise from 25°C ambient with current
- Absolute maximum voltage 30VDC
- Measure Equipment :  
 L : WK 3260B or WK 6500P, 100kHz 0.5V  
 RDC : CHEN HWA 502 or CHEN HWA 46502B

**Test Instruments :** WK3260B Impedance / Material Analyzer

**Inductance v.s DC Current**

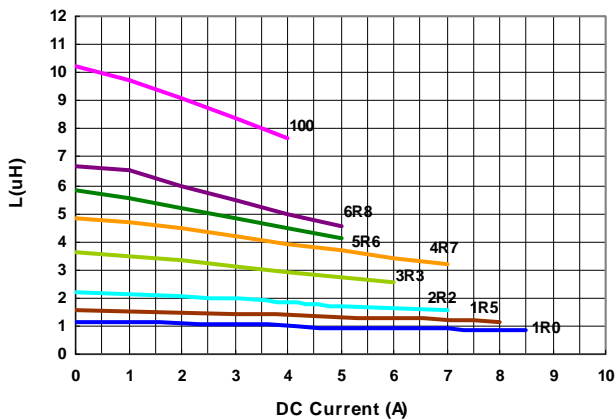

**Temperature Change v.s DC Current**

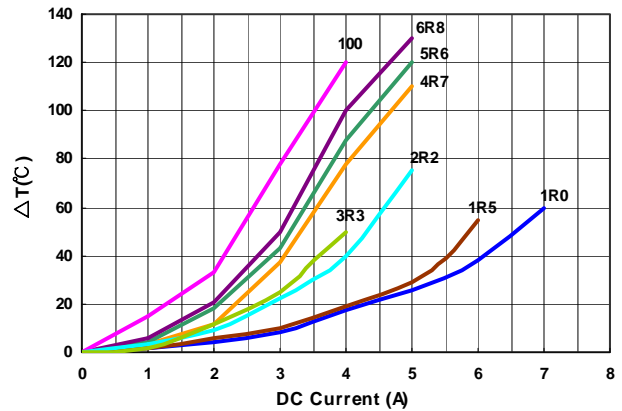

Please be sure to request approval specifications that provide further details of the products. Kindly note that the content of these specifications are subject to change or may be discontinued without advance notice. Please contact our sales department before ordering.

## Electrical Characteristics

| Part Number       | Inductance (uH) | Tolerance (±%) | Test Frequency (kHz) | RDC (mΩ)Max | Isat (A)Typ. | Irms (A)Typ. |
|-------------------|-----------------|----------------|----------------------|-------------|--------------|--------------|
| MHCI05030-R20M-R8 | 0.20            | 20             | 100                  | 3.9         | 14.5         | 17.0         |
| MHCI05030-R47M-R8 | 0.47            | 20             | 100                  | 8           | 14           | 10.0         |
| MHCI05030-R68M-R8 | 0.68            | 20             | 100                  | 12          | 14           | 8.0          |
| MHCI05030-1R0M-R8 | 1.0             | 20             | 100                  | 15          | 11           | 7.0          |
| MHCI05030-1R2M-R8 | 1.2             | 20             | 100                  | 15          | 11           | 6.5          |
| MHCI05030-1R5M-R8 | 1.5             | 20             | 100                  | 25          | 10           | 6.0          |
| MHCI05030-2R2M-R8 | 2.2             | 20             | 100                  | 35          | 8            | 5.0          |
| MHCI05030-3R3M-R8 | 3.3             | 20             | 100                  | 46          | 7            | 4.5          |
| MHCI05030-4R7M-R8 | 4.7             | 20             | 100                  | 60          | 6            | 4.0          |
| MHCI05030-6R8M-R8 | 6.8             | 20             | 100                  | 110         | 5            | 3.0          |
| MHCI05030-100M-R8 | 10              | 20             | 100                  | 126         | 4.5          | 1.5          |

**Note: When ordering, please specify tolerance code. Tolerance: M=±20%**

- Operating temperature range - 55°C ~ 125°C(Including self - temperature rise)
- Isat for Inductance drop 30% from its value without current
- I rms for a 40°C temperature rise from 25°C ambient with current
- Absolute maximum voltage 30VDC
- Measure Equipment :  
 L : WK 3260B or WK 6500P, 100kHz 0.5V  
 RDC : CHEN HWA 502 or CHEN HWA 46502B

**Test Instruments : WK3260B Impedance / Material Analyzer**

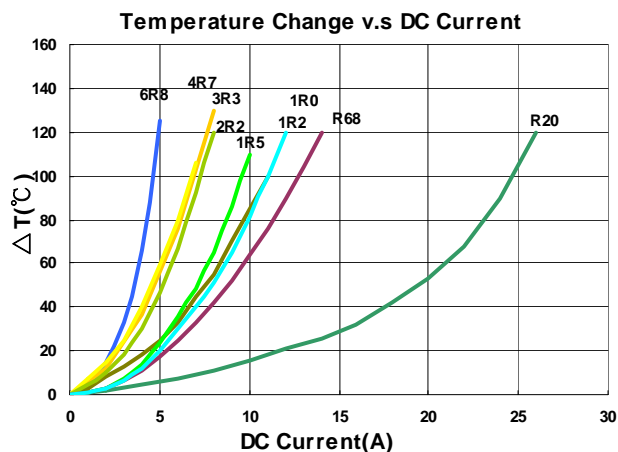
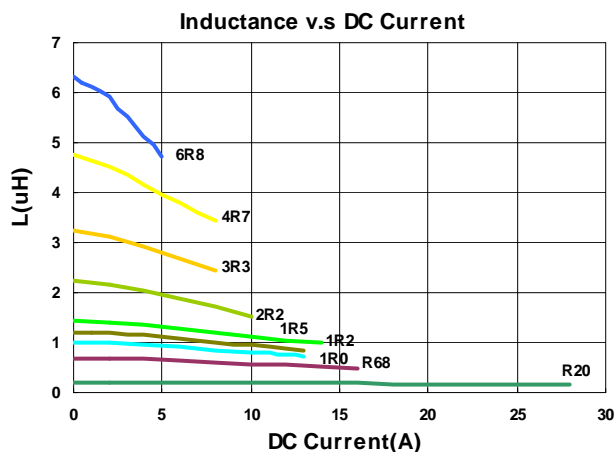

Please be sure to request approval specifications that provide further details of the products. Kindly note that the content of these specifications are subject to change or may be discontinued without advance notice. Please contact our sales department before ordering.

## Electrical Characteristics

| Part Number        | Inductance (uH) | Tolerance (±%) | Test Frequency (kHz) | RDC (mΩ) Max | Isat (A)Typ. | Irms (A)Typ. |
|--------------------|-----------------|----------------|----------------------|--------------|--------------|--------------|
| MHCI06012-4R7M-R8A | 4.7             | 20             | 100                  | 122          | 3.5          | 2.5          |
| MHCI06012-6R8M-R8A | 6.8             | 20             | 100                  | 210          | 2.8          | 2.2          |

**Note: When ordering, please specify tolerance code. Tolerance: M=±20%**

- Operating temperature range - 55°C ~ 125°C(Including self - temperature rise)
- Isat for Inductance drop 30% from its value without current
- I rms for a 40°C temperature rise from 25°C ambient with current
- Absolute maximum voltage 30VDC
- Measure Equipment :  
 L : WK 3260B or WK 6500P, 100kHz 0.5V  
 RDC : CHEN HWA 502 or CHEN HWA 46502B

**Test Instruments :** WK3260B Impedance / Material Analyzer

**Inductance vs DC Current**

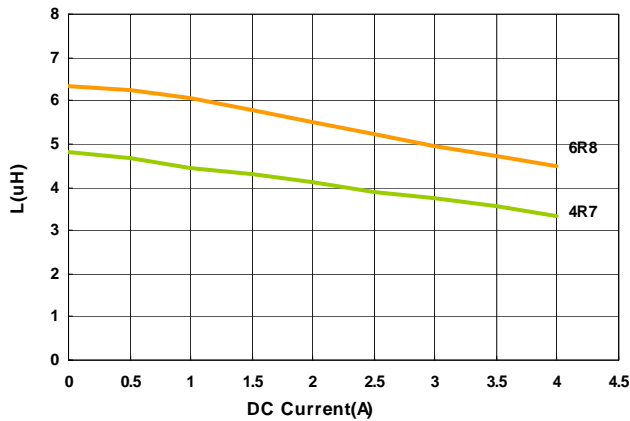

**Temperature Change v.s DC Current**

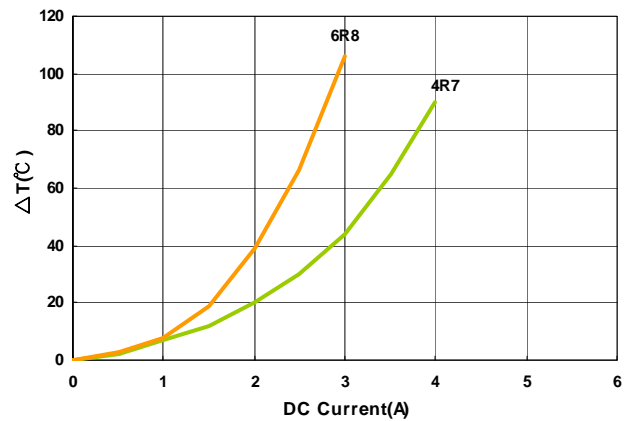

## Electrical Characteristics

| Part Number       | Inductance (uH) | Tolerance (±%) | Test Frequency (kHz) | RDC (mΩ)Max | Isat (A)Typ. | Irms (A)Typ. |
|-------------------|-----------------|----------------|----------------------|-------------|--------------|--------------|
| MHCI06015-2R2M-R8 | 2.2             | 20             | 100                  | 54          | 6.0          | 3.5          |
| MHCI06015-3R3M-R8 | 3.3             | 20             | 100                  | 63          | 5.5          | 3.3          |
| MHCI06015-4R7M-R8 | 4.7             | 20             | 100                  | 105         | 4.5          | 3.2          |
| MHCI06015-6R8M-R8 | 6.8             | 20             | 100                  | 140         | 4.0          | 2.5          |

**Note: When ordering, please specify tolerance code. Tolerance: M=±20%**

- Operating temperature range - 55°C ~ 125°C(Including self - temperature rise)
- Isat for Inductance drop 30% from its value without current
- I rms for a 40°C temperature rise from 25°C ambient with current
- Absolute maximum voltage 30VDC
- Measure Equipment :  
 L : WK 3260B or WK 6500P, 100kHz 0.5V  
 RDC : CHEN HWA 502 or CHEN HWA 46502B

**Test Instruments :** WK3260B Impedance / Material Analyzer

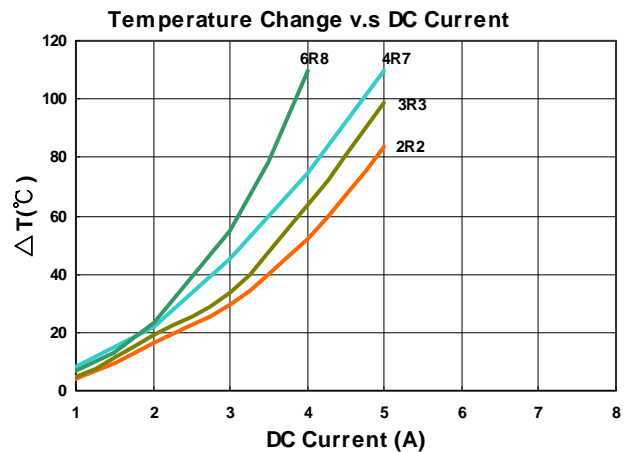
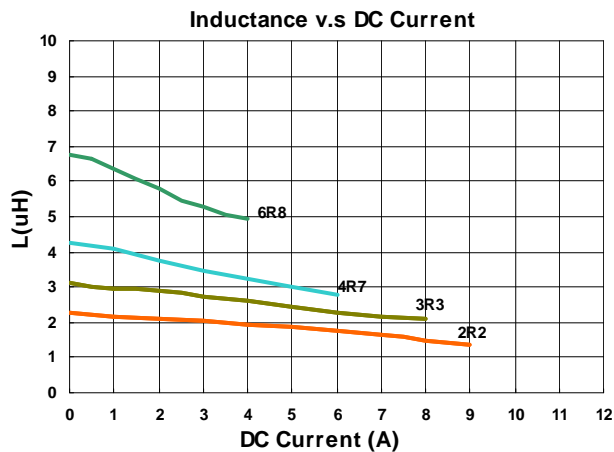

## Electrical Characteristics

| Part Number        | Inductance (uH) | Tolerance (±%) | Test Frequency (kHz) | RDC (mΩ)Max | Isat (A)Typ. | Irms (A)Typ. |
|--------------------|-----------------|----------------|----------------------|-------------|--------------|--------------|
| MHCI06015-1R0M-R8A | 1.0             | 20             | 100                  | 21          | 9.0          | 5.5          |
| MHCI06015-3R3M-R8A | 3.3             | 20             | 100                  | 63          | 5.5          | 3.3          |
| MHCI06015-100M-R8A | 10              | 20             | 100                  | 175         | 3.0          | 2.0          |

**Note: When ordering, please specify tolerance code. Tolerance: M=±20%**

- Operating temperature range - 55°C ~ 125°C(Including self - temperature rise)
- Isat for Inductance drop 30% from its value without current
- I rms for a 40°C temperature rise from 25°C ambient with current
- Absolute maximum voltage 30VDC
- Measure Equipment :  
 L : WK 3260B or WK 6500P, 100kHz 0.5V  
 RDC : CHEN HWA 502 or CHEN HWA 46502B

**Test Instruments : WK3260B Impedance / Material Analyzer**

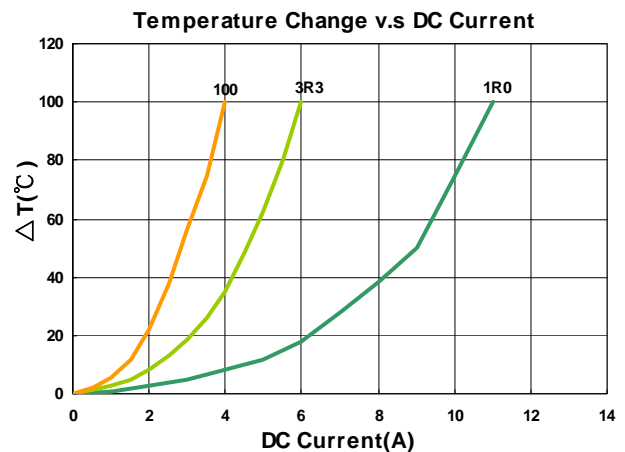
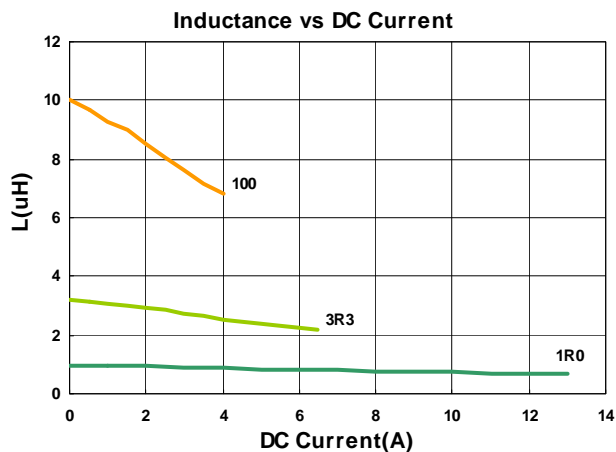

## Electrical Characteristics

| Part Number        | Inductance (uH) | Tolerance (±%) | Test Frequency (kHz) | RDC (mΩ)Max | Isat (A)Typ. | Irms (A)Typ. |
|--------------------|-----------------|----------------|----------------------|-------------|--------------|--------------|
| MHCI06018-R22M-R8A | 0.22            | 20             | 100                  | 5.2         | 29           | 14           |
| MHCI06018-R33M-R8A | 0.33            | 20             | 100                  | 6.8         | 22           | 12           |
| MHCI06018-R47M-R8A | 0.47            | 20             | 100                  | 8.4         | 18           | 11           |
| MHCI06018-R68M-R8A | 0.68            | 20             | 100                  | 12.7        | 17           | 9            |
| MHCI06018-1R0M-R8A | 1.0             | 20             | 100                  | 17          | 14           | 7            |
| MHCI06018-1R5M-R8A | 1.5             | 20             | 100                  | 26          | 12           | 6.5          |
| MHCI06018-2R2M-R8A | 2.2             | 20             | 100                  | 35          | 10           | 6.0          |
| MHCI06018-4R7M-R8A | 4.7             | 20             | 100                  | 70          | 5            | 3.5          |
| MHCI06018-6R8M-R8A | 6.8             | 20             | 100                  | 110         | 3.5          | 2.8          |
| MHCI06018-100M-R8A | 10              | 20             | 100                  | 155         | 2.5          | 2.3          |

**Note: When ordering, please specify tolerance code. Tolerance: M=±20%**

- Operating temperature range - 55°C ~ 125°C(Including self - temperature rise)
- Isat for Inductance drop 30% from its value without current
- I rms for a 40°C temperature rise from 25°C ambient with current
- Absolute maximum voltage 30VDC
- Measure Equipment :  
L : WK 3260B or WK 6500P, 100kHz 0.5V  
RDC : CHEN HWA 502 or CHEN HWA 46502B

**Test Instruments :** WK3260B Impedance / Material Analyzer

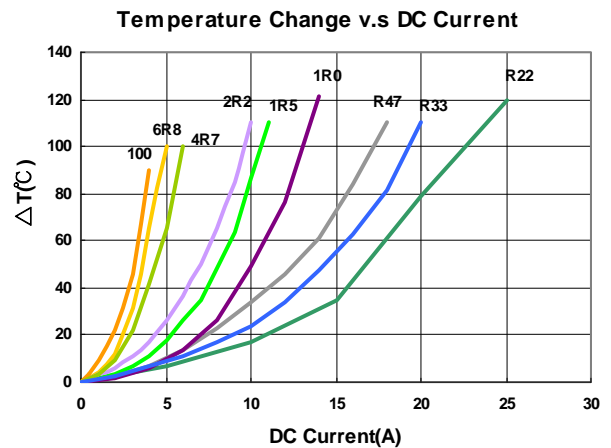
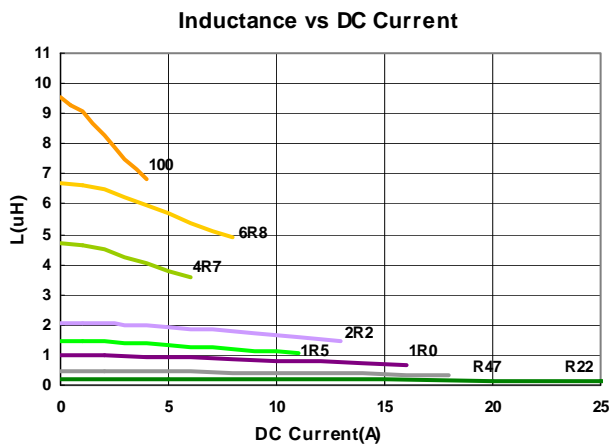

Please be sure to request approval specifications that provide further details of the products. Kindly note that the content of these specifications are subject to change or may be discontinued without advance notice. Please contact our sales department before ordering.

# Molding Power Choke – MHCC/MHCI Series

## Electrical Characteristics

| Part Number        | Inductance (uH) | Tolerance (±%) | Test Frequency (kHz) | RDC (mΩ)Max | Isat (A)Typ. | Irms (A)Typ. |
|--------------------|-----------------|----------------|----------------------|-------------|--------------|--------------|
| MHCI06024-R22M-R8A | 0.22            | 20             | 100                  | 3.2         | 34           | 21           |
| MHCI06024-R33M-R8A | 0.33            | 20             | 100                  | 4.1         | 24.5         | 18           |
| MHCI06024-R47M-R8A | 0.47            | 20             | 100                  | 5.1         | 22           | 15           |
| MHCI06024-1R0M-R8A | 1.0             | 20             | 100                  | 13.5        | 16           | 9            |
| MHCI06024-1R5M-R8A | 1.5             | 20             | 100                  | 20          | 15           | 9            |
| MHCI06024-2R2M-R8A | 2.2             | 20             | 100                  | 28          | 14           | 7            |
| MHCI06024-3R3M-R8A | 3.3             | 20             | 100                  | 39          | 10           | 5.5          |
| MHCI06024-4R7M-R8A | 4.7             | 20             | 100                  | 50          | 10           | 5.0          |
| MHCI06024-6R8M-R8A | 6.8             | 20             | 100                  | 70          | 6.0          | 4.0          |
| MHCI06024-100M-R8A | 10              | 20             | 100                  | 101         | 4.0          | 3.1          |
| MHCI06024-150M-R8A | 15              | 20             | 100                  | 160         | 3.3          | 2.5          |

**Note: When ordering, please specify tolerance code. Tolerance: M=±20%**

- Operating temperature range - 55°C ~ 125°C(Including self - temperature rise)
- Isat for Inductance drop 30% from its value without current
- I rms for a 40°C temperature rise from 25°C ambient with current
- Absolute maximum voltage 30VDC
- Measure Equipment :  
L : WK 3260B or WK 6500P, 100kHz 0.5V  
RDC : CHEN HWA 502 or CHEN HWA 46502B

**Test Instruments :** WK3260B Impedance / Material Analyzer

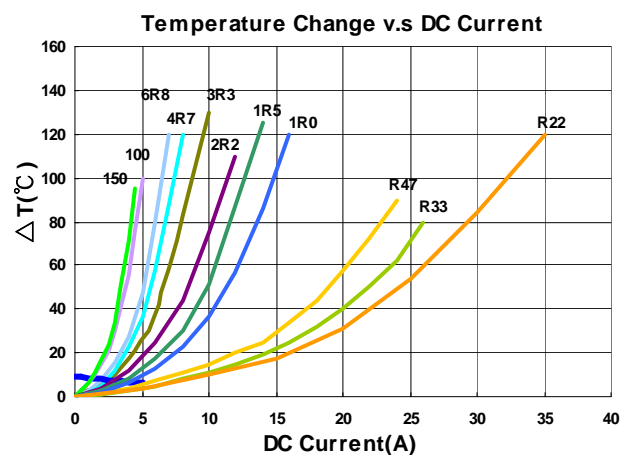
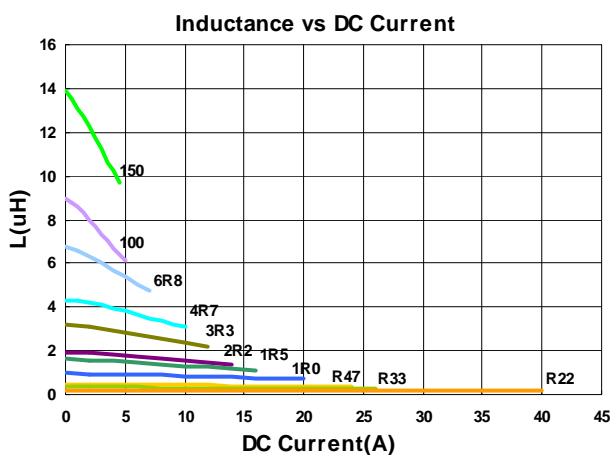

Please be sure to request approval specifications that provide further details of the products. Kindly note that the content of these specifications are subject to change or may be discontinued without advance notice. Please contact our sales department before ordering.

## Electrical Characteristics

| Part Number       | Inductance (uH) | Tolerance (±%) | Test Frequency (kHz) | RDC (mΩ) Max | Isat (A)Typ. | Irms (A)Typ. |
|-------------------|-----------------|----------------|----------------------|--------------|--------------|--------------|
| MHCI06030-R10M-R8 | 0.10            | 20             | 100                  | 1.5          | 45           | 37           |
| MHCI06030-R22M-R8 | 0.22            | 20             | 100                  | 2.8          | 40           | 23           |
| MHCI06030-R33M-R8 | 0.33            | 20             | 100                  | 4.2          | 33           | 20           |
| MHCI06030-R47M-R8 | 0.47            | 20             | 100                  | 5.5          | 27           | 16.5         |
| MHCI06030-R56M-R8 | 0.56            | 20             | 100                  | 5.5          | 27           | 16.5         |
| MHCI06030-R68M-R8 | 0.68            | 20             | 100                  | 6.3          | 24           | 15           |
| MHCI06030-R82M-R8 | 0.82            | 20             | 100                  | 8.0          | 23           | 13           |
| MHCI06030-1R0M-R8 | 1.0             | 20             | 100                  | 10           | 22           | 12           |
| MHCI06030-1R5M-R8 | 1.5             | 20             | 100                  | 15           | 18           | 9.5          |
| MHCI06030-1R8M-R8 | 1.8             | 20             | 100                  | 15           | 14           | 9.5          |
| MHCI06030-2R2M-R8 | 2.2             | 20             | 100                  | 20           | 14           | 8.5          |
| MHCI06030-3R3M-R8 | 3.3             | 20             | 100                  | 35           | 12           | 6.0          |
| MHCI06030-4R7M-R8 | 4.7             | 20             | 100                  | 40           | 9            | 5.5          |
| MHCI06030-5R6M-R8 | 5.6             | 20             | 100                  | 40           | 8            | 5.5          |
| MHCI06030-6R8M-R8 | 6.8             | 20             | 100                  | 60           | 8            | 4.5          |
| MHCC06030-8R2M-R7 | 8.2             | 20             | 100                  | 60           | 6            | 4.5          |
| MHCC06030-100M-R7 | 10              | 20             | 100                  | 68           | 5.5          | 4.0          |
| MHCI06030-150M-R8 | 15              | 20             | 100                  | 122          | 5.0          | 3.0          |
| MHCI06030-220M-R8 | 22              | 20             | 100                  | 145          | 3.2          | 3.0          |
| MHCI06030-330M-R8 | 33              | 20             | 100                  | 270          | 3.0          | 2.0          |

**Note: When ordering, please specify tolerance code. Tolerance: M=±20%**

- Operating temperature range - 55°C ~ 125°C(Including self - temperature rise)
- Isat for Inductance drop 30% from its value without current
- I rms for a 40°C temperature rise from 25°C ambient with current
- Absolute maximum voltage 30VDC
- Measure Equipment :  
 L : WK 3260B or WK 6500P, 100kHz 0.5V  
 RDC : CHEN HWA 502 or CHEN HWA 46502B

## Test Instruments : WK3260B Impedance / Material Analyzer

**Inductance v.s DC Current**

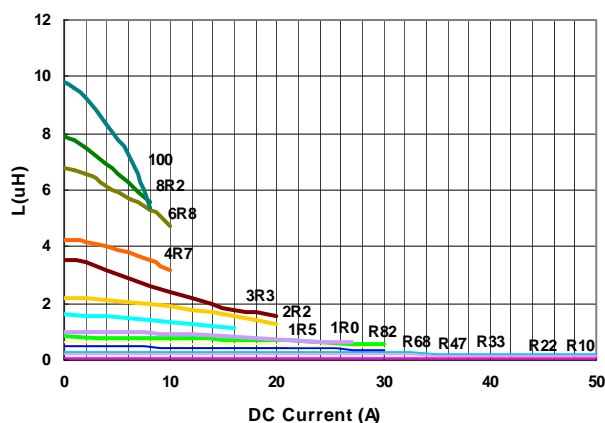

**Temperature Change v.s DC Current**

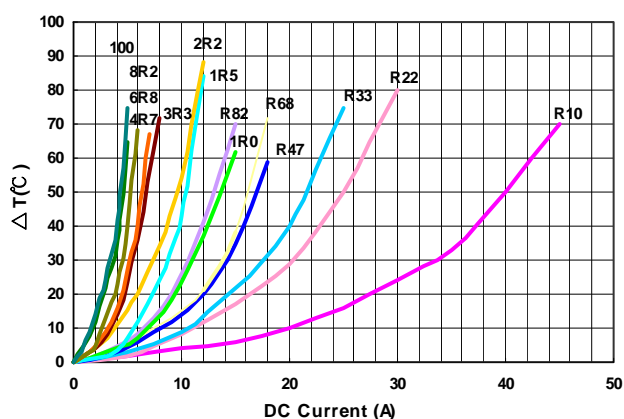

Please be sure to request approval specifications that provide further details of the products. Kindly note that the content of these specifications are subject to change or may be discontinued without advance notice. Please contact our sales department before ordering.



## Electrical Characteristics

| Part Number        | Inductance (uH) | Tolerance (±%) | Test Frequency (kHz) | RDC (mΩ)Max | Isat (A)Typ. | Irms (A)Typ. |
|--------------------|-----------------|----------------|----------------------|-------------|--------------|--------------|
| MHCI06030-R10M-R8A | 0.10            | 20             | 100                  | 1.7         | 60           | 32.5         |
| MHCI06030-R15M-R8A | 0.15            | 20             | 100                  | 2.5         | 40           | 30           |
| MHCI06030-R22M-R8A | 0.22            | 20             | 100                  | 3.0         | 34           | 23           |
| MHCI06030-R33M-R8A | 0.33            | 20             | 100                  | 3.5         | 25           | 21           |
| MHCI06030-R36M-R8A | 0.36            | 20             | 100                  | 3.9         | 24           | 20           |
| MHCI06030-R47M-R8A | 0.47            | 20             | 100                  | 4.1         | 20           | 18           |
| MHCI06030-R56M-R8A | 0.56            | 20             | 100                  | 4.5         | 18           | 16.5         |
| MHCI06030-R68M-R8A | 0.68            | 20             | 100                  | 5.3         | 17           | 16           |
| MHCI06030-R82M-R8A | 0.82            | 20             | 100                  | 6.0         | 16           | 14           |
| MHCI06030-1R0M-R8A | 1.0             | 20             | 100                  | 7.4         | 15           | 12           |
| MHCI06030-1R2M-R8A | 1.2             | 20             | 100                  | 10          | 14           | 10           |
| MHCI06030-1R5M-R8A | 1.5             | 20             | 100                  | 12.1        | 14           | 10           |
| MHCI06030-2R2M-R8A | 2.2             | 20             | 100                  | 15          | 10           | 8            |
| MHCI06030-3R3M-R8A | 3.3             | 20             | 100                  | 22          | 9.5          | 6.5          |
| MHCI06030-4R7M-R8A | 4.7             | 20             | 100                  | 33          | 6.5          | 5.5          |
| MHCI06030-6R8M-R8A | 6.8             | 20             | 100                  | 50          | 6            | 4.5          |
| MHCI06030-100M-R8A | 10              | 20             | 100                  | 68          | 5.5          | 4            |

**Note: When ordering, please specify tolerance code. Tolerance: M=±20%**

- Operating temperature range - 55°C ~ 125°C(Including self - temperature rise)
- Isat for Inductance drop 30% from its value without current
- I rms for a 40°C temperature rise from 25°C ambient with current
- Absolute maximum voltage 30VDC
- Measure Equipment :  
 L : WK 3260B or WK 6500P, 100kHz 0.5V  
 RDC : CHEN HWA 502 or CHEN HWA 46502B

**Test Instruments : WK3260B Impedance / Material Analyzer**

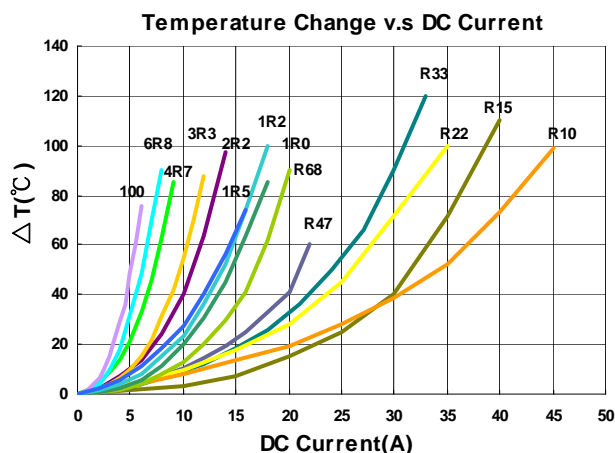
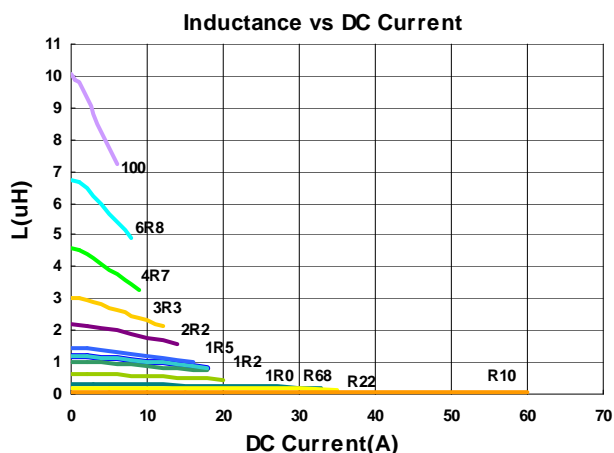

Please be sure to request approval specifications that provide further details of the products. Kindly note that the content of these specifications are subject to change or may be discontinued without advance notice. Please contact our sales department before ordering.

# Molding Power Choke – MHCC/MHCI Series

## Electrical Characteristics

| Part Number        | Inductance (uH) | Tolerance (±%) | Test Frequency (kHz) | RDC (mΩ) Max | Isat (A)Typ. | Irms (A)Typ. |
|--------------------|-----------------|----------------|----------------------|--------------|--------------|--------------|
| MHCI06050-R56M-R8A | 0.56            | 20             | 100                  | 3.3          | 20           | 20           |
| MHCI06050-1R0M-R8A | 1.0             | 20             | 100                  | 6.5          | 15           | 13           |
| MHCI06050-2R2M-R8A | 2.2             | 20             | 100                  | 12.5         | 12           | 8            |
| MHCI06050-3R3M-R8A | 3.3             | 20             | 100                  | 20.9         | 9            | 7            |
| MHCI06050-4R7M-R8A | 4.7             | 20             | 100                  | 25.0         | 7            | 6.5          |

**Note: When ordering, please specify tolerance code. Tolerance: M=±20%**

- Operating temperature range - 55°C ~ 125°C(Including self - temperature rise)
- Isat for Inductance drop 30% from its value without current
- I rms for a 40°C temperature rise from 25°C ambient with current
- Absolute maximum voltage 30VDC
- Measure Equipment :  
L : WK 3260B or WK 6500P, 100kHz 0.5V  
RDC : CHEN HWA 502 or CHEN HWA 46502B

**Test Instruments :** WK3260B Impedance / Material Analyzer

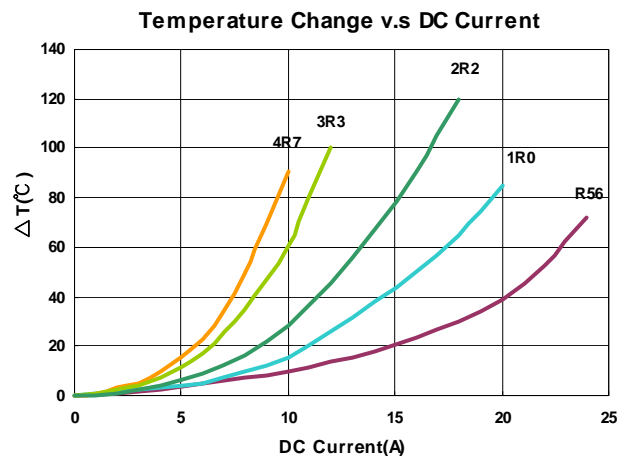
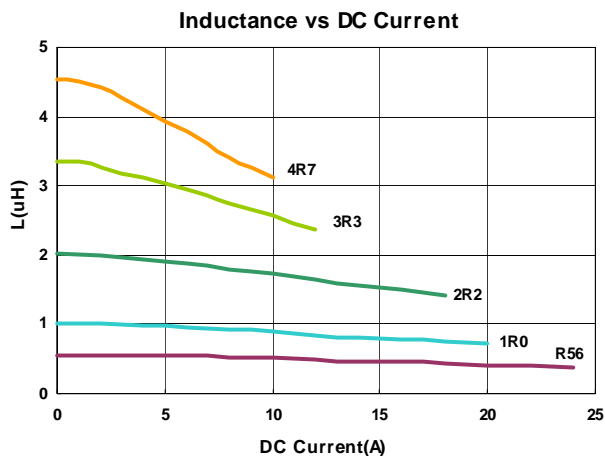

Please be sure to request approval specifications that provide further details of the products. Kindly note that the content of these specifications are subject to change or may be discontinued without advance notice. Please contact our sales department before ordering.

## Electrical Characteristics

| Part Number        | Inductance (uH) | Tolerance (±%) | Test Frequency (kHz) | RDC (mΩ) Max | Isat (A)Typ. | Irms (A)Typ. |
|--------------------|-----------------|----------------|----------------------|--------------|--------------|--------------|
| MHCC10030-R33M-R7A | 0.33            | 20             | 100                  | 1.6          | 32           | 23           |
| MHCC10030-1R0M-R7A | 1.0             | 20             | 100                  | 6.0          | 21           | 15           |
| MHCC10030-3R3M-R7A | 3.3             | 20             | 100                  | 16.0         | 14           | 9            |

**Note: When ordering, please specify tolerance code. Tolerance: M=±20%**

- Operating temperature range - 55°C ~ 125°C(Including self - temperature rise)
- Isat for Inductance drop 30% from its value without current
- Irms for a 40°C temperature rise from 25°C ambient with current
- Absolute maximum voltage 30VDC
- Measure Equipment :  
 L : WK 3260B or WK 6500P, 100kHz 0.5V  
 RDC : CHEN HWA 502 or CHEN HWA 46502B

**Test Instruments :** WK3260B Impedance / Material Analyzer

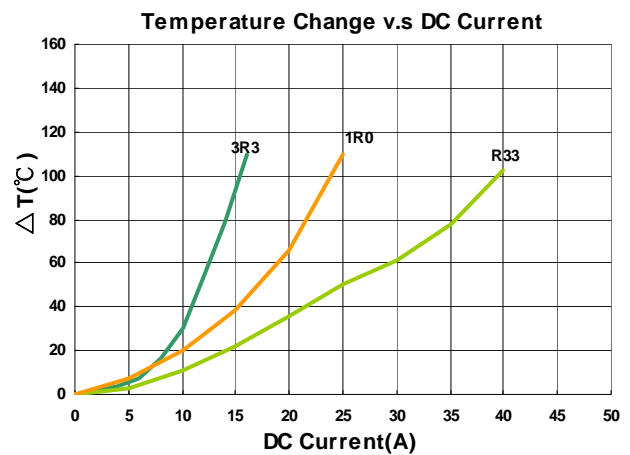
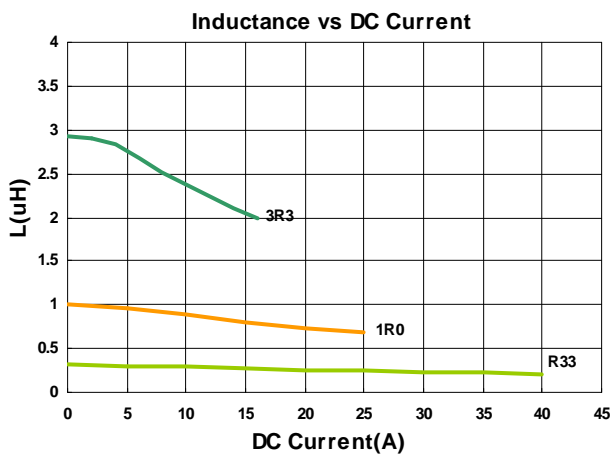

## Electrical Characteristics

| Part Number       | Inductance (uH) | Tolerance (±%) | Test Frequency (kHz) | RDC (mΩ) Max | Isat (A)Typ. | Irms (A)Typ. |
|-------------------|-----------------|----------------|----------------------|--------------|--------------|--------------|
| MHCC10040-R22M-R7 | 0.22            | 20             | 100                  | 0.6          | 45           | 35           |
| MHCC10040-R36M-R7 | 0.36            | 20             | 100                  | 1.2          | 42           | 34           |
| MHCC10040-R45M-R7 | 0.45            | 20             | 100                  | 1.2          | 38           | 33           |
| MHCC10040-R47M-R7 | 0.47            | 20             | 100                  | 1.2          | 38           | 33           |
| MHCC10040-R56M-R7 | 0.56            | 20             | 100                  | 1.55         | 32           | 27           |
| MHCC10040-R68M-R7 | 0.68            | 20             | 100                  | 1.55         | 30           | 27           |
| MHCC10040-1R0M-R7 | 1.0             | 20             | 100                  | 3.1          | 26           | 20           |
| MHCC10040-1R5M-R7 | 1.5             | 20             | 100                  | 4.2          | 22           | 16           |
| MHCC10040-1R8M-R7 | 1.8             | 20             | 100                  | 5            | 16           | 15.3         |
| MHCC10040-2R2M-R7 | 2.2             | 20             | 100                  | 7            | 16           | 14           |
| MHCC10040-3R3M-R7 | 3.3             | 20             | 100                  | 13.2         | 12           | 11           |
| MHCC10040-4R7M-R7 | 4.7             | 20             | 100                  | 16.5         | 12           | 9            |
| MHCC10040-6R8M-R7 | 6.8             | 20             | 100                  | 25           | 10           | 6            |
| MHCC10040-8R2M-R7 | 8.2             | 20             | 100                  | 30           | 9            | 6            |
| MHCC10040-100M-R7 | 10              | 20             | 100                  | 30           | 7            | 6.5          |
| MHCC10040-150M-R7 | 15              | 20             | 100                  | 45           | 6            | 6.25         |
| MHCC10040-220M-R7 | 22              | 20             | 100                  | 72           | 5.5          | 5            |

**Note: When ordering, please specify tolerance code. Tolerance: M=±20%**

- Operating temperature range - 55°C ~ 125°C(Including self - temperature rise)
- Isat for Inductance drop 30% from its value without current
- I rms for a 40°C temperature rise from 25°C ambient with current
- Absolute maximum voltage 30VDC
- Measure Equipment :  
 L : WK 3260B or WK 6500P, 100kHz 0.5V  
 RDC : CHEN HWA 502 or CHEN HWA 46502B

**Test Instruments : WK3260B Impedance / Material Analyzer**

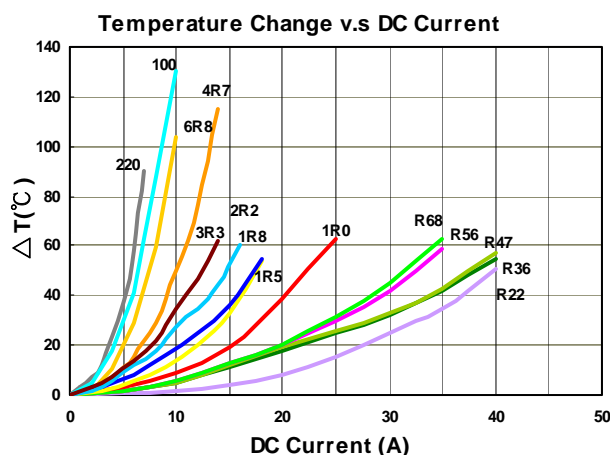
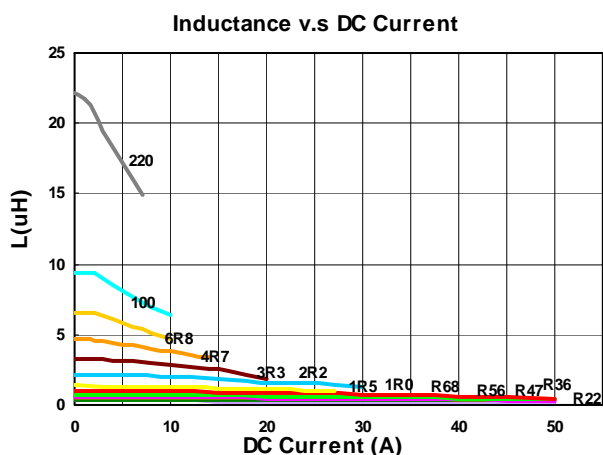

Please be sure to request approval specifications that provide further details of the products. Kindly note that the content of these specifications are subject to change or may be discontinued without advance notice. Please contact our sales department before ordering.

## Electrical Characteristics

| Part Number       | Inductance (uH) | Tolerance (±%) | Test Frequency (kHz) | RDC (mΩ) Max | Isat (A)Typ. | Irms (A)Typ. |
|-------------------|-----------------|----------------|----------------------|--------------|--------------|--------------|
| MHCC12050-R47M-R7 | 0.47            | 20             | 100                  | 1.2          | 46           | 37           |
| MHCC12050-1R0M-R7 | 1.0             | 20             | 100                  | 2.5          | 37           | 29           |
| MHCC12050-1R5M-R7 | 1.5             | 20             | 100                  | 3.0          | 28           | 28           |
| MHCC12050-4R7M-R7 | 4.7             | 20             | 100                  | 11.5         | 16           | 11           |
| MHCC12050-6R8M-R7 | 6.8             | 20             | 100                  | 22           | 14           | 9            |
| MHCC12050-100M-R7 | 10              | 20             | 100                  | 35           | 13           | 7            |

**Note: When ordering, please specify tolerance code. Tolerance: M=±20%**

- Operating temperature range - 55°C ~ 125°C(Including self - temperature rise)
- Isat for Inductance drop 30% from its value without current
- I rms for a 40°C temperature rise from 25°C ambient with current
- Absolute maximum voltage 30VDC
- Measure Equipment :  
 L : WK 3260B or WK 6500P, 100kHz 0.5V  
 RDC : CHEN HWA 502 or CHEN HWA 46502B

**Test Instruments :** WK3260B Impedance / Material Analyzer

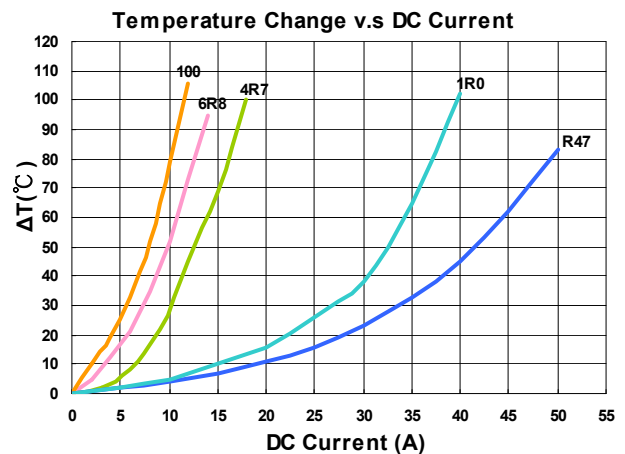
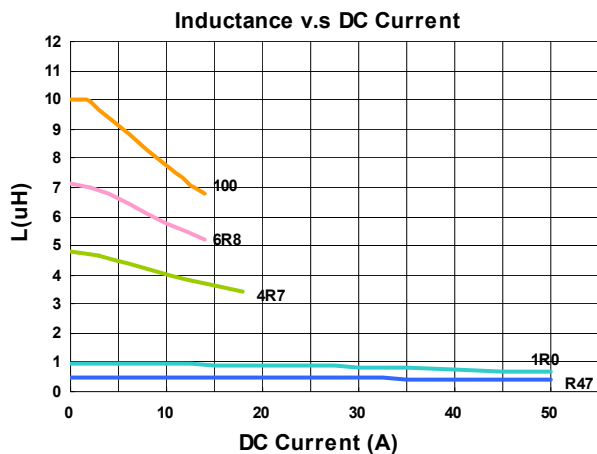

## Electrical Characteristics

| Part Number        | Inductance (uH) | Tolerance (±%) | Test Frequency (kHz) | RDC (mΩ) Max | Isat (A)Typ. | Irms (A)Typ. |
|--------------------|-----------------|----------------|----------------------|--------------|--------------|--------------|
| MHCC12060-100M-R7A | 10              | 20             | 100                  | 20.7         | 12.5         | 10           |
| MHCC12060-150M-R7A | 15              | 20             | 100                  | 29.0         | 9.0          | 6.0          |
| MHCC12060-220M-R7A | 22              | 20             | 100                  | 39.5         | 7.5          | 5.0          |
| MHCC12060-330M-R7A | 33              | 20             | 100                  | 75           | 6.0          | 4.0          |

**Note: When ordering, please specify tolerance code. Tolerance: M=±20%**

- Operating temperature range - 55°C ~ 125°C(Including self - temperature rise)
- Isat for Inductance drop 30% from its value without current
- I rms for a 40°C temperature rise from 25°C ambient with current
- Absolute maximum voltage 30VDC
- Measure Equipment :  
 L : WK 3260B or WK 6500P, 100kHz 0.5V  
 RDC : CHEN HWA 502 or CHEN HWA 46502B

**Test Instruments :** WK3260B Impedance / Material Analyzer

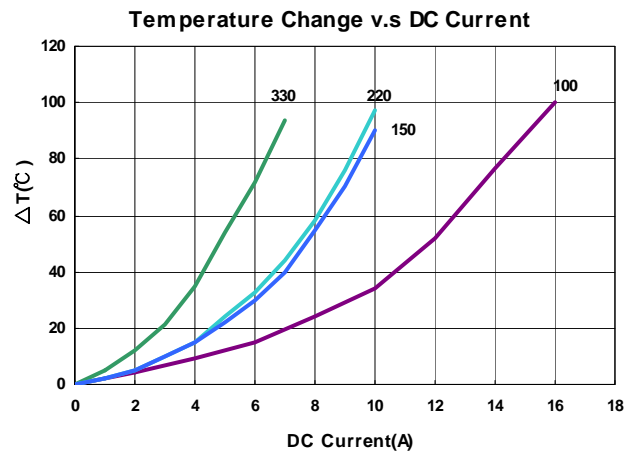
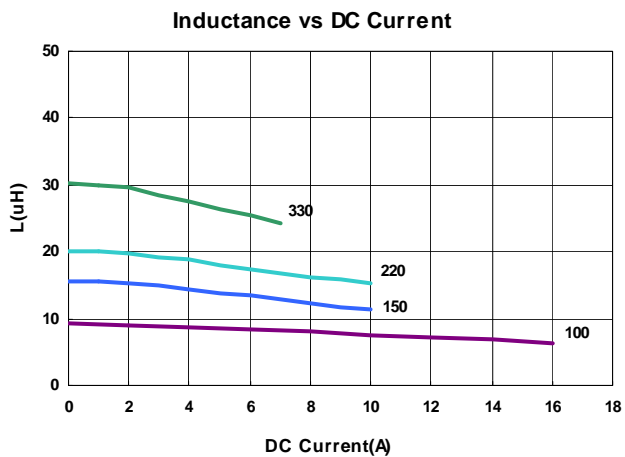

## Packaging Specifications

**Tape Dimensions**

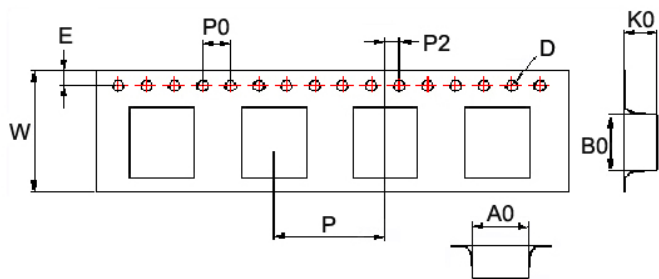

**Tape Material**

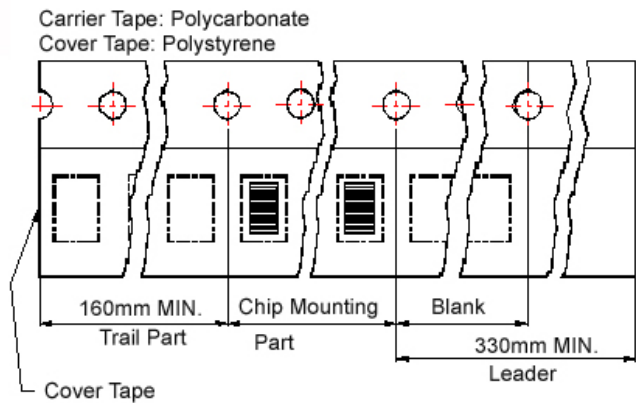

**Reel Dimensions**

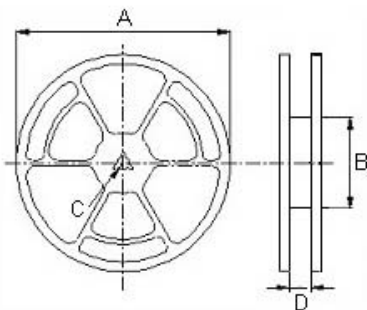

Dimensions in mm

| TYPE  | Tape Dimensions |      |      |      |      |    |    |    |    | Reel Dimensions |     |    |      | Quantity<br>PCS / REEL |
|-------|-----------------|------|------|------|------|----|----|----|----|-----------------|-----|----|------|------------------------|
|       | A0              | B0   | K0   | D    | E    | W  | P  | P0 | P2 | A               | B   | C  | D    |                        |
| 04012 | 4.6             | 5.0  | 1.5  | 1.55 | 1.75 | 12 | 8  | 4  | 2  | 330             | 100 | 13 | 13.4 | 2000                   |
| 04015 | 4.4             | 4.9  | 1.8  | 1.55 | 1.75 | 12 | 8  | 4  | 2  | 330             | 100 | 13 | 13.4 | 2000                   |
| 04020 | 4.3             | 4.9  | 2.4  | 1.55 | 1.75 | 12 | 8  | 4  | 2  | 330             | 100 | 13 | 13.4 | 2000                   |
| 05012 | 5.9             | 6.2  | 1.5  | 1.55 | 1.75 | 16 | 12 | 4  | 2  | 330             | 100 | 13 | 16.0 | 1000                   |
| 05015 | 5.7             | 6.1  | 1.9  | 1.55 | 1.75 | 16 | 12 | 4  | 2  | 330             | 100 | 13 | 16.0 | 1000                   |
| 05018 | 5.9             | 6.2  | 2.2  | 1.55 | 1.75 | 16 | 12 | 4  | 2  | 330             | 100 | 13 | 16.0 | 1000                   |
| 05020 | 5.7             | 5.9  | 2.4  | 1.55 | 1.75 | 16 | 12 | 4  | 2  | 330             | 100 | 13 | 16.0 | 1000                   |
| 05030 | 5.9             | 6.2  | 3.4  | 1.55 | 1.75 | 16 | 12 | 4  | 2  | 330             | 100 | 13 | 16.0 | 1000                   |
| 06012 | 6.9             | 7.6  | 1.6  | 1.55 | 1.75 | 16 | 12 | 4  | 2  | 330             | 100 | 13 | 16.0 | 1000                   |
| 06015 | 6.9             | 7.6  | 1.9  | 1.55 | 1.75 | 16 | 12 | 4  | 2  | 330             | 100 | 13 | 16.0 | 1000                   |
| 06018 | 6.9             | 7.6  | 2.2  | 1.55 | 1.75 | 16 | 12 | 4  | 2  | 330             | 100 | 13 | 16.0 | 1000                   |
| 06024 | 6.9             | 7.6  | 2.9  | 1.55 | 1.75 | 16 | 12 | 4  | 2  | 330             | 100 | 13 | 16.0 | 1000                   |
| 06030 | 6.9             | 7.6  | 3.4  | 1.55 | 1.75 | 16 | 12 | 4  | 2  | 330             | 100 | 13 | 16.0 | 1000                   |
| 06050 | 6.9             | 7.6  | 5.4  | 1.55 | 1.75 | 16 | 12 | 4  | 2  | 330             | 100 | 13 | 16.0 | 1000                   |
| 10030 | 10.6            | 11.7 | 3.25 | 1.55 | 1.75 | 24 | 16 | 4  | 2  | 330             | 100 | 13 | 24.4 | 500                    |
| 10040 | 10.6            | 11.7 | 4.25 | 1.55 | 1.75 | 24 | 16 | 4  | 2  | 330             | 100 | 13 | 24.4 | 500                    |
| 12050 | 13              | 14   | 5.25 | 1.55 | 1.75 | 24 | 16 | 4  | 2  | 330             | 100 | 13 | 24.4 | 500                    |
| 12060 | 13              | 14   | 6.25 | 1.55 | 1.75 | 24 | 16 | 4  | 2  | 330             | 100 | 13 | 24.4 | 500                    |

## X-ON Electronics

Largest Supplier of Electrical and Electronic Components

*Click to view similar products for [Fixed Inductors](#) category:*

*Click to view products by [Chilisin](#) manufacturer:*

Other Similar products are found below :

[CR32NP-100KC](#) [CR32NP-151KC](#) [CR32NP-180KC](#) [CR32NP-181KC](#) [CR32NP-1R5MC](#) [CR32NP-390KC](#) [CR32NP-3R9MC](#) [CR32NP-680KC](#) [CR32NP-820KC](#) [CR32NP-8R2MC](#) [CR43NP-390KC](#) [CR43NP-560KC](#) [CR43NP-680KC](#) [CR54NP-181KC](#) [CR54NP-470LC](#) [CR54NP-820KC](#) [CR54NP-8R5MC](#) [70F224AI](#) [MGDQ4-00004-P](#) [MHL1ECTTP18NJ](#) [MHQ1005P10NJ](#) [MHQ1005P1N0S](#) [MHQ1005P2N4S](#) [MHQ1005P3N6S](#) [MHQ1005P5N1S](#) [MHQ1005P8N2J](#) [PE-51506NL](#) [PE-53601NL](#) [PE-53602NL](#) [PE-53630NL](#) [PE-53824SNLT](#) [PE-92100NL](#) [PG0434.801NLT](#) [PG0936.113NLT](#) [9220-20](#) [9310-16](#) [PM06-2N7](#) [PM06-39NJ](#) [A01TK](#) [1206CS-471XJ](#) [HC2LP-R47-R](#) [HC2-R47-R](#) [HC3-2R2-R](#) [HCF1305-3R3-R](#) [1206CS-151XG](#) [RCH664NP-140L](#) [RCH664NP-4R7M](#) [RCH8011NP-221L](#) [RCP1317NP-332L](#) [RCP1317NP-391L](#)