

Cautions and Warnings

Please be noted that this spec is only for reference if you have projects designed with the product number listed in. If you are looking for new project design-in, please find BMRx Series specification/datasheet on Chilisin website. Or you may find our sales contact for more information on old part number at your convenience. Appreciated your attention and understanding.

Note: Please be sure to request approval specifications that provide further details of the products. Kindly note that the content of these specifications are subject to change or may be discontinued without prior notice. This product may not be designed/used in medical or high risk applications without Chilisin approval. Please contact our sales department before ordering.

MHCC、MHCI Series



MHCC series is designed for low profile type with low RDC and ultra large current. Its molded magnetic shielded type is suitable for high-density mounting and ultra low buzz noise. Soldering conditions can be easily confirmed when mounting onto the board. This series also provides customers with embossed carrier type packaging for automatic mounting machine.

Features

- RoHS, Halogen Free and REACH Compliance
- High rated current
- Ultra low buzz noise

Applications

- Laptops and PCs
- Switches and servers
- Base stations
- DC/DC converters

Product Identification

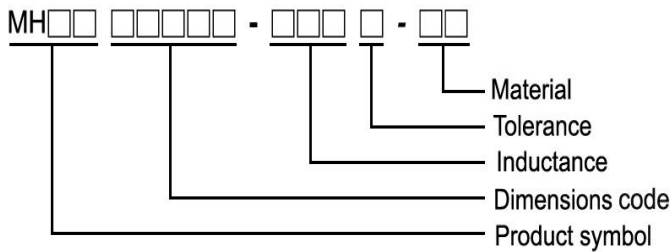

Shape and Dimensions

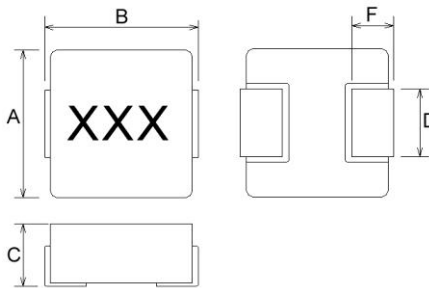

Recommended Pattern

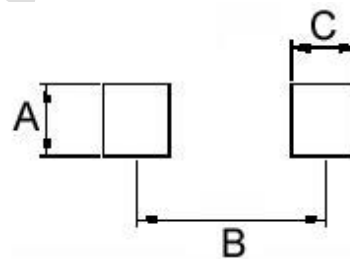

Dimensions in mm

TYPE	A	B Max	C Max	D	F
04012	4.1±0.2	4.6±0.2	1.2	1.5±0.3	1.0±0.5
04015	4.1±0.2	4.6±0.2	1.5	1.5±0.3	1.0±0.5
04020	4.1±0.2	4.6±0.2	2.0	1.5±0.3	1.0±0.5
05012	5.4±0.35	5.7±0.2	1.2	2.0±0.3	1.5±0.3
05015	5.4±0.35	5.7±0.2	1.5	2.0±0.3	1.5±0.3
05018	5.4±0.35	5.7±0.2	1.8	2.0±0.3	1.5±0.3
05020	5.4±0.35	5.7±0.2	1.8±0.2	2.0±0.3	1.5±0.3
05030	5.4±0.35	5.7±0.2	3.0	2.0±0.3	1.5±0.3
06012	6.6±0.2	7.3	1.2	2.9	1.6±0.5
06015	6.6±0.2	7.3	1.3±0.2	2.9	1.6±0.5
06018	6.6±0.2	7.3	1.6±0.2	2.9	1.6±0.5
06024	6.6±0.2	7.3	2.4	2.9	1.6±0.5
06030	6.6±0.2	7.3	3.0	2.9	1.6±0.5
06050	6.6±0.2	7.3	5.0	2.9	1.6±0.5
10030	10.1±0.3	11.6	3.0	3.0	2.5±0.5
10040	10.1±0.3	11.6	4.0	3.0	2.5±0.5
12050	12.6±0.2	13.8	5.0	3.7	2.7±0.7
12060	12.6±0.2	13.8	6.0	3.7	2.7±0.7

Dimensions in mm

TYPE	A	B	C
04012	2.5	3.7	1.5
04015	2.5	3.7	1.5
04020	2.5	3.7	1.5
05012	2.5	4.1	1.9
05015	2.5	4.1	1.9
05018	2.5	4.1	1.9
05020	2.5	4.1	1.9
05030	2.5	4.1	1.9
06012	3.5	6.05	2.35
06015	3.5	6.05	2.35
06018	3.5	6.05	2.35
06024	3.5	6.05	2.35
06030	3.5	6.05	2.35
06050	3.5	6.05	2.35
10030	4.0	9.5	3.5
10040	4.0	9.5	3.5
12050	5.0	10.5	4.0
12060	5.5	10.5	4.0

Molding Power Choke – MHCC/MHCI Series

Electrical Characteristics

Part Number	Inductance (uH)	Tolerance (±%)	Test Frequency (kHz)	RDC (mΩ) Max	Isat (A)Typ.	Irms (A)Typ.
MHCI04012-R22M-R8	0.22	20	100	12	11.5	8.5
MHCI04012-R33M-R8	0.33	20	100	19	8.5	6.5
MHCI04012-R47M-R8	0.47	20	100	25	7.0	5.0
MHCI04012-R68M-R8	0.68	20	100	36	6.0	4.5
MHCI04012-1R0M-R8	1.0	20	100	47	5.2	4.2
MHCI04012-1R5M-R8	1.5	20	100	75	4.0	3.25
MHCI04012-2R2M-R8	2.2	20	100	83.5	3.5	2.75
MHCI04012-3R3M-R8	3.3	20	100	165	3.0	2.0
MHCI04012-4R7M-R8	4.7	20	100	195	2.8	1.8

Note: When ordering, please specify tolerance code. Tolerance: M=±20%

- Operating temperature range - 55°C ~ 125°C(Including self - temperature rise)
- Isat for Inductance drop 30% from its value without current
- I rms for a 40°C temperature rise from 25°C ambient with current
- Absolute maximum voltage 30VDC
- Measure Equipment :
 L : WK 3260B or WK 6500P, 100kHz 0.5V
 RDC : CHEN HWA 502 or CHEN HWA 46502B

Test Instruments : WK3260B Impedance / Material Analyzer

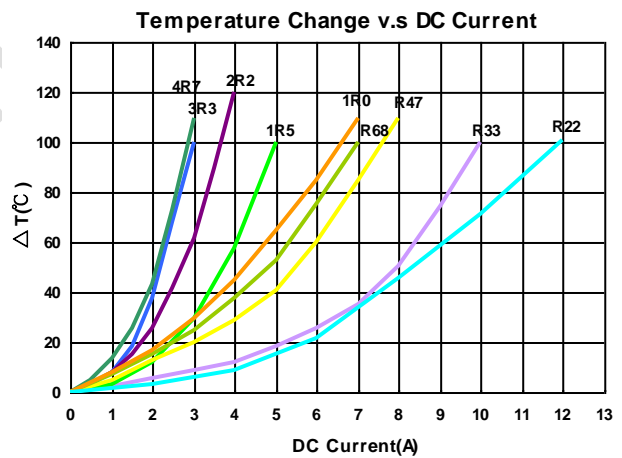
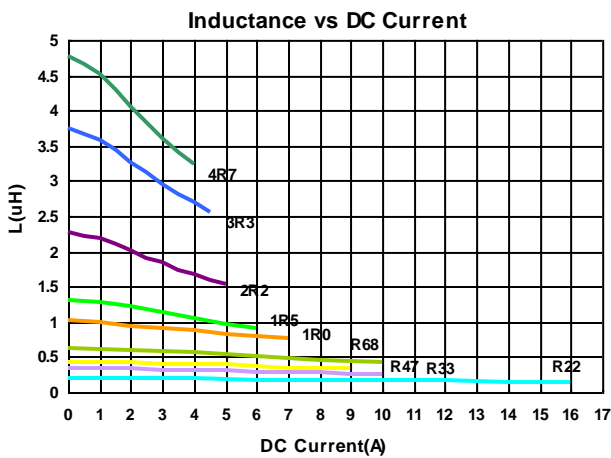

Molding Power Choke – MHCC/MHCI Series

Electrical Characteristics

Part Number	Inductance (uH)	Tolerance (±%)	Test Frequency (kHz)	RDC (mΩ) Max	Isat (A)Typ.	Irms (A)Typ.
MHCI04015-1R0M-R8	1.0	20	100	42	7	4
MHCI04015-1R5M-R8	1.5	20	100	50	6	3.5
MHCI04015-2R2M-R8	2.2	20	100	79	5	3
MHCI04015-3R3M-R8	3.3	20	100	132	4.5	2.3
MHCI04015-4R7M-R8	4.7	20	100	146	4	2

Note: When ordering, please specify tolerance code. Tolerance: M=±20%

- Operating temperature range - 55°C ~ 125°C(Including self - temperature rise)
- Isat for Inductance drop 30% from its value without current
- I rms for a 40°C temperature rise from 25°C ambient with current
- Absolute maximum voltage 30VDC
- Measure Equipment :
L : WK 3260B or WK 6500P, 100kHz 0.5V
RDC : CHEN HWA 502 or CHEN HWA 46502B

Test Instruments : WK3260B Impedance / Material Analyzer

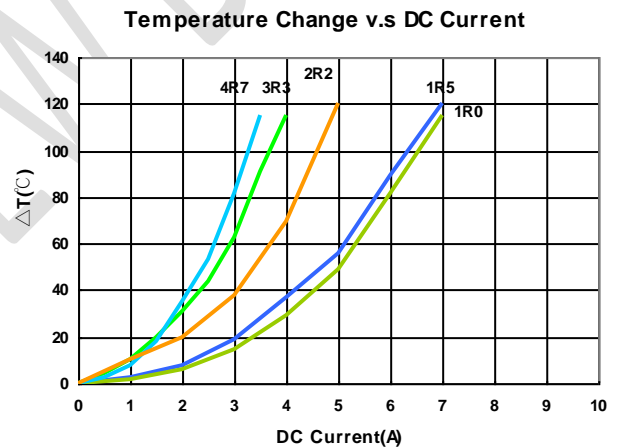
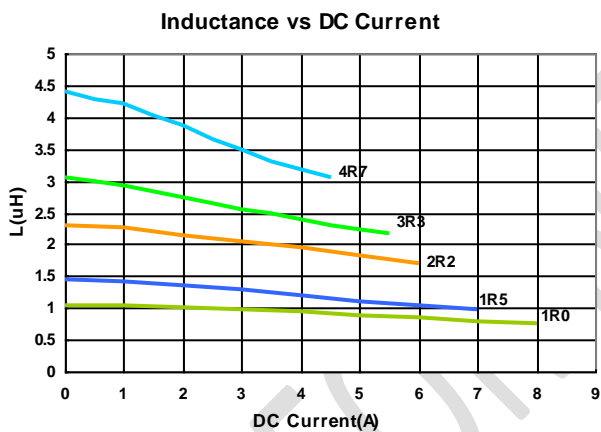

Molding Power Choke – MHCC/MHCI Series

Electrical Characteristics

Part Number	Inductance (uH)	Tolerance (±%)	Test Frequency (kHz)	RDC (mΩ) Max	Isat (A)Typ.	Irms (A)Typ.
MHCI04020-R10M-R8	0.10	20	100	4	25	12.0
MHCI04020-R22M-R8	0.22	20	100	6.6	12.5	9.0
MHCI04020-R47M-R8	0.47	20	100	14	9.5	7.0
MHCI04020-R56M-R8	0.56	20	100	16	10.0	6.5
MHCI04020-R68M-R8	0.68	20	100	21	8.0	5.2
MHCI04020-1R0M-R8	1.0	20	100	27	7.0	4.5
MHCI04020-1R5M-R8	1.5	20	100	46	6.0	4.0
MHCI04020-2R2M-R8	2.2	20	100	58	5.0	3.0
MHCI04020-3R3M-R8	3.3	20	100	87	4.0	2.5
MHCI04020-4R7M-R8	4.7	20	100	126	3.0	2.2
MHCI04020-6R8M-R8	6.8	20	100	135	2.5	2.0
MHCI04020-8R2M-R8	8.2	20	100	216	2.5	2.0
MHCI04020-100M-R8	10	20	100	258	2.0	1.6

Note: When ordering, please specify tolerance code. Tolerance: M=±20%

- Operating temperature range - 55°C ~ 125°C(Including self - temperature rise)
- Isat for Inductance drop 30% from its value without current
- I rms for a 40°C temperature rise from 25°C ambient with current
- Absolute maximum voltage 30VDC
- Measure Equipment :
 L : WK 3260B or WK 6500P, 100KHz 0.5V
 RDC : CHEN HWA 502 or CHEN HWA 46502B

Test Instruments : WK3260B Impedance / Material Analyzer

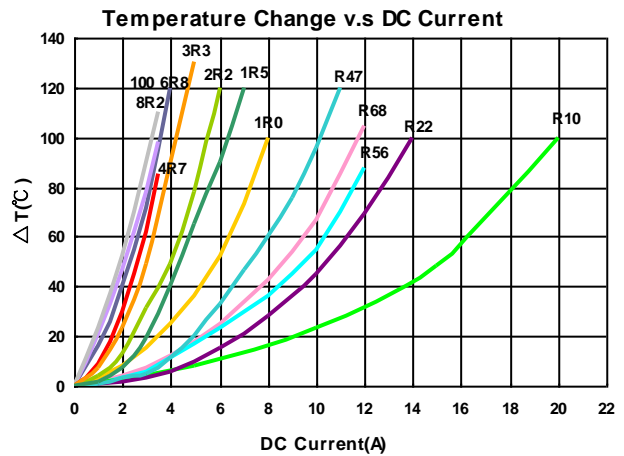
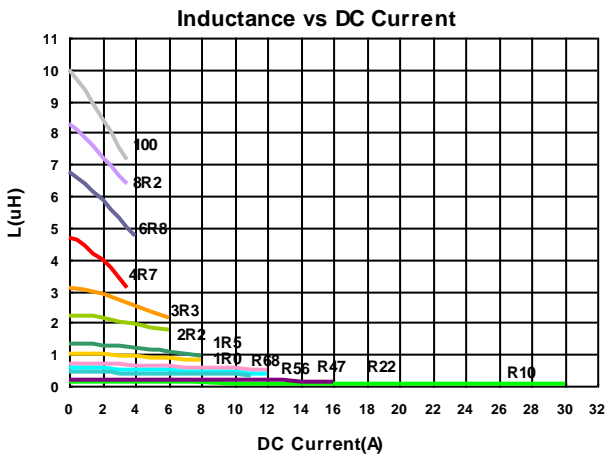

Molding Power Choke – MHCC/MHCI Series

Electrical Characteristics

Part Number	Inductance (uH)	Tolerance (±%)	Test Frequency (kHz)	RDC (mΩ) Max	Isat (A)Typ.	Irms (A)Typ.
MHCI05012-1R0M-R8A	1.0	20	100	30	6.0	5.0
MHCI05012-2R2M-R8A	2.2	20	100	76	4.0	3.5
MHCI05012-6R8M-R8A	6.8	20	100	250	2.3	2.0

Note: When ordering, please specify tolerance code. Tolerance: M=±20%

- Operating temperature range - 55°C ~ 125°C(Including self - temperature rise)
- Isat for Inductance drop 30% from its value without current
- I rms for a 40°C temperature rise from 25°C ambient with current
- Absolute maximum voltage 30VDC
- Measure Equipment :
 L : WK 3260B or WK 6500P, 100kHz 0.5V
 RDC : CHEN HWA 502 or CHEN HWA 46502B

Test Instruments : WK3260B Impedance / Material Analyzer

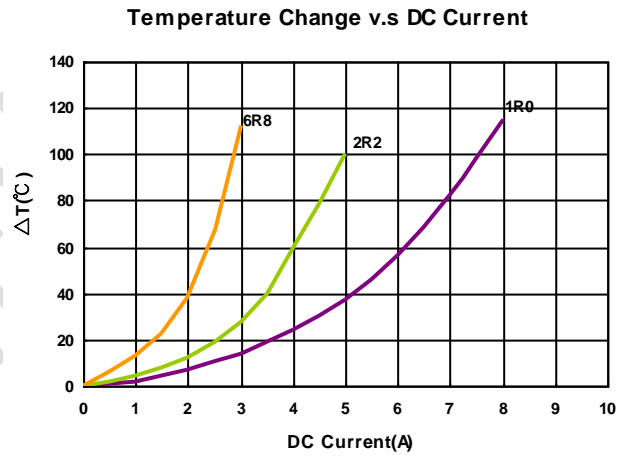
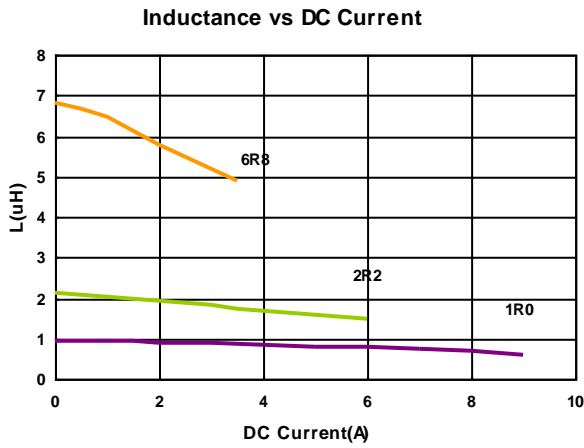

Molding Power Choke – MHCC/MHCI Series

Electrical Characteristics

Part Number	Inductance (uH)	Tolerance (±%)	Test Frequency (kHz)	RDC (mΩ) Max	Isat (A)Typ.	Irms (A)Typ.
MHCI05015-1R0M-R8A	1.0	20	100	23	9	6.5
MHCI05015-2R2M-R8A	2.2	20	100	64	6	3.3
MHCI05015-4R7M-R8A	4.7	20	100	106	4	3.0
MHCI05015-100M-R8A	10	20	100	170	3	2.0

Note: When ordering, please specify tolerance code. Tolerance: M=±20%

- Operating temperature range - 55°C ~ 125°C(Including self - temperature rise)
- Isat for Inductance drop 30% from its value without current
- I rms for a 40°C temperature rise from 25°C ambient with current
- Absolute maximum voltage 30VDC
- Measure Equipment :
 L : WK 3260B or WK 6500P, 100kHz 0.5V
 RDC : CHEN HWA 502 or CHEN HWA 46502B

Test Instruments : WK3260B Impedance / Material Analyzer

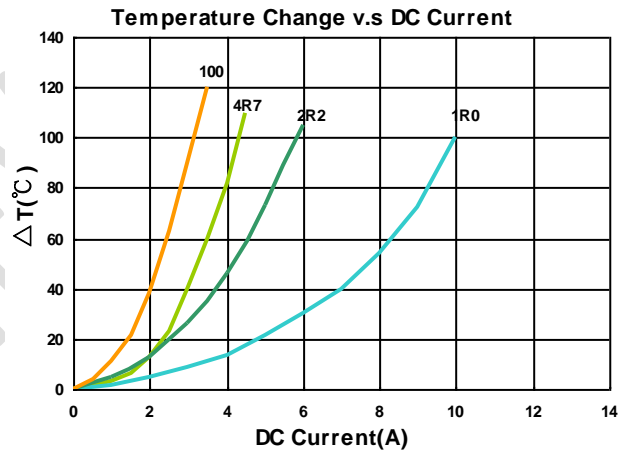
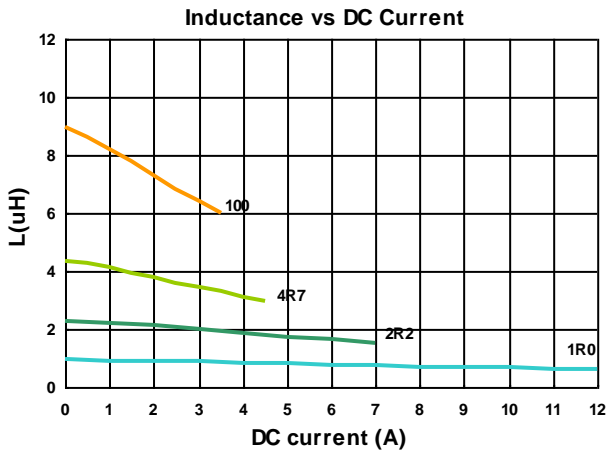

Molding Power Choke – MHCC/MHCI Series

Electrical Characteristics

Part Number	Inductance (uH)	Tolerance (±%)	Test Frequency (kHz)	RDC (mΩ) Max	Isat (A)Typ.	Irms (A)Typ.
MHCI05015-R47M-R8	0.47	20	100	16	12	8.0
MHCI05015-R68M-R8	0.68	20	100	23	10	6.0
MHCI05015-1R0M-R8	1.0	20	100	33	8.0	5.0
MHCI05015-1R5M-R8	1.5	20	100	50	6.0	4.0
MHCI05015-2R2M-R8	2.2	20	100	68	6.0	3.3
MHCI05015-3R3M-R8	3.3	20	100	84	5.0	3.0
MHCI05015-4R7M-R8	4.7	20	100	135	4.0	2.5
MHCI05015-5R6M-R8	5.6	20	100	175	3.5	2.2
MHCI05015-6R8M-R8	6.8	20	100	192	3.0	2.0
MHCI05015-100M-R8	10	20	100	195	2.0	1.5

Note: When ordering, please specify tolerance code. Tolerance: M=±20%

- Operating temperature range - 55°C ~ 125°C(Including self - temperature rise)
- Isat for Inductance drop 30% from its value without current
- I rms for a 40°C temperature rise from 25°C ambient with current
- Absolute maximum voltage 30VDC
- Measure Equipment :
 L : WK 3260B or WK 6500P, 100kHz 0.5V
 RDC : CHEN HWA 502 or CHEN HWA 46502B

Test Instruments : WK3260B Impedance / Material Analyzer

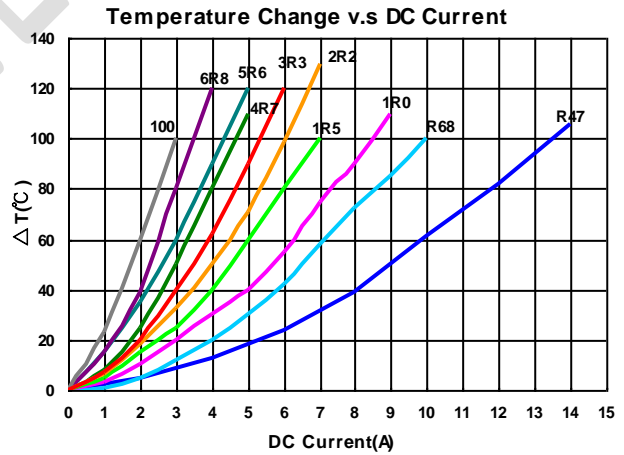
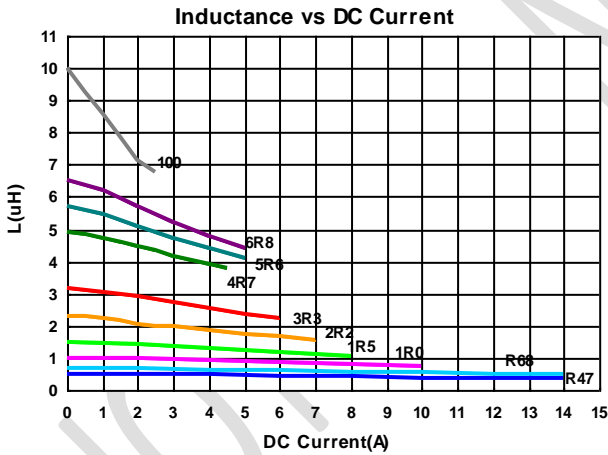

Please be sure to request approval specifications that provide further details of the products. Kindly note that the content of these specifications are subject to change or may be discontinued without prior notice. This product may not be designed/used in medical or high risk applications without Chilisin approval. Please contact our sales department before ordering.

Molding Power Choke – MHCC/MHCI Series

Electrical Characteristics

Part Number	Inductance (uH)	Tolerance (±%)	Test Frequency (kHz)	RDC (mΩ) Max	Isat (A)Typ.	Irms (A)Typ.
MHCI05018-R47M-R8A	0.47	20	100	9.0	15.5	10.5
MHCI05018-1R0M-R8A	1.0	20	100	17	9.0	8.0
MHCI05018-2R2M-R8A	2.2	20	100	35	6.5	5.0
MHCI05018-3R3M-R8A	3.3	20	100	58	5.0	4.5
MHCI05018-4R7M-R8A	4.7	20	100	85	4.0	3.5
MHCI05018-6R8M-R8A	6.8	20	100	120	3.4	2.8
MHCI05018-100M-R8A	10	20	100	155	3.0	2.5

Note: When ordering, please specify tolerance code. Tolerance: M=±20%

- Operating temperature range - 55°C ~ 125°C(Including self - temperature rise)
- Isat for Inductance drop 30% from its value without current
- I rms for a 40°C temperature rise from 25°C ambient with current
- Absolute maximum voltage 30VDC
- Measure Equipment :
 - L : WK 3260B or WK 6500P, 100kHz 0.5V
 - RDC : CHEN HWA 502 or CHEN HWA 46502B

Test Instruments : WK3260B Impedance / Material Analyzer

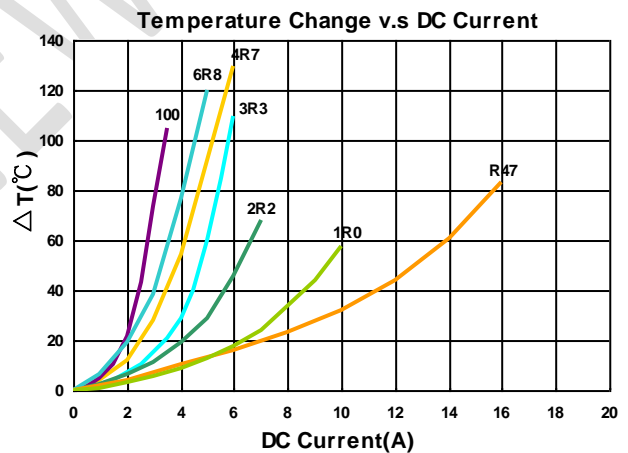
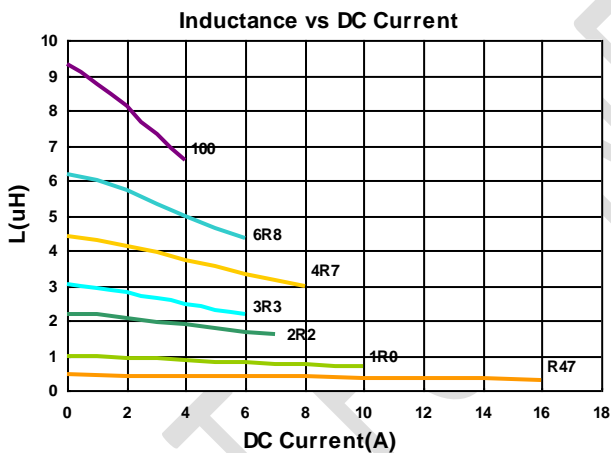

Molding Power Choke – MHCC/MHCI Series

Electrical Characteristics

Part Number	Inductance (uH)	Tolerance (±%)	Test Frequency (kHz)	RDC (mΩ) Max	Isat (A)Typ.	Irms (A)Typ.
MHCI05020-R47M-R8	0.47	20	100	9	15.5	10.5
MHCI05020-1R0M-R8	1.0	20	100	30	7.0	6.0
MHCI05020-1R5M-R8	1.5	20	100	35	6.5	5.5
MHCI05020-2R2M-R8	2.2	20	100	45	6.0	4.0
MHCI05020-3R3M-R8	3.3	20	100	60	5.5	3.5
MHCI05020-4R7M-R8	4.7	20	100	90	5.0	3.0
MHCI05020-5R6M-R8	5.6	20	100	120	4.5	2.8
MHCI05020-6R8M-R8	6.8	20	100	125	4.5	2.8
MHCI05020-100M-R8	10	20	100	180	4.0	2.3

Note: When ordering, please specify tolerance code. Tolerance: M=±20%

- Operating temperature range - 55°C ~ 125°C(Including self - temperature rise)
- Isat for Inductance drop 30% from its value without current
- I rms for a 40°C temperature rise from 25°C ambient with current
- Absolute maximum voltage 30VDC
- Measure Equipment :
 L : WK 3260B or WK 6500P, 100kHz 0.5V
 RDC : CHEN HWA 502 or CHEN HWA 46502B

Test Instruments : WK3260B Impedance / Material Analyzer

Inductance v.s DC Current

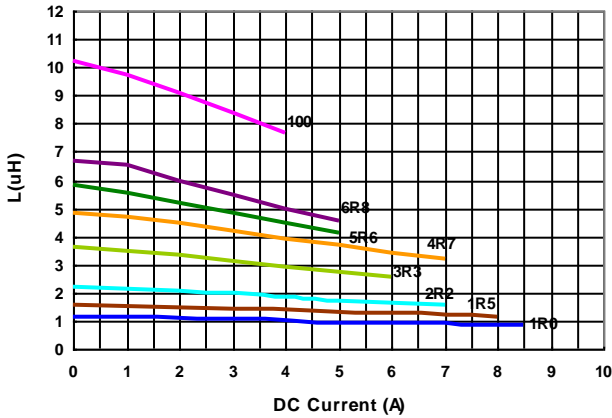

Temperature Change v.s DC Current

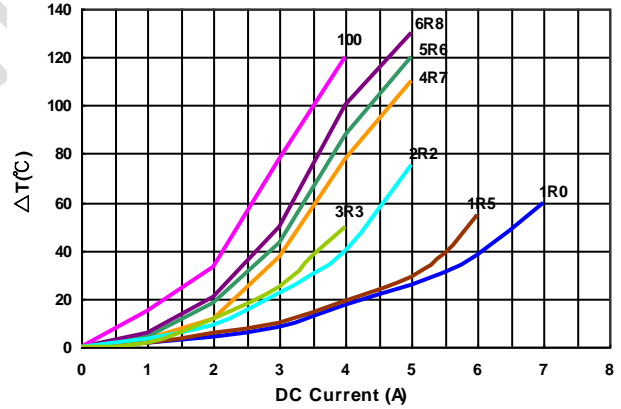

Molding Power Choke – MHCC/MHCI Series

Electrical Characteristics

Part Number	Inductance (uH)	Tolerance (±%)	Test Frequency (kHz)	RDC (mΩ)Max	Isat (A)Typ.	Irms (A)Typ.
MHCI05030-R20M-R8	0.20	20	100	3.9	14.5	17.0
MHCI05030-R47M-R8	0.47	20	100	8	14	10.0
MHCI05030-R68M-R8	0.68	20	100	12	14	8.0
MHCI05030-1R0M-R8	1.0	20	100	15	11	7.0
MHCI05030-1R2M-R8	1.2	20	100	15	11	6.5
MHCI05030-1R5M-R8	1.5	20	100	25	10	6.0
MHCI05030-2R2M-R8	2.2	20	100	35	8	5.0
MHCI05030-3R3M-R8	3.3	20	100	46	7	4.5
MHCI05030-4R7M-R8	4.7	20	100	60	6	4.0
MHCI05030-6R8M-R8	6.8	20	100	110	5	3.0
MHCI05030-100M-R8	10	20	100	126	4.5	1.5

Note: When ordering, please specify tolerance code. Tolerance: M=±20%

- Operating temperature range - 55°C ~ 125°C(Including self - temperature rise)
- Isat for Inductance drop 30% from its value without current
- I rms for a 40°C temperature rise from 25°C ambient with current
- Absolute maximum voltage 30VDC
- Measure Equipment :
L : WK 3260B or WK 6500P, 100kHz 0.5V
RDC : CHEN HWA 502 or CHEN HWA 46502B

Test Instruments : WK3260B Impedance / Material Analyzer

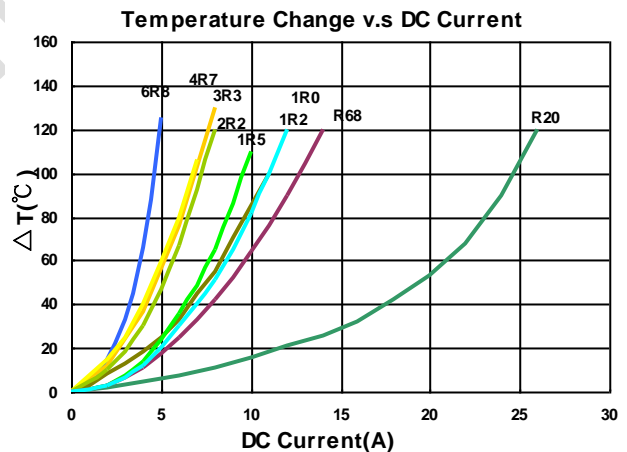
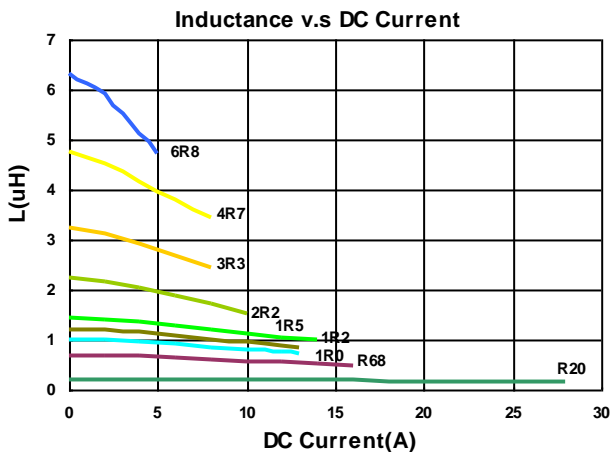

Molding Power Choke – MHCC/MHCI Series

Electrical Characteristics

Part Number	Inductance (uH)	Tolerance (±%)	Test Frequency (kHz)	RDC (mΩ) Max	Isat (A)Typ.	Irms (A)Typ.
MHCI06012-4R7M-R8A	4.7	20	100	122	3.5	2.5
MHCI06012-6R8M-R8A	6.8	20	100	210	2.8	2.2

Note: When ordering, please specify tolerance code. Tolerance: M=±20%

- Operating temperature range - 55°C ~ 125°C(Including self - temperature rise)
- Isat for Inductance drop 30% from its value without current
- I rms for a 40°C temperature rise from 25°C ambient with current
- Absolute maximum voltage 30VDC
- Measure Equipment :
L : WK 3260B or WK 6500P, 100kHz 0.5V
RDC : CHEN HWA 502 or CHEN HWA 46502B

Test Instruments : WK3260B Impedance / Material Analyzer

Inductance vs DC Current

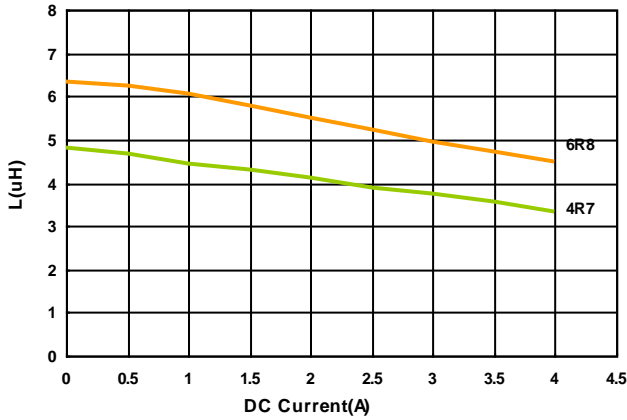

Temperature Change v.s DC Current

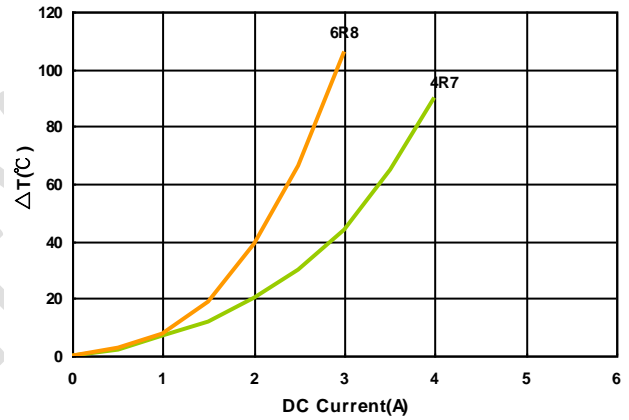

Molding Power Choke – MHCC/MHCI Series

Electrical Characteristics

Part Number	Inductance (uH)	Tolerance (±%)	Test Frequency (kHz)	RDC (mΩ)Max	Isat (A)Typ.	Irms (A)Typ.
MHCI06015-1R0M-R8A	1.0	20	100	21	9.0	5.5
MHCI06015-3R3M-R8A	3.3	20	100	63	5.5	3.3
MHCI06015-100M-R8A	10	20	100	175	3.0	2.0

Note: When ordering, please specify tolerance code. Tolerance: M=±20%

- Operating temperature range - 55°C ~ 125°C(Including self - temperature rise)
- Isat for Inductance drop 30% from its value without current
- I rms for a 40°C temperature rise from 25°C ambient with current
- Absolute maximum voltage 30VDC
- Measure Equipment :
 L : WK 3260B or WK 6500P, 100kHz 0.5V
 RDC : CHEN HWA 502 or CHEN HWA 46502B

Test Instruments : WK3260B Impedance / Material Analyzer

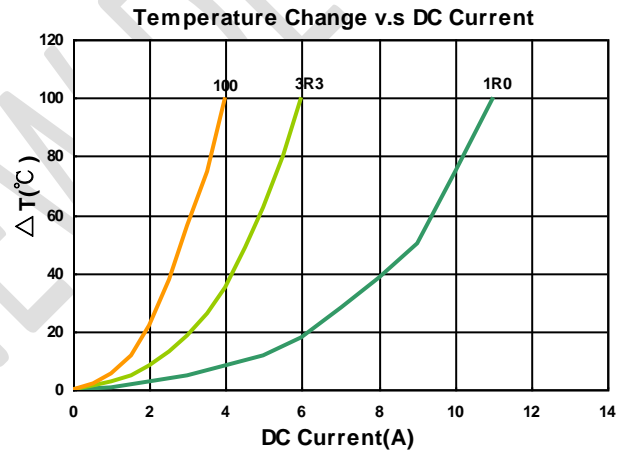
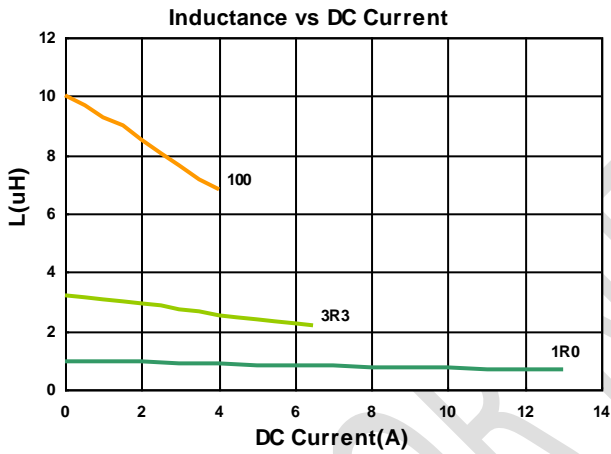

Molding Power Choke – MHCC/MHCI Series

Electrical Characteristics

Part Number	Inductance (uH)	Tolerance (±%)	Test Frequency (kHz)	RDC (mΩ)Max	Isat (A)Typ.	Irms (A)Typ.
MHCI06015-2R2M-R8	2.2	20	100	54	6.0	3.5
MHCI06015-3R3M-R8	3.3	20	100	63	5.5	3.3
MHCI06015-4R7M-R8	4.7	20	100	105	4.5	3.2
MHCI06015-6R8M-R8	6.8	20	100	140	4.0	2.5

Note: When ordering, please specify tolerance code. Tolerance: M=±20%

- Operating temperature range - 55°C ~ 125°C(Including self - temperature rise)
- Isat for Inductance drop 30% from its value without current
- I rms for a 40°C temperature rise from 25°C ambient with current
- Absolute maximum voltage 30VDC
- Measure Equipment :
 L : WK 3260B or WK 6500P, 100kHz 0.5V
 RDC : CHEN HWA 502 or CHEN HWA 46502B

Test Instruments : WK3260B Impedance / Material Analyzer

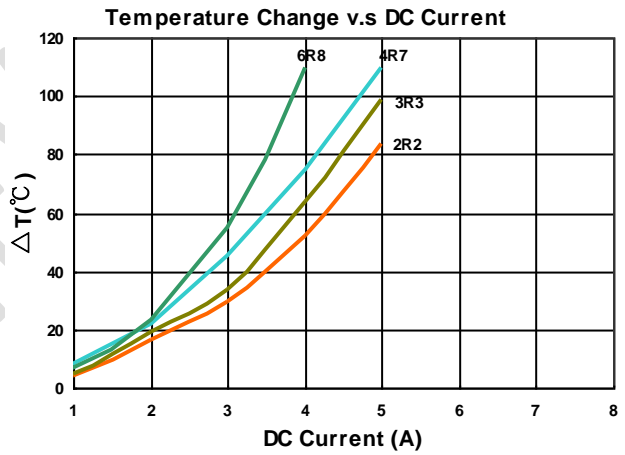
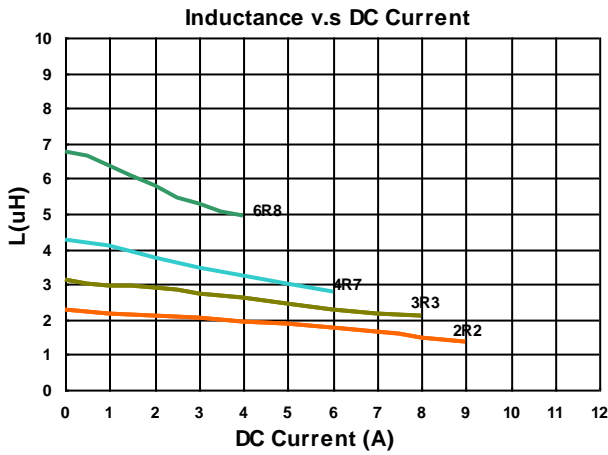

Molding Power Choke – MHCC/MHCI Series

Electrical Characteristics

Part Number	Inductance (uH)	Tolerance (±%)	Test Frequency (kHz)	RDC (mΩ)Max	Isat (A)Typ.	Irms (A)Typ.
MHCI06018-R22M-R8A	0.22	20	100	5.2	29	14
MHCI06018-R33M-R8A	0.33	20	100	6.8	22	12
MHCI06018-R47M-R8A	0.47	20	100	8.4	18	11
MHCI06018-R68M-R8A	0.68	20	100	12.7	17	9
MHCI06018-1R0M-R8A	1.0	20	100	17	14	7
MHCI06018-1R5M-R8A	1.5	20	100	26	12	6.5
MHCI06018-2R2M-R8A	2.2	20	100	35	10	6.0
MHCI06018-4R7M-R8A	4.7	20	100	70	5	3.5
MHCI06018-6R8M-R8A	6.8	20	100	110	3.5	2.8
MHCI06018-100M-R8A	10	20	100	155	2.5	2.3

Note: When ordering, please specify tolerance code. Tolerance: M=±20%

- Operating temperature range - 55°C ~ 125°C(Including self - temperature rise)
- Isat for Inductance drop 30% from its value without current
- I rms for a 40°C temperature rise from 25°C ambient with current
- Absolute maximum voltage 30VDC
- Measure Equipment :
L : WK 3260B or WK 6500P, 100kHz 0.5V
RDC : CHEN HWA 502 or CHEN HWA 46502B

Test Instruments : WK3260B Impedance / Material Analyzer

Inductance vs DC Current

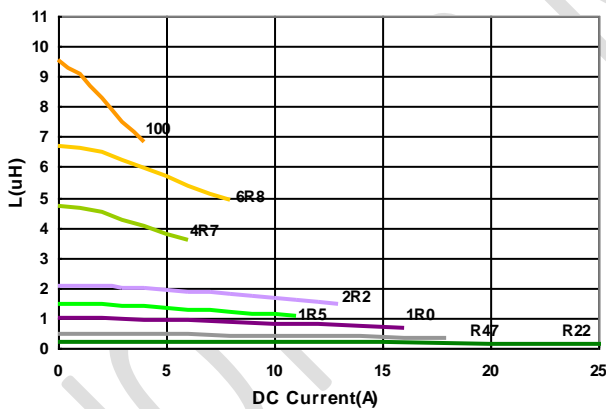

Temperature Change v.s DC Current

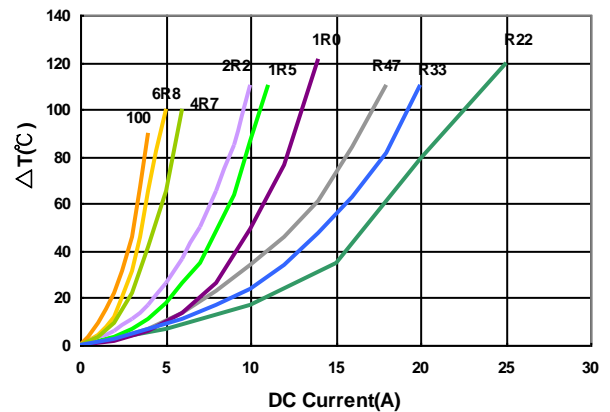

Molding Power Choke – MHCC/MHCI Series

Electrical Characteristics

Part Number	Inductance (uH)	Tolerance (±%)	Test Frequency (kHz)	RDC (mΩ)Max	Isat (A)Typ.	Irms (A)Typ.
MHCI06024-R22M-R8A	0.22	20	100	3.2	34	21
MHCI06024-R33M-R8A	0.33	20	100	4.1	24.5	18
MHCI06024-R47M-R8A	0.47	20	100	5.1	22	15
MHCI06024-1R0M-R8A	1.0	20	100	13.5	16	9
MHCI06024-1R5M-R8A	1.5	20	100	20	15	9
MHCI06024-2R2M-R8A	2.2	20	100	28	11	7
MHCI06024-3R3M-R8A	3.3	20	100	39	10	5.5
MHCI06024-4R7M-R8A	4.7	20	100	50	10	5.0
MHCI06024-6R8M-R8A	6.8	20	100	70	6.0	4.0
MHCI06024-100M-R8A	10	20	100	101	4.0	3.1
MHCI06024-150M-R8A	15	20	100	160	3.3	2.5

Note: When ordering, please specify tolerance code. Tolerance: M=±20%

- Operating temperature range - 55°C ~ 125°C(Including self - temperature rise)
- Isat for Inductance drop 30% from its value without current
- I rms for a 40°C temperature rise from 25°C ambient with current
- Absolute maximum voltage 30VDC
- Measure Equipment :
L : WK 3260B or WK 6500P, 100kHz 0.5V
RDC : CHEN HWA 502 or CHEN HWA 46502B

Test Instruments : WK3260B Impedance / Material Analyzer



Molding Power Choke – MHCC/MHCI Series

Electrical Characteristics

Part Number	Inductance (uH)	Tolerance (±%)	Test Frequency (kHz)	RDC (mΩ)Max	Isat (A)Typ.	Irms (A)Typ.
MHCI06030-R10M-R8A	0.10	20	100	1.7	60	32.5
MHCI06030-R15M-R8A	0.15	20	100	2.5	40	30
MHCI06030-R22M-R8A	0.22	20	100	3.0	34	23
MHCI06030-R33M-R8A	0.33	20	100	3.5	25	21
MHCI06030-R36M-R8A	0.36	20	100	3.9	24	20
MHCI06030-R47M-R8A	0.47	20	100	4.1	20	18
MHCI06030-R56M-R8A	0.56	20	100	4.5	18	16.5
MHCI06030-R68M-R8A	0.68	20	100	5.3	17	16
MHCI06030-R82M-R8A	0.82	20	100	6.0	16	14
MHCI06030-1R0M-R8A	1.0	20	100	7.4	15	12
MHCI06030-1R2M-R8A	1.2	20	100	10	14	10
MHCI06030-1R5M-R8A	1.5	20	100	12.1	14	10
MHCI06030-2R2M-R8A	2.2	20	100	15	10	8
MHCI06030-3R3M-R8A	3.3	20	100	22	9.5	6.5
MHCI06030-4R7M-R8A	4.7	20	100	33	6.5	5.5
MHCI06030-6R8M-R8A	6.8	20	100	50	6	4.5
MHCI06030-100M-R8A	10	20	100	68	5.5	4

Note: When ordering, please specify tolerance code. Tolerance: M=±20%

- Operating temperature range - 55°C ~ 125°C(Including self - temperature rise)
- Isat for Inductance drop 30% from its value without current
- Irms for a 40°C temperature rise from 25°C ambient with current
- Absolute maximum voltage 30VDC
- Measure Equipment :
 L : WK 3260B or WK 6500P, 100kHz 0.5V
 RDC : CHEN HWA 502 or CHEN HWA 46502B

Test Instruments : WK3260B Impedance / Material Analyzer

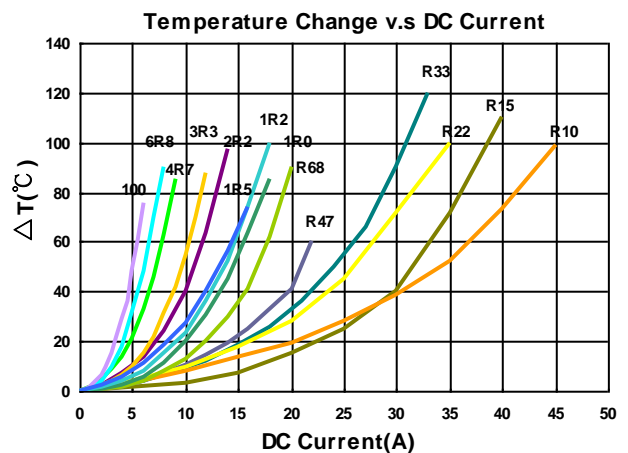
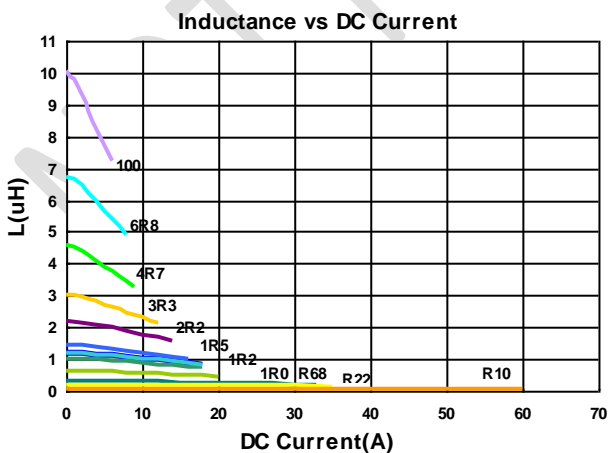

Please be sure to request approval specifications that provide further details of the products. Kindly note that the content of these specifications are subject to change or may be discontinued without prior notice. This product may not be designed/used in medical or high risk applications without Chilisin approval. Please contact our sales department before ordering.

Molding Power Choke – MHCC/MHCI Series

Electrical Characteristics

Part Number	Inductance (uH)	Tolerance (±%)	Test Frequency (kHz)	RDC (mΩ) Max	Isat (A)Typ.	Irms (A)Typ.
MHCI06030-R10M-R8	0.10	20	100	1.5	45	37
MHCI06030-R22M-R8	0.22	20	100	2.8	40	23
MHCI06030-R33M-R8	0.33	20	100	4.2	33	20
MHCI06030-R47M-R8	0.47	20	100	5.5	27	16.5
MHCI06030-R56M-R8	0.56	20	100	5.5	27	16.5
MHCI06030-R68M-R8	0.68	20	100	6.3	24	15
MHCI06030-R82M-R8	0.82	20	100	8.0	23	13
MHCI06030-1R0M-R8	1.0	20	100	10	22	12
MHCI06030-1R5M-R8	1.5	20	100	15	18	9.5
MHCI06030-1R8M-R8	1.8	20	100	15	14	9.5
MHCI06030-2R2M-R8	2.2	20	100	20	14	8.5
MHCI06030-3R3M-R8	3.3	20	100	35	12	6.0
MHCI06030-4R7M-R8	4.7	20	100	40	9	5.5
MHCI06030-5R6M-R8	5.6	20	100	40	8	5.5
MHCI06030-6R8M-R8	6.8	20	100	60	8	4.5
MHCC06030-8R2M-R7	8.2	20	100	60	6	4.5
MHCC06030-100M-R7	10	20	100	68	5.5	4.0
MHCI06030-150M-R8	15	20	100	122	5.0	3.0
MHCI06030-220M-R8	22	20	100	145	3.2	3.0
MHCI06030-330M-R8	33	20	100	270	3.0	2.0

Note: When ordering, please specify tolerance code. Tolerance: M=±20%

- Operating temperature range - 55°C ~ 125°C(Including self - temperature rise)
- Isat for Inductance drop 30% from its value without current
- I rms for a 40°C temperature rise from 25°C ambient with current
- Absolute maximum voltage 30VDC
- Measure Equipment :
L : WK 3260B or WK 6500P, 100kHz 0.5V
RDC : CHEN HWA 502 or CHEN HWA 46502B

Test Instruments : WK3260B Impedance / Material Analyzer

Inductance v.s DC Current

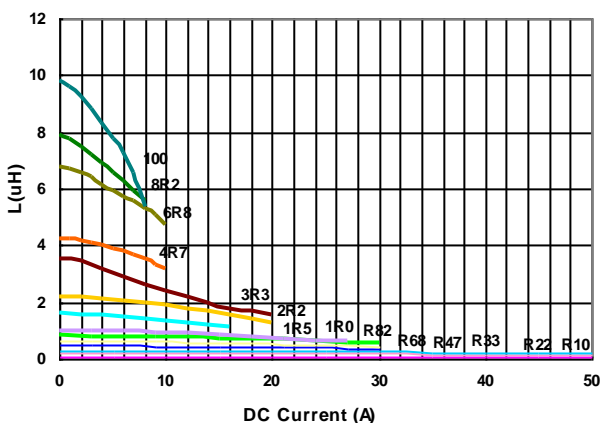

Temperature Change v.s DC Current

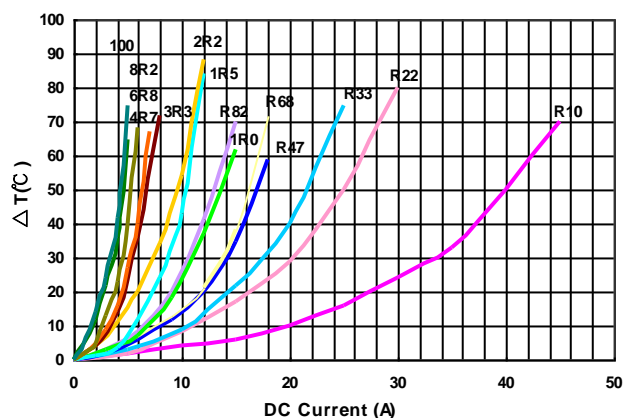

Please be sure to request approval specifications that provide further details of the products. Kindly note that the content of these specifications are subject to change or may be discontinued without prior notice. This product may not be designed/used in medical or high risk applications without Chilisin approval. Please contact our sales department before ordering.

Molding Power Choke – MHCC/MHCI Series

Electrical Characteristics

Part Number	Inductance (uH)	Tolerance (±%)	Test Frequency (kHz)	RDC (mΩ) Max	Isat (A)Typ.	Irms (A)Typ.
MHCI06050-R56M-R8A	0.56	20	100	3.3	20	20
MHCI06050-1R0M-R8A	1.0	20	100	6.5	15	13
MHCI06050-2R2M-R8A	2.2	20	100	12.5	12	8
MHCI06050-3R3M-R8A	3.3	20	100	20.9	9	7
MHCI06050-4R7M-R8A	4.7	20	100	25.0	7	6.5

Note: When ordering, please specify tolerance code. Tolerance: M=±20%

- Operating temperature range - 55°C ~ 125°C(Including self - temperature rise)
- Isat for Inductance drop 30% from its value without current
- I rms for a 40°C temperature rise from 25°C ambient with current
- Absolute maximum voltage 30VDC
- Measure Equipment :
 L : WK 3260B or WK 6500P, 100kHz 0.5V
 RDC : CHEN HWA 502 or CHEN HWA 46502B

Test Instruments : WK3260B Impedance / Material Analyzer

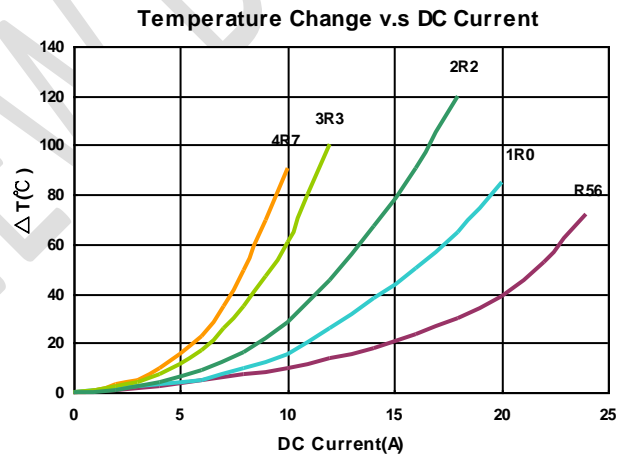
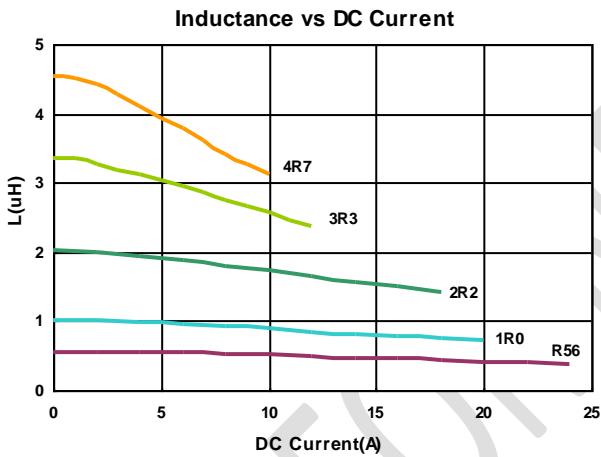

Molding Power Choke – MHCC/MHCI Series

Electrical Characteristics

Part Number	Inductance (uH)	Tolerance (±%)	Test Frequency (kHz)	RDC (mΩ) Max	Isat (A)Typ.	Irms (A)Typ.
MHCC10030-R33M-R7A	0.33	20	100	1.6	32	23
MHCC10030-1R0M-R7A	1.0	20	100	6.0	21	15
MHCC10030-3R3M-R7A	3.3	20	100	16.0	14	9

Note: When ordering, please specify tolerance code. Tolerance: M=±20%

- Operating temperature range - 55°C ~ 125°C(Including self - temperature rise)
- Isat for Inductance drop 30% from its value without current
- I rms for a 40°C temperature rise from 25°C ambient with current
- Absolute maximum voltage 30VDC
- Measure Equipment :
 L : WK 3260B or WK 6500P, 100kHz 0.5V
 RDC : CHEN HWA 502 or CHEN HWA 46502B

Test Instruments : WK3260B Impedance / Material Analyzer

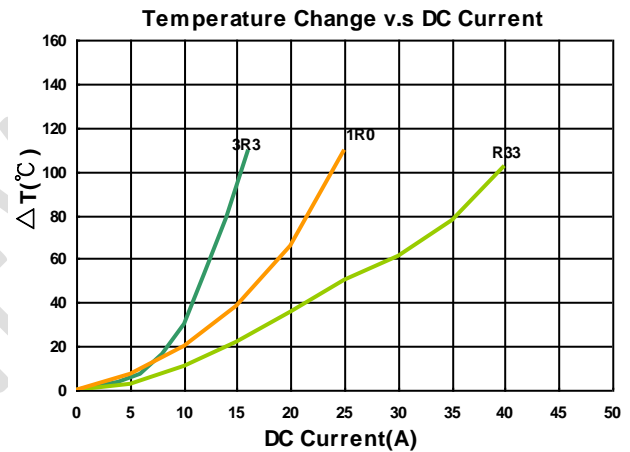
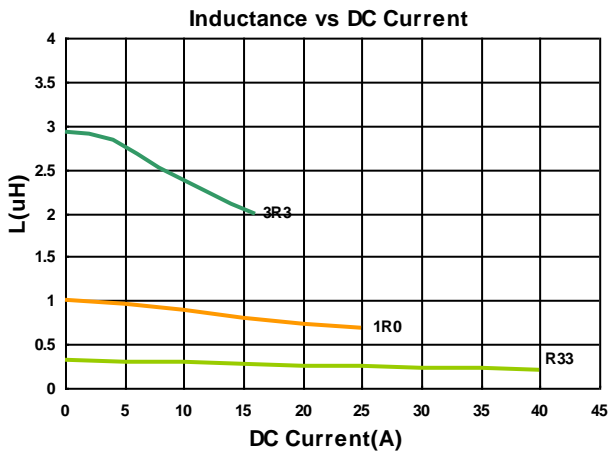

Molding Power Choke – MHCC/MHCI Series

Electrical Characteristics

Part Number	Inductance (uH)	Tolerance (±%)	Test Frequency (kHz)	RDC (mΩ) Max	Isat (A)Typ.	Irms (A)Typ.
MHCC10040-R22M-R7	0.22	20	100	0.6	45	35
MHCC10040-R36M-R7	0.36	20	100	1.2	42	34
MHCC10040-R45M-R7	0.45	20	100	1.2	38	33
MHCC10040-R47M-R7	0.47	20	100	1.2	38	33
MHCC10040-R56M-R7	0.56	20	100	1.55	32	27
MHCC10040-R68M-R7	0.68	20	100	1.55	30	27
MHCC10040-R90M-R7	0.90	20	100	3.0	20	22
MHCC10040-1R0M-R7	1.0	20	100	3.1	26	20
MHCC10040-1R5M-R7	1.5	20	100	4.2	22	16
MHCC10040-1R8M-R7	1.8	20	100	5	16	15.3
MHCC10040-2R2M-R7	2.2	20	100	7	16	14
MHCC10040-3R3M-R7	3.3	20	100	13.2	12	11
MHCC10040-4R7M-R7	4.7	20	100	16.5	12	9
MHCC10040-6R8M-R7	6.8	20	100	25	10	6
MHCC10040-8R2M-R7	8.2	20	100	30	9	6
MHCC10040-100M-R7	10	20	100	30	7	6.5
MHCC10040-150M-R7	15	20	100	45	6	6.25
MHCC10040-220M-R7	22	20	100	64	4.5	4.5

Note: When ordering, please specify tolerance code. Tolerance: M=±20%

- Operating temperature range - 55°C ~ 125°C(Including self - temperature rise)
- Isat for Inductance drop 30% from its value without current
- I rms for a 40°C temperature rise from 25°C ambient with current
- Absolute maximum voltage 30VDC
- Measure Equipment :
 L : WK 3260B or WK 6500P, 100kHz 0.5V
 RDC : CHEN HWA 502 or CHEN HWA 46502B

Test Instruments : WK3260B Impedance / Material Analyzer

Inductance v.s DC Current

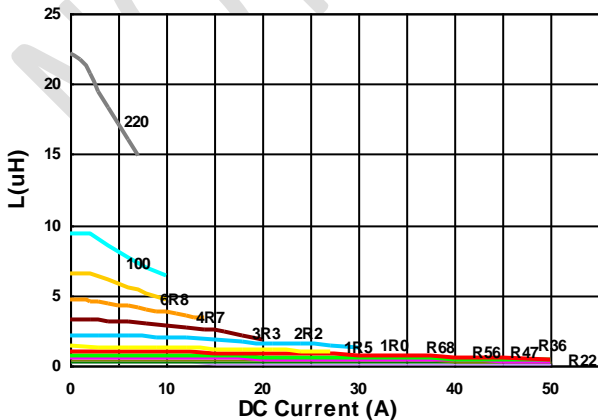

Temperature Change v.s DC Current

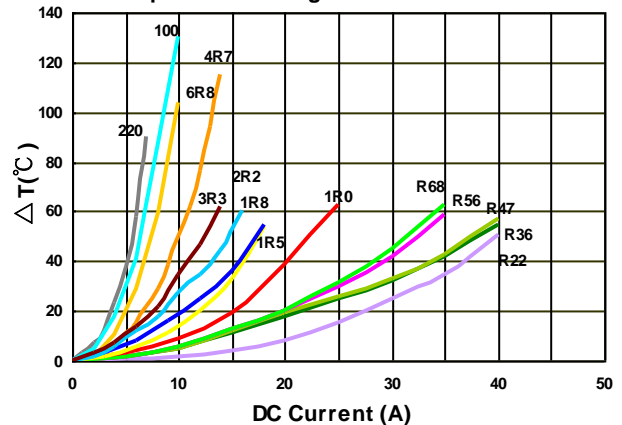

Molding Power Choke – MHCC/MHCI Series

Electrical Characteristics

Part Number	Inductance (uH)	Tolerance (±%)	Test Frequency (kHz)	RDC (mΩ) Max	Isat (A)Typ.	Irms (A)Typ.
MHCC12050-R47M-R7	0.47	20	100	1.2	46	37
MHCC12050-1R0M-R7	1.0	20	100	2.5	37	29
MHCC12050-1R5M-R7	1.5	20	100	3.0	28	28
MHCC12050-4R7M-R7	4.7	20	100	11.5	16	11
MHCC12050-6R8M-R7	6.8	20	100	22	14	9
MHCC12050-100M-R7	10	20	100	35	13	7

Note: When ordering, please specify tolerance code. Tolerance: M=±20%

- Operating temperature range - 55°C ~ 125°C(Including self - temperature rise)
- Isat for Inductance drop 30% from its value without current
- I rms for a 40°C temperature rise from 25°C ambient with current
- Absolute maximum voltage 30VDC
- Measure Equipment :
 L : WK 3260B or WK 6500P, 100kHz 0.5V
 RDC : CHEN HWA 502 or CHEN HWA 46502B

Test Instruments : WK3260B Impedance / Material Analyzer

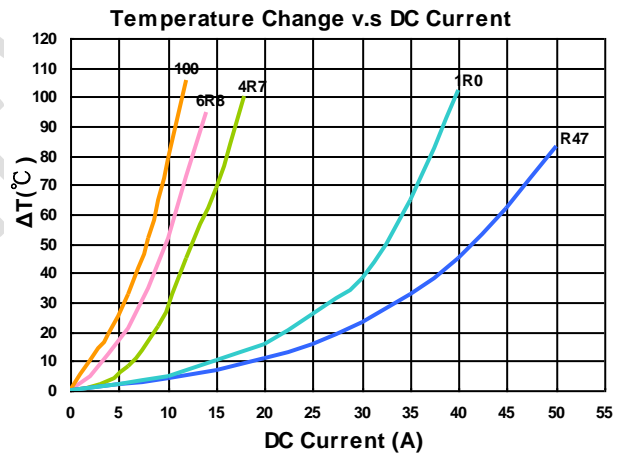
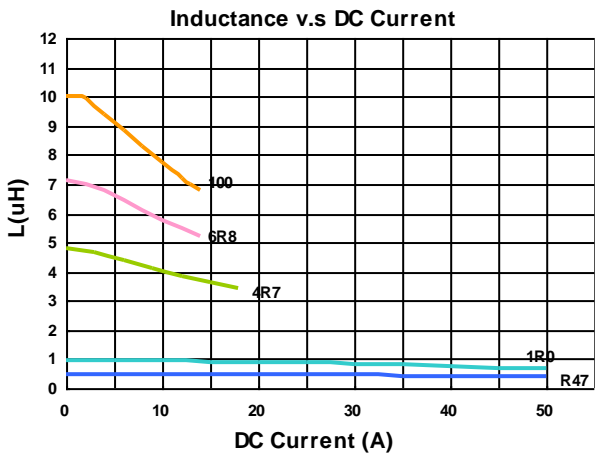

Molding Power Choke – MHCC/MHCI Series

Electrical Characteristics

Part Number	Inductance (uH)	Tolerance (±%)	Test Frequency (kHz)	RDC (mΩ) Max	Isat (A)Typ.	Irms (A)Typ.
MHCC12060-100M-R7A	10	20	100	20.7	12.5	10
MHCC12060-150M-R7A	15	20	100	29.0	9.0	6.0
MHCC12060-220M-R7A	22	20	100	39.5	7.5	5.0
MHCC12060-330M-R7A	33	20	100	75	6.0	4.0

Note: When ordering, please specify tolerance code. Tolerance: M=±20%

- Operating temperature range - 55°C ~ 125°C(Including self - temperature rise)
- Isat for Inductance drop 30% from its value without current
- I rms for a 40°C temperature rise from 25°C ambient with current
- Absolute maximum voltage 30VDC
- Measure Equipment :
 L : WK 3260B or WK 6500P, 100kHz 0.5V
 RDC : CHEN HWA 502 or CHEN HWA 46502B

Test Instruments : WK3260B Impedance / Material Analyzer

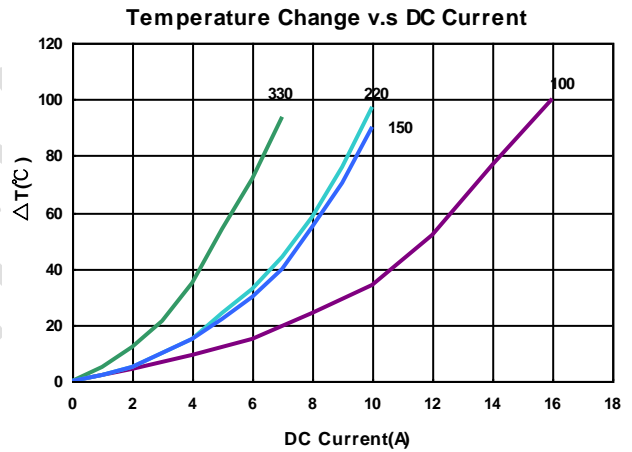
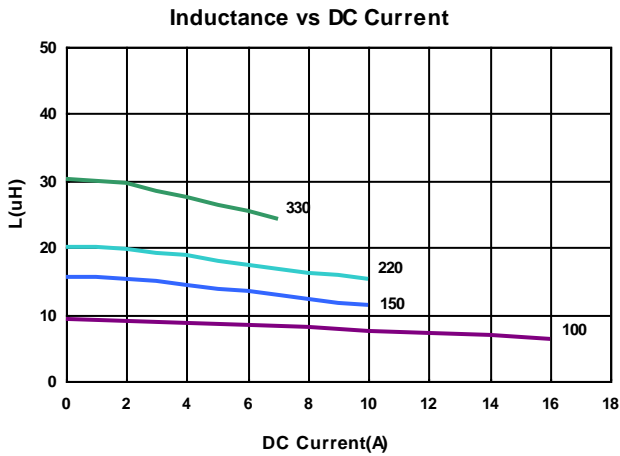

Molding Power Choke – MHCC/MHCI Series

Packaging Specifications

Tape Dimensions

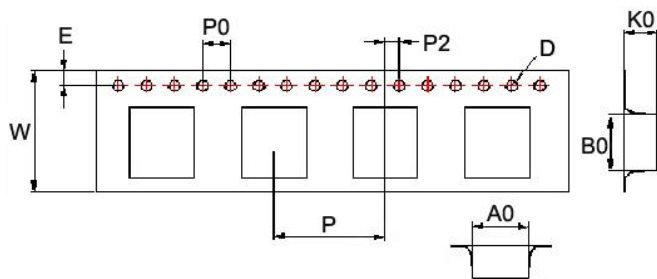

Tape Material

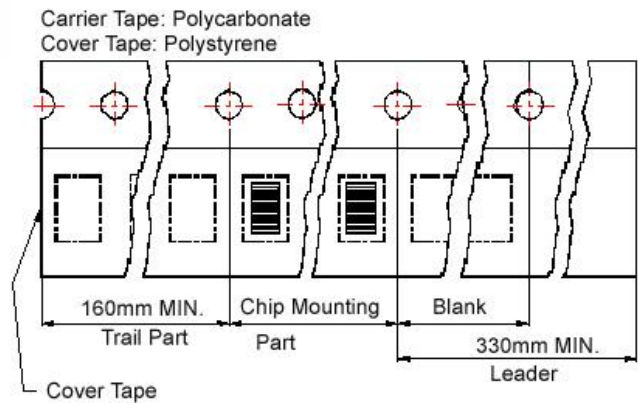

Reel Dimensions

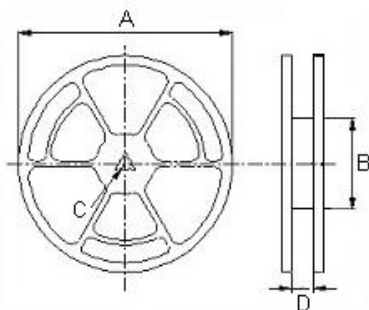

Dimensions in mm

TYPE	Tape Dimensions									Reel Dimensions				Quantity PCS / REEL
	A0	B0	K0	D	E	W	P	P0	P2	A	B	C	D	
04012	4.6	5.0	1.5	1.55	1.75	12	8	4	2	330	100	13	13.4	2000
04015	4.4	4.9	1.8	1.55	1.75	12	8	4	2	330	100	13	13.4	2000
04020	4.3	4.9	2.4	1.55	1.75	12	8	4	2	330	100	13	13.4	2000
05012	5.9	6.2	1.5	1.55	1.75	16	12	4	2	330	100	13	16.0	1000
05015	5.7	6.1	1.9	1.55	1.75	16	12	4	2	330	100	13	16.0	1000
05018	5.9	6.2	2.2	1.55	1.75	16	12	4	2	330	100	13	16.0	1000
05020	5.7	5.9	2.4	1.55	1.75	16	12	4	2	330	100	13	16.0	1000
05030	5.9	6.2	3.4	1.55	1.75	16	12	4	2	330	100	13	16.0	1000
06012	6.9	7.6	1.6	1.55	1.75	16	12	4	2	330	100	13	16.0	1000
06015	6.9	7.6	1.9	1.55	1.75	16	12	4	2	330	100	13	16.0	1000
06018	6.9	7.6	2.2	1.55	1.75	16	12	4	2	330	100	13	16.0	1000
06024	6.9	7.6	2.9	1.55	1.75	16	12	4	2	330	100	13	16.0	1000
06030	6.9	7.6	3.4	1.55	1.75	16	12	4	2	330	100	13	16.0	1000
06050	6.9	7.6	5.4	1.55	1.75	16	12	4	2	330	100	13	16.0	1000
10030	10.6	11.7	3.25	1.55	1.75	24	16	4	2	330	100	13	24.4	500
10040	10.6	11.7	4.25	1.55	1.75	24	16	4	2	330	100	13	24.4	500
12050	13	14	5.25	1.55	1.75	24	16	4	2	330	100	13	24.4	500
12060	13	14	6.25	1.55	1.75	24	16	4	2	330	100	13	24.4	500

X-ON Electronics

Largest Supplier of Electrical and Electronic Components

Click to view similar products for [Fixed Inductors](#) category:

Click to view products by [Chilisin](#) manufacturer:

Other Similar products are found below :

[CR32NP-151KC](#) [CR32NP-180KC](#) [CR32NP-181KC](#) [CR32NP-1R5MC](#) [CR32NP-390KC](#) [CR32NP-3R9MC](#) [CR32NP-680KC](#) [CR32NP-820KC](#) [CR32NP-8R2MC](#) [CR43NP-390KC](#) [CR43NP-560KC](#) [CR43NP-680KC](#) [CR54NP-181KC](#) [CR54NP-470LC](#) [CR54NP-820KC](#) [CR54NP-8R5MC](#) [70F224AI](#) [MGDQ4-00004-P](#) [MHL1ECTTP18NJ](#) [MHQ1005P10NJ](#) [MHQ1005P1N0S](#) [MHQ1005P2N4S](#) [MHQ1005P3N6S](#) [MHQ1005P5N1S](#) [MHQ1005P8N2J](#) [PE-51506NL](#) [PE-53601NL](#) [PE-53602NL](#) [PE-53630NL](#) [PE-53824SNLT](#) [PE-92100NL](#) [PG0434.801NLT](#) [PG0936.113NLT](#) [9220-20](#) [9310-16](#) [PM06-2N7](#) [PM06-39NJ](#) [A01TK](#) [1206CS-471XJ](#) [HC2LP-R47-R](#) [HC2-R47-R](#) [HC3-2R2-R](#) [HCF1305-3R3-R](#) [1206CS-151XG](#) [RCH664NP-140L](#) [RCH664NP-4R7M](#) [RCH8011NP-221L](#) [RCP1317NP-332L](#) [RCP1317NP-391L](#) [RCR1010NP-470M](#)