

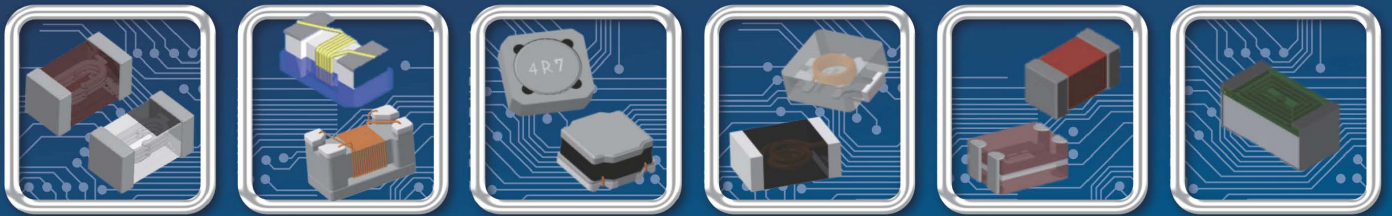

Inductive Solution Provider for Power, EMI and RF.

Inductors SMD Components



Multilayer Power Inductors



The MPx Series is a miniature type of multilayer power inductor constructed using low-loss ferrite material to support high-speed switching frequencies. The compact size and high efficiency is ideal for DC-DC converter applications in space-limited boards.

Features

- RoHS, Halogen Free and REACH Compliance
- Small size
- Low profile
- High current
- Magnetically shielded configuration allowing for high density mounting

Applications

- DC-DC converters
- Power modules
- Cellular phones
- DSC, PND, DVD
- Wireless card and other electronic devices

Product Identification

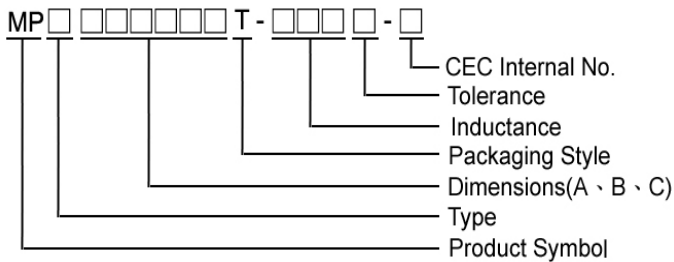

- Product Symbol : MPA, MPB, MPE
- Type : A : General , B : Low RDC , E: High Isat
- Packaging : T : Tape and Reel , B : Bulk
- Tolerance : M = $\pm 20\%$, T = $\pm 30\%$

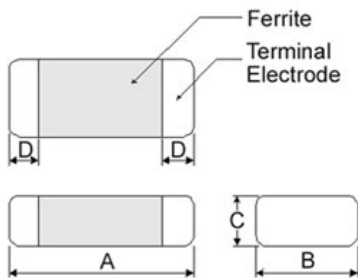

Dimensions in mm

TYPE	A	B	C	D
160805	1.6 \pm 0.15	0.8 \pm 0.15	0.5 \pm 0.05	0.3 \pm 0.2
160806	1.6 \pm 0.15	0.8 \pm 0.15	0.6 \pm 0.15	0.3 \pm 0.2
160808	1.6 \pm 0.15	0.8 \pm 0.15	0.8 \pm 0.15	0.3 \pm 0.2
201205	2.0 \pm 0.20	1.25 \pm 0.20	0.55 Max	0.5 \pm 0.3
201210	2.0 \pm 0.20	1.25 \pm 0.20	1.0 Max	0.5 \pm 0.3
201610	2.0 \pm 0.20	1.6 \pm 0.20	1.0 Max	0.5 \pm 0.3
252010	2.5 \pm 0.20	2.0 \pm 0.20	1.0 Max	0.6 \pm 0.2
252012	2.5 \pm 0.20	2.0 \pm 0.20	1.2 Max	0.6 \pm 0.2

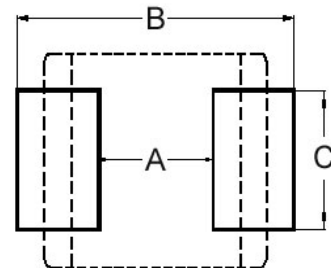

Dimensions in mm

TYPE	A	B	C
160805	0.7 ~ 0.8	1.8 ~ 2.0	0.6 ~ 0.8
160806	0.7 ~ 0.8	1.8 ~ 2.0	0.6 ~ 0.8
160808	0.7 ~ 0.8	1.8 ~ 2.0	0.6 ~ 0.8
201205	0.8 ~ 1.2	2.3 ~ 2.9	1.0 ~ 1.4
201210	0.8 ~ 1.2	2.3 ~ 2.9	1.0 ~ 1.4
201610	0.8 ~ 1.2	2.1 ~ 2.7	1.6 ~ 2.0
252010	1.3 ~ 1.9	2.7 ~ 3.5	2.0 ~ 2.6
252012	1.3 ~ 1.9	2.7 ~ 3.5	2.0 ~ 2.6

Electrical Characteristics

MPA : General Series

Part Number	Inductance (uH)	Tolerance (±%)	Test Frequency (MHz)	RDC (Ω) ±30%	Rated current (mA) Max
MPA201210T-1R0□-N	1.0	20, 30	1	0.18	1100
MPA201210T-1R5□-N	1.5	20, 30	1	0.19	1000
MPA201210T-2R2□-N	2.2	20, 30	1	0.22	900
MPA201210T-3R3□-N	3.3	20, 30	1	0.25	700
MPA201210T-4R7□-N	4.7	20, 30	1	0.35	600

Note: When ordering, please specify tolerance code. Tolerance: M=±20% , T=±30%

- Operating temperature range - 55°C ~ 125°C(Including self - temperature rise)
- Rated Current for a 40°C temperature rise from 25°C ambient with current
- Measure Equipment :
 L : Agilent HP4287A+16197A, 1MHz 200mV
 RDC : HP 4338B, or equivalent

Test Instruments : HP4287A Inductance / Material Analyzer

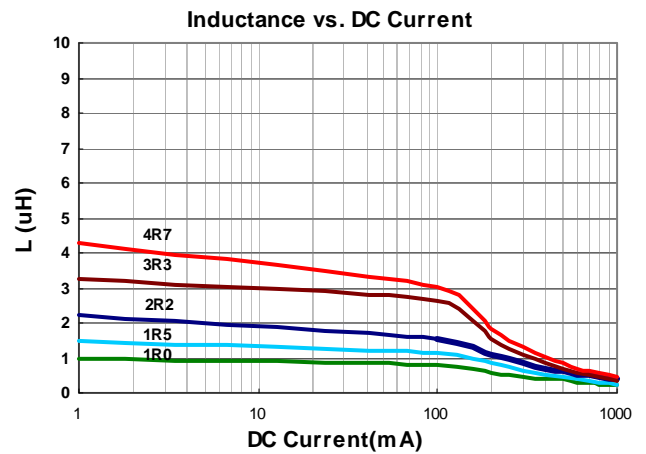
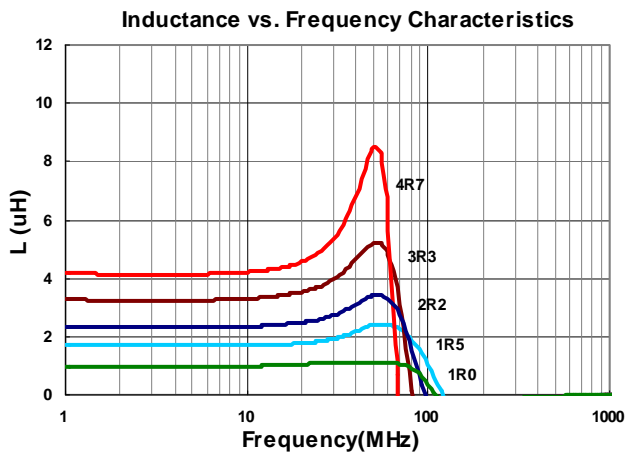

Please be sure to request approval specifications that provide further details of the products. Kindly note that the content of these specifications are subject to change or may be discontinued without advance notice. Please contact our sales department before ordering.

Electrical Characteristics

MPA : General Series

Part Number	Inductance (uH)	Tolerance (±%)	Test Frequency (MHz)	RDC (Ω) ±30%	Rated current (mA) Max
MPA252010T-1R0□-N	1.0	20, 30	1	0.11	1200
MPA252010T-1R5□-N	1.5	20, 30	1	0.13	1100
MPA252010T-2R2□-N	2.2	20, 30	1	0.15	1000
MPA252010T-3R3□-N	3.3	20, 30	1	0.18	1000
MPA252010T-4R7□-N	4.7	20, 30	1	0.25	900

Note: When ordering, please specify tolerance code. Tolerance: M=±20% , T=±30%

- Operating temperature range - 55°C ~ 125°C(Including self - temperature rise)
- Rated Current for a 40°C temperature rise from 25°C ambient with current
- Measure Equipment :
 L : Agilent HP4287A+16197A, 1MHz 200mV
 RDC : HP 4338B, or equivalent

Test Instruments : HP4287A Inductance / Material Analyzer

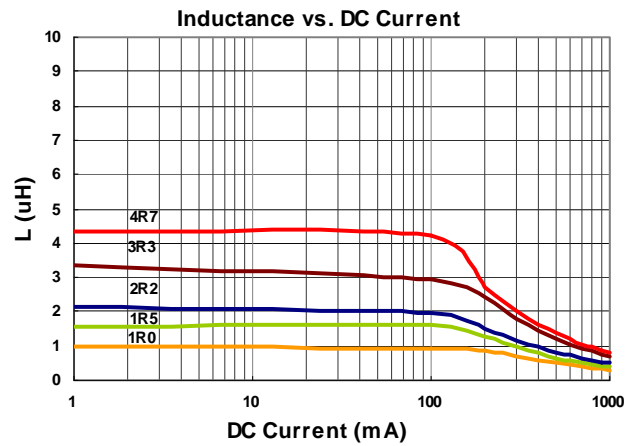
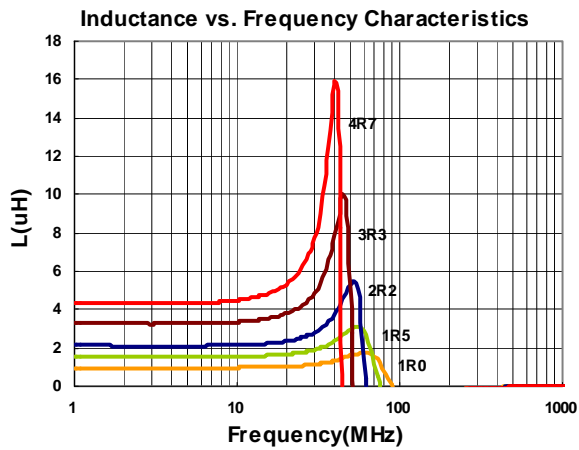

Electrical Characteristics

MPB : Low Profile Series

Part Number	Inductance (uH)	Tolerance (±%)	Test Frequency (MHz)	RDC (Ω) ±25%	Isat (mA) Max	Irms (mA) Max
MPB160805T-R47□-NA6	0.47	20, 30	3	0.15	420	1200
MPB160805T-1R0□-NA6	1.0	20, 30	3	0.20	180	1200
MPB160805T-1R5□-NA6	1.5	20, 30	3	0.22	130	1000
MPB160805T-2R2□-NA6	2.2	20, 30	3	0.24	100	1000

Note: When ordering, please specify tolerance code. Tolerance: M=±20% , T=±30%

- Operating temperature range - 55°C ~ 125°C(Including self - temperature rise)
- Isat for Inductance drop 30% from its value without current
- I rms for a 40°C temperature rise from 25°C ambient with current
- Measure Equipment :
 - L : Agilent HP4287A+16197A, 3MHz 200mV
 - RDC : HP 4338B, or equivalent

Test Instruments : HP4287A Inductance / Material Analyzer

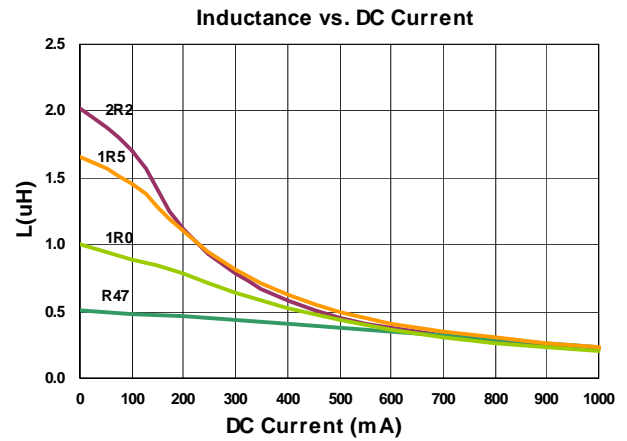
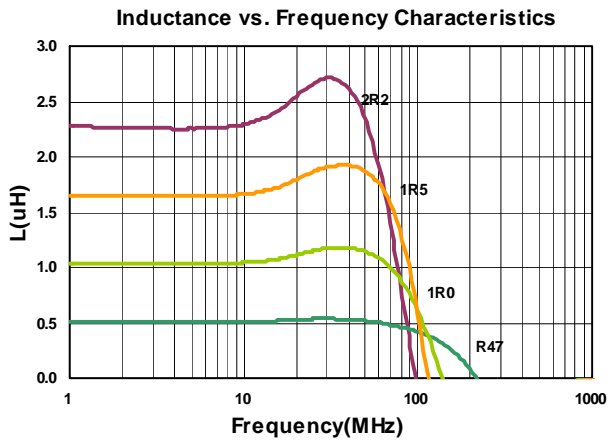

Please be sure to request approval specifications that provide further details of the products. Kindly note that the content of these specifications are subject to change or may be discontinued without advance notice. Please contact our sales department before ordering.

Electrical Characteristics

MPB : Low RDC Series

Part Number	Inductance (uH)	Tolerance (±%)	Test Frequency (MHz)	RDC (Ω) ±30%	Isat (mA) Max	Irms (mA) Max
MPB160808T-R47□-NA2	0.47	20, 30	3	0.15	400	1100
MPB160808T-1R0□-NA2	1.0	20, 30	3	0.20	200	950
MPB160808T-2R2□-NA2	2.2	20, 30	3	0.30	150	750

Note: When ordering, please specify tolerance code. Tolerance: M=±20% , T=±30%

- Operating temperature range - 55°C ~ 125°C(Including self - temperature rise)
- Isat for Inductance drop 30% from its value without current
- I rms for a 40°C temperature rise from 25°C ambient with current
- Measure Equipment :
 - L : Agilent HP4287A+16197A, 3MHz 200mV
 - RDC : HP 4338B, or equivalent

Test Instruments : HP4287A Inductance / Material Analyzer

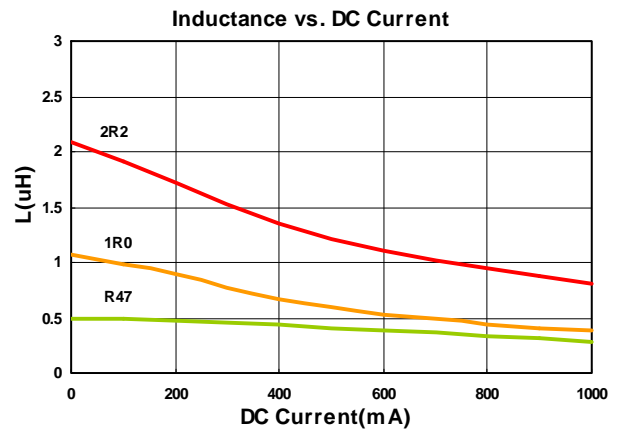
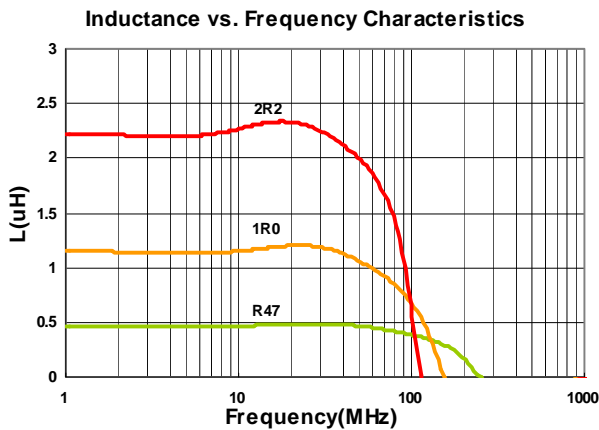

Please be sure to request approval specifications that provide further details of the products. Kindly note that the content of these specifications are subject to change or may be discontinued without advance notice. Please contact our sales department before ordering.

Electrical Characteristics

MPB : Low Profile Series

Part Number	Inductance (uH)	Tolerance (±%)	Test Frequency (MHz)	RDC (Ω) ±30%	Isat (mA) Max	Irms (mA) Max
MPB201205T-R47□-NA2	0.47	20, 30	3	0.11	900	1200
MPB201205T-1R0□-NA2	1.0	20, 30	3	0.16	300	900
MPB201205T-1R5□-NA2	1.5	20, 30	3	0.18	250	800
MPB201205T-2R2□-NA2	2.2	20, 30	3	0.29	200	600
MPB201205T-4R7□-NA2	4.7	20, 30	3	0.50	100	700

Note: When ordering, please specify tolerance code. Tolerance: M=±20% , T=±30%

- Operating temperature range - 55°C ~ 125°C(Including self - temperature rise)
- Isat for Inductance drop 30% from its value without current
- I rms for a 40°C temperature rise from 25°C ambient with current
- Measure Equipment :
 L : Agilent HP4287A+16197A, 3MHz 200mV
 RDC : HP 4338B, or equivalent

Test Instruments : HP4287A Inductance / Material Analyzer

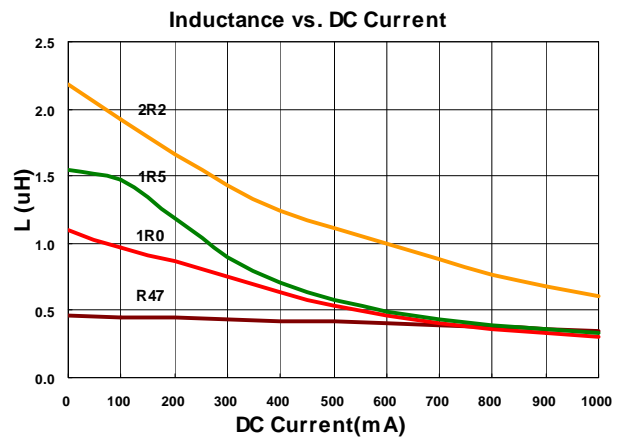
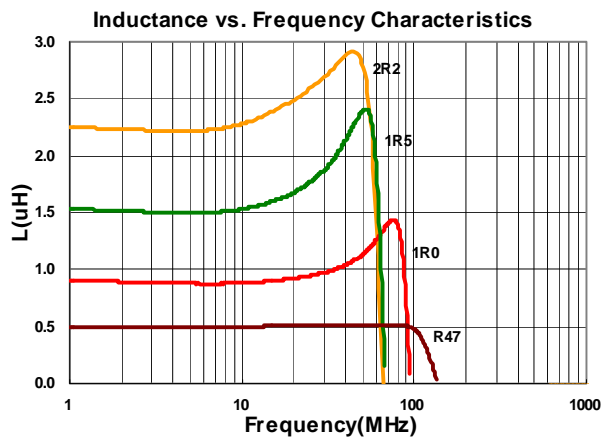

Please be sure to request approval specifications that provide further details of the products. Kindly note that the content of these specifications are subject to change or may be discontinued without advance notice. Please contact our sales department before ordering.

Electrical Characteristics

MPB : Low RDC Series

Part Number	Inductance (uH)	Tolerance (±%)	Test Frequency (MHz)	RDC (Ω) ±30%	Isat (mA) Max	Irms (mA) Max
MPB201210T-R47□-NA2	0.47	20, 30	3	0.09	1100	1300
MPB201210T-1R0□-NA2	1.0	20, 30	3	0.12	650	1200
MPB201210T-1R5□-NA2	1.5	20, 30	3	0.15	450	1100
MPB201210T-2R2□-NA2	2.2	20, 30	3	0.19	400	1100
MPB201210T-3R3□-NA2	3.3	20, 30	3	0.24	300	800
MPB201210T-4R7□-NA2	4.7	20, 30	3	0.26	200	700

Note: When ordering, please specify tolerance code. Tolerance: M=±20% , T=±30%

- Operating temperature range - 55°C ~ 125°C(Including self - temperature rise)
- Isat for Inductance drop 30% from its value without current
- I rms for a 40°C temperature rise from 25°C ambient with current
- Measure Equipment :
 L : Agilent HP4287A+16197A, 3MHz 200mV
 RDC : HP 4338B, or equivalent

Test Instruments : HP4287A Inductance / Material Analyzer

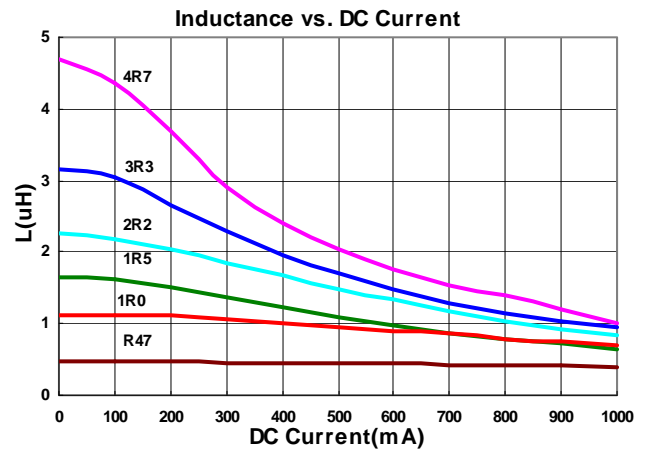
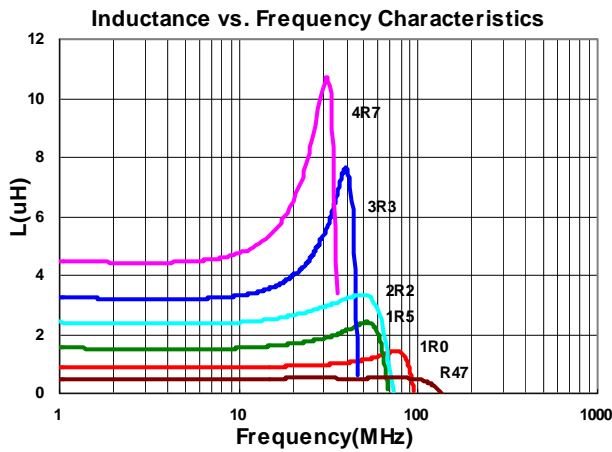

Please be sure to request approval specifications that provide further details of the products. Kindly note that the content of these specifications are subject to change or may be discontinued without advance notice. Please contact our sales department before ordering.

Electrical Characteristics

MPB : Low RDC Series

Part Number	Inductance (uH)	Tolerance (±%)	Test Frequency (MHz)	RDC (Ω) ±25%	Isat (mA) Max	Irms (mA) Max
MPB201610T-R47□-NA6	0.47	20, 30	3	0.06	1200	1600
MPB201610T-1R0□-NA6	1.0	20, 30	3	0.085	850	1300
MPB201610T-1R5□-NA6	1.5	20, 30	3	0.11	600	1200
MPB201610T-2R2□-NA6	2.2	20, 30	3	0.11	400	1200
MPB201610T-3R3□-NA6	3.3	20, 30	3	0.12	350	850
MPB201610T-4R7□-NA6	4.7	20, 30	3	0.14	200	1100

Note: When ordering, please specify tolerance code. Tolerance: M=±20% , T=±30%

- Operating temperature range - 55°C ~ 125°C(Including self - temperature rise)
- Isat for inductance drop 30% from its value without current
- I rms for a 40°C temperature rise from 25°C ambient with current
- Measure Equipment :
 L : Agilent HP4287A+16197A, 3MHz 200mV
 RDC : HP 4338B, or equivalent

Test Instruments : HP4287A Inductance / Material Analyzer

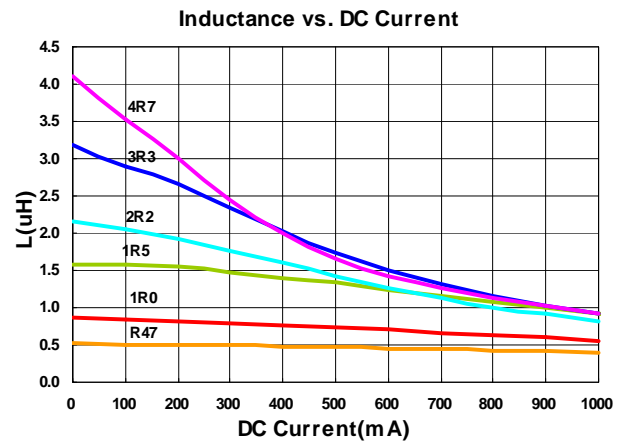
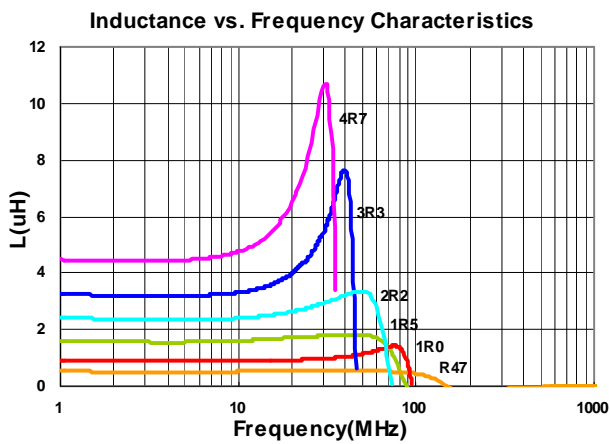

Please be sure to request approval specifications that provide further details of the products. Kindly note that the content of these specifications are subject to change or may be discontinued without advance notice. Please contact our sales department before ordering.

Electrical Characteristics

MPB : Low RDC Series

Part Number	Inductance (uH)	Tolerance (±%)	Test Frequency (MHz)	RDC (Ω) ±25%	Isat (mA) Max	Irms (mA) Max
MPB252010T-R47□-NA6	0.47	20, 30	3	0.04	1500	1800
MPB252010T-1R0□-NA6	1.0	20, 30	3	0.055	900	1600
MPB252010T-1R5□-NA2	1.5	20, 30	3	0.07±30%	800	1400
MPB252010T-2R2□-NA6	2.2	20, 30	3	0.08	500	1300
MPB252010T-3R3□-NA6	3.3	20, 30	3	0.10	400	1200
MPB252010T-4R7□-NA6	4.7	20, 30	3	0.11	300	1100

Note: When ordering, please specify tolerance code. Tolerance: M=±20% , T=±30%

- Operating temperature range - 55°C ~ 125°C(Including self - temperature rise)
- Isat for Inductance drop 30% from its value without current
- I rms for a 40°C temperature rise from 25°C ambient with current
- Measure Equipment :
 L : Agilent HP4287A+16197A, 3MHz 200mV
 RDC : HP 4338B, or equivalent

Test Instruments : HP4287A Inductance / Material Analyzer

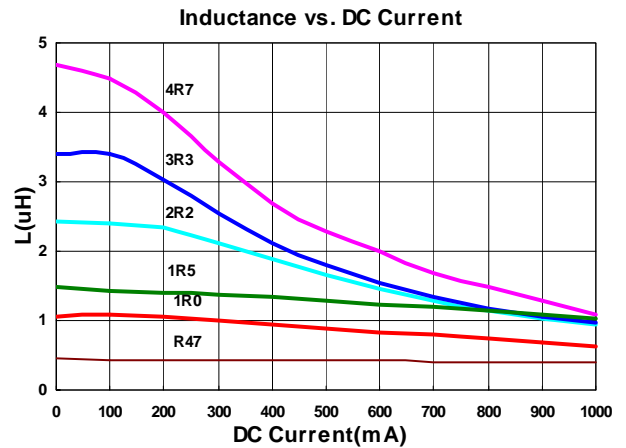
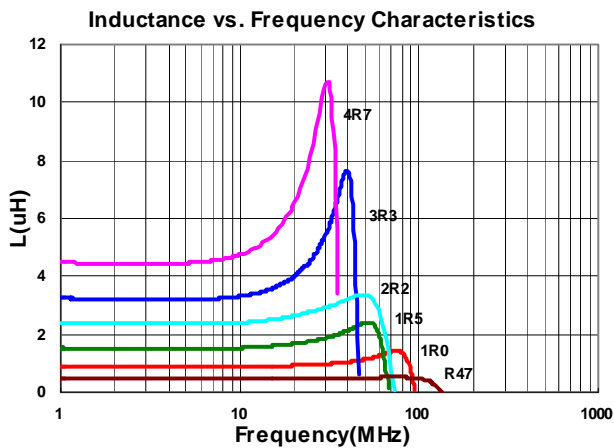

Please be sure to request approval specifications that provide further details of the products. Kindly note that the content of these specifications are subject to change or may be discontinued without advance notice. Please contact our sales department before ordering.

Electrical Characteristics

MPB : Low RDC Series

Part Number	Inductance (uH)	Tolerance (±%)	Test Frequency (MHz)	RDC (Ω) ±30%	Isat (mA) Max	Irms (mA) Max
MPB252012T-R47□-NA2	0.47	20, 30	3	0.04	1500	1800
MPB252012T-1R0□-NA2	1.0	20, 30	3	0.05	950	1600
MPB252012T-1R5□-NA2	1.5	20, 30	3	0.07	900	1400
MPB252012T-2R2□-NA2	2.2	20, 30	3	0.10	700	1200
MPB252012T-3R3□-NA2	3.3	20, 30	3	0.12	500	1100
MPB252012T-4R7□-NA2	4.7	20, 30	3	0.14	350	1000
MPB252012T-6R8□-NA2	6.8	20, 30	3	0.16	250	900

Note: When ordering, please specify tolerance code. Tolerance: M=±20% , T=±30%

- Operating temperature range - 55°C ~ 125°C(Including self - temperature rise)
- Isat for Inductance drop 30% from its value without current
- I rms for a 40°C temperature rise from 25°C ambient with current
- Measure Equipment :
 - L : Agilent HP4287A+16197A, 3MHz 200mV
 - RDC : HP 4338B, or equivalent

Test Instruments : HP4287A Inductance / Material Analyzer

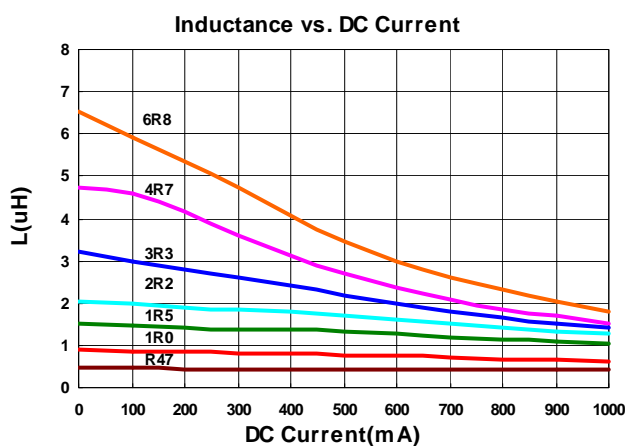
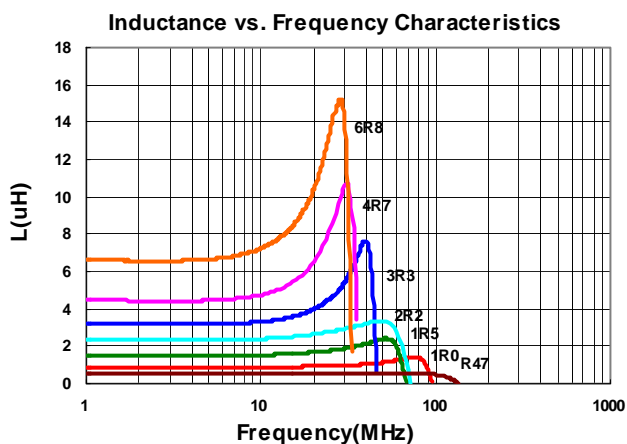

Please be sure to request approval specifications that provide further details of the products. Kindly note that the content of these specifications are subject to change or may be discontinued without advance notice. Please contact our sales department before ordering.

Electrical Characteristics

MPE : Low Profile Series

Part Number	Inductance (uH)	Tolerance (±%)	Test Frequency (MHz)	RDC (Ω) ±25%	Isat(mA) Max(Typ.)	Irms(mA) Max(Typ.)
MPE160806T-2R2□-NA6	2.2	20, 30	3	0.38	250(300)	650(750)

Note: When ordering, please specify tolerance code. Tolerance: M=±20% , T=±30%

- Operating temperature range - 55°C ~ 125°C(Including self - temperature rise)
- Isat for Inductance drop 30% from its value without current
- Irms for a 40°C temperature rise from 25°C ambient with current
- Measure Equipment :
 L : Agilent HP4287A+16197A, 3MHz 200mV
 RDC : HP 4338B, or equivalent

Test Instruments : HP4287A Inductance / Material Analyzer

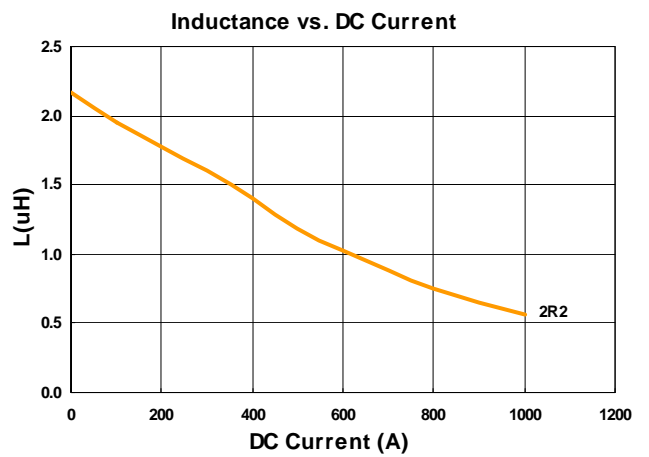
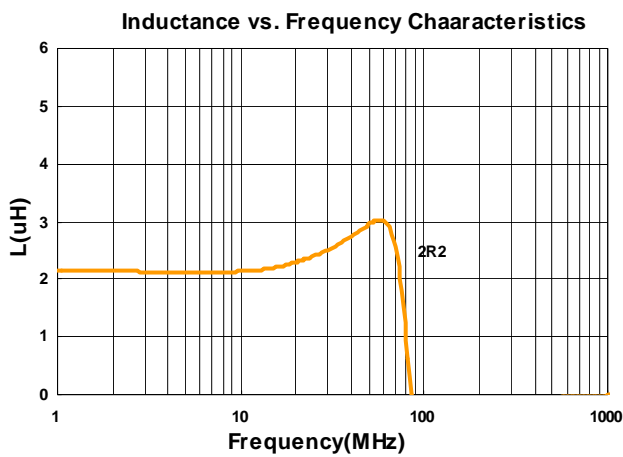

Please be sure to request approval specifications that provide further details of the products. Kindly note that the content of these specifications are subject to change or may be discontinued without advance notice. Please contact our sales department before ordering.

Electrical Characteristics

MPE : High Isat Series

Part Number	Inductance (uH)	Tolerance (±%)	Test Frequency (MHz)	RDC (Ω) ±25%	Isat(mA) Max(Typ.)	Irms(mA) Max(Typ.)
MPE201210T-R24□-NA2	0.24	20, 30	3	0.03	2700(3300)	2400(3200)
MPE201210T-R47□-NA2	0.47	20, 30	3	0.06	1600(2000)	2200(3000)
MPE201210T-1R0□-NA2	1.0	20, 30	3	0.10	1400(1700)	1800(2100)
MPE201210T-2R2□-NA2	2.2	20, 30	3	0.125	500(800)	1600(1900)

Note: When ordering, please specify tolerance code. Tolerance: M=±20% , T=±30%

- Operating temperature range - 55°C ~ 125°C(Including self - temperature rise)
- Isat for Inductance drop 30% from its value without current
- I rms for a 40°C temperature rise from 25°C ambient with current
- Measure Equipment :
 L : Agilent HP4287A+16197A, 3MHz 200mV
 RDC : HP 4338B, or equivalent

Test Instruments : HP4287A Inductance / Material Analyzer

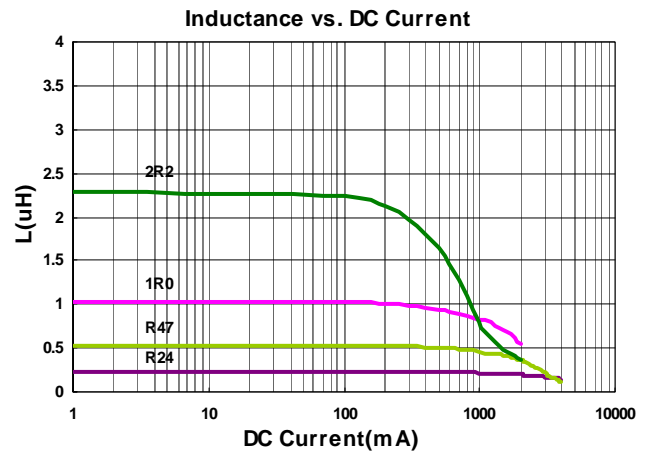
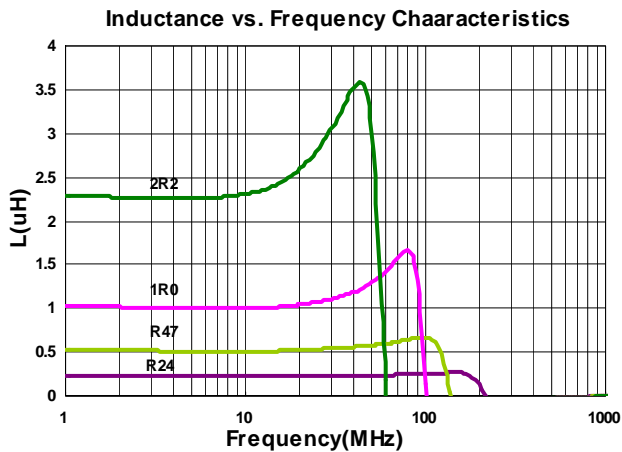

Please be sure to request approval specifications that provide further details of the products. Kindly note that the content of these specifications are subject to change or may be discontinued without advance notice. Please contact our sales department before ordering.

Electrical Characteristics

MPE : High Isat Series

Part Number	Inductance (uH)	Tolerance (±%)	Test Frequency (MHz)	RDC (Ω) ±25%	Isat(mA) Max(Typ.)	Irms(mA) Max(Typ.)
MPE201610T-R24□-NA2	0.24	20, 30	3	0.023	3600(4000)	3500(4200)
MPE201610T-R47□-NA2	0.47	20, 30	3	0.037	2500(2900)	2600(3100)
MPE201610T-R68□-NA2	0.68	20, 30	3	0.065	2500(2800)	2400(2800)
MPE201610T-1R0□-NA2	1.0	20, 30	3	0.068	1500(1900)	2200(2600)
MPE201610T-1R5□-NA2	1.5	20, 30	3	0.100	1500(1800)	1600(1900)
MPE201610T-2R2□-NA2	2.2	20, 30	3	0.210	1000(1300)	1500(1800)

Note: When ordering, please specify tolerance code. Tolerance: M=±20% , T=±30%

- Operating temperature range - 55°C ~ 125°C(Including self - temperature rise)
- Isat for Inductance drop 30% from its value without current
- I rms for a 40°C temperature rise from 25°C ambient with current
- Measure Equipment :
 L : Agilent HP4287A+16197A, 3MHz 200mV
 RDC : HP 4338B, or equivalent

Test Instruments : HP4287A Inductance / Material Analyzer

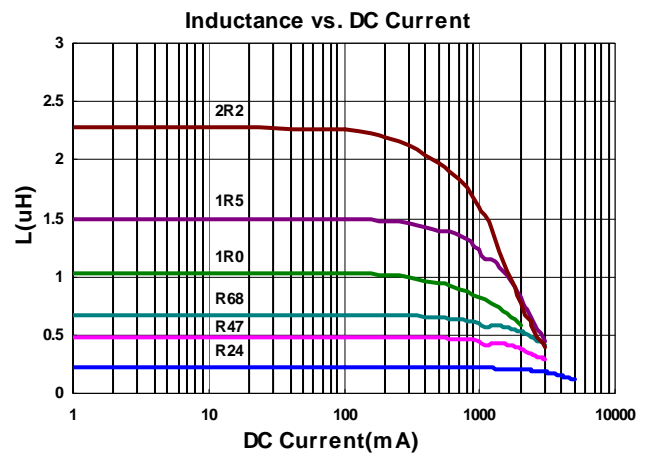
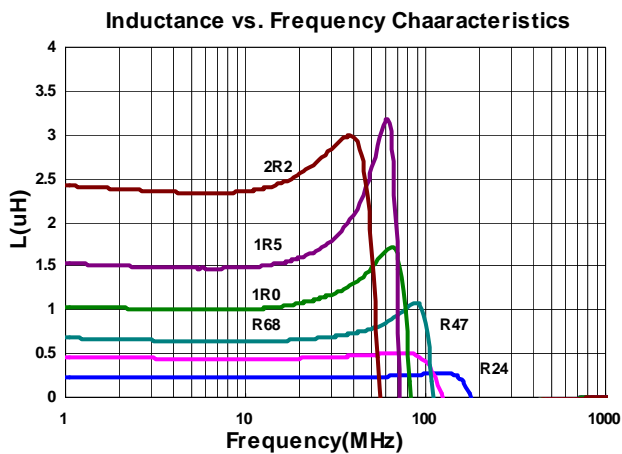

Please be sure to request approval specifications that provide further details of the products. Kindly note that the content of these specifications are subject to change or may be discontinued without advance notice. Please contact our sales department before ordering.

Electrical Characteristics

MPE : High Isat Series

Part Number	Inductance (uH)	Tolerance (±%)	Test Frequency (MHz)	RDC (Ω) ±25%	Isat(mA) Max(Typ.)	Irms(mA) Max(Typ.)
MPE252010T-R24□-NA2	0.24	20, 30	3	0.024	4800(5200)	4100(4900)
MPE252010T-R47□-NA2	0.47	20, 30	3	0.040	3100(3500)	3000(3600)
MPE252010T-1R0□-NA2	1.0	20, 30	3	0.050	1500(1900)	2900(3500)
MPE252010T-2R2□-NA2	2.2	20, 30	3	0.110	1400(1700)	1600(1900)

Note: When ordering, please specify tolerance code. Tolerance: M=±20% , T=±30%

- Operating temperature range - 55°C ~ 125°C(Including self - temperature rise)
- Isat for Inductance drop 30% from its value without current
- I rms for a 40°C temperature rise from 25°C ambient with current
- Measure Equipment :
 L : Agilent HP4287A+16197A, 3MHz 200mV
 RDC : HP 4338B, or equivalent

Test Instruments : HP4287A Inductance / Material Analyzer

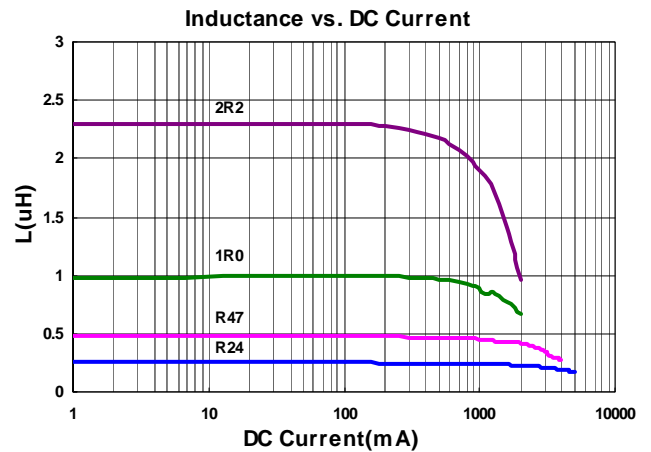
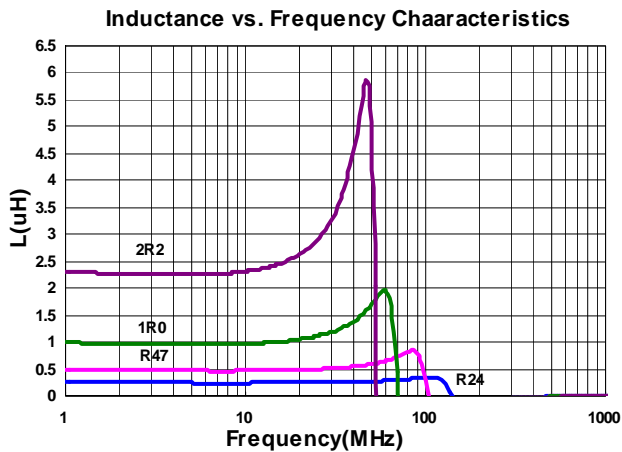

Please be sure to request approval specifications that provide further details of the products. Kindly note that the content of these specifications are subject to change or may be discontinued without advance notice. Please contact our sales department before ordering.

Packaging Specifications

Tape Dimensions

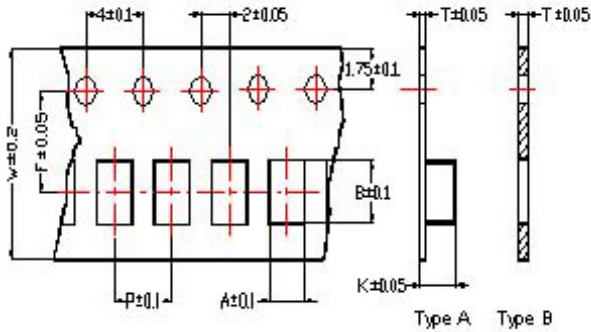

Tape Material

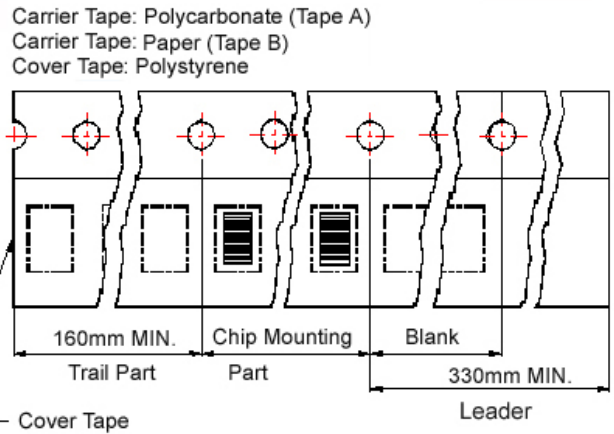

Reel Dimensions

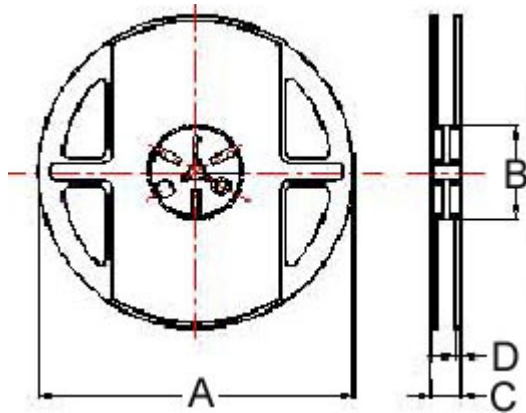

Dimensions in mm

TYPE	Tape Dimensions								Reel Dimensions				Quantity PCS / REEL
	A	B	T	W	P	F	K	Tape Type	A	B	C	D	
160805	1.05	1.85	0.60	8.0	2.0	3.5	-	B	178	60	12	1.5	10000
160806	1.05	1.85	0.75	8.0	4.0	3.5	-	B	178	60	12	1.5	4000
160808	1.05	1.85	0.95	8.0	4.0	3.5	-	B	178	60	12	1.5	4000
201205	1.42	2.25	0.22	8.0	4.0	3.5	0.80	A	178	60	12	1.5	4000
201210	1.45	2.25	0.22	8.0	4.0	3.5	1.04	A	178	60	12	1.5	3000
201610	1.80	2.20	0.22	8.0	4.0	3.5	1.15	A	178	60	12	1.5	3000
252010	2.25	2.8	0.25	8.0	4.0	3.5	1.35	A	178	60	12	1.5	3000
252012	2.25	2.8	0.25	8.0	4.0	3.5	1.35	A	178	60	12	1.5	3000

CXFL Series



The HEI Series is designed specifically to enhance both PFM and PWM application performance. Q(Rac) value at light load and the RDC value at heavy load are both exceptional. Furthermore, the saturated current performance is also optimal, helping to reduce the ripple current and enhance the efficiency.

Features

- RoHS, Halogen Free and REACH Compliance
- High Efficiency
- Excellent Q, RDC and saturation current
- Low profile and miniature size down to 1.6*0.8*0.8mm

Applications

- Smartphones, tablets and wearable devices
- HDD, SSD and PC peripheral devices
- DSC, camcorders
- PND
- DC/DC converters

Product Identification

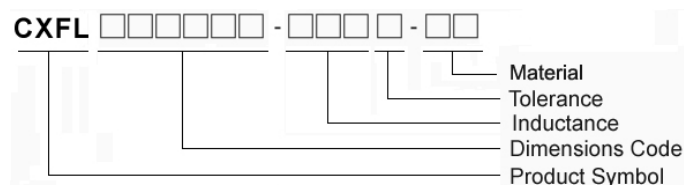

Shape and Dimensions

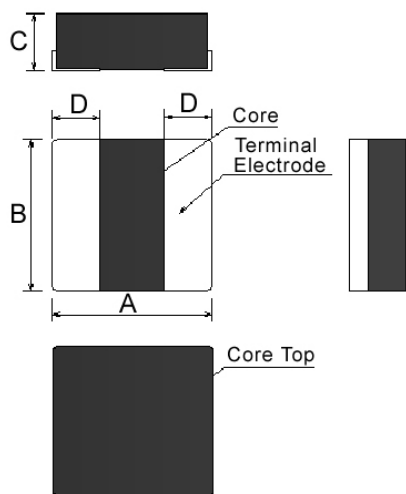

Dimensions in mm

TYPE	A	B	C	D
303010	3.0±0.2	3.0±0.2	1.0Max	0.8±0.3
404010	4.0±0.2	4.0±0.2	1.0Max	1.3±0.3

Recommended Pattern

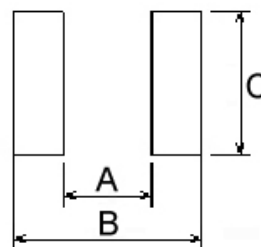

Dimensions in mm

TYPE	A	B	C
303010	1.0	3.2	3.2
404010	1.2	4.2	4.2

Electrical Characteristics

Part Number	Inductance (uH)	Tolerance (±%)	Test Frequency (MHz)	RDC(mΩ) Max(Typ.)	Isat(A) Max(Typ.)	Irms(A) Max(Typ.)
CXFL303010-R60M-B8	0.6	20	2	30(27)	5.2(5.8)	4.3(4.8)
CXFL303010-1R0M-B8	1.0	20	2	49(43)	4.5(5.0)	3.4(3.8)

Note: When ordering, please specify tolerance code. Tolerance: M=±20%

- Operating temperature range - 40°C ~ 125°C(Including self - temperature rise)
- Isat for Inductance drop 30% from its value without current
- Irms for a 40°C temperature rise from 25°C ambient with current
- Absolute maximum voltage 25VDC
- Measure Equipment :
 - L : Agilent E4991/HP4286A+16197A (or equivalent), 2MHz 0.2V
 - RDC : CHEN HWA502BC/HP4338B (or equivalent)
 - Isat : Agilent E4980A+HP42841A (or equivalent)
 - Irms : Agilent 6641 SYSTEM DC POWER SUPPLY (or equivalent)

Test Instruments : E4991A Impedance / Material Analyzer

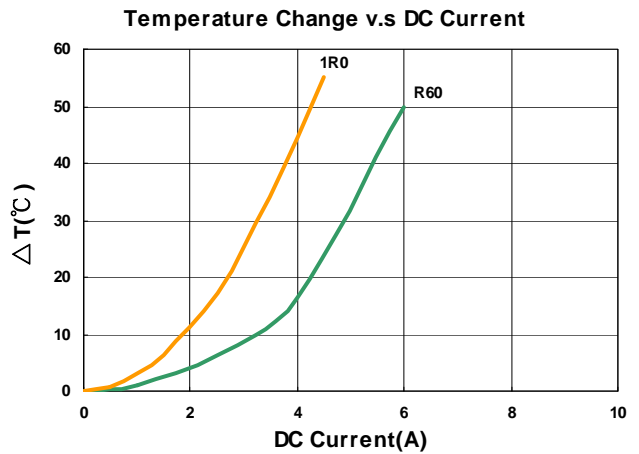
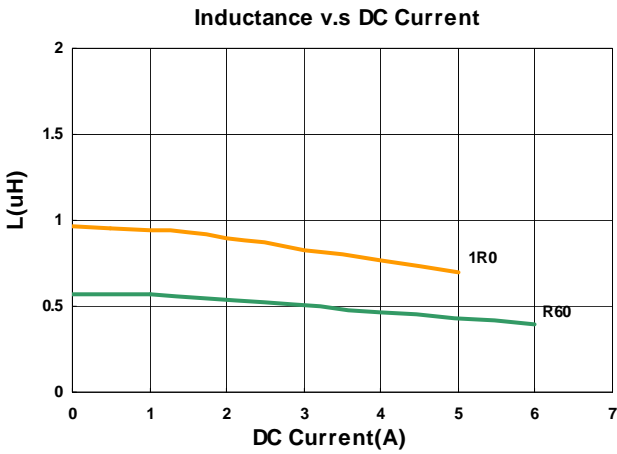

Please be sure to request approval specifications that provide further details of the products. Kindly note that the content of these specifications are subject to change or may be discontinued without advance notice. Please contact our sales department before ordering.

Electrical Characteristics

Part Number	Inductance (μH)	Tolerance ($\pm\%$)	Test Frequency (MHz)	RDC($\text{m}\Omega$) Max(Typ.)	Isat(A) Max(Typ.)	Irms(A) Max(Typ.)
CXFL404010-1R0M-B8	1.0	20	2	35(27)	4.7(5.2)	3.8(4.1)

Note: When ordering, please specify tolerance code. Tolerance: M= $\pm 20\%$

- Operating temperature range - $40^{\circ}\text{C} \sim 125^{\circ}\text{C}$ (Including self - temperature rise)
- Isat for Inductance drop 30% from its value without current
- Irms for a 40°C temperature rise from 25°C ambient with current
- Absolute maximum voltage 25VDC
- Measure Equipment :
 - L : Agilent E4991/HP4286A+16197A (or equivalent), 2MHz 0.2V
 - RDC : CHEN HWA502BC/HP4338B (or equivalent)
 - Isat : Agilent E4980A+HP42841A (or equivalent)
 - Irms : Agilent 6641 SYSTEM DC POWER SUPPLY (or equivalent)

Test Instruments : E4991A Impedance / Material Analyzer

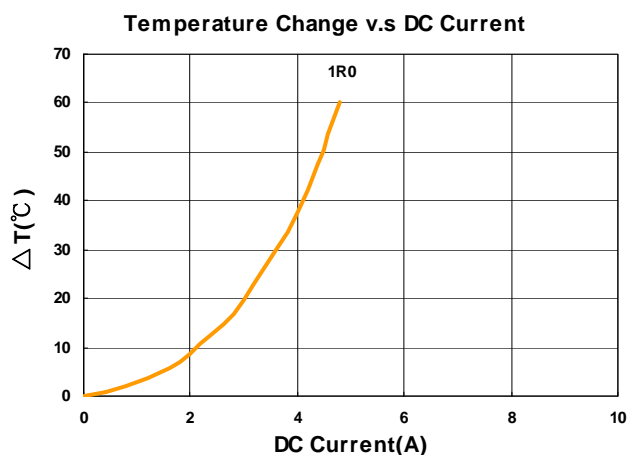
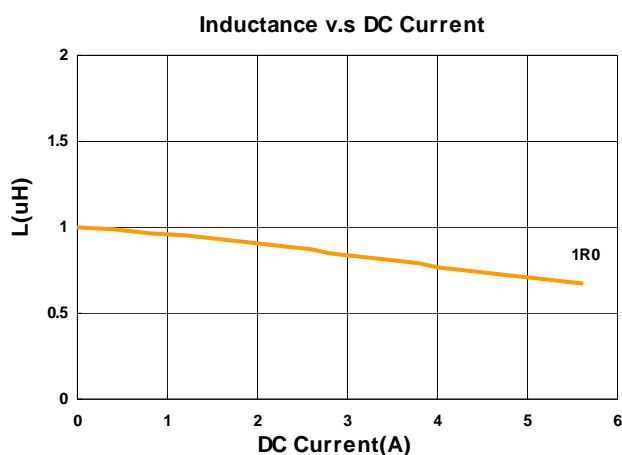

Please be sure to request approval specifications that provide further details of the products. Kindly note that the content of these specifications are subject to change or may be discontinued without advance notice. Please contact our sales department before ordering.

Packaging Specifications

Tape Dimensions

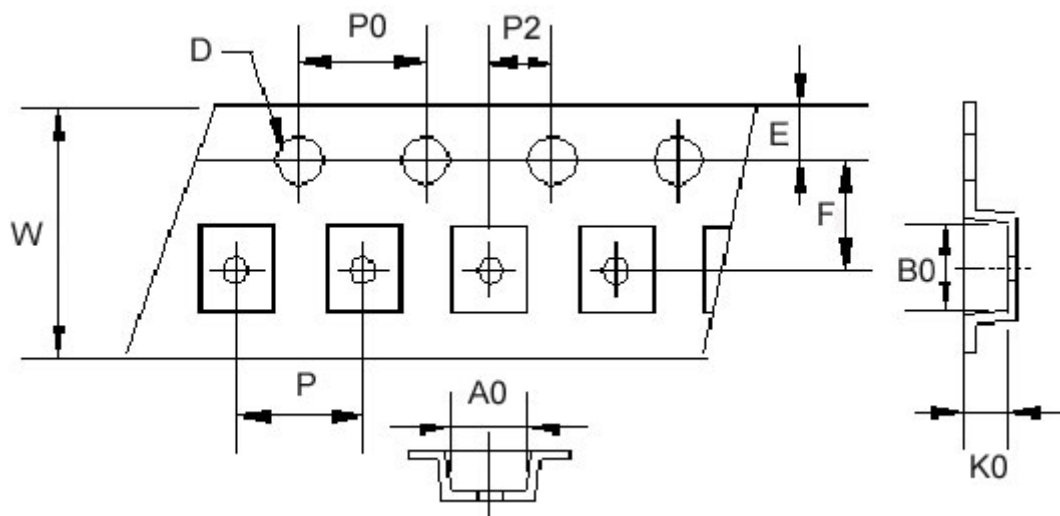

Reel Dimensions

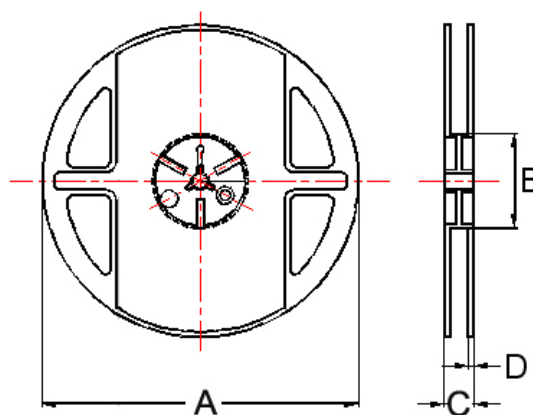

Dimensions in mm

TYPE	Tape Dimensions											Reel Dimensions				Quantity
	A0	B0	K0	D	E	F	W	P	P0	P2	A	B	C	D	PCS / REEL	
303010	3.2	3.2	1.4	1.55	1.75	3.5	8	4	4	2	178	60	12	1.5	2000	
404010	4.25	4.25	1.3	1.55	1.75	5.5	12	8	4	2	178	60	12	1.5	1000	

UHEI Series

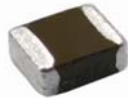

Through material optimization, UHEI Series is with better electrical characteristics, such as: better efficiency performance, higher Q factor, and higher Irms. Compared to HEI series, the RDC of UHEI series can also be reduced by 10% to 25%.

Features

- RoHS, Halogen Free and REACH Compliance
- High Efficiency
- Excellent Q, RDC and Irms
- Low profile and miniature size down to 2.0*1.6*1.0mm

Applications

- Smartphones, tablets and wearable devices
- HDD, SSD and PC peripheral devices
- DSC, camcorders
- PND
- DC/DC converters

Product Identification

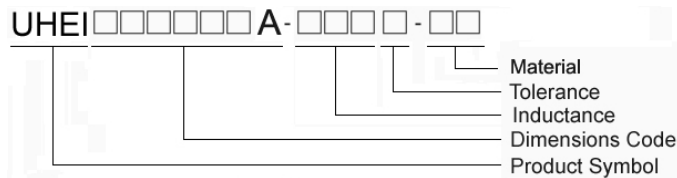

Shape and Dimensions

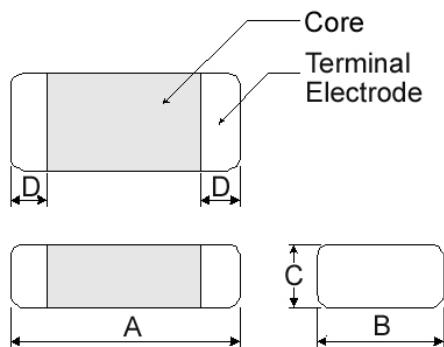

Recommended Pattern

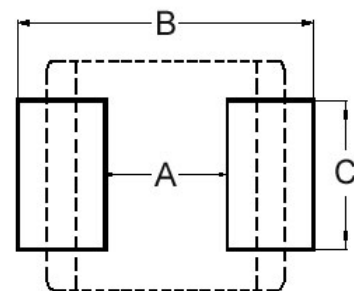

Dimensions in mm

TYPE	A	B	C	D
201208A	2.0±0.2	1.25±0.2	0.8Max	0.5±0.3
201610A	2.0±0.2	1.60±0.2	1.0Max	0.5±0.3
252010A	2.5±0.3	2.00±0.3	1.0Max	0.6±0.3
252012A	2.5±0.3	2.00±0.3	1.2Max	0.6±0.3

Dimensions in mm

TYPE	A	B	C
201208A	0.8~1.2	2.3~2.9	1.0~1.45
201610A	0.7	2.3	1.8
252010A	1.2	2.8	2.3
252012A	1.2	2.8	2.3

Electrical Characteristics

Part Number	Inductance (uH)	Tolerance (±%)	Test Frequency (MHz)	RDC(mΩ) Max(Typ.)	Isat(A) Max(Typ.)	Irms(A) Max(Typ.)
UHEI201208A-R47M-Q9	0.47	20	2	43(37)	3.5(3.6)	3.0(3.2)

Note: When ordering, please specify tolerance code. Tolerance: M=±20%

- Operating temperature range - 40°C ~ 125°C(Including self - temperature rise)
- Isat for Inductance drop 30% from its value without current
- I rms for a 40°C temperature rise from 25°C ambient with current
- Absolute maximum voltage 20VDC
- Measure Equipment :
 L : Agilent E4991/HP4286A+16197A (or equivalent), 2MHz 0.2V
 RDC : CHEN HWA502BC/HP4338B (or equivalent)
 Isat : Agilent E4980A+HP42841A (or equivalent)
 I rms : Agilent 6641 SYSTEM DC POWER SUPPLY (or equivalent)

Test Instruments : E4991A Impedance / Material Analyzer

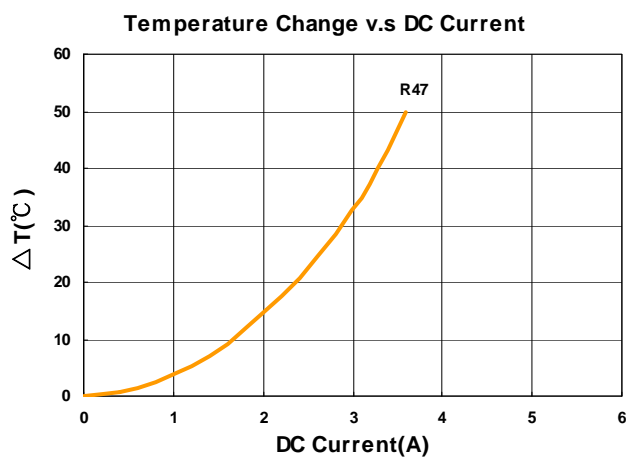
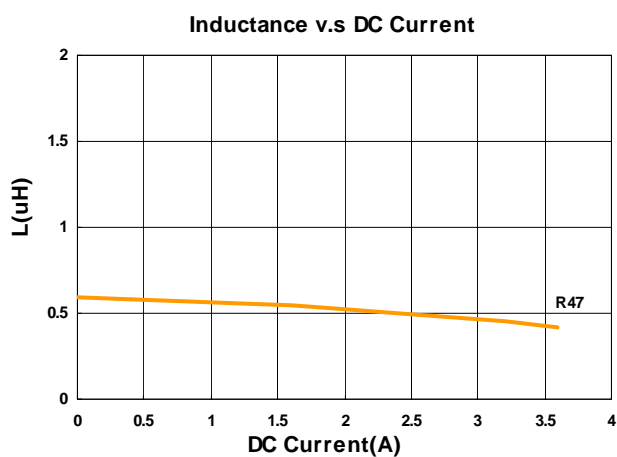

Electrical Characteristics

Part Number	Inductance (uH)	Tolerance (±%)	Test Frequency (MHz)	RDC(mΩ) Max(Typ.)	Isat(A) Max(Typ.)	Irms(A) Max(Typ.)
UHEI201610A-R47M-Q9	0.47	20	2	36(30)	3.5(3.9)	3.1(3.5)
UHEI201610A-1R0M-Q9	1.0	20	2	60(50)	3.0(3.2)	2.7(3.0)

Note: When ordering, please specify tolerance code. Tolerance: M=±20%

- Operating temperature range - 40°C ~ 125°C(Including self - temperature rise)
- Isat for Inductance drop 30% from its value without current
- Irms for a 40°C temperature rise from 25°C ambient with current
- Absolute maximum voltage 25VDC
- Measure Equipment :
 - L : Agilent E4991/HP4286A+16197A (or equivalent), 2MHz 0.2V
 - RDC : CHEN HWA502BC/HP4338B (or equivalent)
 - Isat : Agilent E4980A+HP42841A (or equivalent)
 - Irms : Agilent 6641 SYSTEM DC POWER SUPPLY (or equivalent)

Test Instruments : E4991A Impedance / Material Analyzer

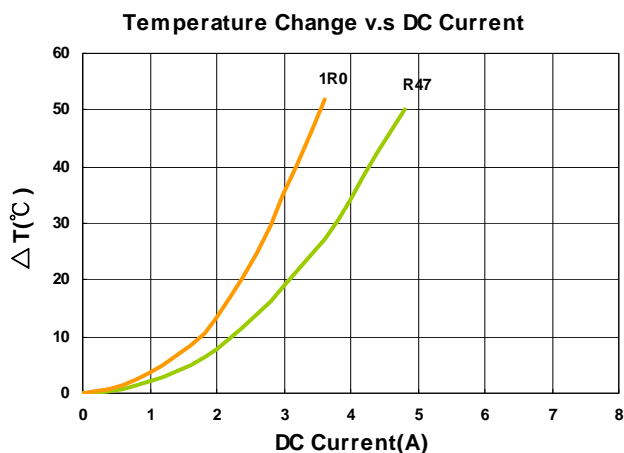
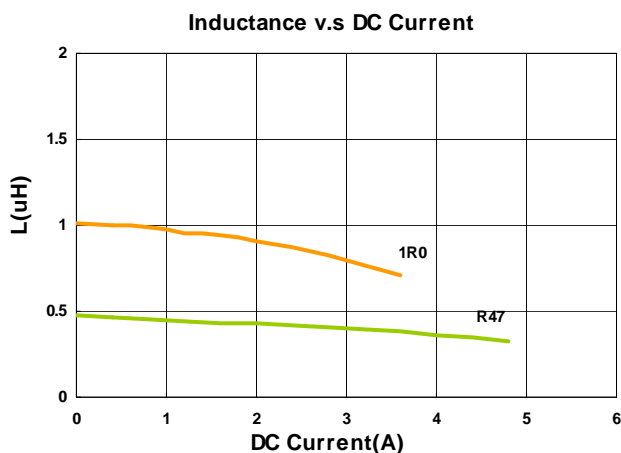

Electrical Characteristics

Part Number	Inductance (uH)	Tolerance (±%)	Test Frequency (MHz)	RDC(mΩ) Max(Typ.)	Isat(A) Max(Typ.)	Irms(A) Max(Typ.)
UHEI252010A-R47M-Q9	0.47	20	2	27(21)	5.5(6.5)	4.2(4.5)
UHEI252010A-1R0M-Q9	1.0	20	2	46(39)	4.7(5.2)	4.0(4.2)

Note: When ordering, please specify tolerance code. Tolerance: M=±20%

- Operating temperature range - 40°C ~ 125°C(Including self - temperature rise)
- Isat for Inductance drop 30% from its value without current
- Irms for a 40°C temperature rise from 25°C ambient with current
- Absolute maximum voltage 25VDC
- Measure Equipment :
 - L : Agilent E4991/HP4286A+16197A (or equivalent), 2MHz 0.2V
 - RDC : CHEN HWA502BC/HP4338B (or equivalent)
 - Isat : Agilent E4980A+HP42841A (or equivalent)
 - Irms : Agilent 6641 SYSTEM DC POWER SUPPLY (or equivalent)

Test Instruments : E4991A Impedance / Material Analyzer

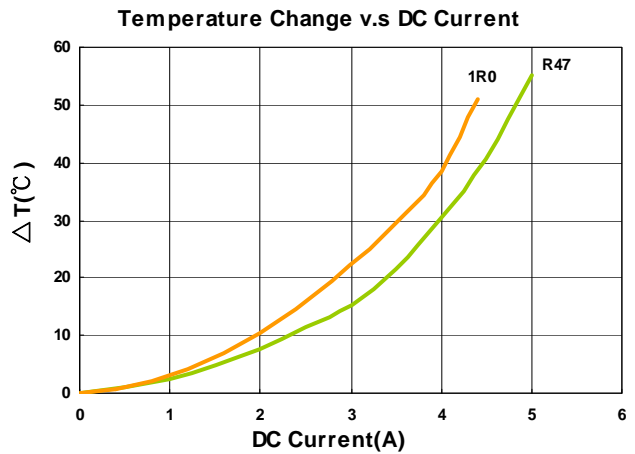
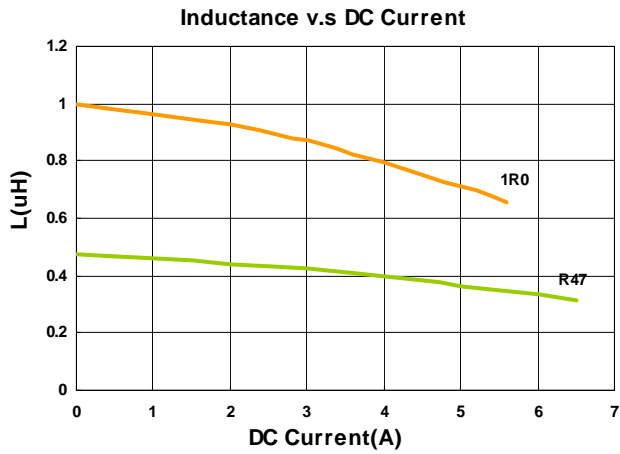

Electrical Characteristics

Part Number	Inductance (uH)	Tolerance (±%)	Test Frequency (MHz)	RDC(mΩ) Max(Typ.)	Isat(A) Max(Typ.)	Irms(A) Max(Typ.)
UHEI252012A-R47M-Q9	0.47	20	2	26.5(22.5)	5.3(7.0)	4.0(4.5)
UHEI252012A-1R5M-Q9	1.5	20	2	59(51)	3.4(4.4)	2.7(3.0)

Note: When ordering, please specify tolerance code. Tolerance: M=±20%

- Operating temperature range - 40°C ~ 125°C(Including self - temperature rise)
- Isat for Inductance drop 30% from its value without current
- Irms for a 40°C temperature rise from 25°C ambient with current
- Absolute maximum voltage 25VDC
- Measure Equipment :
 L : Agilent E4991/HP4286A+16197A (or equivalent), 2MHz 0.2V
 RDC : CHEN HWA502BC/HP4338B (or equivalent)
 Isat : Agilent E4980A+HP42841A (or equivalent)
 Irms : Agilent 6641 SYSTEM DC POWER SUPPLY (or equivalent)

Test Instruments : E4991A Impedance / Material Analyzer

Inductance v.s DC Current

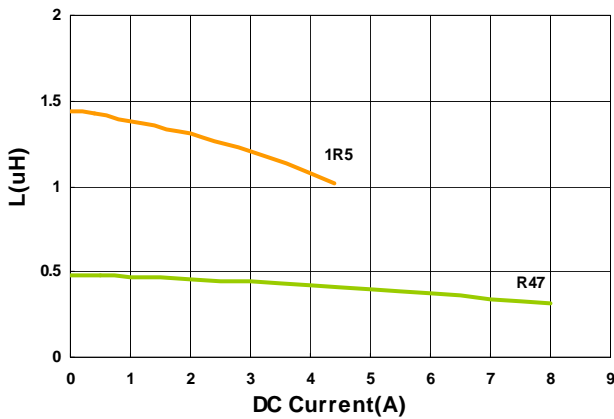

Temperature Change v.s DC Current

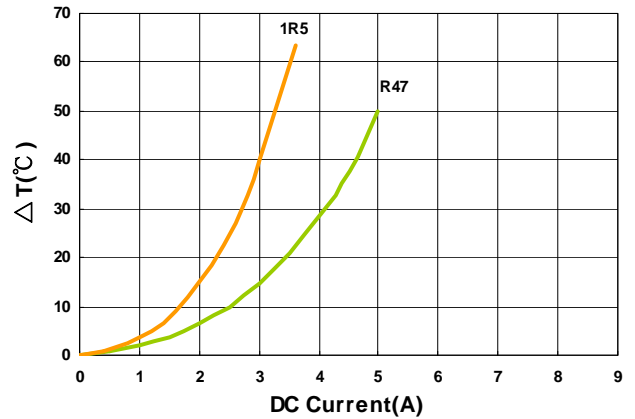

Packaging Specifications

Tape Dimensions

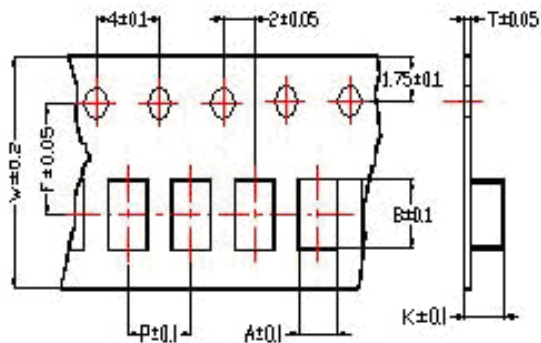

Tape Material

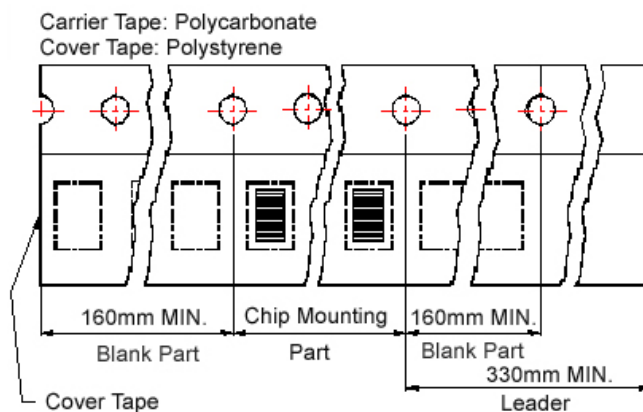

Reel Dimensions

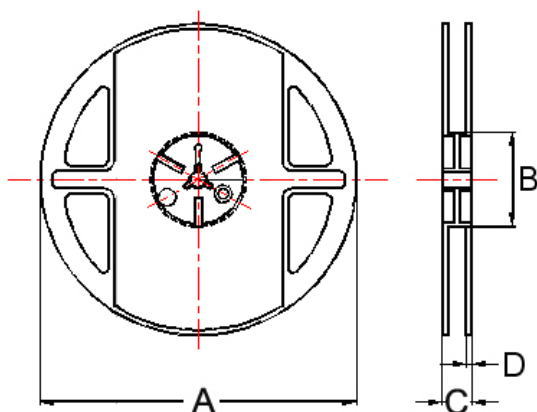

Dimensions in mm

TYPE	Tape Dimensions							Reel Dimensions				Quantity PCS / REEL
	A	B	T	W	P	F	K	A	B	C	D	
201208A	1.45	2.25	0.22	8	4	3.5	1.04	178	60	12	1.5	3000
201610A	1.80	2.20	0.22	8	4	3.5	1.15	178	60	12	1.5	3000
252010A	2.25	2.80	0.22	8	4	3.5	1.35	178	60	12	1.5	3000
252012A	2.25	2.80	0.22	8	4	3.5	1.35	178	60	12	1.5	3000

HEI Series



The HEI Series is designed specifically to enhance both PFM and PWM application performance. Q(Rac) value at light load and the RDC value at heavy load are both exceptional. Furthermore, the saturated current performance is also optimal, helping to reduce the ripple current and enhance the efficiency.

Features

- RoHS, Halogen Free and REACH Compliance
- High Efficiency
- Excellent Q, RDC and saturation current
- Low profile and miniature size down to 1.6*0.8*0.8mm

Applications

- Smartphones, tablets and wearable devices
- HDD, SSD and PC peripheral devices
- DSC, camcorders
- PND
- DC/DC converters

Product Identification

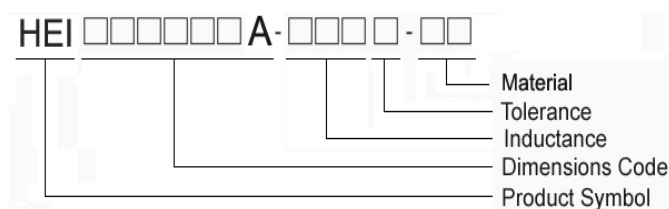

Shape and Dimensions

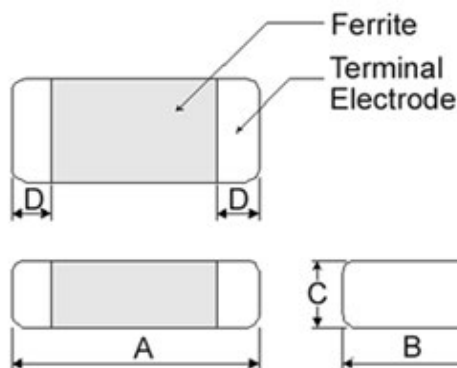

Dimensions in mm

TYPE	A	B	C	D
160808A	1.6±0.2	0.80±0.2	0.8Max	0.3±0.2
201208A	2.0±0.2	1.25±0.2	0.8Max	0.5±0.3
201210A	2.0±0.2	1.25±0.2	1.0Max	0.5±0.3
201608A	2.0±0.2	1.60±0.2	0.8Max	0.5±0.3
201610A	2.0±0.2	1.60±0.2	1.0Max	0.5±0.3
252010A	2.5±0.3	2.00±0.3	1.0Max	0.6±0.3
252012A	2.5±0.3	2.00±0.3	1.2Max	0.6±0.3
322510A	3.2±0.3	2.50±0.3	1.0Max	0.5±0.3
322512A	3.2±0.3	2.50±0.3	1.2Max	0.5±0.3
322525A	3.2±0.3	2.50±0.3	2.50±0.3	0.5±0.3

Recommended Pattern

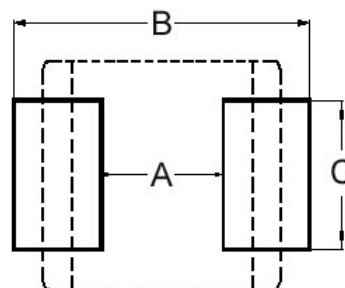

Dimensions in mm

TYPE	A	B	C
160808A	0.7~0.8	1.8~2.0	0.8~1.1
201208A	0.8~1.2	2.3~2.9	1.0~1.45
201210A	0.8~1.2	2.3~2.9	1.0~1.45
201608A	0.7	2.3	1.8
201610A	0.7	2.3	1.8
252010A	1.2	2.8	2.3
252012A	1.2	2.8	2.3
322510A	1.7	3.5	2.8
322512A	1.7	3.5	2.8
322525A	1.7	3.5	2.8

Electrical Characteristics

Part Number	Inductance (uH)	Tolerance (±%)	Test Frequency (MHz)	RDC(mΩ) Max(Typ.)	Isat(A) Max(Typ.)	Irms(A) Max(Typ.)
HEI160808A-R24M-Q8	0.24	20	2	54(47)	3.2(3.6)	2.6(3.0)
HEI160808A-R33M-Q8	0.33	20	2	75(62)	3.0(3.4)	2.2(2.6)
HEI160808A-R47M-Q8	0.47	20	2	100(87)	2.2(2.6)	1.6(2.0)

Note: When ordering, please specify tolerance code. Tolerance: M=±20%

- Operating temperature range - 40°C ~ 125°C(Including self - temperature rise)
- Isat for Inductance drop 30% from its value without current
- I rms for a 40°C temperature rise from 25°C ambient with current
- Absolute maximum voltage 20VDC
- Measure Equipment :
 - L : Agilent E4991/HP4286A+16197A (or equivalent), 2MHz 0.2V
 - RDC : CHEN HWA502BC/HP4338B (or equivalent)
 - Isat : Agilent E4980A+HP42841A (or equivalent)
 - I rms : Agilent 6641 SYSTEM DC POWER SUPPLY (or equivalent)

Test Instruments : E4991A Impedance / Material Analyzer

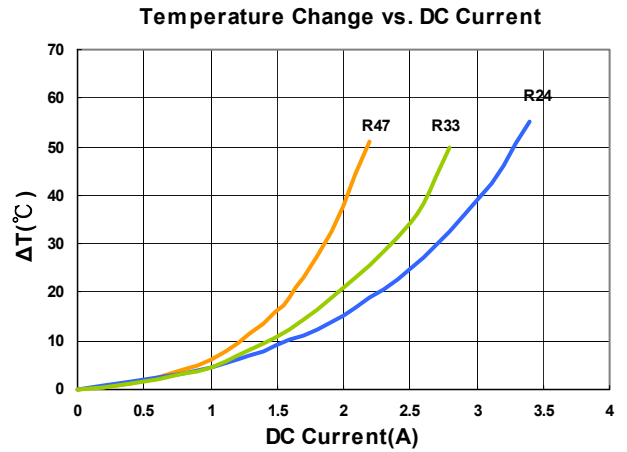
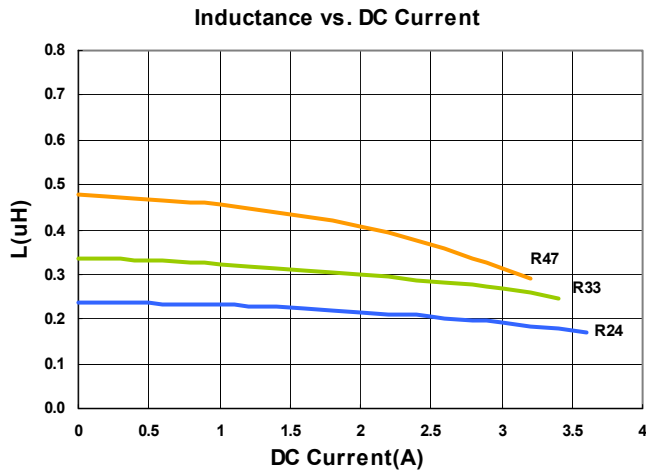

Electrical Characteristics

Part Number	Inductance (uH)	Tolerance (±%)	Test Frequency (MHz)	RDC(mΩ) Max(Typ.)	Isat(A) Max(Typ.)	Irms(A) Max(Typ.)
HEI201208A-R24M-Q8	0.24	20	2	25(19)	4.8(5.4)	4.2(4.8)
HEI201208A-R47M-Q8	0.47	20	2	48(40)	3.2(3.6)	3.0(3.4)

Note: When ordering, please specify tolerance code. Tolerance: M=±20%

- Operating temperature range - 40°C ~ 125°C(Including self - temperature rise)
- Isat for Inductance drop 30% from its value without current
- I rms for a 40°C temperature rise from 25°C ambient with current
- Absolute maximum voltage 20VDC
- Measure Equipment :
 - L : Agilent E4991/HP4286A+16197A (or equivalent), 2MHz 0.2V
 - RDC : CHEN HWA502BC/HP4338B (or equivalent)
 - Isat : Agilent E4980A+HP42841A (or equivalent)
 - I rms : Agilent 6641 SYSTEM DC POWER SUPPLY (or equivalent)

Test Instruments : E4991A Impedance / Material Analyzer

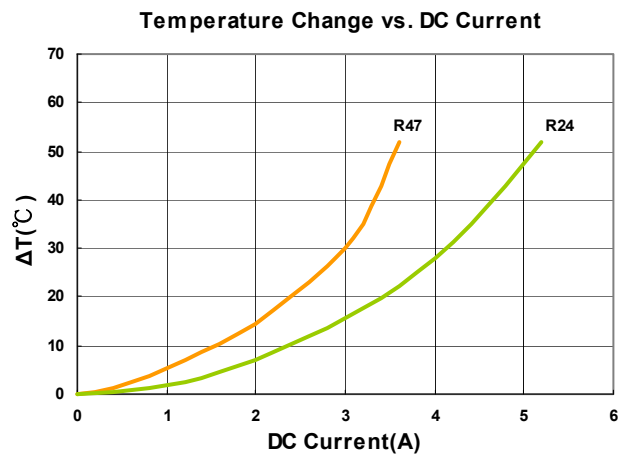
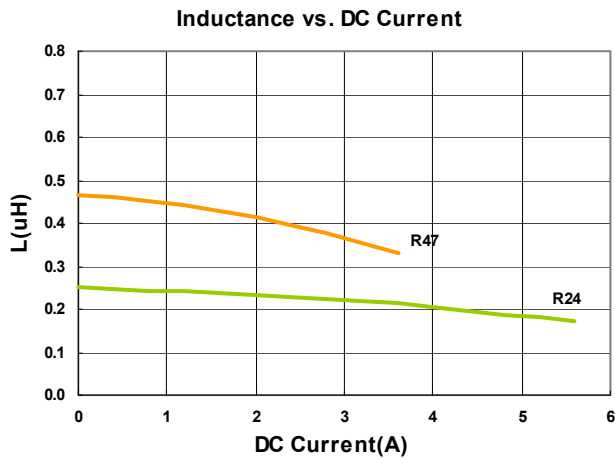

Electrical Characteristics

Part Number	Inductance (uH)	Tolerance (±%)	Test Frequency (MHz)	RDC(mΩ) Max(Typ.)	Isat(A) Max(Typ.)	Irms(A) Max(Typ.)
HEI201210A-R24M-Q8	0.24	20	2	28(22)	4.5(5.7)	3.7(4.6)
HEI201210A-R33M-Q8	0.33	20	2	30(25)	4.5(4.8)	3.7(4.3)
HEI201210A-R47M-Q8	0.47	20	2	42(33)	3.3(4.2)	3.0(3.7)
HEI201210A-1R0M-Q8	1.0	20	2	78(69)	2.3(2.8)	2.2(2.7)
HEI201210A-1R5M-Q8	1.5	20	2	126(108)	1.7(2.2)	1.6(2.1)
HEI201210A-2R2M-Q8	2.2	20	2	176(166)	1.6(1.7)	1.4(1.5)

Note: When ordering, please specify tolerance code. Tolerance: M=±20%

- Operating temperature range - 40°C ~ 125°C(Including self - temperature rise)
- Isat for Inductance drop 30% from its value without current
- I rms for a 40°C temperature rise from 25°C ambient with current
- Absolute maximum voltage 20VDC
- Measure Equipment :
 - L : Agilent E4991/HP4286A+16197A (or equivalent), 2MHz 0.2V
 - RDC : CHEN HWA502BC/HP4338B (or equivalent)
 - Isat : Agilent E4980A+HP42841A (or equivalent)
 - I rms : Agilent 6641 SYSTEM DC POWER SUPPLY (or equivalent)

Test Instruments : E4991A Impedance / Material Analyzer

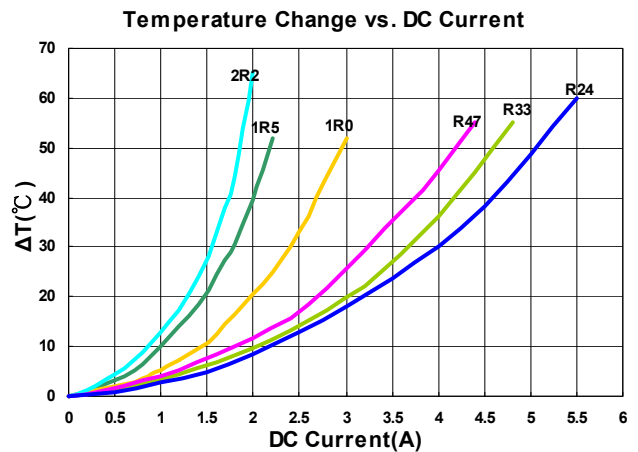
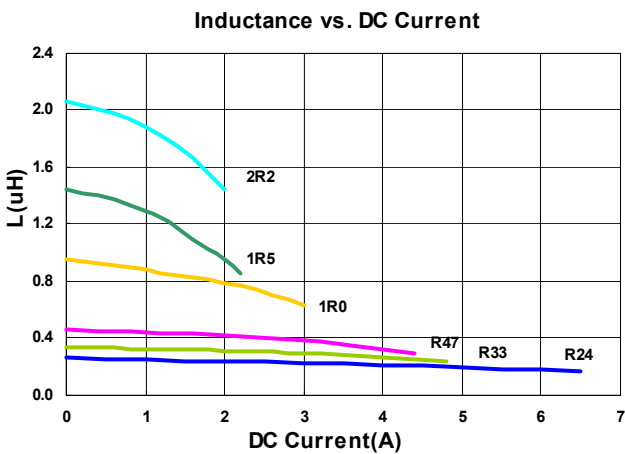

Please be sure to request approval specifications that provide further details of the products. Kindly note that the content of these specifications are subject to change or may be discontinued without advance notice. Please contact our sales department before ordering.

Electrical Characteristics

Part Number	Inductance (uH)	Tolerance (±%)	Test Frequency (MHz)	RDC(mΩ) Max(Typ.)	Isat(A) Max(Typ.)	Irms(A) Max(Typ.)
HEI201608A-R47M-Q8	0.47	20	2	51(42)	3.3(3.6)	3.1(3.4)
HEI201608A-1R0M-Q8	1.0	20	2	87(76)	2.5(2.8)	2.3(2.7)
HEI201608A-1R5M-Q8	1.5	20	2	115(102)	2.0(2.3)	2.1(2.4)

Note: When ordering, please specify tolerance code. Tolerance: M=±20%

- Operating temperature range - 40°C ~ 125°C(Including self - temperature rise)
- Isat for Inductance drop 30% from its value without current
- I rms for a 40°C temperature rise from 25°C ambient with current
- Absolute maximum voltage 25VDC
- Measure Equipment :
 L : Agilent E4991/HP4286A+16197A (or equivalent), 2MHz 0.2V
 RDC : CHEN HWA502BC/HP4338B (or equivalent)
 Isat : Agilent E4980A+HP42841A (or equivalent)
 I rms : Agilent 6641 SYSTEM DC POWER SUPPLY (or equivalent)

Test Instruments : E4991A Impedance / Material Analyzer

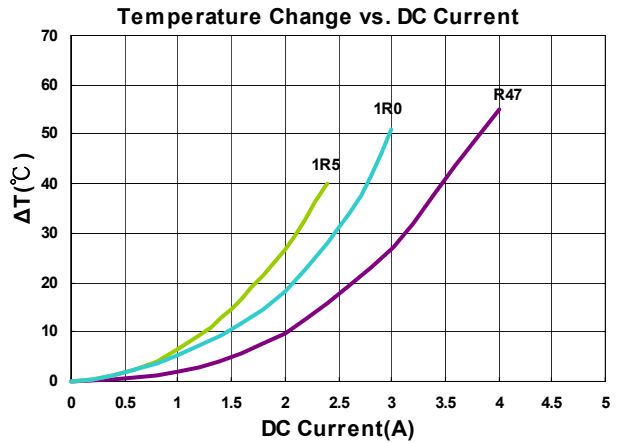
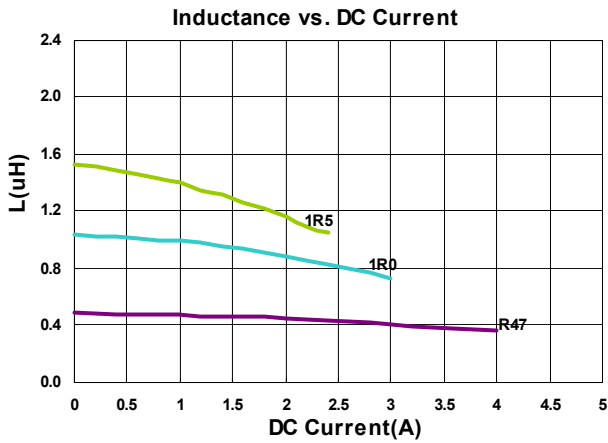

Electrical Characteristics

Part Number	Inductance (uH)	Tolerance (±%)	Test Frequency (MHz)	RDC(mΩ) Max(Typ.)	Isat(A) Max(Typ.)	Irms(A) Max(Typ.)
HEI201610A-R24M-Q8	0.24	20	2	27(21)	5.6(7.0)	3.9(4.8)
HEI201610A-R33M-Q8	0.33	20	2	23(17.5)	5.3(6.0)	4.7(5.1)
HEI201610A-R47M-Q8	0.47	20	2	42(33)	3.9(4.8)	3.5(4.2)
HEI201610A-R68M-Q8	0.68	20	2	56(43)	3.2(4.0)	2.7(3.4)
HEI201610A-1R0M-Q8	1.0	20	2	65(53)	2.9(3.6)	2.5(3.1)
HEI201610A-1R5M-Q8	1.5	20	2	85(75)	2.5(2.8)	2.3(2.7)
HEI201610A-2R2M-Q8	2.2	20	2	135(112)	2.4(2.7)	1.8(2.2)

Note: When ordering, please specify tolerance code. Tolerance: M=±20%

- Operating temperature range - 40°C ~ 125°C(Including self - temperature rise)
- Isat for Inductance drop 30% from its value without current
- I rms for a 40°C temperature rise from 25°C ambient with current
- Absolute maximum voltage 25VDC
- Measure Equipment :
 - L : Agilent E4991/HP4286A+16197A (or equivalent), 2MHz 0.2V
 - RDC : CHEN HWA502BC/HP4338B (or equivalent)
 - Isat : Agilent E4980A+HP42841A (or equivalent)
 - I rms : Agilent 6641 SYSTEM DC POWER SUPPLY (or equivalent)

Test Instruments : E4991A Impedance / Material Analyzer

Inductance vs. DC Current

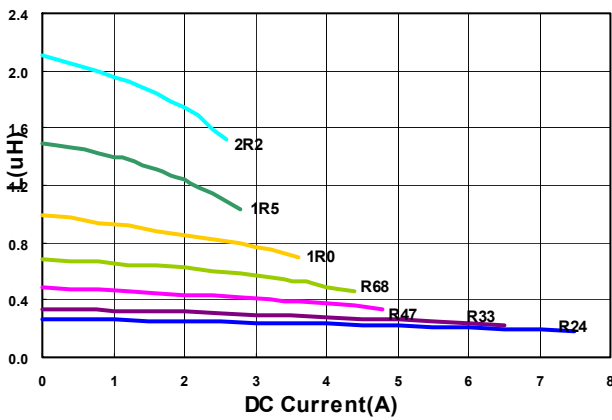

Temperature Change vs. DC Current

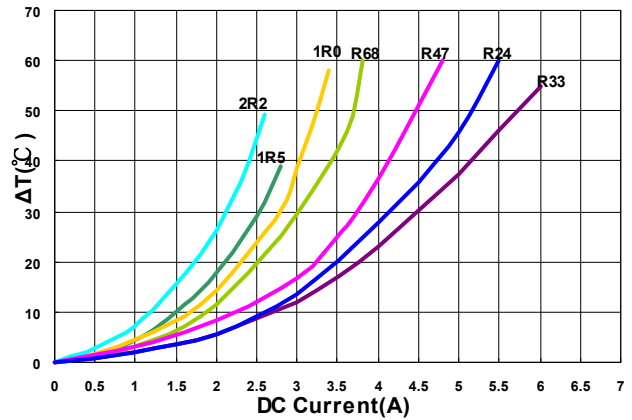

Please be sure to request approval specifications that provide further details of the products. Kindly note that the content of these specifications are subject to change or may be discontinued without advance notice. Please contact our sales department before ordering.

Electrical Characteristics

Part Number	Inductance (uH)	Tolerance (±%)	Test Frequency (MHz)	RDC(mΩ) Max(Typ.)	Isat(A) Max(Typ.)	Irms(A) Max(Typ.)
HEI252010A-R24M-Q8	0.24	20	2	18(13)	8.0(9.5)	5.5(6.5)
HEI252010A-R33M-Q8	0.33	20	2	24(18)	6.5(8.0)	4.8(5.5)
HEI252010A-R47M-Q8	0.47	20	2	35(27)	5.0(6.2)	3.9(4.5)
HEI252010A-R68M-Q8	0.68	20	2	40(32)	4.5(5.6)	3.7(4.2)
HEI252010A-1R0M-Q8	1.0	20	2	53(45)	3.7(4.6)	3.0(3.5)
HEI252010A-1R5M-Q8	1.5	20	2	75(68)	3.1(3.8)	2.4(2.8)
HEI252010A-2R2M-Q8	2.2	20	2	97(87)	2.5(3.0)	2.2(2.5)

Note: When ordering, please specify tolerance code. Tolerance: M=±20%

- Operating temperature range - 40°C ~ 125°C(Including self - temperature rise)
- Isat for Inductance drop 30% from its value without current
- I rms for a 40°C temperature rise from 25°C ambient with current
- Absolute maximum voltage 25VDC
- Measure Equipment :
 L : Agilent E4991/HP4286A+16197A (or equivalent), 2MHz 0.2V
 RDC : CHEN HWA502BC/HP4338B (or equivalent)
 Isat : Agilent E4980A+HP42841A (or equivalent)
 I rms : Agilent 6641 SYSTEM DC POWER SUPPLY (or equivalent)

Test Instruments : E4991A Impedance / Material Analyzer

Inductance vs. DC Current

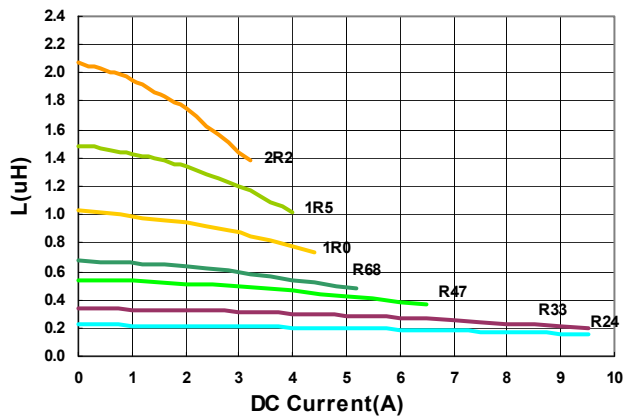

Temperature Change vs. DC Current

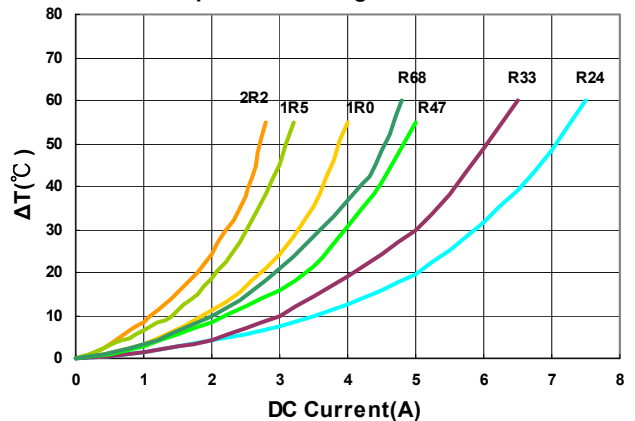

Electrical Characteristics

Part Number	Inductance (uH)	Tolerance (±%)	Test Frequency (MHz)	RDC(mΩ) Max(Typ.)	Isat(A) Max(Typ.)	Irms(A) Max(Typ.)
HEI252012A-R24M-Q8	0.24	20	2	15(11.5)	9.0(10.5)	6.2(7.3)
HEI252012A-R33M-Q8	0.33	20	2	18(14.5)	8.5(10)	5.8(6.4)
HEI252012A-R47M-Q8	0.47	20	2	33(28)	5.6(7.0)	3.8(4.5)
HEI252012A-R68M-Q8	0.68	20	2	36(30)	5.0(6.2)	3.8(4.4)
HEI252012A-1R0M-Q8	1.0	20	2	42(35)	4.4(5.5)	3.6(4.1)
HEI252012A-1R5M-Q8	1.5	20	2	65(57)	3.4(4.2)	2.7(3.1)
HEI252012A-2R2M-Q8	2.2	20	2	83(74)	3.0(3.7)	2.5(2.9)

Note: When ordering, please specify tolerance code. Tolerance: M=±20%

- Operating temperature range - 40°C ~ 125°C(Including self - temperature rise)
- Isat for Inductance drop 30% from its value without current
- I rms for a 40°C temperature rise from 25°C ambient with current
- Absolute maximum voltage 25VDC
- Measure Equipment :
 - L : Agilent E4991/HP4286A+16197A (or equivalent), 2MHz 0.2V
 - RDC : CHEN HWA502BC/HP4338B (or equivalent)
 - Isat : Agilent E4980A+HP42841A (or equivalent)
 - I rms : Agilent 6641 SYSTEM DC POWER SUPPLY (or equivalent)

Test Instruments : E4991A Impedance / Material Analyzer

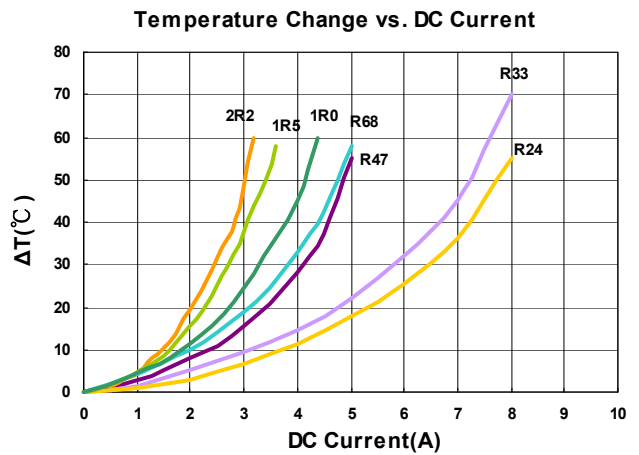
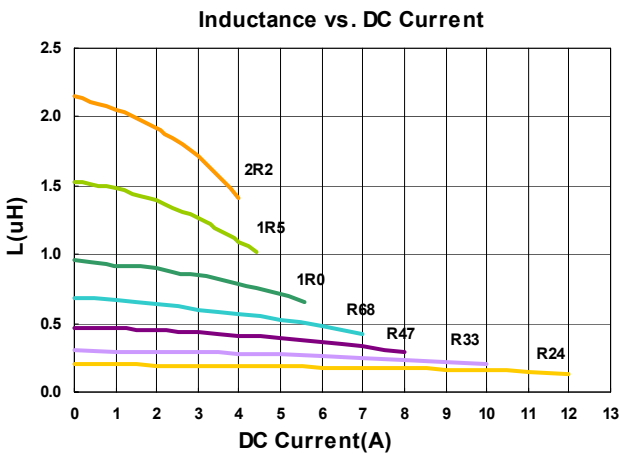

Please be sure to request approval specifications that provide further details of the products. Kindly note that the content of these specifications are subject to change or may be discontinued without advance notice. Please contact our sales department before ordering.

Electrical Characteristics

Part Number	Inductance (uH)	Tolerance (±%)	Test Frequency (MHz)	RDC(mΩ) Max(Typ.)	Isat(A) Max(Typ.)	Irms(A) Max(Typ.)
HEI322510A-R24M-Q8	0.24	20	2	16(12)	9.0(11.5)	6.0(6.8)
HEI322510A-R33M-Q8	0.33	20	2	17(12.5)	8.0(9.5)	5.8(6.5)
HEI322510A-R47M-Q8	0.47	20	2	24(19)	6.0(7.3)	4.5(5.4)
HEI322510A-1R0M-Q8	1.0	20	2	46(39)	4.1(4.7)	3.3(3.7)
HEI322510A-1R5M-Q8	1.5	20	2	58(50)	3.5(4.0)	3.2(3.5)
HEI322510A-2R2M-Q8	2.2	20	2	85(73)	3.0(3.5)	2.5(2.8)

Note: When ordering, please specify tolerance code. Tolerance: M=±20%

- Operating temperature range - 40°C ~ 125°C(Including self - temperature rise)
- Isat for Inductance drop 30% from its value without current
- I rms for a 40°C temperature rise from 25°C ambient with current
- Absolute maximum voltage 25VDC
- Measure Equipment :
 - L : Agilent E4991/HP4286A+16197A (or equivalent), 2MHz 0.2V
 - RDC : CHEN HWA502BC/HP4338B (or equivalent)
 - Isat : Agilent E4980A+HP42841A (or equivalent)
 - I rms : Agilent 6641 SYSTEM DC POWER SUPPLY (or equivalent)

Test Instruments : E4991A Impedance / Material Analyzer

Inductance vs. DC Current

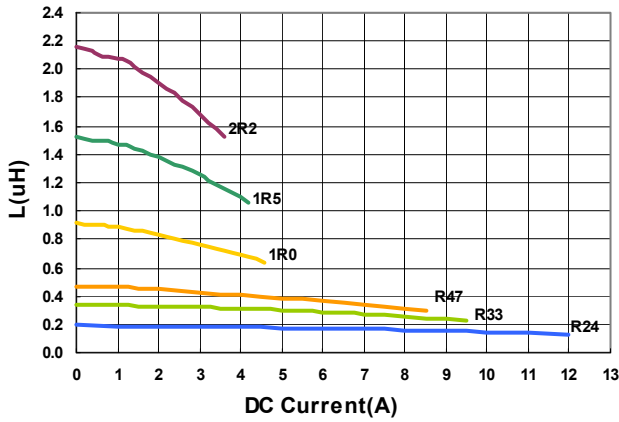

Temperature Change vs. DC Current

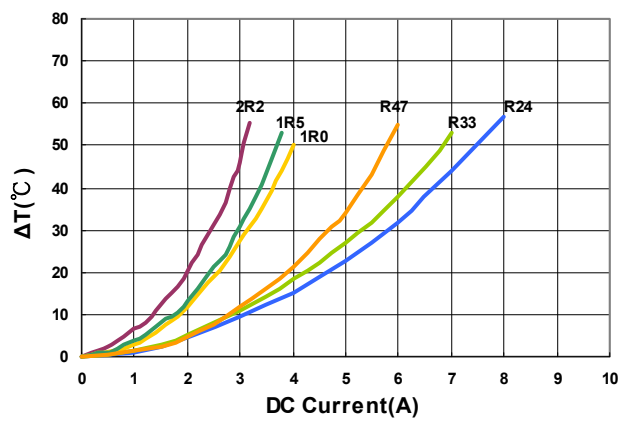

Please be sure to request approval specifications that provide further details of the products. Kindly note that the content of these specifications are subject to change or may be discontinued without advance notice. Please contact our sales department before ordering.

Electrical Characteristics

Part Number	Inductance (uH)	Tolerance (±%)	Test Frequency (MHz)	RDC(mΩ) Max(Typ.)	Isat(A) Max(Typ.)	Irms(A) Max(Typ.)
HEI322512A-R47M-Q8	0.47	20	2	25(19)	7.0(8.2)	4.6(5.2)
HEI322512A-1R0M-Q8	1.0	20	2	34(27.5)	5.7(6.5)	3.7(4.2)
HEI322512A-1R5M-Q8	1.5	20	2	59(51)	4.0(4.6)	2.8(3.2)
HEI322512A-2R2M-Q8	2.2	20	2	73(64)	3.5(4.0)	2.7(3.0)

Note: When ordering, please specify tolerance code. Tolerance: M=±20%

- Operating temperature range - 40°C ~ 125°C(Including self - temperature rise)
- Isat for Inductance drop 30% from its value without current
- I rms for a 40°C temperature rise from 25°C ambient with current
- Absolute maximum voltage 25VDC
- Measure Equipment :
 L : Agilent E4991/HP4286A+16197A (or equivalent), 2MHz 0.2V
 RDC : CHEN HWA502BC/HP4338B (or equivalent)
 Isat : Agilent E4980A+HP42841A (or equivalent)
 I rms : Agilent 6641 SYSTEM DC POWER SUPPLY (or equivalent)

Test Instruments : E4991A Impedance / Material Analyzer

Inductance vs. DC Current

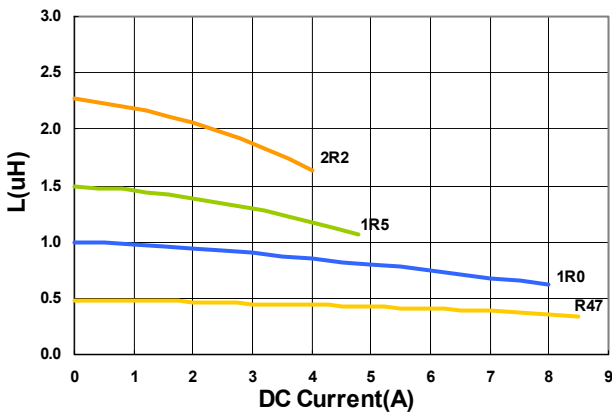

Temperature Change vs. DC Current

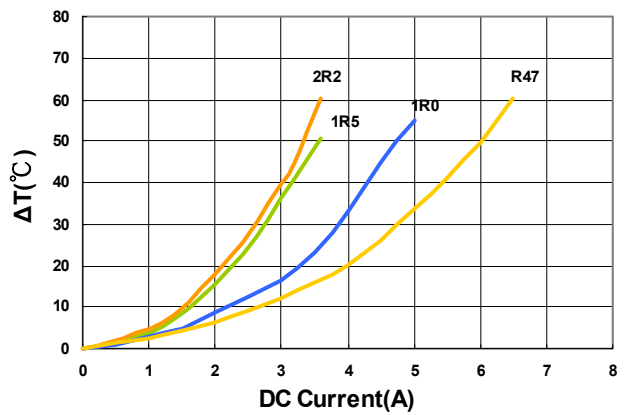

Electrical Characteristics

Part Number	Inductance (uH)	Tolerance (±%)	Test Frequency (MHz)	RDC(mΩ) Max(Typ.)	Isat(A) Max(Typ.)	Irms(A) Max(Typ.)
HEI322525A-1R0M-Q8	1.0	20	2	34(28)	6.0(8.0)	3.5(4.3)
HEI322525A-1R5M-Q8	1.5	20	2	45(35)	5.5(7.5)	3.2(3.9)
HEI322525A-2R2M-Q8	2.2	20	2	60(49)	4.8(6.5)	3.0(3.3)

Note: When ordering, please specify tolerance code. Tolerance: M=±20%

- Operating temperature range - 40°C ~ 125°C(Including self - temperature rise)
- Isat for Inductance drop 30% from its value without current
- I rms for a 40°C temperature rise from 25°C ambient with current
- Absolute maximum voltage 25VDC
- Measure Equipment :
 L : Agilent E4991/HP4286A+16197A (or equivalent), 2MHz 0.2V
 RDC : CHEN HWA502BC/HP4338B (or equivalent)
 Isat : Agilent E4980A+HP42841A (or equivalent)
 I rms : Agilent 6641 SYSTEM DC POWER SUPPLY (or equivalent)

Test Instruments : E4991A Impedance / Material Analyzer

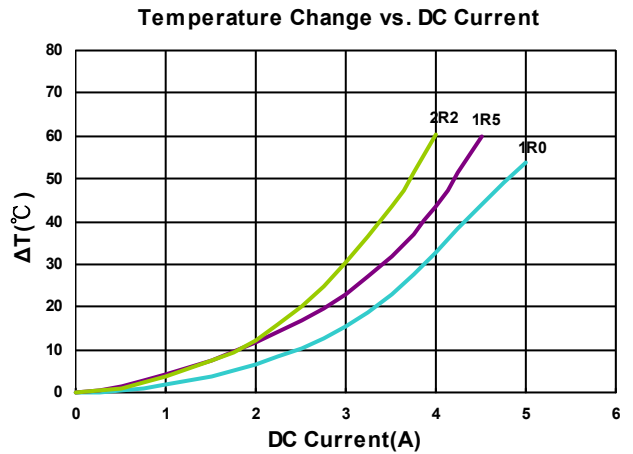
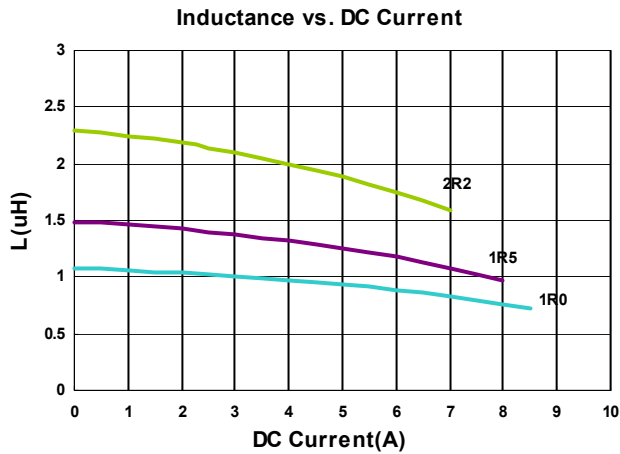

Please be sure to request approval specifications that provide further details of the products. Kindly note that the content of these specifications are subject to change or may be discontinued without advance notice. Please contact our sales department before ordering.

Packaging Specifications

Tape Dimensions

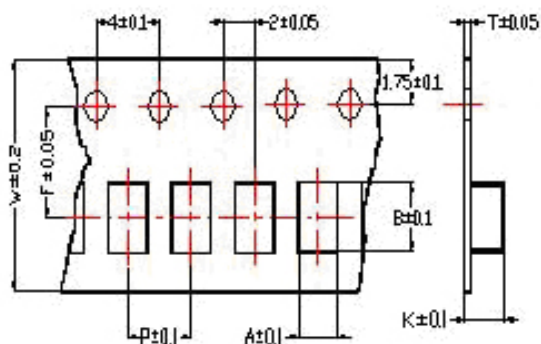

Tape Material

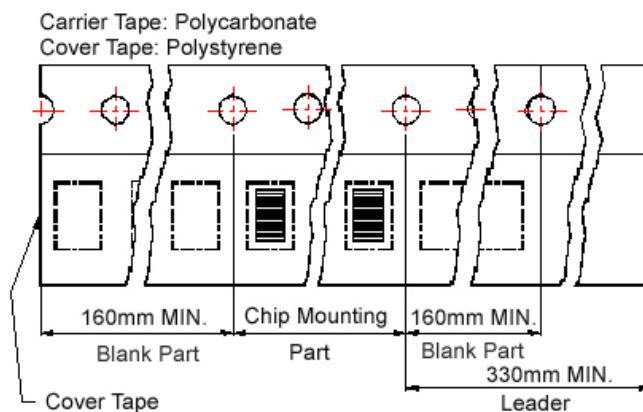

Reel Dimensions

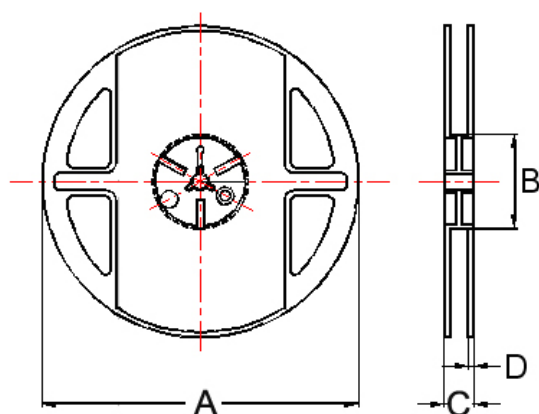

Dimensions in mm

TYPE	Tape Dimensions							Reel Dimensions				Quantity PCS / REEL
	A	B	T	W	P	F	K	A	B	C	D	
160808A	1.20	1.88	0.95	8	4	3.5	-	178	60	12	1.5	4000
201208A	1.45	2.25	0.22	8	4	3.5	1.04	178	60	12	1.5	3000
201210A	1.50	2.25	0.22	8	4	3.5	1.15	178	60	12	1.5	3000
201608A	1.80	2.35	0.23	8	4	3.5	0.85	178	60	12	1.5	3000
201610A	1.80	2.20	0.22	8	4	3.5	1.15	178	60	12	1.5	3000
252010A	2.25	2.80	0.22	8	4	3.5	1.15	178	60	12	1.5	3000
252012A	2.25	2.80	0.22	8	4	3.5	1.35	178	60	12	1.5	3000
322510A	2.80	3.55	0.23	8	4	3.5	1.20	178	60	12	1.5	3000
322512A	2.80	3.50	0.23	8	4	3.5	1.34	178	60	12	1.5	3000
322525A	2.90	3.50	0.23	8	4	3.5	2.90	178	60	12	1.5	1500

HEIL Series



The HEIL Series is designed specifically to enhance both PFM and PWM application performance. Q(Rac) value at light load and the RDC value at heavy load are both exceptional. Furthermore, the saturated current performance is also optimal, helping to reduce the ripple current and enhance the efficiency.

Features

- RoHS, Halogen Free and REACH Compliance
- High Efficiency
- Excellent Q, RDC and saturation current
- Low profile and miniature size down to 2.0*1.6*1.0mm

Applications

- Smartphones, tablets and wearable devices
- HDD, SSD and PC peripheral devices
- DSC, camcorders
- PND
- DC/DC converters

Product Identification

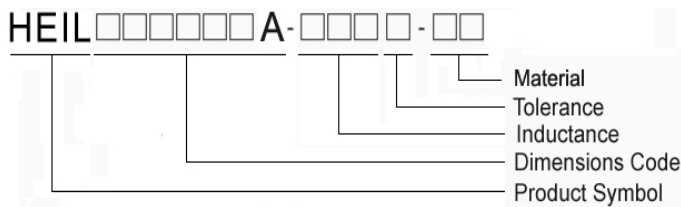

Shape and Dimensions

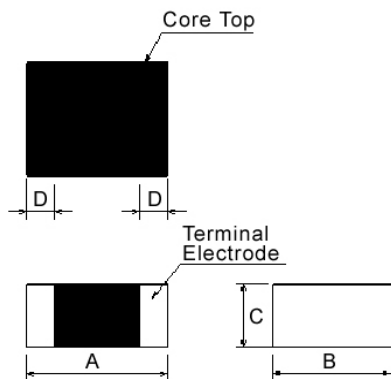

Dimensions in mm

TYPE	A	B	C	D
201610A	2.0±0.2	1.60±0.2	1.0Max	0.5±0.3
252010A	2.5±0.3	2.00±0.3	1.0Max	0.6±0.3
252012A	2.5±0.3	2.00±0.3	1.2Max	0.6±0.3

Recommended Pattern

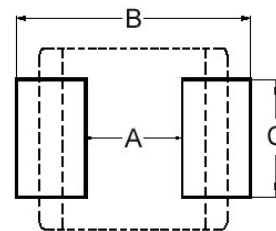

Dimensions in mm

TYPE	A	B	C
201610A	0.7	2.3	1.8
252010A	1.2	2.8	2.3
252012A	1.2	2.8	2.3

Electrical Characteristics

Part Number	Inductance (uH)	Tolerance (±%)	Test Frequency (MHz)	RDC(mΩ) Max(Typ.)	Isat(A) Max(Typ.)	Irms(A) Max(Typ.)
HEIL201610A-R24M-Q8	0.24	20	2	27(21)	5.6(7.0)	3.9(4.8)
HEIL201610A-R33M-Q8	0.33	20	2	23(17.5)	5.3(6.0)	4.7(5.1)
HEIL201610A-R47M-Q8	0.47	20	2	42(33)	3.9(4.8)	3.5(4.2)
HEIL201610A-R68M-Q8	0.68	20	2	56(43)	3.2(4.0)	2.7(3.4)
HEIL201610A-1R0M-Q8	1.0	20	2	65(53)	2.9(3.6)	2.5(3.1)
HEIL201610A-1R5M-Q8	1.5	20	2	85(75)	2.5(2.8)	2.3(2.7)
HEIL201610A-2R2M-Q8	2.2	20	2	135(112)	2.4(2.7)	1.8(2.2)

Note: When ordering, please specify tolerance code. Tolerance: M=±20%

- Operating temperature range - 40°C ~ 125°C(Including self - temperature rise)
- Isat for Inductance drop 30% from its value without current
- I rms for a 40°C temperature rise from 25°C ambient with current
- Absolute maximum voltage 25VDC
- Measure Equipment :
 - L : Agilent E4991/HP4286A+16197A (or equivalent), 2MHz 0.2V
 - RDC : CHEN HWA502BC/HP4338B (or equivalent)
 - Isat : Agilent E4980A+HP42841A (or equivalent)
 - I rms : Agilent 6641 SYSTEM DC POWER SUPPLY (or equivalent)

Test Instruments : E4991A Impedance / Material Analyzer

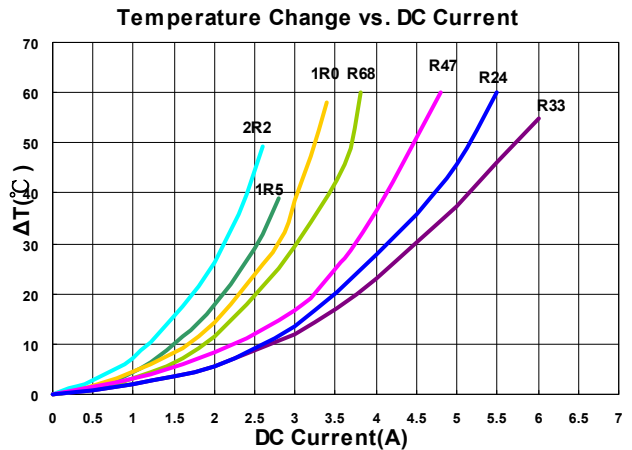
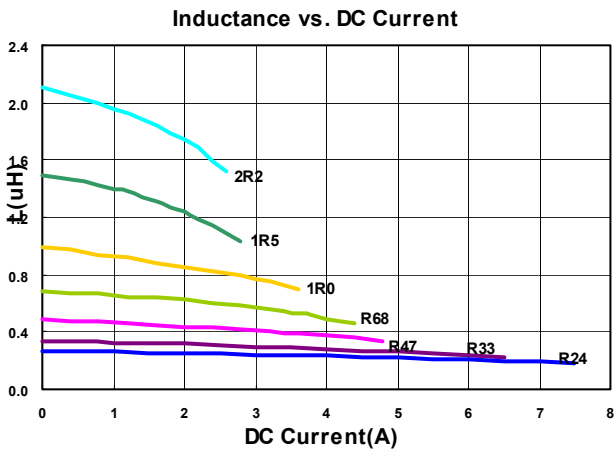

Please be sure to request approval specifications that provide further details of the products. Kindly note that the content of these specifications are subject to change or may be discontinued without advance notice. Please contact our sales department before ordering.

Electrical Characteristics

Part Number	Inductance (uH)	Tolerance (±%)	Test Frequency (MHz)	RDC(mΩ) Max(Typ.)	Isat(A) Max(Typ.)	Irms(A) Max(Typ.)
HEIL252010A-R24M-Q8	0.24	20	2	18(13)	8.0(9.5)	5.5(6.5)
HEIL252010A-R33M-Q8	0.33	20	2	24(18)	6.5(8.0)	4.8(5.5)
HEIL252010A-R47M-Q8	0.47	20	2	35(27)	5.0(6.2)	3.9(4.5)
HEIL252010A-R68M-Q8	0.68	20	2	40(32)	4.5(5.6)	3.7(4.2)
HEIL252010A-1R0M-Q8	1.0	20	2	53(45)	3.7(4.6)	3.0(3.5)
HEIL252010A-1R5M-Q8	1.5	20	2	75(68)	3.1(3.8)	2.4(2.8)
HEIL252010A-2R2M-Q8	2.2	20	2	97(87)	2.5(3.0)	2.2(2.5)

Note: When ordering, please specify tolerance code. Tolerance: M=±20%

- Operating temperature range - 40°C ~ 125°C(Including self - temperature rise)
- Isat for Inductance drop 30% from its value without current
- I rms for a 40°C temperature rise from 25°C ambient with current
- Absolute maximum voltage 25VDC
- Measure Equipment :
 - L : Agilent E4991/HP4286A+16197A (or equivalent), 2MHz 0.2V
 - RDC : CHEN HWA502BC/HP4338B (or equivalent)
 - Isat : Agilent E4980A+HP42841A (or equivalent)
 - I rms : Agilent 6641 SYSTEM DC POWER SUPPLY (or equivalent)

Test Instruments : E4991A Impedance / Material Analyzer

Inductance vs. DC Current

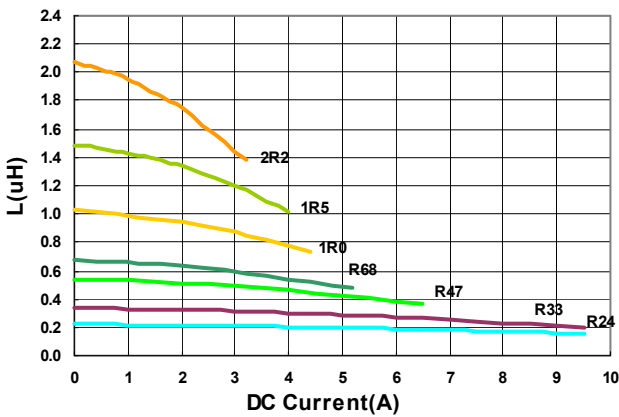

Temperature Change vs. DC Current

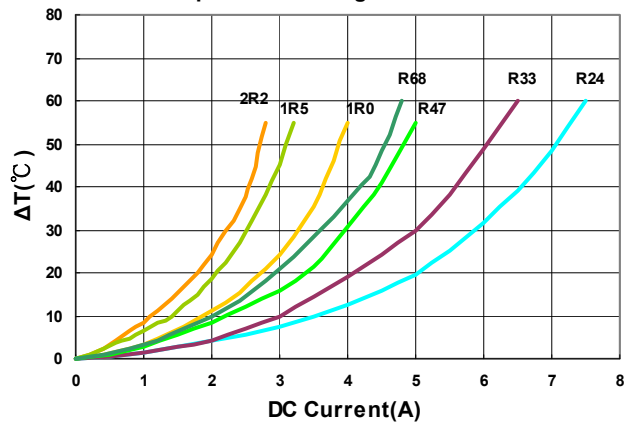

Please be sure to request approval specifications that provide further details of the products. Kindly note that the content of these specifications are subject to change or may be discontinued without advance notice. Please contact our sales department before ordering.

Electrical Characteristics

Part Number	Inductance (uH)	Tolerance (±%)	Test Frequency (MHz)	RDC(mΩ) Max(Typ.)	Isat(A) Max(Typ.)	Irms(A) Max(Typ.)
HEIL252012A-R24M-Q8	0.24	20	2	15(11.5)	9.0(10.5)	6.2(7.3)
HEIL252012A-R33M-Q8	0.33	20	2	18(14.5)	8.5(10)	5.8(6.4)
HEIL252012A-R47M-Q8	0.47	20	2	33(28)	5.6(7.0)	3.8(4.5)
HEIL252012A-R68M-Q8	0.68	20	2	36(30)	5.0(6.2)	3.8(4.4)
HEIL252012A-1R0M-Q8	1.0	20	2	42(35)	4.4(5.5)	3.6(4.1)
HEIL252012A-1R5M-Q8	1.5	20	2	65(57)	3.4(4.2)	2.7(3.1)
HEIL252012A-2R2M-Q8	2.2	20	2	83(74)	3.0(3.7)	2.5(2.9)

Note: When ordering, please specify tolerance code. Tolerance: M=±20%

- Operating temperature range - 40°C ~ 125°C(Including self - temperature rise)
- Isat for Inductance drop 30% from its value without current
- I rms for a 40°C temperature rise from 25°C ambient with current
- Absolute maximum voltage 25VDC
- Measure Equipment :
 - L : Agilent E4991/HP4286A+16197A (or equivalent), 2MHz 0.2V
 - RDC : CHEN HWA502BC/HP4338B (or equivalent)
 - Isat : Agilent E4980A+HP42841A (or equivalent)
 - I rms : Agilent 6641 SYSTEM DC POWER SUPPLY (or equivalent)

Test Instruments : E4991A Impedance / Material Analyzer

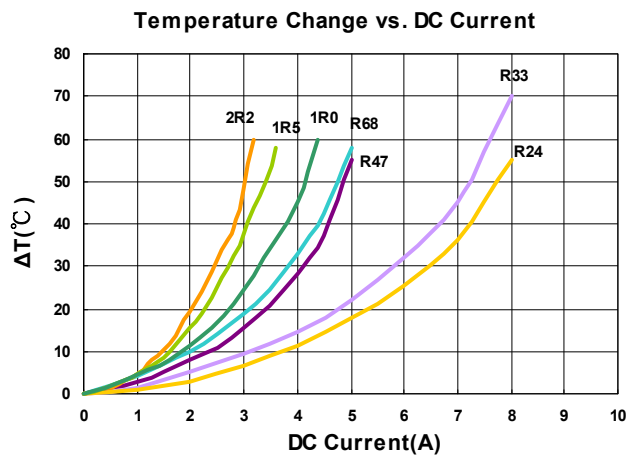
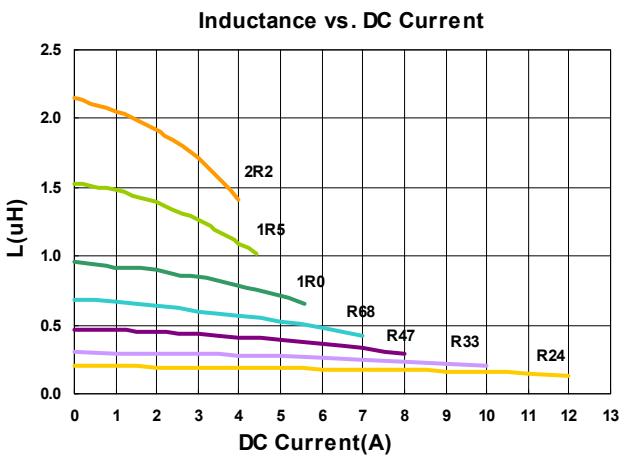

Please be sure to request approval specifications that provide further details of the products. Kindly note that the content of these specifications are subject to change or may be discontinued without advance notice. Please contact our sales department before ordering.

Packaging Specifications

Tape Dimensions

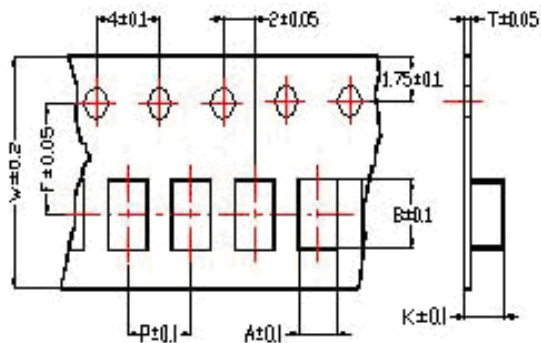

Tape Material

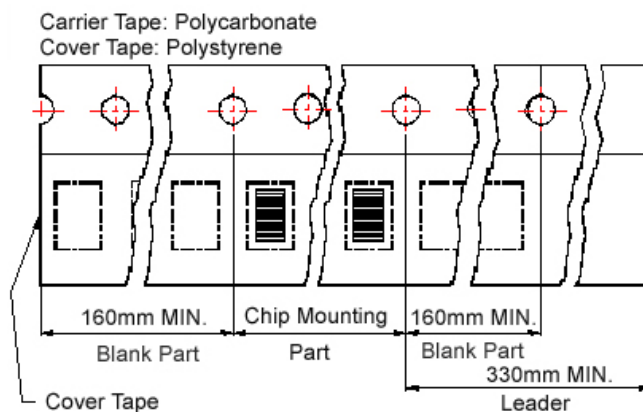

Reel Dimensions

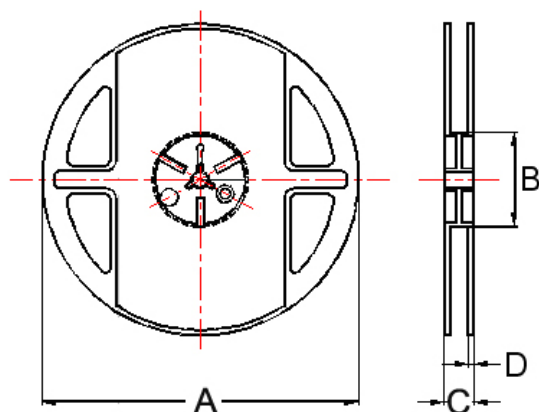

Dimensions in mm

TYPE	Tape Dimensions							Reel Dimensions				Quantity PCS / REEL
	A	B	T	W	P	F	K	A	B	C	D	
201610A	1.80	2.20	0.22	8	4	3.5	1.15	178	60	12	1.5	3000
252010A	2.25	2.80	0.22	8	4	3.5	1.15	178	60	12	1.5	3000
252012A	2.25	2.80	0.22	8	4	3.5	1.35	178	60	12	1.5	3000

MHCD Series



MHCD Series provides high current in compact package size with magnetically shielded construction. This power inductor is an excellent power solution for space-limited devices.

Features

- RoHS, Halogen Free and REACH Compliance
- Monolithic, magnetically shielded
- Capable for large current

Applications

- Smartphones, tablets and wearable devices
- HDD, SSD and PC peripheral devices
- DSC, camcoders
- PND
- DC/DC converters

Product Identification

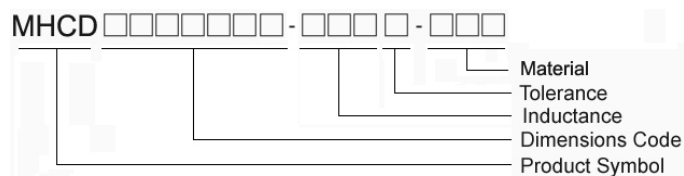

Shape and Dimensions

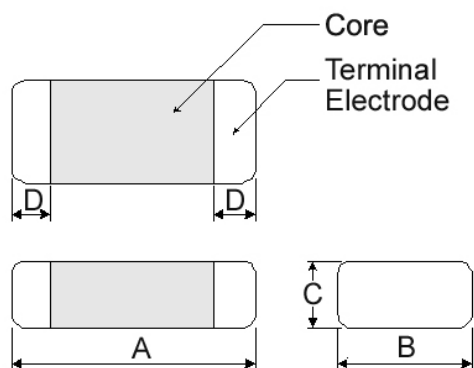

Dimensions in mm

TYPE	A	B	C	D
201610	2.0±0.2	1.6±0.2	1.0Max	0.5±0.3
201612	2.0±0.2	1.6±0.2	1.2Max	0.5±0.3
252010	2.5±0.2	2.0±0.2	1.0Max	0.6±0.3
252012	2.5±0.2	2.0±0.2	1.2Max	0.6±0.3
322510	3.2±0.3	2.5±0.3	1.0Max	0.5±0.3
322512	3.2±0.3	2.5±0.3	1.2Max	0.5±0.3

Recommended Pattern

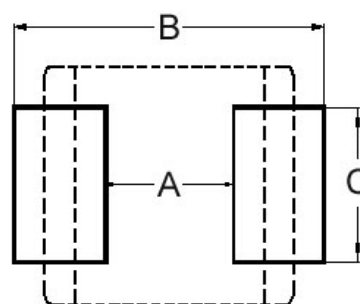

Dimensions in mm

TYPE	A	B	C
201610	0.7	2.3	1.8
201612	0.7	2.3	1.8
252010	1.2	2.8	2.3
252012	1.2	2.8	2.3
322510	1.7	3.5	2.8
322512	1.7	3.5	2.8

Electrical Characteristics

Part Number	Inductance (uH)	Tolerance (±%)	Test Frequency (MHz)	RDC(mΩ) Max(Typ.)	Isat(A) Max(Typ.)	Irms(A) Max(Typ.)
MHCD201610A-R24M-A8S	0.24	20	2	40(28)	4.2(6.0)	4.0(4.5)
MHCD201610A-R33M-A8S	0.33	20	2	48(40)	4.0(5.5)	3.5(3.8)
MHCD201610A-R47M-A8S	0.47	20	2	54(44)	3.2(5.0)	3.0(3.6)
MHCD201610A-R56M-A8S	0.56	20	2	59(46)	2.8(4.6)	2.8(3.3)
MHCD201610A-R68M-A8S	0.68	20	2	72(55)	2.7(4.2)	2.4(3.0)
MHCD201610A-1R0M-A8S	1.0	20	2	96(81)	2.2(3.4)	2.0(2.3)
MHCD201610A-1R5M-A8S	1.5	20	2	150(122)	2.1(2.8)	1.6(2.0)
MHCD201610A-2R2M-A8S	2.2	20	2	204(170)	2.0(2.4)	1.3(1.6)

Note: When ordering, please specify tolerance code. Tolerance: M=±20%

- Operating temperature range - 40°C ~ 125°C(Including self - temperature rise)
- Isat for Inductance drop 30% from its value without current
- I rms for a 40°C temperature rise from 25°C ambient with current
- Absolute maximum voltage 25VDC
- Measure Equipment :
 L : Agilent E4991/HP4286A+16197A (or equivalent), 2MHz 0.2V
 RDC : CHEN HWA502BC/HP4338B (or equivalent)
 Isat : Agilent E4980A+HP42841A (or equivalent)
 I rms : Agilent 6641 SYSTEM DC POWER SUPPLY (or equivalent)

Test Instruments : E4991A Impedance / Material Analyzer

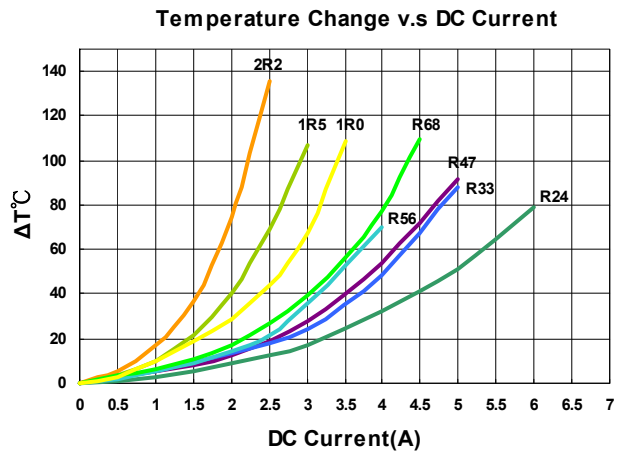
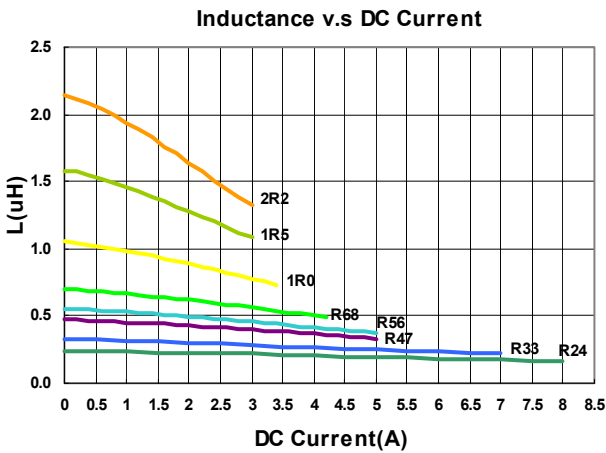

Please be sure to request approval specifications that provide further details of the products. Kindly note that the content of these specifications are subject to change or may be discontinued without advance notice. Please contact our sales department before ordering.

Electrical Characteristics

Part Number	Inductance (uH)	Tolerance (±%)	Test Frequency (MHz)	RDC(mΩ) Max(Typ.)	Isat(A) Max(Typ.)	Irms(A) Max(Typ.)
MHCD201610B-R24M-A8L	0.24	20	2	30(23)	5.0(6.0)	3.8(4.4)
MHCD201610B-R47M-A8L	0.47	20	2	41(34)	4.0(4.5)	2.9(3.3)
MHCD201610B-R68M-A8L	0.68	20	2	53(44)	3.3(3.6)	2.5(2.9)
MHCD201610B-1R0M-A8L	1.0	20	2	72(60)	2.8(3.2)	2.2(2.5)
MHCD201610B-2R2M-A8L	2.2	20	2	170(142)	1.8(2.1)	1.5(1.7)

Note: When ordering, please specify tolerance code. Tolerance: M=±20%

- Operating temperature range - 40°C ~ 125°C(Including self - temperature rise)
- Isat for Inductance drop 30% from its value without current
- I rms for a 40°C temperature rise from 25°C ambient with current
- Absolute maximum voltage 25VDC
- Measure Equipment :
 L : Agilent E4991/HP4286A+16197A (or equivalent), 2MHz 0.2V
 RDC : CHEN HWA502BC/HP4338B (or equivalent)
 Isat : Agilent E4980A+HP42841A (or equivalent)
 I rms : Agilent 6641 SYSTEM DC POWER SUPPLY (or equivalent)

Test Instruments : E4991A Impedance / Material Analyzer

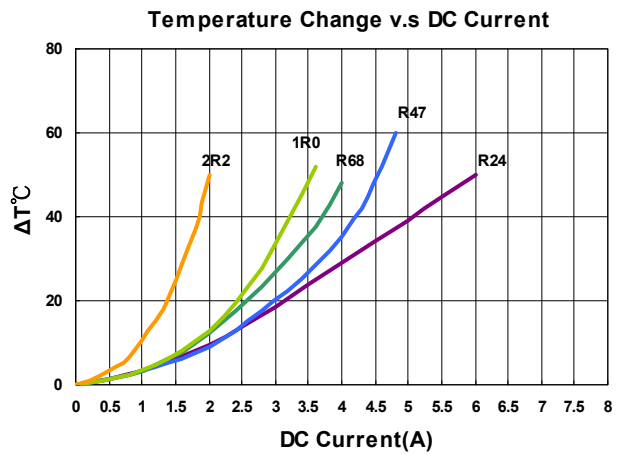
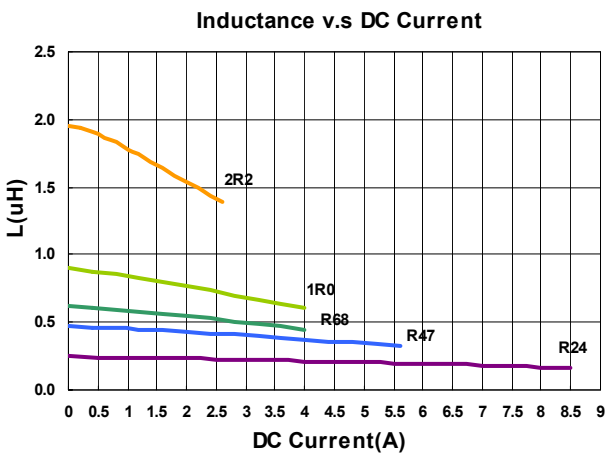

Electrical Characteristics

Part Number	Inductance (uH)	Tolerance (±%)	Test Frequency (MHz)	RDC(mΩ) Max(Typ.)	Isat(A) Max(Typ.)	Irms(A) Max(Typ.)
MHCD201612A-R24M-A8S	0.24	20	2	35(25)	5.5(6.5)	4.2(4.8)
MHCD201612A-R47M-A8S	0.47	20	2	52(40)	3.8(5.1)	3.2(3.8)
MHCD201612A-R68M-A8S	0.68	20	2	70(53)	3.3(4.8)	2.6(3.2)
MHCD201612A-1R0M-A8S	1.0	20	2	82(67)	3.1(3.9)	2.3(2.7)
MHCD201612A-1R5M-A8S	1.5	20	2	120(95)	2.6(3.2)	2.2(2.6)
MHCD201612A-2R2M-A8S	2.2	20	2	195(165)	2.0(2.6)	1.3(1.7)

Note: When ordering, please specify tolerance code. Tolerance: M=±20%

- Operating temperature range - 40°C ~ 125°C(Including self - temperature rise)
- Isat for Inductance drop 30% from its value without current
- I rms for a 40°C temperature rise from 25°C ambient with current
- Absolute maximum voltage 25VDC
- Measure Equipment :
 L : Agilent E4991/HP4286A+16197A (or equivalent), 2MHz 0.2V
 RDC : CHEN HWA502BC/HP4338B (or equivalent)
 Isat : Agilent E4980A+HP42841A (or equivalent)
 I rms : Agilent 6641 SYSTEM DC POWER SUPPLY (or equivalent)

Test Instruments : E4991A Impedance / Material Analyzer

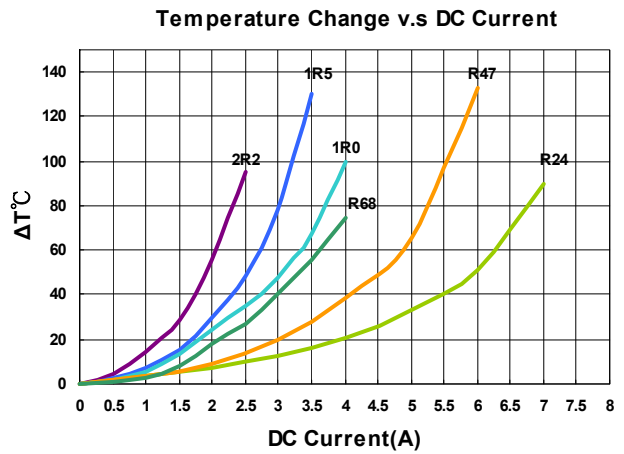
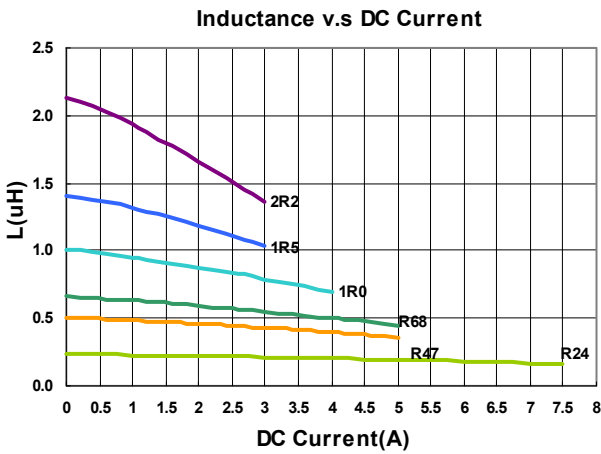

Electrical Characteristics

Part Number	Inductance (uH)	Tolerance (±%)	Test Frequency (MHz)	RDC(mΩ) Max(Typ.)	Isat(A) Max(Typ.)	Irms(A) Max(Typ.)
MHCD252010A-R24M-A8S	0.24	20	2	40(24)	7.5(9.5)	4.5(5.0)
MHCD252010A-R47M-A8S	0.47	20	2	46(36)	5.2(6.5)	3.1(3.6)
MHCD252010A-R68M-A8S	0.68	20	2	65(49)	3.8(5.0)	2.9(3.3)
MHCD252010A-1R0M-A8S	1.0	20	2	78(60)	3.4(4.3)	2.5(3.0)
MHCD252010A-1R5M-A8S	1.5	20	2	105(82)	3.2(4.0)	2.2(2.9)
MHCD252010A-2R2M-A8S	2.2	20	2	156(130)	2.6(3.2)	1.4(1.8)

Note: When ordering, please specify tolerance code. Tolerance: M=±20%

- Operating temperature range - 40°C ~ 125°C(Including self - temperature rise)
- Isat for Inductance drop 30% from its value without current
- Irms for a 40°C temperature rise from 25°C ambient with current
- Absolute maximum voltage 25VDC
- Measure Equipment :
 - L : Agilent E4991/HP4286A+16197A (or equivalent), 2MHz 0.2V
 - RDC : CHEN HWA502BC/HP4338B (or equivalent)
 - Isat : Agilent E4980A+HP42841A (or equivalent)
 - Irms : Agilent 6641 SYSTEM DC POWER SUPPLY (or equivalent)

Test Instruments : E4991A Impedance / Material Analyzer

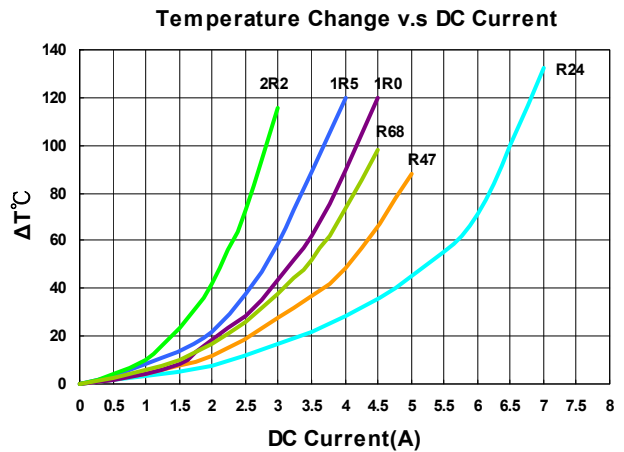
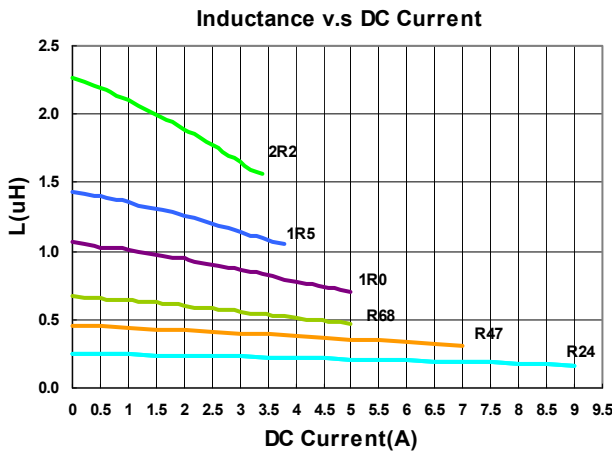

Please be sure to request approval specifications that provide further details of the products. Kindly note that the content of these specifications are subject to change or may be discontinued without advance notice. Please contact our sales department before ordering.

Electrical Characteristics

Part Number	Inductance (uH)	Tolerance (±%)	Test Frequency (MHz)	RDC(mΩ) Max(Typ.)	Isat(A) Max(Typ.)	Irms(A) Max(Typ.)
MHCD252010B-R33M-A8L	0.33	20	2	31(25)	5.0(6.0)	3.8(4.4)
MHCD252010B-R47M-A8L	0.47	20	2	35(29)	4.2(4.7)	3.4(3.9)
MHCD252010B-R68M-A8L	0.68	20	2	48(40)	3.7(4.0)	3.0(3.5)
MHCD252010B-1R0M-A8L	1.0	20	2	65(54)	3.2(3.6)	2.6(3.0)
MHCD252010B-1R5M-A8L	1.5	20	2	94(78)	2.9(3.3)	2.1(2.4)
MHCD252010B-2R2M-A8L	2.2	20	2	120(100)	2.3(2.7)	1.8(2.1)

Note: When ordering, please specify tolerance code. Tolerance: M=±20%

- Operating temperature range - 40°C ~ 125°C(Including self - temperature rise)
- Isat for Inductance drop 30% from its value without current
- I rms for a 40°C temperature rise from 25°C ambient with current
- Absolute maximum voltage 25VDC
- Measure Equipment :
 L : Agilent E4991/HP4286A+16197A (or equivalent), 2MHz 0.2V
 RDC : CHEN HWA502BC/HP4338B (or equivalent)
 Isat : Agilent E4980A+HP42841A (or equivalent)
 I rms : Agilent 6641 SYSTEM DC POWER SUPPLY (or equivalent)

Test Instruments : E4991A Impedance / Material Analyzer

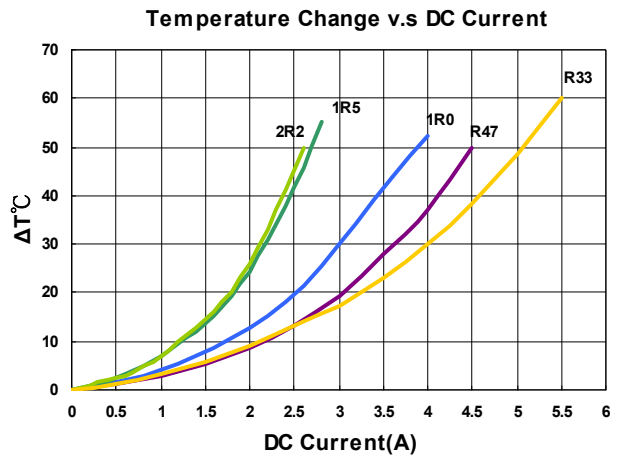
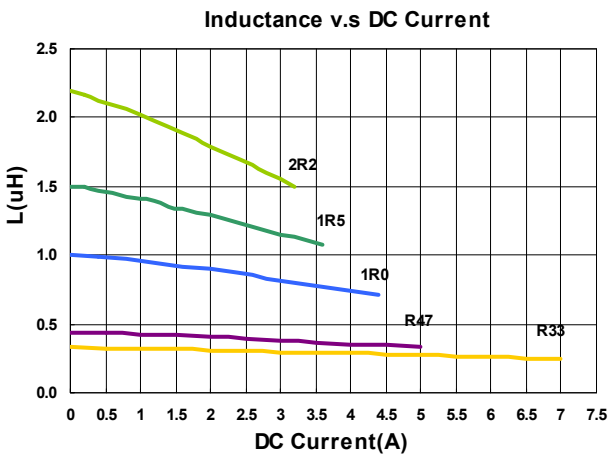

Electrical Characteristics

Part Number	Inductance (uH)	Tolerance (±%)	Test Frequency (MHz)	RDC(mΩ) Max(Typ.)	Isat(A) Max(Typ.)	Irms(A) Max(Typ.)
MHCD252012A-R33M-A8S	0.33	20	2	35(27)	6.8(8.5)	4.0(4.6)
MHCD252012A-R47M-A8S	0.47	20	2	39(29)	6.2(7.8)	3.7(4.4)
MHCD252012A-R68M-A8S	0.68	20	2	46(40)	5.5(6.5)	3.3(3.7)
MHCD252012A-1R0M-A8S	1.0	20	2	59(45)	4.0(5.0)	3.0(3.5)
MHCD252012A-1R5M-A8S	1.5	20	2	70(62)	3.4(4.0)	2.5(2.7)
MHCD252012A-2R2M-A8S	2.2	20	2	115(102)	3.3(3.8)	2.0(2.3)

Note: When ordering, please specify tolerance code. Tolerance: M=±20%

- Operating temperature range - 40°C ~ 125°C(Including self - temperature rise)
- Isat for Inductance drop 30% from its value without current
- Irms for a 40°C temperature rise from 25°C ambient with current
- Absolute maximum voltage 25VDC
- Measure Equipment :
 - L : Agilent E4991/HP4286A+16197A (or equivalent), 2MHz 0.2V
 - RDC : CHEN HWA502BC/HP4338B (or equivalent)
 - Isat : Agilent E4980A+HP42841A (or equivalent)
 - Irms : Agilent 6641 SYSTEM DC POWER SUPPLY (or equivalent)

Test Instruments : E4991A Impedance / Material Analyzer

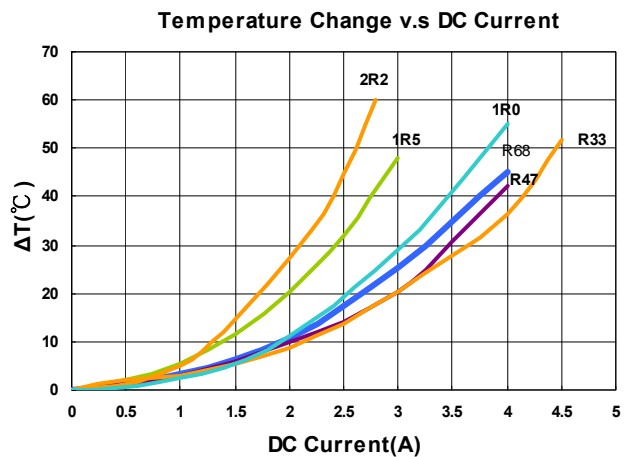
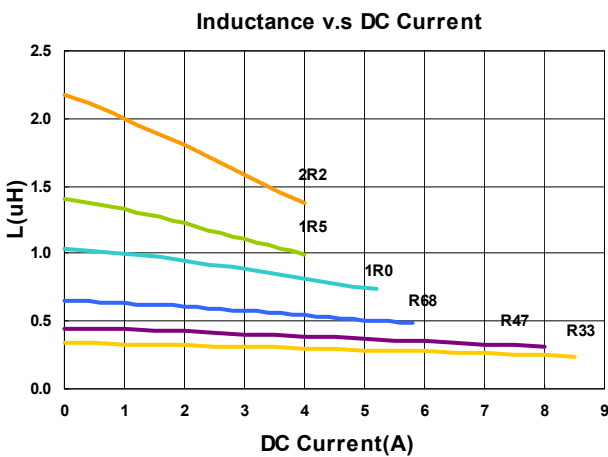

Please be sure to request approval specifications that provide further details of the products. Kindly note that the content of these specifications are subject to change or may be discontinued without advance notice. Please contact our sales department before ordering.

Electrical Characteristics

Part Number	Inductance (uH)	Tolerance (±%)	Test Frequency (MHz)	RDC(mΩ) Max(Typ.)	Isat(A) Max(Typ.)	Irms(A) Max(Typ.)
MHCD252012B-R47M-A8L	0.47	20	2	34(30)	5.2(6.0)	4.1(4.7)
MHCD252012B-1R0M-A8L	1.0	20	2	56(45)	3.6(4.5)	3.2(3.7)
MHCD252012B-2R2M-A8L	2.2	20	2	102(80)	2.5(3.0)	2.2(2.6)

Note: When ordering, please specify tolerance code. Tolerance: M=±20%

- Operating temperature range - 40°C ~ 125°C(Including self - temperature rise)
- Isat for Inductance drop 30% from its value without current
- I rms for a 40°C temperature rise from 25°C ambient with current
- Absolute maximum voltage 25VDC
- Measure Equipment :
 - L : Agilent E4991/HP4286A+16197A (or equivalent), 2MHz 0.2V
 - RDC : CHEN HWA502BC/HP4338B (or equivalent)
 - Isat : Agilent E4980A+HP42841A (or equivalent)
 - I rms : Agilent 6641 SYSTEM DC POWER SUPPLY (or equivalent)

Test Instruments : E4991A Impedance / Material Analyzer

Inductance v.s DC Current

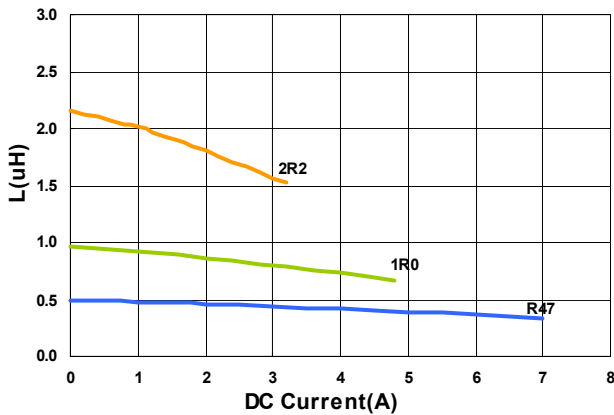

Temperature Change v.s DC Current

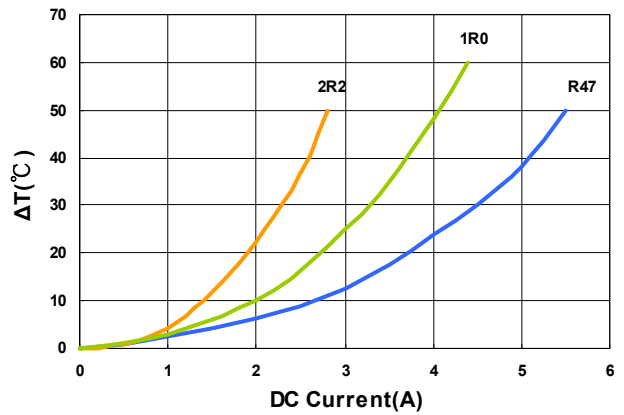

Electrical Characteristics

Part Number	Inductance (uH)	Tolerance (±%)	Test Frequency (MHz)	RDC(mΩ) Max(Typ.)	Isat(A) Max(Typ.)	Irms(A) Max(Typ.)
MHCD322510A-R47M-A8S	0.47	20	2	37(30)	5.8(6.6)	3.6(4.2)
MHCD322510A-1R0M-A8S	1.0	20	2	56(49)	4.0(4.6)	3.0(3.3)
MHCD322510A-1R5M-A8S	1.5	20	2	75(66)	3.4(4.0)	2.6(3.0)
MHCD322510A-2R2M-A8S	2.2	20	2	108(95)	2.7(3.2)	2.2(2.5)

Note: When ordering, please specify tolerance code. Tolerance: M=±20%

- Operating temperature range - 40°C ~ 125°C(Including self - temperature rise)
- Isat for Inductance drop 30% from its value without current
- I rms for a 40°C temperature rise from 25°C ambient with current
- Absolute maximum voltage 25VDC
- Measure Equipment :
 - L : Agilent E4991/HP4286A+16197A (or equivalent), 2MHz 0.2V
 - RDC : CHEN HWA502BC/HP4338B (or equivalent)
 - Isat : Agilent E4980A+HP42841A (or equivalent)
 - I rms : Agilent 6641 SYSTEM DC POWER SUPPLY (or equivalent)

Test Instruments : E4991A Impedance / Material Analyzer

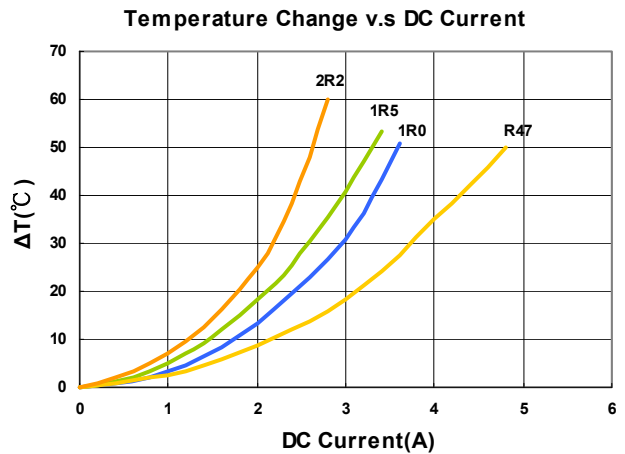
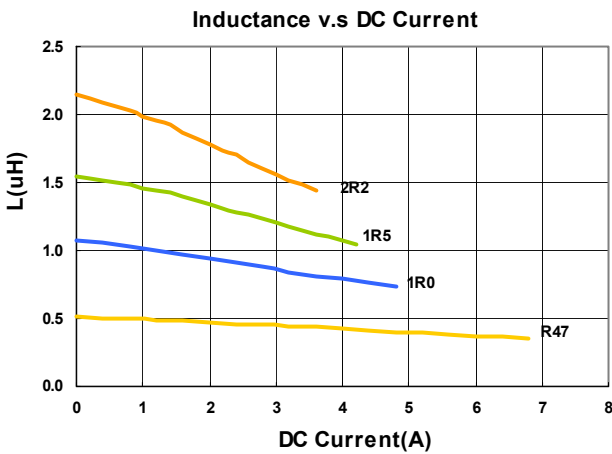

Electrical Characteristics

Part Number	Inductance (uH)	Tolerance (±%)	Test Frequency (MHz)	RDC(mΩ) Max(Typ.)	Isat(A) Max(Typ.)	Irms(A) Max(Typ.)
MHCD322512A-R47M-A8S	0.47	20	2	27(21)	8.0(9.0)	5.0(5.8)
MHCD322512A-R68M-A8S	0.68	20	2	34(26)	6.3(7.5)	4.0(4.6)
MHCD322512A-1R0M-A8S	1.0	20	2	42(34)	5.8(6.3)	3.8(4.2)
MHCD322512A-1R5M-A8S	1.5	20	2	68(58)	4.0(4.5)	2.8(3.2)
MHCD322512A-2R2M-A8S	2.2	20	2	85(75)	3.6(4.0)	2.4(2.7)

Note: When ordering, please specify tolerance code. Tolerance: M=±20%

- Operating temperature range - 40°C ~ 125°C(Including self - temperature rise)
- Isat for Inductance drop 30% from its value without current
- I rms for a 40°C temperature rise from 25°C ambient with current
- Absolute maximum voltage 25VDC
- Measure Equipment :
 L : Agilent E4991/HP4286A+16197A (or equivalent), 2MHz 0.2V
 RDC : CHEN HWA502BC/HP4338B (or equivalent)
 Isat : Agilent E4980A+HP42841A (or equivalent)
 I rms : Agilent 6641 SYSTEM DC POWER SUPPLY (or equivalent)

Test Instruments : E4991A Impedance / Material Analyzer

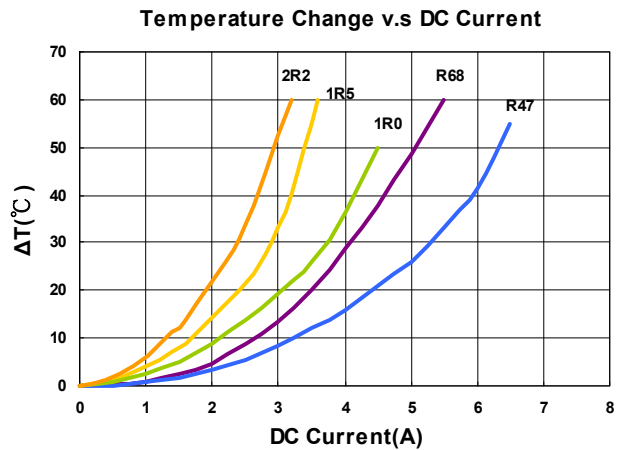
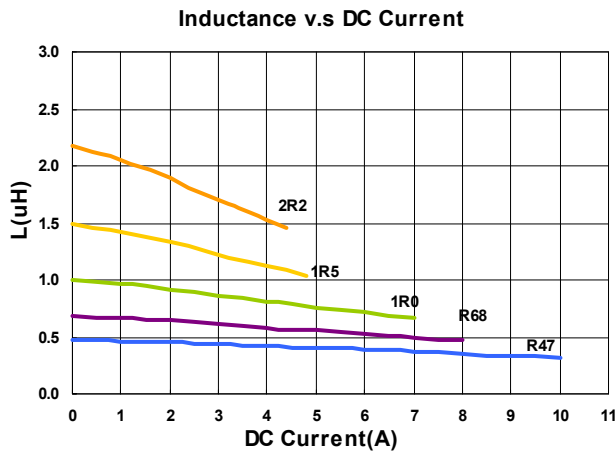

Please be sure to request approval specifications that provide further details of the products. Kindly note that the content of these specifications are subject to change or may be discontinued without advance notice. Please contact our sales department before ordering.

Packaging Specifications

Tape Dimensions

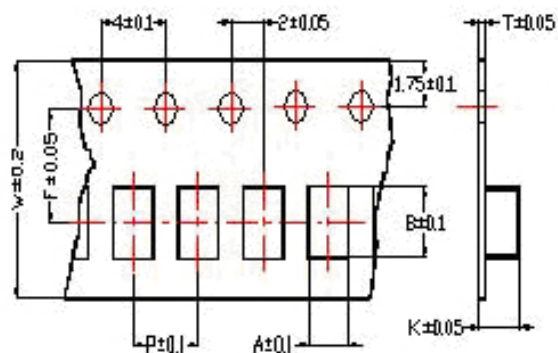

Tape Material

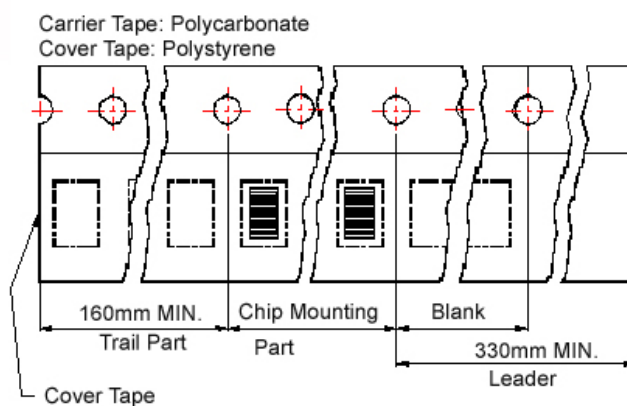

Reel Dimensions

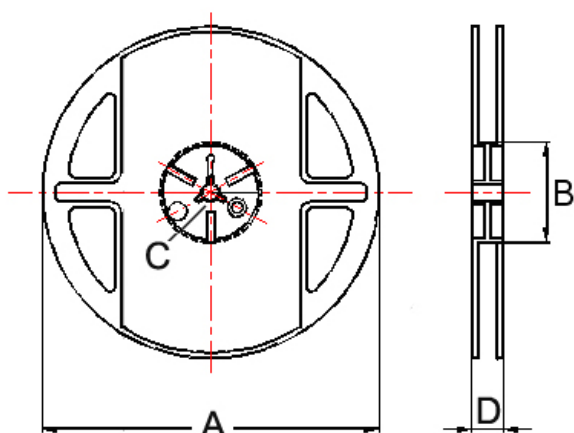

Dimensions in mm

TYPE	Tape Dimensions							Reel Dimensions				Quantity PCS / REEL
	A	B	T	W	P	F	K	A	B	C	D	
201610	1.80	2.20	0.22	8	4	3.5	1.15	178	60	12	1.5	3000
201612	1.80	2.20	0.22	8	4	3.5	1.15	178	60	12	1.5	3000
252010	2.25	2.80	0.22	8	4	3.5	1.15	178	60	12	1.5	3000
252012	2.25	2.80	0.22	8	4	3.5	1.35	178	60	12	1.5	3000
322510	2.80	3.55	0.23	8	4	3.5	1.20	178	60	12	1.5	3000
322512	2.80	3.50	0.23	8	4	3.5	1.34	178	60	12	1.5	3000

MHCL Series



MHCL Series provides high current in compact package size with magnetically shielded construction. This power inductor is an excellent power solution for space-limited devices.

Features

- RoHS, Halogen Free and REACH Compliance
- Monolithic, magnetically shielded
- Capable for large current

Applications

- Smartphones, tablets and wearable devices
- HDD, SSD and PC peripheral devices
- DSC, camcoders
- PND
- DC/DC converters

Product Identification

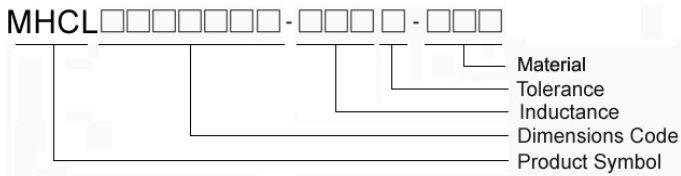

Shape and Dimensions

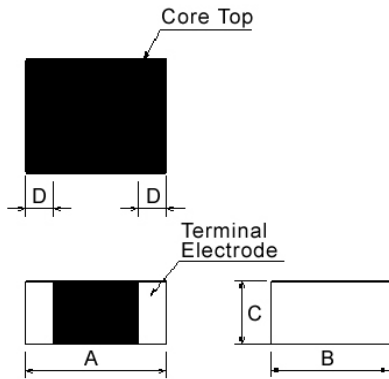

Dimensions in mm

TYPE	A	B	C	D
201610	2.0±0.2	1.6±0.2	1.0Max	0.5±0.3
201612	2.0±0.2	1.6±0.2	1.2Max	0.5±0.3
252010	2.5±0.2	2.0±0.2	1.0Max	0.6±0.3
252012	2.5±0.2	2.0±0.2	1.2Max	0.6±0.3

Recommended Pattern

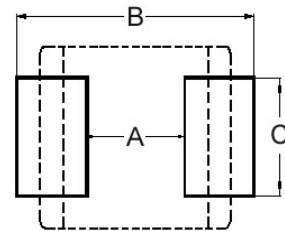

Dimensions in mm

TYPE	A	B	C
201610	0.7	2.3	1.8
201612	0.7	2.3	1.8
252010	1.2	2.8	2.3
252012	1.2	2.8	2.3

Electrical Characteristics

Part Number	Inductance (uH)	Tolerance (±%)	Test Frequency (MHz)	RDC(mΩ) Max(Typ.)	Isat(A) Max(Typ.)	Irms(A) Max(Typ.)
MHCL201610A-R24M-A8S	0.24	20	2	40(28)	4.2(6.0)	4.0(4.5)
MHCL201610A-R33M-A8S	0.33	20	2	48(40)	4.0(5.5)	3.5(3.8)
MHCL201610A-R47M-A8S	0.47	20	2	54(44)	3.2(5.0)	3.0(3.6)
MHCL201610A-R56M-A8S	0.56	20	2	59(46)	2.8(4.6)	2.8(3.3)
MHCL201610A-R68M-A8S	0.68	20	2	72(55)	2.7(4.2)	2.4(3.0)
MHCL201610A-1R0M-A8S	1.0	20	2	96(81)	2.2(3.4)	2.0(2.3)
MHCL201610A-1R5M-A8S	1.5	20	2	150(122)	2.1(2.8)	1.6(2.0)
MHCL201610A-2R2M-A8S	2.2	20	2	204(170)	2.0(2.4)	1.3(1.6)

Note: When ordering, please specify tolerance code. Tolerance: M=±20%

- Operating temperature range - 40°C ~ 125°C(Including self - temperature rise)
- Isat for Inductance drop 30% from its value without current
- Irms for a 40°C temperature rise from 25°C ambient with current
- Absolute maximum voltage 25VDC
- Measure Equipment :
 L : Agilent E4991/HP4286A+16197A (or equivalent), 2MHz 0.2V
 RDC : CHEN HWA502BC/HP4338B (or equivalent)
 Isat : Agilent E4980A+HP42841A (or equivalent)
 Irms : Agilent 6641 SYSTEM DC POWER SUPPLY (or equivalent)

Test Instruments : E4991A Impedance / Material Analyzer

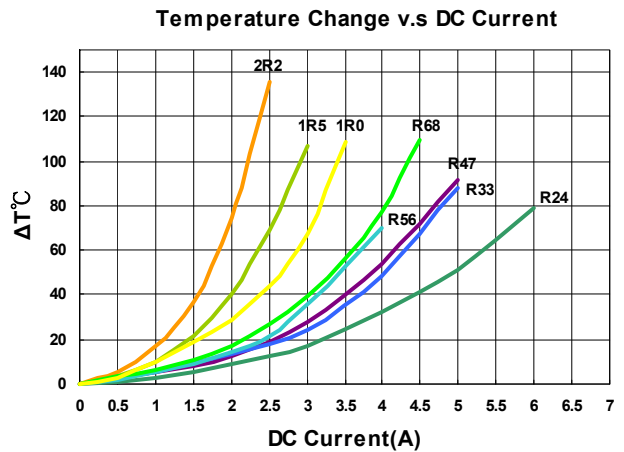
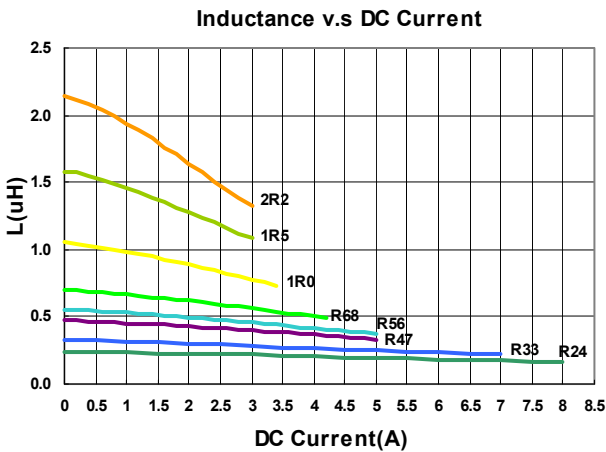

Electrical Characteristics

Part Number	Inductance (uH)	Tolerance (±%)	Test Frequency (MHz)	RDC(mΩ) Max(Typ.)	Isat(A) Max(Typ.)	Irms(A) Max(Typ.)
MHCL201610B-R24M-A8L	0.24	20	2	30(23)	5.0(6.0)	3.8(4.4)
MHCL201610B-R47M-A8L	0.47	20	2	41(34)	4.0(4.5)	2.9(3.3)
MHCL201610B-R68M-A8L	0.68	20	2	53(44)	3.3(3.6)	2.5(2.9)
MHCL201610B-1R0M-A8L	1.0	20	2	72(60)	2.8(3.2)	2.2(2.5)
MHCL201610B-2R2M-A8L	2.2	20	2	170(142)	1.8(2.1)	1.5(1.7)

Note: When ordering, please specify tolerance code. Tolerance: M=±20%

- Operating temperature range - 40°C ~ 125°C(Including self - temperature rise)
- Isat for Inductance drop 30% from its value without current
- I rms for a 40°C temperature rise from 25°C ambient with current
- Absolute maximum voltage 25VDC
- Measure Equipment :
 L : Agilent E4991/HP4286A+16197A (or equivalent), 2MHz 0.2V
 RDC : CHEN HWA502BC/HP4338B (or equivalent)
 Isat : Agilent E4980A+HP42841A (or equivalent)
 I rms : Agilent 6641 SYSTEM DC POWER SUPPLY (or equivalent)

Test Instruments : E4991A Impedance / Material Analyzer

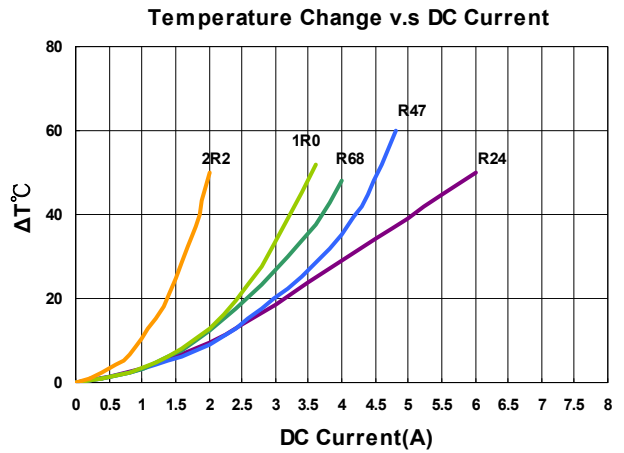
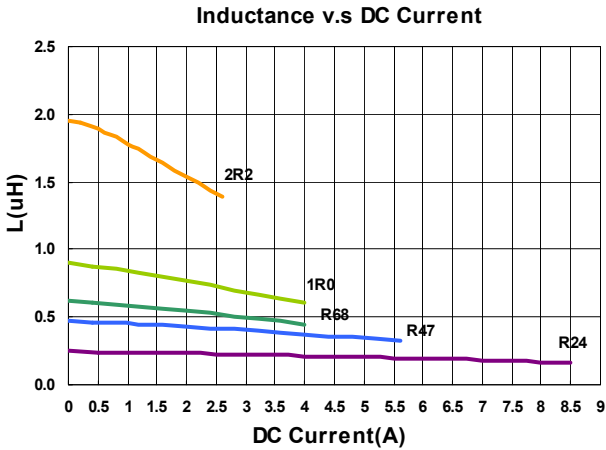

Electrical Characteristics

Part Number	Inductance (uH)	Tolerance (±%)	Test Frequency (MHz)	RDC(mΩ) Max(Typ.)	Isat(A) Max(Typ.)	Irms(A) Max(Typ.)
MHCL201612A-R24M-A8S	0.24	20	2	35(25)	5.5(6.5)	4.2(4.8)
MHCL201612A-R47M-A8S	0.47	20	2	52(40)	3.8(5.1)	3.2(3.8)
MHCL201612A-R68M-A8S	0.68	20	2	70(53)	3.3(4.8)	2.6(3.2)
MHCL201612A-1R0M-A8S	1.0	20	2	82(67)	3.1(3.9)	2.3(2.7)
MHCL201612A-1R5M-A8S	1.5	20	2	120(95)	2.6(3.2)	2.2(2.6)
MHCL201612A-2R2M-A8S	2.2	20	2	195(165)	2.0(2.6)	1.3(1.7)

Note: When ordering, please specify tolerance code. Tolerance: M=±20%

- Operating temperature range - 40°C ~ 125°C(Including self - temperature rise)
- Isat for Inductance drop 30% from its value without current
- I rms for a 40°C temperature rise from 25°C ambient with current
- Absolute maximum voltage 25VDC
- Measure Equipment :
 L : Agilent E4991/HP4286A+16197A (or equivalent), 2MHz 0.2V
 RDC : CHEN HWA502BC/HP4338B (or equivalent)
 Isat : Agilent E4980A+HP42841A (or equivalent)
 I rms : Agilent 6641 SYSTEM DC POWER SUPPLY (or equivalent)

Test Instruments : E4991A Impedance / Material Analyzer

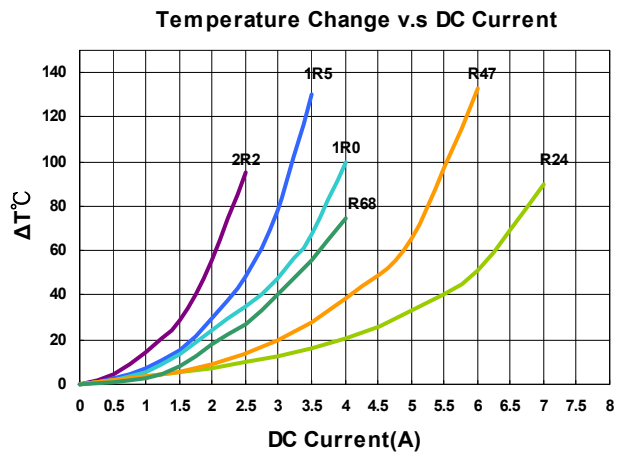
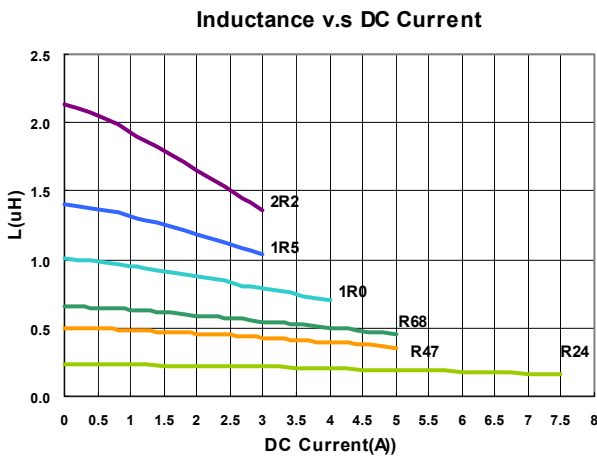

Electrical Characteristics

Part Number	Inductance (uH)	Tolerance (±%)	Test Frequency (MHz)	RDC(mΩ) Max(Typ.)	Isat(A) Max(Typ.)	Irms(A) Max(Typ.)
MHCL252010A-R24M-A8S	0.24	20	2	40(24)	7.5(9.5)	4.5(5.0)
MHCL252010A-R47M-A8S	0.47	20	2	46(36)	5.2(6.5)	3.1(3.6)
MHCL252010A-R68M-A8S	0.68	20	2	65(49)	3.8(5.0)	2.9(3.3)
MHCL252010A-1R0M-A8S	1.0	20	2	78(60)	3.4(4.3)	2.5(3.0)
MHCL252010A-1R5M-A8S	1.5	20	2	105(82)	3.2(4.0)	2.2(2.9)
MHCL252010A-2R2M-A8S	2.2	20	2	156(130)	2.6(3.2)	1.4(1.8)

Note: When ordering, please specify tolerance code. Tolerance: M=±20%

- Operating temperature range - 40°C ~ 125°C(Including self - temperature rise)
- Isat for Inductance drop 30% from its value without current
- I rms for a 40°C temperature rise from 25°C ambient with current
- Absolute maximum voltage 25VDC
- Measure Equipment :
 L : Agilent E4991/HP4286A+16197A (or equivalent), 2MHz 0.2V
 RDC : CHEN HWA502BC/HP4338B (or equivalent)
 Isat : Agilent E4980A+HP42841A (or equivalent)
 I rms : Agilent 6641 SYSTEM DC POWER SUPPLY (or equivalent)

Test Instruments : E4991A Impedance / Material Analyzer

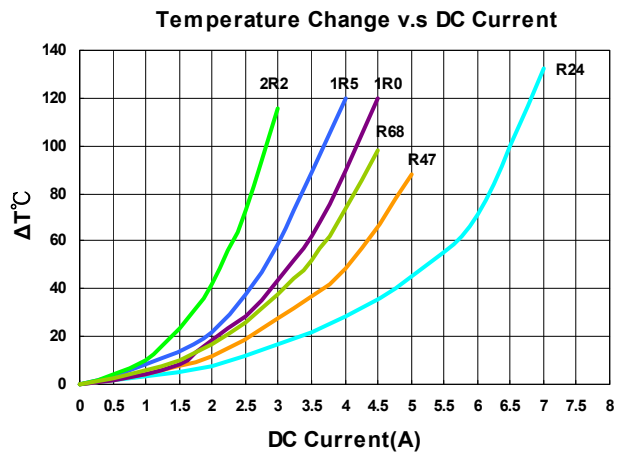
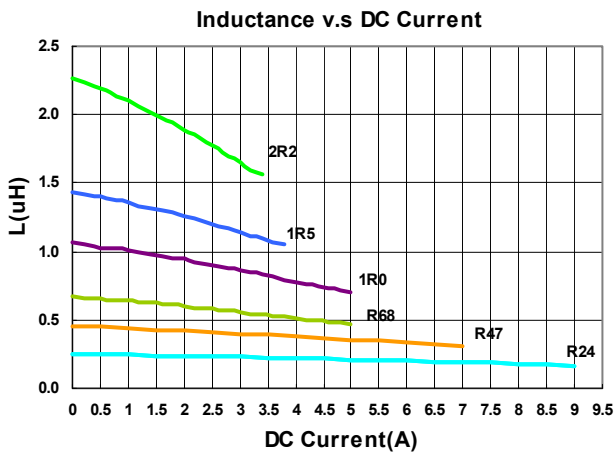

Electrical Characteristics

Part Number	Inductance (uH)	Tolerance (±%)	Test Frequency (MHz)	RDC(mΩ) Max(Typ.)	Isat(A) Max(Typ.)	Irms(A) Max(Typ.)
MHCL252010B-R33M-A8L	0.33	20	2	31(25)	5.0(6.0)	3.8(4.4)
MHCL252010B-R47M-A8L	0.47	20	2	35(29)	4.2(4.7)	3.4(3.9)
MHCL252010B-R68M-A8L	0.68	20	2	48(40)	3.7(4.0)	3.0(3.5)
MHCL252010B-1R0M-A8L	1.0	20	2	65(54)	3.2(3.6)	2.6(3.0)
MHCL252010B-1R5M-A8L	1.5	20	2	94(78)	2.9(3.3)	2.1(2.4)
MHCL252010B-2R2M-A8L	2.2	20	2	120(100)	2.3(2.7)	1.8(2.1)

Note: When ordering, please specify tolerance code. Tolerance: M=±20%

- Operating temperature range - 40°C ~ 125°C(Including self - temperature rise)
- Isat for Inductance drop 30% from its value without current
- I rms for a 40°C temperature rise from 25°C ambient with current
- Absolute maximum voltage 25VDC
- Measure Equipment :
 L : Agilent E4991/HP4286A+16197A (or equivalent), 2MHz 0.2V
 RDC : CHEN HWA502BC/HP4338B (or equivalent)
 Isat : Agilent E4980A+HP42841A (or equivalent)
 I rms : Agilent 6641 SYSTEM DC POWER SUPPLY (or equivalent)

Test Instruments : E4991A Impedance / Material Analyzer

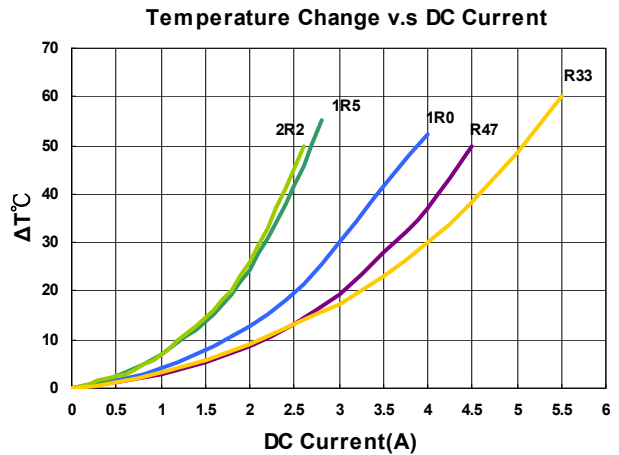
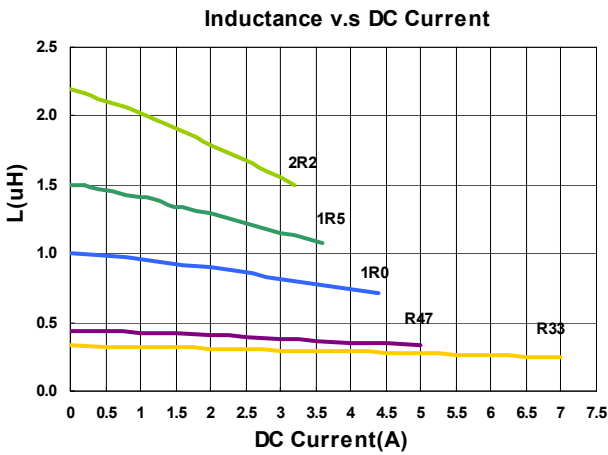

Please be sure to request approval specifications that provide further details of the products. Kindly note that the content of these specifications are subject to change or may be discontinued without advance notice. Please contact our sales department before ordering.

Electrical Characteristics

Part Number	Inductance (uH)	Tolerance (±%)	Test Frequency (MHz)	RDC(mΩ) Max(Typ.)	Isat(A) Max(Typ.)	Irms(A) Max(Typ.)
MHCL252012A-R33M-A8S	0.33	20	2	35(27)	6.8(8.5)	4.0(4.6)
MHCL252012A-R47M-A8S	0.47	20	2	39(29)	6.2(7.8)	3.7(4.4)
MHCL252012A-R68M-A8S	0.68	20	2	46(40)	5.5(6.5)	3.3(3.7)
MHCL252012A-1R0M-A8S	1.0	20	2	59(45)	4.0(5.0)	3.0(3.5)
MHCL252012A-1R5M-A8S	1.5	20	2	70(62)	3.4(4.0)	2.5(2.7)
MHCL252012A-2R2M-A8S	2.2	20	2	115(102)	3.3(3.8)	2.0(2.3)

Note: When ordering, please specify tolerance code. Tolerance: M=±20%

- Operating temperature range - 40°C ~ 125°C(Including self - temperature rise)
- Isat for Inductance drop 30% from its value without current
- Irms for a 40°C temperature rise from 25°C ambient with current
- Absolute maximum voltage 25VDC
- Measure Equipment :
 L : Agilent E4991/HP4286A+16197A (or equivalent), 2MHz 0.2V
 RDC : CHEN HWA502BC/HP4338B (or equivalent)
 Isat : Agilent E4980A+HP42841A (or equivalent)
 Irms : Agilent 6641 SYSTEM DC POWER SUPPLY (or equivalent)

Test Instruments : E4991A Impedance / Material Analyzer

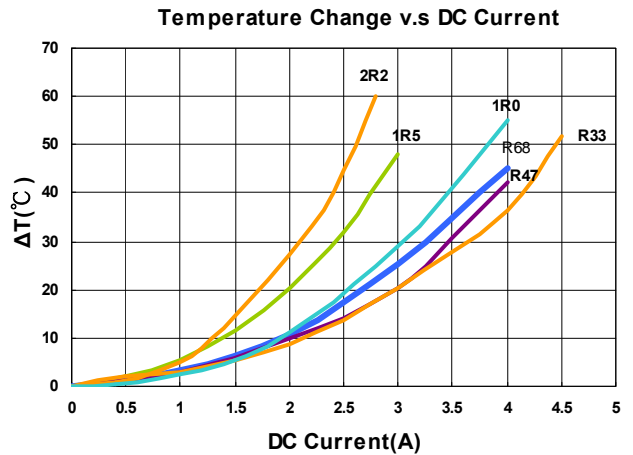
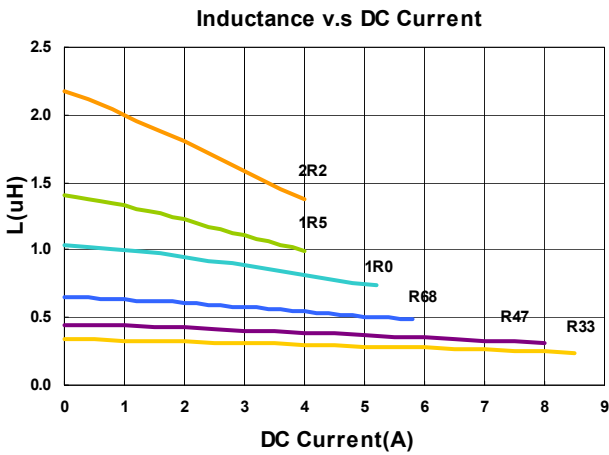

Electrical Characteristics

Part Number	Inductance (uH)	Tolerance (±%)	Test Frequency (MHz)	RDC(mΩ) Max(Typ.)	Isat(A) Max(Typ.)	Irms(A) Max(Typ.)
MHCL252012B-R47M-A8L	0.47	20	2	34(30)	5.2(6.0)	4.1(4.7)
MHCL252012B-1R0M-A8L	1.0	20	2	56(45)	3.6(4.5)	3.2(3.7)
MHCL252012B-2R2M-A8L	2.2	20	2	102(80)	2.5(3.0)	2.2(2.6)

Note: When ordering, please specify tolerance code. Tolerance: M=±20%

- Operating temperature range - 40°C ~ 125°C(Including self - temperature rise)
- Isat for Inductance drop 30% from its value without current
- I rms for a 40°C temperature rise from 25°C ambient with current
- Absolute maximum voltage 25VDC
- Measure Equipment :
 - L : Agilent E4991/HP4286A+16197A (or equivalent), 2MHz 0.2V
 - RDC : CHEN HWA502BC/HP4338B (or equivalent)
 - Isat : Agilent E4980A+HP42841A (or equivalent)
 - I rms : Agilent 6641 SYSTEM DC POWER SUPPLY (or equivalent)

Test Instruments : E4991A Impedance / Material Analyzer

Inductance v.s DC Current

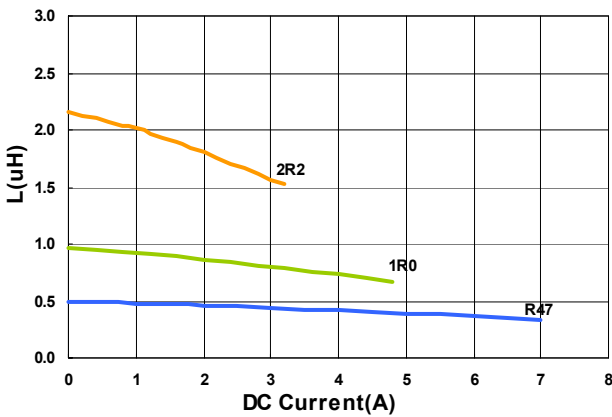

Temperature Change v.s DC Current

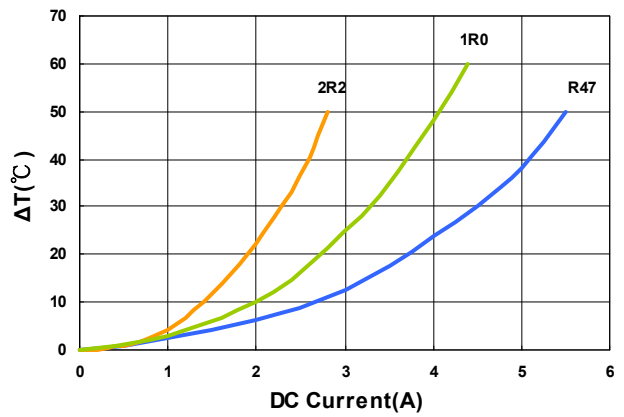

Packaging Specifications

Tape Dimensions

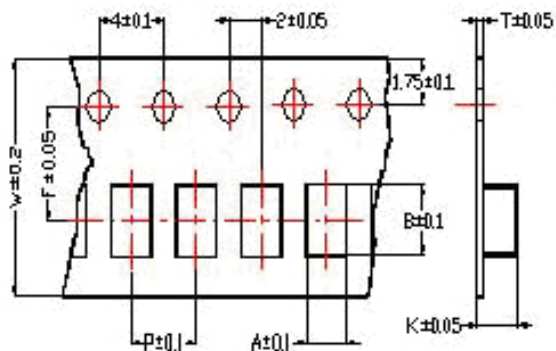

Tape Material

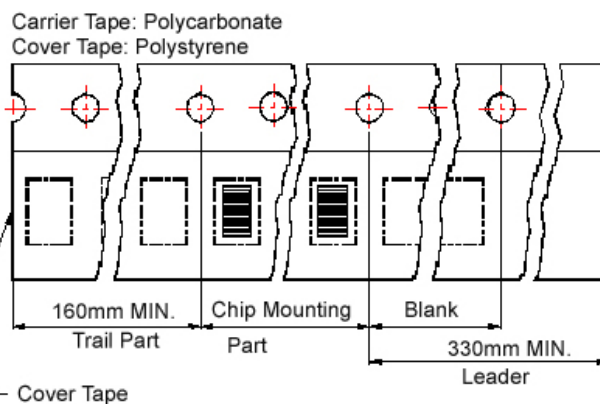

Reel Dimensions

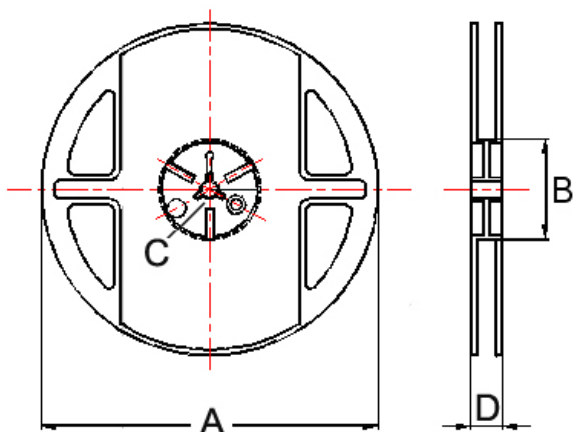

Dimensions in mm

TYPE	Tape Dimensions							Reel Dimensions				Quantity PCS / REEL
	A	B	T	W	P	F	K	A	B	C	D	
201610	1.80	2.20	0.22	8	4	3.5	1.15	178	60	12	1.5	3000
201612	1.80	2.20	0.22	8	4	3.5	1.15	178	60	12	1.5	3000
252010	2.25	2.80	0.22	8	4	3.5	1.15	178	60	12	1.5	3000
252012	2.25	2.80	0.22	8	4	3.5	1.35	178	60	12	1.5	3000

HPPC Series



HPPC series is low profile molding power choke with low RDC and high Q factor, so the efficiency performance is also superior. Its molded magnetic shielded type is suitable for high-density mounting and ultra-low buzz noise. Soldering conditions can be easily confirmed when mounting onto the board. This series also provides customers with embossed carrier type packaging for automatic mounting machine.

Features

- RoHS, Halogen Free and REACH Compliance
- Low RDC
- High Q
- High Efficiency
- Ultra-low buzz noise

Applications

- Laptops and PCs
- Switches and servers
- Base stations
- DC/DC converters

Product Identification

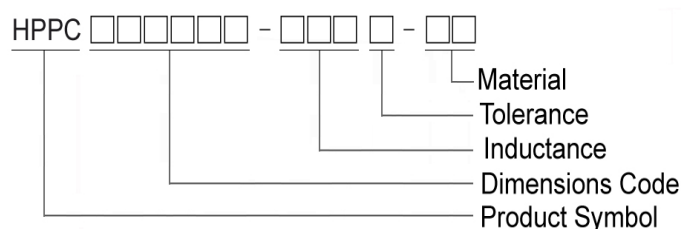

Shape and Dimensions

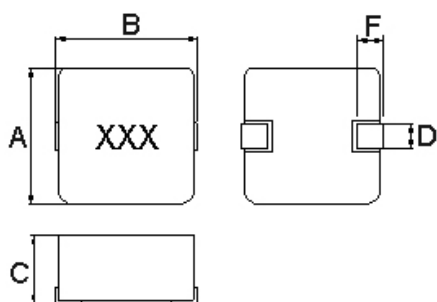

Recommended Pattern

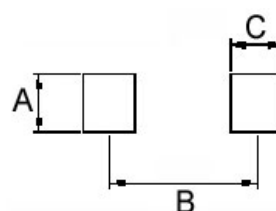

Dimensions in mm

TYPE	A	B	C	D	F
04010	4.1±0.2	4.6±0.2	1.0Max	1.5±0.3	1.0±0.3
04011	4.1±0.2	4.6±0.2	1.1Max	1.5±0.3	1.0±0.3
04020	4.2±0.2	4.8±0.2	1.8±0.2	1.5±0.3	1.1±0.3
05011	5.5±0.2	5.7±0.2	1.1Max	2.0±0.3	1.5±0.3
05030	5.5±0.25	5.85±0.25	2.8±0.2	2.0±0.25	1.5±0.25
06011	6.6±0.2	6.95±0.35	1.1Max	3.0±0.3	1.6±0.3
06020	6.8±0.2	6.95±0.35	1.8±0.2	3.0±0.3	1.6±0.3
06030	6.8±0.2	7.3±0.2	2.8±0.2	3.0±0.3	1.6±0.3
10040	10.2±0.3	11.3±0.3	3.8±0.2	3.0±0.5	2.5±0.5

Dimensions in mm

TYPE	A	B	C
04010	2.5	3.7	1.5
04011	2.5	3.7	1.5
04020	2.5	3.7	1.5
05011	2.5	4.1	1.9
05030	2.5	4.6	1.9
06011	3.5	6.05	2.35
06020	3.5	6.05	2.35
06030	3.5	6.05	2.35
10040	4.0	9.50	3.50

Electrical Characteristics

Part Number	Inductance (uH)	Tolerance (±%)	Test Frequency (kHz)	RDC(mΩ) Max(Typ.)	Isat(A) Max(Typ.)	Irms(A) Max(Typ.)	Marking
HPPC04010-R33M-A8	0.33	20	100	14(12)	9.0(11)	6.0(7.0)	R33
HPPC04010-1R0M-A8	1.0	20	100	43(39)	4.0(5.0)	4.0(4.5)	1R0

Note: When ordering, please specify tolerance code. Tolerance: M=±20%

- Operating temperature range - 55°C ~ 125°C(Including self - temperature rise)
- Isat for Inductance drop 30% from its value without current
- Irms for a 40°C temperature rise from 25°C ambient with current
- Absolute maximum voltage 30VDC
- Measure Equipment :
 - L : WK 3260B or WK 6500P, 100kHz 0.5V
 - RDC : CHEN HWA 502 or CHEN HWA 46502B
 - Irms : CHROMA 1810

Test Instruments : WK3260B Impedance / Material Analyzer

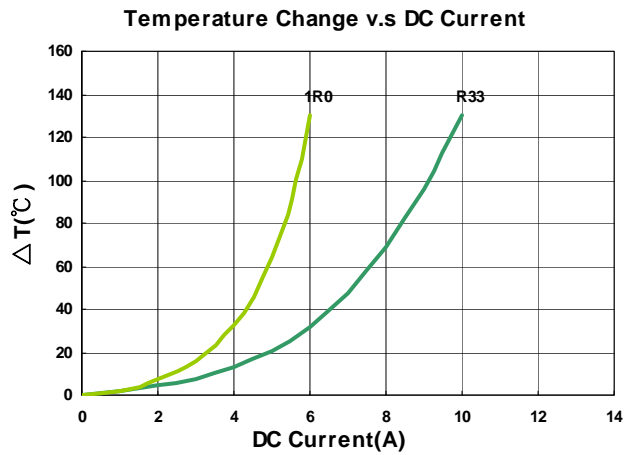
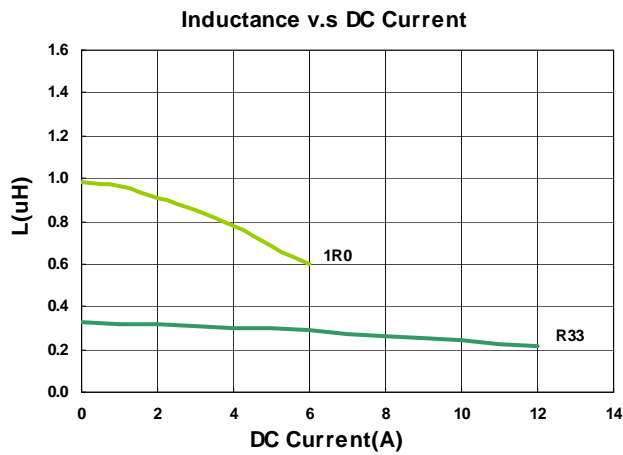

Electrical Characteristics

Part Number	Inductance (uH)	Tolerance (±%)	Test Frequency (kHz)	RDC(mΩ) Max(Typ.)	Isat(A) Max(Typ.)	Irms(A) Max(Typ.)	Marking
HPPC04011-1R0M-A8	1.0	20	100	38.5(35)	5.4(6.0)	4.3(4.8)	1R0
HPPC04011-2R2M-A8	2.2	20	100	82(75)	3.5(4.0)	3.0(3.3)	2R2

Note: When ordering, please specify tolerance code. Tolerance: M=±20%

- Operating temperature range - 55°C ~ 125°C(Including self - temperature rise)
- Isat for Inductance drop 30% from its value without current
- Irms for a 40°C temperature rise from 25°C ambient with current
- Absolute maximum voltage 30VDC
- Measure Equipment :
 L : WK 3260B or WK 6500P, 100kHz 0.5V
 RDC : CHEN HWA 502 or CHEN HWA 46502B
 Irms : CHROMA 1810

Test Instruments : WK3260B Impedance / Material Analyzer

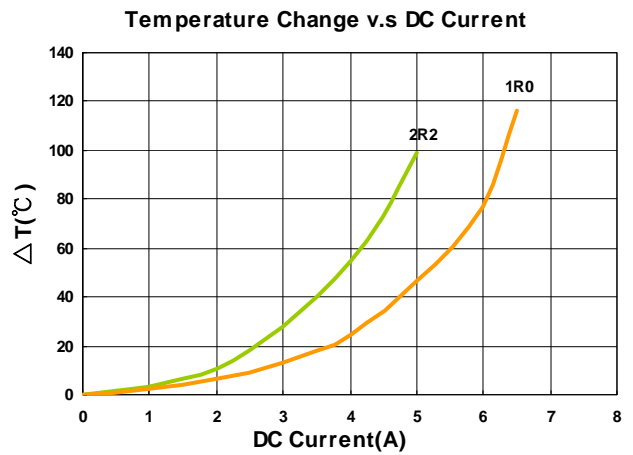
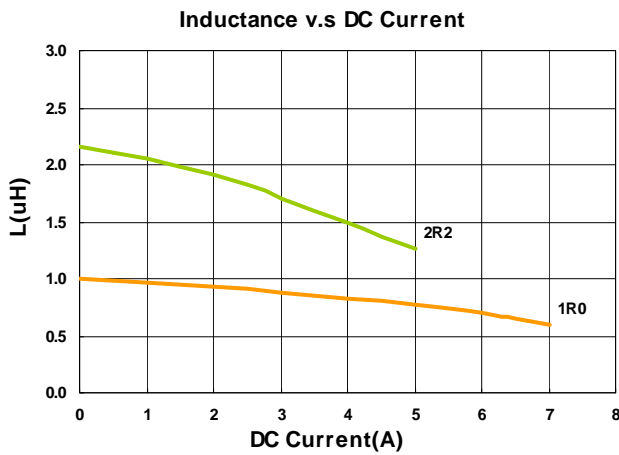

Electrical Characteristics

Part Number	Inductance (uH)	Tolerance (±%)	Test Frequency (kHz)	RDC(mΩ) Max(Typ.)	Isat(A) Max(Typ.)	Irms(A) Max(Typ.)	Marking
HPPC04020-R22M-Q8	0.22	20	100	5.5(5.0)	18(20)	10(11)	R22
HPPC04020-1R0M-Q8	1.0	20	100	17(16)	8.0(8.5)	5.5(6.0)	1R0
HPPC04020-2R2M-Q8	2.2	20	100	38.5(35)	6.0(6.5)	4.0(4.5)	2R2
HPPC04020-4R7M-Q8	4.7	20	100	85(77)	4.0(4.5)	2.5(2.8)	4R7

Note: When ordering, please specify tolerance code. Tolerance: M=±20%

- Operating temperature range - 55°C ~ 125°C(Including self - temperature rise)
- Isat for Inductance drop 30% from its value without current
- I rms for a 40°C temperature rise from 25°C ambient with current
- Absolute maximum voltage 30VDC
- Measure Equipment :
 L : WK 3260B or WK 6500P, 100kHz 0.5V
 RDC : CHEN HWA 502 or CHEN HWA 46502B
 I rms : CHROMA 1810

Test Instruments : WK3260B Impedance / Material Analyzer

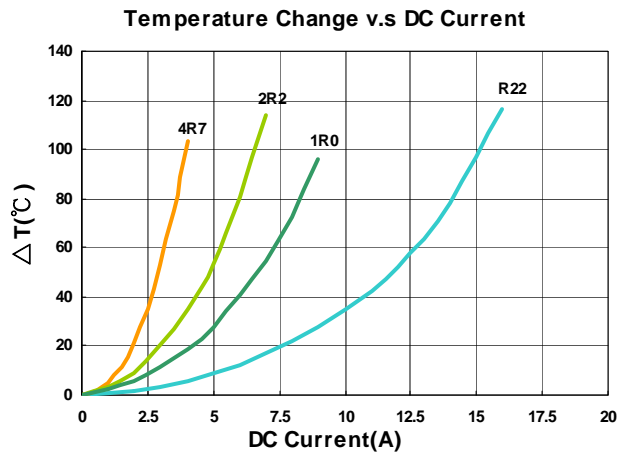
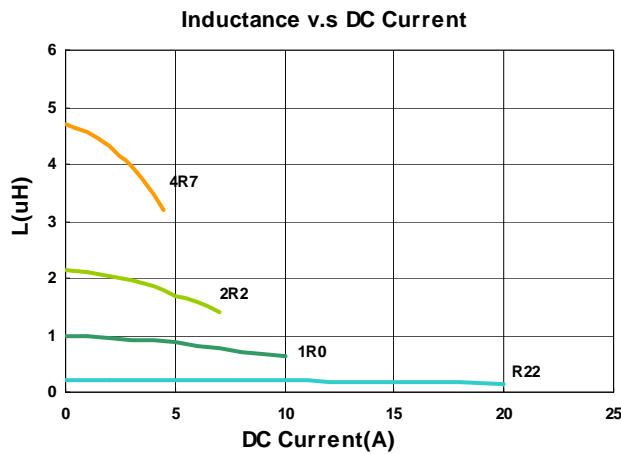

Please be sure to request approval specifications that provide further details of the products. Kindly note that the content of these specifications are subject to change or may be discontinued without advance notice. Please contact our sales department before ordering.

Electrical Characteristics

Part Number	Inductance (uH)	Tolerance (±%)	Test Frequency (kHz)	RDC(mΩ) Max(Typ.)	Isat(A) Max(Typ.)	Irms(A) Max(Typ.)	Marking
HPPC05011-1R0M-A8	1.0	20	100	33(30)	7.0(7.5)	4.8(5.3)	1R0

Note: When ordering, please specify tolerance code. Tolerance: M=±20%

- Operating temperature range - 55°C ~ 125°C(Including self - temperature rise)
- Isat for Inductance drop 30% from its value without current
- I rms for a 40°C temperature rise from 25°C ambient with current
- Absolute maximum voltage 30VDC
- Measure Equipment :
 L : WK 3260B or WK 6500P, 100kHz 0.5V
 RDC : CHEN HWA 502 or CHEN HWA 46502B
 I rms : CHROMA 1810

Test Instruments : WK3260B Impedance / Material Analyzer

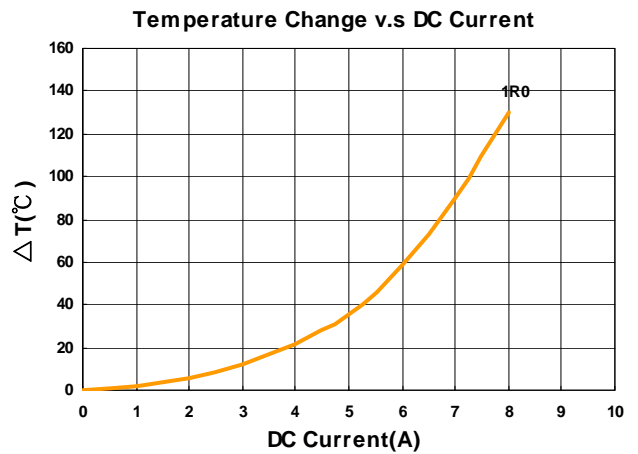
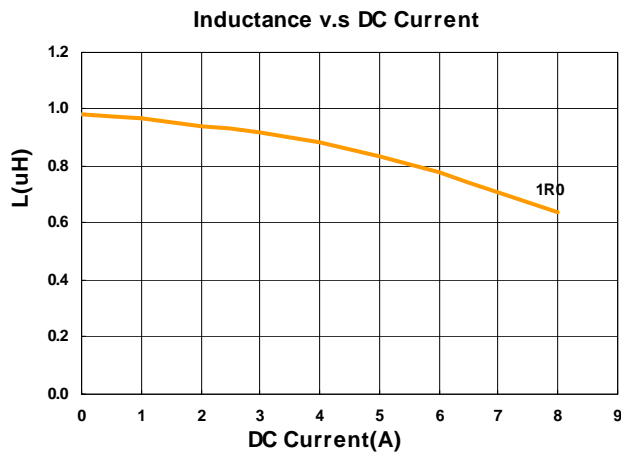

Electrical Characteristics

Part Number	Inductance (uH)	Tolerance (±%)	Test Frequency (kHz)	RDC(mΩ) Max(Typ.)	Isat(A) Max(Typ.)	Irms(A) Max(Typ.)	Marking
HPPC05030-R22M-Q8	0.22	20	100	3.90(3.5)	28(32)	18.0(20.0)	R22
HPPC05030-R36M-Q8	0.36	20	100	4.95(4.5)	23(25)	12.5(13.5)	R36
HPPC05030-R68M-Q8	0.68	20	100	6.30(5.7)	17(18)	11.0(12.0)	R68
HPPC05030-1R0M-Q8	1.0	20	100	9.8(8.9)	16(18)	9.00(9.50)	1R0
HPPC05030-1R5M-Q8	1.5	20	100	15(13.5)	12.5(13.5)	7.50(8.0)	1R5
HPPC05030-2R2M-Q8	2.2	20	100	20(18)	11.5(12.5)	6.00(6.5)	2R2
HPPC05030-4R7M-Q8	4.7	20	100	40(37)	6.5(7.50)	4.50(5.0)	4R7

Note: When ordering, please specify tolerance code. Tolerance: M=±20%

- Operating temperature range - 55°C ~ 125°C(Including self - temperature rise)
- Isat for Inductance drop 30% from its value without current
- I rms for a 40°C temperature rise from 25°C ambient with current
- Absolute maximum voltage 30VDC
- Measure Equipment :
 - L : WK 3260B or WK 6500P, 100kHz 0.5V
 - RDC : CHEN HWA 502 or CHEN HWA 46502B
 - I rms : CHROMA 1810

Test Instruments : WK3260B Impedance / Material Analyzer

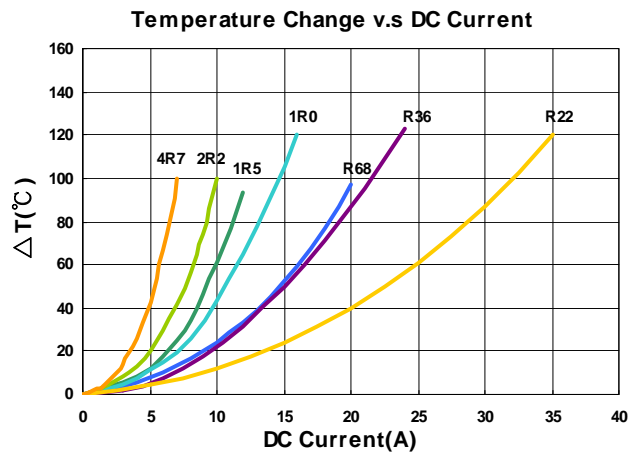
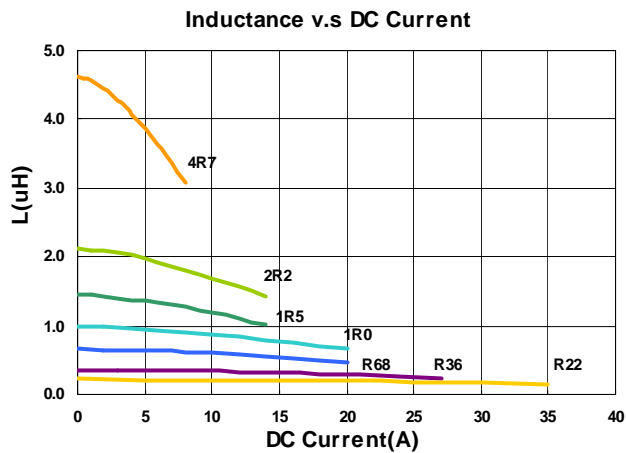

Please be sure to request approval specifications that provide further details of the products. Kindly note that the content of these specifications are subject to change or may be discontinued without advance notice. Please contact our sales department before ordering.

Electrical Characteristics

Part Number	Inductance (uH)	Tolerance (±%)	Test Frequency (kHz)	RDC(mΩ) Max(Typ.)	Isat(A) Max(Typ.)	Irms(A) Max(Typ.)	Marking
HPPC06011-1R0M-A8	1.0	20	100	26(24.5)	7.0(7.8)	6.8(7.3)	1R0
HPPC06011-2R2M-A8	2.2	20	100	57(52)	5.0(6.0)	4.2(4.6)	2R2

Note: When ordering, please specify tolerance code. Tolerance: M=±20%

- Operating temperature range - 55°C ~ 125°C(Including self - temperature rise)
- Isat for Inductance drop 30% from its value without current
- Irms for a 40°C temperature rise from 25°C ambient with current
- Absolute maximum voltage 30VDC
- Measure Equipment :
 - L : WK 3260B or WK 6500P, 100kHz 0.5V
 - RDC : CHEN HWA 502 or CHEN HWA 46502B
 - Irms : CHROMA 1810

Test Instruments : WK3260B Impedance / Material Analyzer

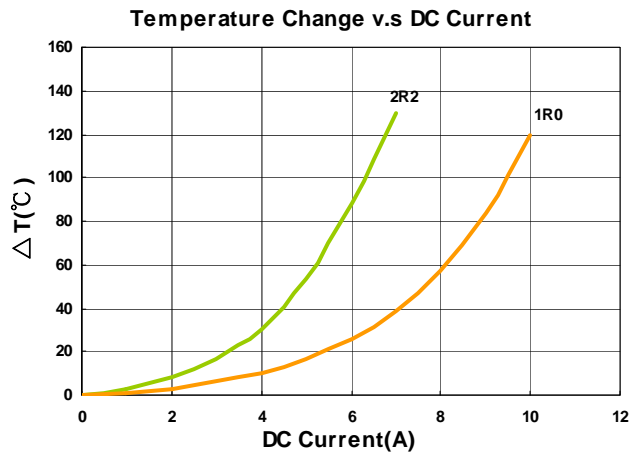
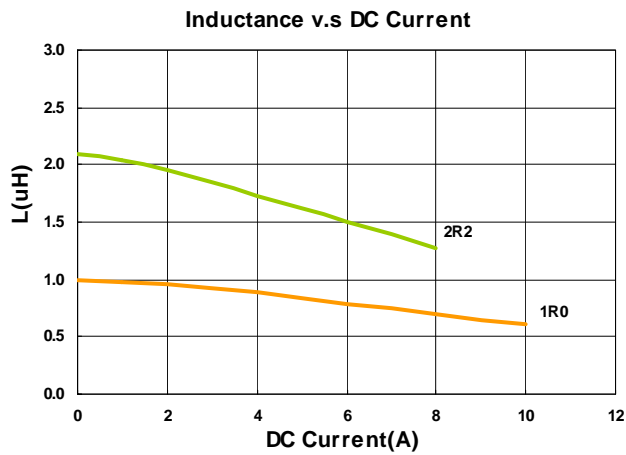

Electrical Characteristics

Part Number	Inductance (uH)	Tolerance (±%)	Test Frequency (kHz)	RDC(mΩ) Max(Typ.)	Isat(A) Max(Typ.)	Irms(A) Max(Typ.)	Marking
HPPC06020-4R7M-Q8	4.7	20	100	48(43.7)	6.0(6.8)	4.2(4.7)	4R7

Note: When ordering, please specify tolerance code. Tolerance: M=±20%

- Operating temperature range - 55°C ~ 125°C(Including self - temperature rise)
- Isat for Inductance drop 30% from its value without current
- I rms for a 40°C temperature rise from 25°C ambient with current
- Absolute maximum voltage 30VDC
- Measure Equipment :
 L : WK 3260B or WK 6500P, 100kHz 0.5V
 RDC : CHEN HWA 502 or CHEN HWA 46502B
 I rms : CHROMA 1810

Test Instruments : WK3260B Impedance / Material Analyzer

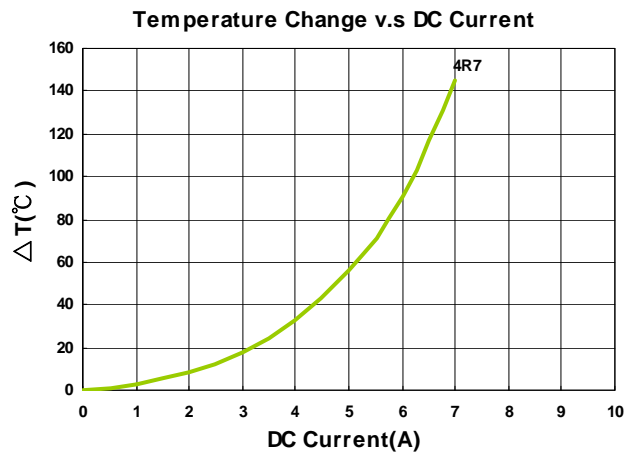
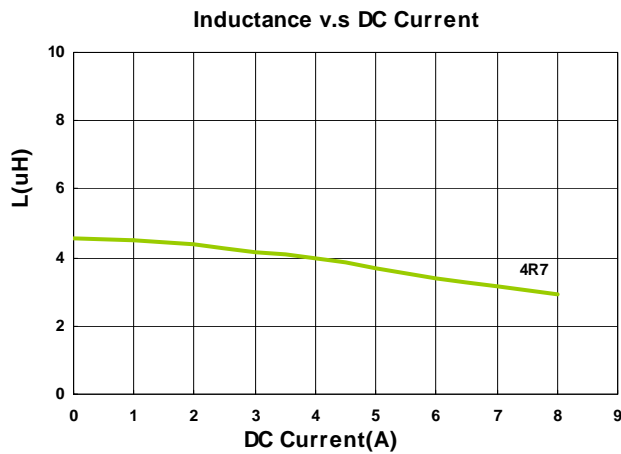

Electrical Characteristics

Part Number	Inductance (uH)	Tolerance (±%)	Test Frequency (kHz)	RDC(mΩ) Max(Typ.)	Isat(A) Max(Typ.)	Irms(A) Max(Typ.)	Marking
HPPC06030-R22M-Q8	0.22	20	100	2.0(1.8)	35(40)	25(27)	R22
HPPC06030-R36M-Q8	0.36	20	100	2.6(2.3)	27(32)	23(25)	R36
HPPC06030-R47M-Q8	0.47	20	100	3.3(2.9)	25(27)	19(20)	R47
HPPC06030-R56M-Q8	0.56	20	100	3.9(3.5)	23(25)	17(18)	R56
HPPC06030-R68M-Q8	0.68	20	100	4.2(3.8)	18(20)	16(17)	R68
HPPC06030-1R0M-Q8	1.0	20	100	5.3(4.8)	17(19)	14(15)	1R0
HPPC06030-1R5M-Q8	1.5	20	100	7.7(7.0)	15(17)	11(11.5)	1R5
HPPC06030-2R2M-Q8	2.2	20	100	9.4(8.5)	12(12.5)	10.5(11)	2R2
HPPC06030-3R3M-Q8	3.3	20	100	15(13.5)	9.0(9.5)	8.0(8.5)	3R3
HPPC06030-4R7M-Q8	4.7	20	100	22.0(20)	6.5(7.0)	6.0(6.5)	4R7
HPPC06030-6R8M-Q8	6.8	20	100	38.5(35)	6.0(6.5)	5.3(5.8)	6R8
HPPC06030-8R2M-Q8	8.2	20	100	47.0(43)	5.5(6.0)	5.0(5.4)	8R2
HPPC06030-100M-Q8	10	20	100	47.0(43)	5.0(5.5)	4.8(5.3)	100

Note: When ordering, please specify tolerance code. Tolerance: M=±20%

- Operating temperature range - 55°C ~ 125°C(Including self - temperature rise)
- Isat for Inductance drop 30% from its value without current
- Irms for a 40°C temperature rise from 25°C ambient with current
- Absolute maximum voltage 30VDC
- Measure Equipment :
 - L : WK 3260B or WK 6500P, 100kHz 0.5V
 - RDC : CHEN HWA 502 or CHEN HWA 46502B
 - Irms : CHROMA 1810

Test Instruments : WK3260B Impedance / Material Analyzer

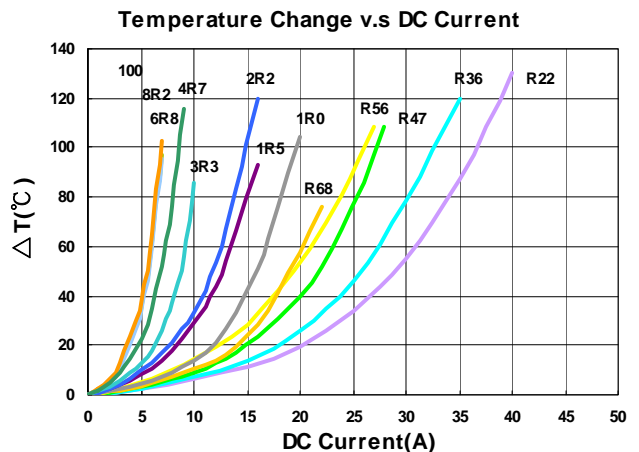
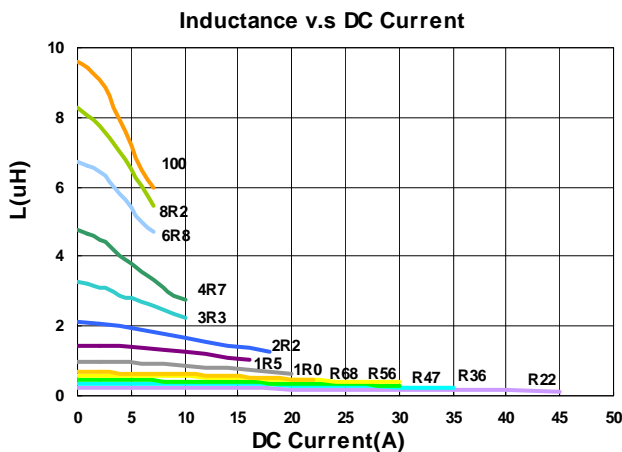

Please be sure to request approval specifications that provide further details of the products. Kindly note that the content of these specifications are subject to change or may be discontinued without advance notice. Please contact our sales department before ordering.

Electrical Characteristics

Part Number	Inductance (uH)	Tolerance (±%)	Test Frequency (kHz)	RDC(mΩ) Max(Typ.)	Isat(A) Max(Typ.)	Irms(A) Max(Typ.)	Marking
HPPC10040-R22M-Q8	0.22	20	100	0.54(0.45)	55(60)	40(42)	R22
HPPC10040-R33M-Q8	0.33	20	100	0.68(0.62)	45(50)	32(35)	R33
HPPC10040-R56M-Q8	0.56	20	100	1.2(1.0)	40(45)	28(30)	R56
HPPC10040-R68M-Q8	0.68	20	100	1.5(1.3)	32(37)	25(27)	R68
HPPC10040-1R0M-Q8	1.0	20	100	2.4(2.2)	26(30)	23(25)	1R0
HPPC10040-2R2M-Q8	2.2	20	100	4.7(4.3)	17(20)	15(15.6)	2R2
HPPC10040-3R3M-Q8	3.3	20	100	7.9(7.2)	16(18)	12(12.5)	3R3
HPPC10040-4R7M-Q8	4.7	20	100	10.5(9.5)	13(14)	10.5(11)	4R7
HPPC10040-6R8M-Q8	6.8	20	100	16.5(15)	9.0(10)	8.5(9.0)	6R8
HPPC10040-100M-Q8	10	20	100	24(22)	8.5(9.0)	8.0(8.5)	100

Note: When ordering, please specify tolerance code. Tolerance: M=±20%

- Operating temperature range - 55°C ~ 125°C(Including self - temperature rise)
- Isat for Inductance drop 30% from its value without current
- I rms for a 40°C temperature rise from 25°C ambient with current
- Absolute maximum voltage 30VDC
- Measure Equipment :
 - L : WK 3260B or WK 6500P, 100kHz 0.5V
 - RDC : CHEN HWA 502 or CHEN HWA 46502B
 - I rms : CHROMA 1810

Test Instruments : WK3260B Impedance / Material Analyzer

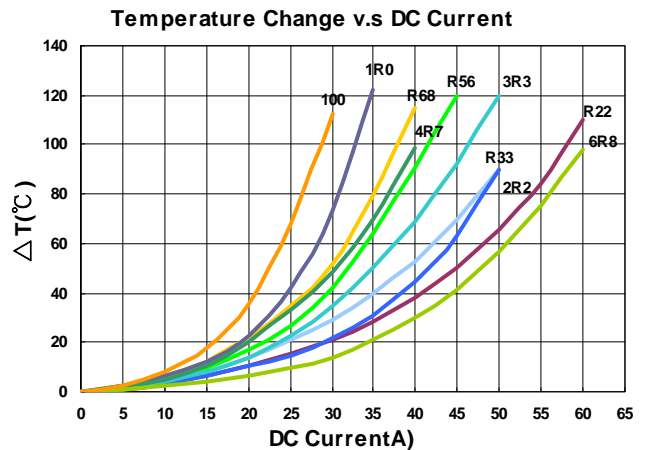
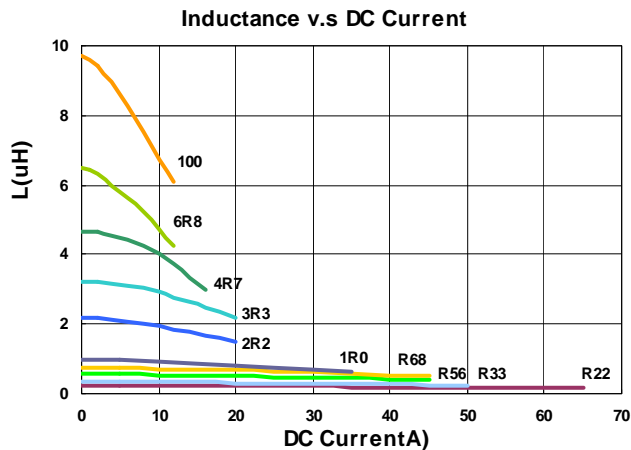

Please be sure to request approval specifications to provide further details of the products. Kindly note that the content of these specifications are subject to change or may be discontinued without advance notice. Please contact our sales department before ordering.

Packaging Specifications

Tape Dimensions

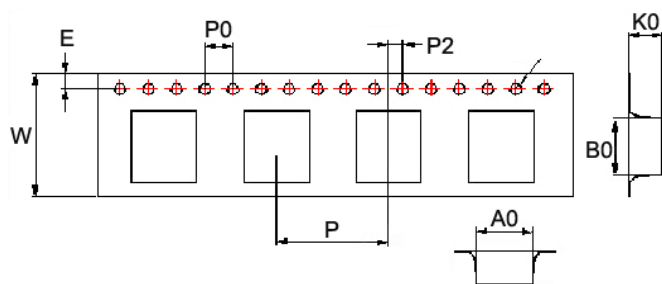

Tape Material

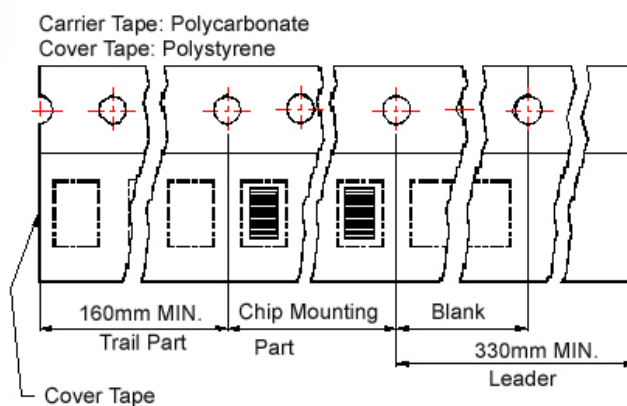

Reel Dimensions

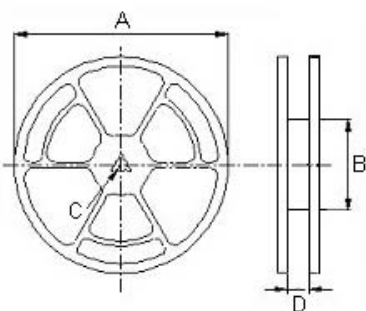

Dimensions in mm

TYPE	Tape Dimensions									Reel Dimensions				Quantity PCS / REEL
	A0	B0	K0	D	E	W	P	P0	P2	A	B	C	D	
04010	4.4	4.9	1.4	1.55	1.75	12	8	4	2	330	100	13	13.4	2000
04011	4.4	4.9	1.5	1.55	1.75	12	8	4	2	330	100	13	13.4	2000
04020	4.5	5.1	2.4	1.55	1.75	12	8	4	2	330	100	13	13.4	2000
05011	5.9	6.2	1.5	1.55	1.75	16	12	4	2	330	100	13	16	2000
05030	5.9	6.25	3.4	1.55	1.75	16	12	4	2	330	100	13	16	1000
06011	6.9	7.4	1.5	1.55	1.75	16	12	4	2	330	100	13	16	1000
06020	7.05	7.6	2.4	1.55	1.75	16	12	4	2	330	100	13	16	1000
06030	7.0	7.6	3.4	1.55	1.75	16	12	4	2	330	100	13	16	1000
10040	10.6	11.7	4.25	1.55	1.75	24	16	4	2	330	100	13	24.4	500

MHCC、MHCI Series



MHCC series is designed for low profile type with low RDC and ultra large current. Its molded magnetic shielded type is suitable for high-density mounting and ultra low buzz noise. Soldering conditions can be easily confirmed when mounting onto the board. This series also provides customers with embossed carrier type packaging for automatic mounting machine.

Features

- RoHS, Halogen Free and REACH Compliance
- High rated current
- Ultra low buzz noise

Applications

- Laptops and PCs
- Switches and servers
- Base stations
- DC/DC converters

Product Identification

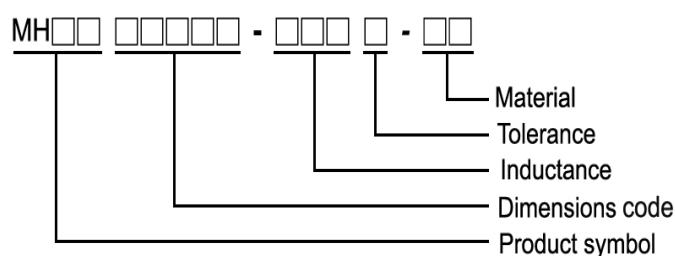

Shape and Dimensions

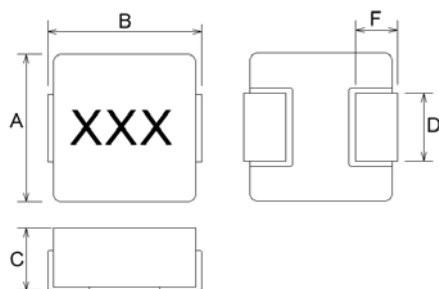

Recommended Pattern

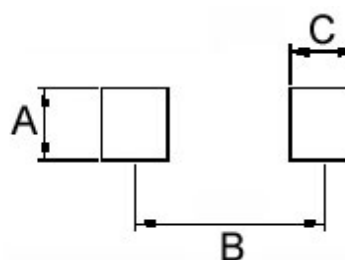

Dimensions in mm

TYPE	A	B Max	C Max	D	F
04012	4.1±0.2	4.6±0.2	1.2	1.5±0.3	1.0±0.5
04015	4.1±0.2	4.6±0.2	1.5	1.5±0.3	1.0±0.5
04020	4.1±0.2	4.6±0.2	2.0	1.5±0.3	1.0±0.5
05012	5.4±0.35	5.7±0.2	1.2	2.0±0.3	1.5±0.3
05015	5.4±0.35	5.7±0.2	1.5	2.0±0.3	1.5±0.3
05018	5.4±0.35	5.7±0.2	1.8	2.0±0.3	1.5±0.3
05020	5.4±0.35	5.7±0.2	1.8±0.2	2.0±0.3	1.5±0.3
05030	5.4±0.35	5.7±0.2	3.0	2.0±0.3	1.5±0.3
06012	6.6±0.2	7.3	1.2	2.9	1.6±0.5
06015	6.6±0.2	7.3	1.3±0.2	2.9	1.6±0.5
06018	6.6±0.2	7.3	1.6±0.2	2.9	1.6±0.5
06024	6.6±0.2	7.3	2.4	2.9	1.6±0.5
06030	6.6±0.2	7.3	3.0	2.9	1.6±0.5
06050	6.6±0.2	7.3	5.0	2.9	1.6±0.5
10030	10.1±0.3	11.6	3.0	3.0	2.5±0.5
10040	10.1±0.3	11.6	4.0	3.0	2.5±0.5
12050	12.6±0.2	13.8	5.0	3.7	2.7±0.7
12060	12.6±0.2	13.8	6.0	3.7	2.7±0.7

Dimensions in mm

TYPE	A	B	C
04012	2.5	3.7	1.5
04015	2.5	3.7	1.5
04020	2.5	3.7	1.5
05012	2.5	4.1	1.9
05015	2.5	4.1	1.9
05018	2.5	4.1	1.9
05020	2.5	4.1	1.9
05030	2.5	4.1	1.9
06012	3.5	6.05	2.35
06015	3.5	6.05	2.35
06018	3.5	6.05	2.35
06024	3.5	6.05	2.35
06030	3.5	6.05	2.35
06050	3.5	6.05	2.35
10030	4.0	9.5	3.5
10040	4.0	9.5	3.5
12050	5.0	10.5	4.0
12060	5.5	10.5	4.0

Electrical Characteristics

Part Number	Inductance (uH)	Tolerance (±%)	Test Frequency (kHz)	RDC (mΩ) Max	Isat (A)Typ.	Irms (A)Typ.
MHCI04012-R22M-R8	0.22	20	100	12	11.5	8.5
MHCI04012-R33M-R8	0.33	20	100	19	8.5	6.5
MHCI04012-R47M-R8	0.47	20	100	25	7.0	5.0
MHCI04012-R68M-R8	0.68	20	100	36	6.0	4.5
MHCI04012-1R0M-R8	1.0	20	100	47	5.2	4.2
MHCI04012-1R5M-R8	1.5	20	100	75	4.0	3.25
MHCI04012-2R2M-R8	2.2	20	100	83.5	3.5	2.75
MHCI04012-3R3M-R8	3.3	20	100	165	3.0	2.0
MHCI04012-4R7M-R8	4.7	20	100	195	2.8	1.8

Note: When ordering, please specify tolerance code. Tolerance: M=±20%

- Operating temperature range - 55°C ~ 125°C(Including self - temperature rise)
- Isat for Inductance drop 30% from its value without current
- I rms for a 40°C temperature rise from 25°C ambient with current
- Absolute maximum voltage 30VDC
- Measure Equipment :
 - L : WK 3260B or WK 6500P, 100kHz 0.5V
 - RDC : CHEN HWA 502 or CHEN HWA 46502B

Test Instruments : WK3260B Impedance / Material Analyzer

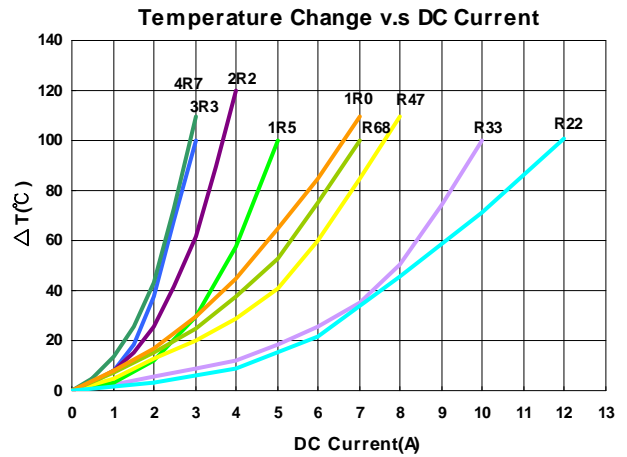
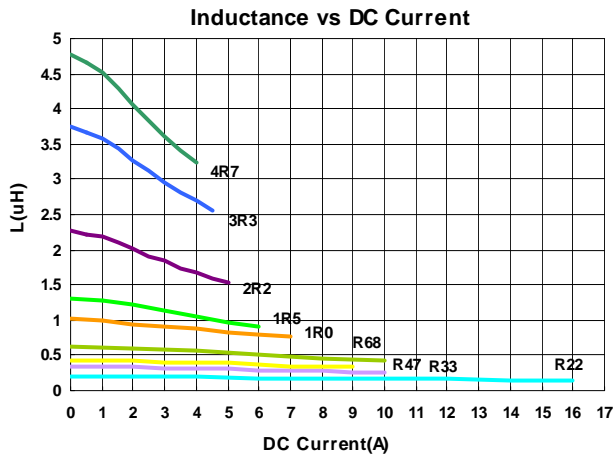

Please be sure to request approval specifications that provide further details of the products. Kindly note that the content of these specifications are subject to change or may be discontinued without advance notice. Please contact our sales department before ordering.

Electrical Characteristics

Part Number	Inductance (uH)	Tolerance (±%)	Test Frequency (kHz)	RDC (mΩ) Max	Isat (A)Typ.	Irms (A)Typ.
MHCI04015-1R0M-R8	1.0	20	100	42	7	4
MHCI04015-1R5M-R8	1.5	20	100	50	6	3.5
MHCI04015-2R2M-R8	2.2	20	100	79	5	3
MHCI04015-3R3M-R8	3.3	20	100	132	4.5	2.3
MHCI04015-4R7M-R8	4.7	20	100	146	4	2

Note: When ordering, please specify tolerance code. Tolerance: M=±20%

- Operating temperature range - 55°C ~ 125°C(Including self - temperature rise)
- Isat for Inductance drop 30% from its value without current
- I rms for a 40°C temperature rise from 25°C ambient with current
- Absolute maximum voltage 30VDC
- Measure Equipment :
 L : WK 3260B or WK 6500P, 100kHz 0.5V
 RDC : CHEN HWA 502 or CHEN HWA 46502B

Test Instruments : WK3260B Impedance / Material Analyzer

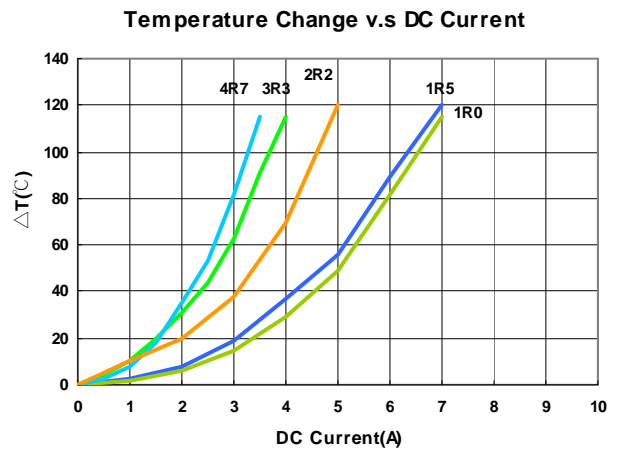
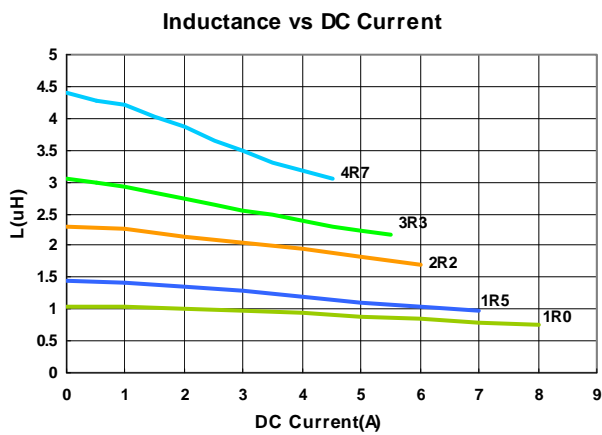

Please be sure to request approval specifications that provide further details of the products. Kindly note that the content of these specifications are subject to change or may be discontinued without advance notice. Please contact our sales department before ordering.

Electrical Characteristics

Part Number	Inductance (uH)	Tolerance (±%)	Test Frequency (kHz)	RDC (mΩ) Max	Isat (A)Typ.	Irms (A)Typ.
MHCI04020-R10M-R8	0.10	20	100	4	25	12.0
MHCI04020-R22M-R8	0.22	20	100	6.6	12.5	9.0
MHCI04020-R47M-R8	0.47	20	100	14	9.5	7.0
MHCI04020-R56M-R8	0.56	20	100	16	10.0	6.5
MHCI04020-R68M-R8	0.68	20	100	21	8.0	5.2
MHCI04020-1R0M-R8	1.0	20	100	27	7.0	4.5
MHCI04020-1R5M-R8	1.5	20	100	46	6.0	4.0
MHCI04020-2R2M-R8	2.2	20	100	58	5.0	3.0
MHCI04020-3R3M-R8	3.3	20	100	87	4.0	2.5
MHCI04020-4R7M-R8	4.7	20	100	126	3.0	2.2
MHCI04020-6R8M-R8	6.8	20	100	135	2.5	2.0
MHCI04020-8R2M-R8	8.2	20	100	216	2.5	2.0
MHCI04020-100M-R8	10	20	100	258	2.0	1.6

Note: When ordering, please specify tolerance code. Tolerance: M=±20%

- Operating temperature range - 55°C ~ 125°C(Including self - temperature rise)
- Isat for Inductance drop 30% from its value without current
- I rms for a 40°C temperature rise from 25°C ambient with current
- Absolute maximum voltage 30VDC
- Measure Equipment :
 L : WK 3260B or WK 6500P, 100KHz 0.5V
 RDC : CHEN HWA 502 or CHEN HWA 46502B

Test Instruments : WK3260B Impedance / Material Analyzer

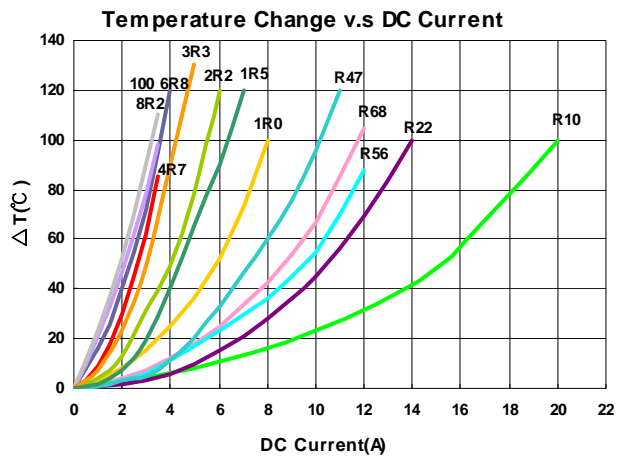
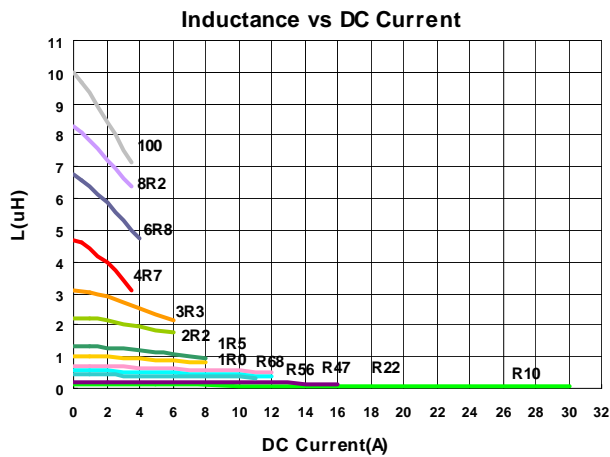

Please be sure to request approval specifications that provide further details of the products. Kindly note that the content of these specifications are subject to change or may be discontinued without advance notice. Please contact our sales department before ordering.

Electrical Characteristics

Part Number	Inductance (uH)	Tolerance (±%)	Test Frequency (kHz)	RDC (mΩ) Max	Isat (A)Typ.	Irms (A)Typ.
MHCI05012-1R0M-R8A	1.0	20	100	30	6.0	5.0
MHCI05012-2R2M-R8A	2.2	20	100	76	4.0	3.5
MHCI05012-6R8M-R8A	6.8	20	100	250	2.3	2.0

Note: When ordering, please specify tolerance code. Tolerance: M=±20%

- Operating temperature range - 55°C ~ 125°C(Including self - temperature rise)
- Isat for Inductance drop 30% from its value without current
- Irms for a 40°C temperature rise from 25°C ambient with current
- Absolute maximum voltage 30VDC
- Measure Equipment :
 L : WK 3260B or WK 6500P, 100kHz 0.5V
 RDC : CHEN HWA 502 or CHEN HWA 46502B

Test Instruments : WK3260B Impedance / Material Analyzer

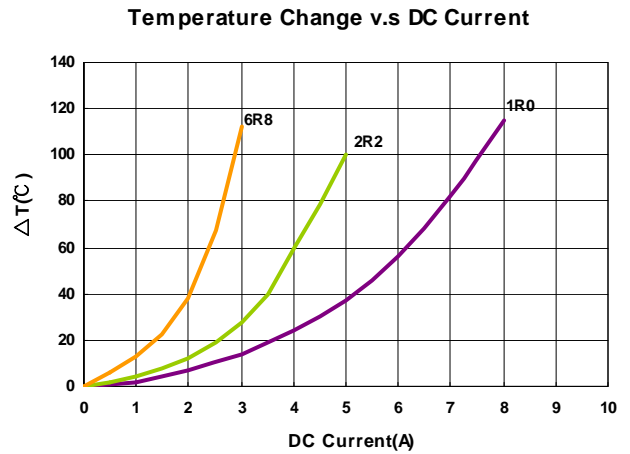
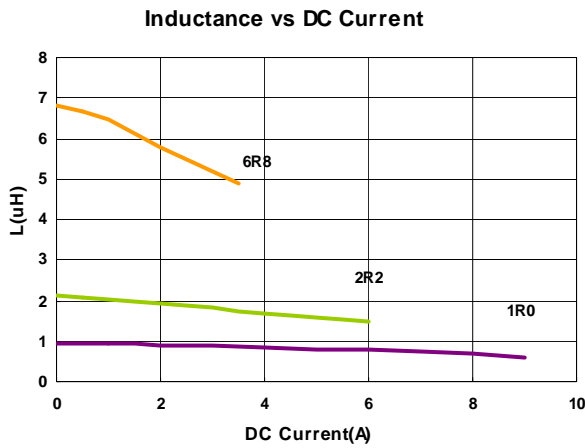

Please be sure to request approval specifications that provide further details of the products. Kindly note that the content of these specifications are subject to change or may be discontinued without advance notice. Please contact our sales department before ordering.

Electrical Characteristics

Part Number	Inductance (uH)	Tolerance (±%)	Test Frequency (kHz)	RDC (mΩ) Max	Isat (A)Typ.	Irms (A)Typ.
MHCI05015-R47M-R8	0.47	20	100	16	12	8.0
MHCI05015-R68M-R8	0.68	20	100	23	10	6.0
MHCI05015-1R0M-R8	1.0	20	100	33	8.0	5.0
MHCI05015-1R5M-R8	1.5	20	100	50	6.0	4.0
MHCI05015-2R2M-R8	2.2	20	100	68	6.0	3.3
MHCI05015-3R3M-R8	3.3	20	100	84	5.0	3.0
MHCI05015-4R7M-R8	4.7	20	100	135	4.0	2.5
MHCI05015-5R6M-R8	5.6	20	100	175	3.5	2.2
MHCI05015-6R8M-R8	6.8	20	100	192	3.0	2.0
MHCI05015-100M-R8	10	20	100	195	2.0	1.5

Note: When ordering, please specify tolerance code. Tolerance: M=±20%

- Operating temperature range - 55°C ~ 125°C(Including self - temperature rise)
- Isat for Inductance drop 30% from its value without current
- I rms for a 40°C temperature rise from 25°C ambient with current
- Absolute maximum voltage 30VDC
- Measure Equipment :
 - L : WK 3260B or WK 6500P, 100kHz 0.5V
 - RDC : CHEN HWA 502 or CHEN HWA 46502B

Test Instruments : WK3260B Impedance / Material Analyzer

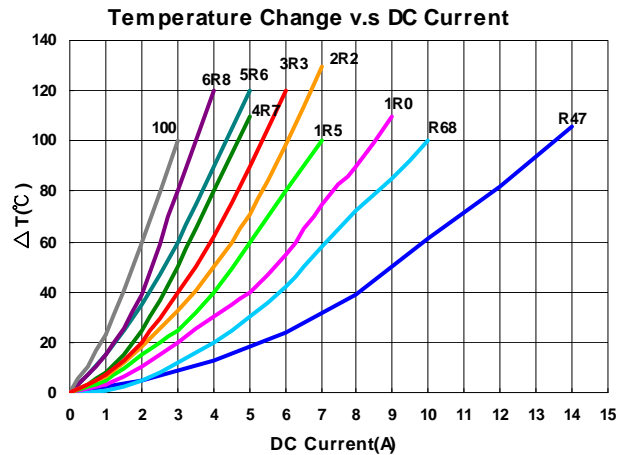
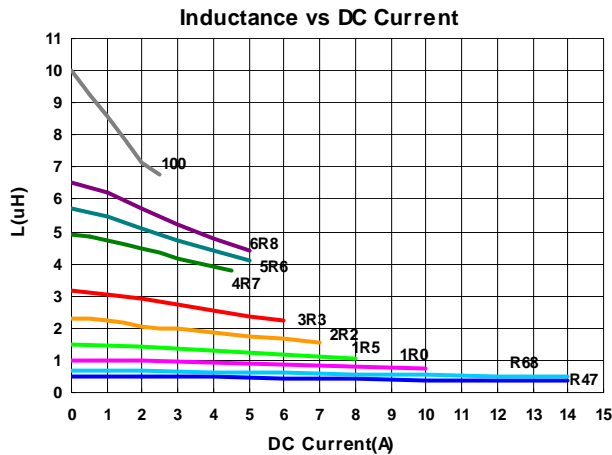

Please be sure to request approval specifications that provide further details of the products. Kindly note that the content of these specifications are subject to change or may be discontinued without advance notice. Please contact our sales department before ordering.

Electrical Characteristics

Part Number	Inductance (uH)	Tolerance (±%)	Test Frequency (kHz)	RDC (mΩ) Max	Isat (A)Typ.	Irms (A)Typ.
MHCI05015-1R0M-R8A	1.0	20	100	23	9	6.5
MHCI05015-2R2M-R8A	2.2	20	100	64	6	3.3
MHCI05015-4R7M-R8A	4.7	20	100	106	4	3.0
MHCI05015-100M-R8A	10	20	100	170	3	2.0

Note: When ordering, please specify tolerance code. Tolerance: M=±20%

- Operating temperature range - 55°C ~ 125°C(Including self - temperature rise)
- Isat for Inductance drop 30% from its value without current
- I rms for a 40°C temperature rise from 25°C ambient with current
- Absolute maximum voltage 30VDC
- Measure Equipment :
 - L : WK 3260B or WK 6500P, 100kHz 0.5V
 - RDC : CHEN HWA 502 or CHEN HWA 46502B

Test Instruments : WK3260B Impedance / Material Analyzer

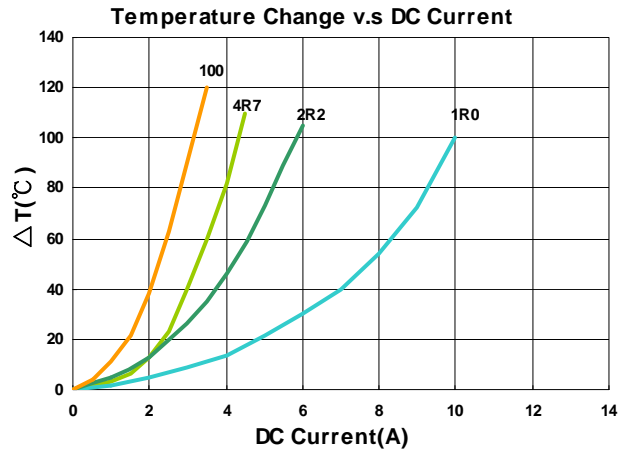
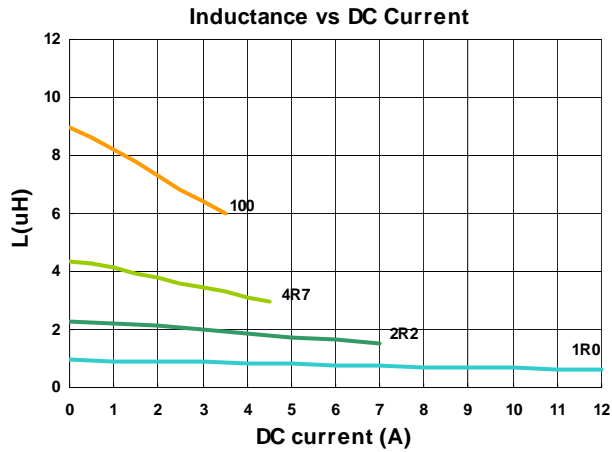

Please be sure to request approval specifications that provide further details of the products. Kindly note that the content of these specifications are subject to change or may be discontinued without advance notice. Please contact our sales department before ordering.

Electrical Characteristics

Part Number	Inductance (uH)	Tolerance (±%)	Test Frequency (kHz)	RDC (mΩ) Max	Isat (A)Typ.	Irms (A)Typ.
MHCI05018-R47M-R8A	0.47	20	100	9.0	15.5	10.5
MHCI05018-1R0M-R8A	1.0	20	100	17	9.0	8.0
MHCI05018-2R2M-R8A	2.2	20	100	35	6.5	5.0
MHCI05018-3R3M-R8A	3.3	20	100	58	5.0	4.5
MHCI05018-4R7M-R8A	4.7	20	100	85	4.0	3.5
MHCI05018-6R8M-R8A	6.8	20	100	120	3.4	2.8
MHCI05018-100M-R8A	10	20	100	155	3.0	2.5

Note: When ordering, please specify tolerance code. Tolerance: M=±20%

- Operating temperature range - 55°C ~ 125°C(Including self - temperature rise)
- Isat for Inductance drop 30% from its value without current
- I rms for a 40°C temperature rise from 25°C ambient with current
- Absolute maximum voltage 30VDC
- Measure Equipment :
 - L : WK 3260B or WK 6500P, 100kHz 0.5V
 - RDC : CHEN HWA 502 or CHEN HWA 46502B

Test Instruments : WK3260B Impedance / Material Analyzer

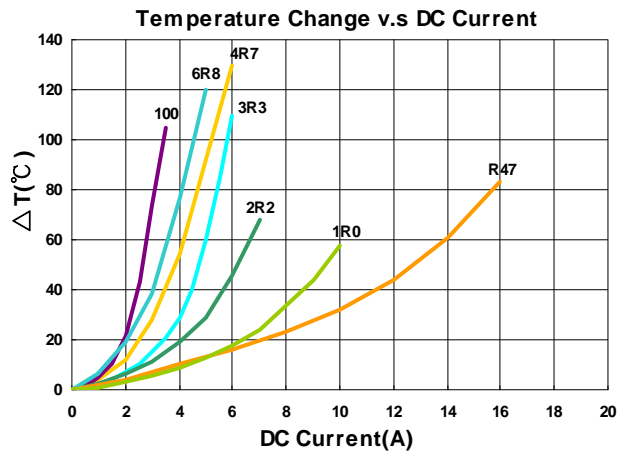
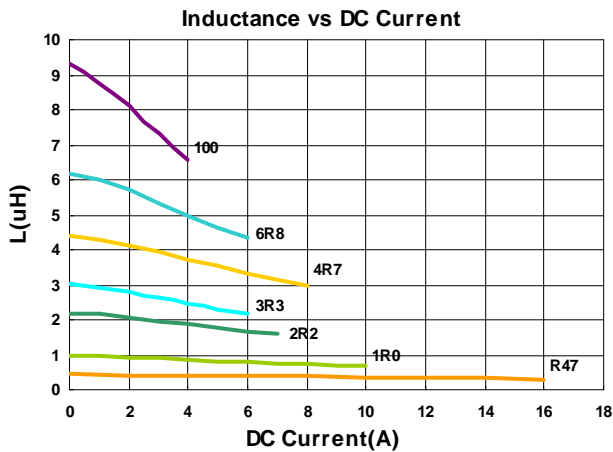

Please be sure to request approval specifications that provide further details of the products. Kindly note that the content of these specifications are subject to change or may be discontinued without advance notice. Please contact our sales department before ordering.

Electrical Characteristics

Part Number	Inductance (uH)	Tolerance (±%)	Test Frequency (kHz)	RDC (mΩ) Max	Isat (A)Typ.	Irms (A)Typ.
MHCI05020-R47M-R8	0.47	20	100	9	15.5	10.5
MHCI05020-1R0M-R8	1.0	20	100	30	7.0	6.0
MHCI05020-1R5M-R8	1.5	20	100	35	6.5	5.5
MHCI05020-2R2M-R8	2.2	20	100	45	6.0	4.0
MHCI05020-3R3M-R8	3.3	20	100	60	5.5	3.5
MHCI05020-4R7M-R8	4.7	20	100	90	5.0	3.0
MHCI05020-5R6M-R8	5.6	20	100	120	4.5	2.8
MHCI05020-6R8M-R8	6.8	20	100	125	4.5	2.8
MHCI05020-100M-R8	10	20	100	180	4.0	2.3

Note: When ordering, please specify tolerance code. Tolerance: M=±20%

- Operating temperature range - 55°C ~ 125°C(Including self - temperature rise)
- Isat for Inductance drop 30% from its value without current
- Iirms for a 40°C temperature rise from 25°C ambient with current
- Absolute maximum voltage 30VDC
- Measure Equipment :
 - L : WK 3260B or WK 6500P, 100kHz 0.5V
 - RDC : CHEN HWA 502 or CHEN HWA 46502B

Test Instruments : WK3260B Impedance / Material Analyzer

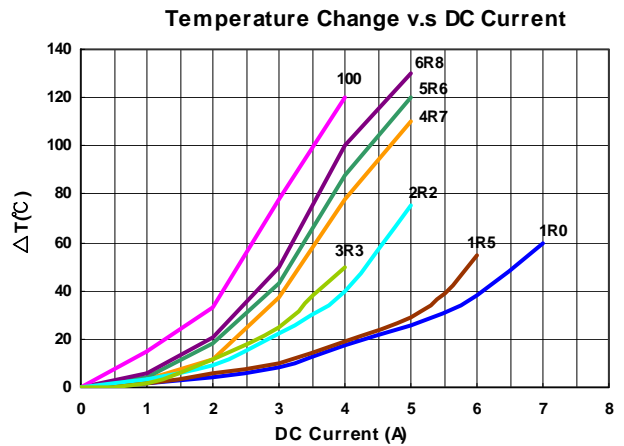
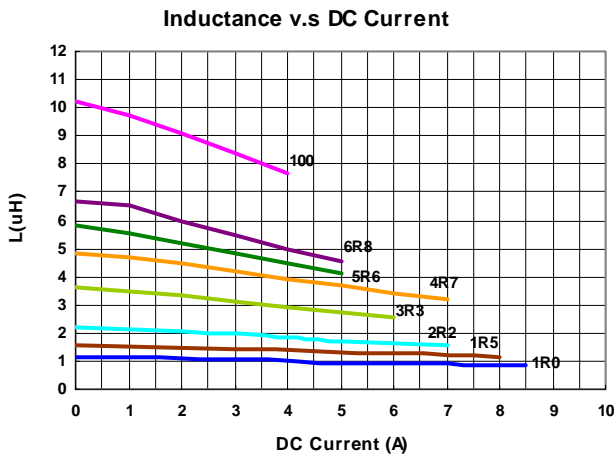

Please be sure to request approval specifications that provide further details of the products. Kindly note that the content of these specifications are subject to change or may be discontinued without advance notice. Please contact our sales department before ordering.

Electrical Characteristics

Part Number	Inductance (uH)	Tolerance (±%)	Test Frequency (kHz)	RDC (mΩ)Max	Isat (A)Typ.	Irms (A)Typ.
MHCI05030-R20M-R8	0.20	20	100	3.9	14.5	17.0
MHCI05030-R47M-R8	0.47	20	100	8	14	10.0
MHCI05030-R68M-R8	0.68	20	100	12	14	8.0
MHCI05030-1R0M-R8	1.0	20	100	15	11	7.0
MHCI05030-1R2M-R8	1.2	20	100	15	11	6.5
MHCI05030-1R5M-R8	1.5	20	100	25	10	6.0
MHCI05030-2R2M-R8	2.2	20	100	35	8	5.0
MHCI05030-3R3M-R8	3.3	20	100	46	7	4.5
MHCI05030-4R7M-R8	4.7	20	100	60	6	4.0
MHCI05030-6R8M-R8	6.8	20	100	110	5	3.0
MHCI05030-100M-R8	10	20	100	126	4.5	1.5

Note: When ordering, please specify tolerance code. Tolerance: M=±20%

- Operating temperature range - 55°C ~ 125°C(Including self - temperature rise)
- Isat for Inductance drop 30% from its value without current
- I rms for a 40°C temperature rise from 25°C ambient with current
- Absolute maximum voltage 30VDC
- Measure Equipment :
 L : WK 3260B or WK 6500P, 100kHz 0.5V
 RDC : CHEN HWA 502 or CHEN HWA 46502B

Test Instruments : WK3260B Impedance / Material Analyzer

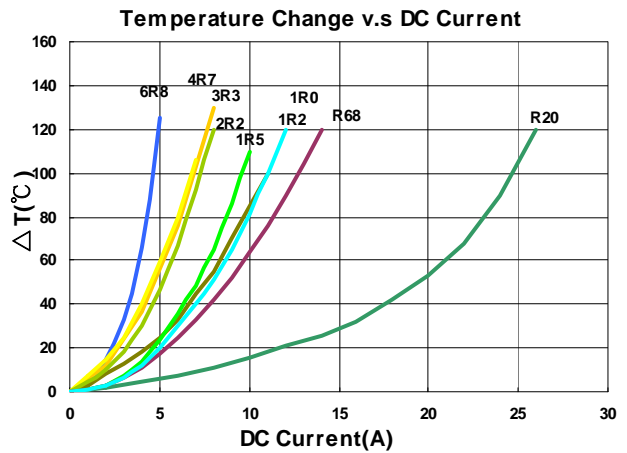
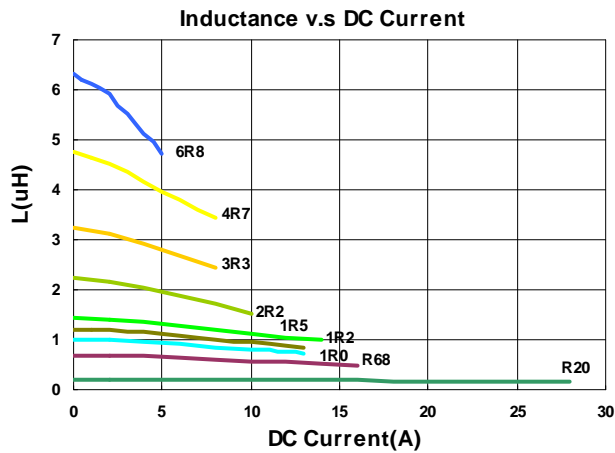

Please be sure to request approval specifications that provide further details of the products. Kindly note that the content of these specifications are subject to change or may be discontinued without advance notice. Please contact our sales department before ordering.

Electrical Characteristics

Part Number	Inductance (uH)	Tolerance (±%)	Test Frequency (kHz)	RDC (mΩ) Max	Isat (A)Typ.	Irms (A)Typ.
MHCI06012-4R7M-R8A	4.7	20	100	122	3.5	2.5
MHCI06012-6R8M-R8A	6.8	20	100	210	2.8	2.2

Note: When ordering, please specify tolerance code. Tolerance: M=±20%

- Operating temperature range - 55°C ~ 125°C(Including self - temperature rise)
- Isat for Inductance drop 30% from its value without current
- Irms for a 40°C temperature rise from 25°C ambient with current
- Absolute maximum voltage 30VDC
- Measure Equipment :
 - L : WK 3260B or WK 6500P, 100kHz 0.5V
 - RDC : CHEN HWA 502 or CHEN HWA 46502B

Test Instruments : WK3260B Impedance / Material Analyzer

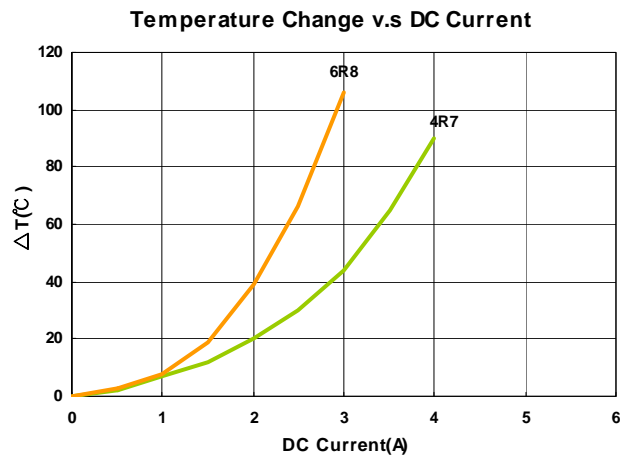
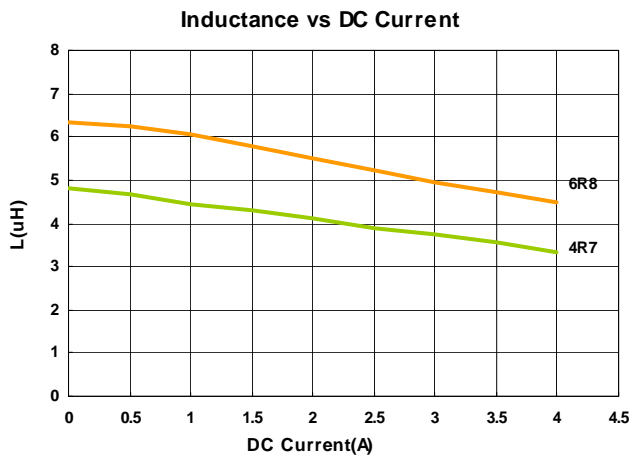

Please be sure to request approval specifications that provide further details of the products. Kindly note that the content of these specifications are subject to change or may be discontinued without advance notice. Please contact our sales department before ordering.

Electrical Characteristics

Part Number	Inductance (uH)	Tolerance (±%)	Test Frequency (kHz)	RDC (mΩ)Max	Isat (A)Typ.	Irms (A)Typ.
MHCI06015-2R2M-R8	2.2	20	100	54	6.0	3.5
MHCI06015-3R3M-R8	3.3	20	100	63	5.5	3.3
MHCI06015-4R7M-R8	4.7	20	100	105	4.5	3.2
MHCI06015-6R8M-R8	6.8	20	100	140	4.0	2.5

Note: When ordering, please specify tolerance code. Tolerance: M=±20%

- Operating temperature range - 55°C ~ 125°C(Including self - temperature rise)
- Isat for Inductance drop 30% from its value without current
- I rms for a 40°C temperature rise from 25°C ambient with current
- Absolute maximum voltage 30VDC
- Measure Equipment :
 L : WK 3260B or WK 6500P, 100kHz 0.5V
 RDC : CHEN HWA 502 or CHEN HWA 46502B

Test Instruments : WK3260B Impedance / Material Analyzer

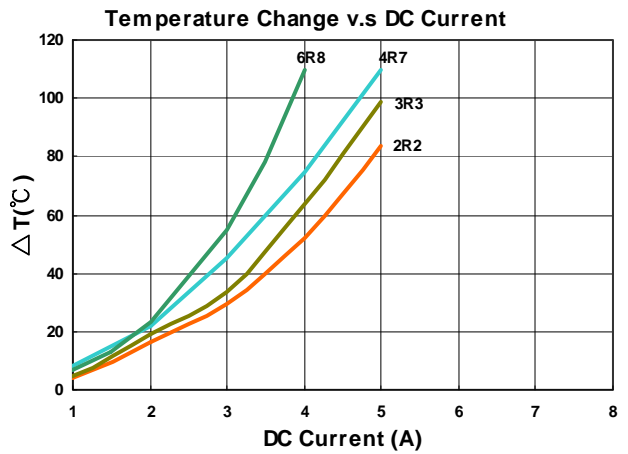
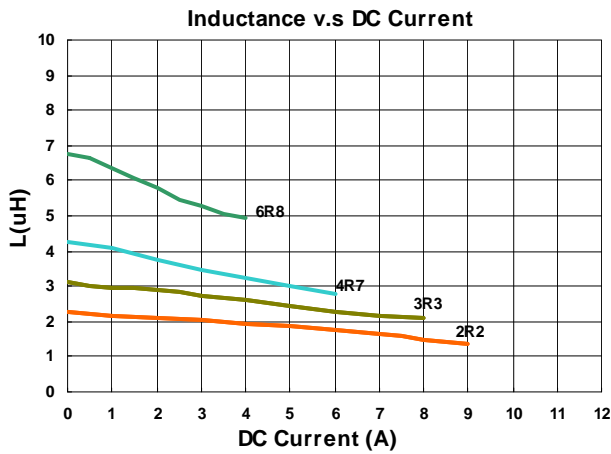

Please be sure to request approval specifications that provide further details of the products. Kindly note that the content of these specifications are subject to change or may be discontinued without advance notice. Please contact our sales department before ordering.

Electrical Characteristics

Part Number	Inductance (uH)	Tolerance (±%)	Test Frequency (kHz)	RDC (mΩ)Max	Isat (A)Typ.	Irms (A)Typ.
MHCI06015-1R0M-R8A	1.0	20	100	21	9.0	5.5
MHCI06015-3R3M-R8A	3.3	20	100	63	5.5	3.3
MHCI06015-100M-R8A	10	20	100	175	3.0	2.0

Note: When ordering, please specify tolerance code. Tolerance: M=±20%

- Operating temperature range - 55°C ~ 125°C(Including self - temperature rise)
- Isat for Inductance drop 30% from its value without current
- Irms for a 40°C temperature rise from 25°C ambient with current
- Absolute maximum voltage 30VDC
- Measure Equipment :
 L : WK 3260B or WK 6500P, 100kHz 0.5V
 RDC : CHEN HWA 502 or CHEN HWA 46502B

Test Instruments : WK3260B Impedance / Material Analyzer

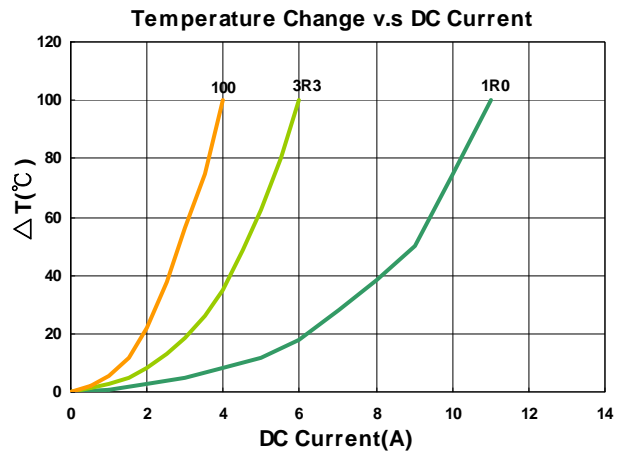
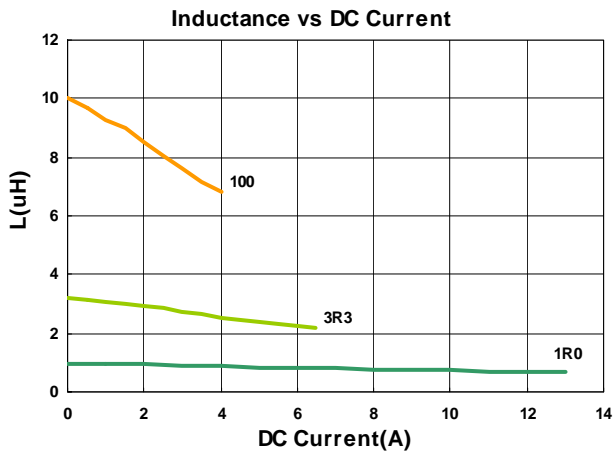

Please be sure to request approval specifications that provide further details of the products. Kindly note that the content of these specifications are subject to change or may be discontinued without advance notice. Please contact our sales department before ordering.

Electrical Characteristics

Part Number	Inductance (uH)	Tolerance (±%)	Test Frequency (kHz)	RDC (mΩ)Max	Isat (A)Typ.	Irms (A)Typ.
MHCI06018-R22M-R8A	0.22	20	100	5.2	29	14
MHCI06018-R33M-R8A	0.33	20	100	6.8	22	12
MHCI06018-R47M-R8A	0.47	20	100	8.4	18	11
MHCI06018-R68M-R8A	0.68	20	100	12.7	17	9
MHCI06018-1R0M-R8A	1.0	20	100	17	14	7
MHCI06018-1R5M-R8A	1.5	20	100	26	12	6.5
MHCI06018-2R2M-R8A	2.2	20	100	35	10	6.0
MHCI06018-4R7M-R8A	4.7	20	100	70	5	3.5
MHCI06018-6R8M-R8A	6.8	20	100	110	3.5	2.8
MHCI06018-100M-R8A	10	20	100	155	2.5	2.3

Note: When ordering, please specify tolerance code. Tolerance: M=±20%

- Operating temperature range - 55°C ~ 125°C(Including self - temperature rise)
- Isat for Inductance drop 30% from its value without current
- I rms for a 40°C temperature rise from 25°C ambient with current
- Absolute maximum voltage 30VDC
- Measure Equipment :
 - L : WK 3260B or WK 6500P, 100kHz 0.5V
 - RDC : CHEN HWA 502 or CHEN HWA 46502B

Test Instruments : WK3260B Impedance / Material Analyzer

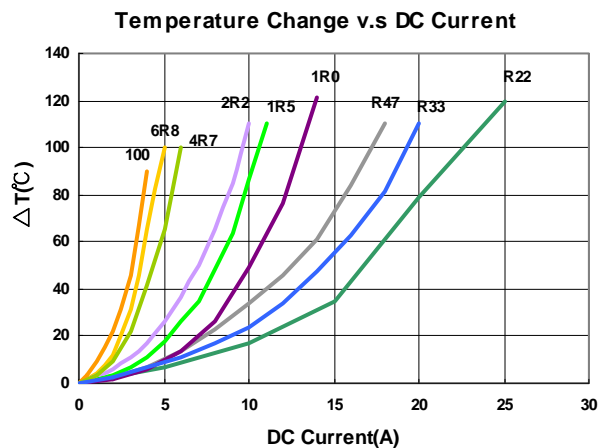
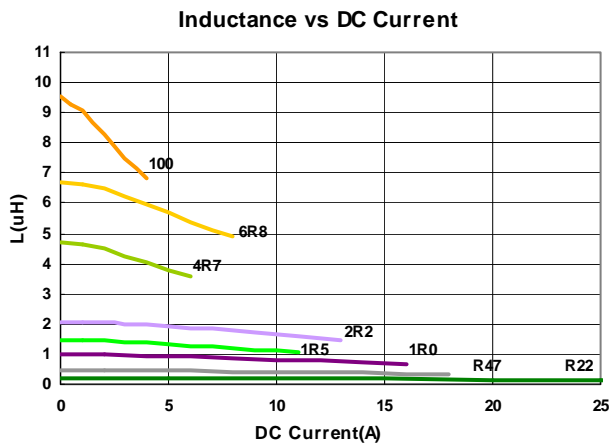

Please be sure to request approval specifications that provide further details of the products. Kindly note that the content of these specifications are subject to change or may be discontinued without advance notice. Please contact our sales department before ordering.

Electrical Characteristics

Part Number	Inductance (uH)	Tolerance (±%)	Test Frequency (kHz)	RDC (mΩ)Max	Isat (A)Typ.	Irms (A)Typ.
MHCI06024-R22M-R8A	0.22	20	100	3.2	34	21
MHCI06024-R33M-R8A	0.33	20	100	4.1	24.5	18
MHCI06024-R47M-R8A	0.47	20	100	5.1	22	15
MHCI06024-1R0M-R8A	1.0	20	100	13.5	16	9
MHCI06024-1R5M-R8A	1.5	20	100	20	15	9
MHCI06024-2R2M-R8A	2.2	20	100	28	14	7
MHCI06024-3R3M-R8A	3.3	20	100	39	10	5.5
MHCI06024-4R7M-R8A	4.7	20	100	50	10	5.0
MHCI06024-6R8M-R8A	6.8	20	100	70	6.0	4.0
MHCI06024-100M-R8A	10	20	100	101	4.0	3.1
MHCI06024-150M-R8A	15	20	100	160	3.3	2.5

Note: When ordering, please specify tolerance code. Tolerance: M=±20%

- Operating temperature range - 55°C ~ 125°C(Including self - temperature rise)
- Isat for Inductance drop 30% from its value without current
- I rms for a 40°C temperature rise from 25°C ambient with current
- Absolute maximum voltage 30VDC
- Measure Equipment :
 L : WK 3260B or WK 6500P, 100kHz 0.5V
 RDC : CHEN HWA 502 or CHEN HWA 46502B

Test Instruments : WK3260B Impedance / Material Analyzer

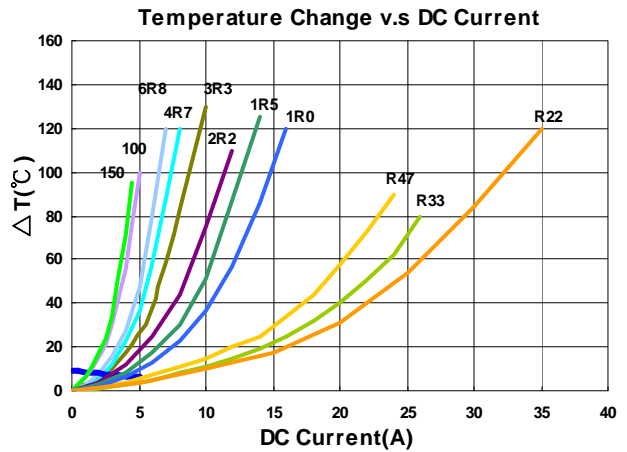
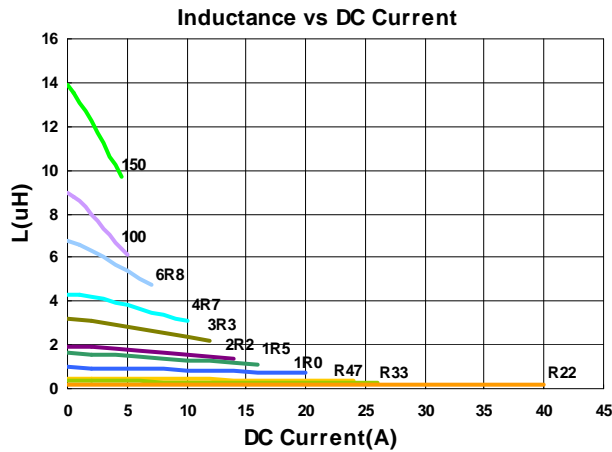

Please be sure to request approval specifications that provide further details of the products. Kindly note that the content of these specifications are subject to change or may be discontinued without advance notice. Please contact our sales department before ordering.

Electrical Characteristics

Part Number	Inductance (uH)	Tolerance (±%)	Test Frequency (kHz)	RDC (mΩ) Max	Isat (A)Typ.	Irms (A)Typ.
MHCI06030-R10M-R8	0.10	20	100	1.5	45	37
MHCI06030-R22M-R8	0.22	20	100	2.8	40	23
MHCI06030-R33M-R8	0.33	20	100	4.2	33	20
MHCI06030-R47M-R8	0.47	20	100	5.5	27	16.5
MHCI06030-R56M-R8	0.56	20	100	5.5	27	16.5
MHCI06030-R68M-R8	0.68	20	100	6.3	24	15
MHCI06030-R82M-R8	0.82	20	100	8.0	23	13
MHCI06030-1R0M-R8	1.0	20	100	10	22	12
MHCI06030-1R5M-R8	1.5	20	100	15	18	9.5
MHCI06030-1R8M-R8	1.8	20	100	15	14	9.5
MHCI06030-2R2M-R8	2.2	20	100	20	14	8.5
MHCI06030-3R3M-R8	3.3	20	100	35	12	6.0
MHCI06030-4R7M-R8	4.7	20	100	40	9	5.5
MHCI06030-5R6M-R8	5.6	20	100	40	8	5.5
MHCI06030-6R8M-R8	6.8	20	100	60	8	4.5
MHCC06030-8R2M-R7	8.2	20	100	60	6	4.5
MHCC06030-100M-R7	10	20	100	68	5.5	4.0
MHCI06030-150M-R8	15	20	100	122	5.0	3.0
MHCI06030-220M-R8	22	20	100	145	3.2	3.0
MHCI06030-330M-R8	33	20	100	270	3.0	2.0

Note: When ordering, please specify tolerance code. Tolerance: M=±20%

- Operating temperature range - 55°C ~ 125°C(Including self - temperature rise)
- Isat for Inductance drop 30% from its value without current
- I rms for a 40°C temperature rise from 25°C ambient with current
- Absolute maximum voltage 30VDC
- Measure Equipment :
 L : WK 3260B or WK 6500P, 100kHz 0.5V
 RDC : CHEN HWA 502 or CHEN HWA 46502B

Test Instruments : WK3260B Impedance / Material Analyzer

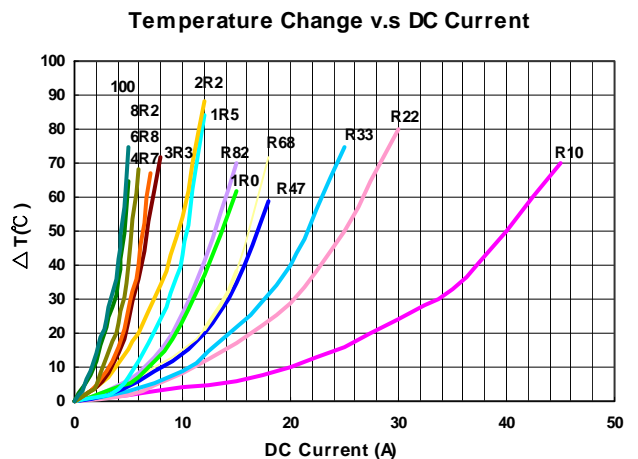
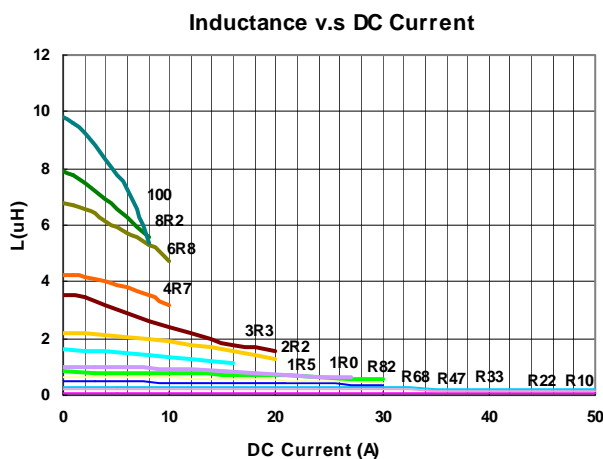

Please be sure to request approval specifications that provide further details of the products. Kindly note that the content of these specifications are subject to change or may be discontinued without advance notice. Please contact our sales department before ordering.

Electrical Characteristics

Part Number	Inductance (uH)	Tolerance (±%)	Test Frequency (kHz)	RDC (mΩ)Max	Isat (A)Typ.	Irms (A)Typ.
MHCI06030-R10M-R8A	0.10	20	100	1.7	60	32.5
MHCI06030-R15M-R8A	0.15	20	100	2.5	60	30
MHCI06030-R22M-R8A	0.22	20	100	3.0	34	23
MHCI06030-R33M-R8A	0.33	20	100	3.5	25	21
MHCI06030-R36M-R8A	0.36	20	100	3.9	24	20
MHCI06030-R47M-R8A	0.47	20	100	4.1	20	18
MHCI06030-R56M-R8A	0.56	20	100	4.5	18	16.5
MHCI06030-R68M-R8A	0.68	20	100	5.3	17	16
MHCI06030-R82M-R8A	0.82	20	100	6.0	16	14
MHCI06030-1R0M-R8A	1.0	20	100	7.4	15	12
MHCI06030-1R2M-R8A	1.2	20	100	10	14	10
MHCI06030-1R5M-R8A	1.5	20	100	12.1	14	10
MHCI06030-2R2M-R8A	2.2	20	100	15	10	8
MHCI06030-3R3M-R8A	3.3	20	100	22	9.5	6.5
MHCI06030-4R7M-R8A	4.7	20	100	33	6.5	5.5
MHCI06030-6R8M-R8A	6.8	20	100	50	6	4.5
MHCI06030-100M-R8A	10	20	100	68	5.5	4

Note: When ordering, please specify tolerance code. Tolerance: M=±20%

- Operating temperature range - 55°C ~ 125°C(Including self - temperature rise)
- Isat for Inductance drop 30% from its value without current
- I rms for a 40°C temperature rise from 25°C ambient with current
- Absolute maximum voltage 30VDC
- Measure Equipment :
 - L : WK 3260B or WK 6500P, 100kHz 0.5V
 - RDC : CHEN HWA 502 or CHEN HWA 46502B

Test Instruments : WK3260B Impedance / Material Analyzer

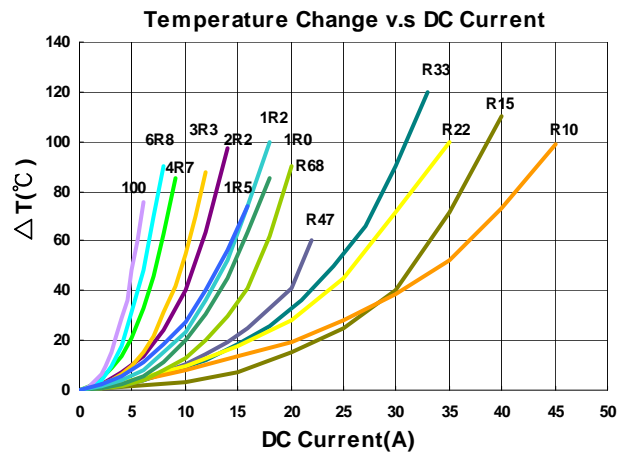
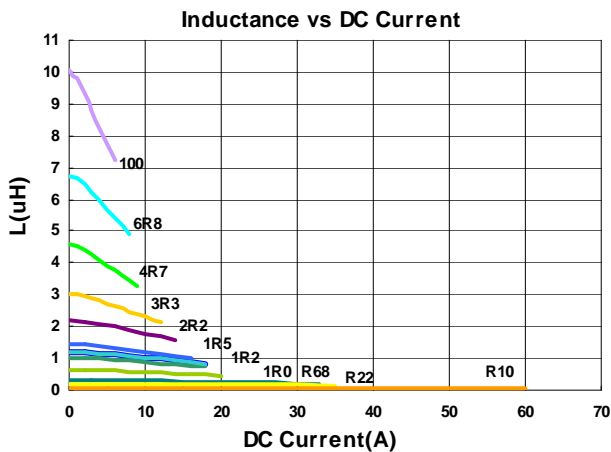

Please be sure to request approval specifications that provide further details of the products. Kindly note that the content of these specifications are subject to change or may be discontinued without advance notice. Please contact our sales department before ordering.

Electrical Characteristics

Part Number	Inductance (uH)	Tolerance (±%)	Test Frequency (kHz)	RDC (mΩ) Max	Isat (A)Typ.	Irms (A)Typ.
MHCI06050-R56M-R8A	0.56	20	100	3.3	20	20
MHCI06050-1R0M-R8A	1.0	20	100	6.5	15	13
MHCI06050-2R2M-R8A	2.2	20	100	12.5	12	8
MHCI06050-3R3M-R8A	3.3	20	100	20.9	9	7
MHCI06050-4R7M-R8A	4.7	20	100	25.0	7	6.5

Note: When ordering, please specify tolerance code. Tolerance: M=±20%

- Operating temperature range - 55°C ~ 125°C(Including self - temperature rise)
- Isat for Inductance drop 30% from its value without current
- I rms for a 40°C temperature rise from 25°C ambient with current
- Absolute maximum voltage 30VDC
- Measure Equipment :
 L : WK 3260B or WK 6500P, 100kHz 0.5V
 RDC : CHEN HWA 502 or CHEN HWA 46502B

Test Instruments : WK3260B Impedance / Material Analyzer

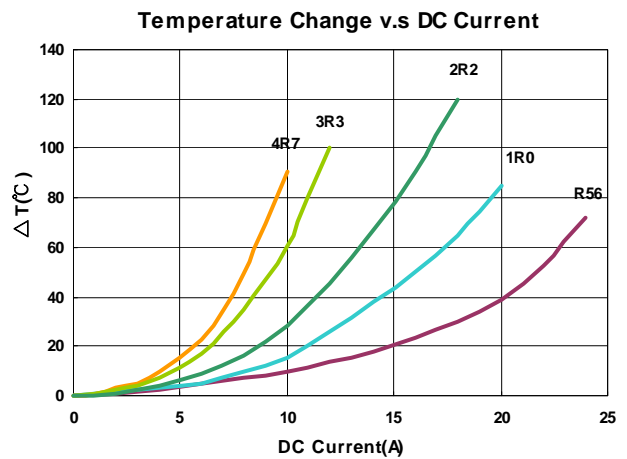
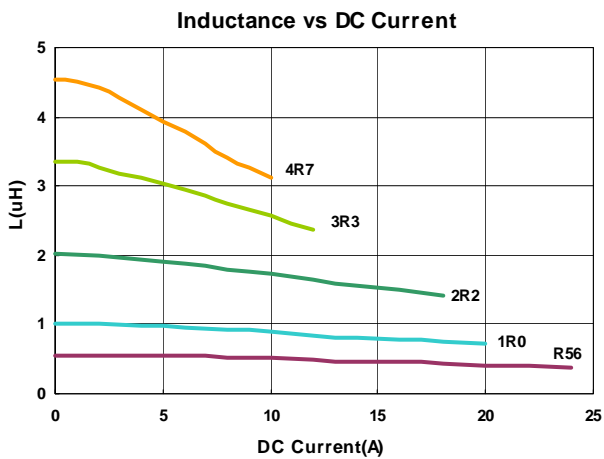

Please be sure to request approval specifications that provide further details of the products. Kindly note that the content of these specifications are subject to change or may be discontinued without advance notice. Please contact our sales department before ordering.

Electrical Characteristics

Part Number	Inductance (uH)	Tolerance (±%)	Test Frequency (kHz)	RDC (mΩ) Max	Isat (A)Typ.	Irms (A)Typ.
MHCC10030-R33M-R7A	0.33	20	100	1.6	32	23
MHCC10030-1R0M-R7A	1.0	20	100	6.0	21	15
MHCC10030-3R3M-R7A	3.3	20	100	16.0	14	9

Note: When ordering, please specify tolerance code. Tolerance: M=±20%

- Operating temperature range - 55°C ~ 125°C(Including self - temperature rise)
- Isat for Inductance drop 30% from its value without current
- I rms for a 40°C temperature rise from 25°C ambient with current
- Absolute maximum voltage 30VDC
- Measure Equipment :
 L : WK 3260B or WK 6500P, 100kHz 0.5V
 RDC : CHEN HWA 502 or CHEN HWA 46502B

Test Instruments : WK3260B Impedance / Material Analyzer

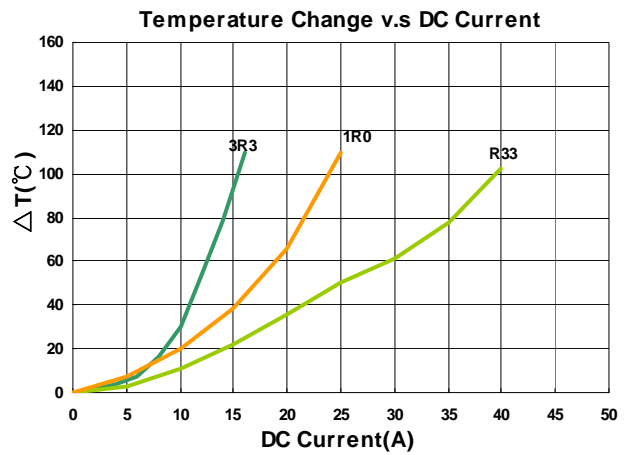
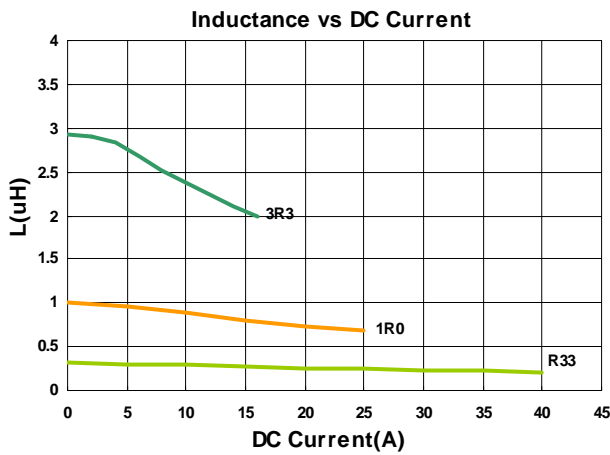

Please be sure to request approval specifications that provide further details of the products. Kindly note that the content of these specifications are subject to change or may be discontinued without advance notice. Please contact our sales department before ordering.

Electrical Characteristics

Part Number	Inductance (uH)	Tolerance (±%)	Test Frequency (kHz)	RDC (mΩ) Max	Isat (A)Typ.	Irms (A)Typ.
MHCC10040-R22M-R7	0.22	20	100	0.6	45	35
MHCC10040-R36M-R7	0.36	20	100	1.2	42	34
MHCC10040-R45M-R7	0.45	20	100	1.2	38	33
MHCC10040-R47M-R7	0.47	20	100	1.2	38	33
MHCC10040-R56M-R7	0.56	20	100	1.55	32	27
MHCC10040-R68M-R7	0.68	20	100	1.55	30	27
MHCC10040-1R0M-R7	1.0	20	100	3.1	26	20
MHCC10040-1R5M-R7	1.5	20	100	4.2	22	16
MHCC10040-1R8M-R7	1.8	20	100	5	16	15.3
MHCC10040-2R2M-R7	2.2	20	100	7	16	14
MHCC10040-3R3M-R7	3.3	20	100	13.2	12	11
MHCC10040-4R7M-R7	4.7	20	100	16.5	12	9
MHCC10040-6R8M-R7	6.8	20	100	25	10	6
MHCC10040-8R2M-R7	8.2	20	100	30	9	6
MHCC10040-100M-R7	10	20	100	30	7	6.5
MHCC10040-150M-R7	15	20	100	45	6	6.25
MHCC10040-220M-R7	22	20	100	72	5.5	5

Note: When ordering, please specify tolerance code. Tolerance: M=±20%

- Operating temperature range - 55°C ~ 125°C(Including self - temperature rise)
- Isat for Inductance drop 30% from its value without current
- I rms for a 40°C temperature rise from 25°C ambient with current
- Absolute maximum voltage 30VDC
- Measure Equipment :
 L : WK 3260B or WK 6500P, 100kHz 0.5V
 RDC : CHEN HWA 502 or CHEN HWA 46502B

Test Instruments : WK3260B Impedance / Material Analyzer

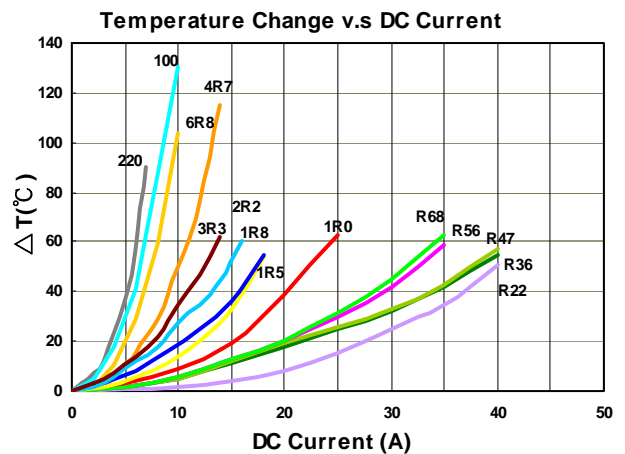
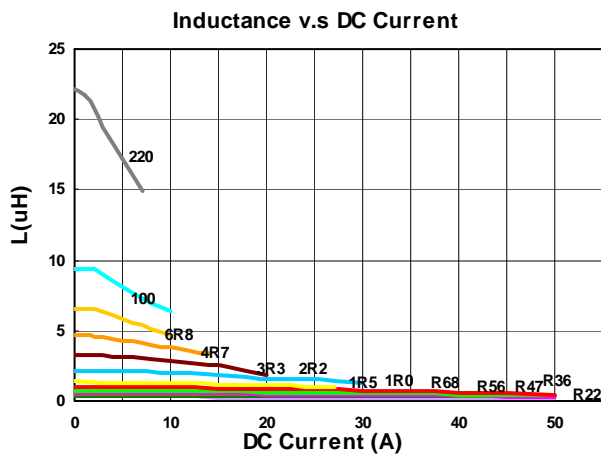

Please be sure to request approval specifications that provide further details of the products. Kindly note that the content of these specifications are subject to change or may be discontinued without advance notice. Please contact our sales department before ordering.

Electrical Characteristics

Part Number	Inductance (uH)	Tolerance (±%)	Test Frequency (kHz)	RDC (mΩ) Max	Isat (A)Typ.	Irms (A)Typ.
MHCC12050-R47M-R7	0.47	20	100	1.2	46	37
MHCC12050-1R0M-R7	1.0	20	100	2.5	37	29
MHCC12050-1R5M-R7	1.5	20	100	3.0	28	28
MHCC12050-4R7M-R7	4.7	20	100	11.5	16	11
MHCC12050-6R8M-R7	6.8	20	100	22	14	9
MHCC12050-100M-R7	10	20	100	35	13	7

Note: When ordering, please specify tolerance code. Tolerance: M=±20%

- Operating temperature range - 55°C ~ 125°C(Including self - temperature rise)
- Isat for Inductance drop 30% from its value without current
- I rms for a 40°C temperature rise from 25°C ambient with current
- Absolute maximum voltage 30VDC
- Measure Equipment :
 L : WK 3260B or WK 6500P, 100kHz 0.5V
 RDC : CHEN HWA 502 or CHEN HWA 46502B

Test Instruments : WK3260B Impedance / Material Analyzer

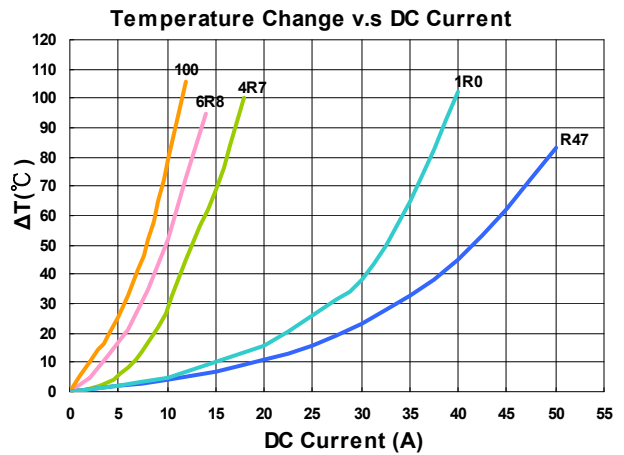
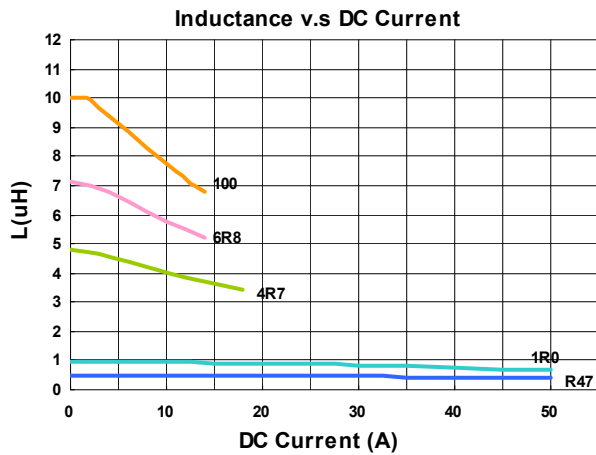

Please be sure to request approval specifications that provide further details of the products. Kindly note that the content of these specifications are subject to change or may be discontinued without advance notice. Please contact our sales department before ordering.

Electrical Characteristics

Part Number	Inductance (uH)	Tolerance (±%)	Test Frequency (kHz)	RDC (mΩ) Max	Isat (A)Typ.	Irms (A)Typ.
MHCC12060-100M-R7A	10	20	100	20.7	12.5	10
MHCC12060-150M-R7A	15	20	100	29.0	9.0	6.0
MHCC12060-220M-R7A	22	20	100	39.5	7.5	5.0
MHCC12060-330M-R7A	33	20	100	75	6.0	4.0

Note: When ordering, please specify tolerance code. Tolerance: M=±20%

- Operating temperature range - 55°C ~ 125°C(Including self - temperature rise)
- Isat for Inductance drop 30% from its value without current
- I rms for a 40°C temperature rise from 25°C ambient with current
- Absolute maximum voltage 30VDC
- Measure Equipment :
 - L : WK 3260B or WK 6500P, 100kHz 0.5V
 - RDC : CHEN HWA 502 or CHEN HWA 46502B

Test Instruments : WK3260B Impedance / Material Analyzer

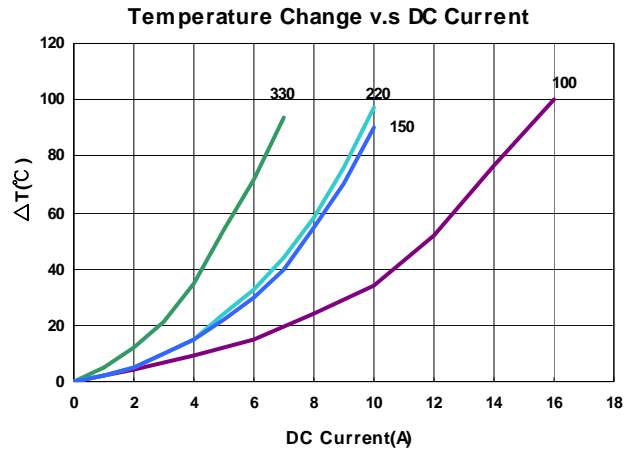
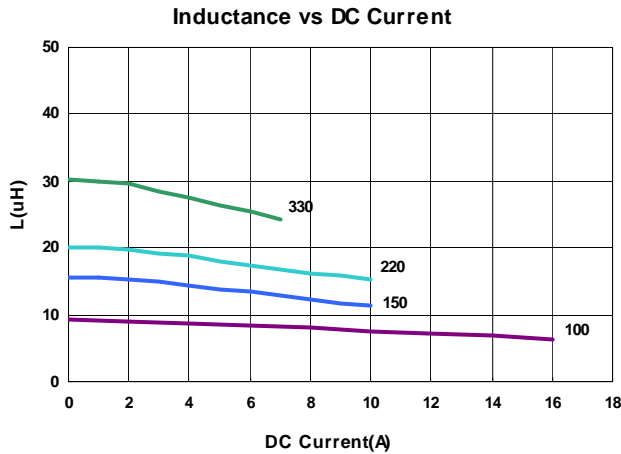

Packaging Specifications

Tape Dimensions

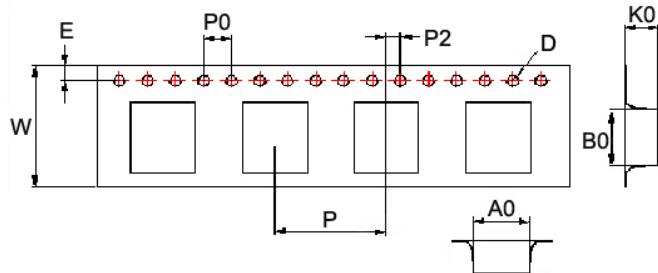

Tape Material

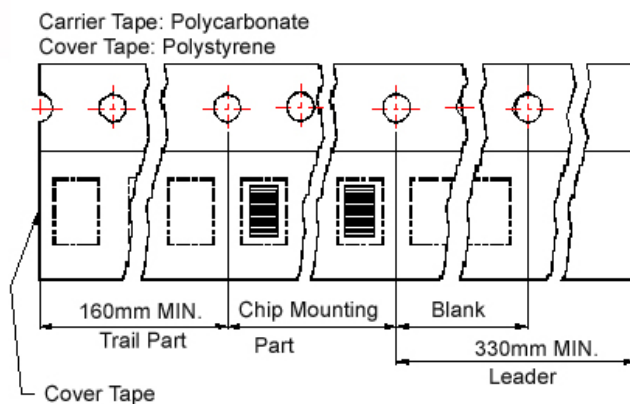

Reel Dimensions

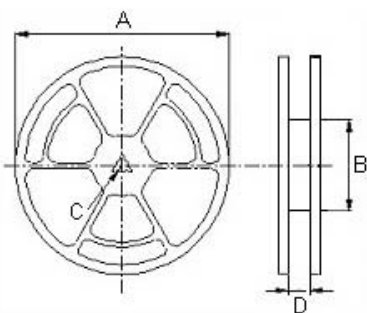

Dimensions in mm

TYPE	Tape Dimensions									Reel Dimensions				Quantity PCS / REEL
	A0	B0	K0	D	E	W	P	P0	P2	A	B	C	D	
04012	4.6	5.0	1.5	1.55	1.75	12	8	4	2	330	100	13	13.4	2000
04015	4.4	4.9	1.8	1.55	1.75	12	8	4	2	330	100	13	13.4	2000
04020	4.3	4.9	2.4	1.55	1.75	12	8	4	2	330	100	13	13.4	2000
05012	5.9	6.2	1.5	1.55	1.75	16	12	4	2	330	100	13	16.0	1000
05015	5.7	6.1	1.9	1.55	1.75	16	12	4	2	330	100	13	16.0	1000
05018	5.9	6.2	2.2	1.55	1.75	16	12	4	2	330	100	13	16.0	1000
05020	5.7	5.9	2.4	1.55	1.75	16	12	4	2	330	100	13	16.0	1000
05030	5.9	6.2	3.4	1.55	1.75	16	12	4	2	330	100	13	16.0	1000
06012	6.9	7.6	1.6	1.55	1.75	16	12	4	2	330	100	13	16.0	1000
06015	6.9	7.6	1.9	1.55	1.75	16	12	4	2	330	100	13	16.0	1000
06018	6.9	7.6	2.2	1.55	1.75	16	12	4	2	330	100	13	16.0	1000
06024	6.9	7.6	2.9	1.55	1.75	16	12	4	2	330	100	13	16.0	1000
06030	6.9	7.6	3.4	1.55	1.75	16	12	4	2	330	100	13	16.0	1000
06050	6.9	7.6	5.4	1.55	1.75	16	12	4	2	330	100	13	16.0	1000
10030	10.6	11.7	3.25	1.55	1.75	24	16	4	2	330	100	13	24.4	500
10040	10.6	11.7	4.25	1.55	1.75	24	16	4	2	330	100	13	24.4	500
12050	13	14	5.25	1.55	1.75	24	16	4	2	330	100	13	24.4	500
12060	13	14	6.25	1.55	1.75	24	16	4	2	330	100	13	24.4	500

MHCB Series



MHCB series is designed for low profile type with low RDC and ultra large current. Its molded magnetic shielded type is suitable for high-density mounting and ultra low buzz noise. Soldering conditions can be easily confirmed when mounting onto the board. This series also provides customers with embossed carrier type packaging for automatic mounting machine.

Features

- RoHS, Halogen Free and REACH Compliance
- High rated current
- Ultra low buzz noise

Applications

- Laptops and PCs
- Switches and servers
- Base stations
- DC/DC converters

Product Identification

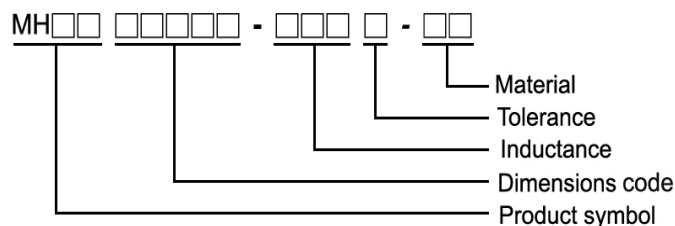

Shape and Dimensions

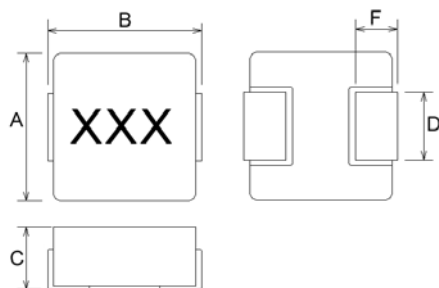

Dimensions in mm

TYPE	A	B	C	D	F
06030	6.6±0.2	6.95±0.35	2.8±0.2	3.0±0.3	1.6±0.5

Recommended Pattern

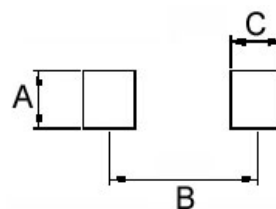

Dimensions in mm

TYPE	A	B	C
06030	3.5	6.05	2.35

Electrical Characteristics

Part Number	Inductance (uH)	Tolerance (±%)	Test Frequency (kHz)	RDC (mΩ) Max	Isat (A)Typ.	Irms (A)Typ.
MHCB06030-R10M-C1	0.10	20	100	1.7	60	32.5
MHCB06030-R22M-C1	0.22	20	100	2.8	40	23.0
MHCB06030-R33M-C1	0.33	20	100	3.9	30	20.0
MHCB06030-R47M-C1	0.47	20	100	4.2	26	17.5
MHCB06030-R68M-C1	0.68	20	100	5.5	25	15.5
MHCB06030-R82M-C1	0.82	20	100	8.0	24	13.0
MHCB06030-1R0M-C1	1.0	20	100	10	22	11.0
MHCB06030-1R5M-C1	1.5	20	100	15	18	9.0
MHCB06030-2R2M-C1	2.2	20	100	20	14	8.0
MHCB06030-3R3M-C1	3.3	20	100	30	13.5	6.0
MHCB06030-4R7M-C1	4.7	20	100	40	10.0	5.5
MHCB06030-6R8M-C1	6.8	20	100	60	8.0	4.5
MHCB06030-100M-C1	10	20	100	102	7.0	3.0

Note: When ordering, please specify tolerance code. Tolerance: M=±20%

- Operating temperature range - 55°C ~ 125°C(Including self - temperature rise)
- Isat for Inductance drop 20% from its value without current
- Irms for a 40°C temperature rise from 25°C ambient with current
- Absolute maximum voltage 30VDC
- Measure Equipment :
 L : WK 3260B or WK 6500P, 100KHz 0.5V
 RDC : CHEN HWA 502 or CHEN HWA 46502B
 Irms : CHROMA 1810

Test Instruments : WK3260B Impedance / Material Analyzer

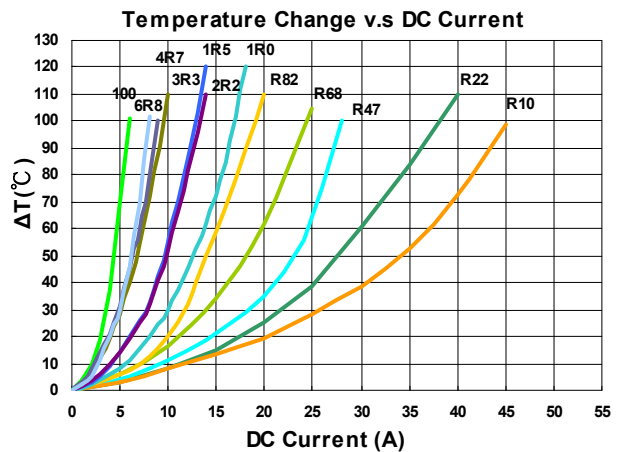
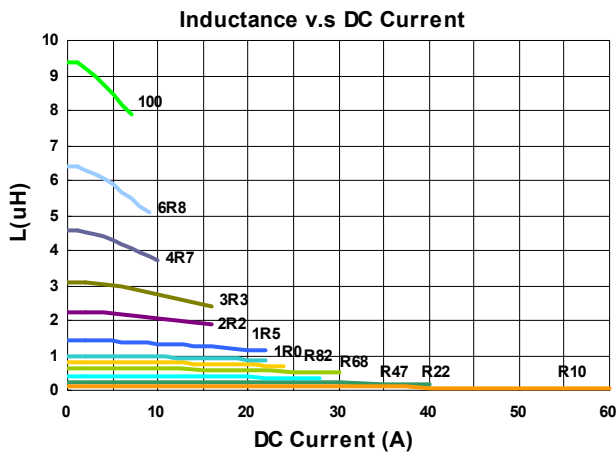

Please be sure to request approval specifications that provide further details of the products. Kindly note that the content of these specifications are subject to change or may be discontinued without advance notice. Please contact our sales department before ordering.

Packaging Specifications

Tape Dimensions

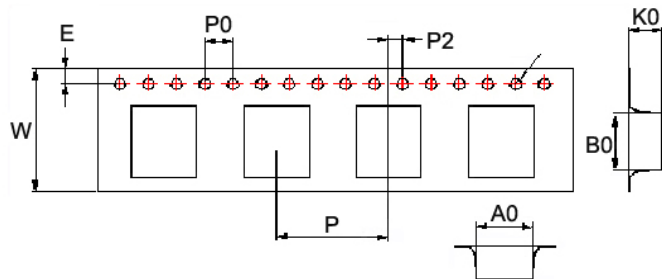

Tape Material

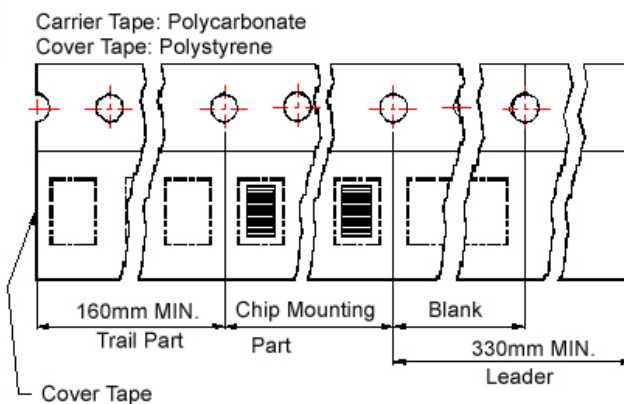

Reel Dimensions

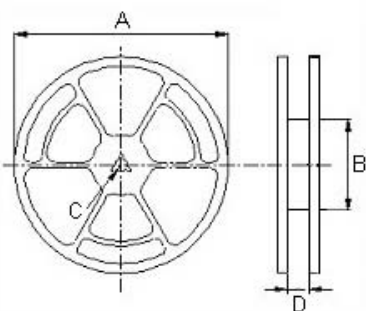

Dimensions in mm

TYPE	Tape Dimensions									Reel Dimensions				Quantity
	A0	B0	K0	D	E	W	P	P0	P2	A	B	C	D	PCS / REEL
06030	6.9	7.6	3.4	1.55	1.75	16	12	4	2	330	100	13	16.0	1000

MRSC Series

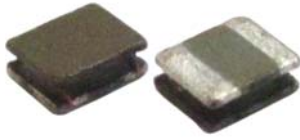

MRSC series, metal alloy wire wound power inductor, its rated current could be increased up to 35% compare to ferrite base power inductor.

Features

- RoHS, Halogen Free and REACH Compliance
- Constructure Low RDC and high rated current.
- Wide inductance range
- Shielded and miniature package design

Applications

- Smartphones, tablets and wearable devices
- DSC, camcorders
- DC/DC converters

Product Identification

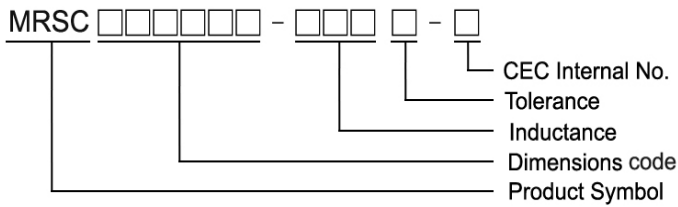

Shape and Dimensions

Recommended Pattern

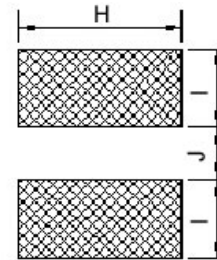
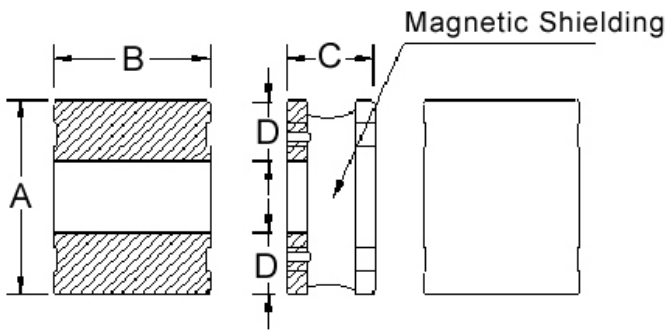

Dimensions in mm

TYPE	A	B	C	D	H	I	J
MRSC201B10	2.0±0.2	1.6±0.2	1.0 Max	0.65	1.7	0.7	0.7
MRSC201B12	2.0±0.2	1.6±0.2	1.2 Max	0.50	1.7	0.6	0.9
MRSC252A10	2.5±0.2	2.0±0.2	1.0 Max	0.85	2.1	0.9	0.8
MRSC252A12	2.5±0.2	2.0±0.2	1.2 Max	0.85	2.1	0.9	0.8

Electrical Characteristics

Part Number	Inductance (uH)	Test Frequency (MHz)	Tolerance (±%)	SRF (MHz) Min	RDC(mΩ) (Max) Typ	Isat (A) (Max) Typ	Irms (A) (Max) Typ
MRSC201B10-4R7□-N	4.7	1	20, 30	25	370(308)	1.00(1.20)	0.86(0.96)
MRSC201B10-6R8□-N	6.8	1	20, 30	19	526(438)	0.86(0.96)	0.73(0.82)
MRSC201B10-100□-N	10	1	20, 30	15	768(640)	0.70(0.78)	0.64(0.72)
MRSC201B10-220□-N	22	1	20, 30	9	1560(1300)	0.49(0.55)	0.40(0.45)

Note: When ordering, please specify tolerance code. Tolerance: M=±20% , T =±30%

- Operating temperature range - 40°C ~ 125°C(Including self - temperature rise)
- Isat for Inductance drop 30% from its value without current
- I rms for a 40°C temperature rise from 25°C ambient with current
- Measure Equipment :
- L : Agilent 4285A+Agilent 42841A, or equivalent,1MHz 200mV
- RDC : DIGITAL MILLINHM METER CHROMA 16502, or equivalent
- Isat & I rms : Agilent/HP4285A+Agilent 42841A
- SRF : HP4294A+16092A

Test Instruments : HP4285A Material/Impedance Analyzer

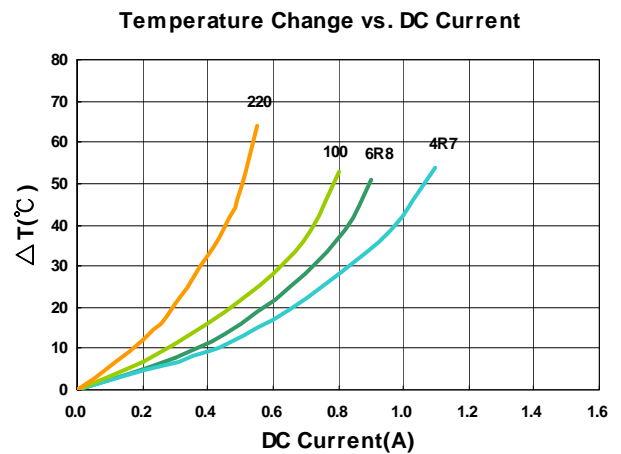
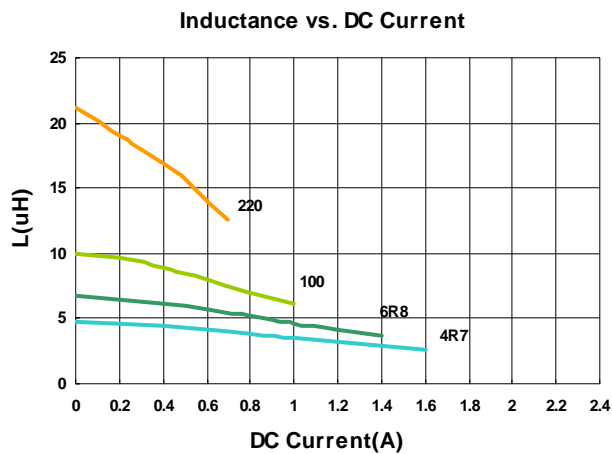

Please be sure to request approval specifications that provide further details of the products. Kindly note that the content of these specifications are subject to change or may be discontinued without advance notice. Please contact our sales department before ordering.

Electrical Characteristics

Part Number	Inductance (uH)	Test Frequency (MHz)	Tolerance (±%)	SRF (MHz) Min	RDC(mΩ) (Max) Typ	Isat (A) (Max) Typ	Irms (A) (Max) Typ
MRSC201B12-4R7□-N	4.7	1	20, 30	26	324(270)	1.20(1.40)	1.00(1.20)
MRSC201B12-6R8□-N	6.8	1	20, 30	20	456(380)	1.00(1.20)	0.78(0.92)
MRSC201B12-100□-N	10	1	20, 30	16	720(600)	0.85(0.95)	0.65(0.73)
MRSC201B12-220□-N	22	1	20, 30	10	1500(1250)	0.57(0.64)	0.41(0.46)

Note: When ordering, please specify tolerance code. Tolerance: M=±20% , T =±30%

- Operating temperature range - 40°C ~ 125°C(Including self - temperature rise)
- Isat for Inductance drop 30% from its value without current
- I rms for a 40°C temperature rise from 25°C ambient with current
- Measure Equipment :
- L : Agilent 4285A+Agilent 42841A, or equivalent,1MHz 200mV
- RDC : DIGITAL MILLINHM METER CHROMA 16502, or equivalent
- Isat & I rms : Agilent/HP4285A+Agilent 42841A
- SRF : HP4294A+16092A

Test Instruments : HP4285A Material/Impedance Analyzer

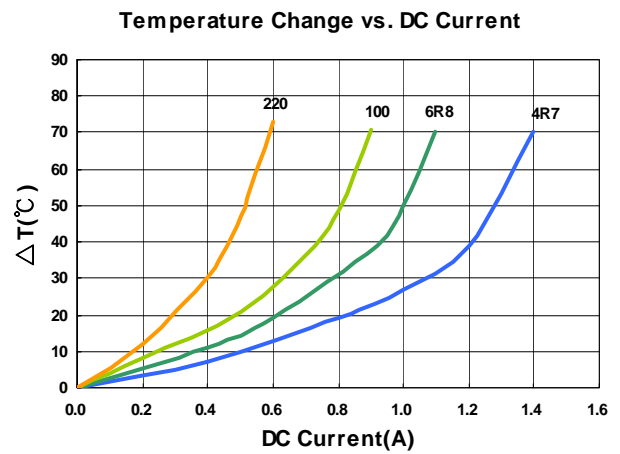
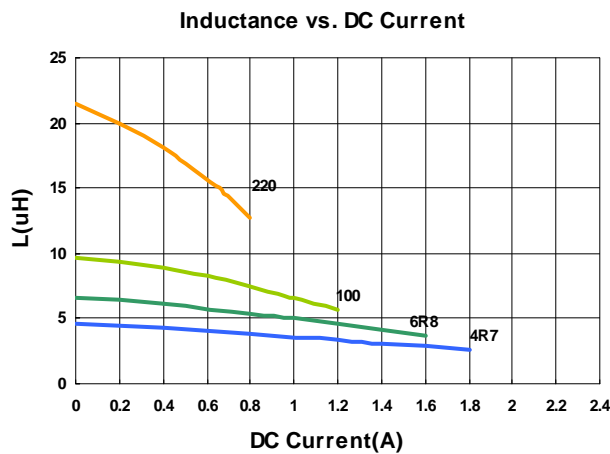

Please be sure to request approval specifications that provide further details of the products. Kindly note that the content of these specifications are subject to change or may be discontinued without advance notice. Please contact our sales department before ordering.

Electrical Characteristics

Part Number	Inductance (uH)	Test Frequency (MHz)	Tolerance (±%)	SRF (MHz) Min	RDC(mΩ) (Max) Typ	Isat (A) (Max) Typ	Irms (A) (Max) Typ
MRSC252A10-4R7□-N	4.7	1	20, 30	19	264(220)	1.30(1.40)	1.10(1.20)
MRSC252A10-6R8□-N	6.8	1	20, 30	15	396(330)	1.00(1.10)	0.90(1.00)
MRSC252A10-100□-N	10	1	20, 30	12	500(435)	0.90(1.00)	0.80(0.90)
MRSC252A10-220□-N	22	1	20, 30	8	1260(1050)	0.56(0.63)	0.45(0.50)

Note: When ordering, please specify tolerance code. Tolerance: M=±20% , T =±30%

- Operating temperature range - 40°C ~ 125°C(Including self - temperature rise)
- Isat for Inductance drop 30% from its value without current
- I rms for a 40°C temperature rise from 25°C ambient with current
- Measure Equipment :
- L : Agilent 4285A+Agilent 42841A, or equivalent,1MHz 200mV
- RDC : DIGITAL MILLINHM METER CHROMA 16502, or equivalent
- Isat & I rms : Agilent/HP4285A+Agilent 42841A
- SRF : HP4294A+16092A

Test Instruments : HP4285A Material/Impedance Analyzer

Inductance vs. DC Current

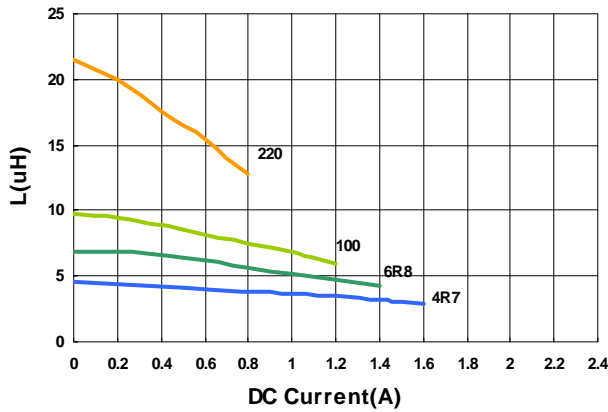

Temperature Change vs. DC Current

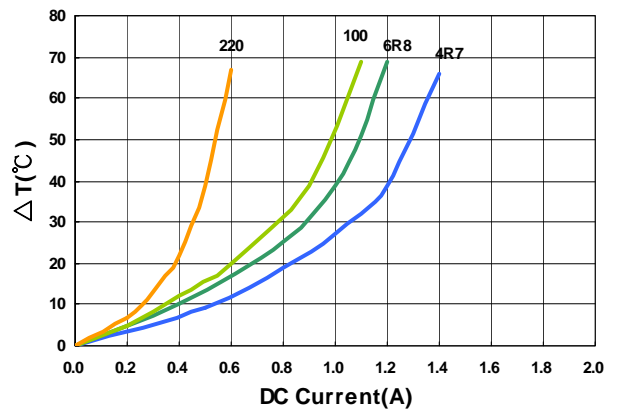

Please be sure to request approval specifications that provide further details of the products. Kindly note that the content of these specifications are subject to change or may be discontinued without advance notice. Please contact our sales department before ordering.

Electrical Characteristics

Part Number	Inductance (uH)	Test Frequency (MHz)	Tolerance (±%)	SRF (MHz) Min	RDC(mΩ) (Max) Typ	Isat (A) (Max) Typ	Irms (A) (Max) Typ
MRSC252A12-4R7□-N	4.7	1	20, 30	23	240(200)	1.70(1.90)	1.30(1.50)
MRSC252A12-6R8□-N	6.8	1	20, 30	16	345(285)	1.30(1.60)	1.00(1.20)
MRSC252A12-100□-N	10	1	20, 30	14	480(400)	1.00(1.30)	0.85(1.00)
MRSC252A12-220□-N	22	1	20, 30	8	1090(910)	0.74(0.83)	0.54(0.60)

Note: When ordering, please specify tolerance code. Tolerance: M=±20% , T =±30%

- Operating temperature range - 40°C ~ 125°C(Including self - temperature rise)
- Isat for Inductance drop 30% from its value without current
- I rms for a 40°C temperature rise from 25°C ambient with current
- Measure Equipment :
- L : Agilent 4285A+Agilent 42841A, or equivalent,1MHz 200mV
- RDC : DIGITAL MILLINHM METER CHROMA 16502, or equivalent
- Isat & I rms : Agilent/HP4285A+Agilent 42841A
- SRF : HP4294A+16092A

Test Instruments : HP4285A Material/Impedance Analyzer

Inductance vs. DC Current

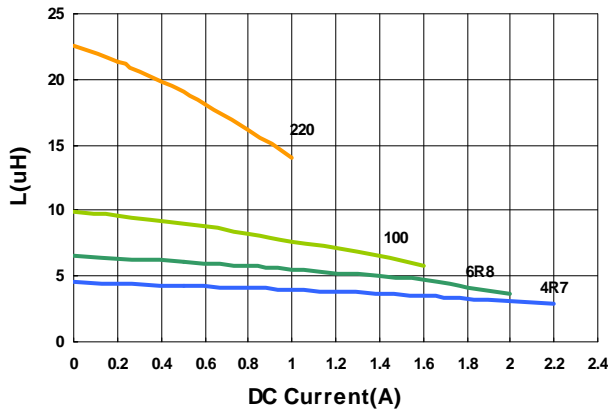

Temperature Change vs. DC Current

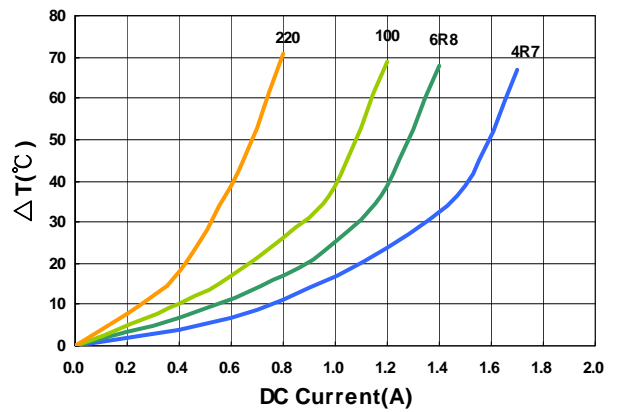

Please be sure to request approval specifications that provide further details of the products. Kindly note that the content of these specifications are subject to change or may be discontinued without advance notice. Please contact our sales department before ordering.

Packaging Specifications

Tape Dimensions

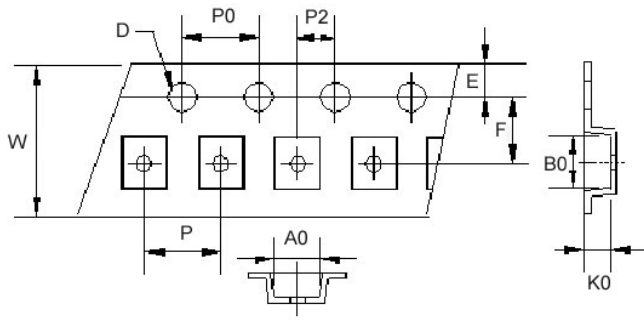

Reel Dimensions

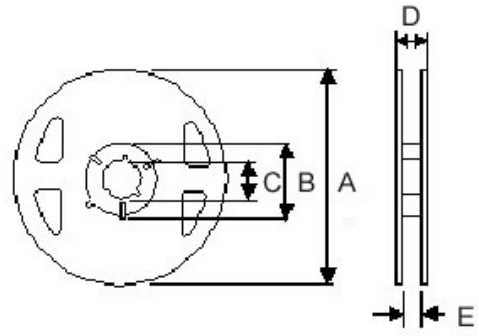

Dimensions in mm

TYPE	Tape Dimensions										Reel Dimensions					Quantity PCS / Reel
	A0	B0	K0	D	E	F	W	P	P0	P2	A	B	C	D	E	
MRSC201B10	1.90	2.20	1.15	1.55	1.75	3.5	8	4	4	2	180	60	13	14.4	8.4	2000
MRSC201B12	1.95	2.20	1.35	1.55	1.75	3.5	8	4	4	2	180	60	13	14.4	8.4	2000
MRSC252A10	2.35	2.80	1.15	1.55	1.75	3.5	8	4	4	2	180	60	13	14.4	8.4	2000
MRSC252A12	2.35	2.80	1.35	1.55	1.75	3.5	8	4	4	2	180	60	13	14.4	8.4	2000

LVS Series



LVS series, an automatic assembly constructed power inductor, is shielded with magnetic resin and suitable for the portable DC-DC converter applications.

Features

- RoHS, Halogen Free and REACH Compliance
- Shielded with magnetic resin
- Various package size and wide inductance range
- Optimize electrical characteristics by using different ferrite core figures

Applications

- AP Routers
- STBs
- LCD TVs, monitors and panels
- Game consoles
- DC/DC converters

Product Identification

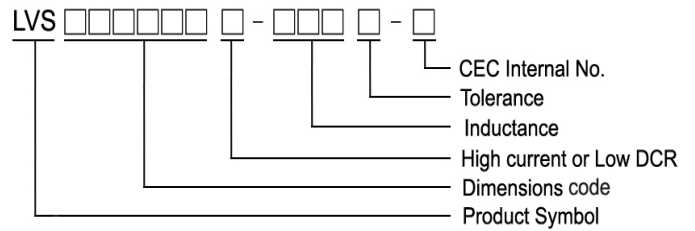
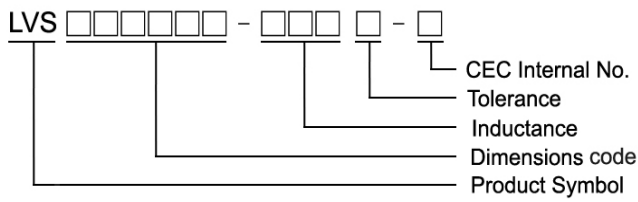

Shape and Dimensions

Figure 1

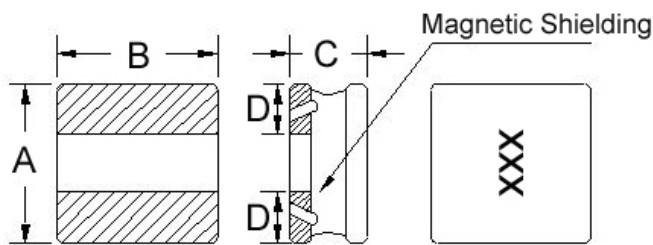

Recommended Pattern

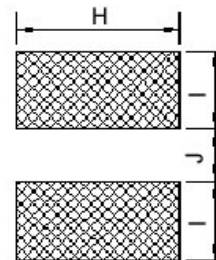

Dimensions in mm

TYPE	FIG	A	B	C	D	H	I	J
LVS404012	1	4.0±0.2	4.0±0.2	1.20±0.1	1.5	4.2	1.5	1.2

Shape and Dimensions

Recommended Pattern

Figure 2

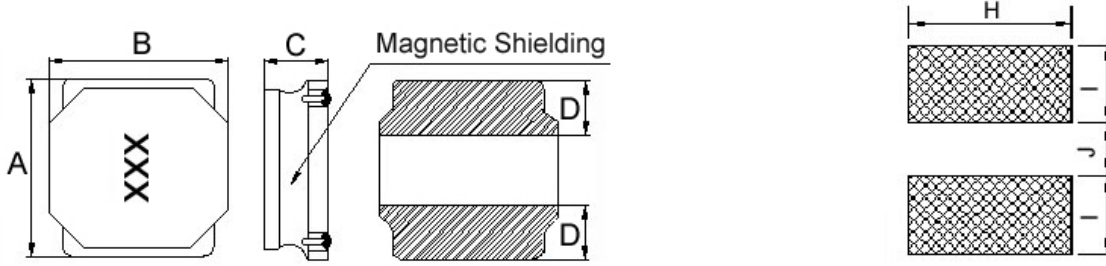

Dimensions in mm

TYPE	FIG	A	B	C	D	H	I	J
LVS404018	2	4.0±0.2	4.0±0.2	1.8 ^{+0.2} _{-0.30}	1.3±0.3	3.7	1.2	1.6
LVS404026	2	4.0±0.2	4.0±0.2	2.6±0.2	1.4	3.7	1.2	1.6

Shape and Dimensions

Recommended Pattern

Figure 3

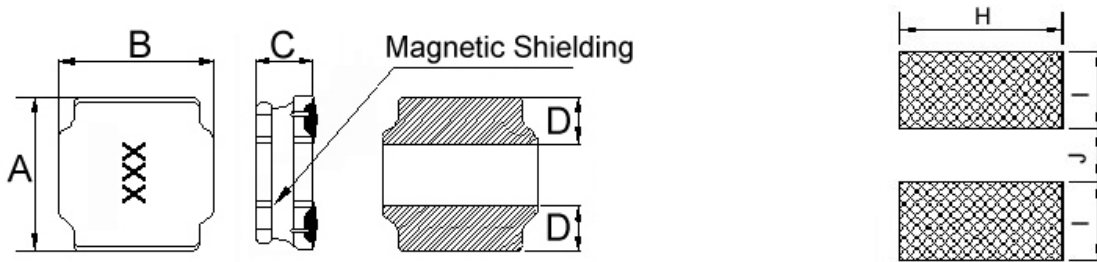

Dimensions in mm

TYPE	FIG	A	B	C	D	H	I	J
LVS505020	3	5.0±0.2	5.0±0.2	2.0 ^{+0.2} _{-0.30}	1.8±0.3	4.0	1.5	2.1
LVS505040	3	5.0±0.2	5.0±0.2	4.0 ^{+0.2} _{-0.30}	1.6±0.3	4.0	1.5	2.1
LVS606020	3	6.0±0.2	6.0±0.2	2.0 ^{+0.2} _{-0.30}	1.7±0.3	5.7	1.6	2.9
LVS606028	3	6.0±0.2	6.0±0.2	2.8 ^{+0.2} _{-0.30}	1.9±0.3	5.7	1.6	2.9
LVS606045	3	6.0±0.2	6.0±0.2	4.5 ^{+0.2} _{-0.30}	1.8±0.3	5.7	2.0	2.4
LVS606045L	3	6.0±0.2	6.0±0.2	4.5 ^{+0.2} _{-0.30}	1.8±0.3	5.7	2.0	2.4
LVS808040	3	8.0±0.2	8.0±0.2	4.0 ^{+0.2} _{-0.30}	2.3±0.3	7.5	2.5	3.4
LVS808040L	3	8.0±0.2	8.0±0.2	4.0 ^{+0.2} _{-0.30}	2.3±0.3	7.5	2.5	3.4

Electrical Characteristics

Part Number	Inductance (uH)	Tolerance (±%)	Test Frequency (kHz)	RDC (mΩ) ±30%	Isat (A) Typ. (Max)	Irms (A) Typ. (Max)	Marking
LVS404012-1R0□-N	1.0	20, 30	100	48	2.50(2.25)	1.70(1.53)	1R0
LVS404012-1R5□-N	1.5	20, 30	100	58	2.10(1.89)	1.60(1.44)	1R5
LVS404012-2R2□-N	2.2	20, 30	100	65	1.70(1.53)	1.50(1.35)	2R2
LVS404012-3R3□-N	3.3	20, 30	100	90	1.30(1.17)	1.40(1.26)	3R3
LVS404012-4R7□-N	4.7	20, 30	100	110	1.10(0.99)	1.20(1.08)	4R7
LVS404012-6R8□-N	6.8	20, 30	100	135	0.90(0.81)	1.05(0.94)	6R8
LVS404012-100□-N	10	20, 30	100	190	0.78(0.70)	0.90(0.81)	100
LVS404012-150□-N	15	20, 30	100	250	0.65(0.58)	0.85(0.76)	150
LVS404012-220□-N	22	20, 30	100	400	0.52(0.46)	0.75(0.67)	220
LVS404012-330□-N	33	20, 30	100	600	0.44(0.39)	0.70(0.63)	330
LVS404012-470□-N	47	20, 30	100	930	0.35(0.31)	0.50(0.45)	470

Note: When ordering, please specify tolerance code. Tolerance: M=±20% , T =±30%

- Operating temperature range - 55°C ~ 125°C(Including self - temperature rise)
- Isat for Inductance drop 30% from its value without current
- I rms for a 40°C temperature rise from 25°C ambient with current
- Measure Equipment :
 L : Agilent HP4284A+Agilent HP42841A, 100kHz 1V
 RDC : DIGITAL MILLINHM METER CHROMA 16502, or equivalent
 Isat & I rms : Agilent HP4284A

Test Instruments : HP4284A Material/Impedance Analyzer

Inductance vs. DC Current

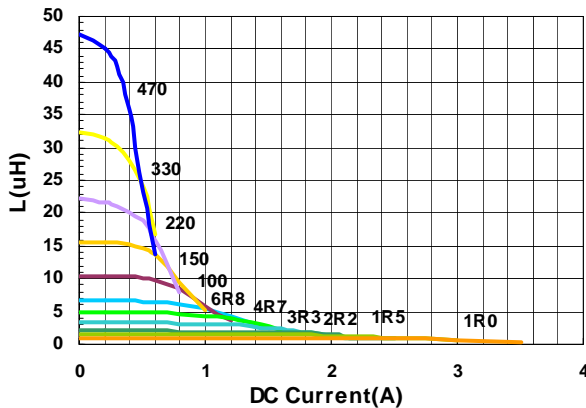

Temperature Change vs. DC Current

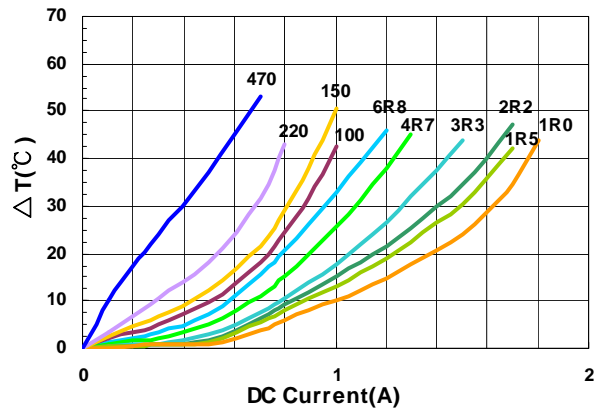

Please be sure to request approval specifications that provide further details of the products. Kindly note that the content of these specifications are subject to change or may be discontinued without advance notice. Please contact our sales department before ordering.

Electrical Characteristics

Part Number	Inductance (uH)	Tolerance (±%)	Test Frequency (kHz)	RDC (mΩ) ±20%	Isat (A) Typ. (Max)	Irms (A) Typ. (Max)	Marking
LVS404018-1R0□-N	1.0	20, 30	100	32	4.10(3.69)	2.80(2.52)	1R0
LVS404018-1R5□-N	1.5	20, 30	100	40	3.30(2.97)	2.60(2.34)	1R5
LVS404018-1R8□-N	1.8	20, 30	100	55	2.80(2.50)	2.50(2.20)	1R8
LVS404018-2R2□-N	2.2	20, 30	100	60	2.80(2.52)	2.50(2.25)	2R2
LVS404018-3R3□-N	3.3	20, 30	100	70	2.20(1.98)	2.10(1.89)	3R3
LVS404018-3R6□-N	3.6	20, 30	100	75	2.10(1.89)	1.90(1.71)	3R6
LVS404018-3R9□-N	3.9	20, 30	100	75	2.10(1.89)	1.90(1.71)	3R9
LVS404018-4R7□-N	4.7	20, 30	100	90	2.00(1.80)	1.70(1.53)	4R7
LVS404018-6R8□-N	6.8	20, 30	100	110	1.60(1.44)	1.50(1.35)	6R8
LVS404018-8R2□-N	8.2	20, 30	100	155	1.50(1.30)	1.30(1.10)	8R2
LVS404018-100□-N	10	20, 30	100	170	1.40(1.26)	1.20(1.08)	100
LVS404018-150□-N	15	20, 30	100	250	1.00(0.90)	1.00(0.90)	150
LVS404018-220□-N	22	20, 30	100	350	0.90(0.81)	0.85(0.76)	220
LVS404018-330□-N	33	20, 30	100	530	0.80(0.72)	0.70(0.63)	330
LVS404018-470□-N	47	20, 30	100	720	0.70(0.63)	0.56(0.50)	470
LVS404018-680□-N	68	20, 30	100	1000	0.56(0.50)	0.45(0.40)	680
LVS404018-101□-N	100	20, 30	100	1500	0.46(0.41)	0.38(0.34)	101
LVS404018-151□-N	150	20, 30	100	2500	0.35(0.31)	0.30(0.27)	151
LVS404018-221□-N	220	20, 30	100	4000	0.28(0.25)	0.23(0.20)	221

Note: When ordering, please specify tolerance code. Tolerance: M=±20% , T =±30%

- Operating temperature range - 55°C ~ 125°C(Including self - temperature rise)
- Isat for Inductance drop 30% from its value without current
- Iirms for a 40°C temperature rise from 25°C ambient with current
- Measure Equipment :
 L : Agilent HP4284A+Agilent HP42841A, 100kHz 1V
 RDC : DIGITAL MILLINHM METER CHROMA 16502, or equivalent
 Isat & Iirms : Agilent HP4284A

Test Instruments : HP4284A Material/Impedance Analyzer

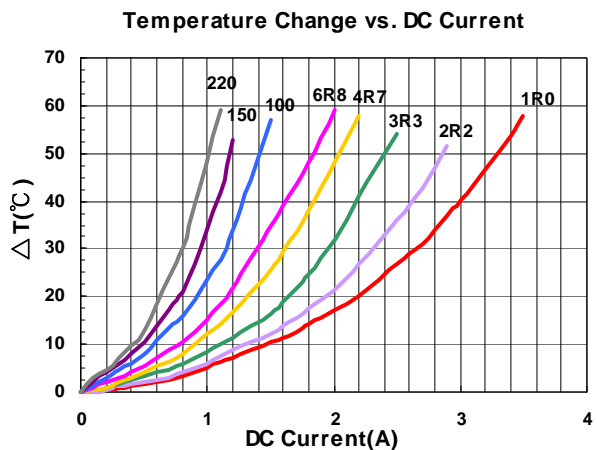
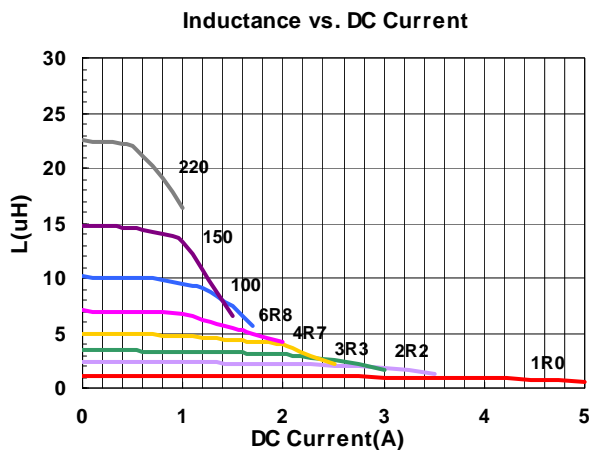

Please be sure to request approval specifications that provide further details of the products. Kindly note that the content of these specifications are subject to change or may be discontinued without advance notice. Please contact our sales department before ordering.

Electrical Characteristics

Part Number	Inductance (uH)	Tolerance (±%)	Test Frequency (kHz)	RDC (mΩ) ±30%	Isat (A) Typ. (Max)	Irms (A) Typ. (Max)	Marking
LVS404026-1R2□-N	1.2	20, 30	100	30	3.50(3.15)	3.30(2.97)	1R2
LVS404026-3R3□-N	3.3	20, 30	100	45	2.50(2.25)	2.50(2.25)	3R3
LVS404026-4R7□-N	4.7	20, 30	100	60	1.80(1.62)	1.80(1.62)	4R7
LVS404026-220□-N	22	20, 30	100	230	0.86(0.77)	1.00(0.90)	220

Note: When ordering, please specify tolerance code. Tolerance: M=±20% , T =±30%

- Operating temperature range - 55°C ~ 125°C(Including self - temperature rise)
- Isat for Inductance drop 30% from its value without current
- Irms for a 40°C temperature rise from 25°C ambient with current
- Measure Equipment :
 L : Agilent HP4284A+Agilent HP42841A, 100kHz 1V
 RDC : DIGITAL MILLINHM METER CHROMA 16502, or equivalent
 Isat & Irms : Agilent HP4284A

Test Instruments : HP4284A Material/Impedance Analyzer

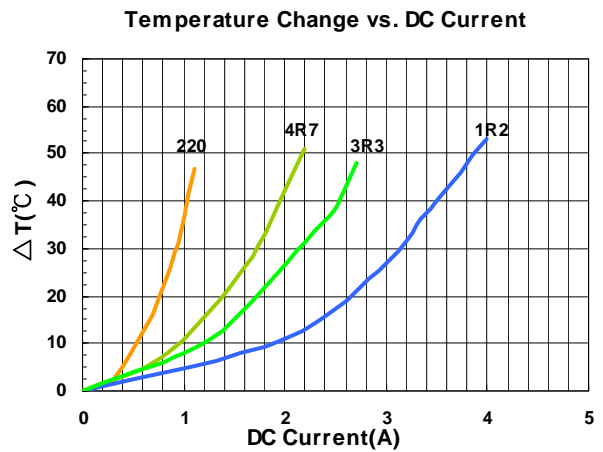
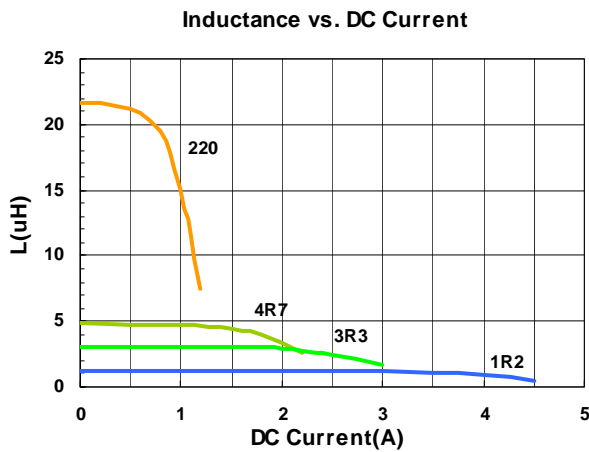

Please be sure to request approval specifications that provide further details of the products. Kindly note that the content of these specifications are subject to change or may be discontinued without advance notice. Please contact our sales department before ordering.

Electrical Characteristics

Part Number	Inductance (uH)	Tolerance (±%)	Test Frequency (kHz)	RDC (mΩ) ±20%	Isat (A) Typ. (Max)	Irms (A) Typ. (Max)	Marking
LVS505020-1R0□-N	1.0	20, 30	100	21	5.1(4.59)	4.0(3.60)	1R0
LVS505020-1R2□-N	1.2	30	100	21	4.8(4.32)	3.8(3.42)	1R2
LVS505020-1R5□-N	1.5	20, 30	100	26	4.2(3.78)	3.5(3.15)	1R5
LVS505020-2R2□-N	2.2	20, 30	100	35	3.4(3.06)	3.2(2.88)	2R2
LVS505020-2R7□-N	2.7	20, 30	100	38	3.05(2.7)	2.9(2.60)	2R7
LVS505020-3R3□-N	3.3	20, 30	100	48	3.0(2.70)	2.8(2.52)	3R3
LVS505020-4R7□-N	4.7	20, 30	100	60	2.2(1.98)	2.2(1.98)	4R7
LVS505020-5R6□-N	5.6	20, 30	100	82	2.05(1.84)	2.0(1.80)	5R6
LVS505020-6R8□-N	6.8	20, 30	100	90	2.0(1.80)	1.8(1.62)	6R8
LVS505020-100□-N	10	20, 30	100	120	1.6(1.44)	1.6(1.44)	100
LVS505020-150□-N	15	20, 30	100	190	1.3(1.17)	1.2(1.08)	150
LVS505020-220□-N	22	20, 30	100	260	1.0(0.90)	1.0(0.90)	220
LVS505020-330□-N	33	20, 30	100	460	0.8(0.72)	0.75(0.67)	330
LVS505020-470□-N	47	20, 30	100	580	0.65(0.58)	0.65(0.58)	470

Note: When ordering, please specify tolerance code. Tolerance: M=±20% , T =±30%

- Operating temperature range - 55°C ~ 125°C(Including self - temperature rise)
- Isat for Inductance drop 30% from its value without current
- Iirms for a 40°C temperature rise from 25°C ambient with current
- Measure Equipment :
 L : Agilent HP4284A+Agilent HP42841A, 100kHz 1V
 RDC : DIGITAL MILLINHM METER CHROMA 16502, or equivalent
 Isat & Iirms : Agilent HP4284A

Test Instruments : HP4284A Material/Impedance Analyzer

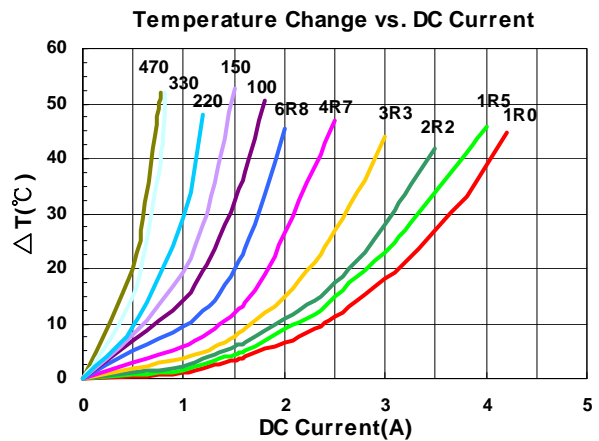
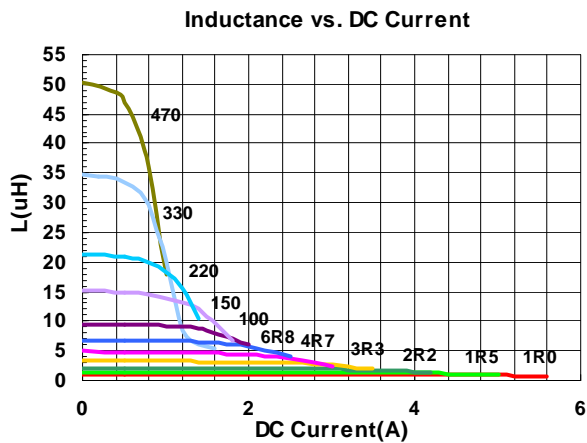

Please be sure to request approval specifications that provide further details of the products. Kindly note that the content of these specifications are subject to change or may be discontinued without advance notice. Please contact our sales department before ordering.

Electrical Characteristics

Part Number	Inductance (uH)	Tolerance (±%)	Test Frequency (kHz)	RDC (mΩ) ±30%	Isat (A) Typ. (Max)	Irms (A) Typ. (Max)	Marking
LVS505040-1R0□-N	1.0	30	100	14	7.5(6.75)	4.6(4.14)	1R0
LVS505040-1R2□-N	1.2	20, 30	100	15	7.4(6.66)	4.5(4.05)	1R2
LVS505040-1R5□-N	1.5	20, 30	100	16	7.1(6.39)	4.4(3.96)	1R5
LVS505040-2R2□-N	2.2	20, 30	100	21	5.7(5.13)	3.7(3.33)	2R2
LVS505040-3R0□-N	2.2	20, 30	100	26	4.8(4.32)	3.5(3.15)	3R0
LVS505040-3R3□-N	3.3	20, 30	100	26	4.8(4.32)	3.5(3.15)	3R3
LVS505040-3R6□-N	3.6	20, 30	100	31	4.2(3.70)	3.3(2.90)	3R6
LVS505040-4R7□-N	4.7	20, 30	100	32	4.2(3.78)	3.2(2.88)	4R7
LVS505040-6R8□-N	6.8	20, 30	100	50	3.3(2.97)	2.4(2.16)	6R8
LVS505040-100□-N	10	20, 30	100	60	2.8(2.52)	2.2(1.98)	100
LVS505040-150□-N	15	20, 30	100	90	2.3(2.07)	1.8(1.62)	150
LVS505040-220□-N	22	20, 30	100	135	1.8(1.62)	1.4(1.26)	220
LVS505040-270□-N	27	20, 30	100	180	1.6(1.44)	1.2(1.08)	270
LVS505040-330□-N	33	20, 30	100	190	1.5(1.35)	1.1(0.99)	330
LVS505040-470□-N	47	20, 30	100	310	1.2(1.08)	0.9(0.81)	470
LVS505040-680□-N	68	20, 30	100	540	1.0(0.90)	0.78(0.7)	680
LVS505040-101□-N	100	20, 30	100	800	0.7(0.60)	0.6(0.50)	101

Note: When ordering, please specify tolerance code. Tolerance: M=±20% , T =±30%

- Operating temperature range - 55°C ~ 125°C(Including self - temperature rise)
- Isat for Inductance drop 30% from its value without current
- Irms for a 40°C temperature rise from 25°C ambient with current
- Measure Equipment :
 L : Agilent HP4284A+Agilent HP42841A, 100kHz 1V
 RDC : DIGITAL MILLINHM METER CHROMA 16502, or equivalent
 Isat & Irms : Agilent HP4284A

Test Instruments : HP4284A Material/Impedance Analyzer

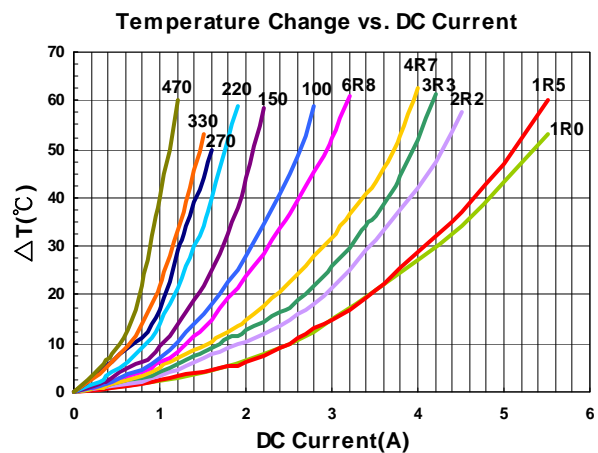
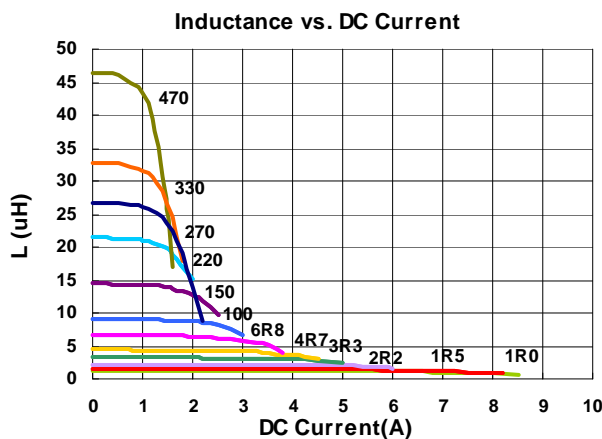

Please be sure to request approval specifications that provide further details of the products. Kindly note that the content of these specifications are subject to change or may be discontinued without advance notice. Please contact our sales department before ordering.

Electrical Characteristics

Part Number	Inductance (uH)	Tolerance (±%)	Test Frequency (kHz)	RDC (mΩ) ±30%	Isat (A) Typ. (Max)	Irms (A) Typ. (Max)	Marking
LVS606020-R50□-N	0.5	30	100	13	8.0(7.20)	5.3(4.77)	R50
LVS606020-R90□-N	0.9	30	100	18	6.3(5.67)	4.2(3.78)	R90
LVS606020-1R0□-N	1.0	30	100	19	6.2(5.58)	4.1(3.69)	1R0
LVS606020-1R5□-N	1.5	20, 30	100	26	5.0(4.50)	3.6(3.24)	1R5
LVS606020-2R2□-N	2.2	20, 30	100	34	4.2(3.78)	3.2(2.88)	2R2
LVS606020-3R3□-N	3.3	20, 30	100	40	3.2(2.88)	2.7(2.43)	3R3
LVS606020-4R7□-N	4.7	20, 30	100	58	2.5(2.25)	2.2(1.98)	4R7
LVS606020-6R8□-N	6.8	20, 30	100	85	2.2(1.98)	1.8(1.62)	6R8
LVS606020-100□-N	10	20, 30	100	125	2.0(1.80)	1.6(1.44)	100
LVS606020-150□-N	15	20, 30	100	190	1.3(1.17)	1.3(1.17)	150
LVS606020-220□-N	22	20, 30	100	260	1.1(0.99)	1.1(0.99)	220

Note: When ordering, please specify tolerance code. Tolerance: M=±20% , T =±30%

- Operating temperature range - 55°C ~ 125°C(Including self - temperature rise)
- Isat for Inductance drop 30% from its value without current
- I rms for a 40°C temperature rise from 25°C ambient with current
- Measure Equipment :
 L : Agilent HP4284A+Agilent HP42841A, 100kHz 1V
 RDC : DIGITAL MILLINHM METER CHROMA 16502, or equivalent
 Isat & I rms : Agilent HP4284A

Test Instruments : HP4284A Material/Impedance Analyzer

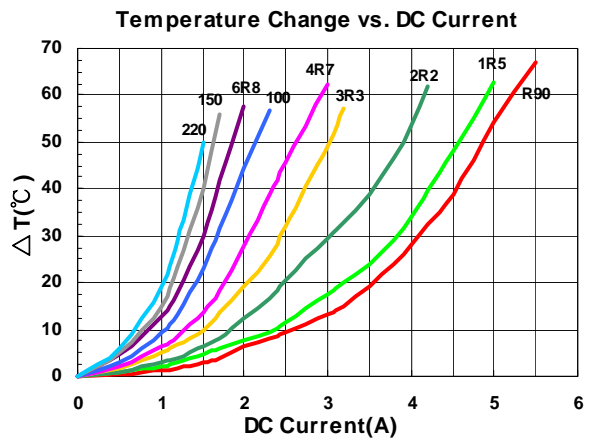
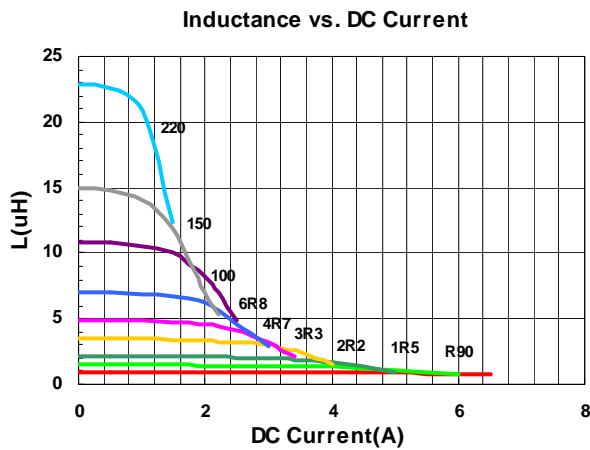

Please be sure to request approval specifications that provide further details of the products. Kindly note that the content of these specifications are subject to change or may be discontinued without advance notice. Please contact our sales department before ordering.

Electrical Characteristics

Part Number	Inductance (uH)	Tolerance (±%)	Test Frequency (kHz)	RDC (mΩ) ±30%	Isat (A) Typ. (Max)	Irms (A) Typ. (Max)	Marking
LVS606028-1R0□-N	1.0	20, 30	100	13	7.6(6.84)	5.2(4.68)	1R0
LVS606028-1R5□-N	1.5	30	100	16	6.3(5.67)	4.8(4.32)	1R5
LVS606028-2R2□-N	2.2	20, 30	100	20	5.4(4.86)	4.0(3.60)	2R2
LVS606028-2R7□-N	2.7	20, 30	100	26	4.9(4.41)	3.7(3.33)	2R7
LVS606028-3R3□-N	3.3	20, 30	100	28	4.3(3.87)	3.5(3.15)	3R3
LVS606028-4R7□-N	4.7	20, 30	100	38	3.7(3.33)	3.2(2.88)	4R7
LVS606028-6R0□-N	6.0	20, 30	100	45	3.3(2.97)	2.8(2.52)	6R0
LVS606028-6R8□-N	6.8	20, 30	100	50	3.1(2.79)	2.7(2.43)	6R8
LVS606028-100□-N	10	20, 30	100	65	2.5(2.25)	2.3(2.07)	100
LVS606028-150□-N	15	20, 30	100	95	2.0(1.80)	1.8(1.62)	150
LVS606028-220□-N	22	20, 30	100	135	1.6(1.44)	1.5(1.35)	220
LVS606028-330□-N	33	20, 30	100	220	1.3(1.17)	1.4(1.26)	330
LVS606028-470□-N	47	20, 30	100	320	1.1(0.99)	1.0(0.90)	470
LVS606028-680□-N	68	20, 30	100	420	0.98(0.88)	0.9(0.81)	680
LVS606028-101□-N	100	20, 30	100	600	0.82(0.73)	0.8(0.72)	101

Note: When ordering, please specify tolerance code. Tolerance: M=±20% , T =±30%

- Operating temperature range - 55°C ~ 125°C(Including self - temperature rise)
- Isat for Inductance drop 30% from its value without current
- Irms for a 40°C temperature rise from 25°C ambient with current
- Measure Equipment :
 L : Agilent HP4284A+Agilent HP42841A, 100kHz 1V
 RDC : DIGITAL MILLINHM METER CHROMA 16502, or equivalent
 Isat & Irms : Agilent HP4284A

Test Instruments : HP4284A Material/Impedance Analyzer

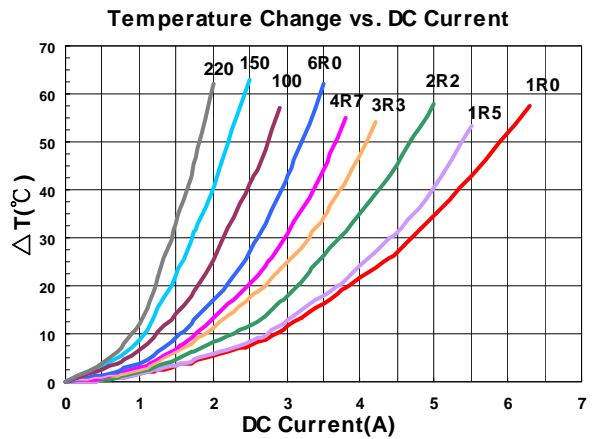
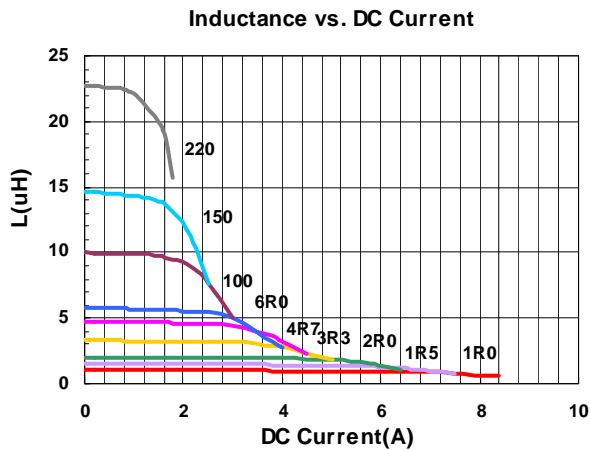

Please be sure to request approval specifications that provide further details of the products. Kindly note that the content of these specifications are subject to change or may be discontinued without advance notice. Please contact our sales department before ordering.

Electrical Characteristics

Part Number	Inductance (uH)	Tolerance (±%)	Test Frequency (kHz)	RDC (mΩ) ±30%	Isat (A) Typ. (Max)	Irms (A) Typ. (Max)	Marking
LVS606045-1R0□-N	1.0	20, 30	100	12	12.2(10.98)	6.5(5.85)	1R0
LVS606045-1R2□-N	1.2	20, 30	100	13	10.6(9.50)	5.9(5.30)	1R2
LVS606045-1R5□-N	1.5	20, 30	100	15	10.4(9.36)	5.9(5.31)	1R5
LVS606045-1R8□-N	1.8	20, 30	100	17	9.6(8.64)	5.6(5.04)	1R8
LVS606045-2R2□-N	2.2	20, 30	100	18.4	8.8(7.92)	5.1(4.59)	2R2
LVS606045-2R3□-N	2.3	20, 30	100	19	8.8(7.92)	5.0(4.50)	2R3
LVS606045-3R0□-N	3.0	20, 30	100	22	7.8(7.02)	4.4(3.96)	3R0
LVS606045-3R3□-N	3.3	20, 30	100	24	7.5(6.75)	4.3(3.87)	3R3
LVS606045-3R6□-N	3.6	20, 30	100	24	7.5(6.75)	4.3(3.87)	3R6
LVS606045-3R9□-N	3.9	20, 30	100	26	7.0(6.30)	4.0(3.60)	3R9
LVS606045-4R5□-N	4.5	20, 30	100	31	6.7(6.03)	3.9(3.51)	4R5
LVS606045-4R7□-N	4.7	20, 30	100	31	6.7(6.03)	3.9(3.51)	4R7
LVS606045-5R1□-N	5.1	20, 30	100	33	6.0(5.40)	3.5(3.15)	5R1
LVS606045-5R6□-N	5.6	20, 30	100	40	5.5(4.95)	3.3(2.97)	5R6
LVS606045-6R3□-N	6.3	20, 30	100	40	5.5(4.95)	3.3(2.97)	6R3
LVS606045-6R8□-N	6.8	20, 30	100	43	5.3(4.77)	3.2(2.88)	6R8
LVS606045-8R2□-N	8.2	20, 30	100	53	4.6(4.10)	2.9(2.60)	8R2
LVS606045-100□-N	10	20, 30	100	57	4.5(4.05)	2.7(2.43)	100
LVS606045-150□-N	15	20, 30	100	80	3.4(3.06)	2.2(1.98)	150
LVS606045-180□-N	18	20, 30	100	100	3.1(2.79)	1.8(1.62)	180
LVS606045-220□-N	22	20, 30	100	125	3.0(2.70)	1.9(1.71)	220
LVS606045-270□-N	27	20, 30	100	160	2.5(2.25)	1.3(1.17)	270
LVS606045-330□-N	33	20, 30	100	165	2.3(2.07)	1.4(1.26)	330
LVS606045-470□-N	47	20, 30	100	245	1.9(1.71)	1.2(1.08)	470
LVS606045-560□-N	56	20, 30	100	310	1.7(1.50)	1.1(0.99)	560
LVS606045-680□-N	68	20, 30	100	330	1.6(1.44)	1.0(0.90)	680
LVS606045-101□-N	100	20, 30	100	500	1.3(1.17)	0.8(0.72)	101
LVS606045-221□-N	220	20, 30	100	1300	0.82(0.73)	0.38(0.34)	221
LVS606045-331□-N	330	20, 30	100	1800	0.7(0.63)	0.35(0.31)	331
LVS606045-102□-N	1000	20, 30	100	6000	0.4(0.36)	0.22(0.19)	102

Note: When ordering, please specify tolerance code. Tolerance: M=±20% , T =±30%

- Operating temperature range - 55°C ~ 125°C(Including self - temperature rise)
- Isat for Inductance drop 30% from its value without current
- Irms for a 40°C temperature rise from 25°C ambient with current
- Measure Equipment :
 L : Agilent HP4284A+Agilent HP42841A, 100kHz 1V
 RDC : DIGITAL MILLINHM METER CHROMA 16502, or equivalent
 Isat & Irms : Agilent HP4284A

Test Instruments : HP4284A Material/Impedance Analyzer

Inductance vs. DC Current

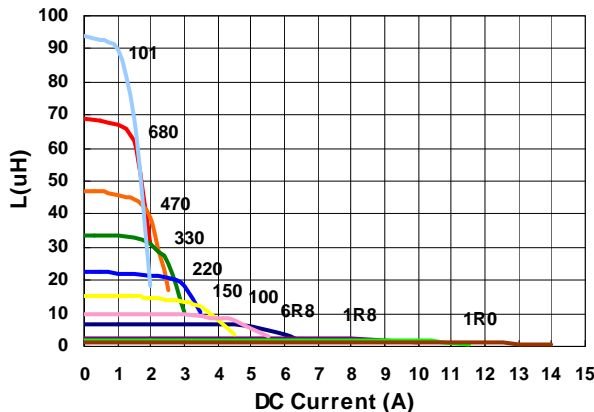

Temperature Change vs. DC Current

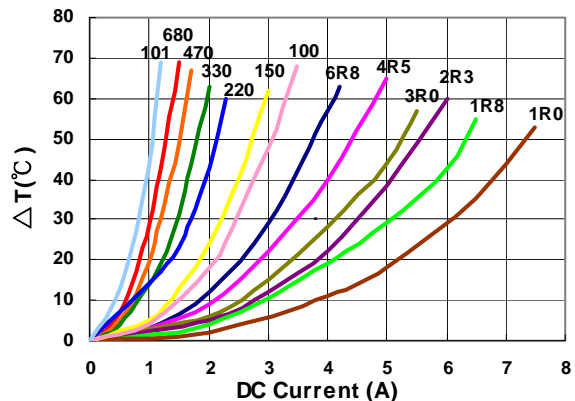

Please be sure to request approval specifications that provide further details of the products. Kindly note that the content of these specifications are subject to change or may be discontinued without advance notice. Please contact our sales department before ordering.

Electrical Characteristics

Part Number	Inductance (uH)	Tolerance (±%)	Test Frequency (kHz)	RDC (mΩ) Max	Isat (A) Typ. (Max)	Irms (A) Typ. (Max)	Marking
LVS606045L-R50□-N	0.5	30	100	9	11(9.90)	8.0(7.20)	R50
LVS606045L-2R2□-N	2.2	20, 30	100	17	6.8(6.12)	5.5(4.95)	2R2
LVS606045L-3R3□-N	3.3	20, 30	100	24	5.5(4.95)	4.7(4.23)	3R3
LVS606045L-4R7□-N	4.7	20, 30	100	30	4.6(4.14)	4.0(3.60)	4R7
LVS606045L-6R8□-N	6.8	20, 30	100	40	4.0(3.60)	3.5(3.15)	6R8
LVS606045L-100□-N	10	20, 30	100	50	3.2(2.88)	3.2(2.88)	100
LVS606045L-150□-N	15	20, 30	100	80	2.6(2.34)	2.5(2.25)	150
LVS606045L-220□-N	22	20, 30	100	120	2.1(1.89)	2.0(1.80)	220
LVS606045L-330□-N	33	20, 30	100	170	1.7(1.53)	1.6(1.44)	330
LVS606045L-101□-N	100	20, 30	100	595	0.95(0.85)	0.92(0.82)	101

Note: When ordering, please specify tolerance code. Tolerance: M=±20% , T =±30%

- Operating temperature range - 55°C ~ 125°C(Including self - temperature rise)
- Isat for Inductance drop 30% from its value without current
- Irms for a 40°C temperature rise from 25°C ambient with current
- Measure Equipment :
 - L : Agilent HP4284A+Agilent HP42841A, 100kHz 1V
 - RDC : DIGITAL MILLINHM METER CHROMA 16502, or equivalent
 - Isat & Irms : Agilent HP4284A

Test Instruments : HP4284A Material/Impedance Analyzer

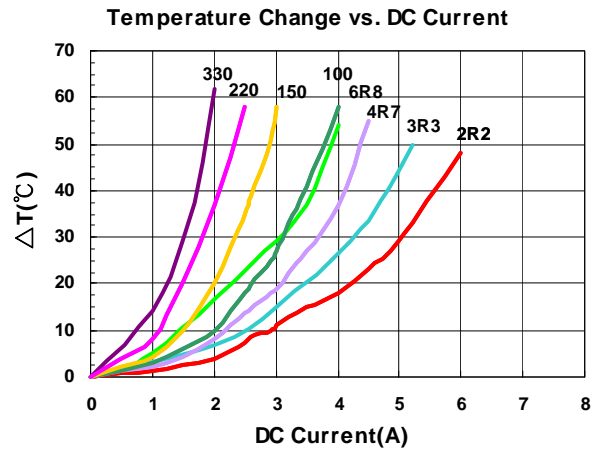
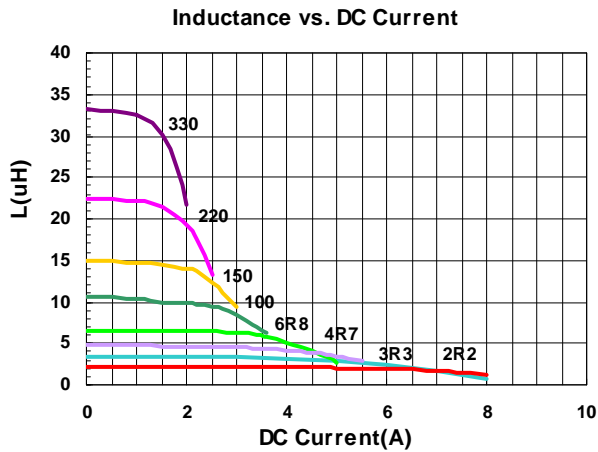

Please be sure to request approval specifications that provide further details of the products. Kindly note that the content of these specifications are subject to change or may be discontinued without advance notice. Please contact our sales department before ordering.

Electrical Characteristics

Part Number	Inductance (uH)	Tolerance (±%)	Test Frequency (kHz)	RDC (mΩ) ±30%	Isat (A) Typ. (Max)	Irms (A) Typ. (Max)	Marking
LVS808040-R90□-N	0.9	30	100	7	13.8(12.42)	8.05(7.24)	R90
LVS808040-1R0□-N	1.0	30	100	7.5	13.0(11.70)	7.95(7.15)	1R0
LVS808040-1R4□-N	1.4	30	100	9	10.8(9.72)	7.8(7.02)	1R4
LVS808040-1R5□-N	1.5	30	100	9.5	10.0(9.00)	7.7(6.93)	1R5
LVS808040-2R0□-N	2.0	20, 30	100	11	9.6(8.64)	7.4(6.66)	2R0
LVS808040-2R2□-N	2.2	20, 30	100	11.5	9.2(8.28)	7.2(6.48)	2R2
LVS808040-2R5□-N	2.5	20, 30	100	13	8.2(7.38)	6.3(5.67)	2R5
LVS808040-3R3□-N	3.3	20, 30	100	15	7.5(6.75)	6.0(5.40)	3R3
LVS808040-3R9□-N	3.9	20, 30	100	18	6.1(5.40)	5.5(4.90)	3R9
LVS808040-4R7□-N	4.7	20, 30	100	18	6.0(5.40)	5.5(4.95)	4R7
LVS808040-5R6□-N	5.6	20, 30	100	23	5.7(5.13)	5.2(4.68)	5R6
LVS808040-6R8□-N	6.8	20, 30	100	25	5.4(4.86)	5.1(4.59)	6R8
LVS808040-100□-N	10	20, 30	100	38	4.3(3.87)	3.8(3.42)	100
LVS808040-120□-N	12	20, 30	100	45	3.8(3.42)	3.5(3.15)	120
LVS808040-150□-N	15	20, 30	100	50	3.6(3.24)	3.2(2.88)	150
LVS808040-180□-N	18	20, 30	100	68	3.1(2.79)	2.7(2.43)	180
LVS808040-220□-N	22	20, 30	100	80	2.8(2.52)	2.6(2.34)	220
LVS808040-330□-N	33	20, 30	100	110	2.3(2.07)	2.0(1.80)	330
LVS808040-470□-N	47	20, 30	100	160	1.9(1.71)	1.75(1.57)	470
LVS808040-680□-N	68	20, 30	100	240	1.7(1.53)	1.45(1.30)	680
LVS808040-101□-N	100	20, 30	100	340	1.4(1.26)	1.10(0.99)	101
LVS808040-121□-N	120	20, 30	100	425	1.1(0.99)	1.0(0.90)	121
LVS808040-151□-N	150	20, 30	100	480	1.0(0.90)	0.9(0.81)	151
LVS808040-181□-N	180	20, 30	100	650	0.98(0.88)	0.7(0.63)	181
LVS808040-221□-N	220	20, 30	100	670	0.94(0.84)	0.60(0.54)	221
LVS808040-271□-N	270	20, 30	100	900	0.83(0.74)	0.55(0.49)	271
LVS808040-821□-N	820	20, 30	100	2800	0.40(0.36)	0.38(0.34)	821

Note: When ordering, please specify tolerance code. Tolerance: M=±20% , T =±30%

- Operating temperature range - 55°C ~ 125°C(Including self - temperature rise)
- Isat for Inductance drop 30% from its value without current
- Irms for a 40°C temperature rise from 25°C ambient with current
- Measure Equipment :
 L : Agilent HP4284A+Agilent HP42841A, 100kHz 1V
 RDC : DIGITAL MILLINHM METER CHROMA 16502, or equivalent
 Isat & Irms : Agilent HP4284A

Test Instruments : HP4284A Material/Impedance Analyzer

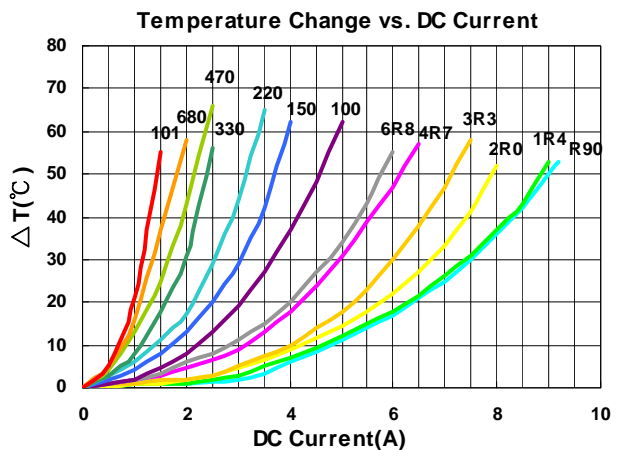
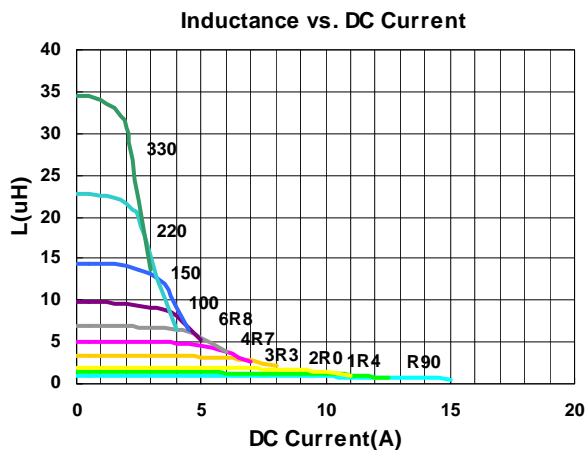

Please be sure to request approval specifications that provide further details of the products. Kindly note that the content of these specifications are subject to change or may be discontinued without advance notice. Please contact our sales department before ordering.

Electrical Characteristics

Part Number	Inductance (uH)	Tolerance (±%)	Test Frequency (kHz)	RDC (mΩ) Max	Isat (A) Typ. (Max)	Irms (A) Typ. (Max)	Marking
LVS808040L-1R0□-N	1.0	30	100	10	9.5(8.55)	8.5(7.65)	1R0
LVS808040L-2R2□-N	2.2	20,30	100	12	7.2(6.48)	7.3(6.57)	2R2
LVS808040L-3R3□-N	3.3	20,30	100	19	5.6(5.04)	6.0(5.40)	3R3
LVS808040L-4R7□-N	4.7	20,30	100	22	4.4(3.96)	5.0(4.50)	4R7
LVS808040L-8R2□-N	8.2	20,30	100	37	3.6(3.24)	3.8(3.42)	8R2
LVS808040L-100□-N	10	20,30	100	42	3.1(2.79)	3.5(3.15)	100
LVS808040L-150□-N	15	20,30	100	58	2.5(2.25)	3.0(2.70)	150
LVS808040L-220□-N	22	20,30	100	85	2.0(1.80)	2.5(2.25)	220

Note: When ordering, please specify tolerance code. Tolerance: M=±20% , T =±30%

- Operating temperature range - 55°C ~ 125°C(Including self - temperature rise)
- Isat for Inductance drop 30% from its value without current
- Irms for a 40°C temperature rise from 25°C ambient with current
- Measure Equipment :
 - L : Agilent HP4284A+Agilent HP42841A, 100kHz 1V
 - RDC : DIGITAL MILLINHM METER CHROMA 16502, or equivalent
 - Isat & Irms : Agilent HP4284A

Test Instruments : HP4284A Material/Impedance Analyzer

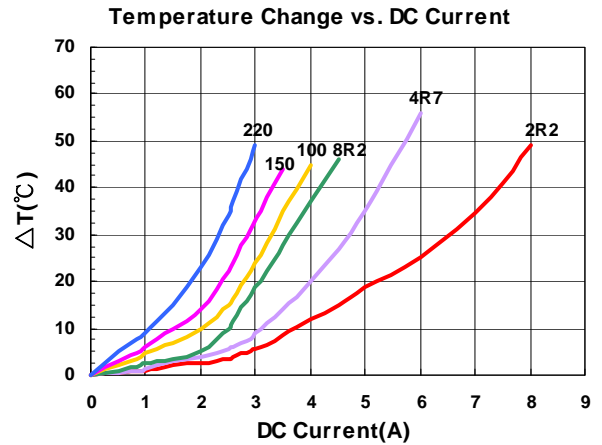
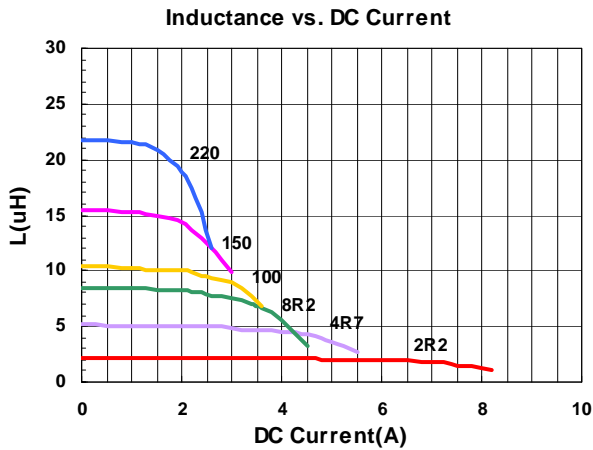

Please be sure to request approval specifications that provide further details of the products. Kindly note that the content of these specifications are subject to change or may be discontinued without advance notice. Please contact our sales department before ordering.

Packaging Specifications

Tape Dimensions

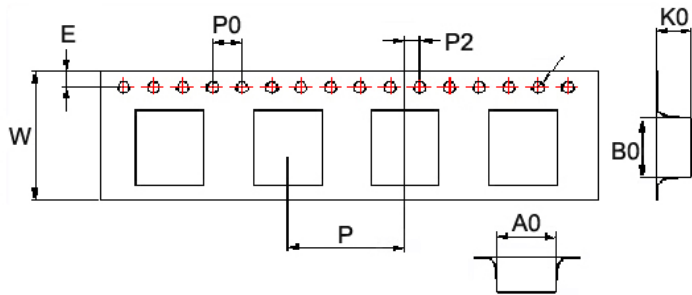

Reel Dimensions

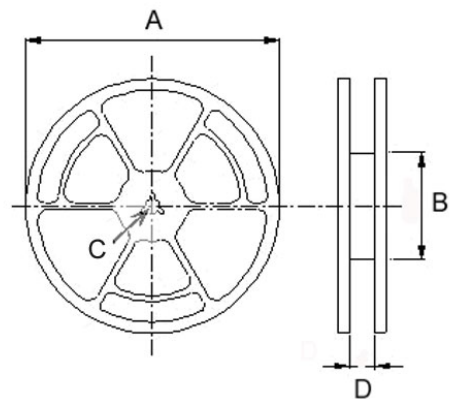

Dimensions in mm

TYPE	Tape Dimensions										Reel Dimensions				Quantity PCS / Reel
	A0	B0	K0	D	E	F	W	P	P0	P2	A	B	C	D	
LVS404012	4.25	4.25	1.30	1.55	1.75	5.5	12	8.1	4	2	180	60	13	13.2	1000
LVS404018	4.25	4.25	2.10	1.55	1.75	5.5	12	8.1	4	2	180	60	13	13.2	800
LVS404026	4.25	4.25	3.00	1.55	1.75	5.5	12	8.1	4	2	180	60	13	13.2	500
LVS505020	5.25	5.25	2.20	1.55	1.75	5.5	12	8.1	4	2	330	100	13	13.4	2000
LVS505040	5.20	5.20	4.20	1.55	1.75	5.5	12	8.1	4	2	330	100	13	13.4	1500
LVS606020	6.25	6.25	2.20	1.55	1.75	7.5	16	12	4	2	330	100	13	16.0	2000
LVS606028	6.25	6.25	3.00	1.55	1.75	7.5	16	12	4	2	330	100	13	16.0	1500
LVS606045	6.25	6.25	4.65	1.55	1.75	7.5	16	12	4	2	330	100	13	16.0	1000
LVS808040	8.25	8.25	4.15	1.55	1.75	7.5	16	12	4	2	330	100	13	16.0	1000

Shape and Dimensions

Recommended Pattern

Figure 3

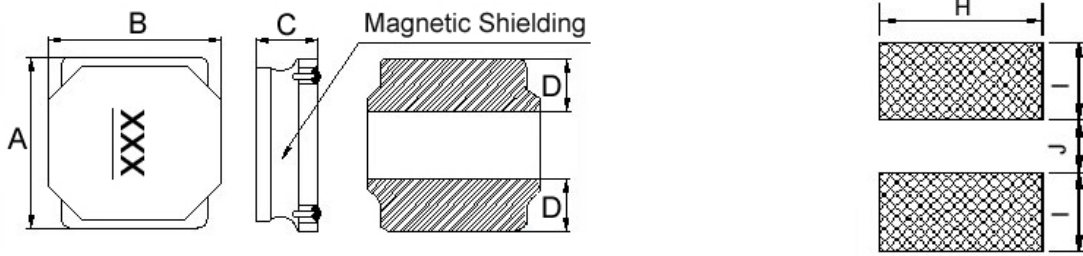

Dimensions in mm

TYPE	FIG	A	B	C	D	H	I	J
LVF404015	3	4.0±0.25	4.0±0.25	1.5±0.2	1.3	3.7	1.5	1.2
LVF404018	3	4.0±0.20	4.0±0.20	1.9 Max	1.3	3.7	1.5	1.2
LVF404026	3	4.0±0.20	4.0±0.25	2.6±0.2	1.4	3.7	1.6	1.2

Shapes and Dimensions

Recommended Pattern

Figure 4

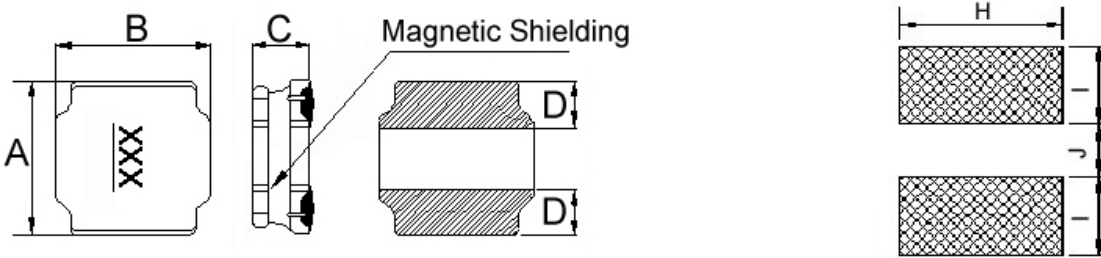

Dimensions in mm

TYPE	FIG	A	B	C	D	H	I	J
LVF505020	4	5.0±0.20	5.0±0.20	2.0±0.2	1.8±0.3	4.2	1.6	2.0
LVF606020	4	6.0±0.20	6.0±0.20	2.0±0.2	1.7±0.3	5.7	1.7	2.8
LVF606028	4	6.0±0.20	6.0±0.20	2.8±0.2	1.9±0.3	5.7	1.8	2.6
LVF808040	4	8.0±0.20	8.0±0.20	4.0 ^{+0.2} _{-0.30}	2.3±0.3	7.5	2.5	3.4

Electrical Characteristics

Part Number	Inductance (uH)	Tolerance (±%)	Test Frequency (MHz)	RDC (Ω) ±30%	Isat (A) Typ. (Max)	Irms (A) Typ. (Max)	Marking
LVF201B12-R47□-N	0.47	20, 30	1	0.051	2.70(2.43)	2.30(2.07)	A
LVF201B12-R68□-N	0.68	20, 30	1	0.074	2.20(1.98)	2.00(1.80)	L
LVF201B12-1R5□-N	1.5	20, 30	1	0.130	1.60(1.44)	1.45(1.30)	D
LVF201B12-6R8□-N	6.8	20, 30	1	0.465	0.82(0.73)	0.78(0.70)	H

Note: When ordering, please specify tolerance code. Tolerance: M=±20% , T =±30%

- Operating temperature range - 55°C ~ 125°C(Including self - temperature rise)
- Isat for Inductance drop 30% from its value without current
- I rms for a 40°C temperature rise from 25°C ambient with current
- Measure Equipment :
 L : Agilent HP4287A+Agilent HP16197A, 1MHz 200mV
 RDC : DIGITAL MILLINHM METER CHROMA 16502, or equivalent
 Isat & I rms : Agilent HP4284A

Test Instruments : HP4284A Material/Impedance Analyzer

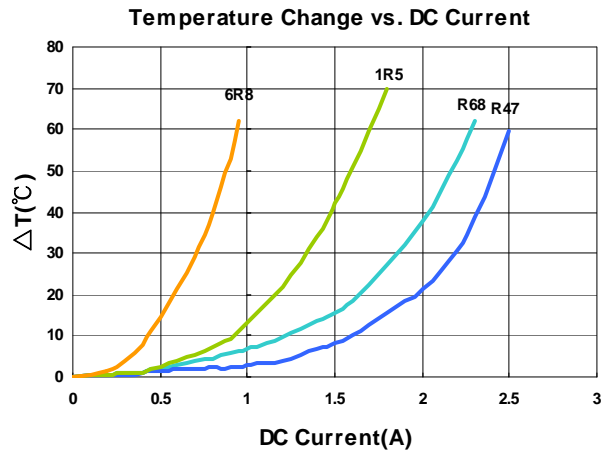
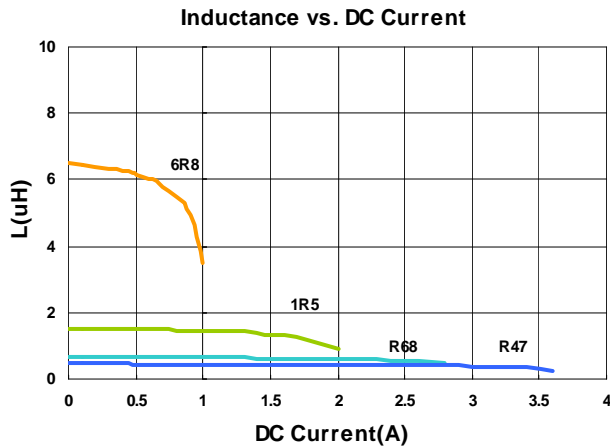

Please be sure to request approval specifications that provide further details of the products. Kindly note that the content of these specifications are subject to change or may be discontinued without advance notice. Please contact our sales department before ordering.

Electrical Characteristics

Part Number	Inductance (uH)	Tolerance (±%)	Test Frequency (MHz)	RDC (Ω) ±30%	Isat (A) Typ. (Max)	Irms (A) Typ. (Max)	Marking
LVF252A10-R47□-N	0.47	20, 30	1	0.045	2.80(2.52)	2.30(2.07)	A
LVF252A10-1R0□-N	1.0	20, 30	1	0.066	1.98(1.78)	2.05(1.84)	B
LVF252A10-1R5□-N	1.5	20, 30	1	0.095	1.70(1.53)	1.85(1.66)	C
LVF252A10-4R7□-N	4.7	20, 30	1	0.285	0.92(0.82)	0.95(0.85)	F
LVF252A10-100□-N	10	20, 30	1	0.535	0.60(0.54)	0.70(0.63)	H
LVF252A10-150□-N	15	20, 30	1	0.810	0.50(0.45)	0.55(0.49)	I
LVF252A10-220□-N	22	20, 30	1	1.200	0.40(0.36)	0.44(0.39)	J

Note: When ordering, please specify tolerance code. Tolerance: M=±20% , T =±30%

- Operating temperature range - 55°C ~ 125°C(Including self - temperature rise)
- Isat for inductance drop 30% from its value without current
- Iirms for a 40°C temperature rise from 25°C ambient with current
- Measure Equipment :
 L : Agilent HP4287A+Agilent HP16197A, 1MHz 200mV
 RDC : DIGITAL MILLINHM METER CHROMA 16502, or equivalent
 Isat & Iirms : Agilent HP4284A

Test Instruments : HP4284A Material/Impedance Analyzer

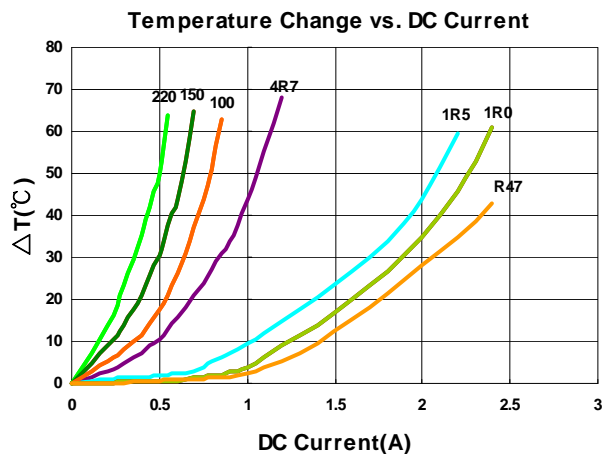
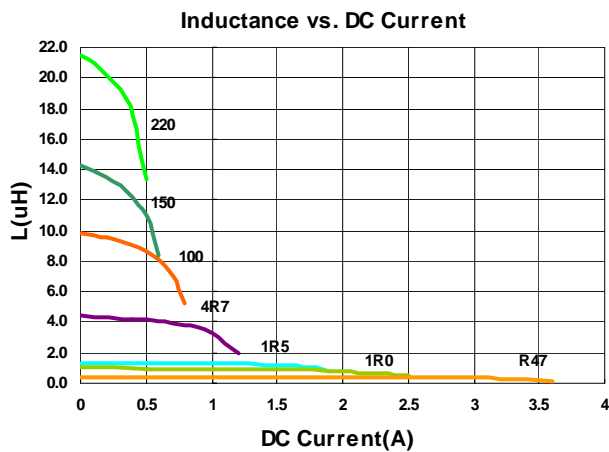

Please be sure to request approval specifications that provide further details of the products. Kindly note that the content of these specifications are subject to change or may be discontinued without advance notice. Please contact our sales department before ordering.

Electrical Characteristics

Part Number	Inductance (uH)	Tolerance (±%)	Test Frequency (MHz)	RDC (Ω) ±30%	Isat (A) Typ. (Max)	Irms (A) Typ. (Max)	Marking
LVF252A12-R50□-N	0.50	20, 30	1	0.028	3.50(3.15)	3.00(2.70)	B
LVF252A12-1R0□-N	1.0	20, 30	1	0.050	2.50(2.25)	2.40(2.16)	C
LVF252A12-1R2□-N	1.2	20, 30	1	0.053	2.10(1.89)	2.35(2.11)	D
LVF252A12-1R5□-N	1.5	20, 30	1	0.068	1.95(1.75)	2.30(2.07)	E
LVF252A12-2R2□-N	2.2	20, 30	1	0.080	1.80(1.62)	1.80(1.62)	F
LVF252A12-3R3□-N	3.3	20, 30	1	0.130	1.45(1.30)	1.50(1.35)	G
LVF252A12-4R7□-N	4.7	20, 30	1	0.190	1.10(0.99)	1.10(0.99)	H
LVF252A12-5R6□-N	5.6	20, 30	1	0.210	1.05(0.94)	1.00(0.90)	I
LVF252A12-6R8□-N	6.8	20, 30	1	0.300	0.95(0.85)	0.80(0.72)	J
LVF252A12-100□-N	10	20, 30	1	0.385	0.88(0.79)	0.70(0.63)	K
LVF252A12-150□-N	15	20, 30	1	0.570	0.68(0.61)	0.62(0.55)	L
LVF252A12-220□-N	22	20, 30	1	0.810	0.55(0.49)	0.53(0.47)	M

Note: When ordering, please specify tolerance code. Tolerance: M=±20% , T =±30%

- Operating temperature range - 55°C ~ 125°C(Including self - temperature rise)
- Isat for Inductance drop 30% from its value without current
- I rms for a 40°C temperature rise from 25°C ambient with current
- Measure Equipment :
 - L : Agilent HP4287A+Agilent HP16197A, 1MHz 200mV
 - RDC : DIGITAL MILLINHM METER CHROMA 16502, or equivalent
 - Isat & I rms : Agilent HP4284A

Test Instruments : HP4284A Material/Impedance Analyzer

Inductance vs. DC Current

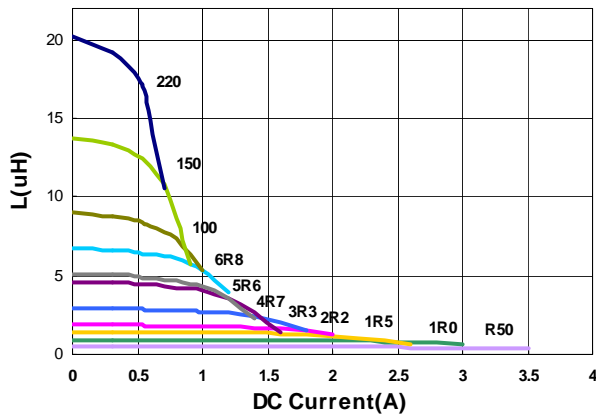

Temperature Change vs. DC Current

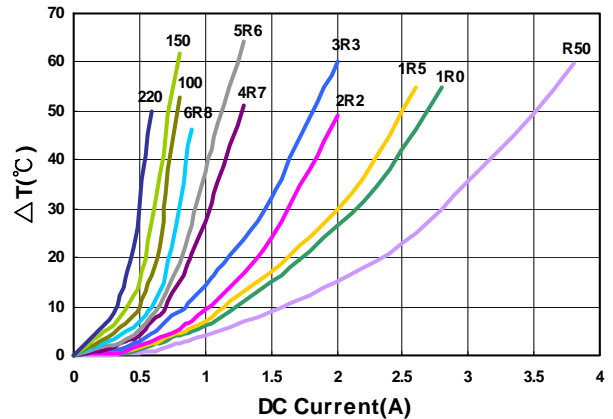

Please be sure to request approval specifications that provide further details of the products. Kindly note that the content of these specifications are subject to change or may be discontinued without advance notice. Please contact our sales department before ordering.

Electrical Characteristics

Part Number	Inductance (uH)	Tolerance (±%)	Test Frequency (MHz)	RDC (Ω) ±30%	Isat (A) Typ. (Max)	Irms (A) Typ. (Max)	Marking
LVF303010-1R5□-N	1.5	20, 30	1	0.085	1.80(1.62)	1.70(1.53)	1R5
LVF303010-2R2□-N	2.2	20, 30	1	0.100	1.50(1.35)	1.40(1.26)	2R2
LVF303010-4R7□-N	4.7	20, 30	1	0.205	1.00(0.90)	0.95(0.85)	4R7
LVF303010-6R8□-N	6.8	20, 30	1	0.310	0.87(0.78)	0.85(0.76)	6R8
LVF303010-100□-N	10	20, 30	1	0.430	0.64(0.57)	0.63(0.56)	100
LVF303010-150□-N	15	20, 30	1	0.625	0.56(0.50)	0.55(0.49)	150
LVF303010-220□-N	22	20, 30	1	0.870	0.47(0.42)	0.46(0.41)	220
LVF303010-470□-N	47	20, 30	1	1.750	0.29(0.26)	0.28(0.25)	470

Note: When ordering, please specify tolerance code. Tolerance: M=±20% , T =±30%

- Operating temperature range - 55°C ~ 125°C(Including self - temperature rise)
- Isat for Inductance drop 30% from its value without current
- I rms for a 40°C temperature rise from 25°C ambient with current
- Measure Equipment :
 L : Agilent HP4287A+Agilent HP16197A, 1MHz 200mV
 RDC : DIGITAL MILLINHM METER CHROMA 16502, or equivalent
 Isat & I rms : Agilent HP4284A

Test Instruments : HP4284A Material/Impedance Analyzer

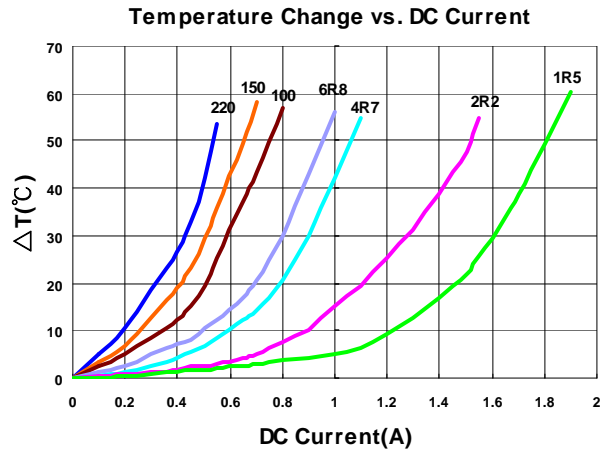
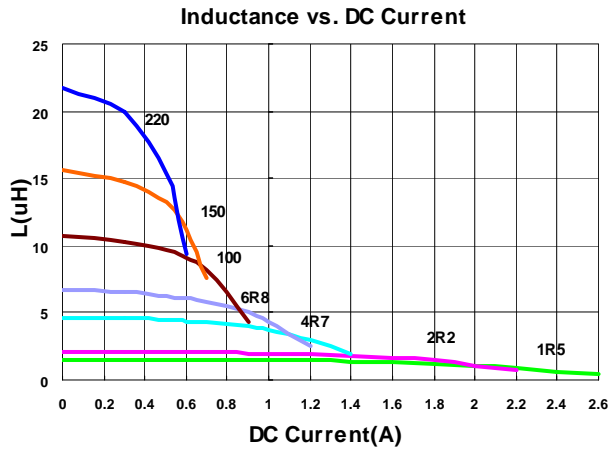

Please be sure to request approval specifications that provide further details of the products. Kindly note that the content of these specifications are subject to change or may be discontinued without advance notice. Please contact our sales department before ordering.

Electrical Characteristics

Part Number	Inductance (uH)	Tolerance (±%)	Test Frequency (MHz)	RDC (Ω) ±30%	Isat (A) Typ. (Max)	Irms (A) Typ. (Max)	Marking
LVF303012-2R2□-N	2.2	20, 30	1	0.092	2.10(1.89)	2.00(1.80)	2R2
LVF303012-3R3□-N	3.3	20, 30	1	0.13	1.84(1.65)	1.80(1.62)	3R3
LVF303012-4R7□-N	4.7	20, 30	1	0.18	1.56(1.40)	1.52(1.36)	4R7
LVF303012-6R8□-N	6.8	20, 30	1	0.25	1.32(1.18)	1.30(1.17)	6R8
LVF303012-100□-N	10	20, 30	1	0.42	1.06(0.95)	1.00(0.90)	100
LVF303012-150□-N	15	20, 30	1	0.56	0.82(0.73)	0.80(0.72)	150
LVF303012-220□-N	22	20, 30	1	0.86	0.64(0.57)	0.62(0.55)	220
LVF303012-470□-N	47	20, 30	1	1.82	0.49(0.44)	0.43(0.38)	470

Note: When ordering, please specify tolerance code. Tolerance: M=±20% , T =±30%

- Operating temperature range - 55°C ~ 125°C(Including self - temperature rise)
- Isat for Inductance drop 30% from its value without current
- Irms for a 40°C temperature rise from 25°C ambient with current
- Measure Equipment :
 L : Agilent HP4287A+Agilent HP16197A, 1MHz 200mV
 RDC : DIGITAL MILLINHM METER CHROMA 16502, or equivalent
 Isat & Irms : Agilent HP4284A

Test Instruments : HP4284A Material/Impedance Analyzer

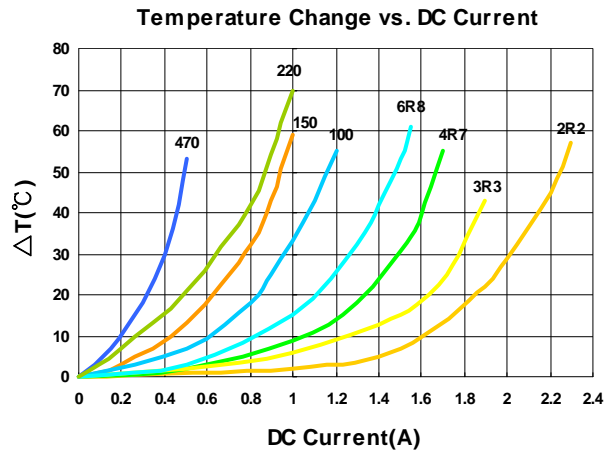
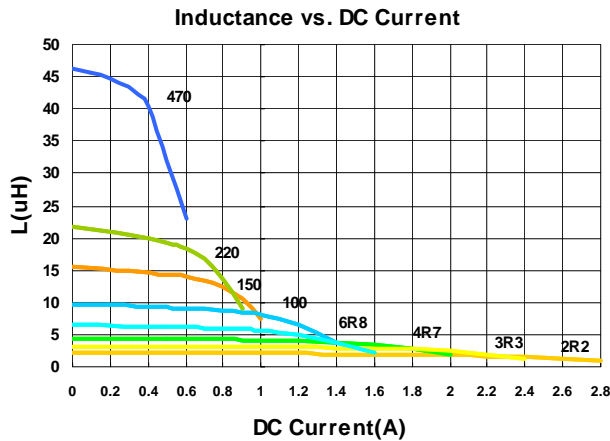

Please be sure to request approval specifications that provide further details of the products. Kindly note that the content of these specifications are subject to change or may be discontinued without advance notice. Please contact our sales department before ordering.

Electrical Characteristics

Part Number	Inductance (uH)	Tolerance (±%)	Test Frequency (MHz)	RDC (Ω) ±30%	Isat (A) Typ. (Max)	Irms (A) Typ. (Max)	Marking
LVF303015-R47□-N	0.47	20, 30	1	0.036	4.7(4.23)	4.0(3.60)	R47
LVF303015-1R0□-N	1.0	20, 30	1	0.054	3.4(3.06)	3.0(2.70)	1R0
LVF303015-1R5□-N	1.5	20, 30	1	0.063	3.0(2.70)	2.6(2.34)	1R5
LVF303015-2R2□-N	2.2	20, 30	1	0.090	2.3(2.07)	2.0(1.80)	2R2
LVF303015-3R3□-N	3.3	20, 30	1	0.125	1.9(1.71)	1.80(1.62)	3R3
LVF303015-4R7□-N	4.7	20, 30	1	0.170	1.58(1.42)	1.52(1.36)	4R7
LVF303015-6R8□-N	6.8	20, 30	1	0.235	1.34(1.20)	1.30(1.17)	6R8
LVF303015-100□-N	10	20, 30	1	0.360	1.06(0.95)	1.00(0.90)	100
LVF303015-150□-N	15	20, 30	1	0.550	0.90(0.81)	0.80(0.72)	150
LVF303015-220□-N	22	20, 30	1	0.770	0.76(0.68)	0.65(0.58)	220
LVF303015-330□-N	33	20, 30	1	0.930	0.65(0.58)	0.60(0.54)	330
LVF303015-470□-N	47	20, 30	1	1.500	0.52(0.46)	0.42(0.37)	470
LVF303015-101□-N	100	20, 30	1	2.700	0.36(0.32)	0.3(0.27)	101

Note: When ordering, please specify tolerance code. Tolerance: M=±20% , T =±30%

- Operating temperature range - 55°C ~ 125°C(Including self - temperature rise)
- Isat for Inductance drop 30% from its value without current
- Iirms for a 40°C temperature rise from 25°C ambient with current
- Measure Equipment :
 L : Agilent HP4287A+Agilent HP16197A, 1MHz 200mV
 RDC : DIGITAL MILLINHM METER CHROMA 16502, or equivalent
 Isat & Iirms : Agilent HP4284A

Test Instruments : HP4284A Material/Impedance Analyzer

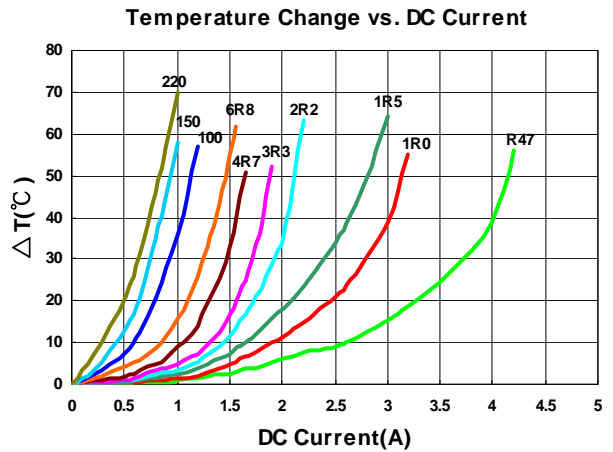
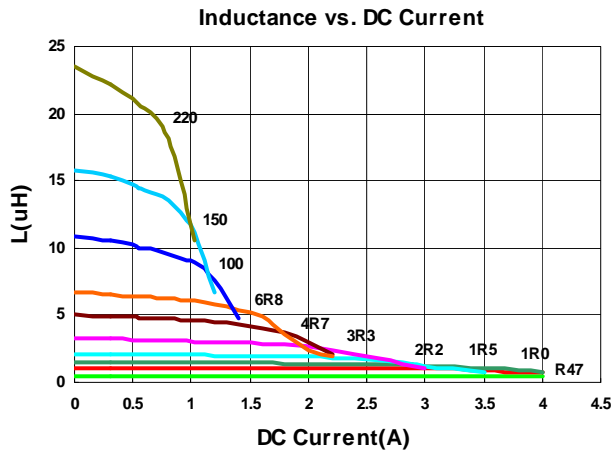

Please be sure to request approval specifications that provide further details of the products. Kindly note that the content of these specifications are subject to change or may be discontinued without advance notice. Please contact our sales department before ordering.

Electrical Characteristics

Part Number	Inductance (uH)	Tolerance (±%)	Test Frequency (MHz)	RDC (Ω) ±30%	Isat (A) Typ. (Max)	Irms (A) Typ. (Max)	Marking
LVF404012-3R3□-N	3.3	20, 30	1	0.072	1.52(1.36)	2.10(1.89)	3R3
LVF404012-100□-N	10	20, 30	1	0.190	0.90(0.81)	1.20(1.08)	100

Note: When ordering, please specify tolerance code. Tolerance: M=±20% , T =±30%

- Operating temperature range - 55°C ~ 125°C(Including self - temperature rise)
- Isat for Inductance drop 30% from its value without current
- I rms for a 40°C temperature rise from 25°C ambient with current
- Measure Equipment :
 L : Agilent HP4284A+Agilent HP42841A.1MHz 200mV
 RDC : DIGITAL MILLINHM METER CHROMA 16502, or equivalent
 Isat & I rms : Agilent HP4284A

Test Instruments : HP4284A Material/Impedance Analyzer

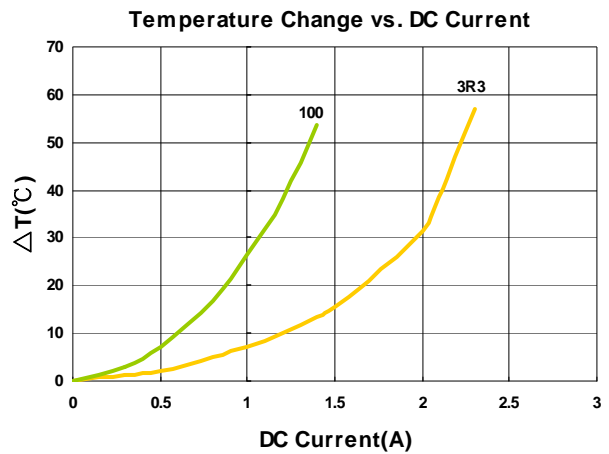
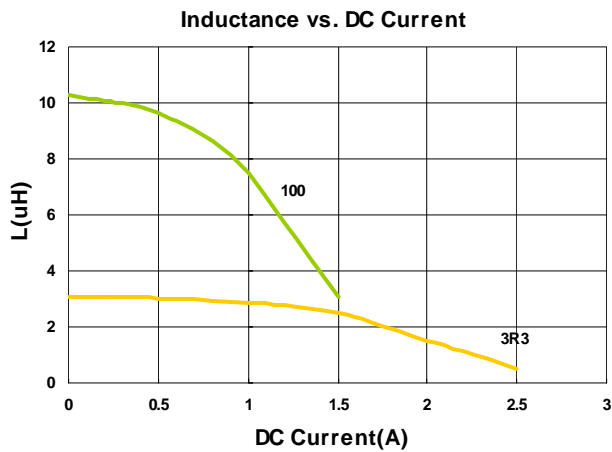

Electrical Characteristics

Part Number	Inductance (uH)	Tolerance (±%)	Test Frequency (MHz)	RDC (Ω) ±30%	Isat (A) Typ. (Max)	Irms (A) Typ. (Max)	Marking
LVF404015-R47□-N	0.47	20, 30	1	0.019	4.00(3.60)	4.20(3.78)	R47
LVF404015-1R5□-N	1.5	20, 30	1	0.041	3.00(2.70)	3.2(2.88)	1R5
LVF404015-2R2□-N	2.2	20, 30	1	0.054	2.30(2.07)	2.60(2.34)	2R2
LVF404015-4R7□-N	4.7	20, 30	1	0.100	1.60(1.44)	1.80(1.62)	4R7
LVF404015-6R8□-N	6.8	20, 30	1	0.138	1.40(1.26)	1.60(1.44)	6R8
LVF404015-100□-N	10	20, 30	1	0.200	1.00(0.90)	1.20(1.08)	100
LVF404015-150□-N	15	20, 30	1	0.300	0.92(0.82)	1.05(0.94)	150
LVF404015-220□-N	22	20, 30	1	0.400	0.72(0.64)	0.85(0.76)	220

Note: When ordering, please specify tolerance code. Tolerance: M=±20% , T =±30%

- Operating temperature range - 55°C ~ 125°C(Including self - temperature rise)
- Isat for Inductance drop 30% from its value without current
- I rms for a 40°C temperature rise from 25°C ambient with current
- Measure Equipment :
 L : Agilent HP4284A+Agilent HP42841A.1MHz 200mV
 RDC : DIGITAL MILLINHM METER CHROMA 16502, or equivalent
 Isat & I rms : Agilent HP4284A

Test Instruments : HP4284A Material/Impedance Analyzer

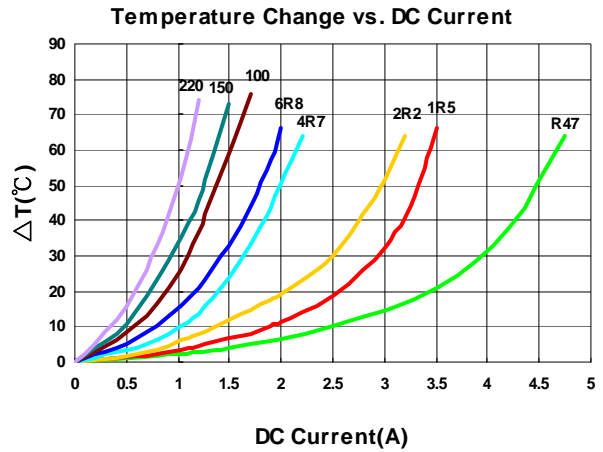
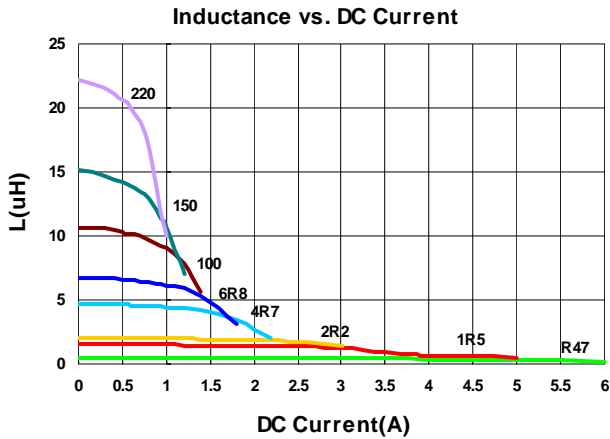

Please be sure to request approval specifications that provide further details of the products. Kindly note that the content of these specifications are subject to change or may be discontinued without advance notice. Please contact our sales department before ordering.

Electrical Characteristics

Part Number	Inductance (uH)	Tolerance (±%)	Test Frequency (kHz)	RDC (Ω) ±30%	Isat (A) Typ. (Max)	Irms (A) Typ. (Max)	Marking
LVF404018-1R0□-N	1.0	20, 30	100	0.0265	4.2(3.78)	3.8(3.42)	1R0
LVF404018-1R5□-N	1.5	20, 30	100	0.0370	3.5(3.15)	3.2(2.88)	1R5
LVF404018-2R2□-N	2.2	20, 30	100	0.0470	3.0(2.70)	2.7(2.43)	2R2
LVF404018-3R3□-N	3.3	20, 30	100	0.0625	2.3(2.07)	2.1(1.89)	3R3

Note: When ordering, please specify tolerance code. Tolerance: M=±20% , T =±30%

- Operating temperature range - 55°C ~ 125°C(Including self - temperature rise)
- Isat for Inductance drop 30% from its value without current
- I rms for a 40°C temperature rise from 25°C ambient with current
- Measure Equipment :
 L : Agilent HP4284A+Agilent HP42841A, 100kHz 1V
 RDC : DIGITAL MILLINHM METER CHROMA 16502, or equivalent
 Isat & I rms : Agilent HP4284A

Test Instruments : HP4284A Material/Impedance Analyzer

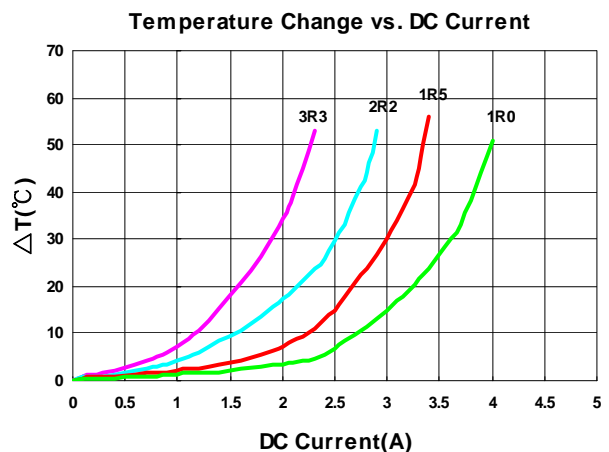
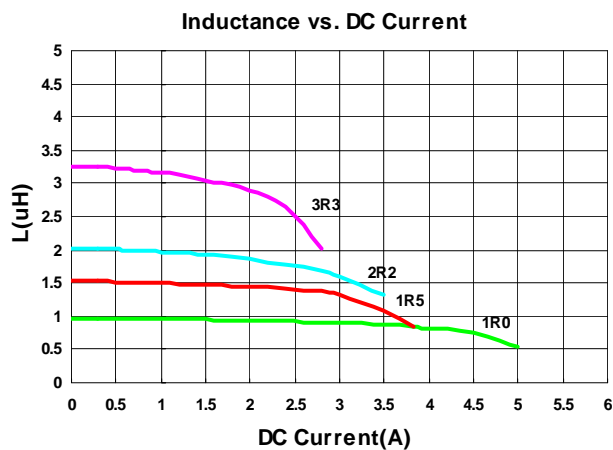

Electrical Characteristics

Part Number	Inductance (uH)	Tolerance (±%)	Test Frequency (kHz)	RDC (Ω) ±30%	Isat (A) Typ. (Max)	Irms (A) Typ. (Max)	Marking
LVF404026-1R0□-N	1.0	20, 30	100	0.030	5.00(4.50)	4.00(3.60)	1R0
LVF404026-1R5□-N	1.5	20, 30	100	0.035	4.20(3.78)	3.70(3.33)	1R5
LVF404026-2R2□-N	2.2	20, 30	100	0.045	3.80(3.42)	3.50(3.15)	2R2
LVF404026-3R3□-N	3.3	20, 30	100	0.067	3.00(2.70)	2.50(2.25)	3R3
LVF404026-4R7□-N	4.7	20, 30	100	0.092	2.60(2.34)	2.00(1.80)	4R7
LVF404026-5R6□-N	5.6	20, 30	100	0.110	2.30(2.07)	1.90(1.71)	5R6
LVF404026-6R8□-N	6.8	20, 30	100	0.130	2.00(1.80)	1.70(1.53)	6R8
LVF404026-100□-N	10	20, 30	100	0.188	1.90(1.71)	1.40(1.26)	100
LVF404026-150□-N	15	20, 30	100	0.240	1.45(1.30)	1.20(1.08)	150
LVF404026-220□-N	22	20, 30	100	0.330	1.22(1.09)	1.00(0.90)	220
LVF404026-330□-N	33	20, 30	100	0.480	1.00(0.90)	0.82(0.73)	330
LVF404026-101□-N	100	20, 30	100	1.380	0.58(0.52)	0.50(0.45)	101
LVF404026-331□-N	330	20, 30	100	4.600	0.31(0.27)	0.25(0.22)	331

Note: When ordering, please specify tolerance code. Tolerance: M=±20% , T =±30%

- Operating temperature range - 55°C ~ 125°C(Including self - temperature rise)
- Isat for Inductance drop 30% from its value without current
- I rms for a 40°C temperature rise from 25°C ambient with current
- Measure Equipment :
- L : Agilent HP4284A+Agilent HP42841A, 100kHz 1V
- RDC : DIGITAL MILLINHM METER CHROMA 16502, or equivalent
- Isat & I rms : Agilent HP4284A

Test Instruments : HP4284A Material/Impedance Analyzer

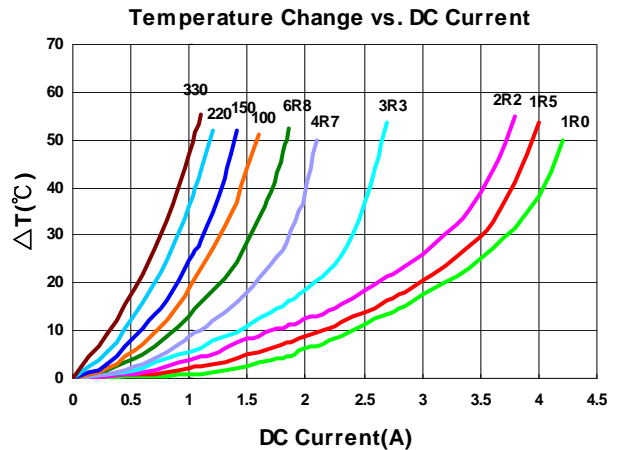
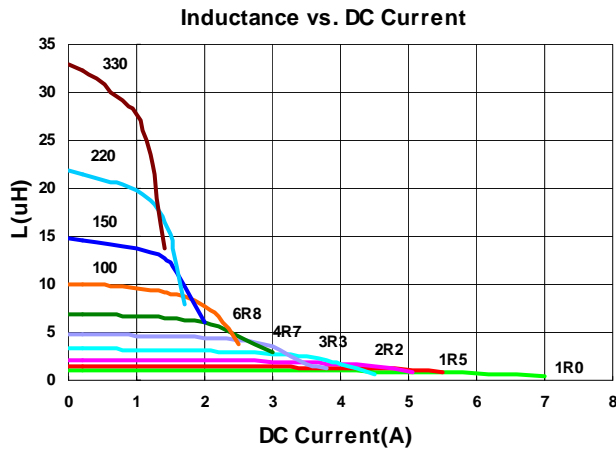

Please be sure to request approval specifications that provide further details of the products. Kindly note that the content of these specifications are subject to change or may be discontinued without advance notice. Please contact our sales department before ordering.

Electrical Characteristics

Part Number	Inductance (uH)	Tolerance (±%)	Test Frequency (kHz)	RDC (Ω) ±30%	Isat (A) Typ. (Max)	Irms (A) Typ. (Max)	Marking
LVF505020-1R0□-N	1.0	20, 30	100	0.018	6.0(5.40)	4.1(3.69)	1R0
LVF505020-1R5□-N	1.5	20, 30	100	0.023	4.9(4.41)	3.5(3.15)	1R5
LVF505020-1R8□-N	1.8	20, 30	100	0.026	4.1(3.60)	3.4(3.00)	1R8
LVF505020-2R2□-N	2.2	20, 30	100	0.030	4.0(3.60)	3.3(2.97)	2R2
LVF505020-3R6□-N	3.6	20, 30	100	0.050	3.1(2.70)	2.7(2.40)	3R6
LVF505020-3R9□-N	3.9	20, 30	100	0.053	2.9(2.61)	2.6(2.34)	3R9
LVF505020-4R7□-N	4.7	20, 30	100	0.060	2.7(2.43)	2.2(1.98)	4R7
LVF505020-6R8□-N	6.8	20, 30	100	0.093	2.2(1.98)	1.8(1.62)	6R8
LVF505020-100□-N	10	20, 30	100	0.125	1.8(1.62)	1.6(1.44)	100
LVF505020-150□-N	15	20, 30	100	0.195	1.4(1.26)	1.2(1.08)	150
LVF505020-220□-N	22	20, 30	100	0.265	1.2(1.08)	1.0(0.90)	220

Note: When ordering, please specify tolerance code. Tolerance: M=±20% , T =±30%

- Operating temperature range - 55°C ~ 125°C(Including self - temperature rise)
- Isat for Inductance drop 30% from its value without current
- Irms for a 40°C temperature rise from 25°C ambient with current
- Measure Equipment :
- L : Agilent HP4284A+Agilent HP42841A, 100kHz 1V
- RDC : DIGITAL MILLINHM METER CHROMA 16502, or equivalent
- Isat & Irms : Agilent HP4284A

Test Instruments : HP4284A Material/Impedance Analyzer

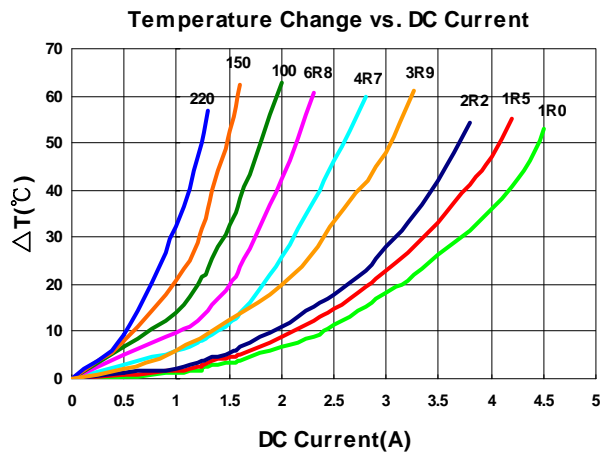
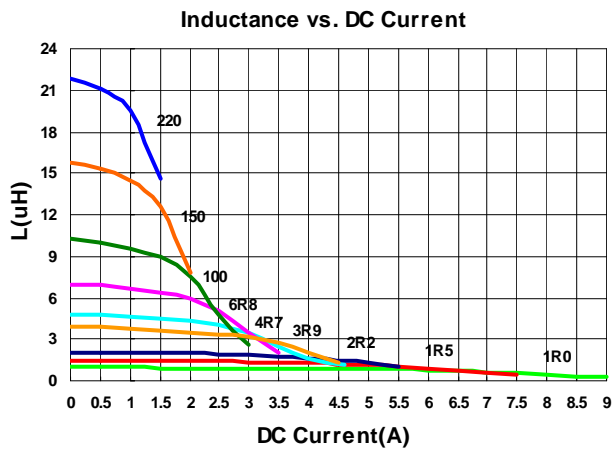

Please be sure to request approval specifications that provide further details of the products. Kindly note that the content of these specifications are subject to change or may be discontinued without advance notice. Please contact our sales department before ordering.

Electrical Characteristics

Part Number	Inductance (uH)	Tolerance (±%)	Test Frequency (kHz)	RDC (Ω) ±30%	Isat (A) Typ. (Max)	Irms (A) Typ. (Max)	Marking
LVF606020-4R7□-N	4.7	20, 30	100	0.058	3.0(2.70)	2.3(2.07)	4R7
LVF606020-100□-N	10	20, 30	100	0.130	2.1(1.89)	1.6(1.44)	100
LVF606020-150□-N	15	20, 30	100	0.195	1.6(1.44)	1.3(1.17)	150
LVF606020-220□-N	22	20, 30	100	0.260	1.3(1.17)	1.1(0.99)	220
LVF606020-470□-N	47	20, 30	100	0.510	0.9(0.80)	0.8(0.72)	470

Note: When ordering, please specify tolerance code. Tolerance: M=±20% , T =±30%

- Operating temperature range - 55°C ~ 125°C(Including self - temperature rise)
- Isat for Inductance drop 30% from its value without current
- I rms for a 40°C temperature rise from 25°C ambient with current
- Measure Equipment :
- L : Agilent HP4284A+Agilent HP42841A, 100kHz 1V
- RDC : DIGITAL MILLINHM METER CHROMA 16502, or equivalent
- Isat & I rms : Agilent HP4284A

Test Instruments : HP4284A Material/Impedance Analyzer

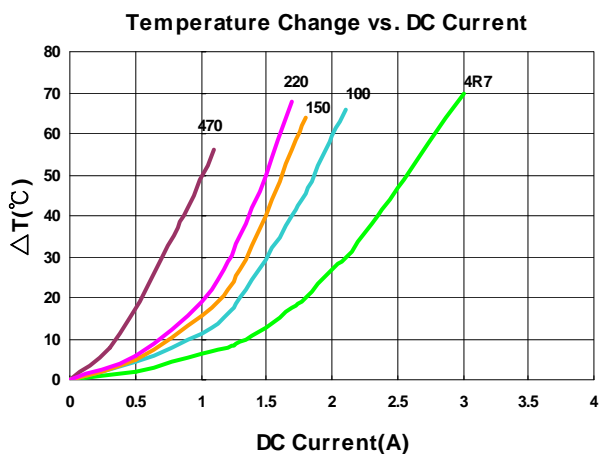
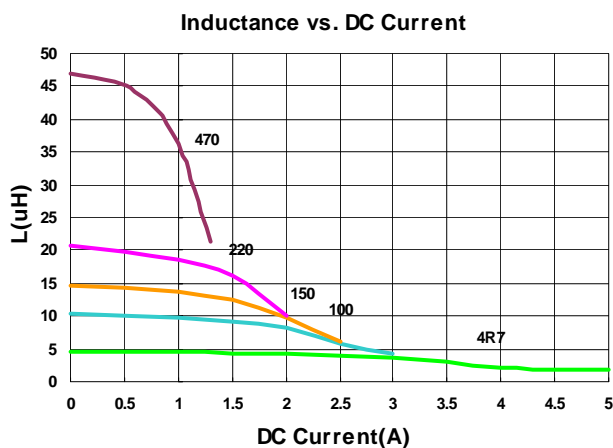

Electrical Characteristics

Part Number	Inductance (uH)	Tolerance (±%)	Test Frequency (kHz)	RDC (Ω) ±30%	Isat (A) Typ. (Max)	Irms (A) Typ. (Max)	Marking
LVF606028-1R0□-N	1.0	20, 30	100	0.012	7.9(7.11)	6.3(5.67)	1R0
LVF606028-1R5□-N	1.5	20, 30	100	0.015	7.0(6.30)	5.5(4.95)	1R5
LVF606028-2R2□-N	2.2	20, 30	100	0.020	6.0(5.40)	5.0(4.50)	2R2
LVF606028-4R7□-N	4.7	20, 30	100	0.036	4.0(3.60)	3.4(3.06)	4R7
LVF606028-6R8□-N	6.8	20, 30	100	0.048	3.2(2.88)	3.0(2.70)	6R8

Note: When ordering, please specify tolerance code. Tolerance: M=±20% , T =±30%

- Operating temperature range - 55°C ~ 125°C(Including self - temperature rise)
- Isat for Inductance drop 30% from its value without current
- I rms for a 40°C temperature rise from 25°C ambient with current
- Measure Equipment :
- L : Agilent HP4284A+Agilent HP42841A, 100kHz 1V
RDC : DIGITAL MILLINHM METER CHROMA 16502, or equivalent
Isat & I rms : Agilent HP4284A

Test Instruments : HP4284A Material/Impedance Analyzer

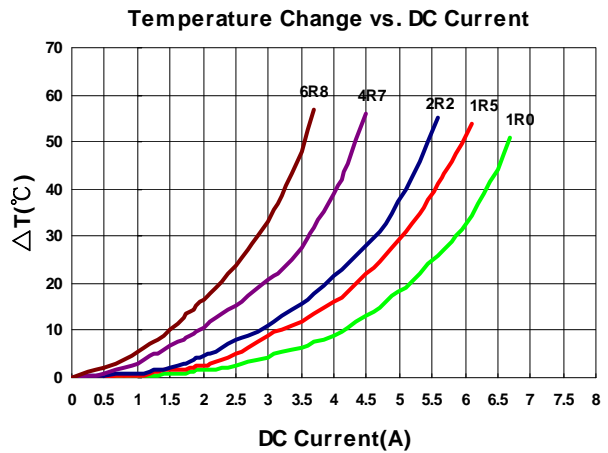
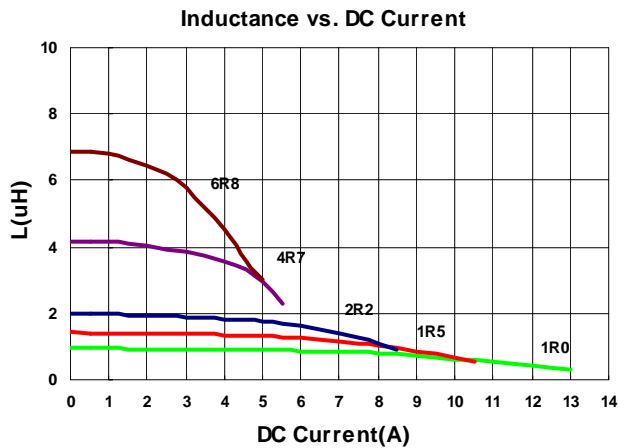

Please be sure to request approval specifications that provide further details of the products. Kindly note that the content of these specifications are subject to change or may be discontinued without advance notice. Please contact our sales department before ordering.

Electrical Characteristics

Part Number	Inductance (uH)	Tolerance (±%)	Test Frequency (kHz)	RDC (Ω) ±30%	Isat (A) Typ. (Max)	Irms (A) Typ. (Max)	Marking
LVF808040-4R7□-N	4.7	20, 30	100	0.020	6.8(6.12)	5.5(4.95)	4R7
LVF808040-100□-N	10	20, 30	100	0.038	5.0(4.50)	3.8(3.42)	100
LVF808040-150□-N	15	20, 30	100	0.057	4.0(3.60)	3.2(2.88)	150
LVF808040-220□-N	22	20, 30	100	0.082	3.4(3.06)	2.7(2.43)	220

Note: When ordering, please specify tolerance code. Tolerance: M=±20% , T =±30%

- Operating temperature range - 55°C ~ 125°C(Including self - temperature rise)
- Isat for Inductance drop 30% from its value without current
- I rms for a 40°C temperature rise from 25°C ambient with current
- Measure Equipment :
- L : Agilent HP4284A+Agilent HP42841A, 100kHz 1V
- RDC : DIGITAL MILLINHM METER CHROMA 16502, or equivalent
- Isat & I rms : Agilent HP4284A

Test Instruments : HP4284A Material/Impedance Analyzer

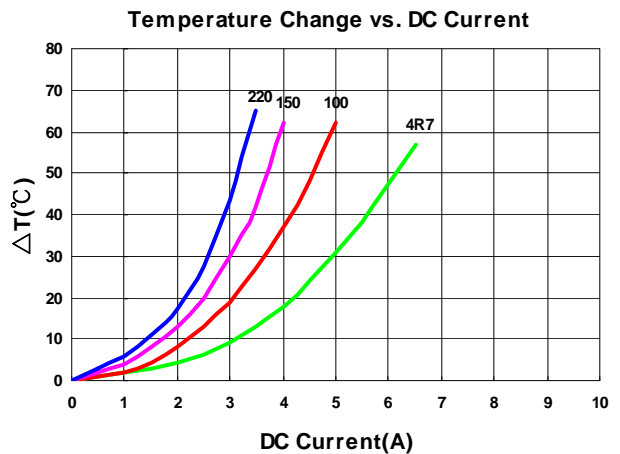
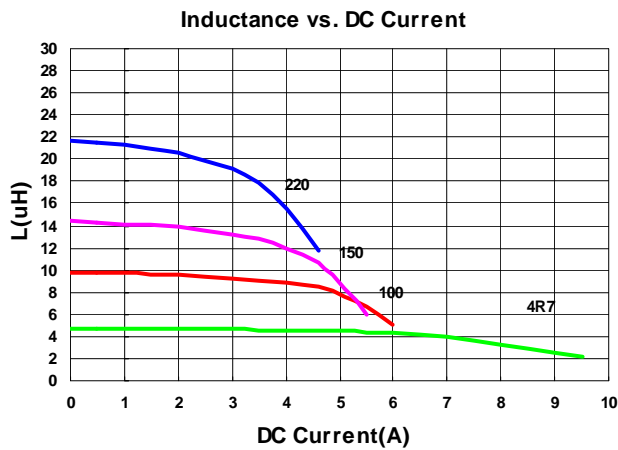

Please be sure to request approval specifications that provide further details of the products. Kindly note that the content of these specifications are subject to change or may be discontinued without advance notice. Please contact our sales department before ordering.

Packaging Specifications

Tape Dimensions

Figure 1

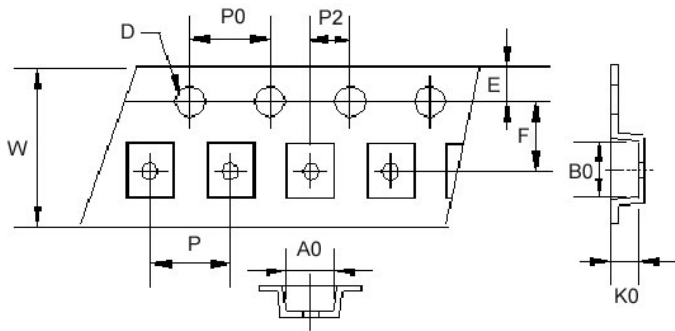

Reel Dimensions

Figure 1

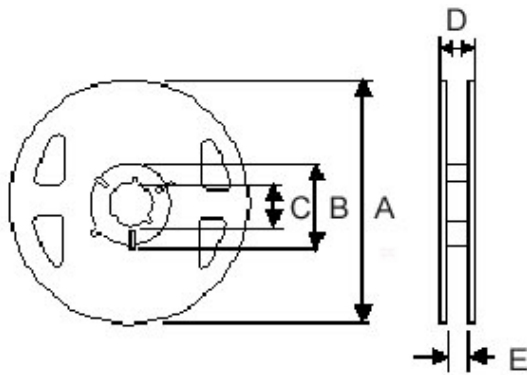

Tape Dimensions

Figure 2

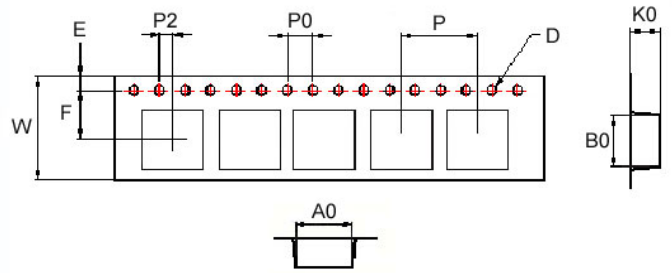

Reel Dimensions

Figure 2

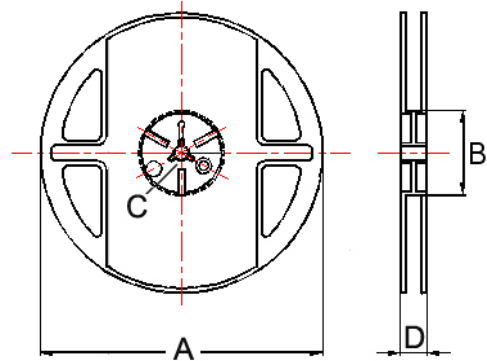

Dimensions in mm

TYPE	Fig	Tape Dimensions										Reel Dimensions					Quantity PCS / Reel
		A0	B0	K0	D	E	F	W	P	P0	P2	A	B	C	D	E	
LVF201B12	1	1.90	2.20	1.30	1.55	1.75	3.5	8.1	4	4	2	180	60	13	14.4	8.4	2000
LVF252A10	1	2.40	2.70	1.15	1.55	1.75	3.5	8.1	4	4	2	180	60	13	14.4	8.4	2000
LVF252A12	1	2.40	2.70	1.35	1.55	1.75	3.5	8.1	4	4	2	180	60	13	14.4	8.4	2000
LVF303010	1	3.20	3.20	1.40	1.55	1.75	3.5	8.1	4	4	2	180	60	13	14.4	8.4	2000
LVF303012	1	3.20	3.20	1.40	1.55	1.75	3.5	8.1	4	4	2	180	60	13	14.4	8.4	2000
LVF303015	1	3.15	3.15	1.60	1.55	1.75	3.5	8.1	4	4	2	180	60	13	14.4	8.4	2000
LVF404012	2	4.25	4.25	1.30	1.55	1.75	5.5	12	8	4	2	178	60	13	13.2	-	1000
LVF404015	2	4.25	4.25	1.70	1.55	1.75	5.5	12	8	4	2	178	60	13	13.2	-	1000
LVF404018	2	4.25	4.25	2.10	1.55	1.75	5.5	12	8	4	2	178	60	13	13.2	-	800
LVF404026	2	4.25	4.25	3.00	1.55	1.75	5.5	12	8	4	2	178	60	13	13.2	-	500
LVF505020	2	5.25	5.25	2.20	1.55	1.75	5.5	12	8	4	2	330	100	13	13.4	-	2000
LVF606020	2	6.25	6.25	2.20	1.55	1.75	7.5	16	12	4	2	330	100	13	16.0	-	2000
LVF606028	2	6.25	6.25	3.00	1.55	1.75	7.5	16	12	4	2	330	100	13	16.0	-	1500
LVF808040	2	8.25	8.25	4.15	1.55	1.75	7.5	16	12	4	2	330	100	13	16.0	-	1000

LVT Series

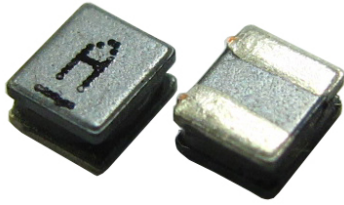

LVT series, an automatic assembly constructed power inductor, is shielded with magnetic resin and suitable for portable DC-DC converter applications.

Features

- RoHS, Halogen Free and REACH Compliance
- Shielded with magnetic resin
- Various package size and wide inductance range
- Optimize electrical characteristics by using different ferrite core figures

Applications

- Smartphones, tablets and wearable devices
- DSC, camcorders
- AP Routers
- STBs
- LCD TVs, monitors and panels
- Game consoles
- DC/DC converters

Product Identification

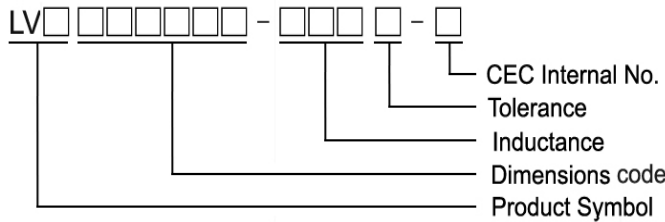

Shape and Dimensions

Figure 1

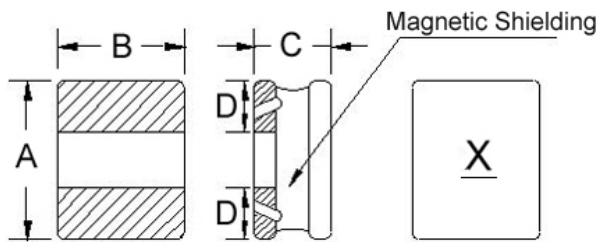
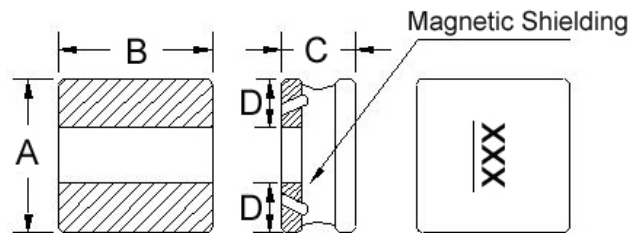

Figure 2



Recommended Pattern

Dimensions in mm

TYPE	FIG	A	B	C	D	H	I	J
LVT201B10	1	2.0±0.25	1.6±0.25	1.02 Max	0.6	1.8	0.80	0.8
LVT252A10	1	2.5±0.25	2.0±0.25	1.02 Max	0.8	2.2	0.85	0.8
LVT252A12	1	2.5±0.25	2.0±0.25	1.2±0.05	0.8	2.2	0.85	0.8
LVT303010	2	3.0±0.20	3.0±0.20	1.02 Max	1.0	3.2	1.1	1.0
LVT303012	2	3.0±0.20	3.0±0.20	1.20 Max	1.0	3.2	1.1	1.0
LVT404012	2	4.0±0.20	4.0±0.20	1.2±0.1	1.5	4.2	1.5	1.2

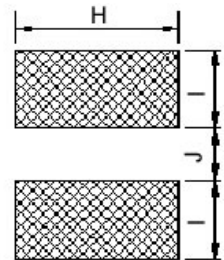

Shape and Dimensions

Figure 3

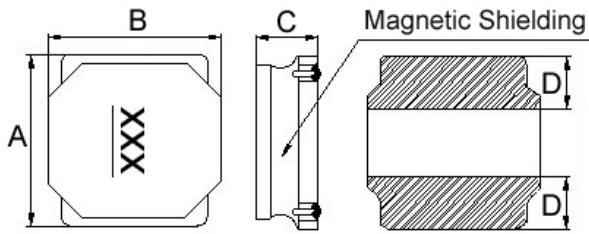

Recommended Pattern

Figure 4

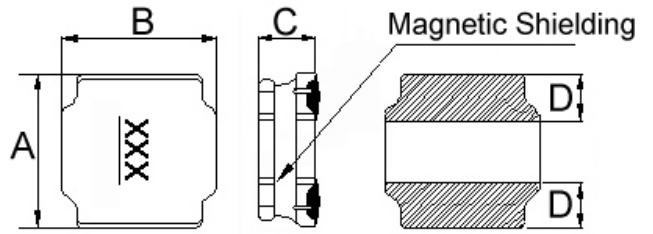

Dimensions in mm

TYPE	FIG	A	B	C	D	H	I	J
LVT404015	3	4.0±0.25	4.0±0.25	1.5±0.2	1.3	3.7	1.5	1.2
LVT404026	3	4.0±0.20	4.0±0.25	2.6±0.2	1.4	3.7	1.2	1.6
LVT505020	4	5.0±0.2	5.0±0.2	2.0±0.2	1.8±0.3	4.2	1.6	2.0
LVT606020	4	6.0±0.2	6.0±0.2	2.0±0.2	1.7±0.3	5.7	1.7	2.8
LVT808040	4	8.0±0.2	8.0±0.2	4.0 ^{+0.2} _{-0.30}	2.3±0.3	7.5	2.5	3.4

Recommended Pattern

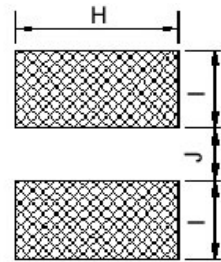

Electrical Characteristics

Part Number	Inductance (uH)	Tolerance (±%)	Test Frequency (MHz)	RDC (mΩ) ±30%	Isat (A) Typ. (Max)	Irms (A) Typ. (Max)	Marking
LVT201B10-R47□-N	0.47	20, 30	1	72	2.4(2.16)	2.4(2.16)	A

Note: When ordering, please specify tolerance code. Tolerance: M=±20% , T =±30%

- Operating temperature range - 55°C ~ 125°C(Including self - temperature rise)
- Isat for Inductance drop 30% from its value without current
- Irms for a 40°C temperature rise from 25°C ambient with current
- Measure Equipment :
- L : Agilent HP4287A+Agilent HP16197A, 1MHz 200mV
 RDC : DIGITAL MILLINHM METER CHROMA 16502, or equivalent
 Isat & Irms : Agilent HP4284A

Test Instruments : HP4284A Material/Impedance Analyzer

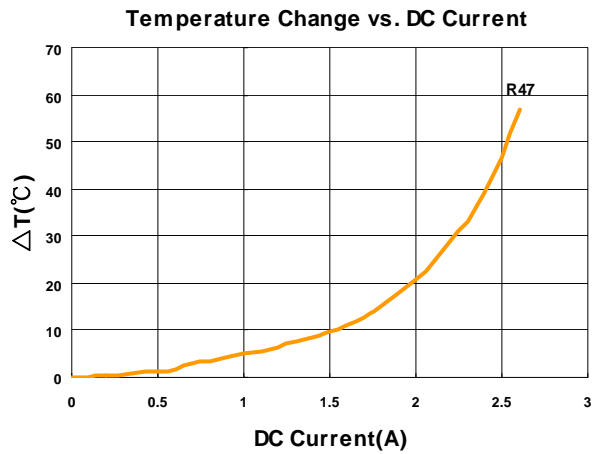
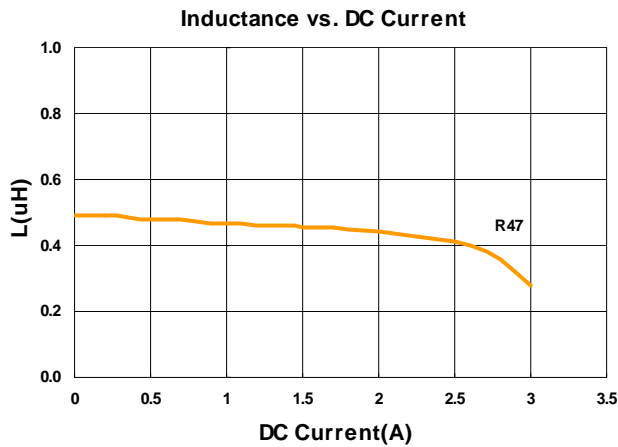

Please be sure to request approval specifications that provide further details of the products. Kindly note that the content of these specifications are subject to change or may be discontinued without advance notice. Please contact our sales department before ordering.

Electrical Characteristics

Part Number	Inductance (uH)	Tolerance (±%)	Test Frequency (MHz)	RDC (Ω) ±30%	Isat (A) Typ. (Max)	Irms (A) Typ. (Max)	Marking
LVT252A10-R68□-N	0.68	20, 30	1	0.050	2.40(2.160)	2.20(1.980)	K
LVT252A10-2R2□-N	2.2	20, 30	1	0.135	1.42(1.270)	1.55(1.390)	D
LVT252A10-3R3□-N	3.3	20, 30	1	0.220	1.12(1.000)	1.20(1.080)	E
LVT252A10-6R8□-N	6.8	20, 30	1	0.435	0.78(0.700)	0.84(0.750)	G

Note: When ordering, please specify tolerance code. Tolerance: M=±20% , T =±30%

- Operating temperature range - 55°C ~ 125°C(Including self - temperature rise)
- Isat for Inductance drop 30% from its value without current
- Iirms for a 40°C temperature rise from 25°C ambient with current
- Measure Equipment :
- L : Agilent HP4287A+Agilent HP16197A, 1MHz 200mV
- RDC : DIGITAL MILLINHM METER CHROMA 16502, or equivalent
- Isat & Iirms : Agilent HP4284A

Test Instruments : HP4284A Material/Impedance Analyzer

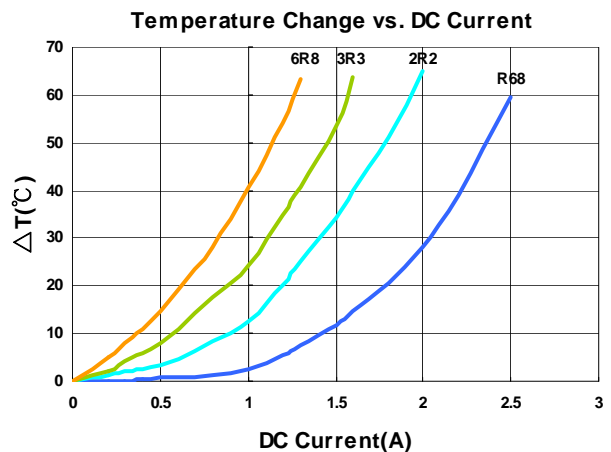
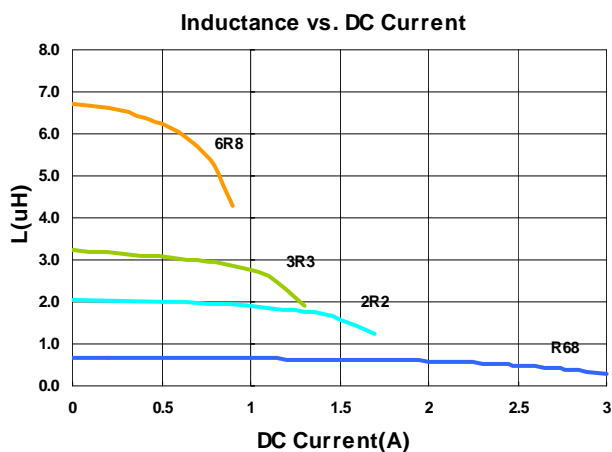

Please be sure to request approval specifications that provide further details of the products. Kindly note that the content of these specifications are subject to change or may be discontinued without advance notice. Please contact our sales department before ordering.

Electrical Characteristics

Part Number	Inductance (uH)	Tolerance (±%)	Test Frequency (MHz)	RDC (Ω) ±30%	Isat (A) Typ. (Max)	Irms (A) Typ. (Max)	Marking
LVT252A12-R47□-N	0.47	20, 30	1	0.027	3.70(3.330)	3.10(2.790)	A

Note: When ordering, please specify tolerance code. Tolerance: M=±20% , T =±30%

- Operating temperature range - 55°C ~ 125°C(Including self - temperature rise)
- Isat for Inductance drop 30% from its value without current
- Irms for a 40°C temperature rise from 25°C ambient with current
- Measure Equipment :
- L : Agilent HP4287A+Agilent HP16197A, 1MHz 200mV
 RDC : DIGITAL MILLINHM METER CHROMA 16502, or equivalent
 Isat & Irms : Agilent HP4284A

Test Instruments : HP4284A Material/Impedance Analyzer

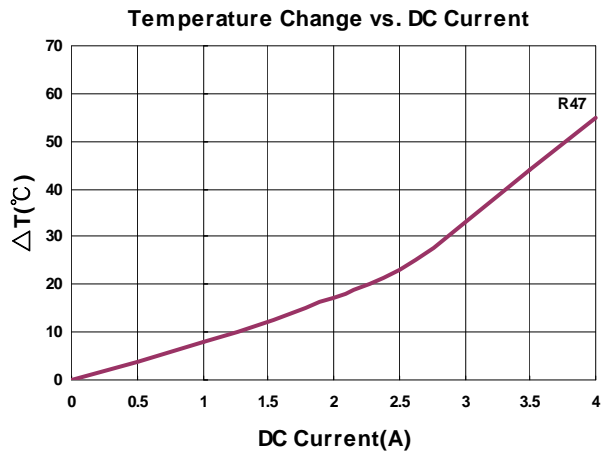
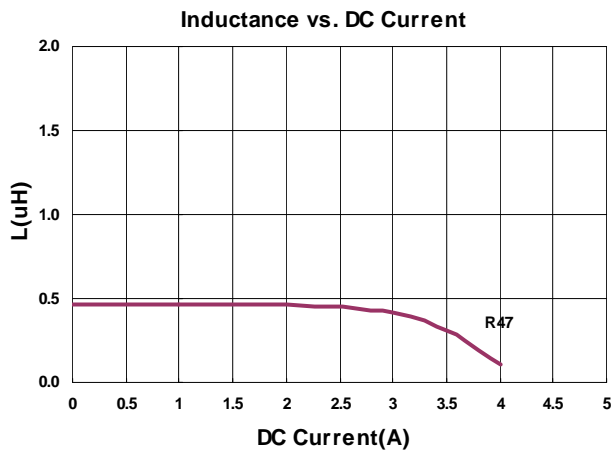

Please be sure to request approval specifications that provide further details of the products. Kindly note that the content of these specifications are subject to change or may be discontinued without advance notice. Please contact our sales department before ordering.

Electrical Characteristics

Part Number	Inductance (uH)	Tolerance (±%)	Test Frequency (MHz)	RDC (Ω) ±30%	Isat (A) Typ. (Max)	Irms (A) Typ. (Max)	Marking
LVT303010-1R0□-N	1.0	20, 30	1	0.063	2.4(2.16)	2.3(2.07)	1R0
LVT303010-3R3□-N	3.3	20, 30	1	0.165	1.2(1.08)	1.1(0.99)	3R3

Note: When ordering, please specify tolerance code. Tolerance: M=±20% , T =±30%

- Operating temperature range - 55°C ~ 125°C(Including self - temperature rise)
- Isat for Inductance drop 30% from its value without current
- I rms for a 40°C temperature rise from 25°C ambient with current
- Measure Equipment :
- L : Agilent HP4287A+Agilent/HP16197A, 1MHz 200mV
 RDC : DIGITAL MILLINHM METER CHROMA 16502, or equivalent
 Isat & I rms : Agilent HP4284A

Test Instruments : HP4284A Material/Impedance Analyzer

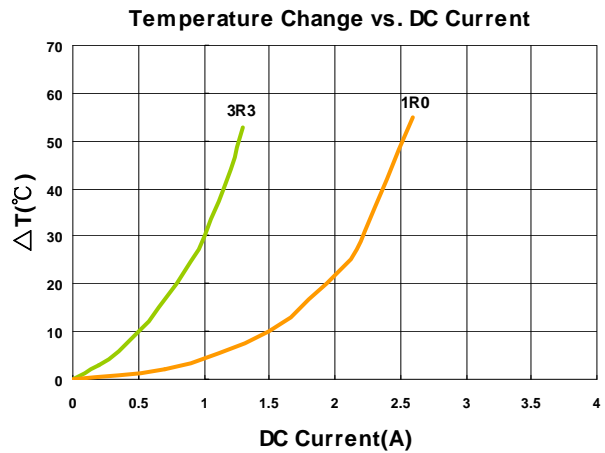
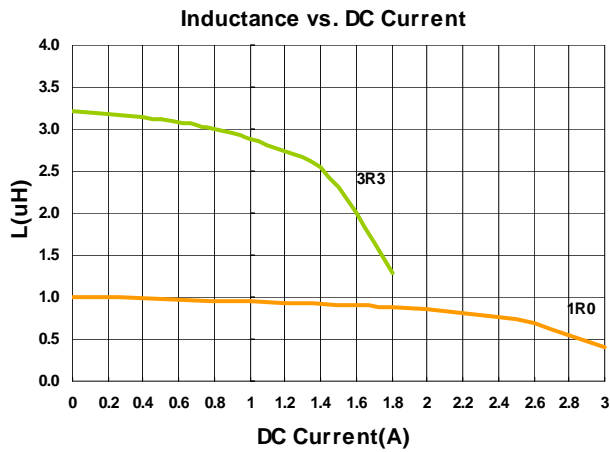

Please be sure to request approval specifications that provide further details of the products. Kindly note that the content of these specifications are subject to change or may be discontinued without advance notice. Please contact our sales department before ordering.

Electrical Characteristics

Part Number	Inductance (uH)	Tolerance (±%)	Test Frequency (MHz)	RDC (Ω) ±30%	Isat (A) Typ. (Max)	Irms (A) Typ. (Max)	Marking
LVT303012-R47□-N	0.47	20, 30	1	0.032	4.3(3.87)	4.0(3.60)	R47
LVT303012-1R0□-N	1.0	20, 30	1	0.060	3.1(2.79)	3.0(2.70)	1R0
LVT303012-1R5□-N	1.5	20, 30	1	0.072	2.7(2.43)	2.6(2.34)	1R5

Note: When ordering, please specify tolerance code. Tolerance: M=±20% , T =±30%

- Operating temperature range - 55°C ~ 125°C(Including self - temperature rise)
- Isat for Inductance drop 30% from its value without current
- I rms for a 40°C temperature rise from 25°C ambient with current
- Measure Equipment :
- L : Agilent HP4287A+Agilent HP16197A, 1MHz 200mV
- RDC : DIGITAL MILLINHM METER CHROMA 16502, or equivalent
- Isat & I rms : Agilent HP4284A

Test Instruments : HP4284A Material/Impedance Analyzer

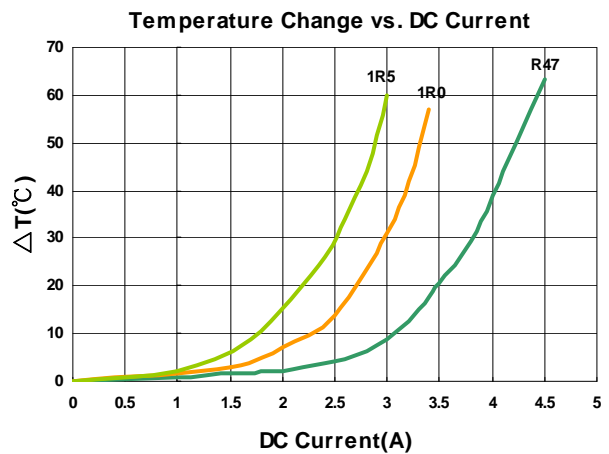
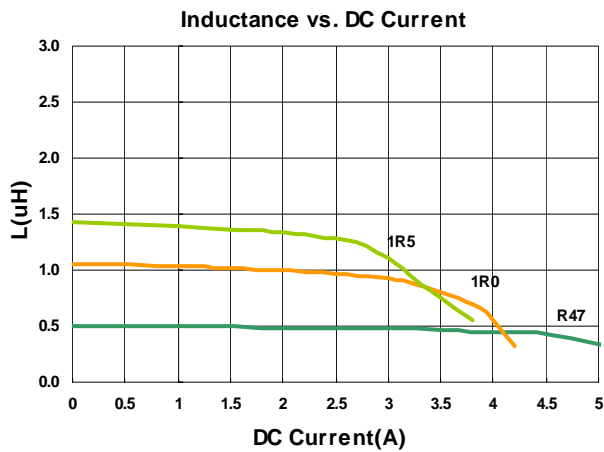

Please be sure to request approval specifications that provide further details of the products. Kindly note that the content of these specifications are subject to change or may be discontinued without advance notice. Please contact our sales department before ordering.

Electrical Characteristics

Part Number	Inductance (uH)	Tolerance (±%)	Test Frequency (MHz)	RDC (Ω) ±30%	Isat (A) Typ. (Max)	Irms (A) Typ. (Max)	Marking
LVT404012-R50□-N	0.5	20, 30	1	0.030	3.90(3.51)	3.50(3.15)	R50
LVT404012-1R0□-N	1.0	20, 30	1	0.040	2.90(2.60)	3.00(2.70)	1R0
LVT404012-1R5□-N	1.5	20, 30	1	0.051	2.30(2.07)	2.50(2.25)	1R5
LVT404012-2R2□-N	2.2	20, 30	1	0.060	1.90(1.71)	2.30(2.07)	2R2
LVT404012-4R7□-N	4.7	20, 30	1	0.094	1.32(1.18)	1.80(1.62)	4R7
LVT404012-6R8□-N	6.8	20, 30	1	0.135	1.08(0.97)	1.50(1.35)	6R8
LVT404012-150□-N	15	20, 30	1	0.260	0.78(0.70)	1.00(0.90)	150
LVT404012-220□-N	22	20, 30	1	0.390	0.62(0.55)	0.80(0.72)	220

Note: When ordering, please specify tolerance code. Tolerance: M=±20% , T =±30%

- Operating temperature range - 55°C ~ 125°C(Including self - temperature rise)
- Isat for Inductance drop 30% from its value without current
- Iirms for a 40°C temperature rise from 25°C ambient with current
- Measure Equipment :
- L : Agilent HP4284A+Agilent HP42841A, 100kHz 1V
- RDC : DIGITAL MILLINHM METER CHROMA 16502, or equivalent
- Isat & Iirms : Agilent HP4284A

Test Instruments : HP4284A Material/Impedance Analyzer

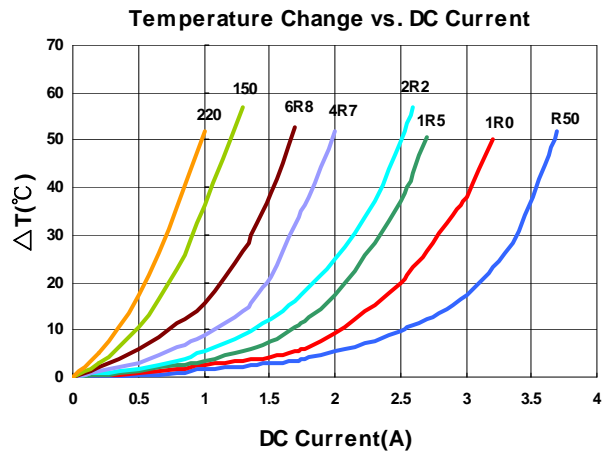
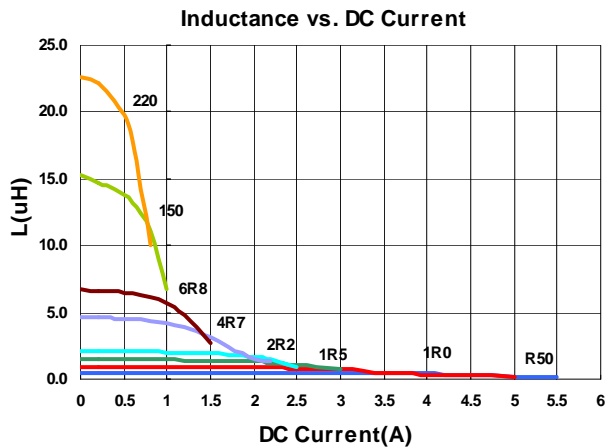

Please be sure to request approval specifications that provide further details of the products. Kindly note that the content of these specifications are subject to change or may be discontinued without advance notice. Please contact our sales department before ordering.

Electrical Characteristics

Part Number	Inductance (uH)	Tolerance (±%)	Test Frequency (MHz)	RDC (Ω) ±30%	Isat (A) Typ. (Max)	Irms (A) Typ. (Max)	Marking
LVT404015-1R0□-N	1.0	20, 30	1	0.034	3.60(3.24)	3.70(3.33)	1R0
LVT404015-3R3□-N	3.3	20, 30	1	0.080	2.00(1.80)	2.20(1.98)	3R3

Note: When ordering, please specify tolerance code. Tolerance: M=±20% , T =±30%

- Operating temperature range - 55°C ~ 125°C(Including self - temperature rise)
- Isat for Inductance drop 30% from its value without current
- I rms for a 40°C temperature rise from 25°C ambient with current
- Measure Equipment :
- L : Agilent HP4284A+Agilent HP42841A, 100kHz 1V
- RDC : DIGITAL MILLINHM METER CHROMA 16502, or equivalent
- Isat & I rms : Agilent HP4284A

Test Instruments : HP4284A Material/Impedance Analyzer

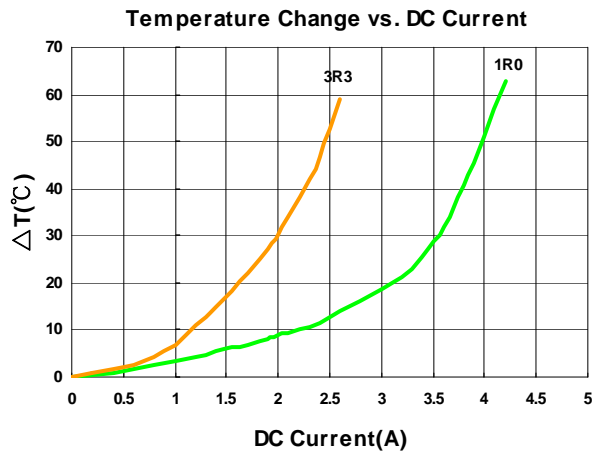
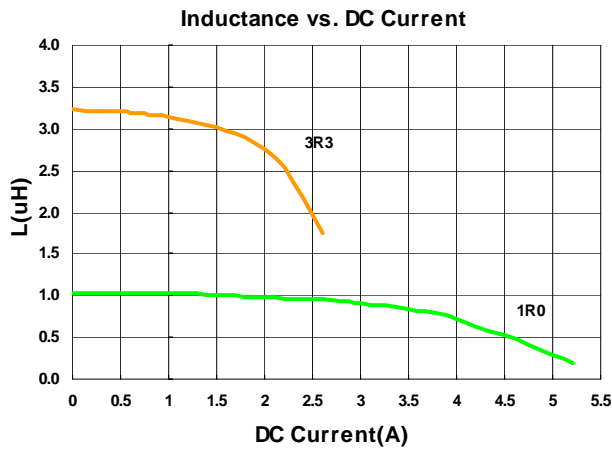

Please be sure to request approval specifications that provide further details of the products. Kindly note that the content of these specifications are subject to change or may be discontinued without advance notice. Please contact our sales department before ordering.

Electrical Characteristics

Part Number	Inductance (uH)	Tolerance (±%)	Test Frequency (kHz)	RDC (Ω) ±30%	Isat (A) Typ. (Max)	Irms (A) Typ. (Max)	Marking
LVT404026-R47□-N	0.47	20, 30	100	0.024	7.20(6.48)	4.80(4.32)	R47
LVT404026-R50□-N	0.50	20, 30	100	0.024	7.20(6.48)	4.80(4.32)	R50

Note: When ordering, please specify tolerance code. Tolerance: M=±20% , T =±30%

- Operating temperature range - 55°C ~ 125°C(Including self - temperature rise)
- Isat for Inductance drop 30% from its value without current
- Irms for a 40°C temperature rise from 25°C ambient with current
- Measure Equipment :
- L : Agilent HP4284A+Agilent HP42841A, 100kHz 1V
 RDC : DIGITAL MILLINHM METER CHROMA 16502, or equivalent
 Isat & Irms : Agilent HP4284A

Test Instruments : HP4284A Material/Impedance Analyzer

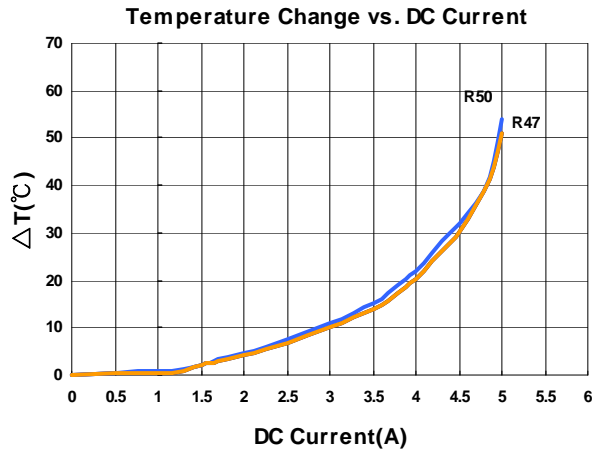
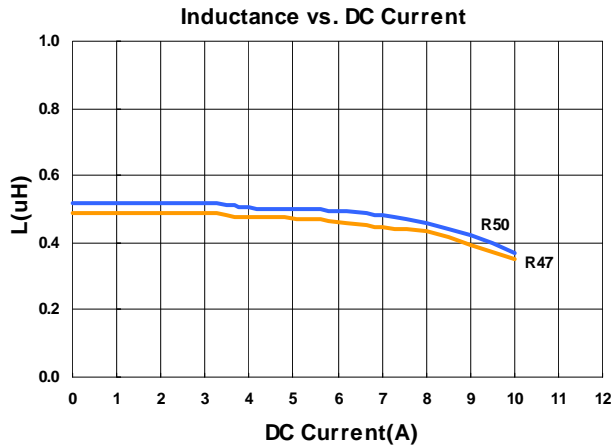

Please be sure to request approval specifications that provide further details of the products. Kindly note that the content of these specifications are subject to change or may be discontinued without advance notice. Please contact our sales department before ordering.

Electrical Characteristics

Part Number	Inductance (uH)	Tolerance (±%)	Test Frequency (kHz)	RDC (Ω) ±30%	Isat (A) Typ. (Max)	Irms (A) Typ. (Max)	Marking
LVT505020-R47□-N	0.47	20, 30	100	0.0135	8.0(7.2)	5.5(5.0)	R47
LVT505020-3R3□-N	3.3	20, 30	100	0.050	3.4(3.06)	2.7(2.43)	3R3

Note: When ordering, please specify tolerance code. Tolerance: M=±20% , T =±30%

- Operating temperature range - 55°C ~ 125°C(Including self - temperature rise)
- Isat for Inductance drop 30% from its value without current
- Irms for a 40°C temperature rise from 25°C ambient with current
- Measure Equipment :
- L : Agilent HP4284A+Agilent HP42841A, 100kHz 1V
 RDC : DIGITAL MILLINHM METER CHROMA 16502, or equivalent
 Isat & Irms : Agilent HP4284A

Test Instruments : HP4284A Material/Impedance Analyzer

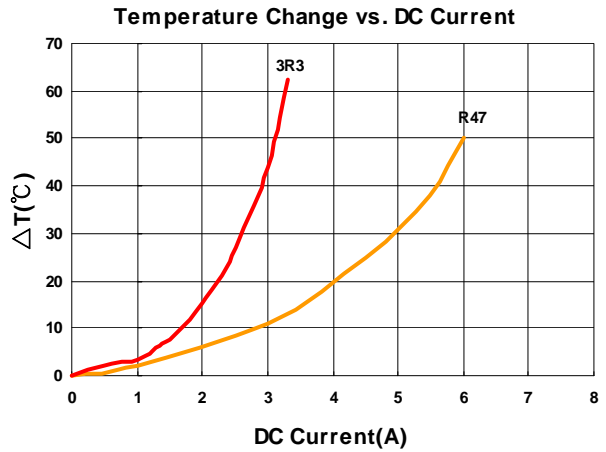
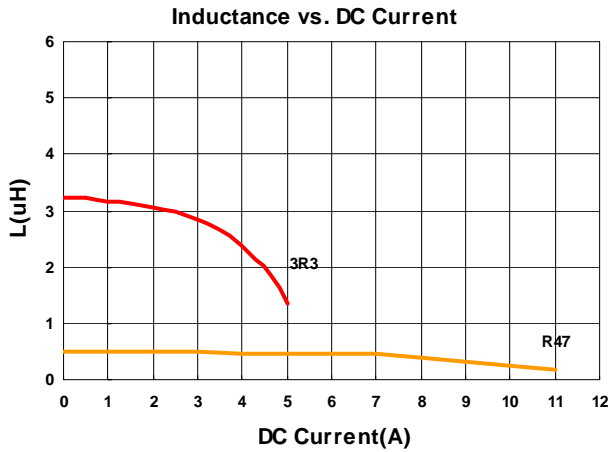

Please be sure to request approval specifications that provide further details of the products. Kindly note that the content of these specifications are subject to change or may be discontinued without advance notice. Please contact our sales department before ordering.

Electrical Characteristics

Part Number	Inductance (uH)	Tolerance (±%)	Test Frequency (kHz)	RDC (Ω) ±30%	Isat (A) Typ. (Max)	Irms (A) Typ. (Max)	Marking
LVT606020-1R0□-N	1.0	20, 30	100	0.019	6.4(5.76)	4.2(3.78)	1R0
LVT606020-1R5□-N	1.5	20, 30	100	0.026	5.4(4.86)	3.7(3.33)	1R5
LVT606020-2R2□-N	2.2	20, 30	100	0.034	4.5(4.05)	3.3(2.97)	2R2
LVT606020-3R3□-N	3.3	20, 30	100	0.045	3.6(3.24)	2.8(2.52)	3R3
LVT606020-6R8□-N	6.8	20, 30	100	0.085	2.6(2.34)	1.9(1.71)	6R8

Note: When ordering, please specify tolerance code. Tolerance: M=±20% , T =±30%

- Operating temperature range - 55°C ~ 125°C(Including self - temperature rise)
- Isat for Inductance drop 30% from its value without current
- Irms for a 40°C temperature rise from 25°C ambient with current
- Measure Equipment :
- L : Agilent HP4284A+Agilent HP42841A, 100kHz 1V
- RDC : DIGITAL MILLINHM METER CHROMA 16502, or equivalent
- Isat & Irms : Agilent HP4284A

Test Instruments : HP4284A Material/Impedance Analyzer

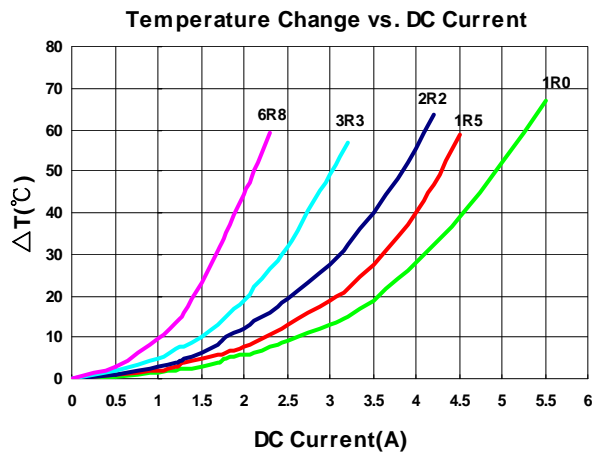
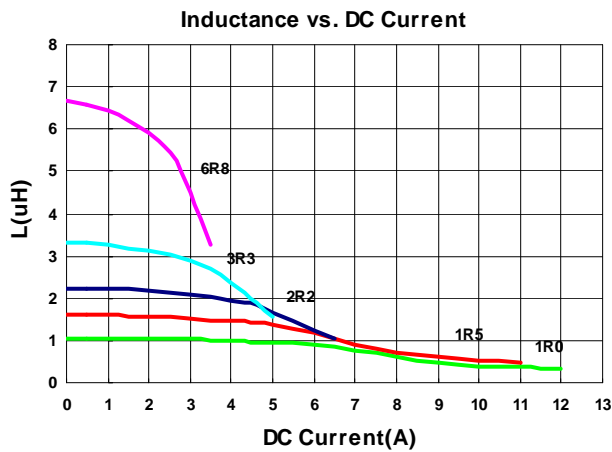

Please be sure to request approval specifications that provide further details of the products. Kindly note that the content of these specifications are subject to change or may be discontinued without advance notice. Please contact our sales department before ordering.

Electrical Characteristics

Part Number	Inductance (uH)	Tolerance (±%)	Test Frequency (kHz)	RDC (Ω) ±30%	Isat (A) Typ. (Max)	Irms (A) Typ. (Max)	Marking
LVT808040-1R0□-N	1.0	20, 30	100	0.0075	13.5(12.15)	8.1(7.29)	1R0
LVT808040-1R5□-N	1.5	20, 30	100	0.0097	10.5(9.45)	7.7(6.93)	1R5
LVT808040-2R2□-N	2.2	20, 30	100	0.012	9.7(8.73)	7.2(6.48)	2R2
LVT808040-3R3□-N	3.3	20, 30	100	0.047	8.0(7.20)	5.9(5.31)	3R3
LVT808040-6R8□-N	6.8	20, 30	100	0.029	5.8(5.22)	4.9(4.41)	6R8

Note: When ordering, please specify tolerance code. Tolerance: M=±20% , T =±30%

- Operating temperature range - 55°C ~ 125°C(Including self - temperature rise)
- Isat for Inductance drop 30% from its value without current
- Irms for a 40°C temperature rise from 25°C ambient with current
- Measure Equipment :
- L : Agilent HP4284A+Agilent HP42841A, 100kHz 1V
- RDC : DIGITAL MILLINHM METER CHROMA 16502, or equivalent
- Isat & Irms : Agilent HP4284A

Test Instruments : HP4284A Material/Impedance Analyzer

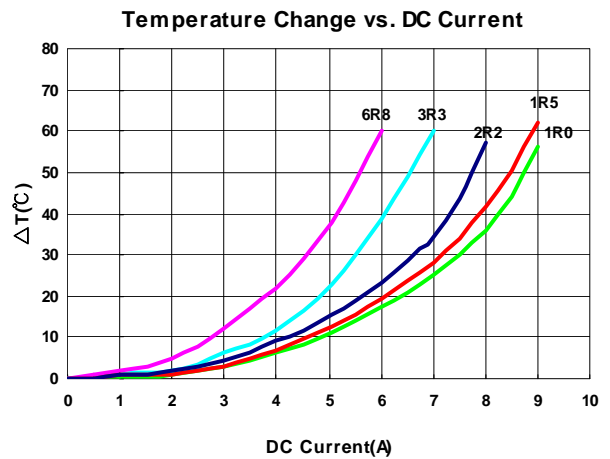
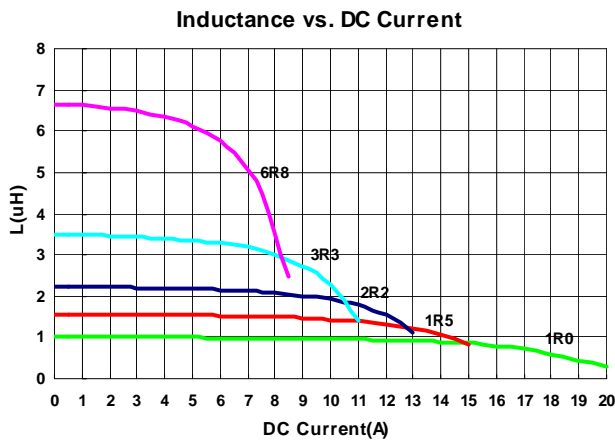

Please be sure to request approval specifications that provide further details of the products. Kindly note that the content of these specifications are subject to change or may be discontinued without advance notice. Please contact our sales department before ordering.

Packaging Specifications

Tape Dimensions

Figure 1

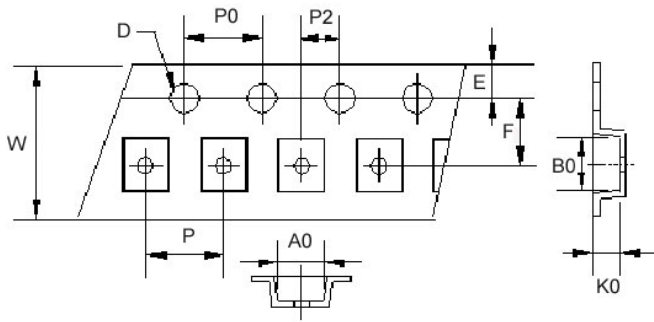

Tape Dimensions

Figure 2

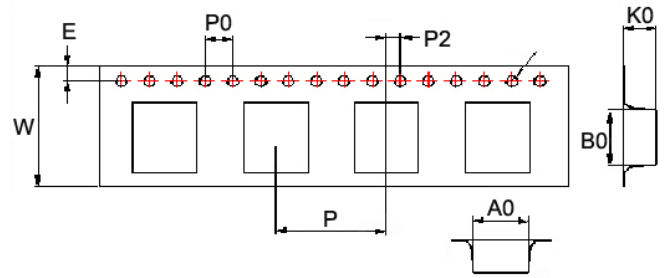

Reel Dimensions

Figure 1

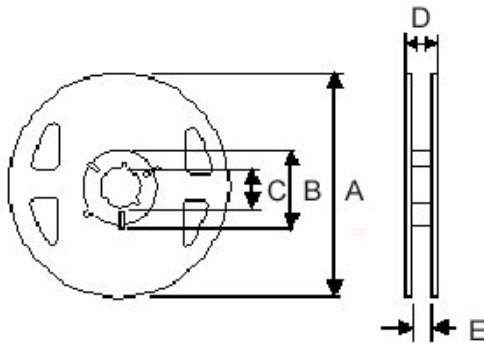

Reel Dimensions

Figure 2

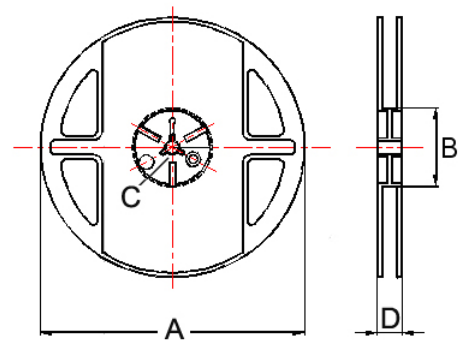

Dimensions in mm

TYPE	Fig	Tape Dimensions										Reel Dimensions					Quantity PCS / Reel
		A0	B0	K0	D	E	F	W	P	P0	P2	A	B	C	D	E	
LVT201B10	1	1.90	2.20	1.15	1.55	1.75	3.5	8.1	4	4	2	180	60	13	14.4	8.4	2000
LVT252A10	1	2.40	2.70	1.15	1.55	1.75	3.5	8.1	4	4	2	180	60	13	14.4	8.4	2000
LVT252A12	1	2.40	2.70	1.35	1.55	1.75	3.5	8.1	4	4	2	180	60	13	14.4	8.4	2000
LVT303010	1	3.20	3.20	1.40	1.55	1.75	3.5	8.1	4	4	2	180	60	13	14.4	8.4	2000
LVT303012	1	3.20	3.20	1.40	1.55	1.75	3.5	8.1	4	4	2	180	60	13	14.4	8.4	2000
LVT404012	2	4.25	4.25	1.30	1.55	1.75	5.5	12	8	4	2	178	60	13	13.2	-	1000
LVT404015	2	4.25	4.25	1.70	1.55	1.75	5.5	12	8	4	2	178	60	13	13.2	-	1000
LVT404026	2	4.25	4.25	3.00	1.55	1.75	5.5	12	8	4	2	178	60	13	13.2	-	500
LVT505020	2	5.25	5.25	2.20	1.55	1.75	5.5	12	8	4	2	330	100	13	13.4	-	2000
LVT606020	2	6.25	6.25	2.20	1.55	1.75	7.5	16	12	4	2	330	100	13	16.0	-	2000
LVT808040	2	8.25	8.25	4.15	1.55	1.75	7.5	16	12	4	2	330	100	13	16.0	-	1000

LVC Series

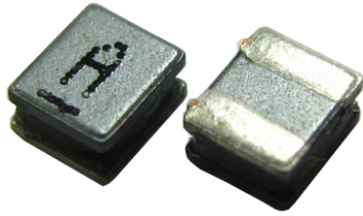

LVC series, an automatic assembly constructed power inductor, is shielded with magnetic resin and suitable for portable DC-DC converter application.

Features

- RoHS, Halogen Free and REACH Compliance
- Shielded with magnetic resin
- Various package size and wide inductance range
- Optimize electrical characteristics by using different ferrite core figures

Applications

- Smartphones, tablets and wearable devices
- DSC, camcorders
- AP Routers
- STBs
- LCD TVs, monitors and panels
- Game consoles
- DC/DC converters

Product Identification

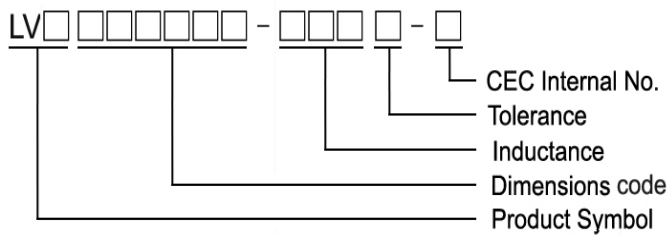

Shape and Dimensions

Figure 1

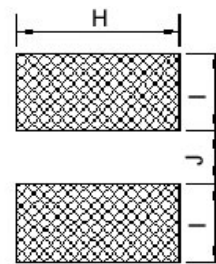
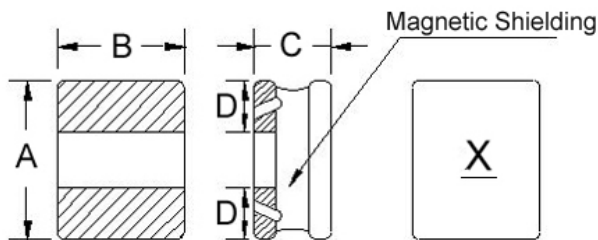

Dimensions in mm

TYPE	FIG	A	B	C	D	H	I	J
LVC201B10	1	2.0±0.25	1.6±0.25	1.00 Max	0.6	1.8	0.80	0.8
LVC201B12	1	2.0±0.25	1.6±0.25	1.2±0.05	0.6	1.8	0.80	0.8
LVC252A12	1	2.5±0.25	2.0±0.25	1.2±0.05	0.8	2.2	0.85	0.8

Shape and Dimensions

Recommended Pattern

Figure 2

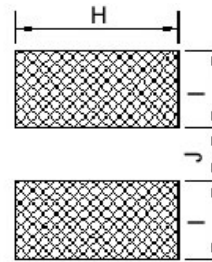
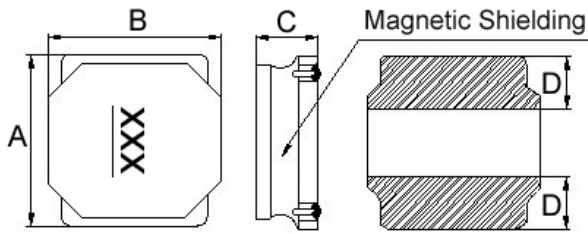

Dimensions in mm

TYPE	FIG	A	B	C	D	H	I	J
LVC404018	2	4.0±0.20	4.0±0.20	1.9 Max	1.3	3.7	1.5	1.2

Shape and Dimensions

Recommended Pattern

Figure 3

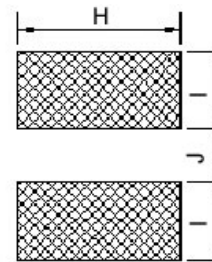
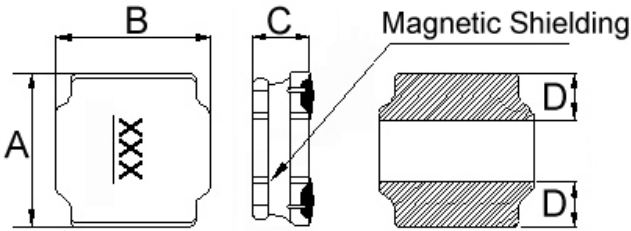

Dimensions in mm

TYPE	FIG	A	B	C	D	H	I	J
LVC505040	3	5.0±0.20	5.0±0.20	4.0±0.2	1.5	4.2	1.6	2.0
LVC606028	3	6.0±0.20	6.0±0.20	2.8±0.2	1.9±0.3	5.7	1.8	2.6
LVC606045	3	6.0±0.20	6.0±0.20	4.5 ^{+0.2} _{-0.30}	1.8±0.3	5.7	2.0	2.4

Electrical Characteristics

Part Number	Inductance (uH)	Tolerance (±%)	Test Frequency (MHz)	RDC (Ω) ±30%	Isat (A) Typ. (Max)	Irms (A) Typ. (Max)	Marking
LVC201B10-R24□-N	0.24	20, 30	1	0.026	3.20(2.80)	3.00(2.70)	M
LVC201B10-1R0□-N	1.0	20, 30	1	0.095	1.86(1.67)	1.86(1.67)	B
LVC201B10-1R5□-N	1.5	20, 30	1	0.140	1.64(1.47)	1.65(1.48)	C
LVC201B10-2R2□-N	2.2	20, 30	1	0.190	1.30(1.17)	1.30(1.17)	D
LVC201B10-3R3□-N	3.3	20, 30	1	0.295	0.96(0.86)	0.98(0.88)	E
LVC201B10-4R7□-N	4.7	20, 30	1	0.360	0.84(0.75)	0.90(0.81)	F
LVC201B10-6R8□-N	6.8	20, 30	1	0.640	0.66(0.59)	0.70(0.63)	G
LVC201B10-100□-N	10	20, 30	1	1.000	0.54(0.48)	0.56(0.50)	H
LVC201B10-150□-N	15	20, 30	1	1.500	0.39(0.35)	0.42(0.37)	K
LVC201B10-180□-N	18	20, 30	1	1.600	0.39(0.35)	0.41(0.36)	J
LVC201B10-220□-N	22	20, 30	1	1.700	0.38(0.34)	0.40(0.36)	I

Note: When ordering, please specify tolerance code. Tolerance: M=±20% , T =±30%

- Operating temperature range - 55°C ~ 125°C(Including self - temperature rise)
- Isat for Inductance drop 30% from its value without current
- I rms for a 40°C temperature rise from 25°C ambient with current
- Measure Equipment :
- L : Agilent HP4287A+Agilent HP16197A, 1MHz 200mV
 RDC : DIGITAL MILLINHM METER CHROMA 16502, or equivalent
 Isat & I rms : Agilent HP4284A

Test Instruments : HP4284A Material/Impedance Analyzer

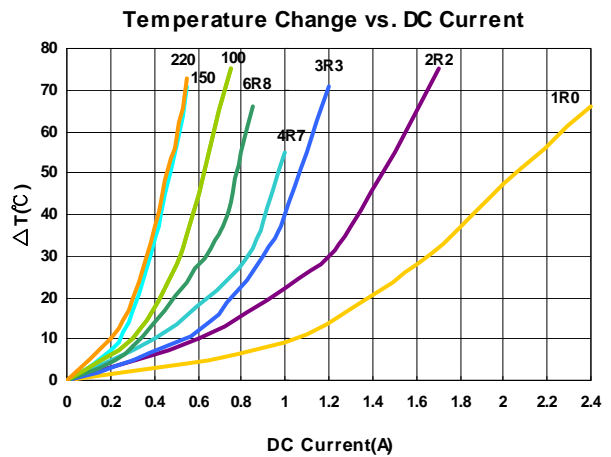
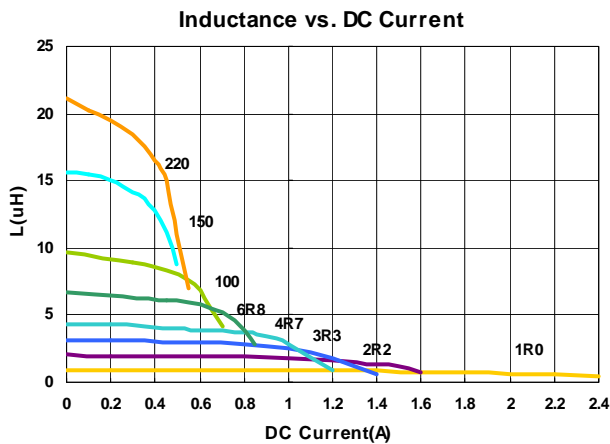

Please be sure to request approval specifications that provide further details of the products. Kindly note that the content of these specifications are subject to change or may be discontinued without advance notice. Please contact our sales department before ordering.

Electrical Characteristics

Part Number	Inductance (uH)	Tolerance (±%)	Test Frequency (MHz)	RDC (Ω) ±30%	Isat (A) Typ. (Max)	Irms (A) Typ. (Max)	Marking
LVC201B12-R50□-N	0.5	20, 30	1	0.051	2.60(2.34)	2.30(2.07)	B
LVC201B12-1R0□-N	1.0	20, 30	1	0.083	1.90(1.71)	1.80(1.62)	C
LVC201B12-2R2□-N	2.2	20, 30	1	0.159	1.36(1.22)	1.34(1.20)	E
LVC201B12-3R3□-N	3.3	20, 30	1	0.220	1.10(0.99)	1.06(0.95)	F
LVC201B12-4R7□-N	4.7	20, 30	1	0.330	0.92(0.82)	0.90(0.81)	G
LVC201B12-100□-N	10	20, 30	1	0.580	0.62(0.55)	0.58(0.52)	I
LVC201B12-150□-N	15	20, 30	1	0.900	0.48(0.43)	0.45(0.40)	J
LVC201B12-220□-N	22	20, 30	1	1.400	0.40(0.36)	0.40(0.36)	K

Note: When ordering, please specify tolerance code. Tolerance: M=±20% , T =±30%

- Operating temperature range - 55°C ~ 125°C(Including self - temperature rise)
- Isat for Inductance drop 30% from its value without current
- I rms for a 40°C temperature rise from 25°C ambient with current
- Measure Equipment :
- L : Agilent HP4287A+Agilent HP16197A, 1MHz 200mV
- RDC : DIGITAL MILLINHM METER CHROMA 16502, or equivalent
- Isat & I rms : Agilent HP4284A

Test Instruments : HP4284A Material/Impedance Analyzer

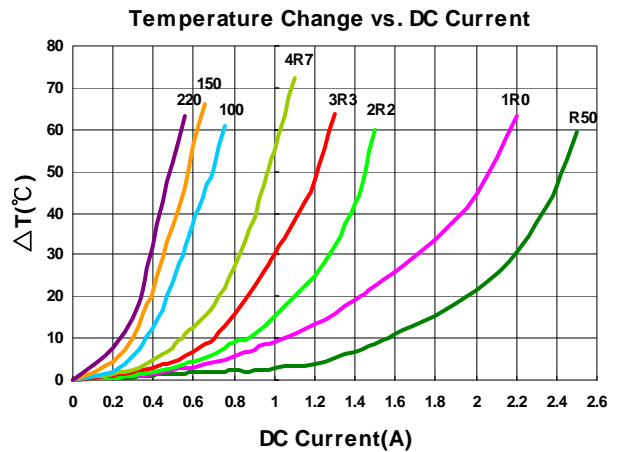
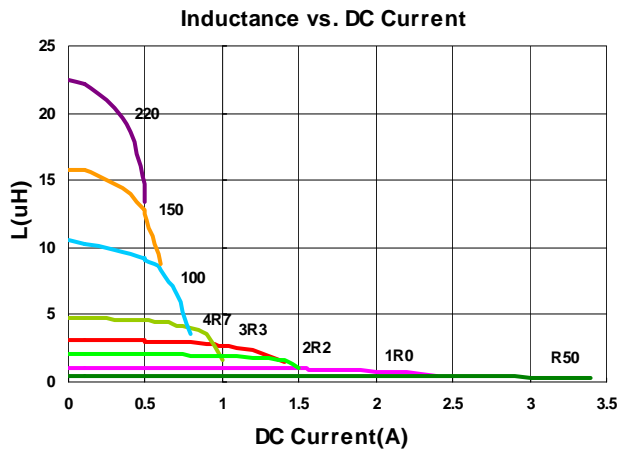

Please be sure to request approval specifications that provide further details of the products. Kindly note that the content of these specifications are subject to change or may be discontinued without advance notice. Please contact our sales department before ordering.

Electrical Characteristics

Part Number	Inductance (uH)	Tolerance (±%)	Test Frequency (MHz)	RDC (Ω) ±30%	Isat (A) Typ. (Max)	Irms (A) Typ. (Max)	Marking
LVC252A12-R68□-N	0.68	20, 30	1	0.035	2.80(2.52)	2.60(2.34)	N

Note: When ordering, please specify tolerance code. Tolerance: M=±20% , T =±30%

- Operating temperature range - 55°C ~ 125°C(Including self - temperature rise)
- Isat for Inductance drop 30% from its value without current
- Irms for a 40°C temperature rise from 25°C ambient with current
- Measure Equipment :
- L : Agilent HP4287A+Agilent HP16197A, 1MHz 200mV
 RDC : DIGITAL MILLINHM METER CHROMA 16502, or equivalent
 Isat & Irms : Agilent HP4284A

Test Instruments : HP4284A Material/Impedance Analyzer

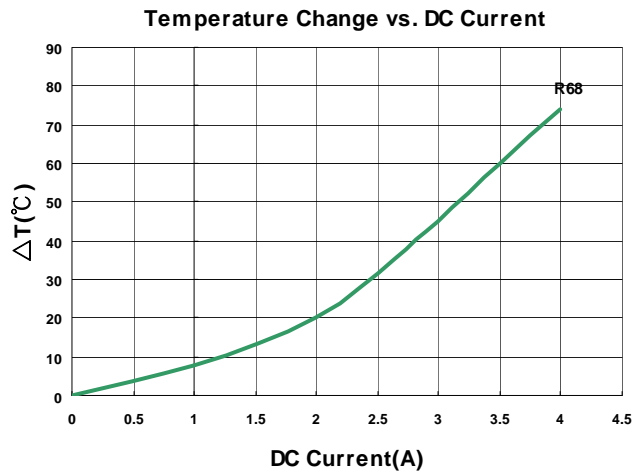
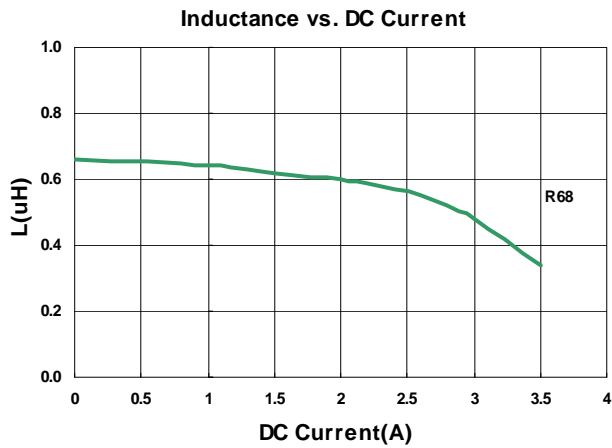

Please be sure to request approval specifications that provide further details of the products. Kindly note that the content of these specifications are subject to change or may be discontinued without advance notice. Please contact our sales department before ordering.

Electrical Characteristics

Part Number	Inductance (uH)	Tolerance (±%)	Test Frequency (kHz)	RDC (Ω) ±30%	Isat (A) Typ. (Max)	Irms (A) Typ. (Max)	Marking
LVC404018-1R2□-N	1.2	20, 30	100	0.027	3.70(3.30)	3.60(3.20)	1R2
LVC404018-4R7□-N	4.7	20, 30	100	0.077	2.00(1.80)	1.80(1.62)	4R7
LVC404018-6R8□-N	6.8	20, 30	100	0.105	1.50(1.35)	1.35(1.21)	6R8
LVC404018-100□-N	10	20, 30	100	0.160	1.40(1.26)	1.20(1.08)	100
LVC404018-150□-N	15	20, 30	100	0.245	1.05(0.94)	0.95(0.85)	150
LVC404018-220□-N	22	20, 30	100	0.335	0.90(0.81)	0.88(0.79)	220

Note: When ordering, please specify tolerance code. Tolerance: M=±20% , T =±30%

- Operating temperature range - 55°C ~ 125°C(Including self - temperature rise)
- Isat for Inductance drop 30% from its value without current
- Irms for a 40°C temperature rise from 25°C ambient with current
- Measure Equipment :
- L : Agilent HP 4284A+Agilent HP 42841A, 100kHz 1V
- RDC : DIGITAL MILLINHM METER CHROMA 16502, or equivalent
- Isat & Irms : Agilent HP4284A

Test Instruments : HP4284A Material/Impedance Analyzer

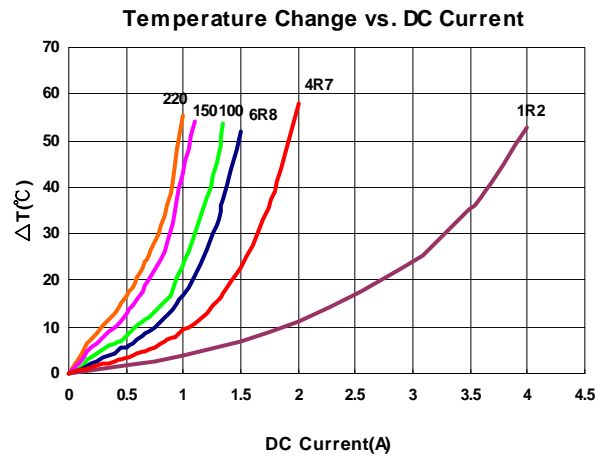
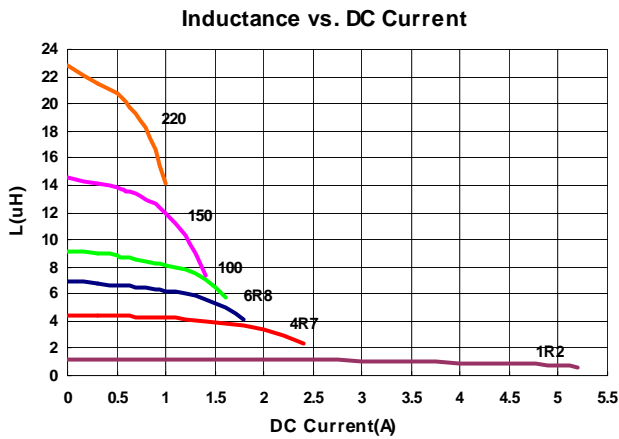

Please be sure to request approval specifications that provide further details of the products. Kindly note that the content of these specifications are subject to change or may be discontinued without advance notice. Please contact our sales department before ordering.

Electrical Characteristics

Part Number	Inductance (uH)	Tolerance (±%)	Test Frequency (kHz)	RDC (Ω) ±30%	Isat (A) Typ. (Max)	Irms (A) Typ. (Max)	Marking
LVC505040-1R0□-N	1.0	20, 30	100	0.012	8.8(7.92)	5.9(5.31)	1R0
LVC505040-1R5□-N	1.5	20,30	100	0.014	7.9(7.11)	5.4(4.86)	1R5
LVC505040-2R2□-N	2.2	20, 30	100	0.020	6.8(6.12)	4.5(4.05)	2R2
LVC505040-2R7□-N	2.7	20, 30	100	0.026	6.0(5.40)	4.2(3.70)	2R7
LVC505040-3R3□-N	3.3	20, 30	100	0.026	5.3(4.77)	4.2(3.78)	3R3
LVC505040-4R7□-N	4.7	20, 30	100	0.032	4.4(3.96)	3.2(2.88)	4R7
LVC505040-6R8□-N	6.8	20, 30	100	0.050	3.8(3.42)	3.0(2.70)	6R8
LVC505040-100□-N	10	20, 30	100	0.070	3.0(2.70)	2.3(2.07)	100
LVC505040-150□-N	15	20, 30	100	0.115	2.4(2.16)	1.8(1.62)	150
LVC505040-220□-N	22	20, 30	100	0.160	2.0(1.80)	1.6(1.44)	220
LVC505040-151□-N	150	20, 30	100	1.180	0.74(0.66)	0.58(0.52)	151
LVC505040-181□-N	180	20, 30	100	1.250	0.67(0.60)	0.54(0.48)	181
LVC505040-221□-N	220	20, 30	100	1.450	0.65(0.58)	0.50(0.45)	221

Note: When ordering, please specify tolerance code. Tolerance: M=±20% , T =±30%

- Operating temperature range - 55°C ~ 125°C(Including self - temperature rise)
- Isat for Inductance drop 30% from its value without current
- I rms for a 40°C temperature rise from 25°C ambient with current
- Measure Equipment :
- L : Agilent HP 4284A+Agilent HP 42841A, 100kHz 1V
- RDC : DIGITAL MILLINHM METER CHROMA 16502, or equivalent
- Isat & I rms : Agilent HP4284A

Test Instruments : HP4284A Material/Impedance Analyzer

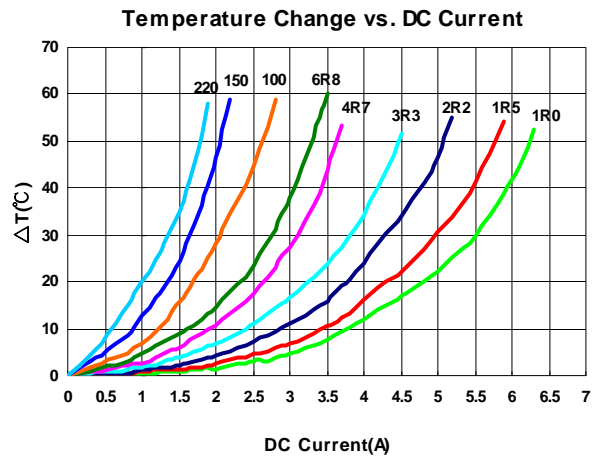
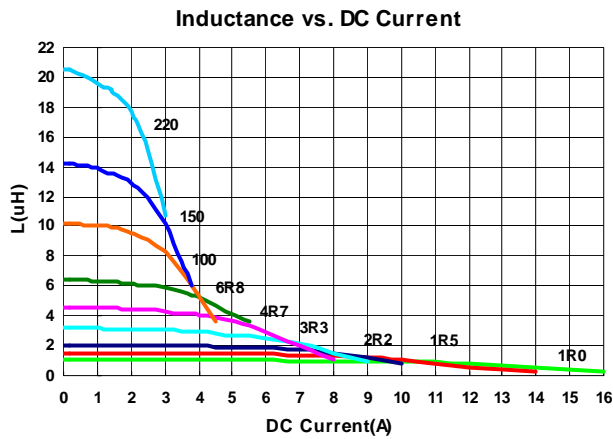

Please be sure to request approval specifications that provide further details of the products. Kindly note that the content of these specifications are subject to change or may be discontinued without advance notice. Please contact our sales department before ordering.

Electrical Characteristics

Part Number	Inductance (uH)	Tolerance (±%)	Test Frequency (kHz)	RDC (Ω) ±30%	Isat (A) Typ. (Max)	Irms (A) Typ. (Max)	Marking
LVC606028-3R3□-N	3.3	20, 30	100	0.027	4.5(4.05)	4.0(3.60)	3R3
LVC606028-100□-N	10	20, 30	100	0.065	2.6(2.34)	2.5(2.25)	100
LVC606028-150□-N	15	20, 30	100	0.093	2.1(1.89)	2.0(1.80)	150
LVC606028-220□-N	22	20, 30	100	0.135	1.7(1.53)	1.65(1.48)	220

Note: When ordering, please specify tolerance code. Tolerance: M=±20% , T=±30%

- Operating temperature range - 55°C ~ 125°C(Including self - temperature rise)
- Isat for Inductance drop 30% from its value without current
- I rms for a 40°C temperature rise from 25°C ambient with current
- Measure Equipment :
- L : Agilent HP 4284A+Agilent HP 42841A, 100kHz 1V
- RDC : DIGITAL MILLINHM METER CHROMA 16502, or equivalent
- Isat & I rms : Agilent HP4284A

Test Instruments : HP4284A Material/Impedance Analyzer

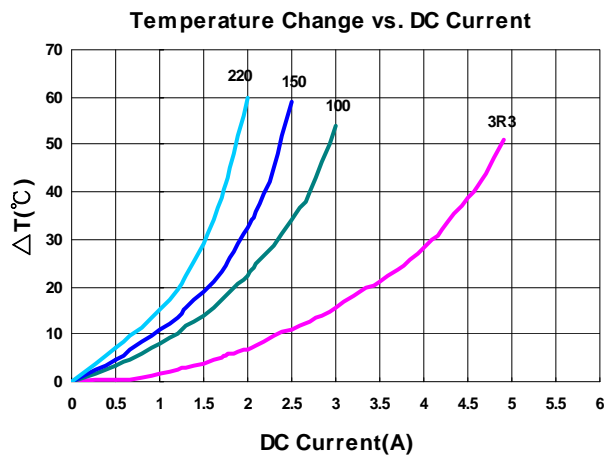
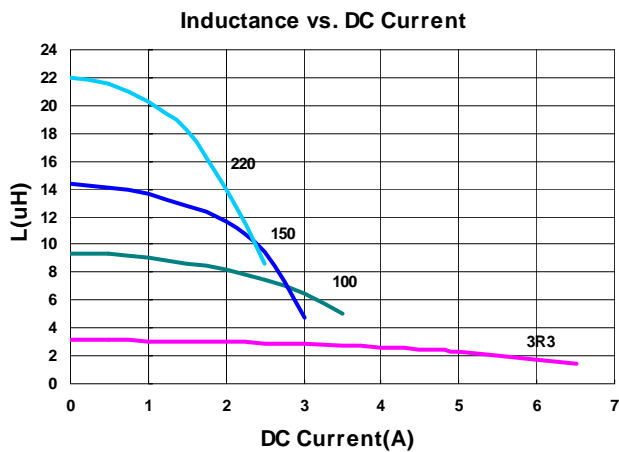

Please be sure to request approval specifications that provide further details of the products. Kindly note that the content of these specifications are subject to change or may be discontinued without advance notice. Please contact our sales department before ordering.

Electrical Characteristics

Part Number	Inductance (uH)	Tolerance (±%)	Test Frequency (kHz)	RDC (Ω) ±30%	Isat (A) Typ. (Max)	Irms (A) Typ. (Max)	Marking
LVC606045-1R0□-N	1.0	20,30	100	0.010	13(11.7)	7.3(6.57)	1R0
LVC606045-1R5□-N	1.5	20,30	100	0.012	12(10.8)	6.6(5.94)	1R5
LVC606045-2R2□-N	2.2	20, 30	100	0.018	9.5(8.55)	5.2(4.68)	2R2
LVC606045-3R3□-N	3.3	20, 30	100	0.022	7.8(7.02)	4.4(3.96)	3R3
LVC606045-4R7□-N	4.7	20, 30	100	0.030	6.8(6.12)	4.0(3.60)	4R7
LVC606045-6R8□-N	6.8	20, 30	100	0.042	5.7(5.13)	3.3(2.97)	6R8
LVC606045-100□-N	10	20, 30	100	0.060	4.6(4.14)	2.6(2.34)	100
LVC606045-150□-N	15	20, 30	100	0.090	3.8(3.42)	2.2(1.98)	150
LVC606045-220□-N	22	20, 30	100	0.130	3.3(2.97)	1.9(1.71)	220

Note: When ordering, please specify tolerance code. Tolerance: M=±20% , T =±30%

- Operating temperature range - 55°C ~ 125°C(Including self - temperature rise)
- Isat for Inductance drop 30% from its value without current
- I rms for a 40°C temperature rise from 25°C ambient with current
- Measure Equipment :
- L : Agilent HP 4284A+Agilent HP 42841A, 100kHz 1V
- RDC : DIGITAL MILLINHM METER CHROMA 16502, or equivalent
- Isat & I rms : Agilent HP4284A

Test Instruments : HP4284A Material/Impedance Analyzer

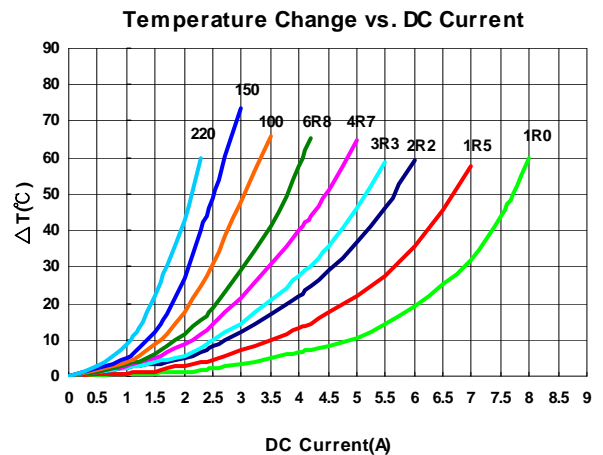
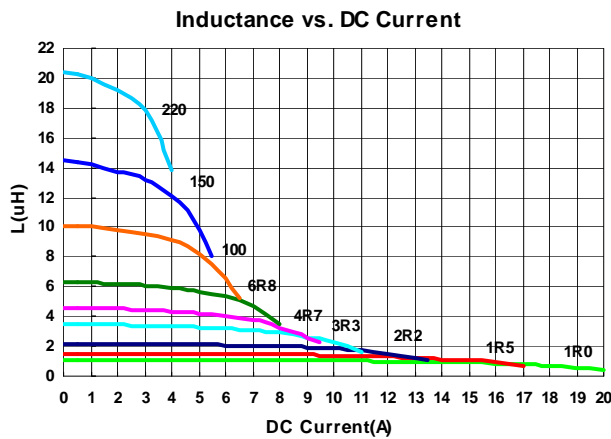

Please be sure to request approval specifications that provide further details of the products. Kindly note that the content of these specifications are subject to change or may be discontinued without advance notice. Please contact our sales department before ordering.

Packaging Specifications

Tape Dimensions

Figure 1

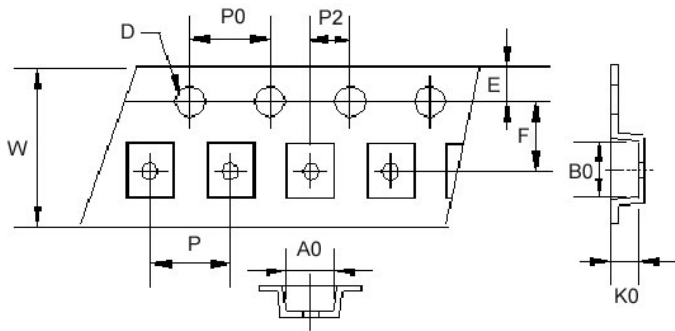
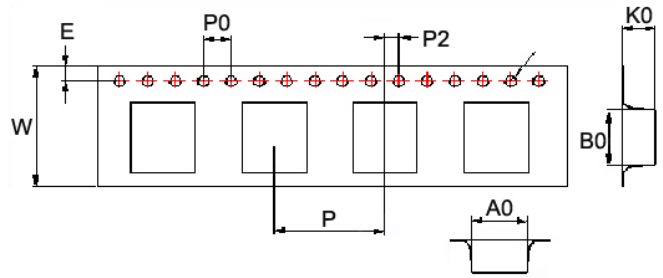
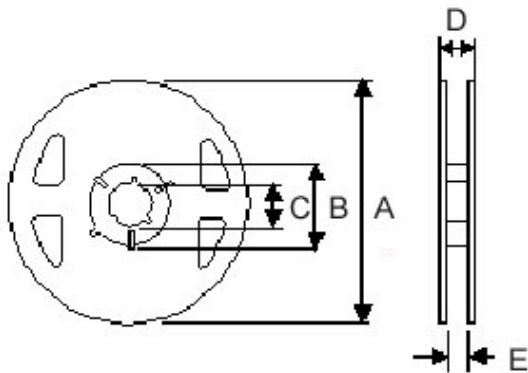

Figure 2



Reel Dimensions

Figure 1



Reel Dimensions

Figure 2

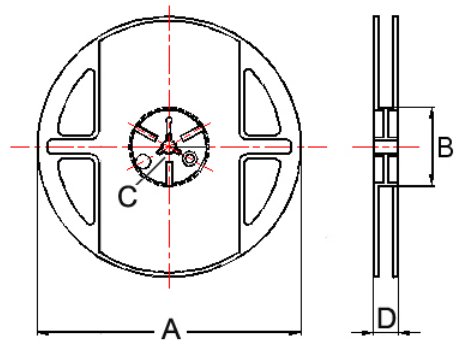

Dimensions in mm

TYPE	Fig	Tape Dimensions										Reel Dimensions					Quantity PCS / Reel
		A0	B0	K0	D	E	F	W	P	P0	P2	A	B	C	D	E	
LVC201B10	1	1.90	2.20	1.15	1.55	1.75	3.5	8.1	4	4	2	180	60	13	14.4	8.4	2000
LVC201B12	1	1.90	2.20	1.30	1.55	1.75	3.5	8.1	4	4	2	180	60	13	14.4	8.4	2000
LVC252A12	1	2.40	2.70	1.35	1.55	1.75	3.5	8.1	4	4	2	180	60	13	14.4	8.4	2000
LVC404018	2	4.25	4.25	2.10	1.55	1.75	5.5	12	8	4	2	178	60	13	13.2	-	800
LVC505040	2	5.30	5.30	4.40	1.55	1.75	5.5	12	8	4	2	330	100	13	13.4	-	1500
LVC606028	2	6.25	6.25	3.00	1.55	1.75	7.5	16	12	4	2	330	100	13	16.0	-	1500
LVC606045	2	6.25	6.25	4.65	1.55	1.75	7.5	16	12	4	2	330	100	13	16.0	-	1000

LVH Series

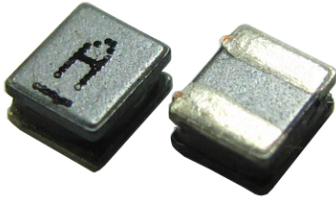

LVH series, an automatic assembly constructed power inductor, is shielded with magnetic resin and suitable for portable DC-DC converter applications.

Features

- RoHS, Halogen Free and REACH Compliance
- Shielded with magnetic resin
- Low profile, miniature package size and wide inductance range.
- Low DCR and high rated current.

Applications

- Smart phone
- DSC
- Tablet PC and other portable devices
- DC/DC converters

Product Identification

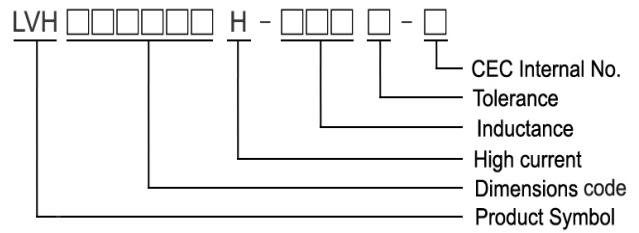
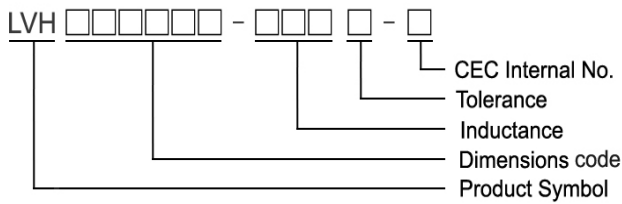

Shape and Dimensions

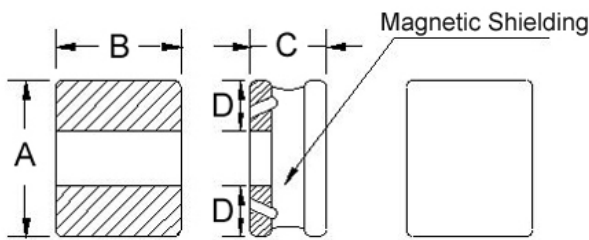

Recommended Pattern

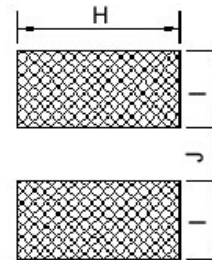

Dimensions in mm

TYPE	A	B	C	D	H	I	J
LVH201B10H	2.0±0.25	1.6±0.25	1.02 Max	0.6	1.8	0.8	0.8
LVH252A10H	2.5±0.25	2.0±0.25	1.00 Max	0.8	2.2	0.85	0.8
LVH252A12	2.5±0.25	2.0±0.25	1.2±0.05	0.8	2.2	0.85	0.8
LVH252A12H	2.5±0.25	2.0±0.25	1.2±0.05	0.8	2.2	0.85	0.8

Electrical Characteristics

Part Number	Inductance (uH)	Tolerance (±%)	Test Frequency (MHz)	RDC (Ω) ±30%	Isat (mA) Typ. (Max)	Irms (mA) Typ. (Max)
LVH201B10H-R24□-N	0.24	20, 30	1	0.048	3700(3300)	2500(2100)
LVH201B10H-R33□-N	0.33	20, 30	1	0.048	3400(3000)	2500(2100)
LVH201B10H-R47□-N	0.47	20, 30	1	0.072	2900(2600)	2100(1800)
LVH201B10H-R56□-N	0.56	20, 30	1	0.072	2700(2400)	2100(1800)
LVH201B10H-R68□-N	0.68	20, 30	1	0.092	2500(2200)	1800(1500)
LVH201B10H-1R0□-N	1.0	20, 30	1	0.110	2200(2000)	1500(1200)
LVH201B10H-2R2□-N	2.2	20, 30	1	0.205	1400(1200)	1150(970)
LVH201B10H-3R3□-N	3.3	20, 30	1	0.380	1050(940)	900(800)
LVH201B10H-4R7□-N	4.7	20, 30	1	0.520	900(800)	800(680)
LVH201B10H-100□-N	10	20, 30	1	1.100	620(550)	450(380)

Note: When ordering, please specify tolerance code. Tolerance: M=±20% , T =±30%

- Operating temperature range - 55°C ~ 125°C(Including self - temperature rise)
- Isat for Inductance drop 30% from its value without current
- Irms for a 40°C temperature rise from 25°C ambient with current
- Measure Equipment :
- L : Agilent HP4287A+Agilent HP16197A, 1MHz 200mV
 RDC : DIGITAL MILLINHM METER CHROMA 16502, or equivalent
 Isat & Irms : Agilent HP4284A

Test Instruments : HP4284A Material/Impedance Analyzer

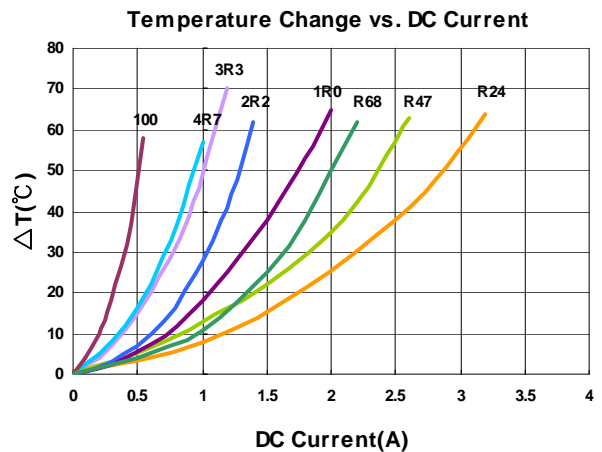
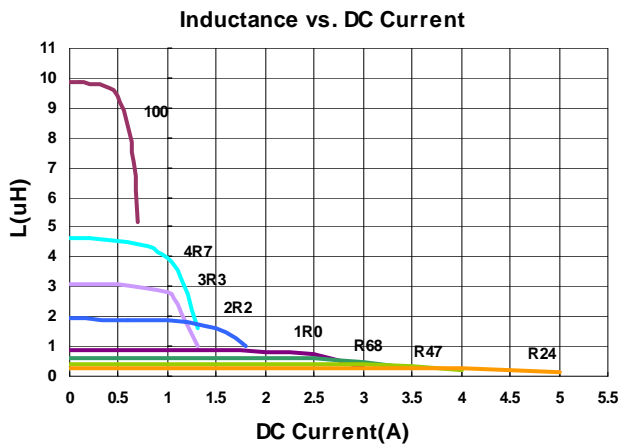

Please be sure to request approval specifications that provide further details of the products. Kindly note that the content of these specifications are subject to change or may be discontinued without advance notice. Please contact our sales department before ordering.

Electrical Characteristics

Part Number	Inductance (uH)	Tolerance (±%)	Test Frequency (MHz)	RDC (Ω) ±30%	Isat (mA) Typ. (Max)	Irms (mA) Typ. (Max)
LVH252A10H-R24□-N	0.24	20, 30	1	0.030	4700(4200)	3600(3000)
LVH252A10H-R47□-N	0.47	20, 30	1	0.043	3300(3000)	2700(2300)
LVH252A10H-R68□-N	0.68	20, 30	1	0.062	2800(2500)	2300(1900)
LVH252A10H-1R0□-N	1.0	20, 30	1	0.080	2300(2100)	1900(1600)
LVH252A10H-2R2□-N	2.2	20, 30	1	0.135	1600(1400)	1400(1100)
LVH252A10H-4R7□-N	4.7	20, 30	1	0.330	1000(900)	850(720)
LVH252A10H-100□-N	10	20, 30	1	0.670	720(640)	580(490)

Note: When ordering, please specify tolerance code. Tolerance: M=±20% , T =±30%

- Operating temperature range - 55°C ~ 125°C(Including self - temperature rise)
- Isat for Inductance drop 30% from its value without current
- Irms for a 40°C temperature rise from 25°C ambient with current
- Measure Equipment :
- L : Agilent HP4287A+Agilent HP16197A, 1MHz 200mV
- RDC : DIGITAL MILLINHM METER CHROMA 16502, or equivalent
- Isat & Irms : Agilent HP4284A

Test Instruments : HP4284A Material/Impedance Analyzer

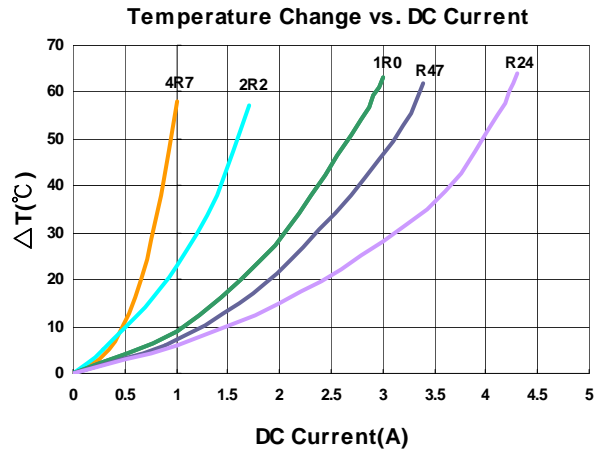
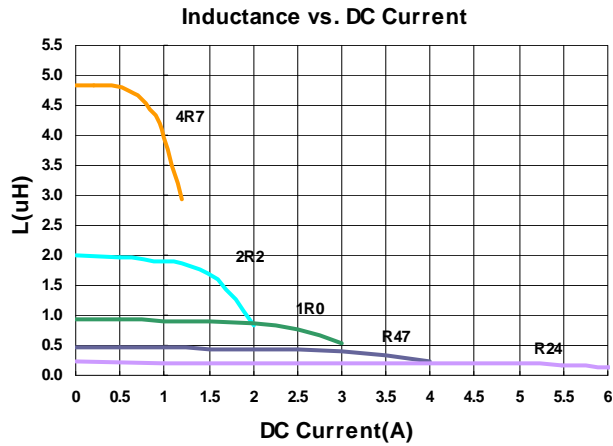

Please be sure to request approval specifications that provide further details of the products. Kindly note that the content of these specifications are subject to change or may be discontinued without advance notice. Please contact our sales department before ordering.

Electrical Characteristics

Part Number	Inductance (uH)	Tolerance (±%)	Test Frequency (MHz)	RDC (Ω) ±30%	Isat (mA) Typ. (Max)	Irms (mA) Typ. (Max)
LVH252A12H-R47□-N	0.47	20, 30	1	0.031	4100(3700)	3100(2600)
LVH252A12H-R68□-N	0.68	20, 30	1	0.031	3100(2900)	3100(2600)
LVH252A12H-1R0□-N	1.0	20, 30	1	0.049	3200(3000)	3000(2500)
LVH252A12H-1R5□-N	1.5	20, 30	1	0.088	2300(2100)	2200(1800)
LVH252A12H-2R2□-N	2.2	20, 30	1	0.099	2200(2000)	2000(1700)
LVH252A12H-3R3□-N	3.3	20, 30	1	0.190	1400(1200)	1200(1000)
LVH252A12H-4R7□-N	4.7	20, 30	1	0.235	1300(1100)	1100(930)
LVH252A12H-100□-N	10	20, 30	1	0.510	920(820)	800(680)

Note: When ordering, please specify tolerance code. Tolerance: M=±20% , T =±30%

- Operating temperature range - 55°C ~ 125°C(Including self - temperature rise)
- Isat for Inductance drop 30% from its value without current
- I rms for a 40°C temperature rise from 25°C ambient with current
- Measure Equipment :
- L : Agilent HP4287A+Agilent HP16197A, 1MHz 200mV
- RDC : DIGITAL MILLINHM METER CHROMA 16502, or equivalent
- Isat & I rms : Agilent HP4284A

Test Instruments : HP4284A Material/Impedance Analyzer

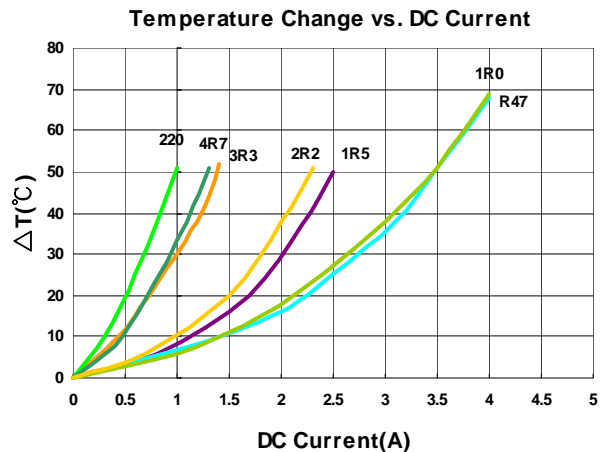
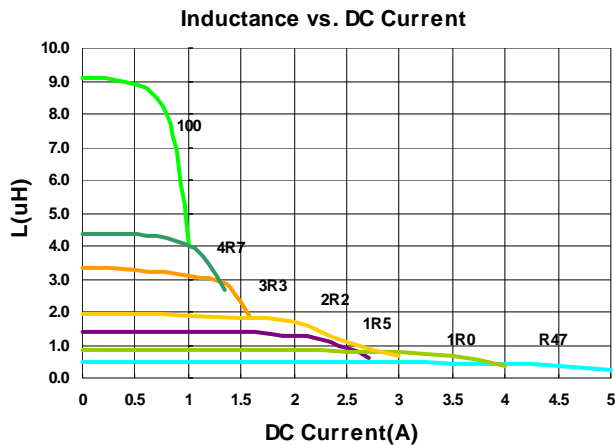

Please be sure to request approval specifications that provide further details of the products. Kindly note that the content of these specifications are subject to change or may be discontinued without advance notice. Please contact our sales department before ordering.

Electrical Characteristics

Part Number	Inductance (uH)	Tolerance (±%)	Test Frequency (MHz)	RDC (Ω) ±30%	Isat (mA) Typ. (Max)	Irms (mA) Typ. (Max)	Marking
LVH252A12-R24□-N	0.24	20, 30	1	0.021	4700(4200)	3800(3200)	E
LVH252A12-R33□-N	0.33	20, 30	1	0.027	4200(3700)	3000(2500)	G
LVH252A12-R47□-N	0.47	20, 30	1	0.027	3600(3400)	3000(2500)	J
LVH252A12-R50□-N	0.50	20, 30	1	0.027	3600(3400)	3000(2500)	D
LVH252A12-R68□-N	0.68	20, 30	1	0.036	2900(2600)	2800(2300)	H
LVH252A12-1R0□-N	1.0	20, 30	1	0.037	2700(2450)	2600(2200)	A
LVH252A12-1R5□-N	1.5	20, 30	1	0.075	2200(1900)	1900(1600)	I
LVH252A12-2R2□-N	2.2	20, 30	1	0.080	1900(1800)	1800(1500)	B
LVH252A12-4R7□-N	4.7	20, 30	1	0.195	1200(1000)	1100(930)	C
LVH252A12-100□-N	10	20, 30	1	0.400	900(800)	800(680)	F

Note: When ordering, please specify tolerance code. Tolerance: M=±20% , T =±30%

- Operating temperature range - 55°C ~ 125°C(Including self - temperature rise)
- Isat for Inductance drop 30% from its value without current
- Irms for a 40°C temperature rise from 25°C ambient with current
- Measure Equipment :
- L : Agilent HP4287A+Agilent HP16197A, 1MHz 200mV
- RDC : DIGITAL MILLINHM METER CHROMA 16502, or equivalent
- Isat & Irms : Agilent HP4284A

Test Instruments : HP4284A Material/Impedance Analyzer

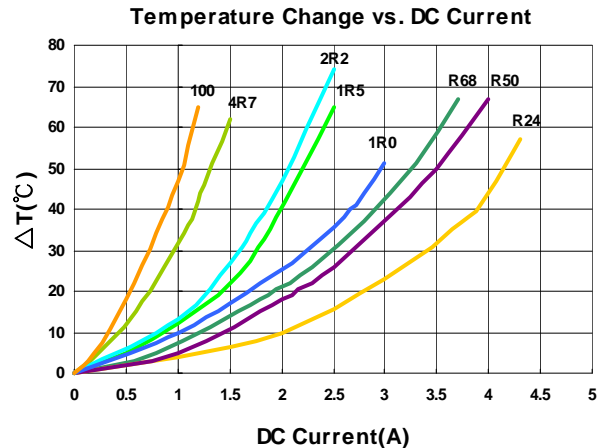
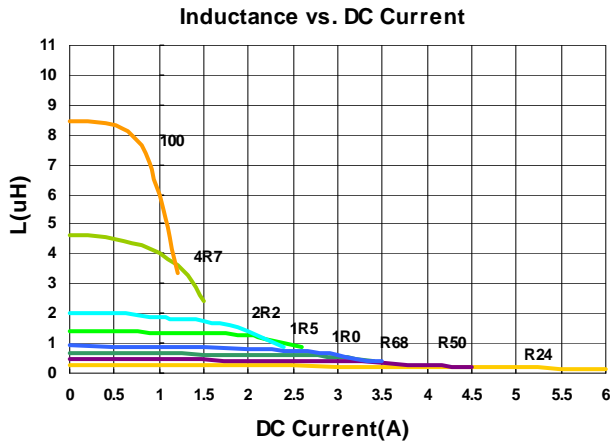

Please be sure to request approval specifications that provide further details of the products. Kindly note that the content of these specifications are subject to change or may be discontinued without advance notice. Please contact our sales department before ordering.

Packaging Specifications

Tape Dimensions

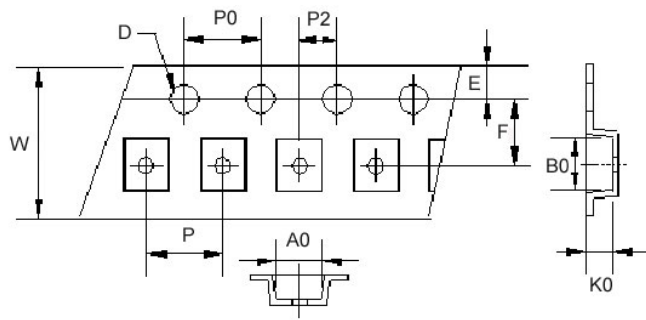

Reel Dimensions

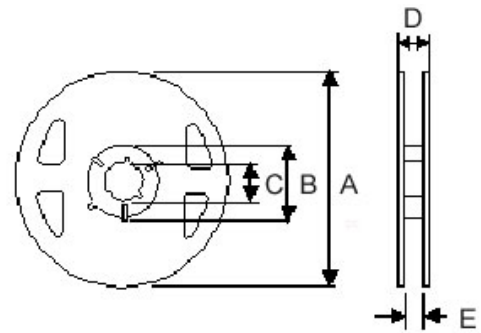

Dimensions in mm

TYPE	Tape Dimensions											Reel Dimensions					Quantity PCS / Reel
	A0	B0	K0	D	E	F	W	P	P0	P2	A	B	C	D	E		
LVH201B10H	1.90	2.20	1.15	1.55	1.75	3.5	8.1	4	4	2	180	60	13	14.4	8.4	2000	
LVH252A10H	2.40	2.70	1.15	1.55	1.75	3.5	8.1	4	4	2	180	60	13	14.4	8.4	2000	
LVH252A12H	2.40	2.70	1.35	1.55	1.75	3.5	8.1	4	4	2	180	60	13	14.4	8.4	2000	
LVH252A12	2.40	2.70	1.35	1.55	1.75	3.5	8.1	4	4	2	180	60	13	14.4	8.4	2000	

SF Series

Features

- RoHS, Halogen Free and REACH Compliance
- Surface mount inductors designed for high speed, high current switch mode applications requiring lower inductance
- Gapped ferrite cores for maximum efficiency
- Customized specifications are available

Applications

- Voltage regulator modules (VRMs) for servers, microprocessors
- High frequency, high current switching power supplies

Product Identification

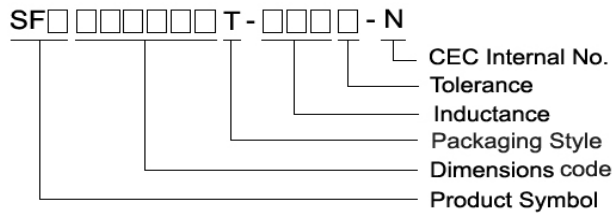

Shape and Dimensions

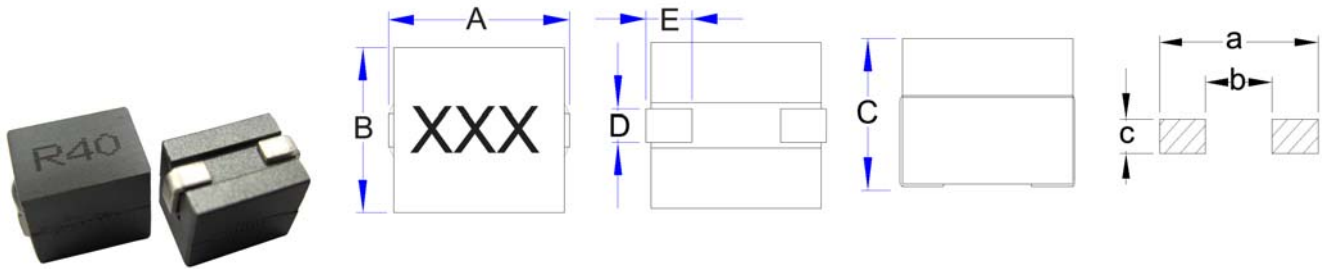

Dimensions in mm

TYPE	A	B	C	D	E	a	b	c
SFD100707	11.0 Max	7.5 Max	7.0 Max	1.6±0.2	2.6±0.3	11.0	4.3	2

Shape and Dimensions

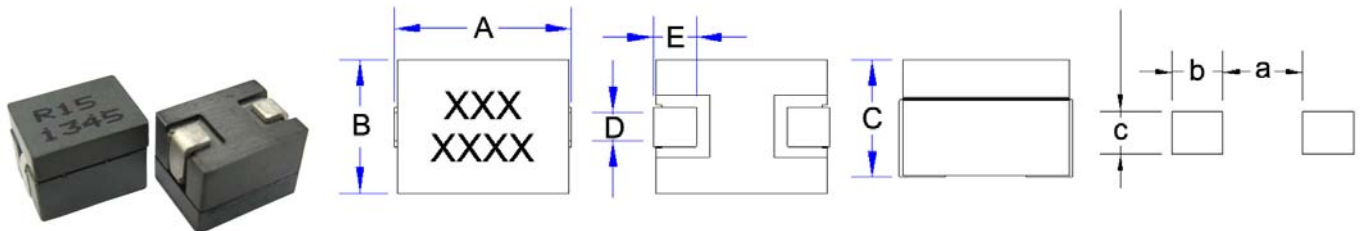

Dimensions in mm

TYPE	A	B	C	D	E	a	b	c
SFS100875	10.2±0.2	8.0 Max	7.3±0.2	2.2±0.2	2.54±0.5	4.7	3.0	2.5

Electrical Characteristics

Part Number	Inductance (uH)	Tolerance (±%)	Test Frequency (kHz)	RDC (mΩ) ±7%	Isat (A) Max	Irms (A) Max
SFD100707T-R12L-N	0.12	15	100	0.37	85	37
SFD100707T-R15L-N	0.15	15	100	0.37	75	37
SFD100707T-R18L-N	0.18	15	100	0.37	50	37
SFD100707T-R22L-N	0.22	15	100	0.37	40	37
SFD100707T-R33L-N	0.33	15	100	0.37	28	37
SFD100707T-R40L-N	0.40	15	100	0.37	21	37

Note: When ordering, please specify tolerance code. Tolerance: L=±15%

- Customized Specifications are available
- Operating temperature range - 40°C ~ 125°C(Including self - temperature rise)
- OCL (Open Circuit Inductance) Test parameters: 100kHz, 0.25Vrms, 0A_{dc} & Isat @20°C
- DC current for an approximate ΔT of 40°C without core loss. Derating is necessary for AC currents. PCB layout, trace thickness and width, airflow, and proximity of other heat generating components will affect the temperature rise. It is recommended that the temperature of the part not exceed 155°C under worst case operating conditions verified in the end application.
- Measure Equipment :
 L : WK4237METER
 RDC : CHEN HWA 502
 Isat : WK3260B+WK3265B

Inductance vs. DC Current

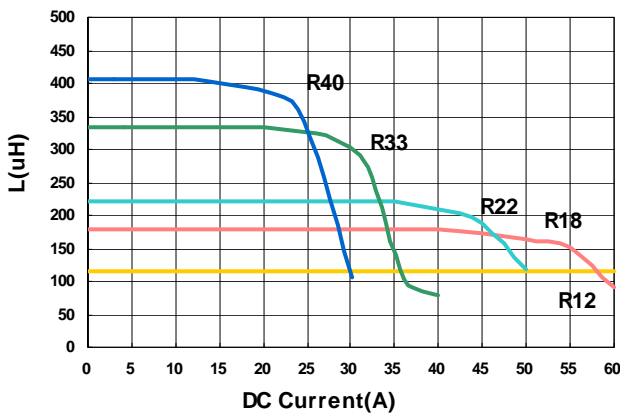

Temperature Change vs. DC Current

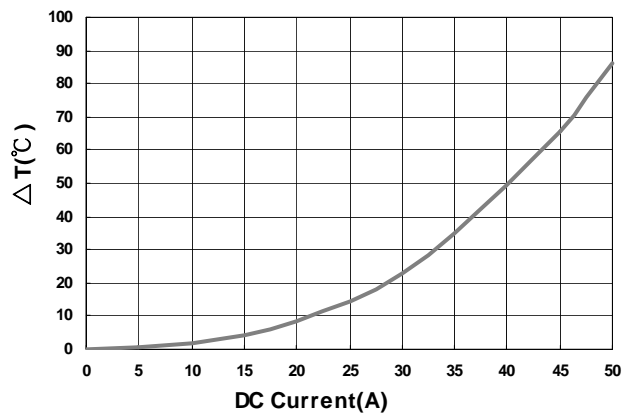

Please be sure to request approval specifications that provide further details of the products. Kindly note that the content of these specifications are subject to change or may be discontinued without advance notice. Please contact our sales department before ordering.

Electrical Characteristics

Part Number	Inductance (uH)	Tolerance (±%)	Test Frequency (kHz)	RDC (mΩ) ±6%	Isat (A) Max	Irms (A) Max
SFS100875T-R15K-N	0.15	10	100	0.29	76	56
SFS100875T-R17K-N	0.17	10	100	0.29	66	56
SFS100875T-R22K-N	0.215	10	100	0.29	50	56
SFS100875T-R27K-N	0.27	10	100	0.29	40	56
SFS100875T-R30K-N	0.30	10	100	0.29	35	56
SFS100875T-R40L-N	0.40	15	100	0.29	25	56

Note: When ordering, please specify tolerance code. Tolerance: K=±10% , L=±15%

- Customized Specifications are available
- Operating temperature range - 40°C ~ 125°C(Including self - temperature rise)
- OCL (Open Circuit Inductance) Test parameters: 100kHz, 0.25Vrms, 0Adc & Isat @20°C
- DC current for an approximate ΔT of 40°C without core loss. Derating is necessary for AC currents. PCB layout, trace thickness and width, airflow, and proximity of other heat generating components will affect the temperature rise. It is recommended that the temperature of the part not exceed 155°C under worst case operating conditions verified in the end application.
- Measure Equipment :
 L : WK4237METER
 RDC : CHEN HWA 502
 Isat : WK3260B+WK3265B

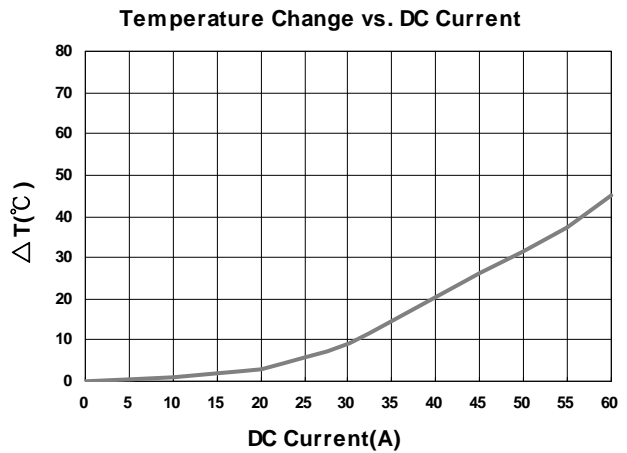
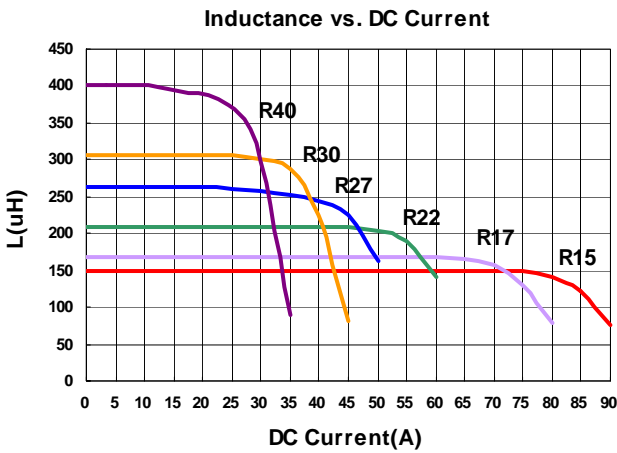

Please be sure to request approval specifications that provide further details of the products. Kindly note that the content of these specifications are subject to change or may be discontinued without advance notice. Please contact our sales department before ordering.

Packaging Specifications

Tape Dimensions

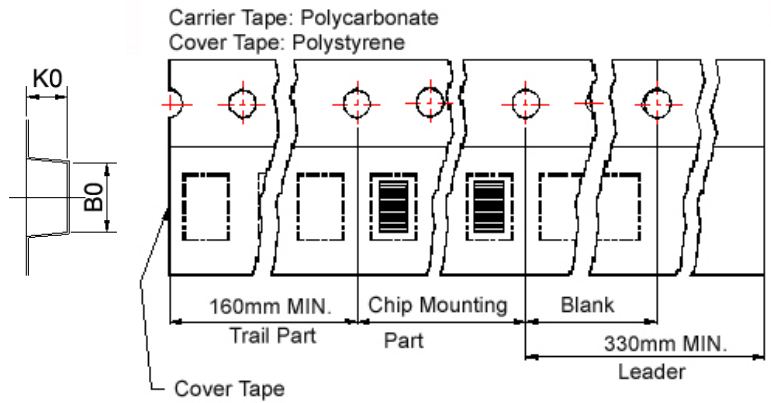
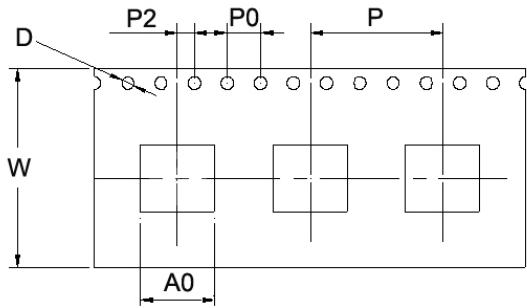

Reel Dimensions

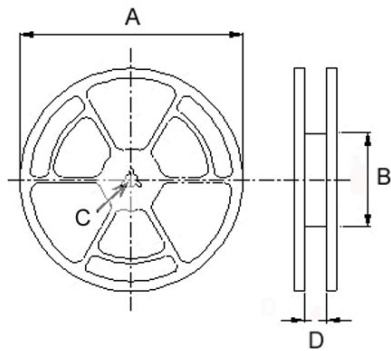

Dimensions in mm

TYPE	Tape Dimensions								Reel Dimensions				Quantity PCS / REEL
	A0	B0	K0	D	W	P	P0	P2	A	B	C	D	
SFD100707	7.4	10.6	7.6	1.5	24	12	4	2	330	100	13.5	24	640
SFS100875	8.0	10.3	7.7	1.5	24	12	4	2	330	100	13.5	24	700

CPUS Series



CPUS Series is designed for low RDC and ultra large current application. Its assembly model and magnetic shielding is suitable for high-density mounting. This series also provides customers with embossed carrier type packaging for automatic mounting machine.

Features

- RoHS, Halogen Free and REACH Compliance
- Magnetic shielded
- Handle high transient current spikes without saturation
- Customized specifications are available

Applications

- Graphic card, PCs and servers

Product Identification

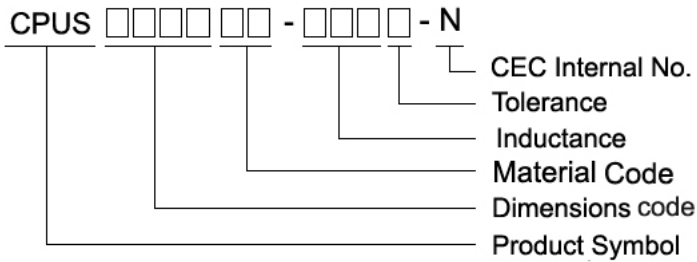

Shape and Dimensions

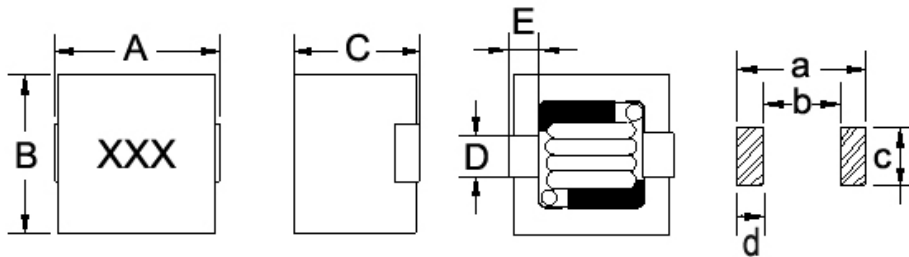

Dimensions in mm

TYPE	A	B	C	D	E	a	b	c	d
CPUS0807MN	8.8 ⁺⁰	8.4 ⁺⁰	7.5 ⁺⁰	2.3±0.2	1.5±0.2	9.2	4.4	3.0	2.3
CPUS1009MN	11.3 ⁺⁰	10.4 ⁺⁰	9.7 ⁺⁰	3.0±0.2	1.6±0.2	11.3	6.9	3.6	2.2
CPUS1210MN	12.3 ⁺⁰	11.7 ⁺⁰	10.0 ⁺⁰	3.5±0.2	2.0±0.2	12.8	7.0	5.4	2.9

Electrical Characteristics

Part Number	Inductance (μ H)	Tolerance (\pm %)	Test Frequency (KHz)	RDC (m Ω) Max	Isat (A) Max	Irms (A) Max	Marking
CPUS0807MN-R30M-N	0.30	20	100	2.7	27	16	R30
CPUS0807MN-R47M-N	0.47	20	100	3.1	25	15	R47
CPUS0807MN-R56M-N	0.56	20	100	3.1	20	15	R56
CPUS0807MN-R68M-N	0.68	20	100	3.1	17	15	R68
CPUS0807MN-1R0M-N	1.0	20	100	4.3	15	13	1R0
CPUS0807MN-1R5M-N	1.5	20	100	6.2	11	10	1R5
CPUS0807MN-2R2M-N	2.2	20	100	6.2	8	10	2R2
CPUS0807MN-3R3M-N	3.3	20	100	9.0	5	8	3R3
CPUS1009MN-R22M-N	0.22	20	100	1.60	55	22	R22
CPUS1009MN-R33M-N	0.33	20	100	1.60	42	22	R33
CPUS1009MN-R47M-N	0.47	20	100	1.85	36	20	R47
CPUS1009MN-R56M-N	0.56	20	100	1.85	32	20	R56
CPUS1009MN-R68M-N	0.68	20	100	2.65	28	17	R68
CPUS1009MN-R82M-N	0.82	20	100	2.65	24	17	R82
CPUS1009MN-1R0M-N	1.0	20	100	2.65	21	17	1R0
CPUS1009MN-1R5M-N	1.5	20	100	4.00	17	13.5	1R5
CPUS1009MN-2R2M-N	2.2	20	100	5.30	14	12	2R2
CPUS1009MN-3R3M-N	3.3	20	100	7.70	10	11	3R3
CPUS1009MN-4R7M-N	4.7	20	100	10.8	8.5	10	4R7
CPUS1009MN-6R8M-N	6.8	20	100	16.9	7.0	9	6R8
CPUS1009MN-8R2M-N	8.2	20	100	16.9	6.0	9	8R2
CPUS1009MN-100M-N	10	20	100	26.0	5.0	7	100
CPUS1210MN-R22M-N	0.22	20	100	1.5	55	37	R22
CPUS1210MN-R33M-N	0.33	20	100	1.5	45	37	R33
CPUS1210MN-R47M-N	0.47	20	100	1.8	45	35	R47
CPUS1210MN-R56M-N	0.56	20	100	1.8	35	35	R56
CPUS1210MN-R68M-N	0.68	20	100	1.8	33	35	R68
CPUS1210MN-R82M-N	0.82	20	100	2.4	31	30	R82
CPUS1210MN-1R0M-N	1.0	20	100	2.4	28	30	1R0
CPUS1210MN-1R5M-N	1.5	20	100	3.5	24	25	1R5
CPUS1210MN-2R2M-N	2.2	20	100	4.7	18	21	2R2
CPUS1210MN-3R3M-N	3.3	20	100	6.3	14	15	3R3
CPUS1210MN-4R7M-N	4.7	20	100	8.8	11	12	4R7
CPUS1210MN-6R8M-N	6.8	20	100	12.5	9	10	6R8
CPUS1210MN-8R2M-N	8.2	20	100	13.0	7	9	8R2
CPUS1210MN-100M-N	10	20	100	18.7	6	8	100

Note: When ordering, please specify tolerance code. Tolerance: M= \pm 20%

- Operating temperature range - 40°C ~ 125°C(Including self - temperature rise)
- Isat for Inductance drop 20% from its value without current
- I rms for a 40°C temperature rise from 25°C ambient with current
- Measure Equipment :
L : WK4237METER
RDC : HK502BC METER
Isat & I rms : WK3260B/ 3265B METER

Please be sure to request approval specifications that provide further details of the products. Kindly note that the content of these specifications are subject to change or may be discontinued without advance notice. Please contact our sales department before ordering.

Packaging Specifications

Tape Dimensions

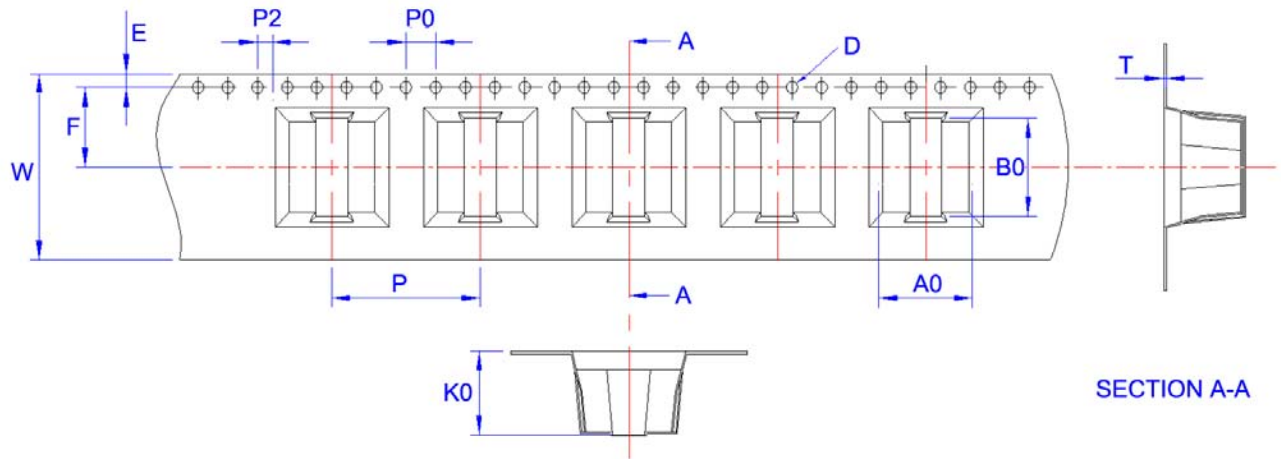

Reel Dimensions

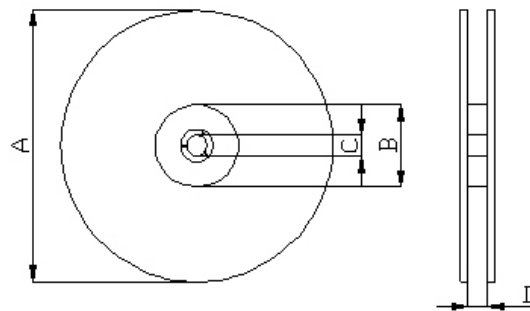

Dimensions in mm

TYPE	Tape Dimensions										Reel Dimensions				Quantity
	A0	B0	K0	D	E	W	T	P	P0	P2	A	B	C	D	PCS / REEL
CPUS0807MN	8.25	9.0	7.4	1.5	1.75	24	0.4	16	4	2	330	75	13.5	24	500
CPUS1009MN	10.4	11.3	9.8	1.5	1.75	24	0.4	16	4	2	330	75	13.5	24	400
CPUS1210MN	11.8	12.6	10.55	1.5	1.75	24	0.5	20	4	2	330	75	13.5	24	300

SFP Series



Features

- High current carrying capacity
- Flat wire windings provide exceptionally low DCR

Applications

- High current, low voltage power supply applications
- Audio boost circuit

Product Identification

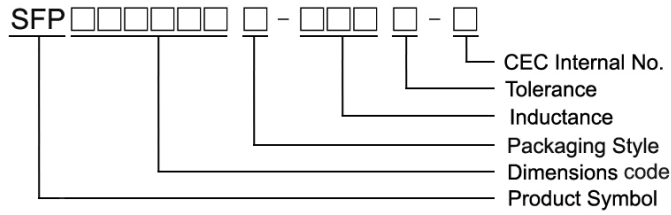

Shape and Dimensions

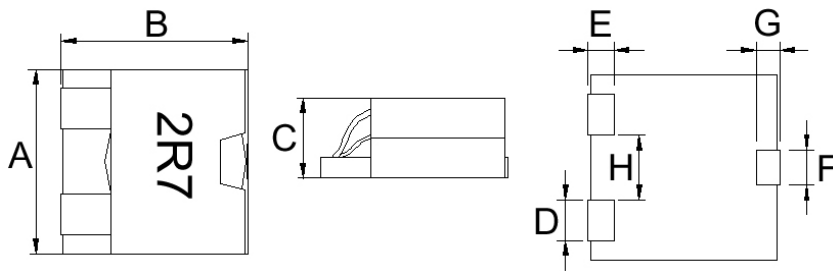

Dimensions in mm

TYPE	A	B	C	D	E	F	G	H
SFP131306	12.6±0.3	12.7±0.3	5.45±0.35	2.6±0.2	2.0±0.2	2.5±0.2	1.6±0.2	4.3±0.2

Recommended Pattern

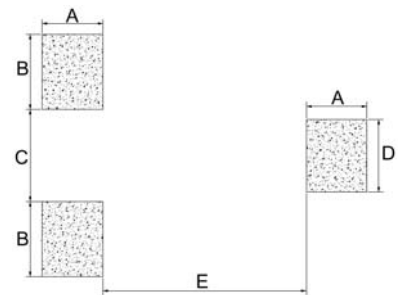

Dimensions in mm

TYPE	A	B	C	D	E
SFP131306	2.5	3.1	3.8	3.0	8.4

Electrical Characteristics

Part Number	Inductance (μ H)	Tolerance (\pm %)	Frequency (kHz)	SRF	RDC	Isat 1	Isat 2	Isat 3	Irms 1 (A)	Irms 2 (A)	Marking
				(MHz) Typ.	(m Ω) Max	(A) Max(Typ)	(A) Max(Typ)	(A) Max(Typ)			
SFP131306T-1R0K-N	1.0	10	100	75	2.6	25(32)	26(33)	27(33.5)	9.5	13	1R0
SFP131306T-1R8K-N	1.8	10	100	50	2.6	14(17)	16(19)	16.5(20)	9.5	13	1R8
SFP131306T-2R7K-N	2.7	10	100	42	2.6	9(12)	10(13)	11(14)	10	13.5	2R7

Note: When ordering, please specify tolerance code. Tolerance: M= \pm 20%

- Operating temperature range - 40°C ~ 125°C(Including self - temperature rise)
- Isat 1 for Inductance drop 10%
- Isat 2 for Inductance drop 20%
- Isat 3 for Inductance drop 30%
- Irms 1 for a 20°C temperature rise from 25°C ambient with current
- Irms 2 for a 40°C temperature rise from 25°C ambient with current
- Measure Equipment :
 L : E4980 or HP4284A , 100kHz/ 0.1V
 RDC : Chroma 16502
 Isat : HP4284A+HP42841A or WK3260B+WK3265B

Test Instruments : HP4294A Impedance / Material Analyzer

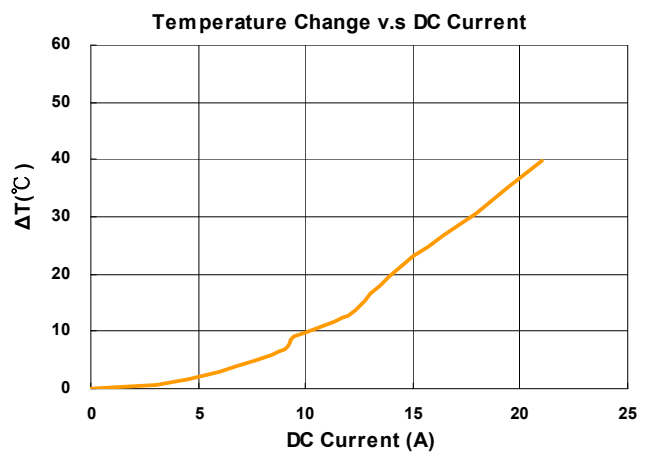
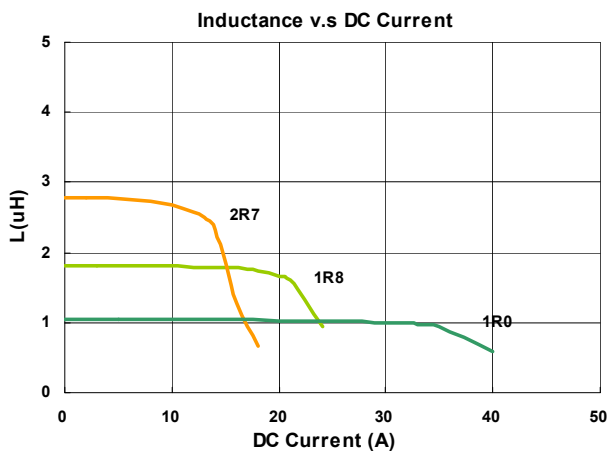

Packaging Specifications

Tape Dimensions

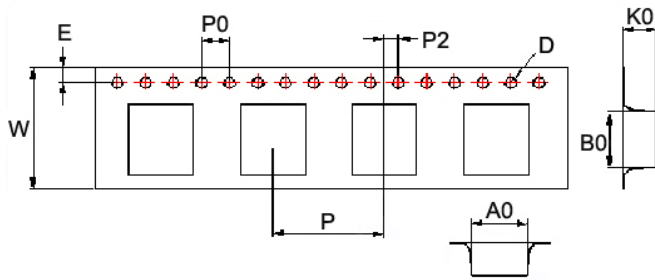

Tape Material

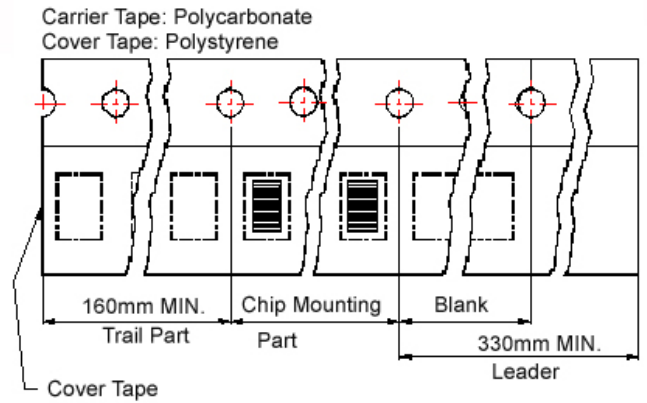

Reel Dimensions

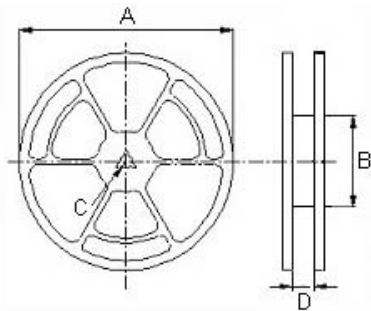

Dimensions in mm

TYPE	Tape Dimensions									Reel Dimensions				Quantity
	A0	B0	K0	D	E	W	P	P0	P2	A	B	C	D	PCS / REEL
SFP131306	13.1	13.2	6.4	1.55	1.75	24	16	4	2	330	100	13	24.4	500

Standard Specifications

Stamp	Inductance (μH)	RDC (mΩ) Max								
		SCDS 2D11	SCDS 2D14	SCDS 2D18LD	SCDS 2D18HP	SCDS 3D11	SCDS 3D11HP	SCDS 3D16	SCDS 3D28	SCDS 3D28LD
R47	0.47		40							
R60	0.6						59			
1R0	1.0							40	45	
1R2	1.2						82			
1R5	1.5	68	63		44		104	52		
1R7	1.7				44					
1R8	1.8		75							
2R2	2.2	98	94	41	60		143	72		
2R7	2.7		106			78				
3R3	3.3	123	125	54	86		182	85	72.1	
3R9	3.9	160	138							
4R1	4.1		169							
4R7	4.7	170	169	78	140	123	234	105	88.3	
5R6	5.6		188					135		
6R3	6.3				160					
6R8	6.8	260	213	106	195	180	377	170	119	
8R2	8.2		281			204		210		
100	10	400	294	180	245	240	413	210	145	95
120	12		394			276	585			100
150	15	600		220	345	372	653	295	213	115
180	18					468	888			125
220	22	950		320	650	540	1010	430	335	145
270	27					726				175
330	33			460		822		675	481	215
390	39			600		942				225
470	47			660					599	305
560	56									325
680	68									470
820	82									540
101	100							2750		610
121	120									755
151	150									880
181	180									1130
221	220									1270

Note: When ordering, please specify tolerance code. Tolerance: M=±20% , T=±30% , N = ⁺⁴⁰/₋₂₀%

- Operating temperature range - 30°C ~ 100°C(Including self - temperature rise)
- Rated Current : DC current that will cause L drop approximately 35% over its nominal value or DC current cause the temperature rising approximately Δt=40°C, whichever is lower
- Irms for a 40°C temperature rise from 25°C ambient with current
- Measure Equipment :
 Test Freq L : SCDS 2D11/ 2D14/ 2D18LP/2D18HP/3D11/3D11HP/3D28/3D28LD (100kHz/ 1V), SCDS 3D16 (100kHz/ 0.1V)
 L : Agilent/ E4980 or HP4284A
 RDC : Chroma 16502
 Rated Current : HP4284+42841A or WK3260B+WK3265B

Please be sure to request approval specifications that provide further details of the products. Kindly note that the content of these specifications are subject to change or may be discontinued without advance notice. Please contact our sales department before ordering.

Standard Specifications

Stamp	Inductance (μH)	Rated Current (A)								
		SCDS 2D11	SCDS 2D14	SCDS 2D18LD	SCDS 2D18HP	SCDS 3D11	SCDS 3D11HP	SCDS 3D16	SCDS 3D28	SCDS 3D28LD
R47	0.47		2.00							
R60	0.6						2.90			
1R0	1.0							1.60	2.80	
1R2	1.2						2.00			
1R5	1.5	0.90	1.80		1.90		1.85	1.55		
1R7	1.7				1.85					
1R8	1.8		1.65							
2R2	2.2	0.78	1.50	0.85	1.60		1.60	1.20		
2R7	2.7		1.35			0.53				
3R3	3.3	0.60	1.20	0.75	1.45		1.25	1.10	2.00	
3R9	3.9	0.60	1.10							
4R1	4.1		1.00							
4R7	4.7	0.50	1.00	0.63	1.20	0.40	1.00	0.90	1.65	
5R6	5.6		0.95					0.80		
6R3	6.3				1.05					
6R8	6.8	0.44	0.85	0.52	1.00	0.34	0.85	0.73	1.24	
8R2	8.2		0.80			0.32		0.55		
100	10	0.35	0.70	0.43	0.85	0.28	0.80	0.55	1.05	0.50
120	12		0.62			0.25	0.64			0.45
150	15	0.25		0.35	0.70	0.23	0.58	0.45	0.90	0.40
180	18					0.21	0.52			0.35
220	22	0.16		0.30	0.50	0.19	0.45	0.40	0.76	0.33
270	27					0.17				0.29
330	33			0.24		0.15		0.32	0.58	0.28
390	39			0.22		0.14				0.25
470	47			0.20					0.48	0.23
560	56									0.20
680	68									0.185
820	82									0.172
101	100							0.13		0.160
121	120									0.136
151	150									0.124
181	180									0.119
221	220									0.116

Tolerance Of Inductors

- SCDS 2D11 1.5 ~ 22uH ± 30%
- SCDS 2D14 0.47 ~ 12μH ± 30%
- SCDS 2D18LD 2.2 ~ 47μH ± 30%
- SCDS 2D18HP 1.5 ~ 22μH ± 30%
- Tolerance : M = ±20% , T = ±30% , N = ⁺⁴⁰/₋₂₀%
- SCDS3D11 2.7 ~ 39 uH ± 30%
- SCDS3D11HP 0.6 ~ 22 uH ± 30%
- SCDS3D16 1.0 ~ 100 uH ± 30%
- SCDS3D28 1.0 ~ 47 uH ± 30%
- SCDS3D28LD 10 ~ 220 uH ± 30%

Please be sure to request approval specifications that provide further details of the products. Kindly note that the content of these specifications are subject to change or may be discontinued without advance notice. Please contact our sales department before ordering.

Packaging Specifications

Tape Dimensions

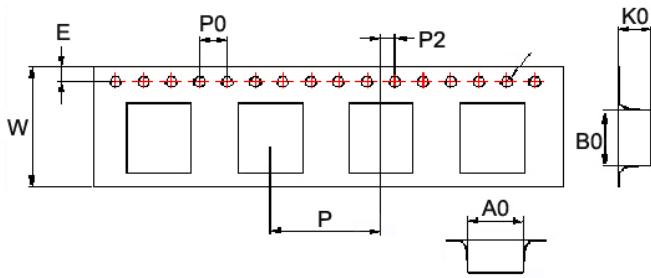

Tape Material

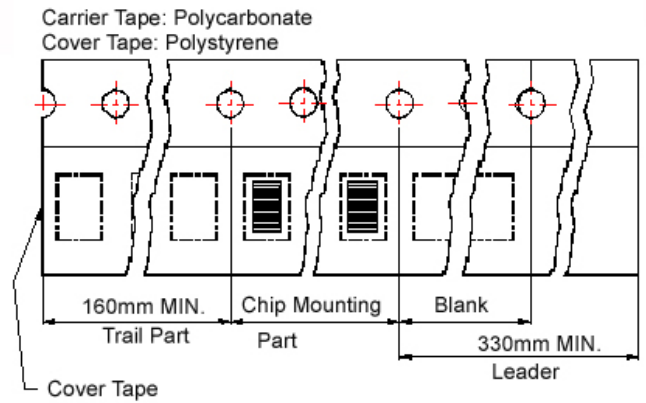

Reel Dimensions

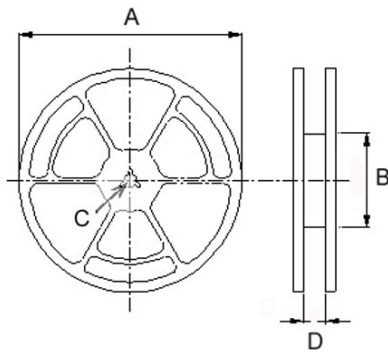

Dimensions in mm

TYPE	Tape Dimensions									Reel Dimensions				Quantity PCS / REEL
	A0	B0	K0	D	E	W	P	P0	P2	A	B	C	D	
SCDS 2D11	3.35	3.35	1.4	1.55	1.75	12	8	4	2	178	60	13	13.2	1000
SCDS 2D14	3.35	3.35	1.7	1.55	1.75	12	8	4	2	178	60	13	13.2	1000
SCDS 2D18	3.5	3.5	2.1	1.55	1.75	12	8	4	2	178	60	13	13.2	1000
SCDS 3D11	4.2	4.2	1.5	1.55	1.75	12	8	4	2	178	60	13	13.2	1000
SCDS 3D16	4.1	4.1	2.0	1.5	1.75	12	8	4	2	178	60	13	13.2	1000
SCDS 3D28	4.2	4.2	3.2	1.55	1.75	12	8	4	2	178	60	13	13.2	500

SCDS Series

Features

- RoHS, Halogen Free and REACH Compliance
- Magnetic shielded
- Various package size and wide inductance range

Applications

- AP Routers
- STBs
- LCD TVs and monitors
- Game consoles
- LED lightings
- DC/DC converters

Product Identification

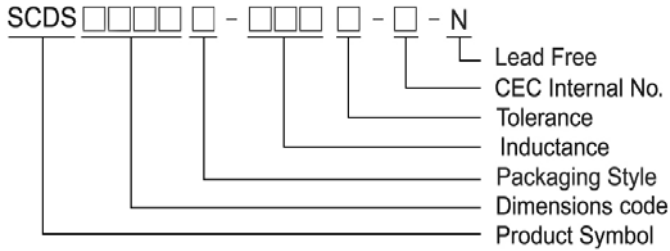

- T : Packaging: Tape and Reel
- CEC Internal No.: S: Base type terminals

SCDS 3D16T-XXXX-S-N

Shape and Dimensions

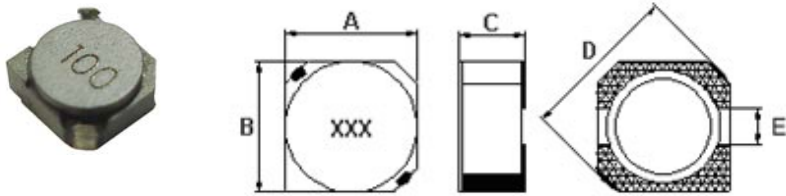

Recommended Pattern

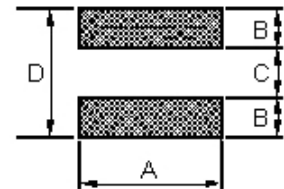

Dimensions in mm						Dimension in mm				
TYPE	A	B	C	D	E	TYPE	A	B	C	D
SCDS3D16	4 ⁺⁰	4 ⁺⁰	1.8 ⁺⁰	5.2 ⁺⁰	1.0	SCDS3D16	4.6	1.6	1.4	4.6

SCDS 4D18 ~ 6D38

Shape and Dimensions

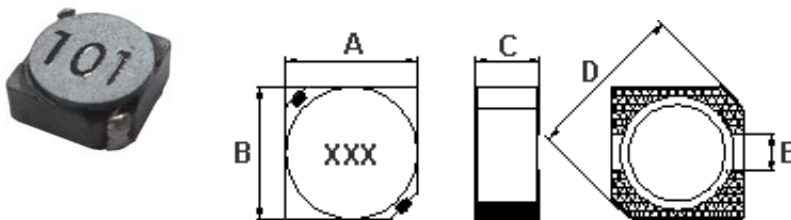

Recommended Pattern

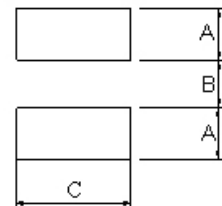

Dimension in mm						Dimension in mm			
TYPE	A	B	C	D	E	TYPE	A	B	C
SCDS4D18	4.7 ± 0.3	4.7 ± 0.3	2.0 ⁺⁰	6.9 ⁺⁰	1.5	SCDS4D18	1.9	1.5	5.3
SCDS4D28	4.7 ± 0.3	4.7 ± 0.3	3.0 ⁺⁰	6.9 ⁺⁰	1.5	SCDS4D28	1.9	1.5	5.3
SCDS4D40	4.7 ± 0.3	4.7 ± 0.3	4 ⁺⁰	6.9 ⁺⁰	1.5	SCDS4D40	1.9	1.5	5.3
SCDS5D18	5.7 ± 0.3	5.7 ± 0.3	2.0 ⁺⁰	8.2 ⁺⁰	2.0	SCDS5D18	2.15	2.0	6.3
SCDS5D28	5.7 ± 0.3	5.7 ± 0.3	3.0 ⁺⁰	8.2 ⁺⁰	2.0	SCDS5D28	2.15	2.0	6.3
SCDS6D28	6.7 ± 0.3	6.7 ± 0.3	3.0 ⁺⁰	9.5 ⁺⁰	2.0	SCDS6D28	2.65	2.0	7.3
SCDS6D38	7 ⁺⁰	7 ⁺⁰	4 ⁺⁰	9.5 ⁺⁰	2.0	SCDS6D38	2.65	2.0	7.3

Standard Specifications

Stamp	Inductance (μ H)	RDC (m Ω) Max								Rated Current (A)							
		SCDS	SCDS	SCDS	SCDS	SCDS	SCDS	SCDS	SCDS	SCDS	SCDS	SCDS	SCDS	SCDS	SCDS	SCDS	SCDS
		3D16	4D18	4D28	4D40	5D18	5D28	6D28	6D38	3D16	4D18	4D28	4D40	5D18	5D28	6D28	6D38
1R0	1.0		45			38	15	24			1.72			2.80	3.50	3.50	
1R2	1.2			23.6								2.56					
1R5	1.5	52	60			38	15	19.5		1.55	1.50			2.50	3.00	3.40	
1R8	1.8		70	27.5							1.35	2.20					
2R0	2.0			29.0		45						2.10		2.50			
2R2	2.2	72	75	31.3	22	48	18	35	18	1.20	1.32	2.04	4.6	1.90	2.60	3.00	3.80
2R5	2.5						18								2.60		
2R6	2.6						22								2.40		
2R7	2.7		105	43.3					20		1.28	1.60					3.60
3R0	3.0						24	24							2.40	3.00	
3R3	3.3	85	110	49.2	33	56	27	25	20	1.10	1.04	1.57	3.4	1.90	2.10	3.00	3.50
3R6	3.6	90								0.95							
3R9	3.9		155	64.8				27			0.88	1.44				2.60	
4R1	4.1					57								1.95			
4R2	4.2						31								2.20		
4R3	4.3						41								2.5Typ		
4R7	4.7	105	162	72.0	44	76	38	31	22	0.90	0.84	1.32	2.8	1.60	1.90	2.40	3.10
5R0	5.0						38	31	24						1.90	2.40	2.90
5R3	5.3						38								1.90		
5R4	5.4					76								1.60			
5R6	5.6		170	100.9					27		0.80	1.17					2.50
6R0	6.0							35								2.25	
6R2	6.2					96	45	51	27					1.40	1.80	2.40	2.50
6R3	6.3		180								0.78						
6R8	6.8	170	200	108.9	46	100	50	50	31	0.73	0.76	1.12	2.6	1.35	1.65	2.15	2.30
7R3	7.3							54							2.10		
7R4	7.4								31								2.30
8R2	8.2		245	117.5			53				0.68	1.04			1.60		
8R6	8.6							58								1.85	
8R7	8.7								34								2.20
8R9	8.9					116								1.25			
100	10	210	280	128.3	150	124	65	65	38	0.55	0.61	1.00	1.8	1.20	1.30	1.70	2.00
120	12		320	131.6		153	76	70	53		0.56	0.84		1.10	1.20	1.55	1.70
150	15	295	360	149.0	210	196	103	84	57	0.45	0.50	0.76	1.6	0.97	1.10	1.40	1.60
180	18		400	166.0		210	110	95	92		0.48	0.72		0.85	1.00	1.32	1.50
220	22	430	480	235.0	270	290	122	128	96	0.40	0.41	0.70	1.4	0.80	0.90	1.20	1.30
270	27	620	570	261.0		330	175	142	109	0.35	0.35	0.58		0.75	0.85	1.05	1.20
330	33	675	694	331.3		386	189	165	124	0.32	0.32	0.56		0.65	0.75	0.97	1.10
390	39		800	383.7		520	212	210	138		0.30	0.50		0.57	0.70	0.86	1.00
470	47		950	587.0		595	250	238	150		0.28	0.48		0.54	0.62	0.80	0.95
560	56		1080	624.5		665	305	277	202		0.26	0.41		0.50	0.58	0.73	0.85
680	68	1700	1300	699.0		840	355	304	234	0.18	0.24	0.35		0.43	0.52	0.65	0.75
820	82			914.8		978	463	390	324			0.32		0.41	0.46	0.60	0.70
101	100		2000	1020		1200	520	535	358		0.20	0.29		0.36	0.42	0.54	0.65
121	120			1270								0.27					
151	150		2840	1350							0.15	0.24					
181	180			1540			1050					0.22				0.29	
221	220	5500		2000			1200			0.08		0.20				0.28	
331	330			3400			1700					0.19				0.19	
391	390			3560			1800					0.18				0.18	
471	470						2500									0.15	
561	560						3200		1800							0.12	0.22
681	680			5200								0.10					

Please be sure to request approval specifications that provide further details of the products. Kindly note that the content of these specifications are subject to change or may be discontinued without advance notice. Please contact our sales department before ordering.

Note: When ordering, please specify tolerance code. Tolerance: M=±20% , T=±30% , N = ⁺⁴⁰/₋₂₀%

- Operating temperature range - 30°C ~ 100°C(Including self - temperature rise)
- Rated Current : DC current that will cause L drop approximately 35% over its nominal value or DC current cause the temperature rising approximately $\Delta t=40^{\circ}\text{C}$, whichever is lower
- Measure Equipment :
 Test Freq L : SCDS 3D16(100kHz/ 0.1V) , 4D28/ 4D40 (100kHz/ 1V) , SCDS 5D18/ 5D28/ 6D28/ 6D38 (10kHz/ 1V)
 SCDS 4D18: 1.0~8.2 μH (7.96MHz/ 1V), 10~150 μH (100kHz/ 1V)
 L : Agilent/ E4980 or HP4284A
 RDC : Chroma 16502
 Rated Current : HP4284+42841A or WK3260B+WK3265B

Tolerance Of Inductors

- SCDS 3D16 1.5 ~ 220 μH ± 30%
- SCDS 4D18 1.0 ~ 150 μH ± 30%
- SCDS 4D28 1.2 ~ 680 μH ± 30%
- SCDS 4D40 2.2 ~ 22 μH ± 30%
- Tolerance : M = ±20% , T = ±30% , N = ⁺⁴⁰/₋₂₀%
- SCDS 5D18 1.0 ~ 100 μH ± 30%
- SCDS 5D28 1.0 ~ 560 μH ± 30%
- SCDS 6D28 1.0 ~ 100 μH ± 30%
- SCDS 6D38 2.2 ~ 560 μH ± 30%

Packaging Specifications

Tape Dimensions

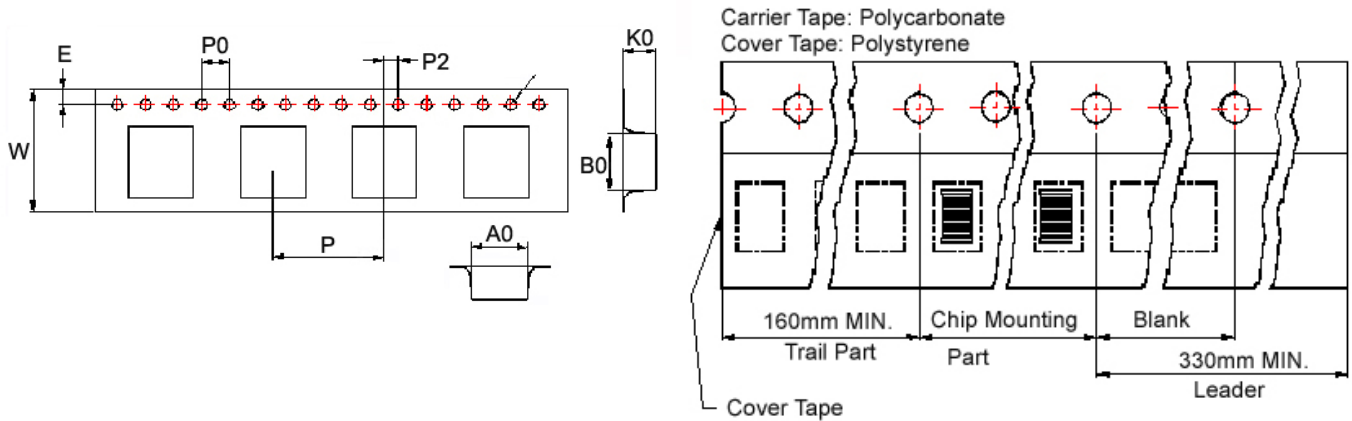

Reel Dimensions

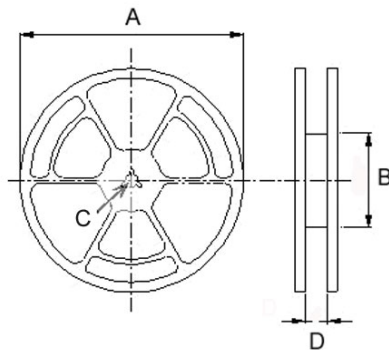

Dimensions in mm

TYPE	Tape Dimensions									Reel Dimensions				Quantity
	A0	B0	K0	D	E	W	P	P0	P2	A	B	C	D	PCS / REEL
SCDS 3D16	4.1	4.1	2.0	1.5	1.75	12	8	4	2	178	60	13	13.2	1000
SCDS 4D18	5.3	5.3	2.4	1.5	1.75	12	8	4	2	330	100	13	13.4	2000
SCDS 4D28	5.3	5.3	3.4	1.5	1.75	12	8	4	2	330	100	13	13.4	2000
SCDS 4D40	5.35	5.35	4.1	1.55	1.75	12	8	4	2	330	100	13	13.4	1000
SCDS 5D18	6.2	6.2	2.2	1.5	1.75	12	8	4	2	330	100	13	13.4	2000
SCDS 5D28	6.2	6.2	3.2	1.5	1.75	12	8	4	2	330	100	13	13.4	2000
SCDS 6D28	7.25	7.25	3.35	1.55	1.75	16	12	4	2	330	100	13	16.0	1500
SCDS 6D38	7.1	7.1	4.1	1.55	1.75	16	12	4	2	330	100	13	16.0	1000

Please be sure to request approval specifications that provide further details of the products. Kindly note that the content of these specifications are subject to change or may be discontinued without advance notice. Please contact our sales department before ordering.

SCDS Series

Features

- RoHS, Halogen Free and REACH Compliance
- Magnetic shielded
- Various package size and wide inductance range

Applications

- AP Routers
- STBs
- LCD TVs and monitors
- Game consoles
- LED lightings
- DC/DC converters

Product Identification

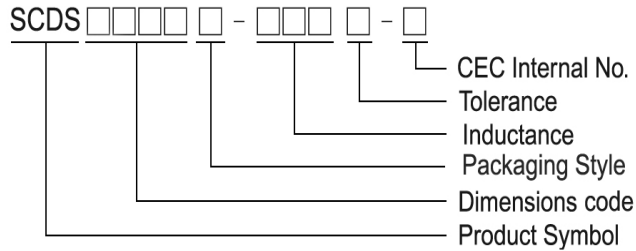

- T : Packaging: Tape and Reel

SCDS 73/ 74

Shape and Dimensions

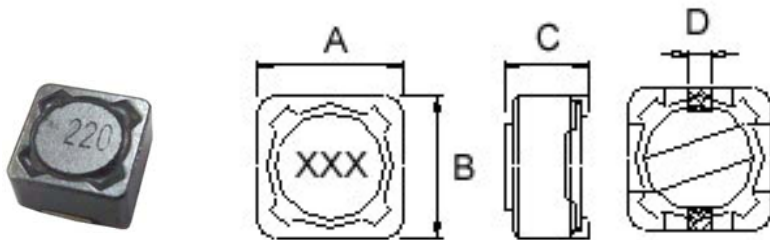

Dimension in mm

TYPE	A	B	C	D
SCDS73	7.3±0.2	7.3±0.2	3.4 ⁺⁰	1.8
SCDS74	7.3±0.2	7.3±0.2	4.5 ⁺⁰	1.8

Recommended Pattern

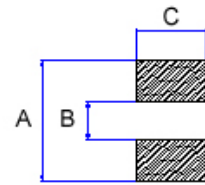

Dimension in mm

TYPE	A	B	C
SCDS73	8.4	4.4	2.2
SCDS74	8.4	4.4	2.2

SCDS 103R/ 104R/ 105R

Shape and Dimensions

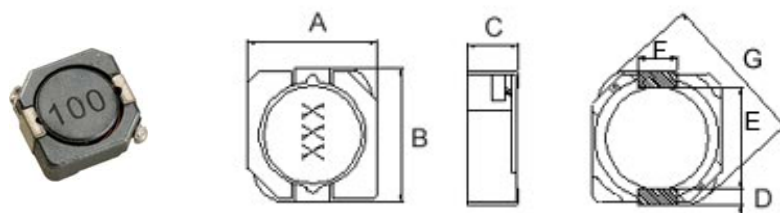

Dimensions in mm

TYPE	A	B	C	D	E	F	G
SCDS103R	10.3 ⁺⁰	10.5 ⁺⁰	3.1 ⁺⁰	1.2	7.7	3.0	13.5 ⁺⁰
SCDS104R	10.3 ⁺⁰	10.5 ⁺⁰	4 ⁺⁰	1.2	7.7	3.0	13.5 ⁺⁰
SCDS105R	10.3 ⁺⁰	10.5 ⁺⁰	5.1 ⁺⁰	1.2	7.7	3.0	13.5 ⁺⁰

Recommended Pattern

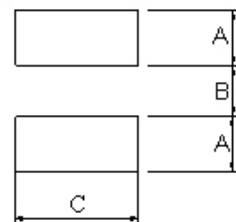

Dimension in mm

TYPE	A	B	C
SCDS103R	1.6	7.3	3.2
SCDS104R	1.6	7.3	3.2
SCDS105R	1.6	7.3	3.2

Standard Specifications

Stamp	Inductance (μH)	RDC (mΩ) Max							
		SCDS 73	SCDS 74	SCDS 103R	SCDS 104R	SCDS 105R	SCDS 124	SCDS 125	SCDS 127
R80	0.8					4.3			
1R0	1.0				7.5				
1R2	1.2								7.0
1R5	1.5	30	20		8.1	5.8			8.0
1R8	1.8		25		9.5				
2R2	2.2	30	25		10.5	11			11.5
2R4	2.4								11.5
2R5	2.5				10.5				
2R7	2.7		30						
3R3	3.3	40	35		13	10.4	15	15	13.5
3R5	3.5								13.5
3R8	3.8				13				
3R9	3.9						15		
4R7	4.7		35	30	18	12.3	18	18	15.8
5R2	5.2				22				
5R6	5.6				27				
6R1	6.1								17.6
6R4	6.4							18	
6R8	6.8	60	45	35	27	18	23		20.0
7R0	7.0				27				
7R6	7.6								20.0
8R2	8.2				33	20		25	
100	10	72	49	59	35	26	28	25	21.6
120	12	98	58			33	38	27	24.3
150	15	130	81	91	50	41	50	30	27.0
180	18	140	91		70	46	57	34	39.2
220	22	190	110		73	61	66	36	43.2
270	27	210	150		90	69	80	51	45.9
330	33	240	170	202	93	84	97	57	64.8
390	39	320	230		128	106	132	68	72.9
470	47	360	260	299	128	130	150	75	100
560	56	470	350		213	149	190	110	110
680	68	520	380		213	201	220	120	140
820	82	690	430		280	227	260	140	160
101	100	790	610		304	253	308	160	220
121	120	890	660			303	380	170	250
151	150	1270	880		506	370	530	230	280
181	180	1450	980			419	620	290	350
201	200				756				
221	220	1650	1170		756	500	700	400	390
271	270	2310	1640			672	876	460	560
331	330	2620	1860		1090	812	990	510	640
391	390	2940	2850			953		690	700
471	470	4180	3010		1600	1289		770	980
561	560	4670	3620			1430		860	1070
681	680	5730	4630			1599		1200	1460
821	820	6540	5200			1768		1340	1640
102	1000	9440	6000			1989		1530	1820

Note: When ordering, please specify tolerance code. Tolerance: M=±20% , T=±30% , N = +40% -20%

- Operating temperature range - 40°C ~ 105°C(Including self - temperature rise)
- Isat for Inductance drop 35% from its value without current
- Measure Equipment :
 L : Agilent/ E4980 or HP4284A (under 1MHz), HP4285A (over 1MHz)
 RDC : Chroma 16502
 Rated Current : HP4284+42841A or WK3260B+WK3265B

Please be sure to request approval specifications that provide further details of the products. Kindly note that the content of these specifications are subject to change or may be discontinued without advance notice. Please contact our sales department before ordering.

Standard Specifications

Stamp	Inductance (μH)	Isat (A)							
		SCDS 73	SCDS 74	SCDS 103R	SCDS 104R	SCDS 105R	SCDS 124	SCDS 125	SCDS 127
R80	0.8					13.5			
1R0	1.0				11				
1R2	1.2								9.80
1R5	1.5	4.00	5.00		10.	10.5			9.50
1R8	1.8		4.00		8.5				
2R2	2.2	4.00	3.50		7.5	9.25			8.00
2R4	2.4								8.00
2R5	2.5				7.5				
2R7	2.7		3.50						
3R3	3.3	3.70	3.50		6.0	7.8	6.50	8.00	7.50
3R5	3.5								7.50
3R8	3.8				6.0				
3R9	3.9						6.50		
4R7	4.7		3.00	4.65	5.7	6.40	5.70	7.60	6.80
5R2	5.2				5.5				
5R6	5.6				5.0				
6R1	6.1								6.60
6R4	6.4							5.8	
6R8	6.8	2.00	2.50	3.84	5.0	5.40	4.90		6.20
7R0	7.0				4.8				
7R6	7.6								5.90
8R2	8.2				4.5	4.85		5.00	
100	10	1.68	1.84	3.18	4.4	4.45	4.50	4.00	5.40
120	12	1.52	1.71			4.00	4.00	3.50	4.90
150	15	1.33	1.47	2.60	3.6	3.60	3.20	3.30	4.50
180	18	1.20	1.31		3.5	3.20	3.10	3.00	3.90
220	22	1.07	1.23		2.9	2.95	2.90	2.80	3.60
270	27	0.96	1.12		2.5	2.70	2.80	2.30	3.40
330	33	0.91	0.96	1.74	2.3	2.50	2.70	2.10	3.00
390	39	0.77	0.91		2.1	2.30	2.10	2.00	2.75
470	47	0.76	0.88	1.43	2.1	2.00	1.90	1.80	2.50
560	56	0.68	0.75		1.6	1.90	1.80	1.70	2.35
680	68	0.61	0.69		1.5	1.65	1.50	1.50	2.10
820	82	0.57	0.61		1.35	1.50	1.30	1.40	1.95
101	100	0.50	0.60		1.35	1.35	1.20	1.30	1.70
121	120	0.49	0.52			1.28	1.10	1.10	1.60
151	150	0.43	0.46		1.15	1.12	0.95	1.00	1.42
181	180	0.39	0.42			1.04	0.85	0.90	1.30
201	200				0.92				
221	220	0.35	0.36		0.92	0.94	0.80	0.80	1.16
271	270	0.32	0.34			0.84	0.60	0.75	1.06
331	330	0.28	0.32		0.70	0.75	0.50	0.68	0.95
391	390	0.26	0.29			0.70		0.65	0.88
471	470	0.24	0.26		0.50	0.60		0.58	0.79
561	560	0.22	0.23			0.54		0.54	0.73
681	680	0.19	0.22			0.52		0.48	0.67
821	820	0.18	0.20			0.50		0.43	0.60
102	1000	0.16	0.18			0.48		0.40	0.55

Tolerance Of Inductors

- SCDS 73 1.5 ~ 1000uH ± 20%
- SCDS 74 1.5 ~ 1000uH ± 20%
- SCDS 103R 4.7~47uH ± 30%
- SCDS 104R 1.0 ~ 470uH ± 30%
- SCDS 105R 0.8 ~ 1000uH ± 30%
- Tolerance : M = ±20% , T = ±30% , N = ⁺⁴⁰/₋₂₀%
- SCDS 124 3.3 ~ 330uH ±20%
- SCDS 125 3.3 ~ 1000uH ± 20%
- SCDS 127 1.2 ~ 7.6uH ⁺⁴⁰/₋₂₀%
- SCDS 127 10 ~ 1000uH ± 20%

Please be sure to request approval specifications that provide further details of the products. Kindly note that the content of these specifications are subject to change or may be discontinued without advance notice. Please contact our sales department before ordering.



Curves of SCDS Series

Test Instruments : HP4294 Impedance / Material Analyzer

SCDS73

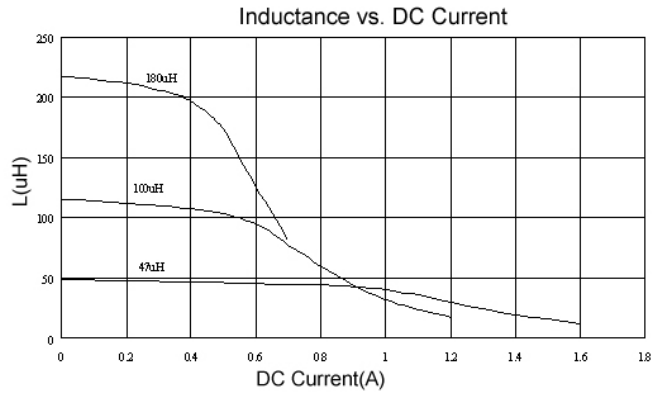
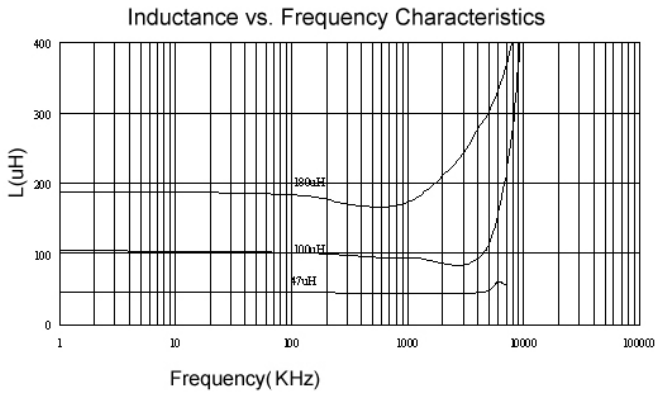

SCDS74

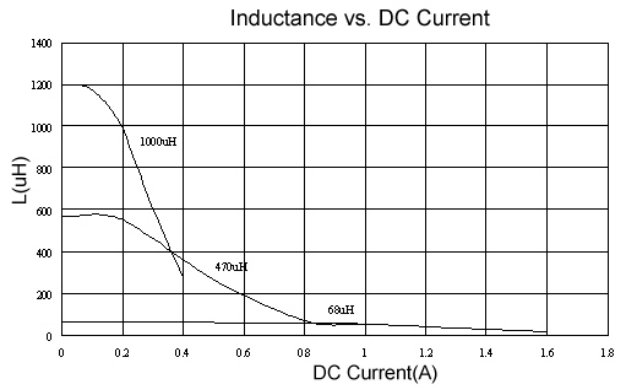
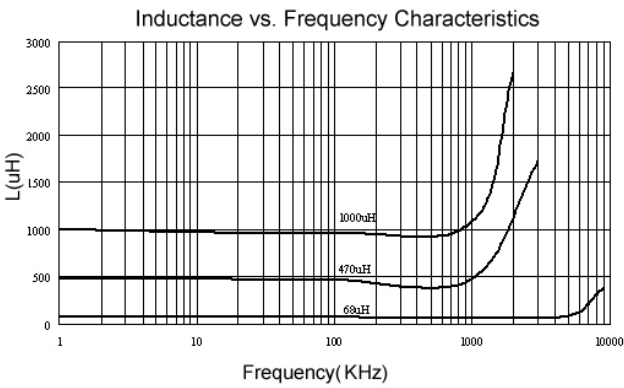

Test Instruments : HP4294 Impedance / Material Analyzer

SCDS104R

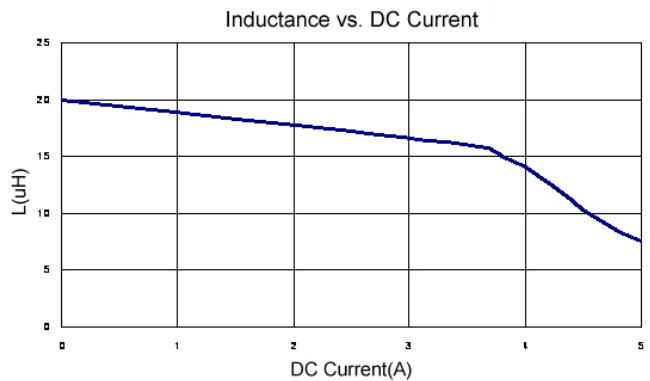
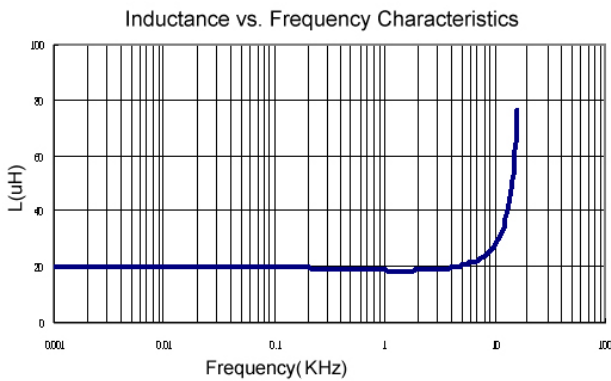

SCDS124

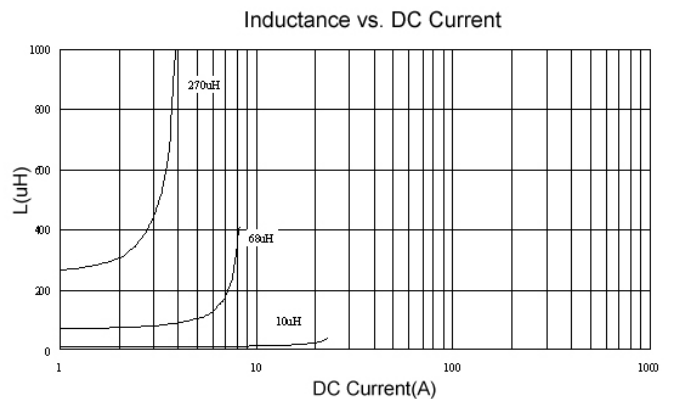
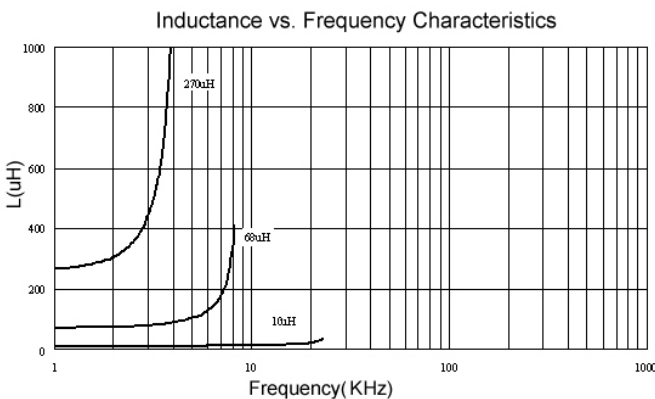

SCDS125

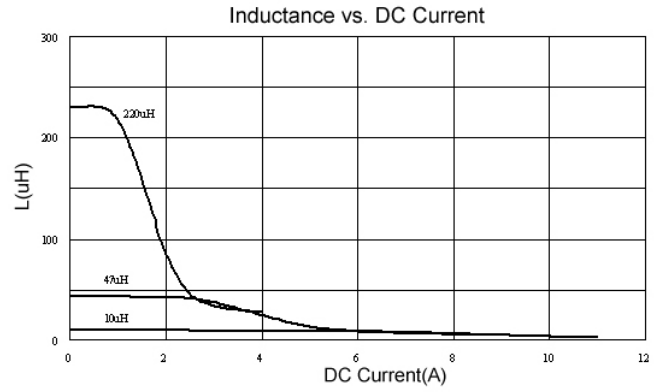
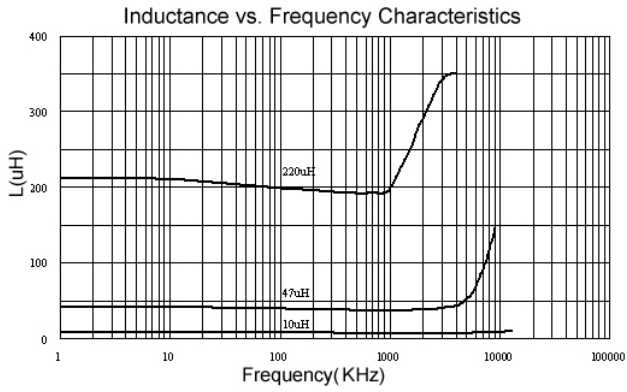

SCDS127

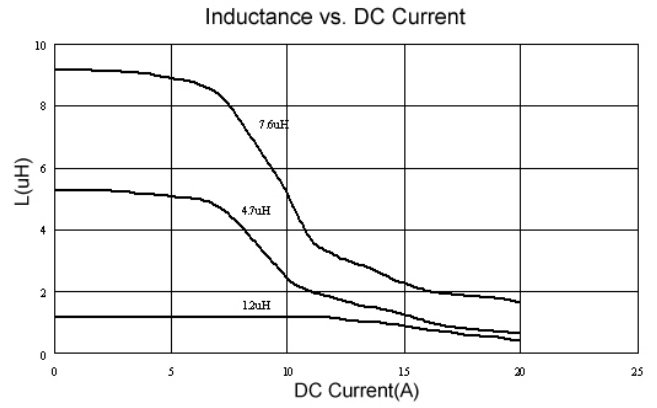
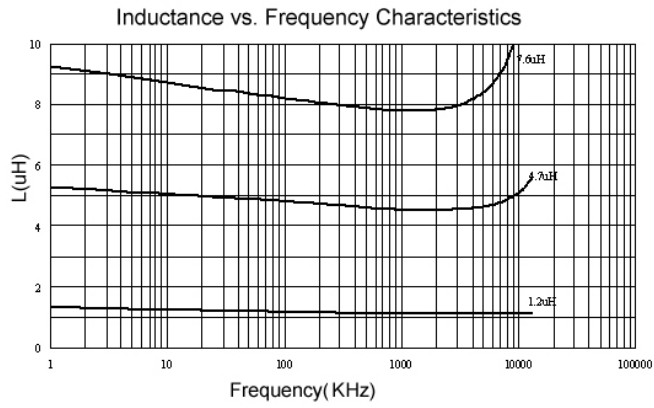

Packaging Specifications

Tape Dimensions

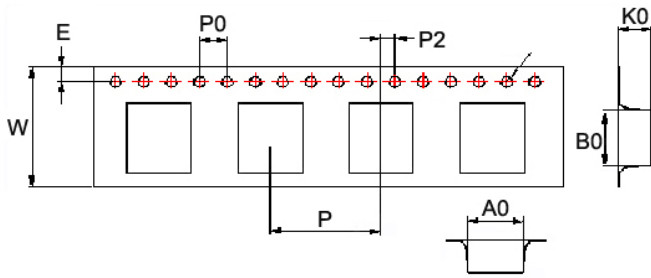

Tape Material

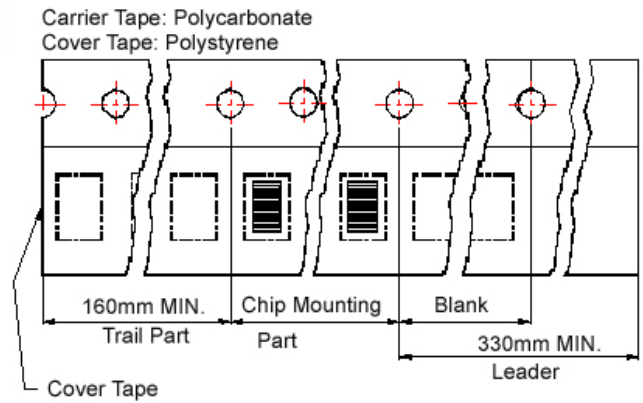

Reel Dimensions

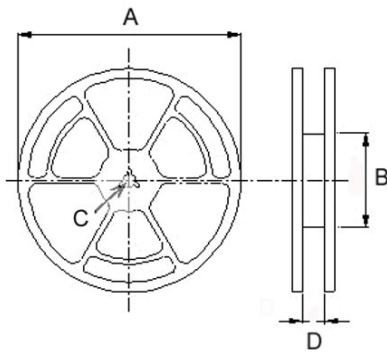

Dimensions in mm

TYPE	Tape Dimensions									Reel Dimensions				Quantity PCS / REEL
	A0	B0	K0	D	E	W	P	P0	P2	A	B	C	D	
SCDS 73	7.6	7.6	3.6	1.55	1.75	16	12	4	2	330	100	13	16.0	1600
SCDS 74	7.6	7.6	5.0	1.55	1.75	16	12	4	2	330	100	13	16.0	1000
SCDS 103R	10.6	10.75	4.2	1.55	1.75	24	16	4	2	300	100	13	24.4	1000
SCDS 104R	10.6	10.75	4.2	1.5	1.75	24	16	4	2	330	100	13	24.4	1000
SCDS 105R	10.6	10.6	5.0	1.5	1.75	24	16	4	2	330	100	13	24.4	500
SCDS 124	13.0	12.8	5.1	1.55	1.75	24	16	4	2	330	100	13	24.4	500
SCDS 125	12.6	12.6	6.7	1.55	1.75	24	16	4	2	330	100	13	24.4	600
SCDS 127	12.6	12.6	8.7	1.55	1.75	24	16	4	2	330	100	13	24.4	500

SCDS Series



Features

- RoHS, Halogen Free and REACH Compliance
- Magnetic shielded
- Various package size and wide inductance range

Applications

- AP Routers
- STBs
- LCD TVs and monitors
- Game consoles
- LED lightings
- DC/DC converters

Product Identification

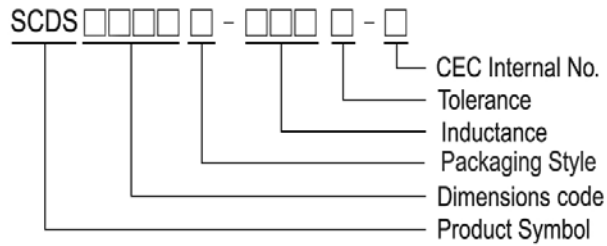

- T : Packaging: Tape and Reel

Shapes and Dimensions

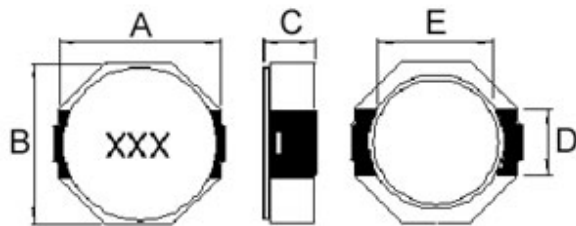

Recommended Pattern

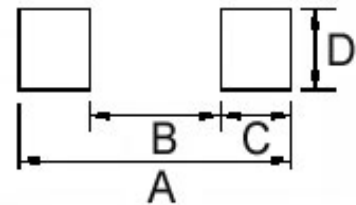

Dimension in mm

TYPE	A	B	C	D	E
SCDS8D43	8.3 ⁺⁰	8.3 ⁺⁰	4.5 ⁺⁰	2.5	6.3

Dimension in mm

TYPE	A	B	C	D
SCDS8D43	10.1	6.1	2.0	2.8

Electrical Characteristics

Part Number	Inductance (μH)	Test Frequency (kHz)	Tolerance ($\pm\%$)	RDC ($\text{m}\Omega$) Max	Rated Current (A)
SCDS8D43T-3R3□-N	3.3	100	30	19	5.7
SCDS8D43T-4R7□-N	4.7	100	30	22	5.6
SCDS8D43T-6R8□-N	6.8	100	30	25	4.4
SCDS8D43T-100□-N	10	100	30	36	4.0
SCDS8D43T-150□-N	15	100	30	53	2.9
SCDS8D43T-220□-N	22	100	30	75	2.4
SCDS8D43T-470□-N	47	100	30	150	1.8
SCDS8D43T-680□-N	68	100	30	240	1.5
SCDS8D43T-101□-N	100	100	30	353	1.1

Note: When ordering, please specify tolerance code. Tolerance: $T=\pm 30\%$

- Operating temperature range - 30°C ~ 100°C(Including self - temperature rise)
- Rated current for Inductance drop 35% from its value with current
- Measure Equipment :
 - L : HP4284A 100kHz/ 1V
 - RDC : Chroma 16502
 - Rated current : HP4284+42841A

Packaging Specifications

Tape Dimensions

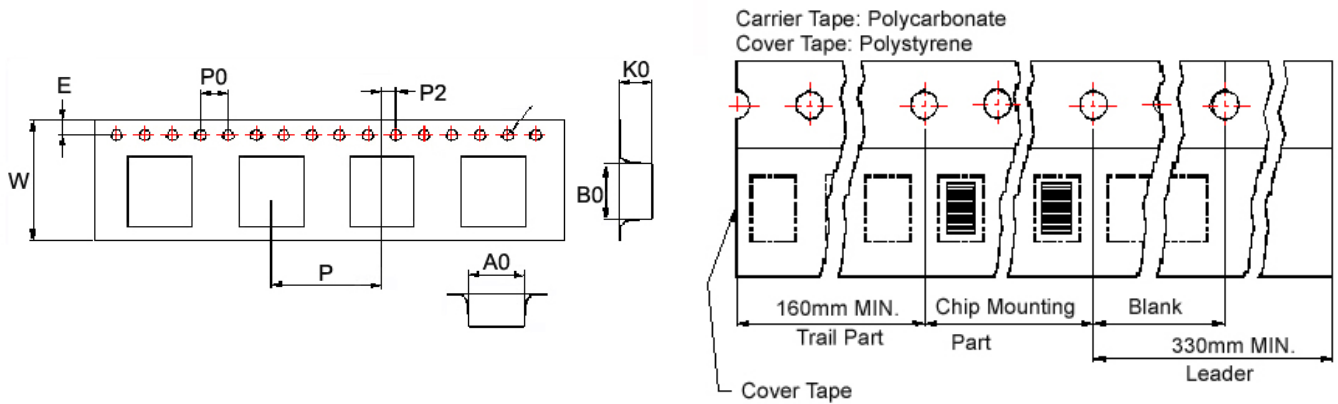

Reel Dimensions

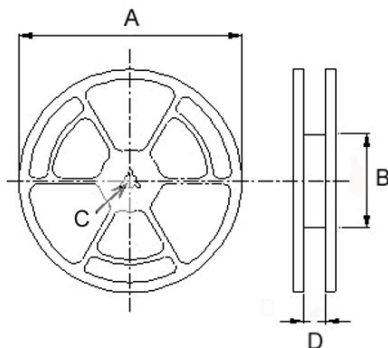

Dimensions in mm

TYPE	Tape Dimensions									Reel Dimensions				Quantity PCS / REEL
	A0	B0	K0	D	E	W	P	P0	P2	A	B	C	D	
SCDS 8D43	8.4	9.9	4.8	1.55	1.75	24	12	4	2	330	100	13	24.4	1000

Please be sure to request approval specifications that provide further details of the products. Kindly note that the content of these specifications are subject to change or may be discontinued without advance notice. Please contact our sales department before ordering.

SCPS Series

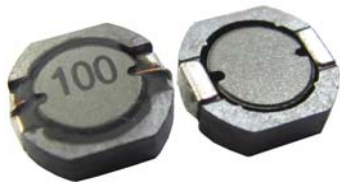

The SCPS Series is designed for low profile type with low RDC and large current. The magnetic shielding supports high – density mounting. This series also provides working – frequency up to 1MHz.

Features

- RoHS compliant
- Low Rdc and high saturation current for portable DC to DC converter line
- High magnetic shielding construction provides high resolution for EMC protection
- Support lead-free soldering

Applications

- Notebook PC
- Set top box
- LCD TV
- LCD displays
- Portable communication device
- DC/DC converters

Product Identification

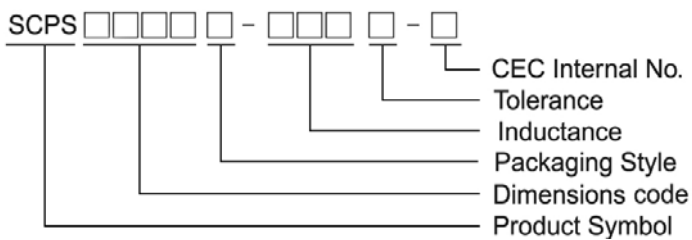

Shape and Dimensions

FIG 1

FIG 2

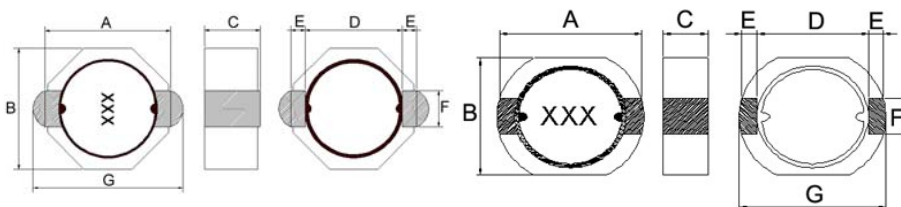

Recommended Pattern

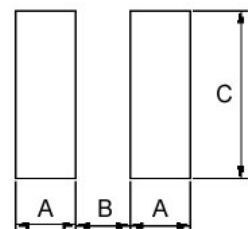

Dimensions in mm

TYPE	FIG	A	B	C	D	E	F	G
SCPS0522	1	5.2±0.3	5.0±0.3	2.2Max	4.0	0.6	1.5	6.2Max
SCPS0725	2	7.5±0.3	7.4±0.3	2.5Max	5.6	1.2	2.5	8.7Max
SCPS0740	2	7.5±0.3	7.4±0.3	4.0Max	5.6	1.2	2.5	9.2Max

Dimensions in mm

TYPE	A	B	C
SCPS0522	1.5	3.2	1.5
SCPS0725	1.5	5.4	2.8
SCPS0740	1.5	5.4	2.8

Standard Specifications

Part Number	Inductance (uH)	Tolerance (±%)	Test Frequency (kHz)	RDC (mΩ) Max	Isat (A)	Irms (A)
SCPS0522T-1R2□-N	1.2	30	100	25	4.3	3.43
SCPS0522T-1R8□-N	1.8	30	100	32	3.6	3.12
SCPS0522T-3R3□-N	3.3	30	100	54	2.5	2.68
SCPS0522T-4R7□-N	4.7	30	100	81	2.0	2.18
SCPS0522T-100□-N	10	20,30	100	160	1.4	1.51
SCPS0522T-220□-N	22	20,30	100	320	0.9	1.02
SCPS0522T-330□-N	33	20,30	100	490	0.77	0.80

Note: When ordering, please specify tolerance code. Tolerance: M=±20% , T=±30%

- Operating temperature range - 40°C ~ 105°C(Including self - temperature rise)
- Isat for Inductance drop 30% from its value without current
- Irms for a 40°C temperature rise from 25°C ambient with current
- Measure Equipment :
 L : HP4284A.+Aglient 16334A , 100kHz/ 1V
 RDC : Chroma 16502
 Isat : HP4284A+HP42841A or WK3260B+WK3265B
 Irms : Agilent 6641 SYSTEM DC POWER SUPPLY

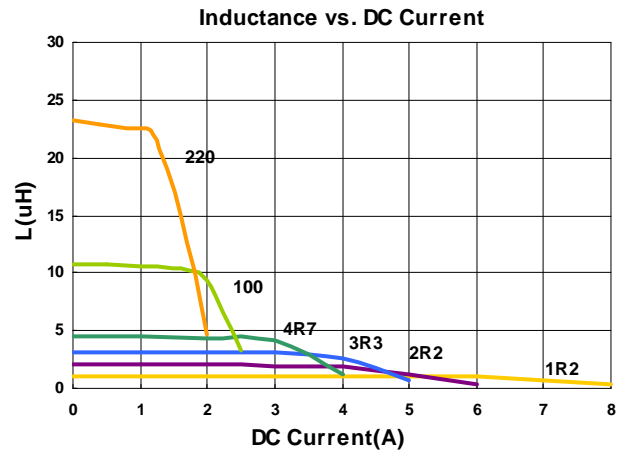
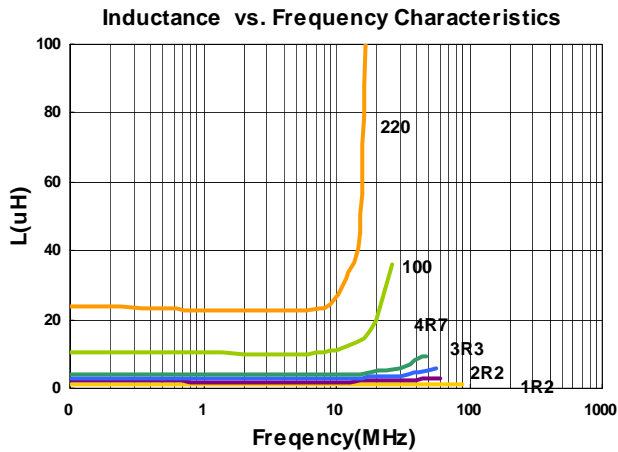

Please be sure to request approval specifications that provide further details of the products. Kindly note that the content of these specifications are subject to change or may be discontinued without advance notice. Please contact our sales department before ordering.

Standard Specifications

Part Number	Inductance (uH)	Tolerance (±%)	Test Frequency (kHz)	RDC (mΩ) Max	Isat (A)	Irms (A)
SCPS0725T-1R0□-N	1.0	30	100	14.28	8.3	6.22
SCPS0725T-1R5□-N	1.5	30	100	19.70	7.2	5.00
SCPS0725T-2R2□-N	2.2	30	100	24.09	5.4	4.40
SCPS0725T-3R3□-N	3.3	30	100	41.20	4.4	3.70
SCPS0725T-4R7□-N	4.7	30	100	49.70	4.0	3.20
SCPS0725T-5R6□-N	5.6	20,30	100	58.90	3.9	2.90
SCPS0725T-6R8□-N	6.8	20,30	100	66.30	3.5	2.70
SCPS0725T-100□-N	10	20,30	100	92.40	2.8	1.90
SCPS0725T-150□-N	15	20,30	100	170.0	2.3	1.70
SCPS0725T-220□-N	22	20,30	100	210.0	1.5	1.52
SCPS0725T-330□-N	33	20,30	100	320.0	1.4	1.10
SCPS0725T-470□-N	47	20,30	100	490.0	1.2	0.95

Note: When ordering, please specify tolerance code. Tolerance: M=±20% , T=±30%

- Operating temperature range - 40°C ~ 105°C(Including self - temperature rise)
- Isat for Inductance drop 30% from its value without current
- Irms for a 40°C temperature rise from 25°C ambient with current
- Measure Equipment :

L : HP4284A.+Aglient 16334A , 100kHz/ 1V

RDC : Chroma 16502

Isat : HP4284A+HP42841A or WK3260B+WK3265B

Irms : Agilent 6641 SYSTEM DC POWER SUPPLY

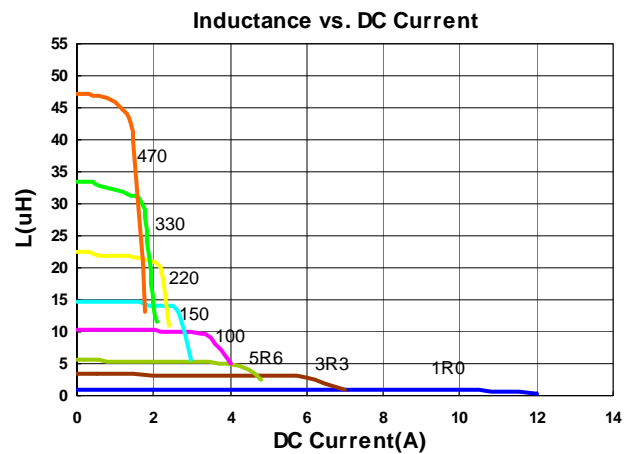
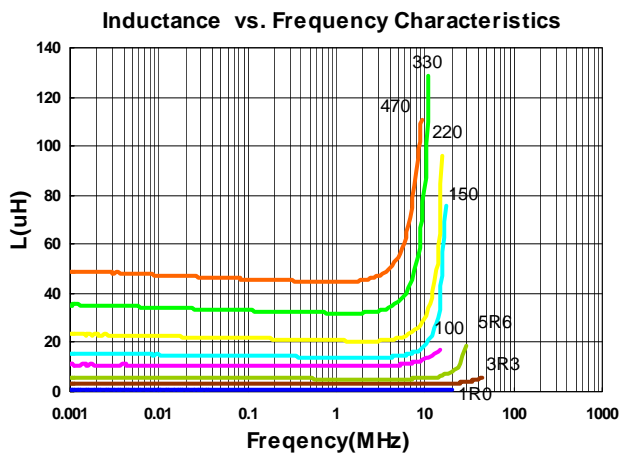

Please be sure to request approval specifications that provide further details of the products. Kindly note that the content of these specifications are subject to change or may be discontinued without advance notice. Please contact our sales department before ordering.

Standard Specifications

Part Number	Inductance (uH)	Tolerance (±%)	Test Frequency (kHz)	RDC (mΩ) Max	Isat (A)	Irms (A)
SCPS0740T-1R0□-N	1.0	30	100	6.38	12.0	9.00
SCPS0740T-1R5□-N	1.5	30	100	8.64	10.0	8.00
SCPS0740T-1R8□-N	1.8	30	100	9.60	8.60	7.92
SCPS0740T-2R5□-N	2.5	30	100	13.6	7.20	7.40
SCPS0740T-3R3□-N	3.3	30	100	17.8	6.80	6.70
SCPS0740T-4R7□-N	4.7	20,30	100	26.6	4.60	4.90
SCPS0740T-5R6□-N	5.6	20,30	100	29.0	4.10	4.60
SCPS0740T-6R8□-N	6.8	20,30	100	34.0	3.90	3.90
SCPS0740T-100□-N	10	20,30	100	55.6	3.40	3.25
SCPS0740T-150□-N	15	20,30	100	74.4	3.00	2.70
SCPS0740T-220□-N	22	20,30	100	98.1	2.40	2.40
SCPS0740T-330□-N	33	20,30	100	140	2.00	1.90
SCPS0740T-470□-N	47	20,30	100	217	1.70	1.48
SCPS0740T-560□-N	56	20,30	100	260	1.50	1.33
SCPS0740T-680□-N	68	20,30	100	310	1.36	1.20
SCPS0740T-820□-N	82	20,30	100	360	1.20	1.12
SCPS0740T-101□-N	100	20,30	100	480	1.12	0.95
SCPS0740T-121□-N	120	20,30	100	560	1.00	0.89
SCPS0740T-151□-N	150	20,30	100	710	0.92	0.82

Note: When ordering, please specify tolerance code. Tolerance: M=±20% , T=±30%

- Operating temperature range - 40°C ~ 105°C(Including self - temperature rise)
- Isat for Inductance drop 30% from its value without current
- I rms for a 40°C temperature rise from 25°C ambient with current
- Measure Equipment :
 L : HP4284A.+Aglient 16334A , 100kHz/ 1V
 RDC : Chroma 16502
 Isat : HP4284A+HP42841A or WK3260B+WK3265B
 I rms : Agilent 6641 SYSTEM DC POWER SUPPLY

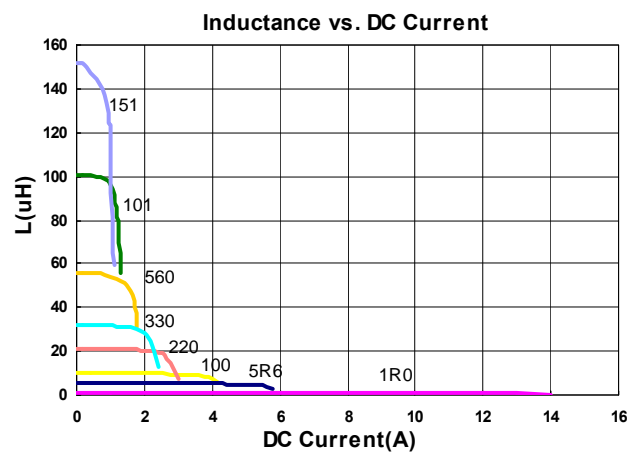
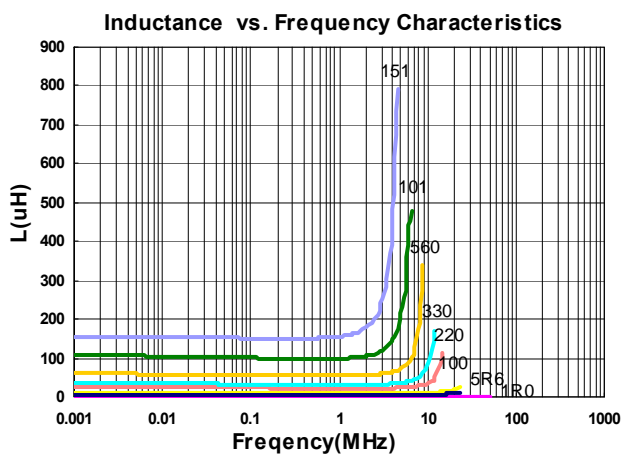

Please be sure to request approval specifications that provide further details of the products. Kindly note that the content of these specifications are subject to change or may be discontinued without advance notice. Please contact our sales department before ordering.

Packaging Specifications

Tape Dimensions

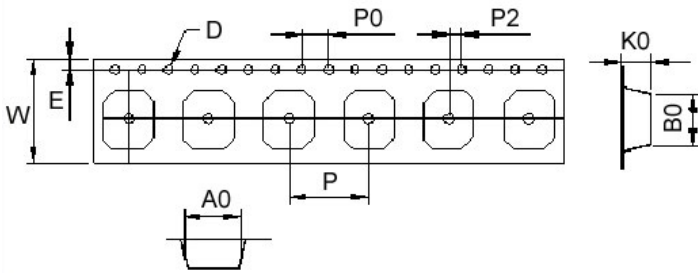

Tape Material

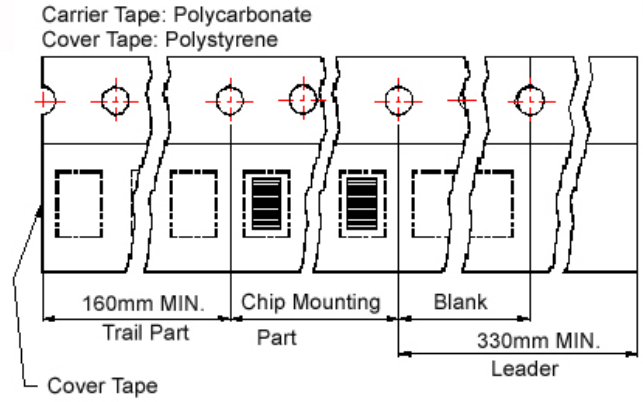

Reel Dimensions

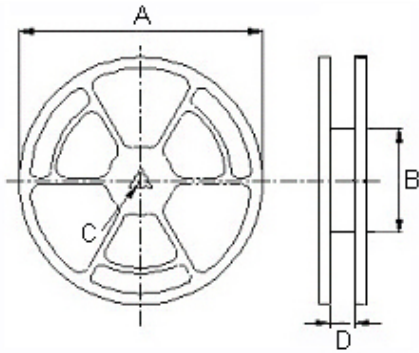

Dimensions in mm

TYPE	Tape Dimensions									Reel Dimensions				Quantity
	A0	B0	K0	D	E	W	P	P0	P2	A	B	C	D	PCS / REEL
SCPS0522	5.35	6.20	2.4	1.55	1.75	16	8	4	2	330	100	13	16	2000
SCPS0725	7.6	8.65	2.8	1.55	1.75	16	12	4	2	330	100	13	16	1500
SCPS0740	7.6	9.0	4.3	1.55	1.75	16	12	4	2	330	100	13	16	1000

SDS Series



Features

- RoHS, Halogen Free and REACH Compliance
- Magnetic shielded
- Good Q factor, good energy storage and low resistance

Applications

- Flash memory programmers
- Electric motors
- DC/DC converters

Product Identification

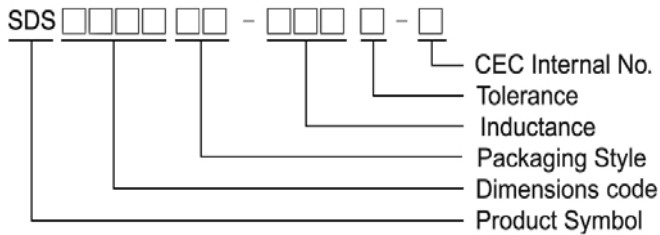

- Packaging: T: Tape and Reel

Shape and Dimensions

SDS0402

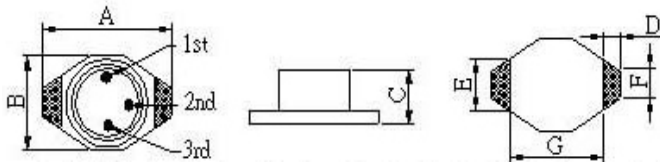

Dimensions in mm

TYPE	A	B	C	D	E	F	G
SDS0402	6.60 ⁺⁰	4.45 ⁺⁰	2.92 ⁺⁰	1.02	3.05	1.27	4.32

Recommended Pattern

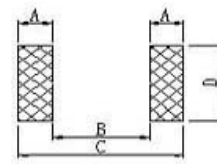

Dimensions in mm

TYPE	A	B	C	D
SDS0402	1.4	4.06	6.86	3.56

SDS0804

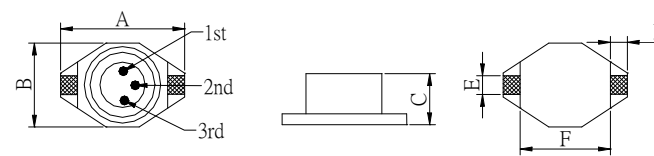

Dimensions in mm

TYPE	A	B	C	D	E	F
SDS0804	12.95 ⁺⁰	9.40 ⁺⁰	5.08 ⁺⁰	2.54	2.54	7.62

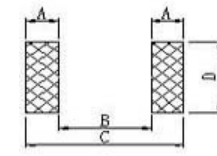

Dimensions in mm

TYPE	A	B	C	D
SDS0804	2.92	7.37	13.21	2.79

SDS1306

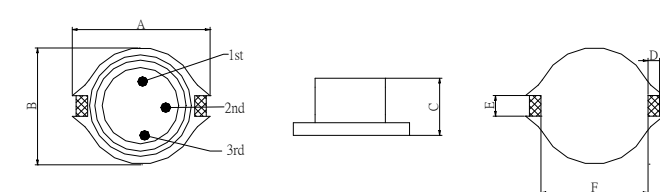

Dimensions in mm

TYPE	A	B	C	D	E	F
SDS1306	18.54 ⁺⁰	15.24 ⁺⁰	7.62 ⁺⁰	2.54	2.54	12.7

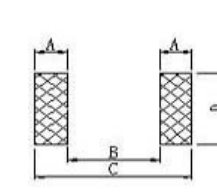

Dimensions in mm

TYPE	A	B	C	D
SDS1306	2.92	12.45	18.29	2.79

Electrical Characteristics

Part Number	Inductance (μH)	Tolerance (±%)	Q Min	Q Frequency (kHz)	DC Resistance (Ω) Max	SRF (MHz) Typ.	I _{rms} (A)
SDS0402T-1R0M-N	1.0	20	30	200	0.040	200	3.0
SDS0402T-1R5M-N	1.5	20	30	200	0.045	100	2.8
SDS0402T-2R2M-N	2.2	20	40	200	0.050	90	1.8
SDS0402T-3R3M-N	3.3	20	40	200	0.060	90	1.6
SDS0402T-4R7M-N	4.7	20	40	200	0.065	80	1.4
SDS0402T-6R8M-N	6.8	20	40	200	0.070	40	1.2
SDS0402T-100M-N	10	20	40	200	0.075	30	1.0
SDS0402T-150M-N	15	20	40	100	0.090	25	0.80
SDS0402T-220M-N	22	20	40	100	0.110	20	0.70
SDS0402T-330M-N	33	20	40	100	0.190	15	0.60
SDS0402T-470M-N	47	20	40	100	0.230	15	0.50
SDS0402T-680M-N	68	20	40	100	0.290	10	0.40
SDS0402T-101M-N	100	20	40	100	0.480	8	0.30
SDS0402T-151M-N	150	20	40	100	0.590	7	0.26
SDS0402T-221M-N	220	20	40	100	0.770	4	0.22
SDS0402T-331M-N	330	20	40	100	1.4	4	0.20
SDS0402T-471M-N	470	20	40	100	1.8	3	0.19
SDS0402T-681M-N	680	20	40	100	2.2	2	0.18
SDS0402T-102M-N	1000	20	40	100	3.4	1	0.15

Note: When ordering, please specify tolerance code. Tolerance: M=±20%

- Operating temperature range - 40°C ~ 125°C(Including self - temperature rise)
- Isat for Inductance drop 30% from its value without current
- I_{rms} for a 30°C temperature rise from 25°C ambient with current
- Measure Equipment :
 - L : E4980 or HP4284A , 100kHz/ 0.1V
 - RDC : Chroma 16502
 - Isat : HP4284A+HP42841A or WK3260B+WK3265B

Test Instruments : HP4294A Impedance / Material Analyzer

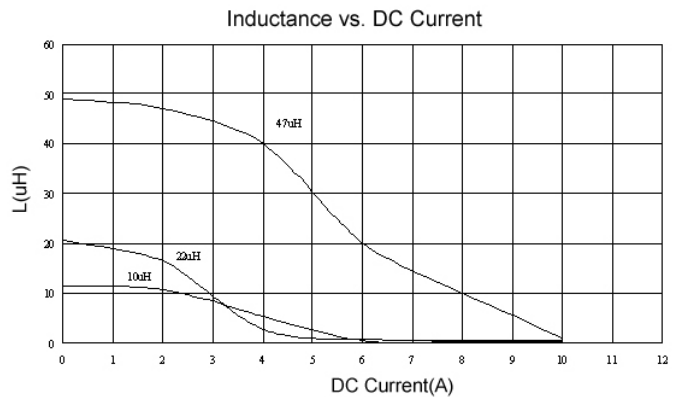
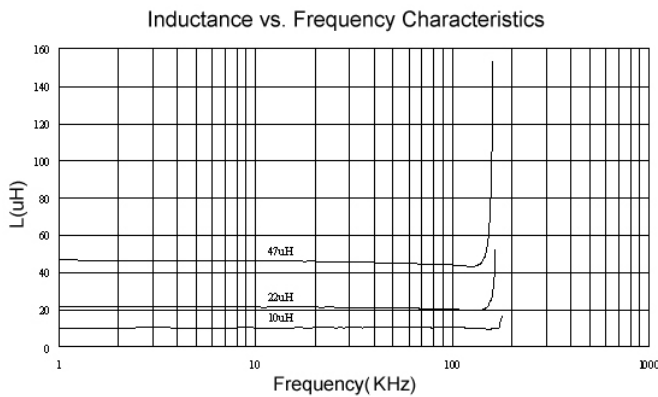

Please be sure to request approval specifications that provide further details of the products. Kindly note that the content of these specifications are subject to change or may be discontinued without advance notice. Please contact our sales department before ordering.

Electrical Characteristics

Part Number	Inductance (μH)	Tolerance (±%)	Q Min	Q Frequency (kHz)	DC Resistance (Ω) Max	SRF (MHz) Typ.	Isat (A)	Irms (A)
SDS0804T-1R0M-N	1.0	20	3	100	0.021	110	5.6	5.0
SDS0804T-1R5M-N	1.5	20	5	100	0.022	90	5.2	4.5
SDS0804T-2R2M-N	2.2	20	5	100	0.032	60	5.0	3.8
SDS0804T-3R3M-N	3.3	20	5	100	0.039	55	3.9	3.3
SDS0804T-4R7M-N	4.7	20	10	100	0.054	30	3.2	2.7
SDS0804T-6R8M-N	6.8	20	10	100	0.075	30	2.8	2.2
SDS0804T-100M-N	10	20	10	100	0.101	28	2.4	2.0
SDS0804T-150M-N	15	20	15	100	0.15	20	2.0	1.5
SDS0804T-220M-N	22	20	20	100	0.207	15	1.6	1.3
SDS0804T-330M-N	33	20	20	100	0.334	12	1.4	1.1
SDS0804T-470M-N	47	20	20	100	0.472	10	1.0	0.8
SDS0804T-680M-N	68	20			0.660	10	0.9	0.7
SDS0804T-101M-N	100	20			1.110	7	0.8	0.6
SDS0804T-151M-N	150	20			1.550	6	0.6	0.5
SDS0804T-221M-N	220	20			2.000	5	0.5	0.37
SDS0804T-102M-N	1000	20			8.300	2	0.32	0.17

Note: When ordering, please specify tolerance code. Tolerance: M=±20%

- Operating temperature range - 40°C ~ 125°C(Including self - temperature rise)
- Isat for Inductance drop 10% from its value without current
- I rms for a 40°C temperature rise from 25°C ambient with current
- Measure Equipment :
 L : E4980 or HP4284A , 100kHz/ 0.1V
 RDC : Chroma 16502
 Isat : HP4284A+HP42841A or WK3260B+WK3265B

Test Instruments : HP4294A Impedance / Material Analyzer

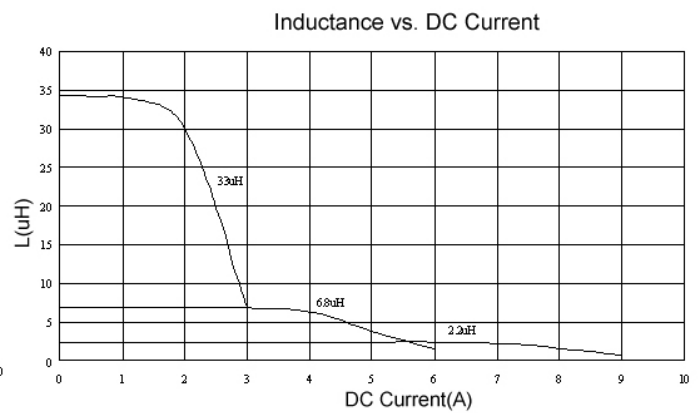
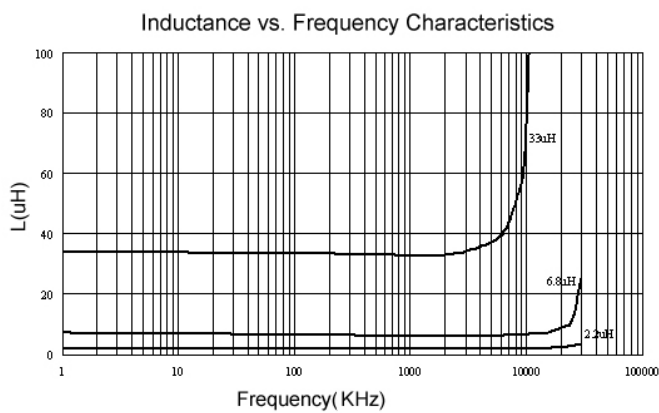

Please be sure to request approval specifications that provide further details of the products. Kindly note that the content of these specifications are subject to change or may be discontinued without advance notice. Please contact our sales department before ordering.

Electrical Characteristics

Part Number	Inductance (μH)	Tolerance (±%)	Q Min	Q Frequency (kHz)	DC Resistance (Ω) Max	Isat (A)	Irms (A)	SRF (MHz) Typ.
SDS1306T-100M-N	10	20	40	100	0.040	5.5	3.9	24
SDS1306T-150M-N	15	20	40	100	0.048	4.5	3.4	16
SDS1306T-220M-N	22	20	30	100	0.059	3.5	3.1	14
SDS1306T-330M-N	33	20	40	100	0.075	3.3	2.8	11
SDS1306T-470M-N	47	20	40	100	0.097	2.7	2.4	8.0
SDS1306T-680M-N	68	20	40	100	0.140	2.2	2.0	7.0
SDS1306T-101M-N	100	20	40	100	0.210	1.7	1.7	5.5
SDS1306T-151M-N	150	20	50	100	0.300	1.3	1.3	4.8
SDS1306T-221M-N	220	20	50	100	0.470	1.1	1.1	4.0
SDS1306T-331M-N	330	20	50	100	0.780	0.86	0.86	3.0
SDS1306T-471M-N	470	20	50	100	1.08	0.73	0.73	2.4
SDS1306T-681M-N	680	20	60	100	1.40	0.64	0.64	2.0
SDS1306T-102M-N	1000	20	60	100	2.01	0.53	0.53	1.0

Note: When ordering, please specify tolerance code. Tolerance: M=±20%

- Operating temperature range - 40°C ~ 125°C(Including self - temperature rise)
- Isat for inductance drop 10% from its value without current
- I rms for a 40°C temperature rise from 25°C ambient with current
- Measure Equipment :
 L : E4980 or HP4284A , 100kHz/ 0.1V
 RDC : Chroma 16502
 Isat : HP4284A+HP42841A or WK3260B+WK3265B

Test Instruments : HP4294A Impedance / Material Analyzer

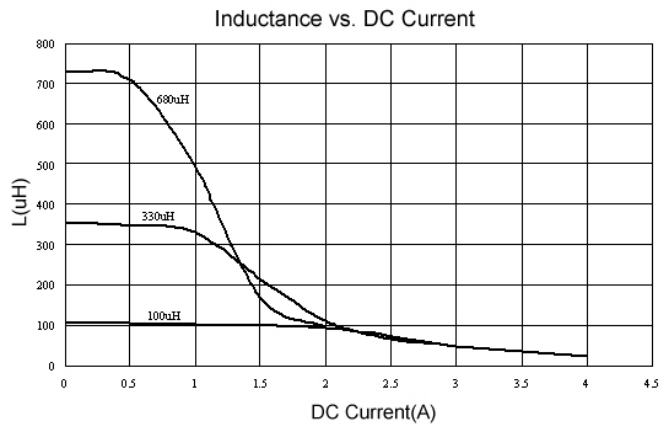
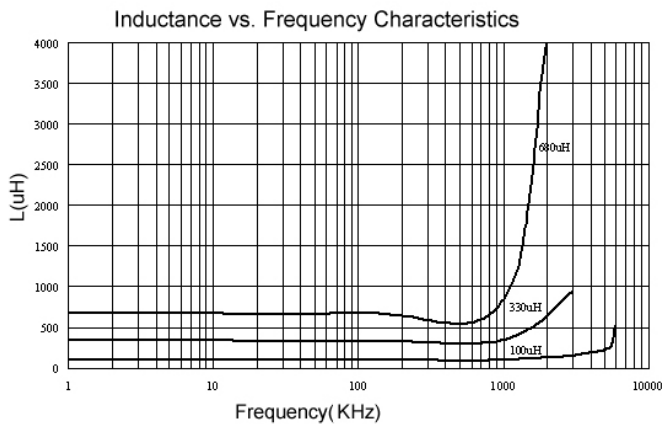

Please be sure to request approval specifications that provide further details of the products. Kindly note that the content of these specifications are subject to change or may be discontinued without advance notice. Please contact our sales department before ordering.

Packaging Specifications

Tape Dimensions

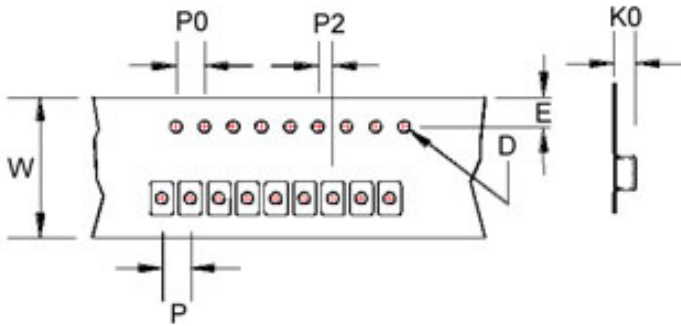

Tape Material

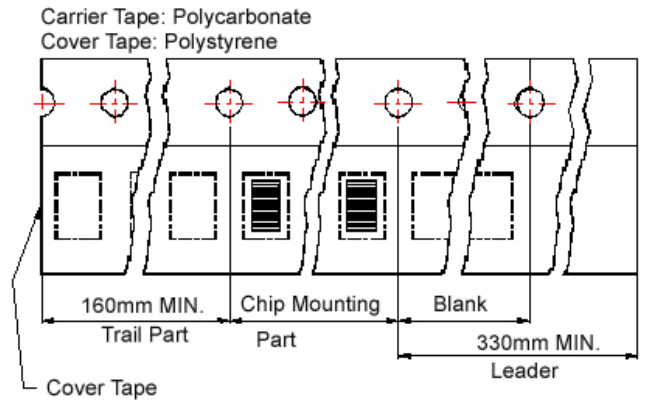

Reel Dimensions

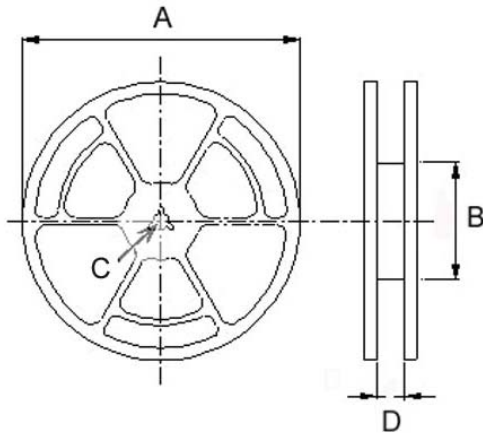

Dimensions

TYPE	Tape Dimensions							Reel Dimensions				Quantity (PCS /	
	K0	D	E	W	P	P0	P2	A	B	C	D	178mm	330mm
SDS 0402	3.2	1.55	1.75	12	8	4	2	330	100	13	13.4	-	2500
								178	60		13.2	750	-
SDS 0804	5.4	1.55	1.75	24	12	4	2	330	100	13	24.4	-	1000
SDS 1306	7.5	1.55	1.75	32	20	4	2	330	100	13	33.4	-	250

SLF Series



Features

- RoHS, Halogen Free and REACH Compliance
- Magnetic shielded
- Various package size and wide inductance range

Applications

- AP Routers
- STBs
- LCD TVs and monitors
- Game consoles
- LED lightings
- DC/DC converters

Products Identification

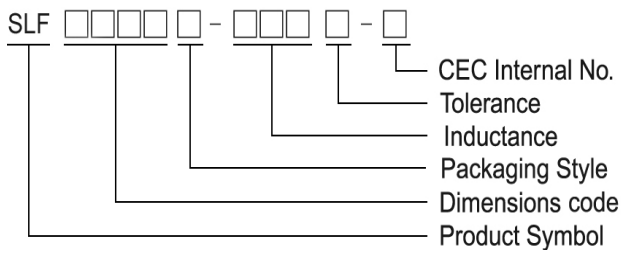

- Packaging: T : Tape and Reel

Shape and Dimensions

SLF 0628

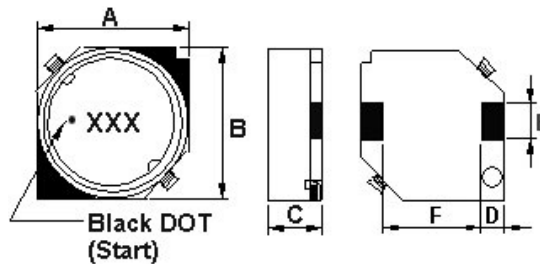

Dimension in mm

TYPE	A	B	C	D	E	F
SLF 0628	6 ± 0.2	6 ± 0.2	2.8 ± 0.2	1.5 TYP	2 ± 0.1	3.0 TYP

SLF 0728/ 0730/ 0732/ 0745

SLF 0755

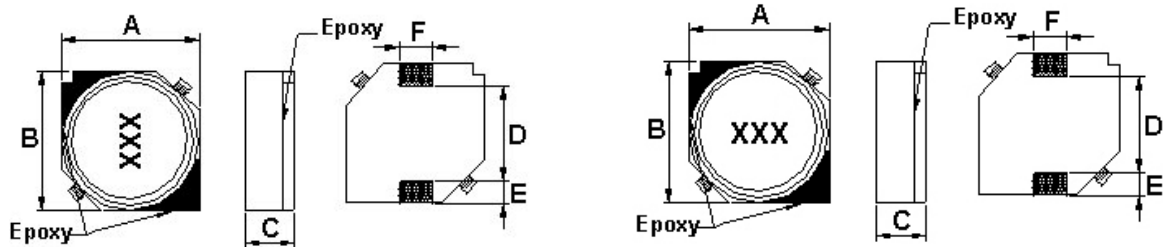

Dimension in mm

TYPE	A	B	C	D	E	F
SLF 0728	7 ± 0.2	7 ± 0.2	2.8 ± 0.2	4.9 TYP	0.9TYP	2.0 TYP
SLF 0730	7 ± 0.2	7 ± 0.2	3.0 ± 0.2	4.9 TYP	0.9TYP	2.0 TYP
SLF 0732	7 ± 0.2	7 ± 0.2	3.2 ± 0.2	4.9 TYP	0.9TYP	2.0 TYP
SLF 0745	7 ± 0.2	7 ± 0.2	4.5 ± 0.3	4.9 TYP	0.9TYP	2.0 TYP
SLF 0755	7.0 ± 0.2	7.0 ± 0.2	5.5 ± 0.3	4.9 TYP	0.9 TYP	2.0 TYP

Shape and Dimensions

SLF 1045/ 1055

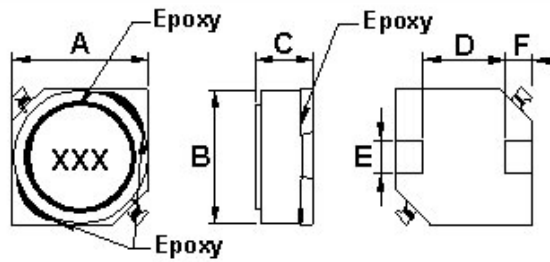

Dimension in mm

TYPE	A	B	C	D	E	F
SLF 1045	10.1 ± 0.3	10.1 ± 0.3	4.5 ± 0.3	6.0 TYP	3.0 TYP	2 TYP
SLF 1055	10.1 ± 0.3	10.1 ± 0.3	5.5 ± 0.3	6.0 TYP	3.0 TYP	2 TYP

SLF 1255/ 1265/ 1275

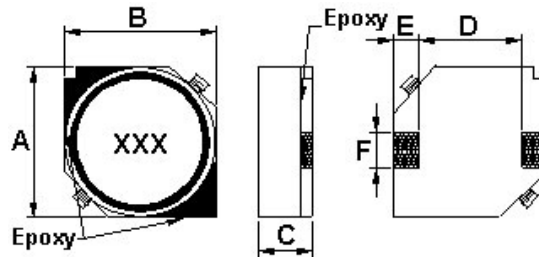

Dimension in mm

TYPE	A	B	C	D	E	F
SLF 1255	12.5 ± 0.3	12.5 ± 0.3	5.5 ± 0.3	8.6 TYP	2.0 TYP	3.0 TYP
SLF 1265	12.5 ± 0.3	12.5 ± 0.3	6.5 ± 0.35	8.6 TYP	2.0 TYP	3.0 TYP
SLF 1275	12.5 ± 0.3	12.5 ± 0.3	7.5 ± 0.35	8.6 TYP	2.0 TYP	3.0 TYP

Recommended Pattern

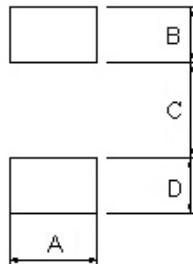

Dimension in mm

TYPE	A	B	C	D
SLF 0628	2.2	1.5	4.0	1.5
SLF 0728	2.2	1.5	4.9	1.5
SLF 0730	2.2	1.5	4.9	1.5
SLF 0732	2.2	1.5	4.9	1.5
SLF 0745	2.2	1.5	4.9	1.5
SLF 0755	2.2	1.5	4.9	1.5
SLF 1045	3.2	2.5	5.6	2.5
SLF 1045	3.2	2.5	5.6	2.5
SLF 1105	3.2	2.5	5.6	2.5
SLF 1255	3.2	2.5	8.6	2.5
SLF 1265	3.2	2.5	8.6	2.5
SLF 1275	3.2	2.5	8.6	2.5

Electrical Characteristics

Part Number	Inductance (μH)	Tolerance ($\pm\%$)	Test Frequency (kHz)	RDC ($\Omega\pm 20\%$)	Isat (A)	Irms (A) Max
SLF0628T-4R7M-N	4.7	20	1	0.0284	1.6	2.5
SLF0628T-6R8M-N	6.8	20	1	0.0354	1.5	2.2
SLF0628T-100M-N	10	20	1	0.0532	1.3	1.8
SLF0628T-150M-N	15	20	1	0.0745	1.0	1.4
SLF0628T-220M-N	22	20	1	0.104	0.77	1.3
SLF0628T-330M-N	33	20	1	0.148	0.69	1.1
SLF0628T-470M-N	47	20	1	0.21	0.59	0.92
SLF0628T-680M-N	68	20	1	0.29	0.50	0.78
SLF0628T-101M-N	100	20	1	0.43	0.42	0.64

Note: When ordering, please specify tolerance code. Tolerance: M= $\pm 20\%$

- Operating temperature range - 40°C ~ 125°C(Including self - temperature rise)
- Isat for Inductance drop 30% from its value without current
- Irms for a 25°C temperature rise from 25°C ambient with current
- Measure Equipment :
L : E4980 or HP4284A , 1kHz 0.5V
RDC : Chroma 16502
Isat : HP4284A+HP42841A or WK3260B+WK3265B

Electrical Characteristics

Part Number	Inductance (μH)	Tolerance ($\pm\%$)	Test Frequency (kHz)	RDC ($\Omega\pm 20\%$)	Isat (A)
SLF0728T-2R2M-N	2.2	20	1	0.032	1.8
SLF0728T-3R3M-N	3.3	20	1	0.037	1.6
SLF0728T-4R7M-N	4.7	20	1	0.045	1.5
SLF0728T-5R0M-N	5.0	20	1	0.045	2.4
SLF0728T-6R8M-N	6.8	20	1	0.059	1.3
SLF0728T-8R2M-N	8.2	20	1	0.065	1.1
SLF0728T-100M-N	10	20	1	0.083	1.1
SLF0728T-150M-N	15	20	1	0.13	0.88
SLF0728T-220M-N	22	20	1	0.18	0.75
SLF0728T-330M-N	33	20	1	0.24	0.65
SLF0728T-470M-N	47	20	1	0.34	0.54

Note: When ordering, please specify tolerance code. Tolerance: M= $\pm 20\%$

- Operating temperature range - 40°C ~ 125°C(Including self - temperature rise)
- Isat for Inductance drop 10% from its value without current
- Measure Equipment :
L : E4980 or HP4284A , 1kHz 0.5V
RDC : Chroma 16502
Isat : HP4284A+HP42841A or WK3260B+WK3265B

Electrical Characteristics

Part Number	Inductance (μH)	Tolerance ($\pm\%$)	Test Frequency (kHz)	RDC ($\Omega\pm 20\%$)	Isat (A)
SLF0730T-3R3M-N	3.3	20	1	0.023	1.8
SLF0730T-4R7M-N	4.7	20	1	0.036	1.6
SLF0730T-6R8M-N	6.8	20	1	0.041	1.5
SLF0730T-100M-N	10	20	1	0.060	1.3
SLF0730T-150M-N	15	20	1	0.084	1
SLF0730T-220M-N	22	20	1	0.15	0.86
SLF0730T-330M-N	33	20	1	0.16	0.65
SLF0730T-470M-N	47	20	1	0.24	0.57
SLF0730T-680M-N	68	20	1	0.31	0.49
SLF0730T-101M-N	100	20	1	0.45	0.35

Note: When ordering, please specify tolerance code. Tolerance: M= $\pm 20\%$

- Operating temperature range - 40°C ~ 125°C(Including self - temperature rise)
- Isat for Inductance drop 10% from its value without current
- Measure Equipment :
L : E4980 or HP4284A , 1kHz 0.5V
RDC : Chroma 16502
Isat : HP4284A+HP42841A or WK3260B+WK3265B

Electrical Characteristics

Part Number	Inductance (μH)	Tolerance ($\pm\%$)	Test Frequency (kHz)	RDC ($\Omega\pm 20\%$)	Isat (A)
SLF0732T-2R2M-N	2.2	20	1	0.018	2.1
SLF0732T-3R3M-N	3.3	20	1	0.023	1.9
SLF0732T-4R7M-N	4.7	20	1	0.036	1.7
SLF0732T-6R8M-N	6.8	20	1	0.041	1.6
SLF0732T-100M-N	10	20	1	0.053	1.4
SLF0732T-150M-N	15	20	1	0.075	1.1
SLF0732T-220M-N	22	20	1	0.11	0.96
SLF0732T-330M-N	33	20	1	0.16	0.75
SLF0732T-470M-N	47	20	1	0.24	0.67
SLF0732T-680M-N	68	20	1	0.31	0.59
SLF0732T-101M-N	100	20	1	0.45	0.45
SLF0732T-151M-N	150	20	1	0.65	0.37
SLF0732T-221M-N	220	20	1	1.05	0.29
SLF0732T-331M-N	330	20	1	1.67	0.22
SLF0732T-471M-N	470	20	1	2.05	0.2
SLF0732T-681M-N	680	20	1	3.15	0.16
SLF0732T-102M-N	1000	20	1	4.78	0.13

Note: When ordering, please specify tolerance code. Tolerance: M= $\pm 20\%$

- Operating temperature range - 40°C ~ 125°C(Including self - temperature rise)
- Isat for Inductance drop 10% from its value without current
- Measure Equipment :
L : E4980 or HP4284A , 1kHz 0.5V
RDC : Chroma 16502
Isat : HP4284A+HP42841A or WK3260B+WK3265B

Electrical Characteristics

Part Number	Inductance (μ H)	Tolerance (\pm %)	Test Frequency (kHz)	RDC ($\Omega \pm 20\%$)	Isat (A)	Irms (A) Max
SLF0745T-3R3M-N	3.3	20	1	0.02	2.5	2.3
SLF0745T-4R7M-N	4.7	20	1	0.03	2	2.1
SLF0745T-6R8M-N	6.8	20	1	0.039	1.7	1.74
SLF0745T-100M-N	10	20	1	0.036	1.3	1.78
SLF0745T-150M-N	15	20	1	0.052	1.1	1.53
SLF0745T-220M-N	22	20	1	0.061	0.9	1.34
SLF0745T-330M-N	33	20	1	0.096	0.82	1.09
SLF0745T-470M-N	47	20	1	0.125	0.75	0.92
SLF0745T-680M-N	68	20	1	0.175	0.6	0.77
SLF0745T-101M-N	100	20	1	0.25	0.5	0.65
SLF0745T-151M-N	150	20	1	0.34	0.4	0.55
SLF0745T-221M-N	220	20	1	0.52	0.33	0.45
SLF0745T-331M-N	330	20	1	0.74	0.25	0.37
SLF0745T-471M-N	470	20	1	1.05	0.22	0.31
SLF0745T-681M-N	680	20	1	1.48	0.2	0.27
SLF0745T-102M-N	1000	20	1	2.28	0.14	0.25

Note: When ordering, please specify tolerance code. Tolerance: M= $\pm 20\%$

- Operating temperature range - 40°C ~ 125°C(Including self - temperature rise)
- Isat for Inductance drop 10% from its value without current
- Irms for a 20°C temperature rise from 25°C ambient with current
- Measure Equipment :
L : E4980 or HP4284A , 1kHz 0.5V
RDC : Chroma 16502
Isat : HP4284A+HP42841A or WK3260B+WK3265B

Electrical Characteristics

Part Number	Inductance (μ H)	Tolerance (\pm %)	Test Frequency (kHz)	RDC (Ω)	Isat (A)	Irms (A) Max
SLF0755T-1R5T-N	1.5	30	100	0.0174 $\pm 30\%$	6.2	4.0
SLF0755T-2R2T-N	2.2	30	100	0.0217 $\pm 30\%$	5.3	3.5
SLF0755T-3R3T-N	3.3	30	100	0.0240 $\pm 30\%$	4.3	3.3
SLF0755T-4R7T-N	4.7	30	100	0.0280 $\pm 30\%$	3.6	3.1
SLF0755T-6R8T-N	6.8	30	100	0.0340 $\pm 30\%$	3.0	2.8
SLF0755T-100M-N	10	20	100	0.0391 $\pm 20\%$	2.6	2.5
SLF0755T-150M-N	15	20	100	0.0508 $\pm 20\%$	2.1	2.2
SLF0755T-220M-N	22	20	100	0.0643 $\pm 20\%$	1.7	2.0
SLF0755T-470M-N	47	20	100	0.1550 $\pm 20\%$	0.8	1.0

Note: When ordering, please specify tolerance code. Tolerance: M= $\pm 20\%$, T= $\pm 30\%$

- Operating temperature range - 40°C ~ 125°C(Including self - temperature rise)
- Isat for Inductance drop 10% from its value without current
- Irms for a 30°C temperature rise from 25°C ambient with current
- Measure Equipment :
L : E4980 or HP4284A , 100kHz 1V
RDC : Chroma 16502
Isat : HP4284A+HP42841A or WK3260B+WK3265B

Electrical Characteristics

Part Number	Inductance (μ H)	Tolerance (\pm %)	Test Frequency (kHz)	RDC ($\Omega \pm 20\%$)	Isat (A)	Irms (A) Max
SLF1045T-4R7T-N	4.7	20	1	0.0200	4.5	
SLF1045T-100M-N	10	20	1	0.0364	3.0	2.5
SLF1045T-150M-N	15	20	1	0.0472	2.4	2.2
SLF1045T-220M-N	22	20	1	0.0591	2.1	1.9
SLF1045T-330M-N	33	20	1	0.0815	1.6	1.7
SLF1045T-470M-N	47	20	1	0.1	1.4	1.5
SLF1045T-680M-N	68	20	1	0.14	1.2	1.3
SLF1045T-101M-N	100	20	1	0.2	1.0	1.1
SLF1045T-151M-N	150	20	1	0.35	0.79	0.81
SLF1045T-221M-N	220	20	1	0.47	0.65	0.70
SLF1045T-271M-N	270	20	1	0.58	0.58	0.60
SLF1045T-331M-N	330	20	1	0.68	0.54	0.58
SLF1045T-471M-N	470	20	1	1.03	0.47	0.47
SLF1045T-681M-N	680	20	1	1.6	0.38	0.38
SLF1045T-102M-N	1000	20	1	2.8	0.32	0.29
SLF1045T-152M-N	1500	20	1	3.4	0.22	0.26

Note: When ordering, please specify tolerance code. Tolerance: M= $\pm 20\%$, T= $\pm 30\%$

- Operating temperature range - 40°C ~ 125°C(Including self - temperature rise)
- Isat for Inductance drop 10% from its value without current
- I rms for a 30°C temperature rise from 25°C ambient with current
- Measure Equipment :
L : E4980 or HP4284A , 1kHz 0.5V
RDC : Chroma 16502
Isat : HP4284A+HP42841A or WK3260B+WK3265B
Isat : HP4284A+HP42841A or WK3260B+WK3265B

Electrical Characteristics

Part Number	Inductance (μ H)	Tolerance (\pm %)	Test Frequency (kHz)	RDC (Ω) Max	Isat (A)
SLF1055T-4R7M-N	4.7	20	1	0.035	4.0
SLF1055T-100M-N	10	20	1	0.040	3.0
SLF1055T-220M-N	22	20	1	0.0456	2.5
SLF1055T-330M-N	33	20	1	0.085	2.1

Note: When ordering, please specify tolerance code. Tolerance: M= $\pm 20\%$

- Operating temperature range - 40°C ~ 125°C(Including self - temperature rise)
- Isat for Inductance drop 15% from its value without current
- Measure Equipment :
L : E4980 or HP4284A , 1kHz 0.5V
RDC : Chroma 16502
Isat : HP4284A+HP42841A or WK3260B+WK3265B

Electrical Characteristics

Part Number	Inductance (μH)	Tolerance ($\pm\%$)	Test Frequency (kHz)	RDC ($\Omega\pm 20\%$)	Isat (A)	Irms (A) Max
SLF1255T-6R0M-N	6	20	1	0.0164	3.6	4.9
SLF1255T-100M-N	10	20	1	0.0215	3.4	4.3
SLF1255T-150M-N	15	20	1	0.0259	2.8	3.9
SLF1255T-220M-N	22	20	1	0.0338	2.3	3.4
SLF1255T-330M-N	33	20	1	0.0415	1.9	3.1
SLF1255T-470M-N	47	20	1	0.0618	1.6	2.5
SLF1255T-680M-N	68	20	1	0.0832	1.3	2.2
SLF1255T-101M-N	100	20	1	0.117	1.1	1.8
SLF1255T-151M-N	150	20	1	0.19	0.88	1.4
SLF1255T-221M-N	220	20	1	0.27	0.72	1.2
SLF1255T-331M-N	330	20	1	0.41	0.59	1
SLF1255T-471M-N	470	20	1	0.52	0.49	0.88
SLF1255T-681M-N	680	20	1	0.76	0.43	0.73
SLF1255T-102M-N	1000	20	1	1.12	0.34	0.6
SLF1255T-152M-N	1500	20	1	1.73	0.29	0.48

Note: When ordering, please specify tolerance code. Tolerance: M= $\pm 20\%$

- Operating temperature range - 40°C ~ 125°C(Including self - temperature rise)
- Isat for Inductance drop 10% from its value without current
- I rms for a 30°C temperature rise from 25°C ambient with current
- Measure Equipment :
L : E4980 or HP4284A , 1kHz 0.5V
RDC : Chroma 16502
Isat : HP4284A+HP42841A or WK3260B+WK3265B

Electrical Characteristics

Part Number	Inductance (μH)	Tolerance ($\pm\%$)	Test Frequency (kHz)	RDC ($\Omega\pm 20\%$)	Isat (A)	Irms (A) Max
SLF1265T-2R0T-N	2	30	1	0.0117	10	6.2
SLF1265T-4R2T-N	4.2	30	1	0.015	7.3	5.5
SLF1265T-7R0T-N	7	30	1	0.0177	5.7	5.0
SLF1265T-100M-N	10	20	1	0.0202	5.0	4.8
SLF1265T-150M-N	15	20	1	0.0237	4.2	4.4
SLF1265T-220M-N	22	20	1	0.0316	3.5	3.8
SLF1265T-330M-N	33	20	1	0.0490	2.8	3.4
SLF1265T-470M-N	47	20	1	0.0578	2.4	2.8
SLF1265T-680M-N	68	20	1	0.0787	2.0	2.4
SLF1265T-101M-N	100	20	1	0.123	1.6	1.9
SLF1265T-151M-N	150	20	1	0.210	1.2	1.5
SLF1265T-221M-N	220	20	1	0.273	1.0	1.2

Note: When ordering, please specify tolerance code. Tolerance: M= $\pm 20\%$, T= $\pm 30\%$

- Operating temperature range - 40°C ~ 125°C(Including self - temperature rise)
- Isat for Inductance drop 10% from its value without current
- I rms for a 40°C temperature rise from 25°C ambient with current
- Measure Equipment :
L : E4980 or HP4284A , 1kHz 0.5V
RDC : Chroma 16502
Isat : HP4284A+HP42841A or WK3260B+WK3265B

Please be sure to request approval specifications that provide further details of the products. Kindly note that the content of these specifications are subject to change or may be discontinued without advance notice. Please contact our sales department before ordering.

Electrical Characteristics

Part Number	Inductance (μ H)	Tolerance (\pm %)	Test Frequency (kHz)	RDC ($\Omega \pm 20\%$)	Isat (A)	Irms (A) Max
SLF1275T-1R2T-N	1.2	30	1	0.0069	13	8.2
SLF1275T-2R7T-N	2.7	30	1	0.0094	10	7.0
SLF1275T-3R9T-N	3.9	30	1	0.0104	9	6.7
SLF1275T-4R7T-N	4.7	30	1	0.0110	7.8	6.3
SLF1275T-5R6T-N	5.6	30	1	0.0116	7.8	6.3
SLF1275T-6R8T-N	6.8	30	1	0.0131	7.2	5.9
SLF1275T-100M-N	10	20	1	0.0156	5.5	5.4
SLF1275T-150M-N	15	20	1	0.0184	4.7	5.0
SLF1275T-220M-N	22	20	1	0.0263	4.0	4.0
SLF1275T-330M-N	33	20	1	0.0395	3.2	3.4
SLF1275T-470M-N	47	20	1	0.0528	2.7	3.0
SLF1275T-680M-N	68	20	1	0.0778	2.0	2.4
SLF1275T-101M-N	100	20	1	0.1250	1.9	1.9
SLF1275T-151M-N	150	20	1	0.1750	1.5	1.6
SLF1275T-221M-N	220	20	1	0.2580	1.3	1.3
SLF1275T-331M-N	330	20	1	0.340	0.9	

Note: When ordering, please specify tolerance code. Tolerance: M= $\pm 20\%$, T= $\pm 30\%$

- Operating temperature range - 40°C ~ 125°C(Including self - temperature rise)
- Isat for Inductance drop 10% from its value without current
- Irms for a 40°C temperature rise from 25°C ambient with current
- Measure Equipment :
L : E4980 or HP4284A , 1kHz 0.5V
RDC : Chroma 16502
Isat : HP4284A+HP42841A or WK3260B+WK3265B

Packaging Specifications

Tape Dimensions

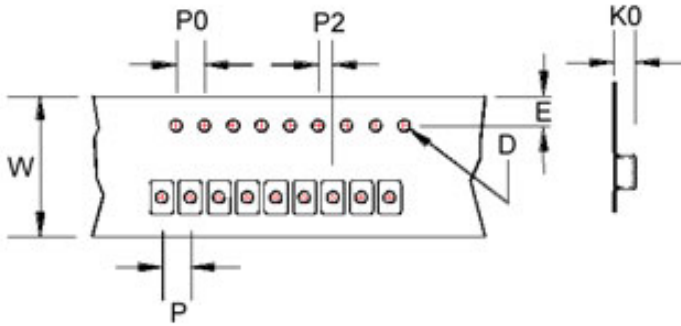

Tape Material

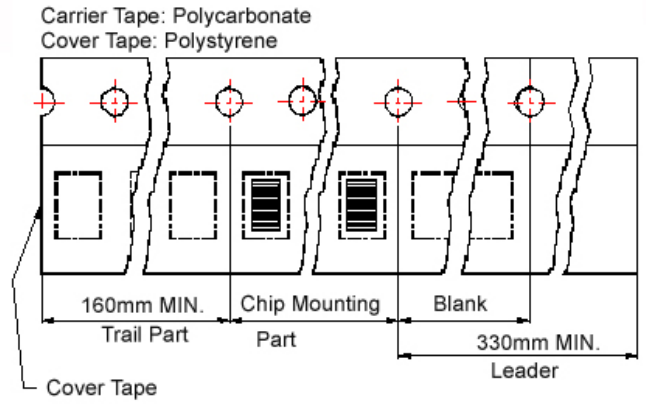

Reel Dimensions

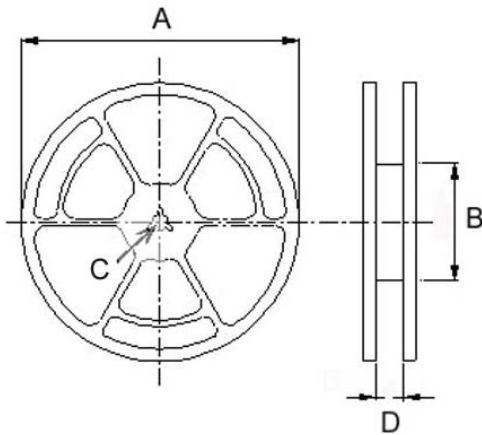

Dimensions in mm

TYPE	Tape Dimensions							Reel Dimensions				Quantity PCS / REEL
	K0	D	E	W	P	P0	P2	A	B	C	D	
SLF 0628	3.4	1.55	1.75	16	12	4	2	330	100	13	16.0	1000
SLF 0728	3.2	1.55	1.75	16	12	4	2	330	100	13	16.0	1000
SLF 0730	3.5	1.55	1.75	16	12	4	2	330	100	13	16.0	1000
SLF 0732	3.5	1.55	1.75	16	12	4	2	330	100	13	16.0	1000
SLF 0745	4.8	1.55	1.75	16	12	4	2	330	100	13	16.0	1000
SLF 0755	5.7	1.55	1.75	16	12	4	2	330	100	13	16.0	900
SLF 1045	5.0	1.55	1.75	24	16	4	2	330	100	13	24.4	500
SLF 1055	5.0	1.55	1.75	24	16	4	2	330	100	13	24.4	500
SLF 1255	6.0	1.55	1.75	24	16	4	2	330	100	13	24.4	500
SLF 1265	7.0	1.55	1.75	24	16	4	2	330	100	13	24.4	500
SLF 1275	8.2	1.55	1.75	24	16	4	2	330	100	13	24.4	350

SLFA Series

Features

- RoHS, Halogen Free and REACH Compliance
- Magnetically shielded type
- Cost effective
- Low DCR

Applications

- TV
- Laptop
- Mainboard
- Automotive devices
- Commercial devices

Product Identification

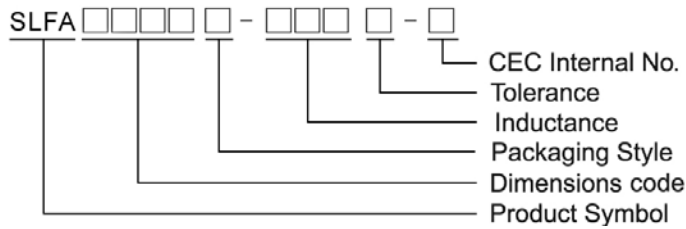

SLFA 5D28

Shape and Dimensions

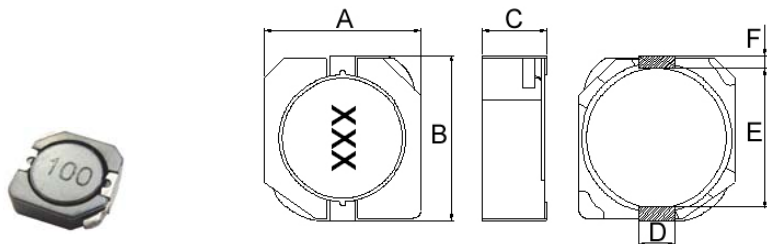

Dimensions in mm						
TYPE	A	B	C	D	E	F
SLFA5D28	6.3 ⁺⁰	6.3 ⁺⁰	3.0 ⁺⁰	2.0	4.0	0.9

Recommended Pattern

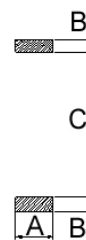

Dimension in mm			
TYPE	A	B	C
SLFA5D28	2.2	1.5	4.0

SLFA 0745~1255

Shape and Dimensions

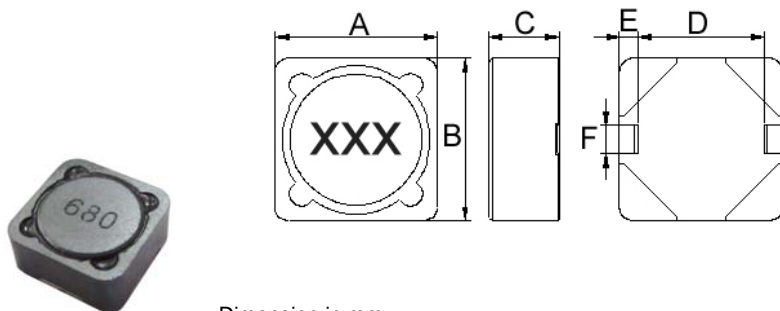

Dimension in mm						
TYPE	A	B	C	D	E	F
SLFA0745	7.3±0.2	7.3±0.2	4.8 ⁺⁰	5.5	0.9	2.0
SLFA0755	7.3±0.2	7.3±0.2	5.8 ⁺⁰	5.5	0.9	2.0
SLFA1255	12.5 ⁺⁰	12.5 ⁺⁰	5.8 ⁺⁰	8.0	2.0	2.7

Recommended Pattern

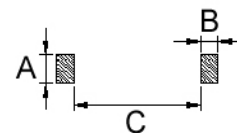

Dimension in mm			
TYPE	A	B	C
SLFA0745	2.2	1.5	4.8
SLFA0755	2.2	1.5	4.8
SLFA1255	3.2	2.6	7.5

Standard Specifications

Part Number	Inductance (uH)	Tolerance (±%)	Test Frequency (kHz)	SRF (MHz) Min	RDC (mΩ) Max	Isat (A)	Irms (A)	Marking
SLFA5D28T-6R8T-N	6.8	30	100	35	42	1.50	2.20	6R8
SLFA5D28T-100M-N	10	20	100	20	63.8	1.30	1.80	100
SLFA5D28T-150M-N	15	20	100	15	89.4	1.00	1.40	150
SLFA5D28T-220M-N	22	20	100	10	124	0.77	1.30	220
SLFA5D28T-330M-N	33	20	100	7	177	0.69	1.10	330
SLFA5D28T-470M-N	47	20	100	5	252	0.59	0.92	470
SLFA5D28T-680M-N	68	20	100	4	348	0.50	0.78	680
SLFA5D28T-101M-N	100	20	100	4	516	0.42	0.64	101
SLFA5D28T-151M-N	150	30	100	4	780	0.34	0.50	151
SLFA5D28T-221M-N	220	20	100	3.2	1170	0.26	0.38	221

Note: When ordering, please specify tolerance code. Tolerance: M=±20% , T=±30%

- Operating temperature range - 40°C ~ 125°C(Including self - temperature rise)
- Isat for Inductance drop 30% from its value without current
- Irms for a 25°C temprature rise from 25°C ambient
- Measure Equipment :
 L : L: WK6500B+WK6565, 100kHz/ 1V
 RDC : Chroma 16502
 Isat : WK3260B+WK3265B

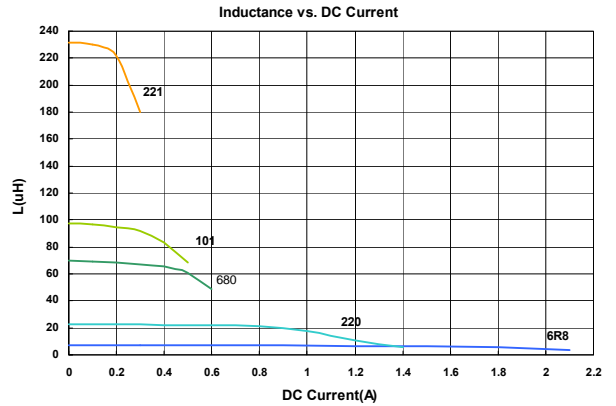
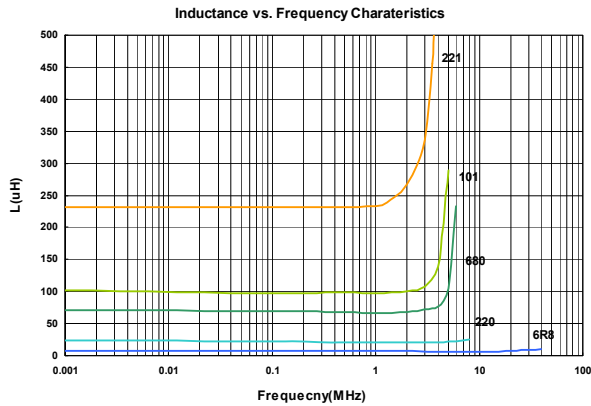

Please be sure to request approval specifications that provide further details of the products. Kindly note that the content of these specifications are subject to change or may be discontinued without advance notice. Please contact our sales department before ordering.

Standard Specifications

Part Number	Inductance (uH)	Tolerance (±%)	Test Frequency (kHz)	SRF (MHz) Min	RDC (mΩ) Max	Isat (A)	Irms (A)	Marking
SLFA0745T-3R3M-N	3.3	20	100	90	24	2.50	2.30	3R3
SLFA0745T-4R7M-N	4.7	20	100	65	36	2.00	2.10	4R7
SLFA0745T-6R8M-N	6.8	20	100	24	40	1.70	1.74	6R8
SLFA0745T-100M-N	10	20	100	17	43.2	1.30	1.78	100
SLFA0745T-150M-N	15	20	100	14	62.4	1.10	1.53	150
SLFA0745T-220M-N	22	20	100	10.5	73.2	0.90	1.34	220
SLFA0745T-330M-N	33	20	100	10.0	115	0.82	1.09	330
SLFA0745T-470M-N	47	20	100	8.0	150	0.75	0.92	470
SLFA0745T-680M-N	68	20	100	7.0	210	0.60	0.77	680
SLFA0745T-101M-N	100	20	100	6.0	300	0.50	0.65	101
SLFA0745T-151M-N	150	20	100	4.0	408	0.40	0.55	151
SLFA0745T-221M-N	220	20	100	3.5	624	0.33	0.45	221
SLFA0745T-331M-N	330	20	100	3.0	880	0.25	0.37	331
SLFA0745T-471M-N	470	20	100	2.5	1260	0.22	0.31	471
SLFA0745T-681M-N	680	20	100	2.1	1770	0.20	0.27	681
SLFA0745T-102M-N	1000	20	100	1.1	2730	0.14	0.25	102

Note: When ordering, please specify tolerance code. Tolerance: M=±20%

- Operating temperature range - 40°C ~ 125°C(Including self - temperature rise)
- Isat for Inductance drop 10% from its value without current
- I rms for a 20°C temperature rise from 25°C ambient
- Measure Equipment :
 L : L: WK6500B+WK6565, 100kHz/ 1V
 RDC : Chroma 16502
 Isat : WK3260B+WK3265B

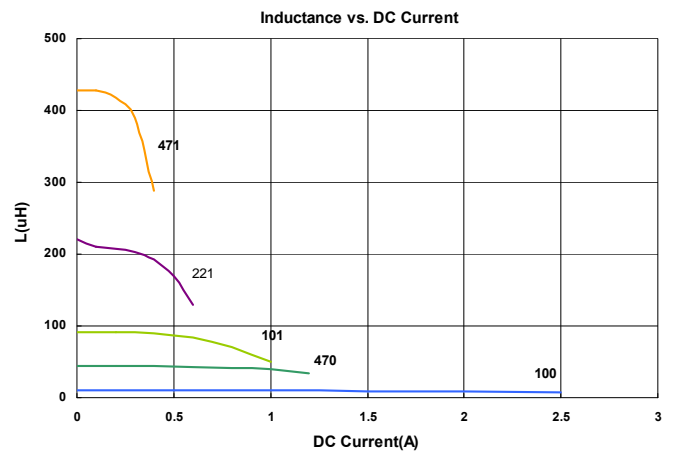
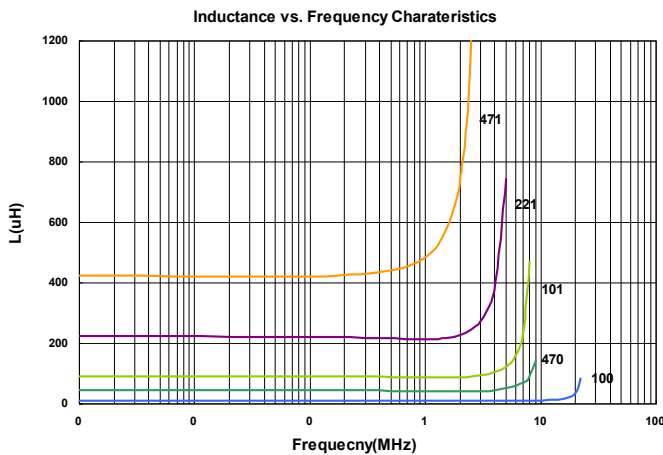

Please be sure to request approval specifications that provide further details of the products. Kindly note that the content of these specifications are subject to change or may be discontinued without advance notice. Please contact our sales department before ordering.

Standard Specifications

Part Number	Inductance (uH)	Tolerance (±%)	Test Frequency (kHz)	SRF (MHz) Min	RDC (mΩ) Max	Isat (A)	Irms (A)	Marking
SLFA0755T-1R5T-N	1.5	30	100	75	20	6.2	4.0	1R5
SLFA0755T-2R2T-N	2.2	30	100	55	23	5.3	3.5	2R2
SLFA0755T-3R3T-N	3.3	30	100	48	31	4.3	3.3	3R3
SLFA0755T-4R7T-N	4.7	30	100	38	36	3.6	3.1	4R7
SLFA0755T-6R8T-N	6.8	30	100	35	44	3.0	2.8	6R8
SLFA0755T-100M-N	10	20	100	22	46	2.6	2.5	100
SLFA0755T-150M-N	15	20	100	14	60.9	2.1	2.2	150
SLFA0755T-220M-N	22	20	100	8	77	1.7	2.0	220

Note: When ordering, please specify tolerance code. Tolerance: M=±20% , T=±30%

- Operating temperature range - 40°C ~ 125°C(Including self - temperature rise)
- Isat for Inductance drop 10% from its value without current
- Irms for a 30°C temprature rise from 25°C ambient.
- Measure Equipment :
 L : L: WK6500B+WK6565, 100kHz/ 1V
 RDC : Chroma 16502
 Isat : WK3260B+WK3265B

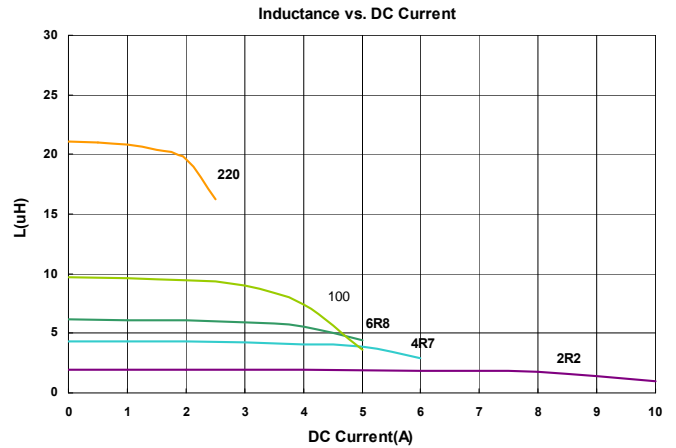
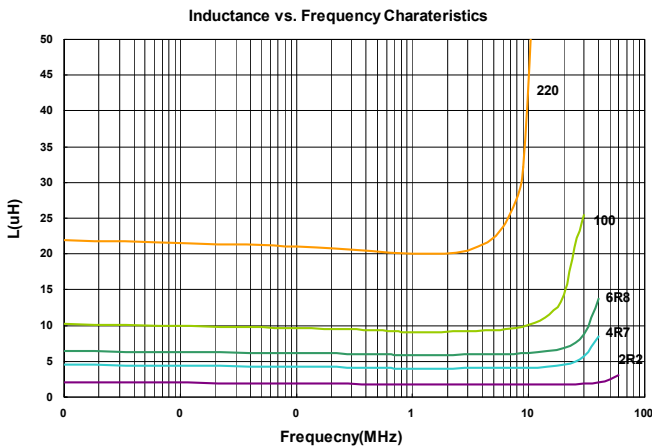

Please be sure to request approval specifications that provide further details of the products. Kindly note that the content of these specifications are subject to change or may be discontinued without advance notice. Please contact our sales department before ordering.

Standard Specifications

Part Number	Inductance (uH)	Tolerance (±%)	Test Frequency (kHz)	SRF (MHz) Min	RDC (mΩ) Max	Isat (A)	Irms (A)	Marking
SLFA1255T-6R0T-N	6	30	1	26	19.7	3.6	4.9	6R0
SLFA1255T-100M-N	10	20	1	17	25.8	3.4	4.3	100
SLFA1255T-150M-N	15	20	1	15	31.0	2.8	3.9	150
SLFA1255T-220M-N	22	20	1	11	40.6	2.3	3.4	220
SLFA1255T-330M-N	33	20	1	10	49.8	1.9	3.1	330
SLFA1255T-470M-N	47	20	1	8	74.2	1.6	2.5	470
SLFA1255T-680M-N	68	20	1	7	99.8	1.3	2.2	680
SLFA1255T-101M-N	100	20	1	5.5	140	1.1	1.8	101
SLFA1255T-151M-N	150	30	1	4.5	228	0.88	1.4	151
SLFA1255T-221M-N	220	20	1	3.0	324	0.72	1.2	221
SLFA1255T-331M-N	330	20	1	3.0	492	0.59	1.0	331
SLFA1255T-471M-N	470	20	1	2.5	624	0.49	0.88	471
SLFA1255T-681M-N	680	20	1	2.0	912	0.43	0.73	681
SLFA1255T-102M-N	1000	20	1	1.7	1344	0.34	0.60	102
SLFA1255T-152M-N	1500	20	1	1.4	2076	0.29	0.48	152

Note: When ordering, please specify tolerance code. Tolerance: M=±20% , T=±30%

- Operating temperature range - 40°C ~ 125°C(Including self - temperature rise)
- Isat for Inductance drop 10% from its value without current
- Irms for a 30°C temprature rise from 25°C ambient.
- Measure Equipment :
 L : L: WK6500B+WK6565, 1kHz/ 1V
 RDC : Chroma 16502
 Isat : WK3260B+WK3265B

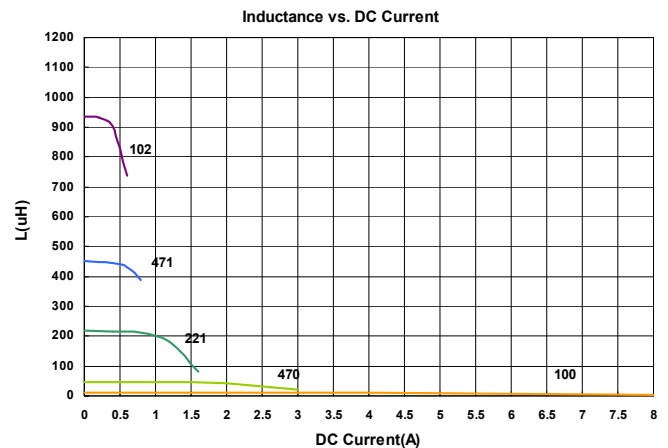
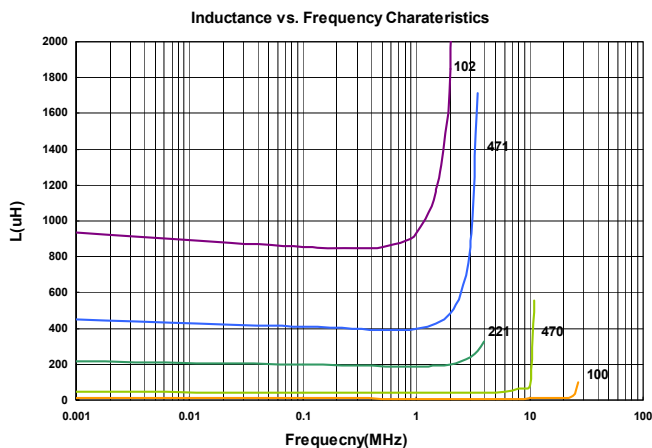

Please be sure to request approval specifications that provide further details of the products. Kindly note that the content of these specifications are subject to change or may be discontinued without advance notice. Please contact our sales department before ordering.

Packaging Specifications

Tape Dimensions

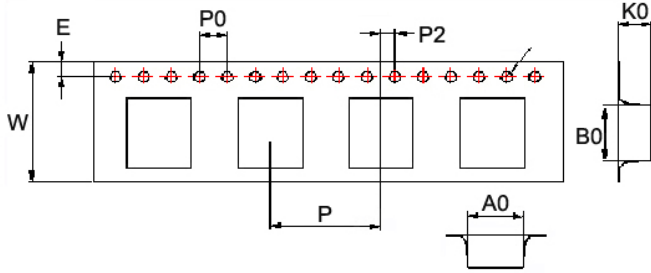

Tape Material

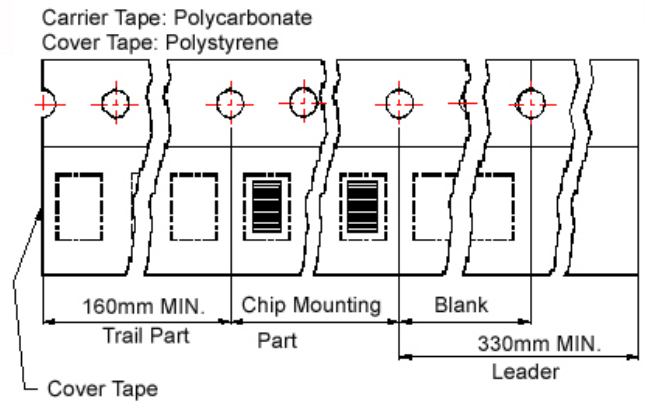

Reel Dimensions

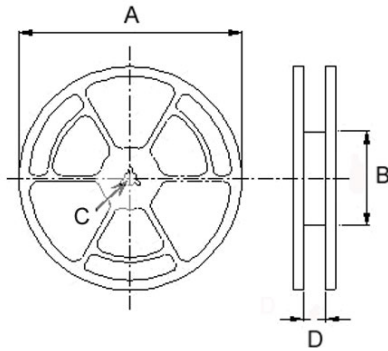

Dimensions in mm

TYPE	Tape Dimensions									Reel Dimensions				Quantity PCS / REEL
	A0	B0	K0	D	E	W	P	P0	P2	A	B	C	D	
SLFA 5D28	6.3	6.55	3.3	1.55	1.75	16	12	4	2	330	100	13	16.0	1000
SLFA 0745	7.6	7.6	5.2	1.55	1.75	16	12	4	2	330	100	13	16.0	1000
SLFA 0755	7.8	7.8	6.0	1.55	1.75	16	12	4	2	330	100	13	16.0	900
SLFA 1255	12.6	12.6	6.7	1.55	1.75	24	16	4	2	330	100	13	24.2	600

SDT Series



Its feature of "swinging" inductance vs. current characteristics, the SSL0402 Series supports used as ultra high inductance at zero or low current.

Features

- RoHS, Halogen Free and REACH Compliance
- Magnetic shielded
- Functions equally well in filter and smoothing circuit applications

Applications

- Electric motors
- DC/DC converters

Product Identification

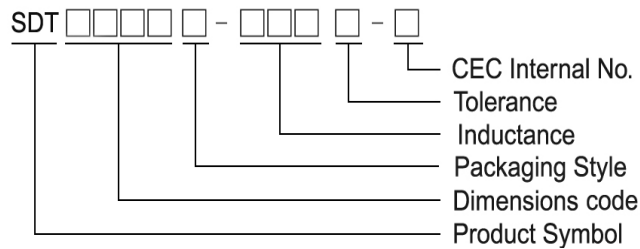

- Packaging: T : Tape and Reel

Shape and Dimensions

SDT 0402

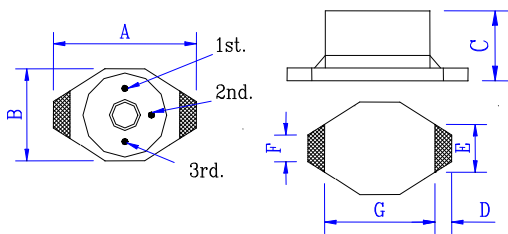

Dimensions in mm

A	B	C	D	E	F	G
6.60 ⁺⁰	4.54 ⁺⁰	2.92 ⁺⁰	1.02	3.05	1.27	4.32

Recommended Pattern

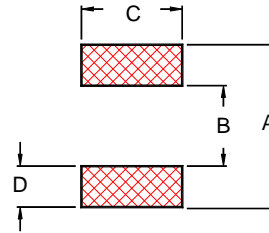

Dimensions in mm

A	B	C	D
6.86	4.06	3.56	1.40

SDT 0804

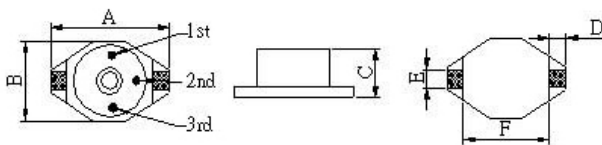

Dimensions in mm

A	B	C	D	E	F
12.95 ⁺⁰	9.4 ⁺⁰	5.08 ⁺⁰	2.54	2.54	7.62

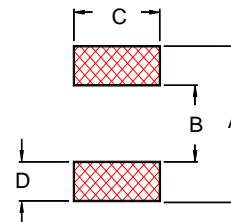

Dimensions in mm

A	B	C	D
13.21	7.37	2.79	2.92

Electrical Characteristics

Specifications				Operating Parameters				
Part Number	Inductance (μH)	Tolerance (±%)	DC Resistance (Ω) Max	Self Resonant Frequency (MHz) Typ.	Inductance Rating (μH)	Current Rating (A)	Energy Storage (μ Joules) Max	Switching Frequency Max
SDT0402T-1R0M-N	1.0	20	0.045	157	0.60	2.0	1.8	1 MHz
SDT0402T-1R5M-N	1.5	20	0.050	108	0.80	1.9	1.8	1 MHz
SDT0402T-2R2M-N	2.2	20	0.060	92	0.90	1.5	1.8	1 MHz
SDT0402T-3R3M-N	3.3	20	0.070	69	1.5	1.2	1.4	1 MHz
SDT0402T-4R7M-N	4.7	20	0.080	59	2.0	1.2	1.6	1 MHz
SDT0402T-6R8M-N	6.8	20	0.085	51	3.0	1.0	1.9	1 MHz
SDT0402T-100M-N	10	20	0.095	33	5.0	0.7	1.2	1 MHz
SDT0402T-150M-N	15	20	0.135	26	6.0	0.6	1.1	1 MHz
SDT0402T-220M-N	22	20	0.160	20	10	0.5	1.2	1 MHz
SDT0402T-330M-N	33	20	0.275	17	12	0.45	1.5	1 MHz
SDT0402T-470M-N	47	20	0.340	12	20	0.34	1.3	1 MHz
SDT0402T-680M-N	68	20	0.575	11	30	0.29	1.4	1 MHz
SDT0402T-101M-N	100	20	1.100	9.4	40	0.24	1.5	1 MHz
SDT0402T-151M-N	150	20	1.400	6.7	60	0.20	1.4	500 kHz
SDT0402T-221M-N	220	20	2.250	6.1	90	0.17	1.6	500 kHz
SDT0402T-331M-N	330	20	2.900	4.7	100	0.16	1.4	500 kHz
SDT0402T-471M-N	470	20	3.600	3.85	150	0.14	1.5	500 kHz
SDT0402T-681M-N	680	20	4.550	3.1	200	0.12	1.4	500 kHz
SDT0402T-102M-N	1000	20	8.100	2.3	400	0.08	1.4	500 kHz

Note: When ordering, please specify tolerance code. Tolerance: M=±20%

- Operating temperature range - 40°C ~ 125°C(Including self - temperature rise)
- Measured at the rated current. Refer to curves below for more detail.
- Average maximum allowable current. SDT Series inductors are designed for current spikes as high as 2X the current rating
- Measure Equipment :
 - L : E4980 or HP4284A, 100kHz 0.1V
 - RDC : Chroma 16502
 - SRF : HP4291A or HP4192A
 - Rated Current : HP4284A+HP42841A or WK3260B+WK3265B

Typical Inductance Energy Storage VS. Current

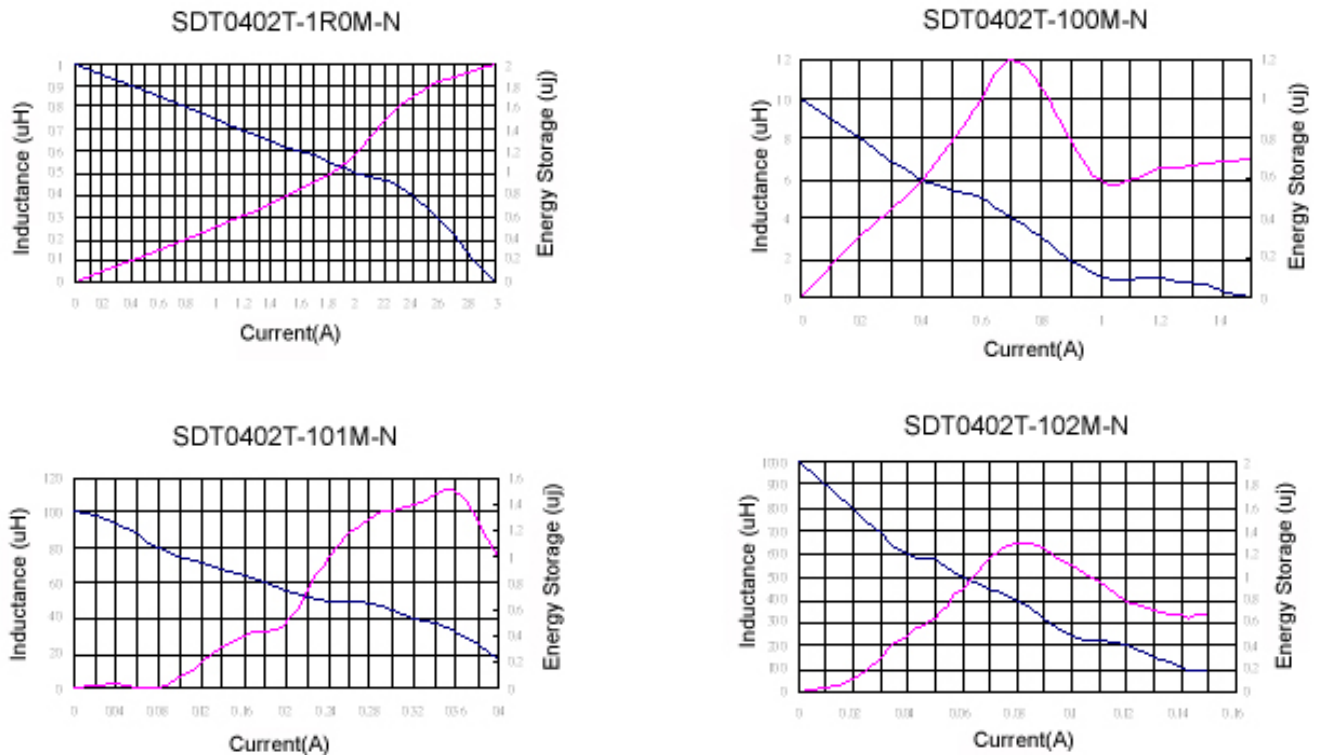

Please be sure to request approval specifications that provide further details of the products. Kindly note that the content of these specifications are subject to change or may be discontinued without advance notice. Please contact our sales department before ordering.

Electrical Characteristics

Specifications				Operating Parameters				
Part Number	Inductance (μH)	Tolerance (±%)	DC Resistance (Ω) Max	Self Resonant Frequency (MHz) Typ.	Inductance Rating (μH)	Current Rating (A)	Energy Storage (μ Joules) Max	Switching Frequency Max
SDT0804T-1R0M-N	1.0	20	0.025	60	0.50	5.0	9	1 MHz
SDT0804T-1R5M-N	1.5	20	0.030	55	0.70	5.0	12	1 MHz
SDT0804T-2R2M-N	2.2	20	0.035	55	1.00	5.0	15	1 MHz
SDT0804T-3R3M-N	3.3	20	0.040	50	1.50	5.0	16	1 MHz
SDT0804T-4R7M-N	4.7	20	0.045	45	2.00	3.0	10	1 MHz
SDT0804T-6R8M-N	6.8	20	0.050	40	4.00	2.5	14	1 MHz
SDT0804T-100M-N	10	20	0.055	35	5.00	2.0	11	1 MHz
SDT0804T-150M-N	15	20	0.060	25	6.00	1.8	12	1 MHz
SDT0804T-220M-N	22	20	0.084	22	10	1.5	11	1 MHz
SDT0804T-330M-N	33	20	0.090	18	12	1.3	13	1 MHz
SDT0804T-470M-N	47	20	0.11	16	27	1.0	13	1 MHz
SDT0804T-680M-N	68	20	0.15	12	40	0.90	17	1 MHz
SDT0804T-101M-N	100	20	0.29	9	50	0.80	15	1 MHz
SDT0804T-151M-N	150	20	0.36	8	80	0.60	15	500 kHz
SDT0804T-221M-N	220	20	0.39	6	90	0.50	10	500 kHz
SDT0804T-331M-N	330	20	0.73	5	150	0.40	13	500 kHz
SDT0804T-471M-N	470	20	0.88	4	200	0.35	13	500 kHz
SDT0804T-681M-N	680	20	1.15	3	300	0.30	13	500 kHz
SDT0804T-102M-N	1000	20	1.45	2.5	420	0.25	13	500 kHz

Note: When ordering, please specify tolerance code. Tolerance: M=±20%

- Operating temperature range - 40°C ~ 125°C(Including self - temperature rise)
- Measured at the rated current. Refer to curves below for more detail.
- Average maximum allowable current. SDT Series inductors are designed for current spikes as high as 2X the current rating
- Measure Equipment :
 L : E4980 or HP4284A, 100kHz 0.1V
 RDC : Chroma 16502
 SRF : HP4291A or HP4192A
 Rated Current : HP4284A+HP42841A or WK3260B+WK3265B

Typical Inductance Energy Storage VS. Current

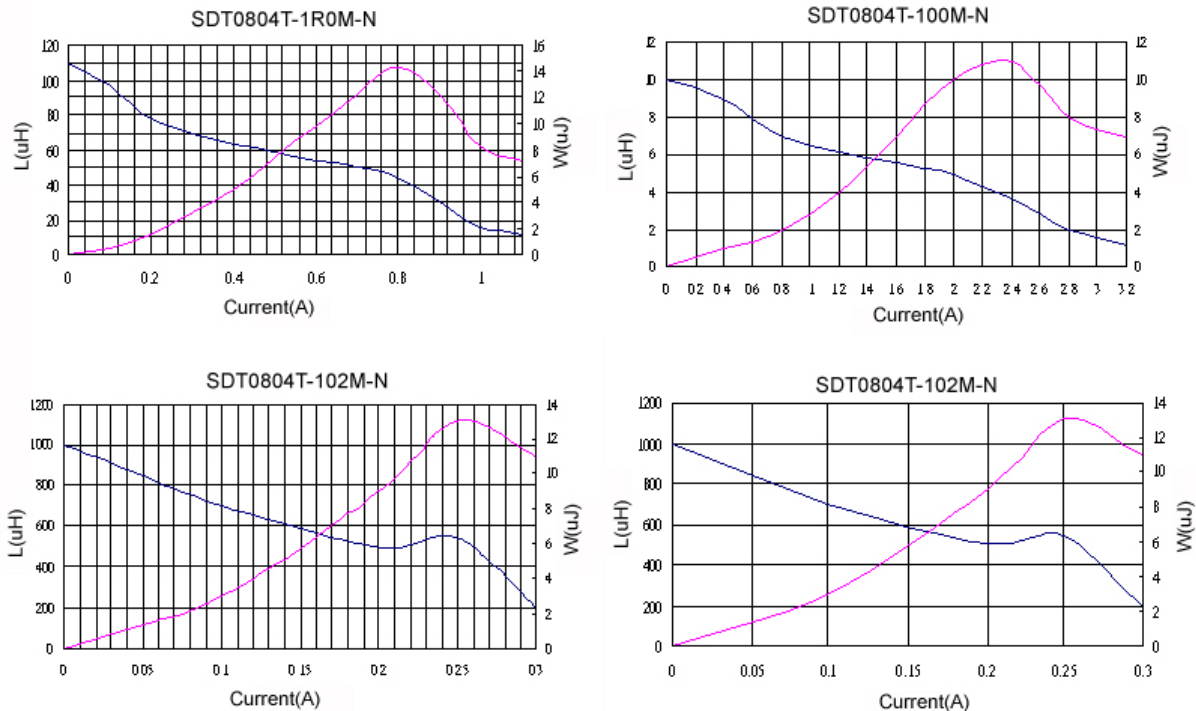

Please be sure to request approval specifications that provide further details of the products. Kindly note that the content of these specifications are subject to change or may be discontinued without advance notice. Please contact our sales department before ordering.

Packaging Specifications

Tape Dimensions

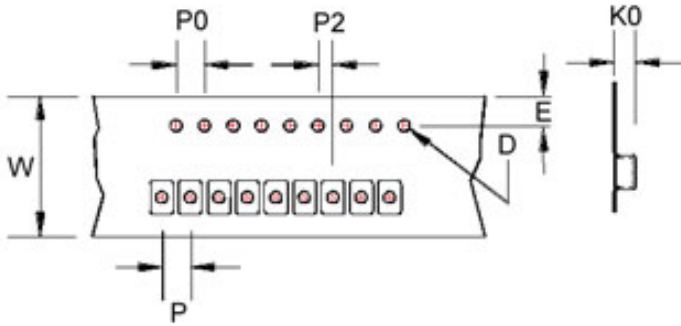

Tape Material

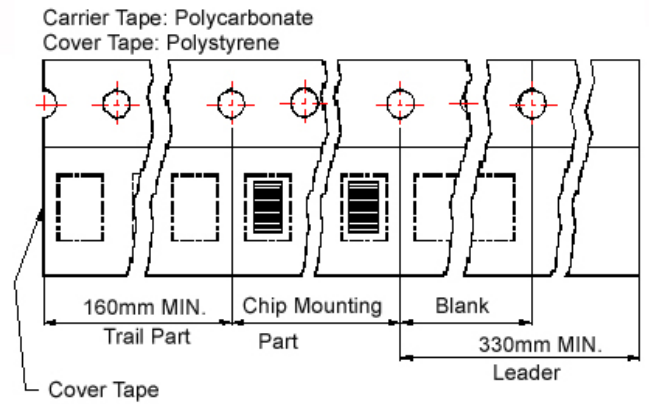

Reel Dimensions

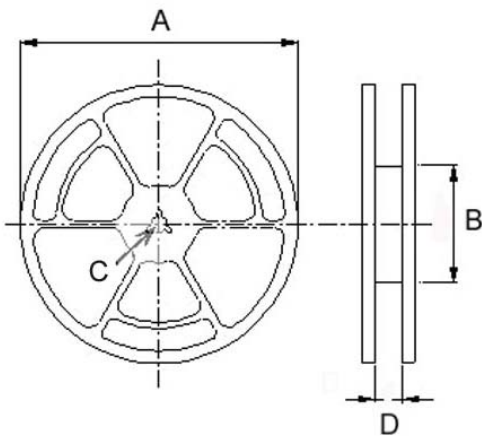

Dimensions in mm

TYPE	Tape Dimensions							Reel Dimensions				Quantity (PCS / REEL)	
	K0	D	E	W	P	P0	P2	A	B	C	D	178mm	330mm
SDT 0402	3.2	1.55	1.75	12	8	4	2	330	100	13	13.4	-	2500
								178	60		13.2	750	-
SDT 0804	5.4	1.55	1.75	24	16	4	2	330	100	13	24.4	-	750

Standard Specifications

Stamp	Inductance (μH)	RDC (Ω) Max										
		SCD 03015	SCD 03021	SCD 0403	SCD 0502	SCD 0503	SCD 0504	SCD 0703	SCD 0705	SCD 1004	SCD 1005	SCD 1006
R15	0.15			0.0085								
R82	0.82		0.06									
1R0	1.0		0.07	0.033	0.03	0.03						
1R2	1.2			0.035		0.03						
1R4	1.4		0.09	0.038	0.04				0.02			
1R5	1.5		0.11			0.03			0.02			
1R8	1.8		0.11	0.042	0.05	0.03	0.020		0.02			
2R2	2.2	0.10±30%	0.13	0.047	0.06	0.03	0.023	0.03	0.02			
2R7	2.7		0.14	0.052	0.07	0.04			0.02			
3R0	3.0								0.025			
3R3	3.3	0.11±30%	0.17	0.058	0.08	0.05	0.0314		0.03	0.022	0.038	
3R5	3.5						0.030					
3R8	3.8									0.022		
3R9	3.9		0.19	0.076	0.09	0.06			0.03			
4R7	4.7	0.15±30%	0.21	0.094	0.14	0.07	0.0372	0.04	0.04		0.040	
5R6	5.6	0.15±30%	0.22	0.101	0.15	0.08			0.04		0.037	
6R2	6.2			0.110								
6R8	6.8	0.20±30%	0.25	0.117	0.16	0.09	0.057		0.04	0.04	0.037	
7R0	7.0		0.28									
8R2	8.2		0.28	0.132	0.17	0.10			0.05		0.050	
100	10	0.30±30%	0.32	0.182	0.18	0.12	0.10	0.08	0.07	0.05	0.060	
120	12		0.35	0.210	0.20	0.13	0.12	0.09	0.08	0.06	0.070	
150	15	0.58±30%	0.40	0.235	0.22	0.15	0.14	0.10	0.09	0.07	0.080	
180	18		0.48	0.338	0.25	0.22	0.15	0.11	0.10	0.08	0.090	
220	22	0.71±30%	0.58	0.378	0.35	0.22	0.18	0.13	0.11	0.09	0.100	0.08
270	27		0.65	0.522	0.45	0.26	0.20	0.15	0.12	0.10	0.110	
330	33	1.10±30%	0.80	0.540	0.56	0.33	0.23	0.17	0.13	0.12	0.120	
390	39	1.30±30%	0.90	0.587	0.69	0.42	0.32	0.22	0.16	0.15	0.140	
470	47	1.30±30%	1.19	0.844	0.72	0.50	0.37	0.25	0.18	0.17	0.170	
500	50		1.22									
560	56		1.27	0.937	0.84	0.55	0.42	0.28	0.24	0.20	0.190	
680	68	2.20±30%	1.73	1.117	0.90	0.65	0.46	0.33	0.28	0.22	0.220	
750	75		1.90									
820	82		1.99		1.20	0.80	0.60	0.41	0.37	0.30	0.25	
101	100	3.50±30%	2.52	2.000	1.30	0.90	0.70	0.48	0.43	0.34	0.35	
121	120		2.90	1.800	1.38	1.00	0.93	0.54	0.47	0.40	0.40	
151	150		3.36	2.800	1.81	1.30	1.10	0.75	0.64	0.54	0.47	
181	180		5.10	3.200	1.95	1.50	1.38	1.02	0.71	0.62	0.63	
221	220	10.92	5.80	4.000	3.00	2.00	1.57	1.20	0.96	0.72	0.73	
271	270		7.80		3.20	2.50	1.85	1.31	1.11	0.95	0.97	
331	330			5.850	3.82	3.20	2.00	1.50	1.26	1.10	1.15	
391	390				4.68	3.50	2.60	1.77	1.24	1.24	1.30	
471	470				5.10	4.20	3.00		1.96	1.53	1.48	1.421
561	560				8.50	4.50	4.19	2.50	2.41	1.90	1.90	
681	680					10.0	6.50	4.44		2.50		2.25
821	820					12.0	7.50	5.12				2.55
102	1000					18.0	8.00	10.00		2.80		3.10
122	1200											2.9
152	1500											3.5
202	2000											3.8
222	2200											6.6
602	6000											8.0
822	8200											14
												50

Note: When ordering, please specify tolerance code. Tolerance: K=±10% , M=±20%

- Operating temperature range - 40°C ~ 105°C(Including self – temperature rise)
- Isat for Inductance drop 10% from its value without current
- Measure Equipment :
 Test Freq L : SCD03015: (1MHz/1V), SCD1005/1006: 1.0 ~ 8.2μH(7.96MHz/1V), 10 ~ 82μH (2.52MHz/1V), 100 ~ 1000μH (1kHz/1V)
 SCD03021/0403/0502/ 0503: 0.15 ~ 8.2μH(7.96MHz/1V), 10 ~ 82μH (2.52MHz/1V), 100 ~ 1000μH (1kHz/1V).
 SCD0504/0703/0705/1004: 1.0 ~ 8.2μH(7.96MHz/1V), 10 ~ 82μH (2.52MHz/1V), 100 ~ 1000μH (1kHz/1V).

L : Agilent/ E4980 or HP4284A (under 1MHz), HP4285A (over 1MHz)

RDC : Chroma 16502

Isat : HP4284+42841A or WK3260B+WK3265B

Please be sure to request approval specifications that provide further details of the products. Kindly note that the content of these specifications are subject to change or may be discontinued without advance notice. Please contact our sales department before ordering.



Standard Specifications

Stamp	Inductance (μH)	Isat (A) Max										
		SCD 03015	SCD 03021	SCD 0403	SCD 0502	SCD 0503	SCD 0504	SCD 0703	SCD 0705	SCD 1004	SCD 1005	SCD 1006
R15	0.15			7.5								
R82	0.82		2.200									
1R0	1.0		2.080	3.80	4.50	4.50						
1R2	1.2			3.50		4.20						
1R4	1.4		1.860	3.30	4.00				3.70			
1R5	1.5		1.800			4.10			3.70			
1R8	1.8		1.800	2.91	3.30	3.70	3.50		3.70			
2R2	2.2	0.79	1.390	2.60	2.94	3.50	3.20	3.20	3.70			
2R7	2.7		1.320	2.43	2.50	3.20			3.70			
3R0									3.70			
3R3	3.3	0.73	1.250	2.15	2.35	2.80	2.59		3.70	4.50	2.80	
3R5	3.5						2.40					
3R8	3.8									4.20		
3R9	3.9		1.200	1.98	2.20	2.60			3.70			
4R7	4.7	0.65	1.130	1.70	2.00	2.50	2.30	1.60	3.50		2.60	
5R6	5.6	0.60	0.910	1.60	1.80	2.40			3.30		4.50	
6R2	6.2			1.50								
6R8	6.8	0.77	0.850	1.41	1.70	2.20	1.80		3.10	3.00	4.33	
7R0	7.0		0.820									
8R2	8.2		0.820	1.26	1.40	2.00			2.70		3.50	
100	10	0.45	0.740	1.15	1.20	1.80	1.44	1.44	2.30	2.38	2.60	
120	12		0.640	1.05	1.18	1.75	1.40	1.39	2.00	2.13	2.45	
150	15	0.30	0.600	0.92	1.15	1.70	1.30	1.24	1.80	1.87	2.27	
180	18		0.540	0.84	1.10	1.60	1.23	1.12	1.60	1.73	2.15	
220	22	0.25	0.500	0.76	1.00	1.50	1.11	1.07	1.50	1.60	1.95	3.80
270	27		0.430	0.71	0.86	1.40	0.97	0.94	1.30	1.44	1.76	
330	33	0.20	0.400	0.64	0.76	1.10	0.88	0.85	1.20	1.26	1.50	
390	39	0.17	0.370	0.59	0.75	1.00	0.80	0.74	1.10	1.20	1.37	
470	47	0.17	0.360	0.54	0.73	0.90	0.72	0.68	1.10	1.10	1.28	
500	50		0.330									
560	56		0.310	0.50	0.55	0.85	0.68	0.64	0.94	1.01	1.17	
680	68	0.13	0.300	0.46	0.52	0.80	0.61	0.59	0.85	0.91	1.11	
750	75		0.290									
820	82		0.280		0.50	0.65	0.58	0.54	0.78	0.85	1.00	
101	100	0.10	0.250	0.40	0.40	0.60	0.52	0.51	0.72	0.74	0.97	
121	120		0.200	0.38	0.36	0.58	0.48	0.49	0.66	0.69	0.89	
151	150		0.190	0.30	0.30	0.43	0.40	0.40	0.58	0.61	0.78	
181	180		0.170	0.25	0.26	0.41	0.38	0.36	0.51	0.56	0.72	
221	220	0.07	0.160	0.15	0.25	0.38	0.35	0.31	0.49	0.53	0.66	
271	270		0.140		0.21	0.35	0.29	0.29	0.42	0.45	0.57	
331	330			0.21	0.18	0.28	0.28	0.28	0.40	0.42	0.52	
391	390				0.16	0.26	0.26		0.36	0.38	0.48	
471	470				0.15	0.20	0.12		0.34	0.35	0.42	0.82
561	560				0.14	0.19	0.10	0.14	0.32	0.32	0.33	
681	680				0.13	0.18	0.08		0.29		0.28	
821	820				0.07	0.15	0.05				0.24	
102	1000				0.05	0.13	0.03		0.19		0.20	0.60
122	1200											0.50
152	1500											0.60
202	2000											0.40
222	2200											0.40
602	6000											0.27
822	8200											0.20

Tolerance Of Inductors

- SCD03015 2.2 ~ 100μH ± 20%
- SCD03021 1.0 ~ 270μH ± 20%
- SCD0403 0.15 ~ 27μH ± 20% 33 ~ 100μH ±10%
- SCD0502 1.0 ~ 27μH ± 20% 33 ~ 1000μH ±10%
- SCD0503 1.0 ~ 27μH ± 20% 33 ~ 1000μH ±10%
- SCD0504 1.0~27μH±20% 33~47μH ±15% 56~1000μH±10%
- SCD0703 10 ~ 27μH ± 20% 33 ~ 330μH ±10%
- SCD0705 1.4 ~ 27μH ± 20% 33 ~ 470μH ±10%
- SCD1004 10 ~ 27μH ± 20% 33 ~ 560μH ±10%
- SCD1005 4.7 ~ 27μH ± 20% 33 ~ 820μH ±10%
- SCD1006 6000μH ~8200μH±20%

Tolerance: K = ±10% , M = ±20%

Please be sure to request approval specifications that provide further details of the products. Kindly note that the content of these specifications are subject to change or may be discontinued without advance notice. Please contact our sales department before ordering.

Test Instruments : HP4294A Impedance / Material Analyzer

SCD0403

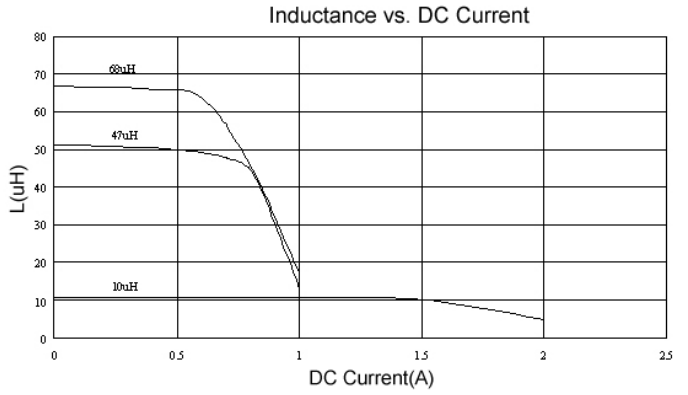
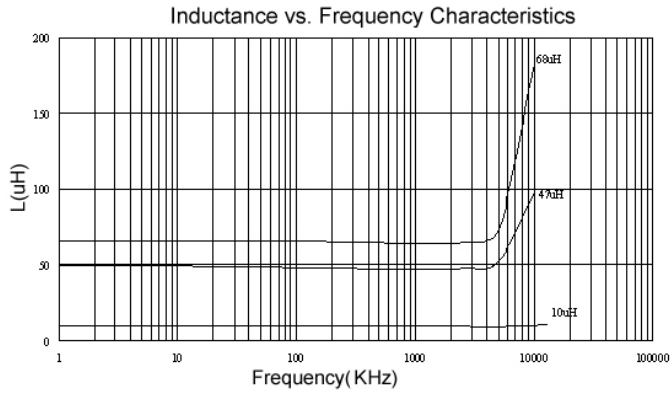

SCD0504

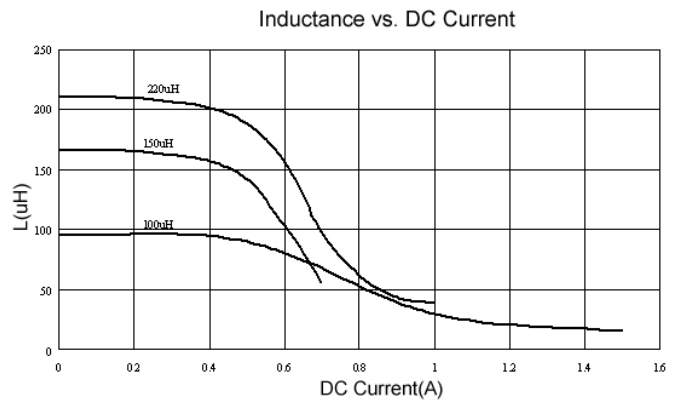
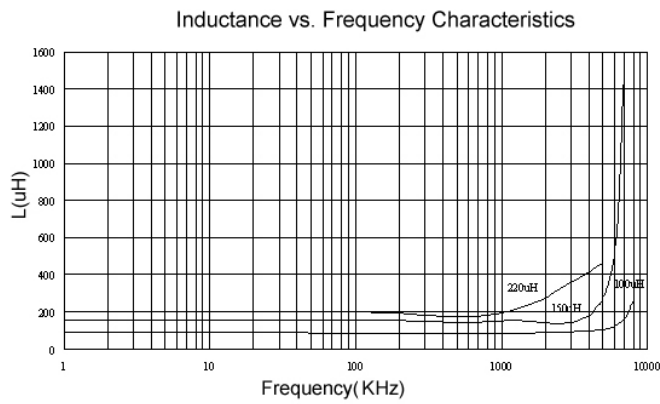

SCD0703

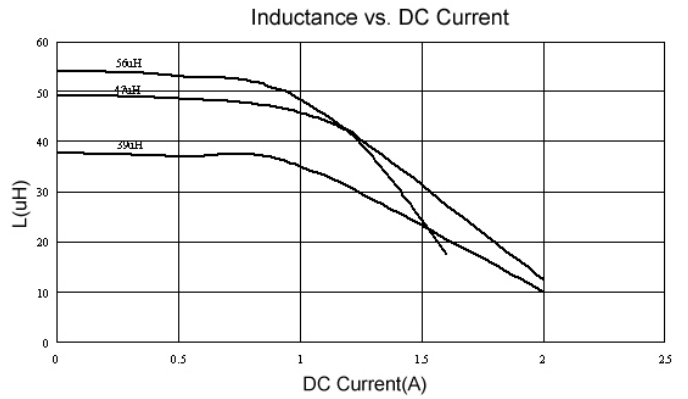
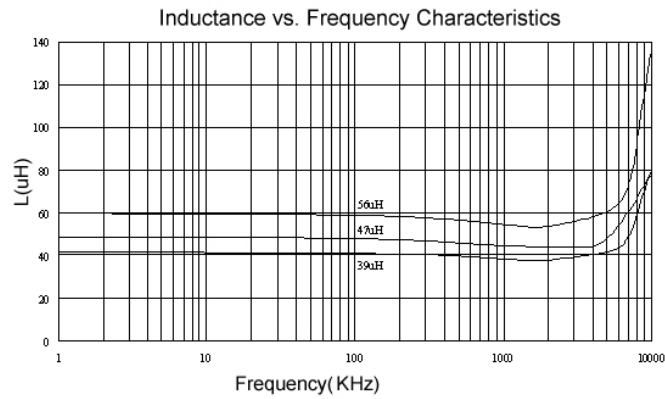

Please be sure to request approval specifications that provide further details of the products. Kindly note that the content of these specifications are subject to change or may be discontinued without advance notice. Please contact our sales department before ordering.

Test Instruments : HP4294A Impedance / Material Analyzer

SCD0705

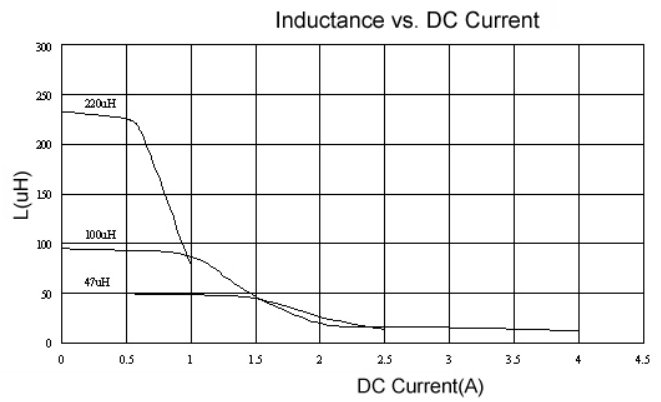
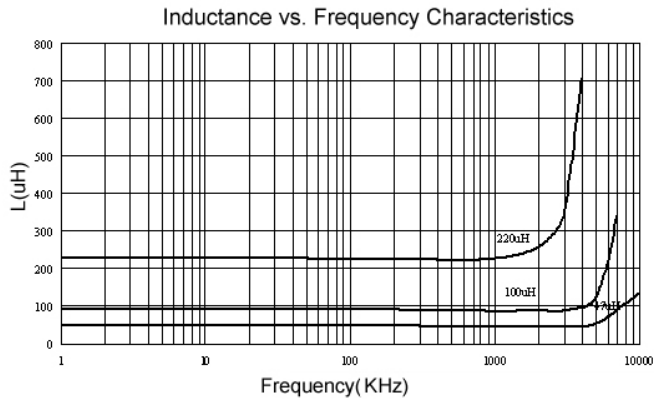

SCD1004

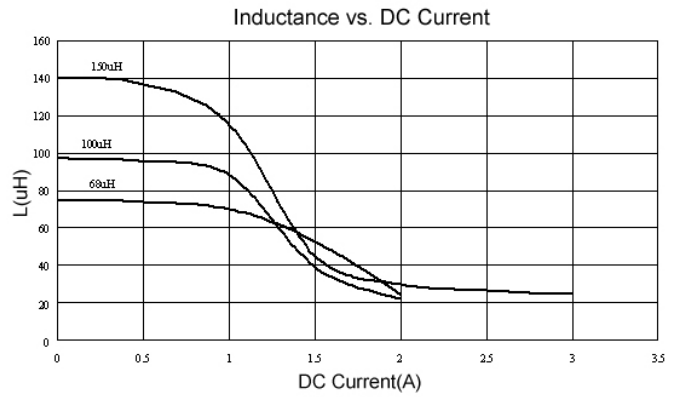
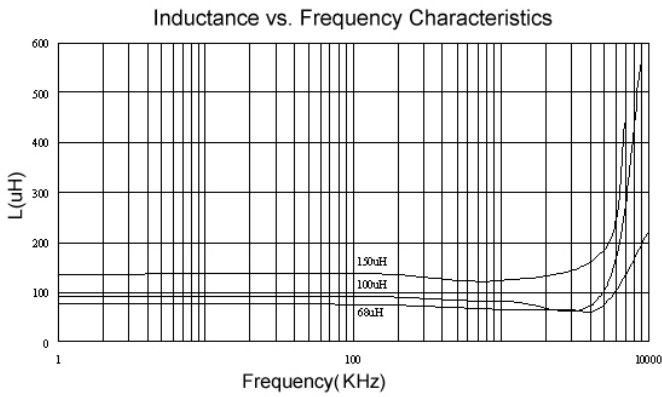

SCD1005

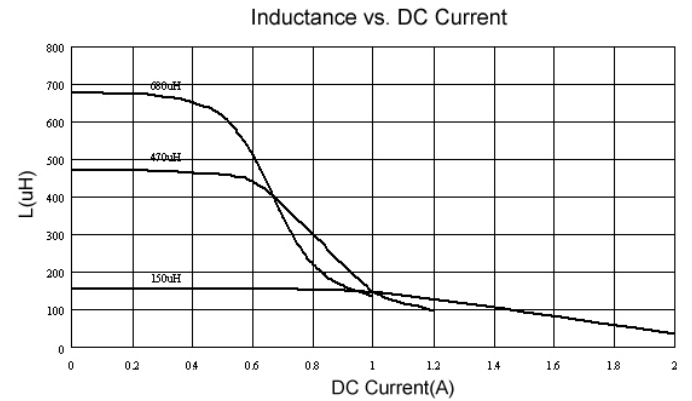
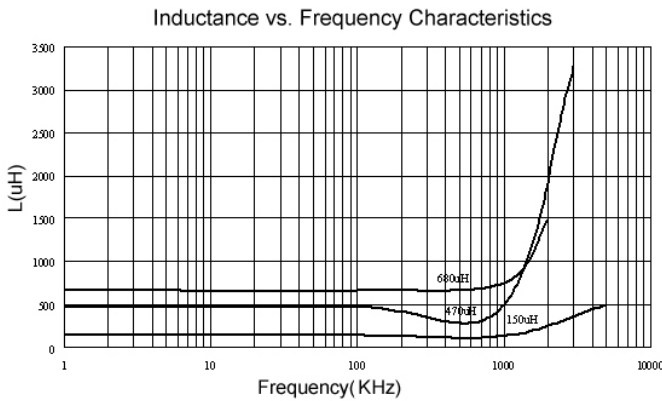

Please be sure to request approval specifications that provide further details of the products. Kindly note that the content of these specifications are subject to change or may be discontinued without advance notice. Please contact our sales department before ordering.

Packaging Specifications

Tape Dimensions

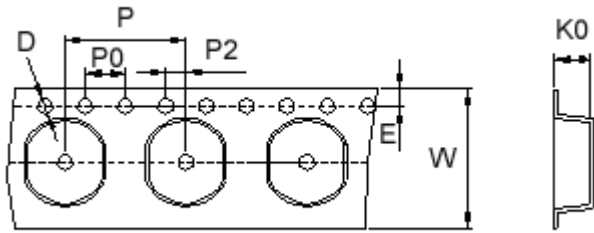

Tape Material

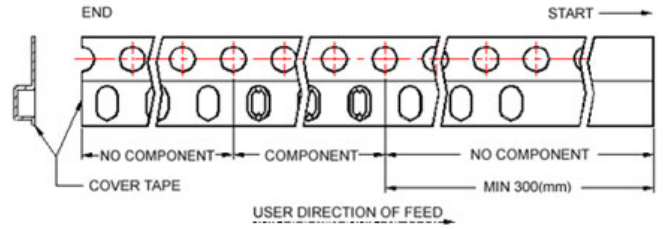

Reel Dimensions

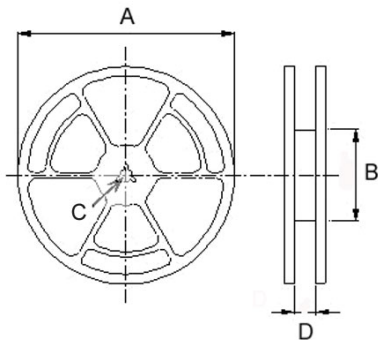

Dimensions in mm

TYPE	Tape Dimensions							Reel Dimensions				Quantity PCS / REEL
	K0	D	E	W	P	P0	P2	A	B	C	D	
SCD03015	1.80	1.55	1.75	12	8	4	2	330	100	13	13.4	3000
SCD03021	2.50	1.55	1.75	12	8	4	2	330	100	13	13.4	3000
SCD0403	3.55	1.55	1.75	12	8	4	2	330	100	13	13.4	2000
SCD0502	3.30	1.50	1.75	16	8	4	2	330	100	13	16.0	2000
SCD0503	3.30	1.50	1.75	16	8	4	2	330	100	13	16.0	2000
SCD0504	4.8	1.55	1.75	16	8	4	2	330	100	13	16.0	1500
SCD0703	3.8	1.55	1.75	16	12	4	2	330	100	13	16.0	1000
SCD0705	5.2	1.55	1.75	16	12	4	2	330	100	13	16.0	700
SCD1004	4.5	1.55	1.75	24	12	4	2	330	100	13	24.4	700
SCD1005	5.8	1.55	1.75	24	12	4	2	330	100	13	24.4	700
SCD1006	7.0	1.55	1.75	24	12	4	2	330	100	13	24.4	500

SSL Series

Features

- RoHS, Halogen Free and REACH Compliance
- Unshielded power inductor
- Various package size and wide inductance range. SSL-HC family is designed for low resistance and high current purpose

Applications

- DC/DC converters

Product Identification

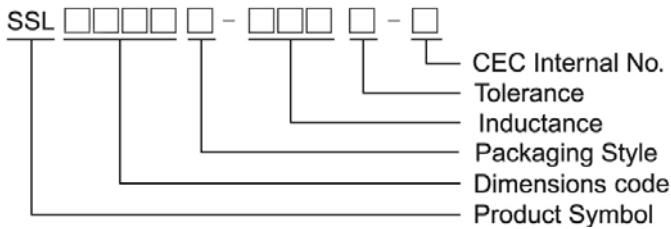

- Packaging: T : Tape and Reel , B : Bulk

Shape and Dimensions

SSL0402

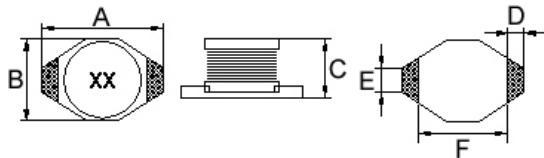

Dimensions in mm

A	B	C	D	E	F
6.60 ⁺⁰	4.45 ⁺⁰	2.92 ⁺⁰	1.02	1.27	4.32

Recommended Pattern

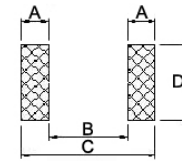

Dimensions in mm

TYPE	A	B	C	D
SSL0402	1.40	4.06	6.86	3.56

SSL0804/ 0810

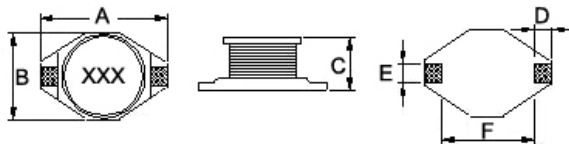

Dimensions in mm

TYPE	A	B	C	D	E	F
SSL0804	12.95 ⁺⁰	9.40 ⁺⁰	5.21 ⁺⁰	2.54	2.54	7.62
SSL0810	12.95 ⁺⁰	9.40 ⁺⁰	11.43 ⁺⁰	2.54	2.54	7.62

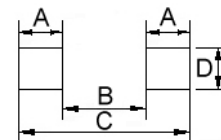

Dimension in mm

TYPE	A	B	C	D
SSL0804	2.92	7.37	13.21	2.79
SSL0810	2.92	7.37	13.21	2.79

SSL1306

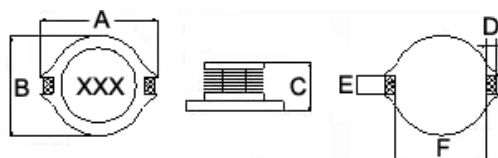

Dimensions in mm

A	B	C	D	E	F
18.54 ⁺⁰	15.24 ⁺⁰	7.11 ⁺⁰	2.54	2.54	12.7

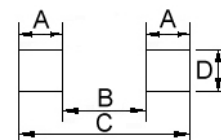

Dimension in mm

TYPE	A	B	C	D
SSL1306	2.92	12.45	18.29	2.79

Electrical Characteristics

Part Number	Inductance (μH)	Tolerance (±%)	SRF (MHz) Typ.	RDC (Ω) Max	Isat (A)	Irms (A)
SSL0402T-1R0M-N	1.0	20	130	0.05	2.90	2.9
SSL0402T-1R5M-N	1.5	20	115	0.05	2.60	2.8
SSL0402T-2R2M-N	2.2	20	90	0.07	2.30	2.4
SSL0402T-3R3M-N	3.3	20	70	0.08	2.00	2.0
SSL0402T-4R7M-N	4.7	20	50	0.09	1.50	1.5
SSL0402T-5R6M-N	5.6	20	47	0.11	1.30	1.4
SSL0402T-6R8M-N	6.8	20	45	0.13	1.20	1.4
SSL0402T-100M-N	10	20	35	0.16	1.10	1.1
SSL0402T-150M-N	15	20	30	0.23	0.90	1.2
SSL0402T-220M-N	22	20	20	0.37	0.70	0.8
SSL0402T-330M-N	33	20	15	0.51	0.58	0.6
SSL0402T-470M-N	47	20	14	0.64	0.50	0.5
SSL0402T-680M-N	68	20	11	0.86	0.40	0.4
SSL0402T-101M-N	100	20	9	1.27	0.31	0.3
SSL0402T-151M-N	150	20	6	2.00	0.27	0.25
SSL0402T-221M-N	220	20	5.5	3.11	0.22	0.20
SSL0402T-331M-N	330	20	5	3.80	0.18	0.16
SSL0402T-471M-N	470	20	4	5.06	0.16	0.15
SSL0402T-681M-N	680	20	3	9.20	0.14	0.12
SSL0402T-102M-N	1000	20	2	13.8	0.10	0.07

Note: When ordering, please specify tolerance code. Tolerance: M=±20%

- Operating temperature range - 40°C ~ 125°C(Including self - temperature rise)
- Isat for Inductance drop 20% from its value without current
- I rms for a 30°C temperature rise from 25°C ambient with current
- Measure Equipment :
 L : E4980 or HP4284A , 100kHz 0.1V
 SRF : HP4291A or HP4192A
 RDC : Chroma 16502
 Isat : HP4284A+HP42841A or WK3260B+WK3265B

Test Instruments :

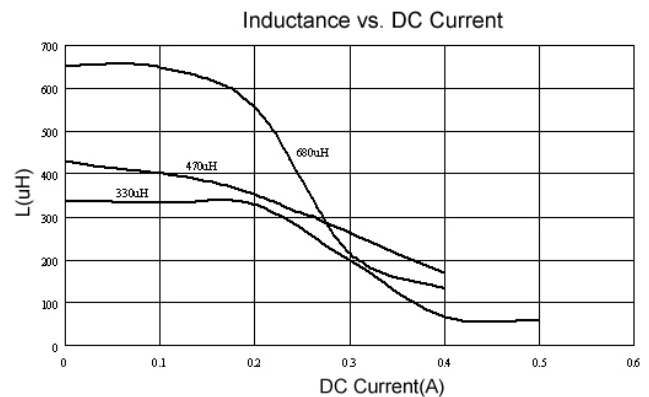
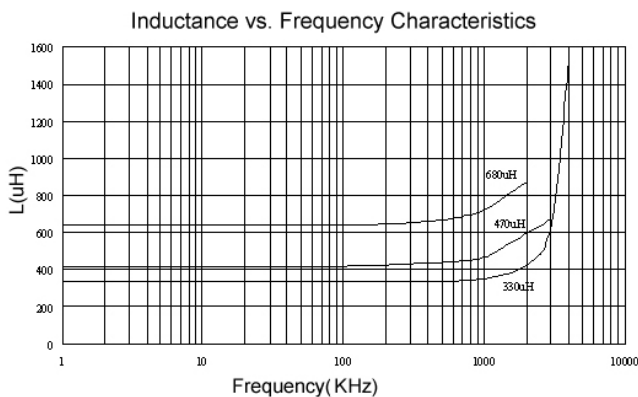

Please be sure to request approval specifications that provide further details of the products. Kindly note that the content of these specifications are subject to change or may be discontinued without advance notice. Please contact our sales department before ordering.

Electrical Characteristics

Part Number	Inductance (μH)	Tolerance ($\pm\%$)	SRF (MHz) Typ.	RDC (Ω) Max	Isat (A)	Irms (A)
SSL0804T-1R0M-N	1.0	20	100	0.009	9.0	6.8
SSL0804T-1R5M-N	1.5	20	90	0.010	8.0	6.4
SSL0804T-2R2M-N	2.2	20	80	0.012	7.0	6.1
SSL0804T-3R3M-N	3.3	20	65	0.015	6.4	5.4
SSL0804T-4R7M-N	4.7	20	45	0.018	5.4	4.8
SSL0804T-6R8M-N	6.8	20	38	0.027	4.6	4.4
SSL0804T-100M-N	10	20	30	0.038	3.8	3.9
SSL0804T-120M-N	12	20	27	0.0432	3.5	3.6
SSL0804T-150M-N	15	20	27	0.046	3.0	3.1
SSL0804T-220M-N	22	20	19	0.085	2.6	2.7
SSL0804T-330M-N	33	20	15	0.100	2.0	2.1
SSL0804T-470M-N	47	20	12	0.140	1.6	1.8
SSL0804T-680M-N	68	20	10	0.200	1.4	1.5
SSL0804T-101M-N	100	20	9	0.260	1.2	1.3
SSL0804T-151M-N	150	20	6	0.400	1.0	1.0
SSL0804T-221M-N	220	20	5	0.610	0.8	0.8
SSL0804T-331M-N	330	20	4.5	1.020	0.6	0.6
SSL0804T-471M-N	470	20	3.5	1.270	0.5	0.5
SSL0804T-681M-N	680	20	2.5	2.020	0.4	0.4
SSL0804T-102M-N	1000	20	2.0	3.000	0.3	0.3
SSL0804T-152M-N	1500	20	1.4	4.500	0.25	0.2

Note: When ordering, please specify tolerance code. Tolerance: M= $\pm 20\%$

- Operating temperature range - 40°C ~ 125°C(Including self - temperature rise)
- Isat for Inductance drop 20% from its value without current
- I rms for a 15°C temperature rise from 25°C ambient with current
- Measure Equipment :
 L : E4980 or HP4284A , 100kHz 0.1V
 SRF:HP4291A or HP4192A
 RDC : Chroma 16502
 Isat : HP4284A+HP42841A or WK3260B+WK3265B

Test Instruments :

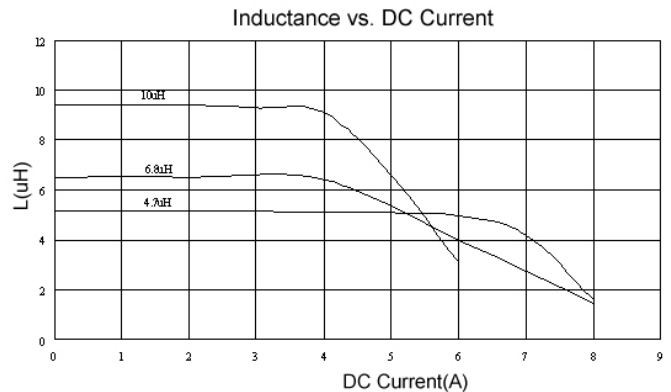
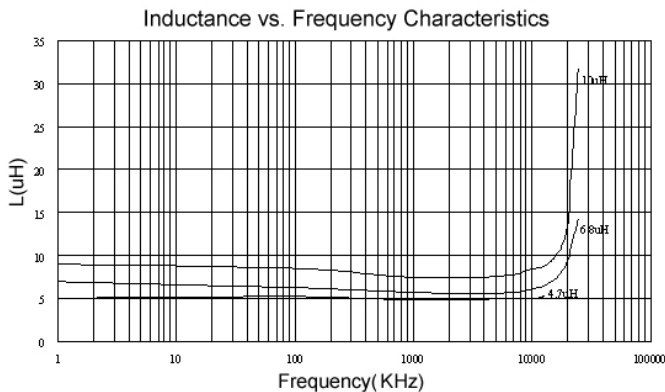

Please be sure to request approval specifications that provide further details of the products. Kindly note that the content of these specifications are subject to change or may be discontinued without advance notice. Please contact our sales department before ordering.

Electrical Characteristics

Part Number	Inductance (μH)	Tolerance ($\pm\%$)	SRF (MHz) Typ.	RDC (Ω) Max	Isat (A)	Irms (A)
SSL0810T-3R3M-N	3.3	20	30	0.025	10	4.0
SSL0810T-4R7M-N	4.7	20	25	0.033	8.0	3.5
SSL0810T-100M-N	10	20	22	0.033	8.0	3.5
SSL0810T-150M-N	15	20	18	0.042	7.0	3.0
SSL0810T-220M-N	22	20	11	0.054	5.5	2.5
SSL0810T-330M-N	33	20	9	0.08	4.0	2.0
SSL0810T-470M-N	47	20	8	0.10	3.8	1.6
SSL0810T-680M-N	68	20	7	0.17	3.0	1.2
SSL0810T-101M-N	100	20	5	0.22	2.5	1.2
SSL0810T-151M-N	150	20	4	0.34	2.0	0.9
SSL0810T-221M-N	220	20	3.5	0.44	1.6	0.7
SSL0810T-271M-N	270	20	2.5	0.60	1.4	0.6
SSL0810T-331M-N	330	20	2.5	0.70	1.2	0.6
SSL0810T-471M-N	470	20	2	0.95	1.0	0.3
SSL0810T-681M-N	680	20	2	1.2	1.0	0.2
SSL0810T-102M-N	1000	20	1.5	2.0	0.8	0.1

Note: When ordering, please specify tolerance code. Tolerance: M= $\pm 20\%$

- Operating temperature range - 40°C ~ 125°C(Including self - temperature rise)
- Isat for Inductance drop 20% from its value without current
- I rms for a 40°C temperature rise from 25°C ambient with current
- Measure Equipment :
 L : E4980 or HP4284A , 100kHz 0.1V
 SRF:HP4291A or HP4192A
 RDC : Chroma 16502
 Isat : HP4284A+HP42841A or WK3260B+WK3265B

Test Instruments :

Inductance vs. Frequency Characteristics

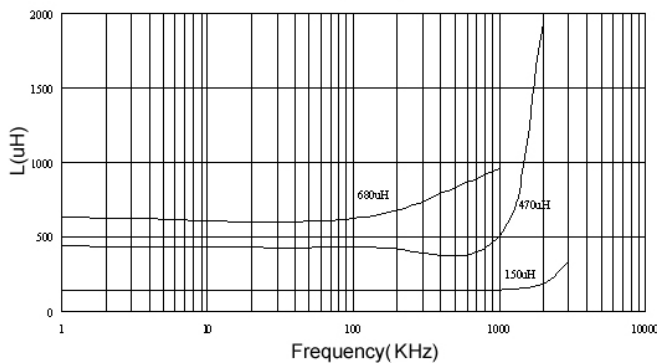

Inductance vs. DC Current

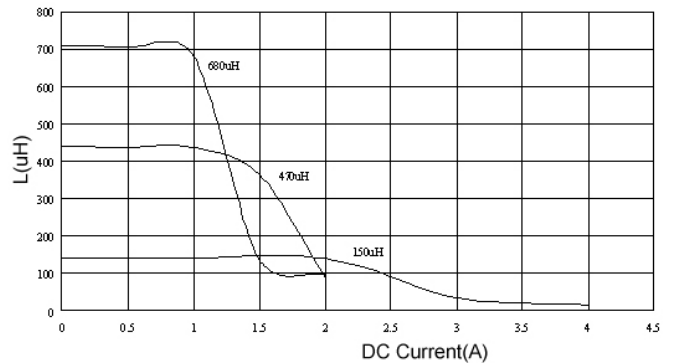

Please be sure to request approval specifications that provide further details of the products. Kindly note that the content of these specifications are subject to change or may be discontinued without advance notice. Please contact our sales department before ordering.

Electrical Characteristics

Part Number	Inductance (μH)	Tolerance ($\pm\%$)	SRF (MHz) Typ.	RDC ($\Omega+15\%$)	Isat (A)	Irms (A)
SSL1306T-1R0M-N	1.0	20	80	0.011	20	8.6
SSL1306T-2R2M-N	2.2	20	80	0.014	16	7.1
SSL1306T-3R3M-N	3.3	20	60	0.016	14	6.2
SSL1306T-4R7M-N	4.7	20	45	0.022	13	5.5
SSL1306T-5R6M-N	5.6	20	40	0.022	12	5.3
SSL1306T-6R8M-N	6.8	20	30	0.022	10	5.0
SSL1306T-100M-N	10	20	30	0.032	10	4.3
SSL1306T-150M-N	15	20	22	0.036	8.0	4.0
SSL1306T-180M-N	18	20	20	0.039	7.5	3.7
SSL1306T-220M-N	22	20	20	0.047	7.0	3.5
SSL1306T-330M-N	33	20	15	0.066	5.5	3.0
SSL1306T-470M-N	47	20	9	0.087	4.5	2.6
SSL1306T-680M-N	68	20	8	0.13	3.5	2.3
SSL1306T-101M-N	100	20	7	0.19	3.0	1.8
SSL1306T-151M-N	150	20	6	0.25	2.6	1.5
SSL1306T-221M-N	220	20	5	0.38	2.4	1.2
SSL1306T-331M-N	330	20	4	0.56	1.9	1.0
SSL1306T-471M-N	470	20	3	0.85	1.4	0.82
SSL1306T-681M-N	680	20	2.5	1.2	1.2	0.72
SSL1306T-102M-N	1000	20	2	1.8	1.0	0.56

Note: When ordering, please specify tolerance code. Tolerance: M= $\pm 20\%$

- Operating temperature range - 40°C ~ 125°C(Including self - temperature rise)
- Isat for Inductance drop 20% from its value without current
- I rms for a 40°C temperature rise from 25°C ambient with current
- Measure Equipment :
 L : E4980 or HP4284A , 100kHz 0.1V
 SRF:HP4291A or HP4192A
 RDC : Chroma 16502
 Isat : HP4284A+HP42841A or WK3260B+WK3265B

Test Instruments :

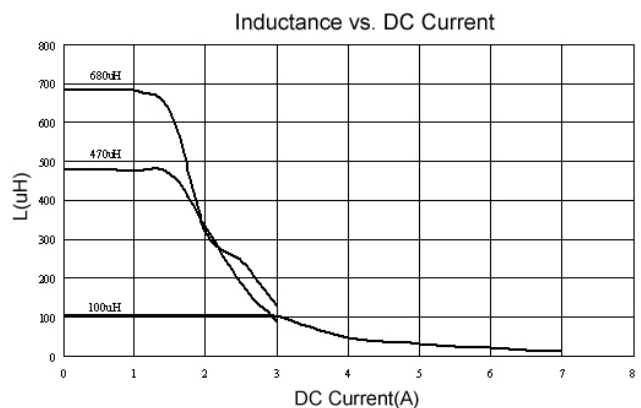
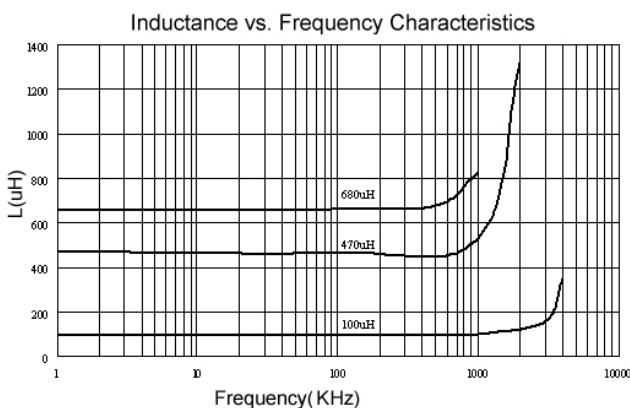

Please be sure to request approval specifications that provide further details of the products. Kindly note that the content of these specifications are subject to change or may be discontinued without advance notice. Please contact our sales department before ordering.

Packaging Specifications

Tape Dimensions

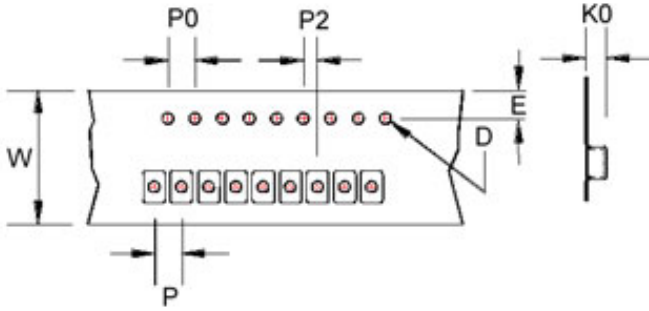

Tape Material

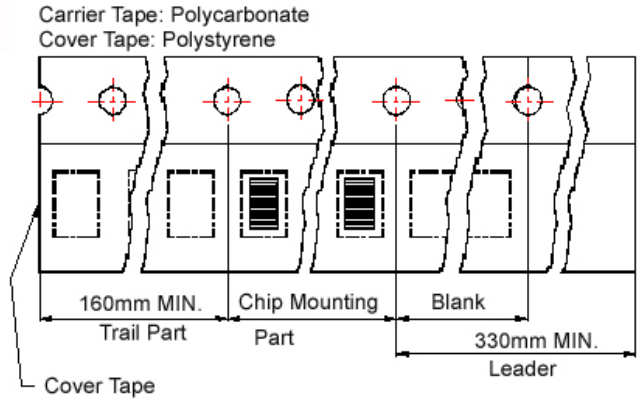

Reel Dimensions

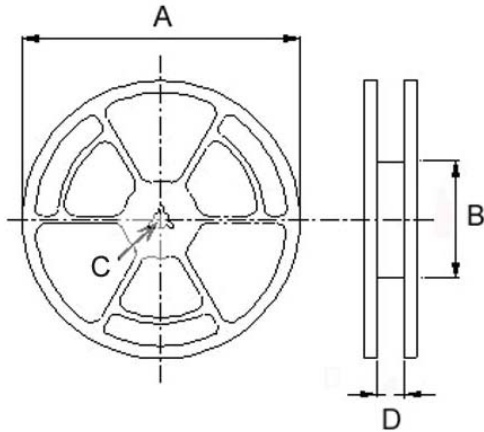

Dimensions in mm

TYPE	Tape Dimensions							Reel Dimensions				Quantity (PCS / REEL)	
	K0	D	E	W	P	P0	P2	A	B	C	D	178mm	330mm
SSL0402	3.2	1.55	1.75	12	8	4	2	330	100	13	13.4	-	2500
								178	60		13.2	750	-
SSL 0804	5.4	1.55	1.75	24	16	4	2	330	100	13	24.4	-	750
SSL 0810	11.5	1.55	1.75	24	20	4	2	330	100	13	24.4	-	225
SSL 1306	7.5	1.55	1.75	32	20	4	2	330	100	13	33.4	-	350

SSL-HC Series



This series is specially designed for high current, low voltage DC-DC converter applications. Its simple, rugged design provides current ratings normally available in larger packages. With tinned self-leaded construction, SSL-HC series can achieve very low DCR values and excellent solderability. In addition, they have very low resistance. Standard parts shown in catalogue and custom values are also available.

Features

- RoHS, Halogen Free and REACH Compliance
- Unshielded power inductor
- Various package size and wide inductance range. SSL-HC family is designed for low resistance and high current purpose

Applications

- DC/DC converters

Product Identification

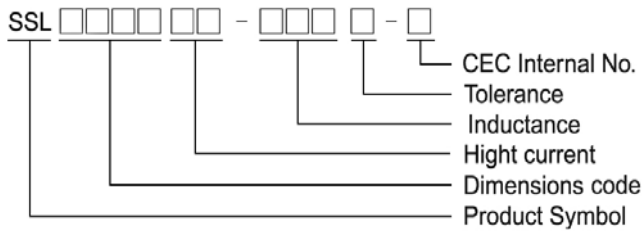

- Packaging: T : Tape and Reel , B : Bulk

Shape and Dimension

SSL0503HC

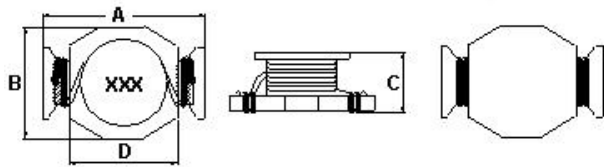

Dimension in mm

A	B	C	D
8.89 ⁺⁰	6.10 ⁺⁰	5.00 ⁺⁰	5.84

Recommended Pattern

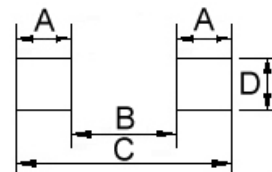

Dimension in mm

A	B	C	D
1.91	4.06	8.89	5.08

SSL0804HC

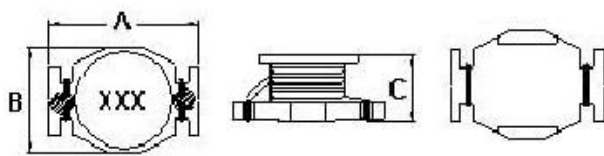

Dimension in mm

A	B	C
13.21 ⁺⁰	9.91 ⁺⁰	6.35 ⁺⁰

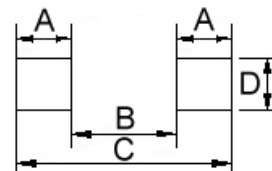

Dimension in mm

A	B	C	D
1.52	8.64	11.68	4.06

Electrical Characteristics

Part Number	Inductance (μH)	Tolerance (±%)	SRF (MHz) Typ.	RDC (Ω) Max	Isat (A)	Irms (A)
SSL0503HC-R33M-N	0.33	20	330	0.007	8.2	7.0
SSL0503HC-R56M-N	0.56	20	200	0.010	7.7	6.0
SSL0503HC-1R0M-N	1.0	20	140	0.017	5.3	4.4
SSL0503HC-1R2M-N	1.2	20	140	0.017	5.3	4.4
SSL0503HC-1R6M-N	1.6	20	100	0.022	4.5	4.0
SSL0503HC-2R2M-N	2.2	20	100	0.035	3.5	3.1
SSL0503HC-4R7M-N	4.7	20	50	0.054	2.6	2.2
SSL0503HC-6R8M-N	6.8	20	45	0.070	2.0	1.8
SSL0503HC-100M-N	10	20	40	0.111	1.9	1.5
SSL0503HC-150M-N	15	20	30	0.17	1.5	1.2
SSL0503HC-220M-N	22	20	25	0.25	1.2	1.0
SSL0503HC-270M-N	27	20	20	0.32	1.0	0.85
SSL0503HC-330M-N	33	20	20	0.37	0.99	0.82
SSL0503HC-470M-N	47	20	15	0.47	0.87	0.72

Note: When ordering, please specify tolerance code. Tolerance: M=±20%

- Operating temperature range - 40°C ~ 125°C(Including self - temperature rise)
- Isat for Inductance drop 30% from its value without current
- I rms for a 40°C temperature rise from 25°C ambient with current
- Measure Equipment :
 L : E4980 or HP4284A , 100kHz 0.25V
 SRF : HP4291A or HP4192A
 RDC : Chroma 16502
 Isat : HP4284A+HP42841A or WK3260B+WK3265B

Test Instruments :

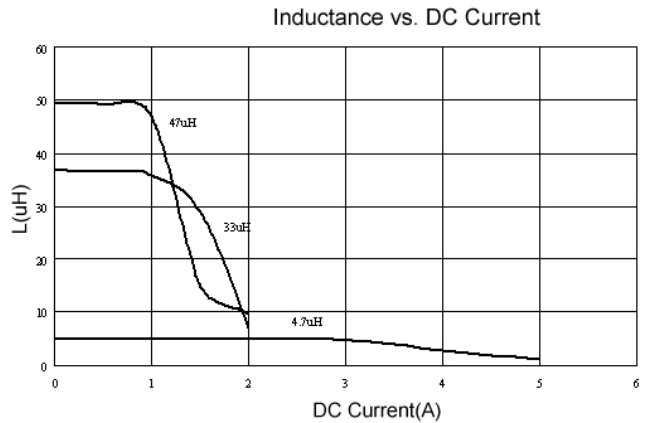
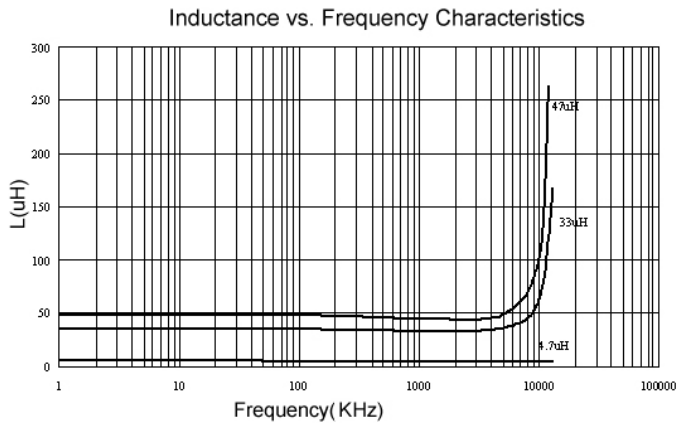

Please be sure to request approval specifications that provide further details of the products. Kindly note that the content of these specifications are subject to change or may be discontinued without advance notice. Please contact our sales department before ordering.

Electrical Characteristics

Part Number	Inductance (μ H)	Tolerance (\pm %)	SRF (MHz) Typ.	RDC (Ω) Max	Isat (A)	Irms (A)
SSL0804HC-R33M-N	0.33	20	300	0.002	20.0	16.0
SSL0804HC-R68M-N	0.68	20	200	0.005	13.0	12.0
SSL0804HC-1R0M-N	1.0	20	100	0.006	11.0	10.0
SSL0804HC-1R5M-N	1.5	20	90	0.008	9.0	9.0
SSL0804HC-2R2M-N	2.2	20	90	0.011	7.8	7.4
SSL0804HC-2R7M-N	2.7	20	65	0.012	7.0	6.6
SSL0804HC-3R3M-N	3.3	20	65	0.014	6.4	5.9
SSL0804HC-4R7M-N	4.7	20	45	0.018	5.4	4.8
SSL0804HC-6R8M-N	6.8	20	35	0.035	3.6	5.0
SSL0804HC-100M-N	10	20	26	0.04	3.3	4.3
SSL0804HC-150M-N	15	20	21	0.06	2.4	3.5
SSL0804HC-220M-N	22	20	17	0.08	2.0	2.8
SSL0804HC-330M-N	33	20	14	0.15	1.7	2.1
SSL0804HC-470M-N	47	20	12	0.28	1.4	1.7
SSL0804HC-680M-N	68	20	9	0.3	1.2	1.5
SSL0804HC-101M-N	100	20	7	0.4	0.95	1.2

Note: When ordering, please specify tolerance code. Tolerance: M= \pm 20%

- Operating temperature range - 40°C ~ 125°C(Including self - temperature rise)
- Isat for Inductance drop 10% from its value without current
- I rms for a 40°C temperature rise from 25°C ambient with current
- Measure Equipment :
 L : E4980 or HP4284A , 100kHz 0.1V
 SRF : HP4291A or HP4192A
 RDC : Chroma 16502
 Isat : HP4284A+HP42841A or WK3260B+WK3265B.

Test Instruments :

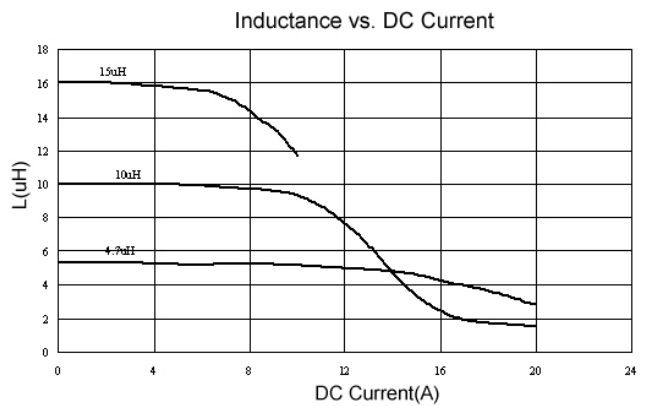
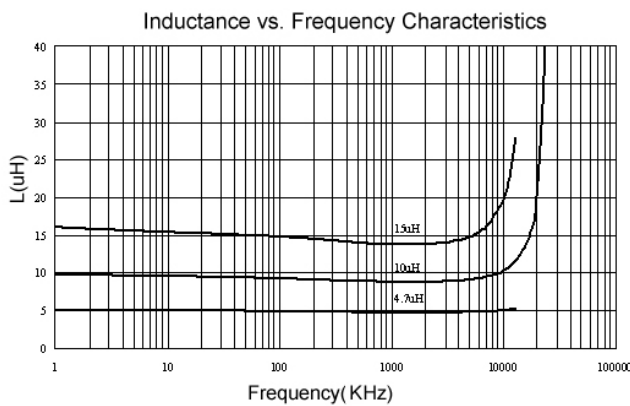

Please be sure to request approval specifications that provide further details of the products. Kindly note that the content of these specifications are subject to change or may be discontinued without advance notice. Please contact our sales department before ordering.

Packaging Specifications

Tape Dimensions

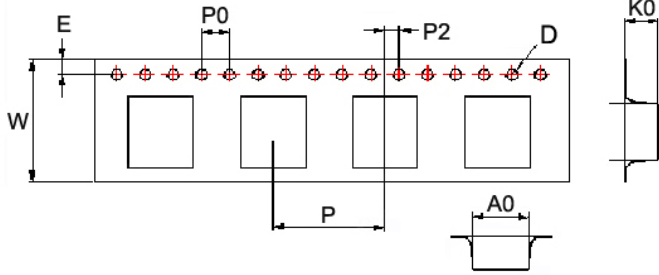

Tape Material

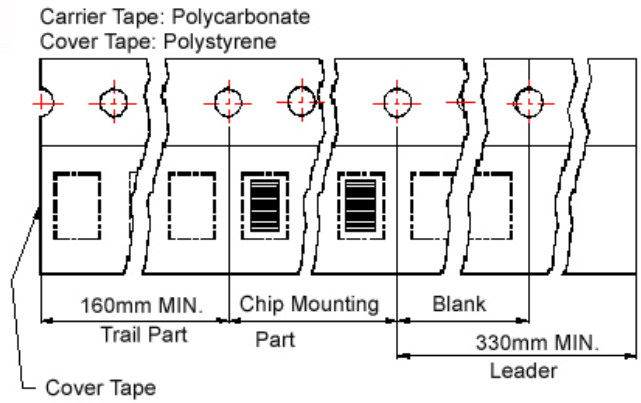

Reel Dimensions

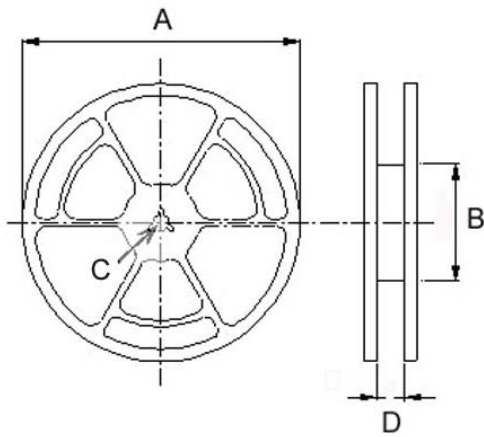

Dimensions in mm

TPYE	Tape Dimensions							Reel Dimensions				Quantity PCS / Reel
	K0	D	E	W	P	P0	P2	A	B	C	D	
SSL 0503HC	5.3	1.55	1.75	16	12	4	2	330	100	13	16.0	1000
SSL 0804HC	6.1	1.55	1.75	24	16	4	2	330	100	13	24.2	700

TFL Series



The TFL Series is designed for miniaturized devices, featuring low inductance, high precision and low loss. It allows for easy impedance matching for both RF and IF circuit designs as well as compact high frequency circuit designs

Features

- Ultra small size
- Excellent Q factor and SRF characteristics
- Minimal deviation in inductance
- Finely graded inductance level

Applications

- RF and wireless communication
- Bluetooth, cellular phone, ultrabook, telecommunications, W-LAN
- High frequency circuits in general

Product Identification

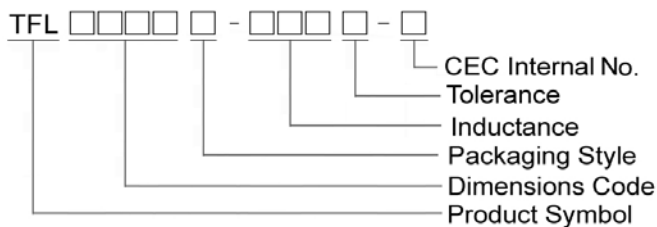

Shape and Dimensions

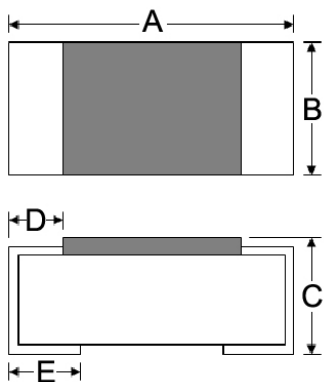

Dimensions in mm

TYPE	A	B	C	D	E
TFL0603	0.61±0.05	0.31±0.05	0.30±0.05	0.10±0.05	0.15±0.05

Recommended Pattern

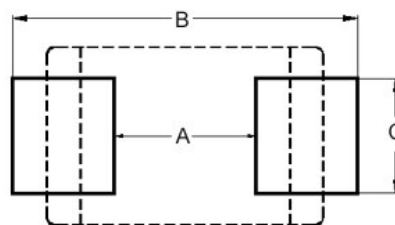

Dimensions in mm

TYPE	A	B	C
TFL0603	0.3	0.75 ~ 1.05	0.3

Electrical Characteristics

Part Number	Inductance (nH)	Tolerance (±%)	Q Min	Test Frequency (MHz)	SRF (MHz) Typ	RDC (Ω) Max	Rated Current (mA) Max
TFL0603T-0N6□-S	0.6	±0.1nH/±0.2nH	14	500 / 500mV	6000	0.10	900
TFL0603T-0N7□-S	0.7	±0.1nH/±0.2nH	14	500 / 500mV	6000	0.10	850
TFL0603T-0N8□-S	0.8	±0.1nH/±0.2nH	14	500 / 500mV	6000	0.10	850
TFL0603T-0N9□-S	0.9	±0.1nH/±0.2nH	14	500 / 500mV	6000	0.10	800
TFL0603T-1N0□-S	1.0	±0.1nH/±0.2nH	14	500 / 500mV	6000	0.10	800
TFL0603T-1N1□-S	1.1	±0.1nH/±0.2nH	14	500 / 500mV	6000	0.10	800
TFL0603T-1N2□-S	1.2	±0.1nH/±0.2nH	14	500 / 500mV	6000	0.10	800
TFL0603T-1N3□-S	1.3	±0.1nH/±0.2nH	14	500 / 500mV	6000	0.12	650
TFL0603T-1N4□-S	1.4	±0.1nH/±0.2nH	14	500 / 500mV	6000	0.13	650
TFL0603T-1N5□-S	1.5	±0.1nH/±0.2nH	14	500 / 500mV	6000	0.16	650
TFL0603T-1N6□-S	1.6	±0.1nH/±0.2nH	14	500 / 500mV	6000	0.16	650
TFL0603T-1N7□-S	1.7	±0.1nH/±0.2nH	14	500 / 500mV	6000	0.20	650
TFL0603T-1N8□-S	1.8	±0.1nH/±0.2nH	14	500 / 500mV	6000	0.20	650
TFL0603T-1N9□-S	1.9	±0.1nH/±0.2nH	14	500 / 500mV	6000	0.20	620
TFL0603T-2N0□-S	2.0	±0.1nH/±0.2nH	14	500 / 500mV	6000	0.20	620
TFL0603T-2N1□-S	2.1	±0.1nH/±0.2nH	14	500 / 500mV	6000	0.20	620
TFL0603T-2N2□-S	2.2	±0.1nH/±0.2nH	14	500 / 500mV	6000	0.20	620
TFL0603T-2N3□-S	2.3	±0.1nH/±0.2nH	14	500 / 500mV	6000	0.20	500
TFL0603T-2N4□-S	2.4	±0.1nH/±0.2nH	14	500 / 500mV	6000	0.20	500
TFL0603T-2N5□-S	2.5	±0.1nH/±0.2nH	14	500 / 500mV	6000	0.20	500
TFL0603T-2N6□-S	2.6	±0.1nH/±0.2nH	14	500 / 500mV	6000	0.20	500
TFL0603T-2N7□-S	2.7	±0.1nH/±0.2nH	14	500 / 500mV	6000	0.23	500
TFL0603T-2N8□-S	2.8	±0.1nH/±0.2nH	14	500 / 500mV	6000	0.25	500
TFL0603T-2N9□-S	2.9	±0.1nH/±0.2nH	14	500 / 500mV	6000	0.25	500
TFL0603T-3N0□-S	3.0	±0.1nH/±0.2nH	14	500 / 500mV	6000	0.30	450
TFL0603T-3N1□-S	3.1	±0.1nH/±0.2nH	14	500 / 500mV	6000	0.30	450
TFL0603T-3N2□-S	3.2	±0.1nH/±0.2nH	14	500 / 500mV	6000	0.30	450
TFL0603T-3N3□-S	3.3	±0.1nH/±0.2nH	14	500 / 500mV	6000	0.30	450
TFL0603T-3N4□-S	3.4	±0.1nH/±0.2nH	14	500 / 500mV	6000	0.32	450
TFL0603T-3N5□-S	3.5	±0.1nH/±0.2nH	14	500 / 500mV	6000	0.32	450
TFL0603T-3N6□-S	3.6	±0.1nH/±0.2nH	14	500 / 500mV	6000	0.32	400
TFL0603T-3N7□-S	3.7	±0.1nH/±0.2nH	14	500 / 500mV	6000	0.40	400
TFL0603T-3N8□-S	3.8	±0.1nH/±0.2nH	14	500 / 500mV	6000	0.40	350
TFL0603T-3N9□-S	3.9	±0.1nH/±0.2nH	14	500 / 500mV	5700	0.40	350
TFL0603T-4N3□-S	4.3	3 / 5	14	500 / 500mV	5300	0.40	300
TFL0603T-4N7□-S	4.7	3 / 5	14	500 / 500mV	4400	0.45	280
TFL0603T-5N1□-S	5.1	3 / 5	14	500 / 500mV	4200	0.50	270
TFL0603T-5N6□-S	5.6	3 / 5	14	500 / 500mV	4000	0.55	260
TFL0603T-6N2□-S	6.2	3 / 5	14	500 / 500mV	4000	0.60	250
TFL0603T-6N8□-S	6.8	3 / 5	14	500 / 500mV	3900	0.70	230
TFL0603T-7N5□-S	7.5	3 / 5	12	500 / 500mV	3700	1.10	180
TFL0603T-8N2□-S	8.2	3 / 5	12	500 / 500mV	3600	1.20	180
TFL0603T-9N1□-S	9.1	3 / 5	12	500 / 500mV	3300	1.20	180
TFL0603T-10N□-S	10	3 / 5	12	500 / 500mV	3200	1.30	180

Please be sure to request approval specifications that provide further details of the products. Kindly note that the content of these specifications are subject to change or may be discontinued without advance notice. Please contact our sales department before ordering.

Electrical Characteristics

Part Number	Inductance (nH)	Tolerance (±%)	Q Min	Test Frequency (MHz)	SRF (MHz) Typ	RDC (Ω) Max	Rated Current (mA) Max
TFL0603T-12N□-S	12	3 / 5	12	500 / 500mV	2900	1.30	180
TFL0603T-15N□-S	15	3 / 5	12	500 / 500mV	2600	1.50	180
TFL0603T-18N□-S	18	3 / 5	12	500 / 500mV	2200	1.70	160
TFL0603T-22N□-S	22	3 / 5	12	500 / 500mV	2200	2.55	120

Note: When ordering, please specify tolerance code. Tolerance: B=±0.1nH, C=±0.2nH, H=±3%, J=±5%

- Operating temperature range - 55°C ~ 125°C(Including self - temperature rise)
- Rated Current : Applied the current to coils, the inductance shall be less than 10% initial value
- Measure Equipment :
 L & Q : Agilent E4991A+Agilent 16197A
 SRF : HP8753D
 RDC : HP4338B or CHEN HWA 502

Test Instruments : Agilent E4991A Material/Impedance Analyzer

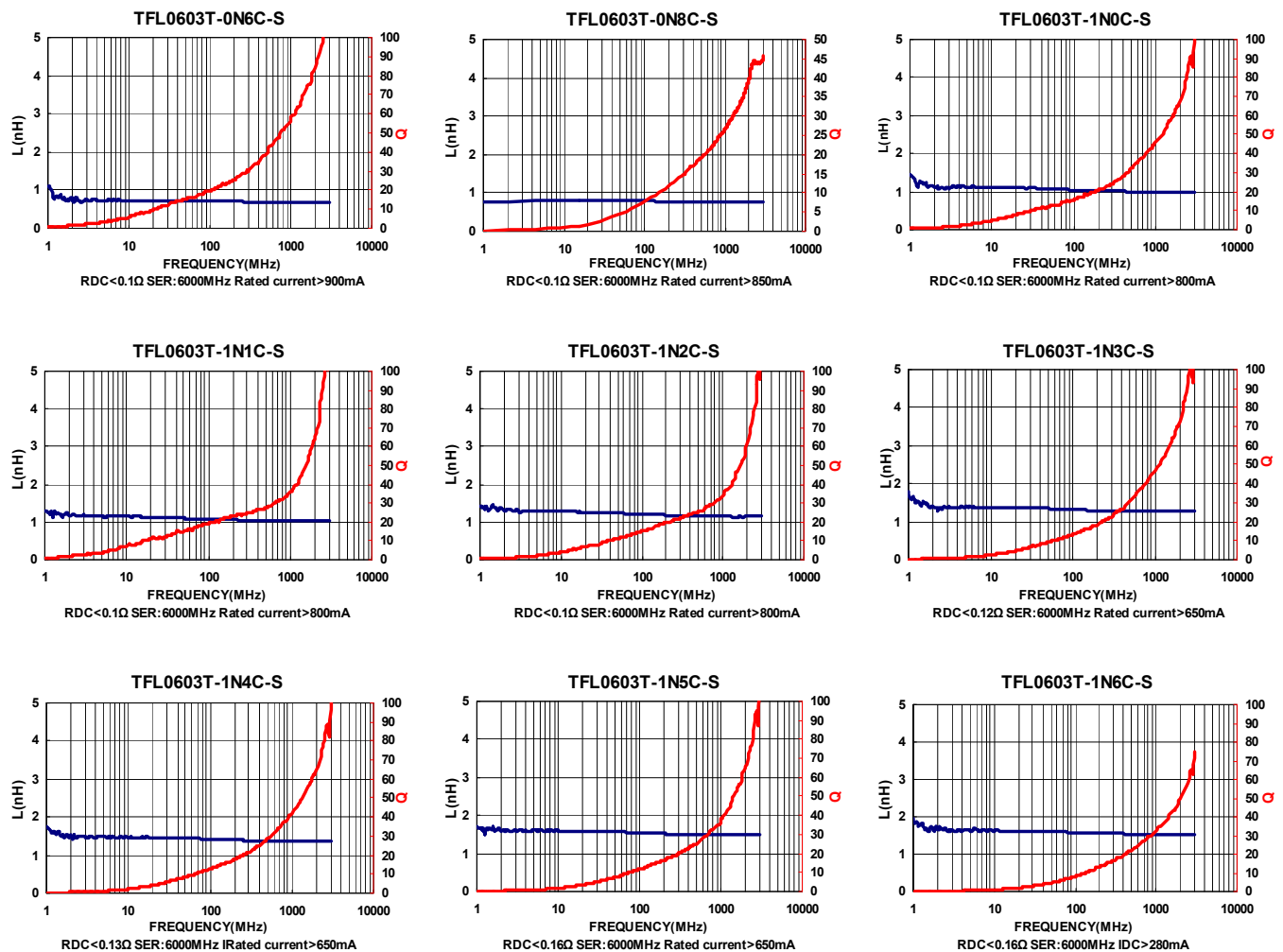

Please be sure to request approval specifications that provide further details of the products. Kindly note that the content of these specifications are subject to change or may be discontinued without advance notice. Please contact our sales department before ordering.

Test Instruments : Agilent E4991A Material/Impedance Analyzer

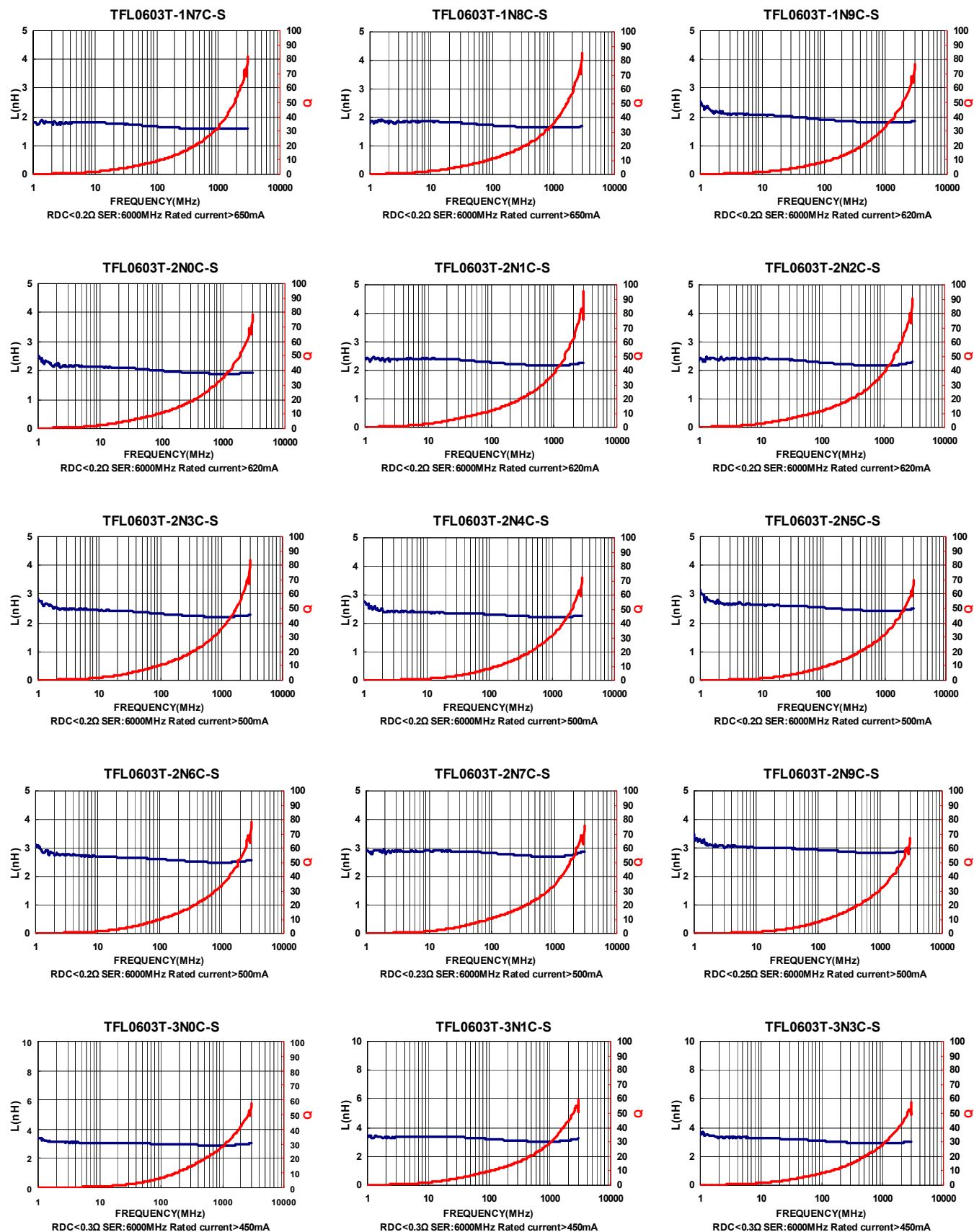

Please be sure to request approval specifications that provide further details of the products. Kindly note that the content of these specifications are subject to change or may be discontinued without advance notice. Please contact our sales department before ordering.

Test Instruments : Agilent E4991A Material/Impedance Analyzer

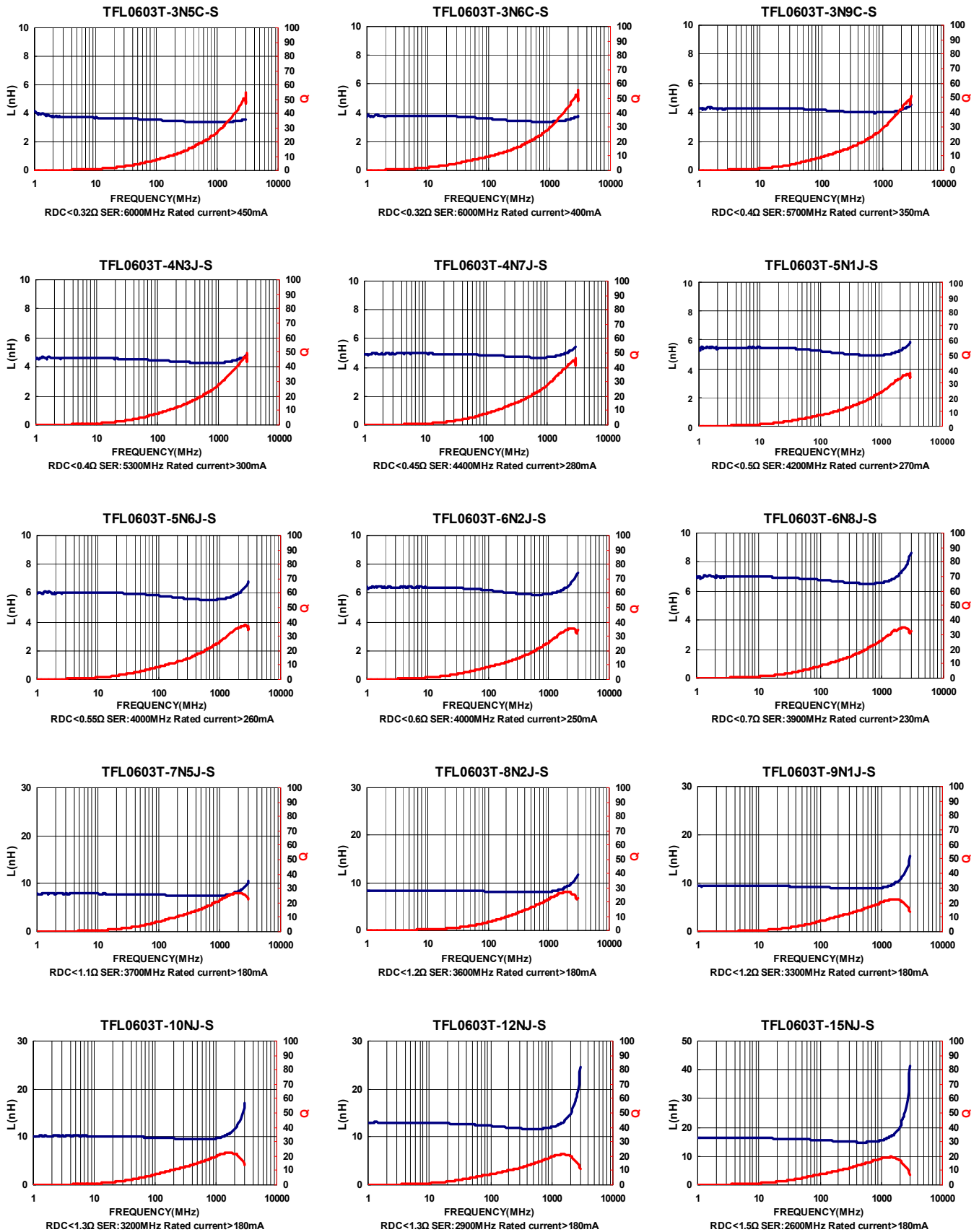

Please be sure to request approval specifications that provide further details of the products. Kindly note that the content of these specifications are subject to change or may be discontinued without advance notice. Please contact our sales department before ordering.

Test Instruments : Agilent E4991A Material/Impedance Analyzer

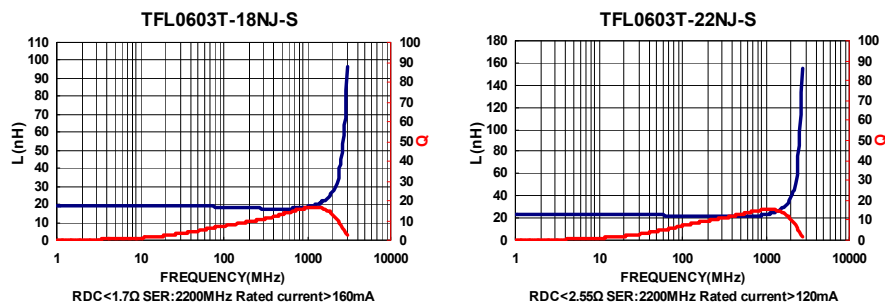

Packaging Specifications

Tape Dimensions

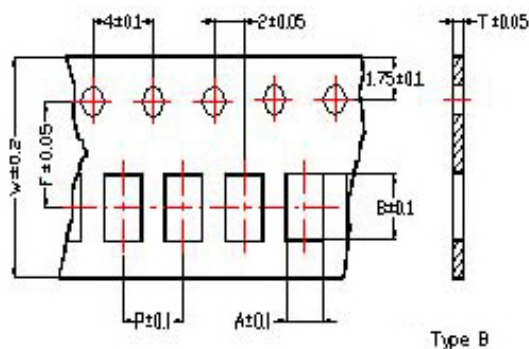

Tape Material

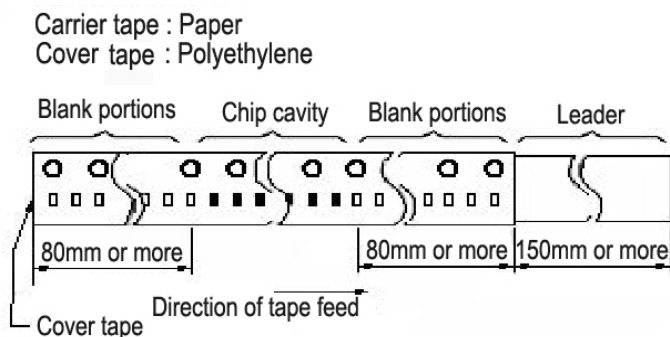

Reel Dimensions

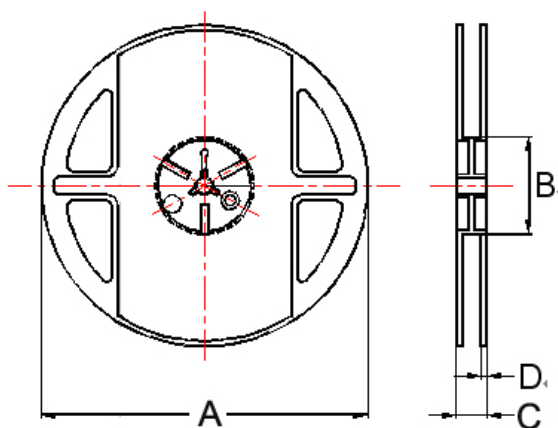

Dimensions in mm

TYPE	Tape Dimensions						Reel Dimensions				Quantity PCS / Reel
	A	B	T	W	P	F	A	B	C	D	
TFL0603	0.37	0.67	0.42	8	2	3.5	180	60	13	1.5	15000

Please be sure to request approval specifications that provide further details of the products. Kindly note that the content of these specifications are subject to change or may be discontinued without advance notice. Please contact our sales department before ordering.

THQ Series



THQ Series is a type of ceramic chip inductor produced using thin film technology designed for miniaturized devices, featuring low inductance and high precision. It is suitable for high frequency applications

Features

- High frequency application
- Miniaturization
- Tight tolerance

Applications

- RF matching circuit requiring Q value
- Bluetooth, WLAN, UWB, digital TV tuners and high-frequency circuit and module

Product Identification

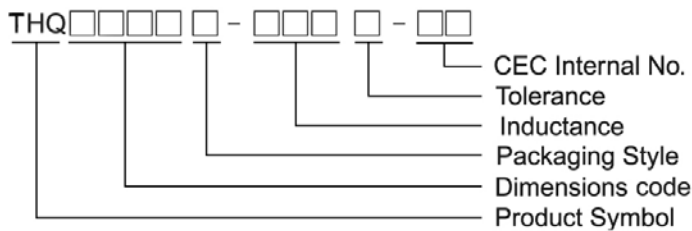

Shape and Dimensions

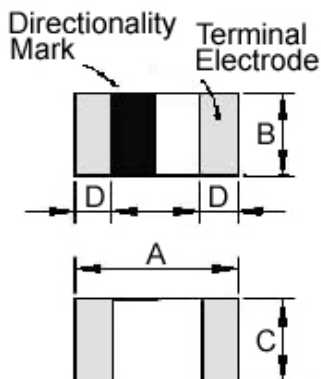

Dimensions in mm

TYPE	A	B	C	D
THQ0402	0.4±0.02	0.2±0.02	0.2±0.02	0.095±0.025

Recommended Pattern

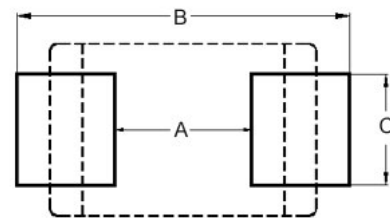

Dimensions in mm

TYPE	A	B	C
THQ0402	0.16~0.2	0.4 ~ 0.56	0.2~0.23

Electrical Characteristics

Part Number	Inductance (nH)	Tolerance (±%)	Q Min	Test Frequency (MHz)	SRF (MHz) Min	RDC (Ω) Max	IDC (mA) Max
THQ0402T-1N0B-H	1.0	±0.1nH	8	500	10000	0.60	220
THQ0402T-1N2B-H	1.2	±0.1nH	8	500	10000	0.60	220
THQ0402T-1N5B-H	1.5	±0.1nH	8	500	9500	0.60	220
THQ0402T-1N8B-H	1.8	±0.1nH	8	500	9000	0.70	200
THQ0402T-2N0B-H	2.0	±0.1nH	8	500	9000	0.75	200
THQ0402T-2N2B-H	2.2	±0.1nH	8	500	7500	0.75	200
THQ0402T-2N7B-H	2.7	±0.1nH	8	500	7500	0.80	200

Note: When ordering, please specify tolerance code. Tolerance : B=±0.1nH , C=±0.2nH , S=±0.3nH

- Operating temperature range - 55°C ~ 125°C(Including self - temperature rise)
- IDC : Applied the current to coils, the inductance shall be less than 10% initial value
- Residual impedance of short chip : 0.11nH
- Measure Equipment :
 L & Q : Agilent E4991A+Agilent 16197A
 SRF : Agilent E4991A or HP19196C
 RDC : HP4338B or CHEN HWA 502

Test Instruments : Agilent E4991A Material/Impedance Analyzer

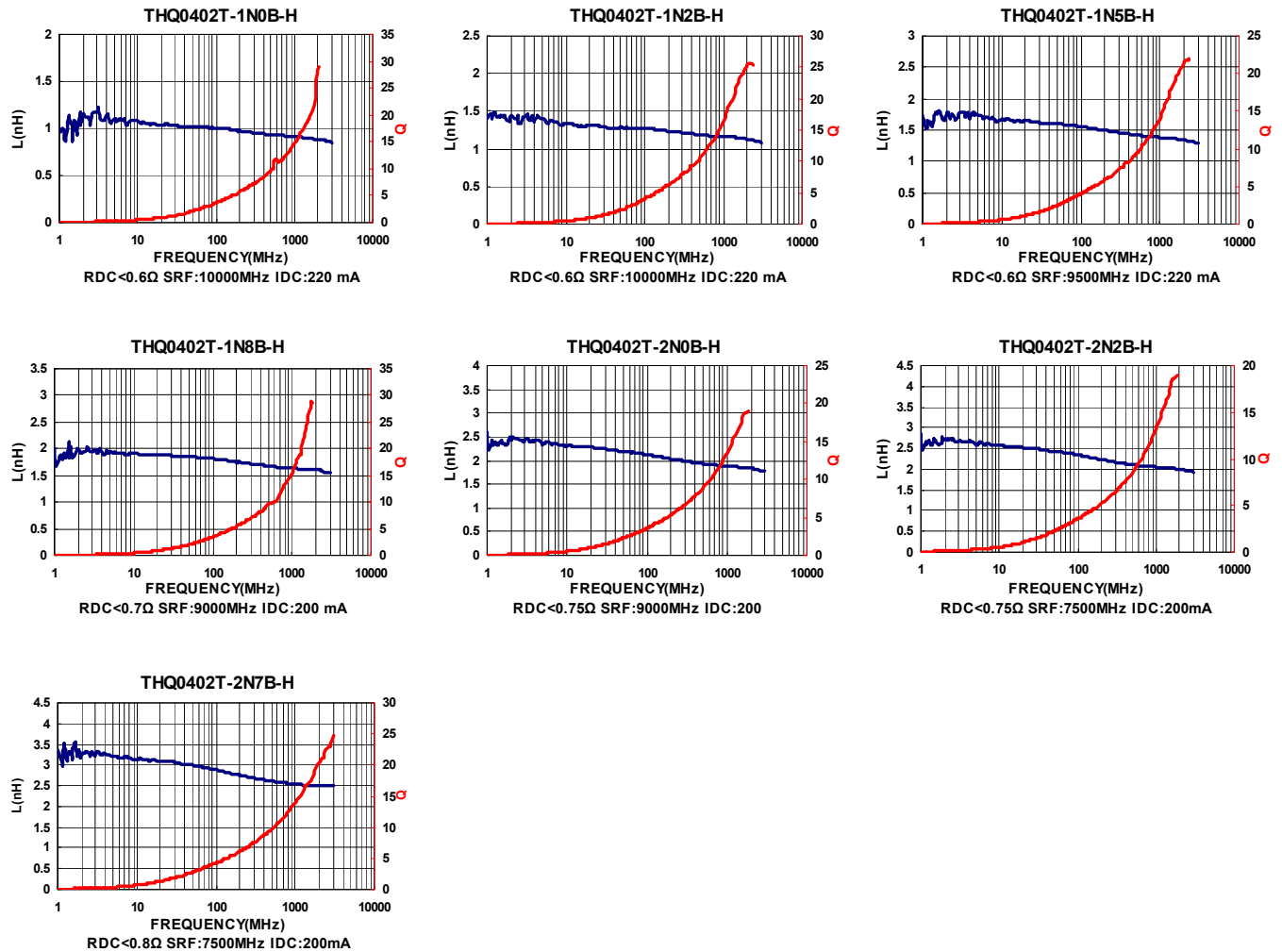

Please be sure to request approval specifications that provide further details of the products. Kindly note that the content of these specifications are subject to change or may be discontinued without advance notice. Please contact our sales department before ordering.

CHQ Series



CHQ Series supports miniaturized devices. Its low inductance, high precision and high Q enables easy impedance matching at both RF and IF circuits and compact high frequency circuit designing.

Features

- Excellent high frequency application
- High Q factor and SRF value
- Miniaturization
- Tight tolerance
- Wide inductance range

Applications

- RF matching circuit requiring Q value
- Bluetooth, WLAN, UWB, digital TV tuners and high-frequency circuit and module

Product Identification

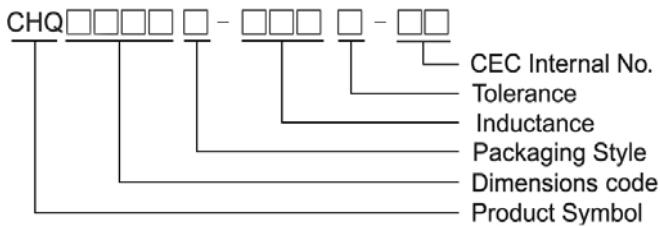

Shape and Dimensions

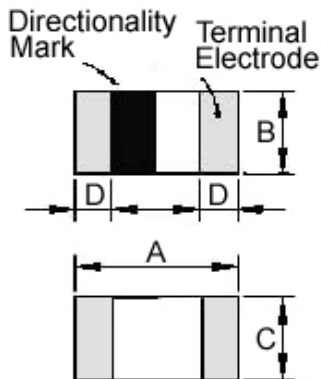

Dimensions in mm

TYPE	A	B	C	D
CHQ0603	0.6±0.03	0.3±0.03	0.3±0.03	0.15±0.05
CHQ1005	1.0±0.10	0.5±0.10	0.5±0.10	0.25±0.10

Recommended Pattern

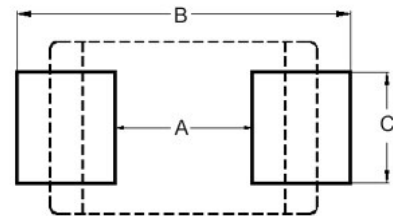

Dimensions in mm

TYPE	A	B	C
CHQ0603	0.3	0.75 ~ 1.05	0.3
CHQ1005	0.4	1.2 ~ 1.4	0.5

Electrical Characteristics

Part Number	Inductance (nH)	Tolerance (±%)	Q Min	Test Frequency (MHz)	Q Typical					SRF (MHz) Min	RDC (Ω) Max	IDC (mA) Max
					500 MHz	800 MHz	1.8 GHz	2.0 GHz	2.4 GHz			
CHQ0603T-0N6□-HU	0.6	±0.1nH/±0.2nH/±0.3nH	14	500	>35	>47	>75	>80	>88	10000	0.06	900
CHQ0603T-0N7□-HU	0.7	±0.1nH/±0.2nH/±0.3nH	14	500	>35	>47	>75	>80	>88	10000	0.06	900
CHQ0603T-0N8□-HU	0.8	±0.1nH/±0.2nH/±0.3nH	14	500	>35	>47	>75	>80	>88	10000	0.06	900
CHQ0603T-0N9□-HU	0.9	±0.1nH/±0.2nH/±0.3nH	14	500	>35	>47	>75	>80	>88	10000	0.06	900
CHQ0603T-1N0□-HU	1.0	±0.1nH/±0.2nH/±0.3nH	14	500	>35	>47	>75	>80	>88	10000	0.07	850
CHQ0603T-1N1□-HU	1.1	±0.1nH/±0.2nH/±0.3nH	14	500	>35	>47	>75	>80	>88	10000	0.07	850
CHQ0603T-1N2□-HU	1.2	±0.1nH/±0.2nH/±0.3nH	14	500	35	47	75	80	88	10000	0.08	800
CHQ0603T-1N3□-HU	1.3	±0.1nH/±0.2nH/±0.3nH	14	500	32	43	70	74	82	10000	0.09	760
CHQ0603T-1N4□-HU	1.4	±0.1nH/±0.2nH/±0.3nH	14	500	29	39	63	67	75	10000	0.12	640
CHQ0603T-1N5□-HU	1.5	±0.1nH/±0.2nH/±0.3nH	14	500	27	36	59	62	69	10000	0.15	600
CHQ0603T-1N6□-HU	1.6	±0.1nH/±0.2nH/±0.3nH	14	500	25	33	54	57	63	10000	0.19	510
CHQ0603T-1N7□-HU	1.7	±0.1nH/±0.2nH/±0.3nH	14	500	25	32	52	54	61	10000	0.11	680
CHQ0603T-1N8□-HU	1.8	±0.1nH/±0.2nH/±0.3nH	14	500	25	32	51	53	59	10000	0.12	640
CHQ0603T-1N9□-HU	1.9	±0.1nH/±0.2nH/±0.3nH	14	500	24	31	50	53	58	10000	0.13	620
CHQ0603T-2N0□-HU	2.0	±0.1nH/±0.2nH/±0.3nH	14	500	24	31	50	53	58	10000	0.15	600
CHQ0603T-2N1□-HU	2.1	±0.1nH/±0.2nH/±0.3nH	14	500	24	31	50	53	58	10000	0.16	550
CHQ0603T-2N2□-HU	2.2	±0.1nH/±0.2nH/±0.3nH	14	500	24	31	50	53	58	10000	0.20	500
CHQ0603T-2N3□-HU	2.3	±0.1nH/±0.2nH/±0.3nH	14	500	24	31	49	52	58	10000	0.24	460
CHQ0603T-2N4□-HU	2.4	±0.1nH/±0.2nH/±0.3nH	14	500	22	28	45	48	53	10000	0.26	430
CHQ0603T-2N5□-HU	2.5	±0.1nH/±0.2nH/±0.3nH	14	500	22	29	46	49	54	10000	0.28	415
CHQ0603T-2N6□-HU	2.6	±0.1nH/±0.2nH/±0.3nH	14	500	21	27	44	46	51	10000	0.30	405
CHQ0603T-2N7□-HU	2.7	±0.1nH/±0.2nH/±0.3nH	14	500	20	26	41	43	48	10000	0.32	400
CHQ0603T-2N8□-HU	2.8	±0.1nH/±0.2nH/±0.3nH	14	500	20	26	41	43	47	9500	0.20	500
CHQ0603T-2N9□-HU	2.9	±0.1nH/±0.2nH/±0.3nH	14	500	20	26	41	43	47	9300	0.22	480
CHQ0603T-3N0□-HU	3.0	±0.1nH/±0.2nH/±0.3nH	14	500	20	26	41	43	47	9100	0.24	460
CHQ0603T-3N1□-HU	3.1	±0.1nH/±0.2nH/±0.3nH	14	500	20	26	41	43	47	8900	0.25	450
CHQ0603T-3N2□-HU	3.2	±0.1nH/±0.2nH/±0.3nH	14	500	20	26	40	43	47	8700	0.28	415
CHQ0603T-3N3□-HU	3.3	±0.1nH/±0.2nH/±0.3nH	14	500	20	26	40	43	47	8600	0.28	415
CHQ0603T-3N4□-HU	3.4	±0.1nH/±0.2nH/±0.3nH	14	500	20	25	40	43	47	8400	0.29	410
CHQ0603T-3N5□-HU	3.5	±0.1nH/±0.2nH/±0.3nH	14	500	20	25	40	42	46	8200	0.30	405
CHQ0603T-3N6□-HU	3.6	±0.1nH/±0.2nH/±0.3nH	14	500	19	25	40	42	46	8100	0.32	400
CHQ0603T-3N7□-HU	3.7	±0.1nH/±0.2nH/±0.3nH	14	500	19	25	40	42	46	8000	0.36	370
CHQ0603T-3N8□-HU	3.8	±0.1nH/±0.2nH/±0.3nH	14	500	19	25	39	41	45	7800	0.40	355
CHQ0603T-3N9□-HU	3.9	±0.1nH/±0.2nH/±0.3nH	14	500	19	25	39	41	45	7700	0.41	350
CHQ0603T-4N3□-HU	4.3	±0.2nH/±0.3nH	14	500	18	24	37	39	43	6500	0.48	320
CHQ0603T-4N7□-HU	4.7	±0.2nH/±0.3nH	14	500	19	24	37	39	42	6400	0.42	350
CHQ0603T-5N1□-HU	5.1	±0.2nH/±0.3nH	14	500	19	24	37	39	42	6100	0.45	330
CHQ0603T-5N6□-HU	5.6	±0.2nH/±0.3nH	14	500	18	24	36	37	41	5500	0.47	325
CHQ0603T-6N2□-HU	6.2	±0.2nH/±0.3nH	14	500	18	23	35	36	39	5100	0.52	305
CHQ0603T-6N8□-HU	6.8	3 / 5	14	500	18	23	35	36	39	4800	0.55	305
CHQ0603T-7N5□-HU	7.5	3 / 5	14	500	18	23	34	35	38	4600	0.55	305
CHQ0603T-8N2□-HU	8.2	3 / 5	14	500	17	22	33	34	36	4300	0.57	290
CHQ0603T-9N1□-HU	9.1	3 / 5	14	500	17	22	33	34	36	4000	0.65	270
CHQ0603T-10N□-HU	10	3 / 5	14	500	17	22	33	34	36	3800	0.85	230
CHQ0603T-12N□-HU	12	3 / 5	14	500	17	22	31	32	33	3300	0.85	230
CHQ0603T-15N□-HU	15	3 / 5	14	500	17	21	28	29	29	2600	0.89	220
CHQ0603T-18N□-HU	18	3 / 5	14	500	16	21	26	26	25	2300	1.05	205
CHQ0603T-22N□-HU	22	3 / 5	14	500	16	21	26	26	24	1900	1.29	190

Note: When ordering, please specify tolerance code. Tolerance : B=±0.1nH , C=±0.2nH , S=±0.3nH , H=±3% , J=±5%

- Operating temperature range - 55°C ~ 125°C(Including self - temperature rise)
- IDC : Applied the current to coils, the inductance shall be less than 10% initial value
- Residual impedance of short chip : 0.48nH
- Measure Equipment :
 L & Q : Agilent E4991A+Agilent 16197A
 SRF : Agilent E4991A or HP19196C
 RDC : HP4338B or CHEN HWA 502

Please be sure to request approval specifications that provide further details of the products. Kindly note that the content of these specifications are subject to change or may be discontinued without advance notice. Please contact our sales department before ordering.

Test Instruments : Agilent E4991A Material/Impedance Analyzer

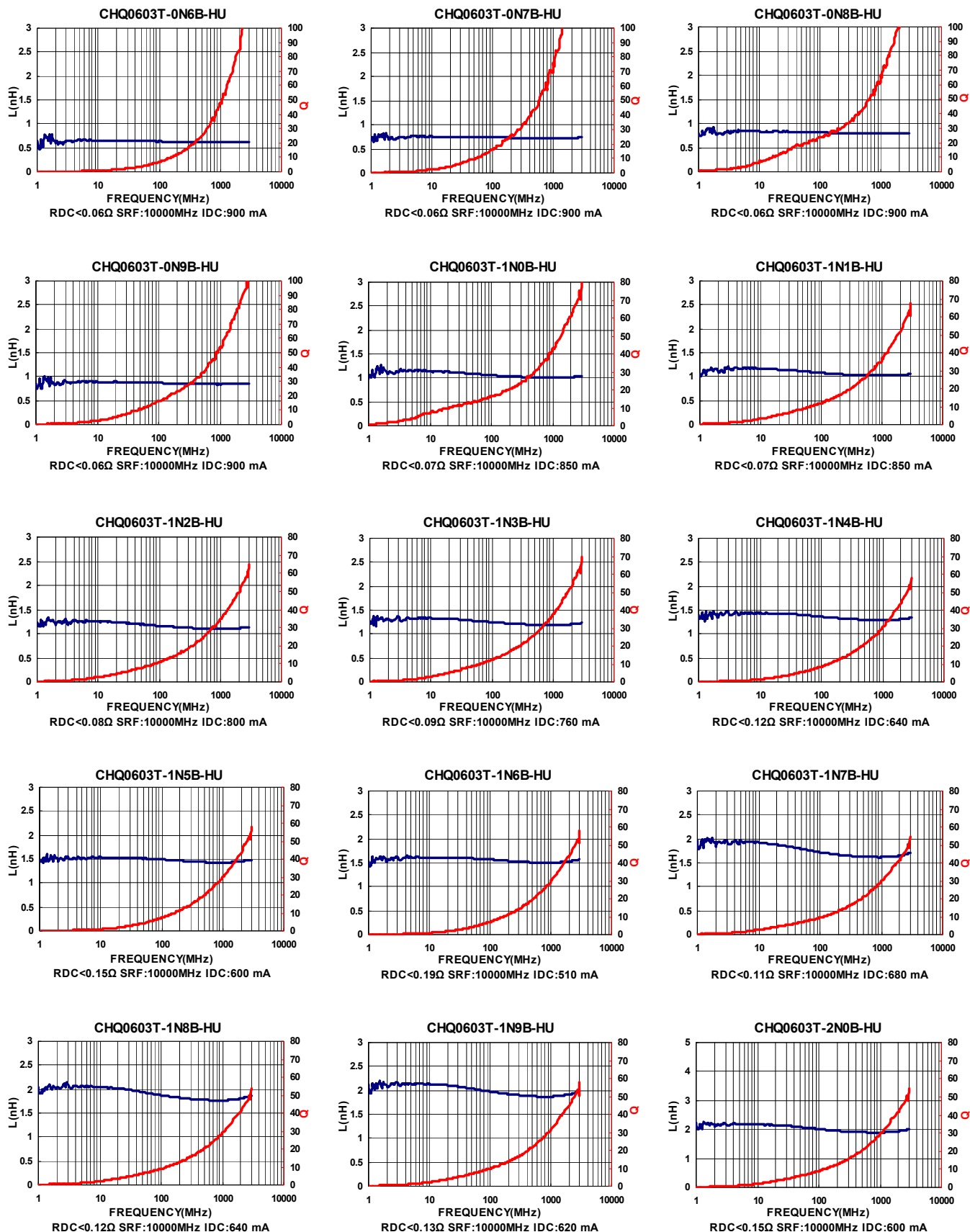

Please be sure to request approval specifications that provide further details of the products. Kindly note that the content of these specifications are subject to change or may be discontinued without advance notice. Please contact our sales department before ordering.

Test Instruments : Agilent E4991A Material/Impedance Analyzer

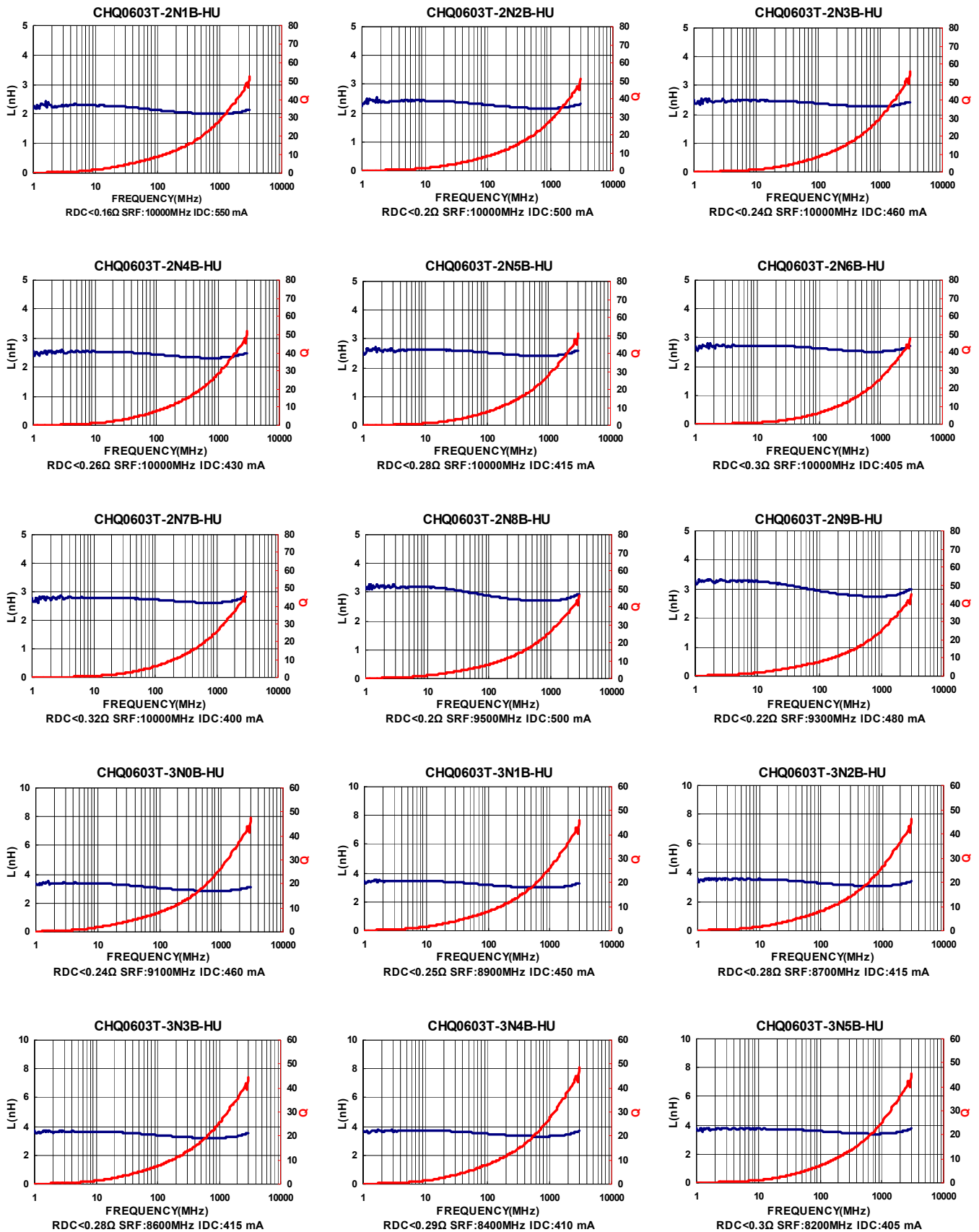

Please be sure to request approval specifications that provide further details of the products. Kindly note that the content of these specifications are subject to change or may be discontinued without advance notice. Please contact our sales department before ordering.

Electrical Characteristics

Part Number	Inductance (nH)	Tolerance (±%)	Test Frequency (MHz)	Q		SRF (MHz) Min	RDC (Ω) Max	IDC (mA) Max
				Min 100MHz	Typ 250MHz			
CHQ1005T-1N0□-S-NP	1.0	±0.3nH	100	8	23	10000	0.07	710
CHQ1005T-1N2□-S-NP	1.2	±0.3nH	100	8	23	10000	0.07	710
CHQ1005T-1N5□-S-NP	1.5	±0.3nH	100	8	20	8000	0.07	710
CHQ1005T-1N8□-S-NP	1.8	±0.3nH	100	8	20	6000	0.07	710
CHQ1005T-2N0□-S-NP	2.0	±0.3nH	100	8	20	6000	0.08	660
CHQ1005T-2N2□-S-NP	2.2	±0.3nH	100	8	20	6000	0.08	660
CHQ1005T-2N4□-S-NP	2.4	±0.3nH	100	8	18	6000	0.09	630
CHQ1005T-2N7□-S-NP	2.7	±0.3nH	100	8	18	6000	0.09	630
CHQ1005T-3N0□-S-NP	3.0	±0.3nH	100	8	18	6000	0.11	570
CHQ1005T-3N3□-S-NP	3.3	±0.3nH	100	8	18	6000	0.12	540
CHQ1005T-3N6□-S-NP	3.6	±0.3nH	100	8	18	5000	0.14	500
CHQ1005T-3N9□-S-NP	3.9	±0.3nH	100	8	18	4000	0.15	490

Note: When ordering, please specify tolerance code. Tolerance : S=±0.3nH , J=±5%

- Operating temperature range - 55°C ~ 125°C(Including self - temperature rise)
- IDC : Applied the current to coils, the inductance shall be less than 10% initial value
- Residual impedance of short chip : 0.19nH(Inductance ≤ 4.3nH) or 0.48nH(Inductance >4.3nH)
- Measure Equipment :
 L & Q : Agilent E4991A+Agilent 16197A
 SRF : Agilent E4991A or HP19196C
 RDC : HP4338B or CHEN HWA 502

Test Instruments : Agilent E4991A Material/Impedance Analyzer

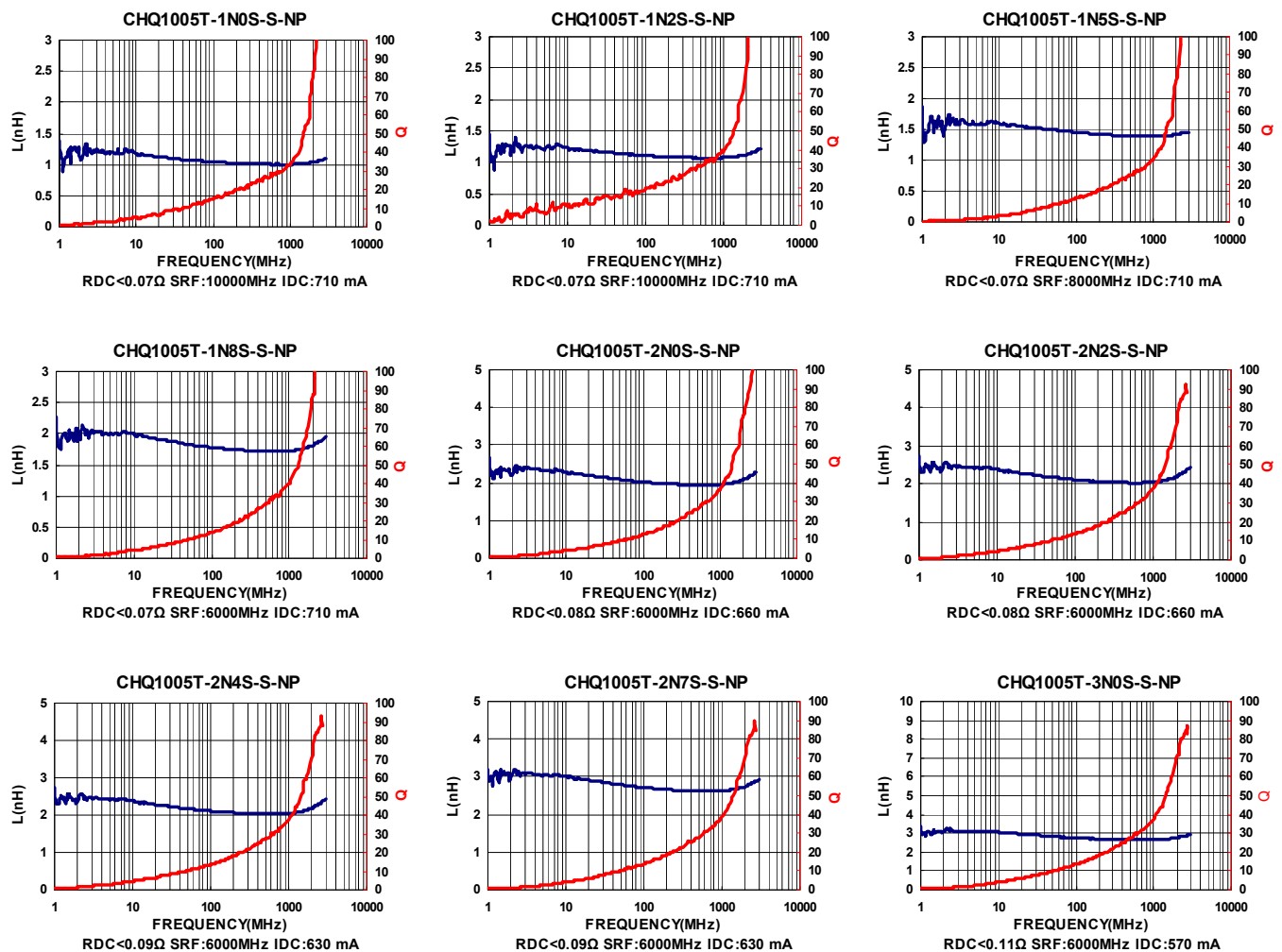

Please be sure to request approval specifications that provide further details of the products. Kindly note that the content of these specifications are subject to change or may be discontinued without advance notice. Please contact our sales department before ordering.

Test Instruments : Agilent E4991A Material/Impedance Analyzer

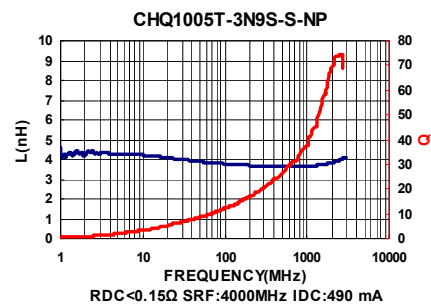
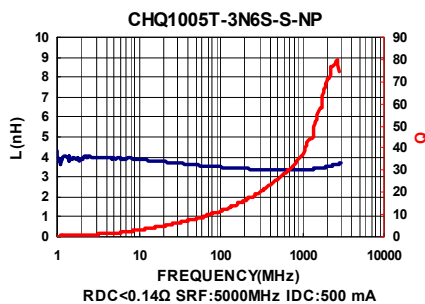
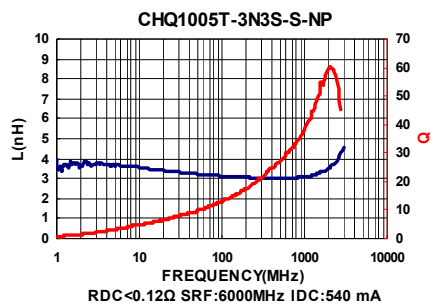

Please be sure to request approval specifications that provide further details of the products. Kindly note that the content of these specifications are subject to change or may be discontinued without advance notice. Please contact our sales department before ordering.

Packaging Specifications

Tape Dimensions

Figure A

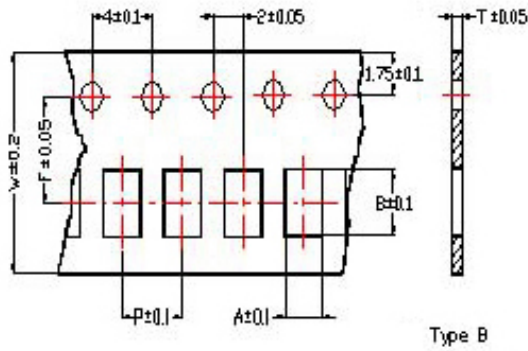

Tape Material

Figure A

Carrier Tape: Polycarbonate (Tape A)
 Carrier Tape: Paper (Tape B)
 Cover Tape: Polystyrene

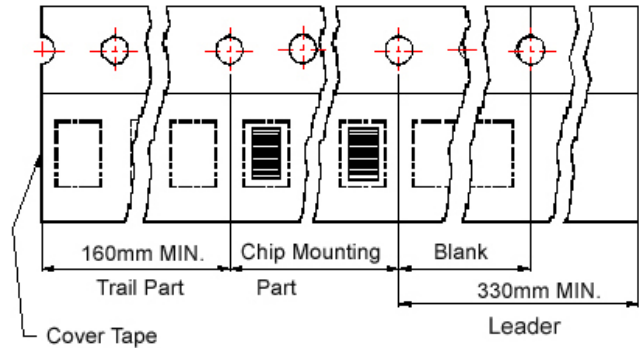
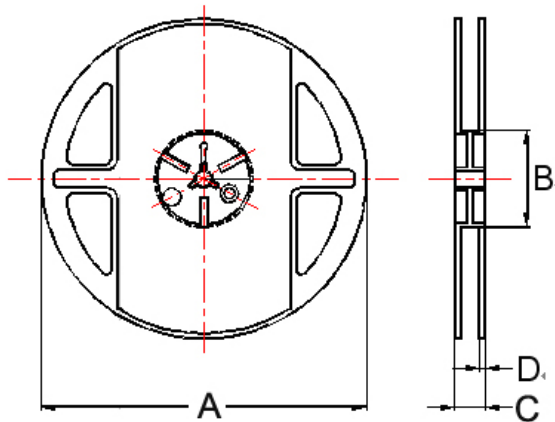
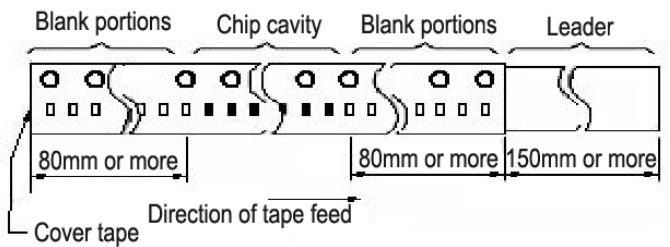

Figure B

Carrier tape : Paper
 Cover tape : Polyethylene



Dimensions in mm

TYPE	Tape Dimensions							Tape Material	Reel Dimensions				Quantity PCS / Reel
	A	B	T	W	P	F	A		B	C	D		
CHQ0603	0.37	0.67	0.42	8	2	3.5	A	B	180	60	13	1.5	15000
CHQ1005	0.62	1.12	0.60	8	2	3.5	A	A	178	60	12	1.5	10000

CLH Series



The CLH Series is a type of ceramic chip inductor produced using the multilayer technology. The series provides excellent Q factor and SRF characteristics and is suitable for high frequency applications.

Features

- RoHS compliant
- Excellent Q factor and SRF characteristics
- Small size of 1005/1608 is suitable for small portable devices
- Supports operating frequency up to 6GHz with nominal inductance values from 1.0nH to 470nH.

Applications

- RF resonance and impedance matching circuit
- RF and wireless communication
- Information technology equipment, computers, telecommunications, radar detectors, automotive electronics, cellular phones, pagers, PDAs, keyless remote systems
- L-C filter configurations

Product Identification

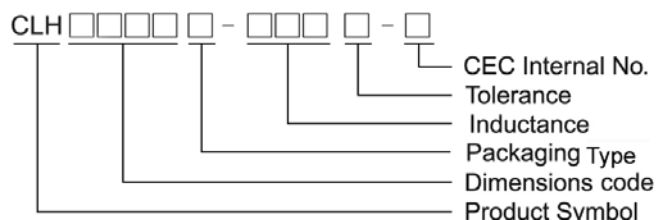

- Packing Type: T: Taping B: Bulk
- Product series identification:

CLH0603-F: Top side half mark.

CLH1005-S: Top side full mark.

CLH1608-S: Top side full mark.

Shape and Dimensions

CLH0603-F Series

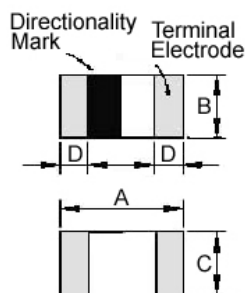

CLH1005-S Series

CLH1608-S Series

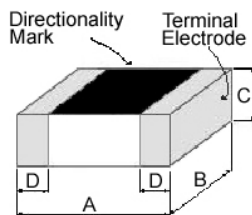

Recommended Pattern

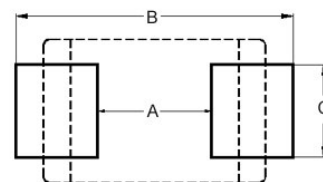

Dimensions in mm

TYPE	A	B	C	D
0603	0.6±0.03	0.3±0.03	0.3±0.03	0.15±0.05
1005	1.0±0.10	0.5±0.10	0.5±0.10	0.25±0.10
1608	1.6±0.15	0.8±0.15	0.8±0.15	0.3±0.2

Dimensions in mm

TYPE	A	B	C
CLH0603	0.3	0.75 ~ 1.05	0.3
CLH1005	0.4	1.2 ~ 1.4	0.5
CLH1608	0.7 ~ 0.8	1.8 ~ 2.0	0.6 ~ 0.8

Electrical Characteristics

Part Number	Inductance (nH)	Tolerance (±%)	Test Frequency (MHz)	Q Min	SRF (MHz) Min	RDC (Ω) Max	Rated Current (mA) Max
CLH0603T-1N0□-F	1.0	±0.3nH	100	4	>10000	0.11	470
CLH0603T-1N2□-F	1.2	±0.3nH	100	4	>10000	0.12	450
CLH0603T-1N5□-F	1.5	±0.3nH	100	4	>10000	0.13	430
CLH0603T-1N8□-F	1.8	±0.3nH	100	4	>10000	0.16	390
CLH0603T-2N0□-F	2.0	±0.3nH	100	4	>10000	0.17	380
CLH0603T-2N2□-F	2.2	±0.3nH	100	4	8800	0.19	360
CLH0603T-2N4□-F	2.4	±0.3nH	100	4	8300	0.20	350
CLH0603T-2N7□-F	2.7	±0.3nH	100	4	7700	0.21	340
CLH0603T-3N0□-F	3.0	±0.3nH	100	4	7200	0.22	330
CLH0603T-3N3□-F	3.3	±0.3nH	100	4	6700	0.23	320
CLH0603T-3N6□-F	3.6	±0.3nH	100	4	6400	0.25	310
CLH0603T-3N9□-F	3.9	±0.3nH	100	4	6000	0.27	300
CLH0603T-4N3□-F	4.3	±0.3nH	100	4	5700	0.30	280
CLH0603T-4N7□-F	4.7	±0.3nH	100	4	5300	0.30	280
CLH0603T-5N1□-F	5.1	±0.3nH	100	4	5000	0.33	270
CLH0603T-5N6□-F	5.6	±0.3nH	100	4	4600	0.36	260
CLH0603T-6N2□-F	6.2	±0.3nH	100	4	4200	0.38	250
CLH0603T-6N8□-F	6.8	5	100	4	3900	0.39	250
CLH0603T-7N5□-F	7.5	5	100	4	3600	0.41	240
CLH0603T-8N2□-F	8.2	5	100	4	3400	0.45	230
CLH0603T-9N1□-F	9.1	5	100	4	3200	0.48	220
CLH0603T-10N□-F	10	5	100	4	2900	0.51	220
CLH0603T-12N□-F	12	5	100	4	2700	0.68	190
CLH0603T-15N□-F	15	5	100	4	2300	0.71	180
CLH0603T-18N□-F	18	5	100	4	2100	0.81	170
CLH0603T-22N□-F	22	5	100	4	1800	1.00	150
CLH0603T-27N□-F	27	5	100	4	1800	1.35	120
CLH0603T-33N□-F	33	5	100	4	1700	1.47	110
CLH0603T-39N□-F	39	5	100	4	1500	1.72	100
CLH0603T-47N□-F	47	5	100	4	1300	1.90	100
CLH0603T-56N□-F	56	5	100	4	1100	2.27	80
CLH0603T-68N□-F	68	5	100	4	1100	2.66	80
CLH0603T-82N□-F	82	5	100	4	1000	3.37	70
CLH0603T-R10□-F	100	5	100	4	900	3.74	60

Note: When ordering, please specify tolerance code. Tolerance : S=±0.3nH , J=±5%

- Operating temperature range - 55°C ~ 125°C(Including self - temperature rise)
- Rate Current :Applied the current to coils, the temperature rise shall not be more than 30°C
- Residual impedance of short chip : 0.19nH
- Measure Equipment :
 - L & Q : Agilent E4991A+Agilent 16197A
 - SRF : Agilent E4991A or HP19196C
 - RDC : HP4338B or CHEN HWA 502

Test Instruments : Agilent E4991A Material/Impedance Analyzer

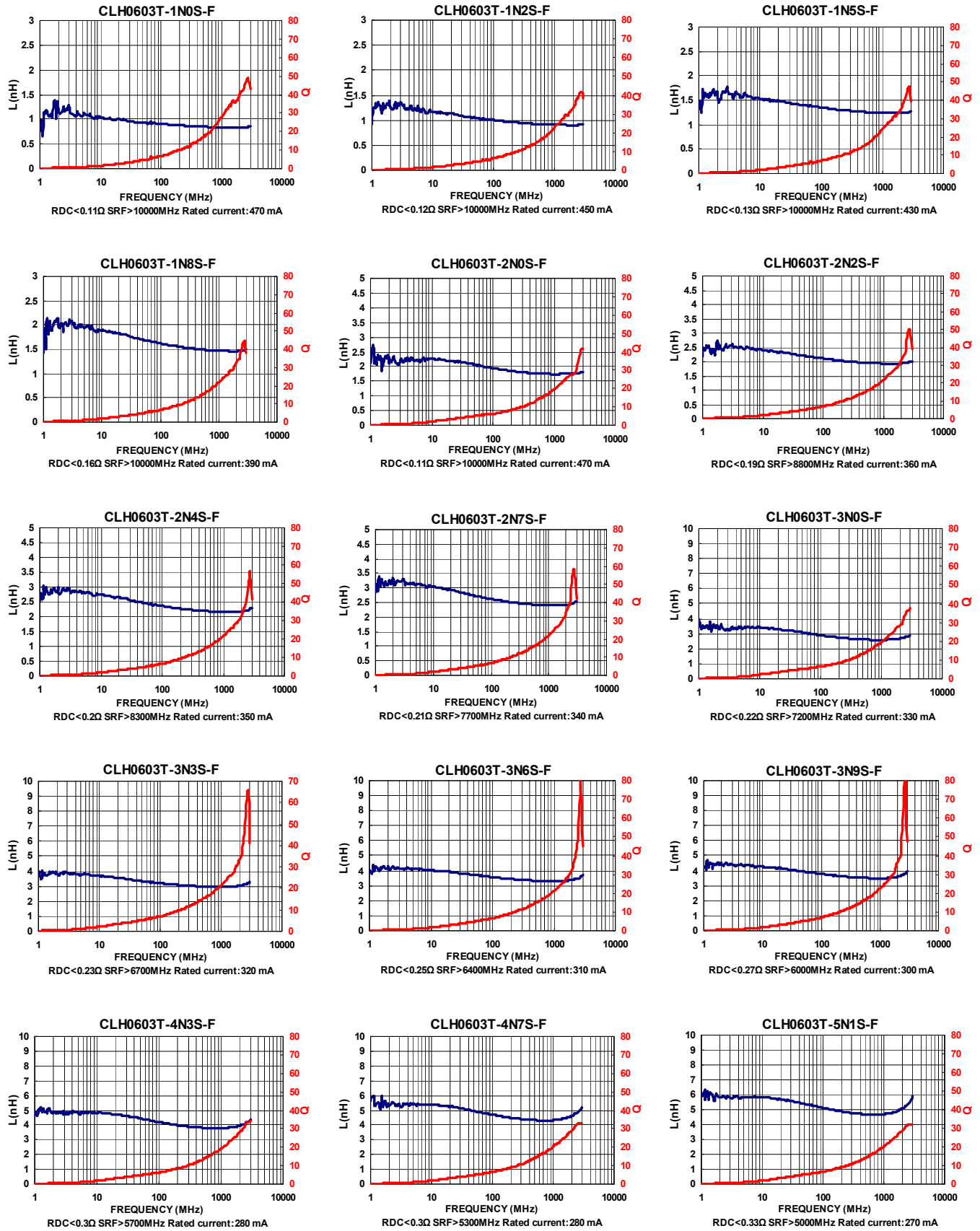

Please be sure to request approval specifications that provide further details of the products. Kindly note that the content of these specifications are subject to change or may be discontinued without advance notice. Please contact our sales department before ordering.

Test Instruments : Agilent E4991A Material/Impedance Analyzer

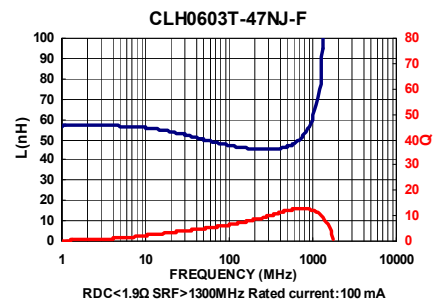
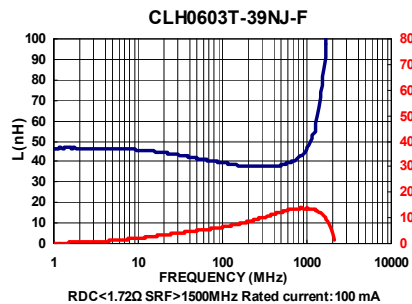
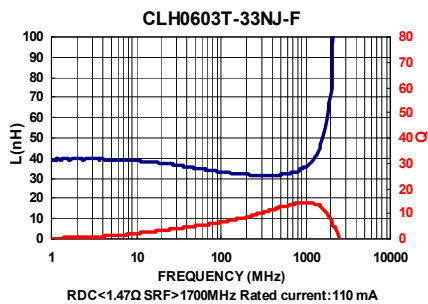
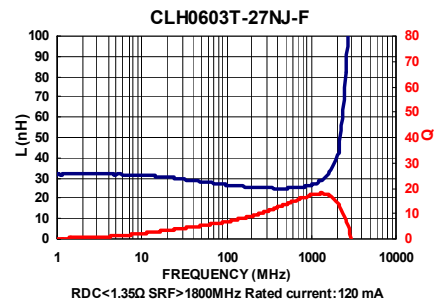
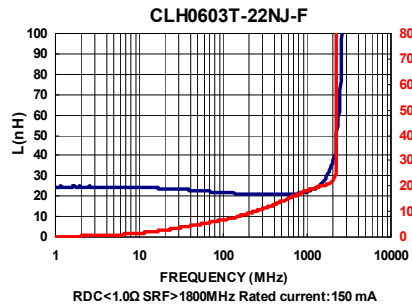
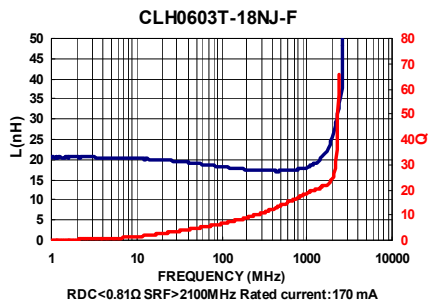
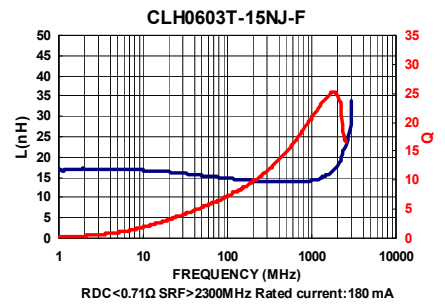
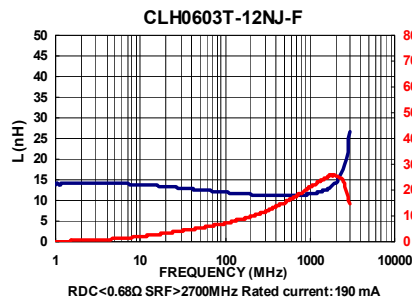
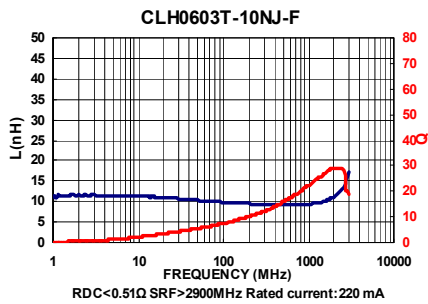
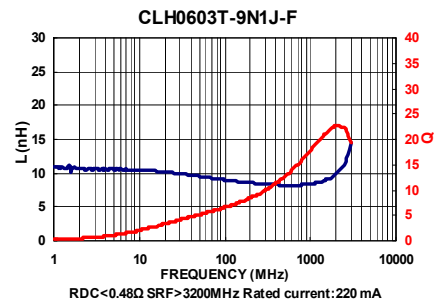
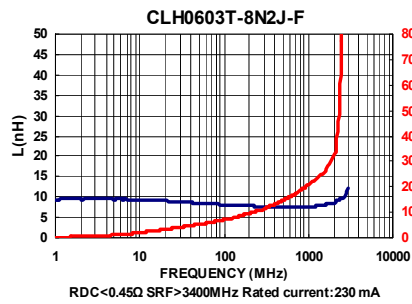
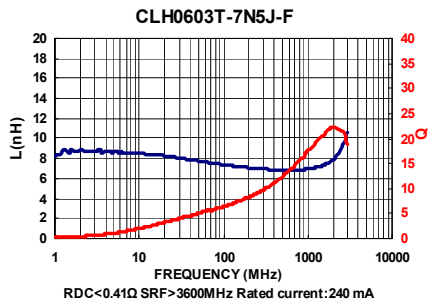
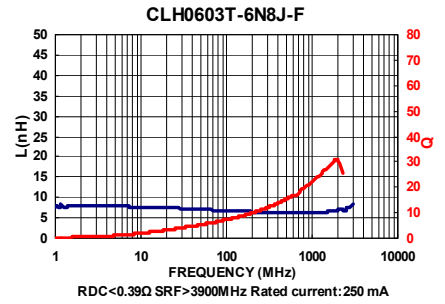
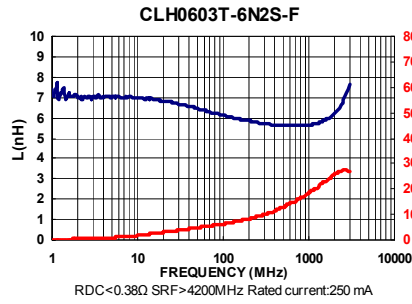
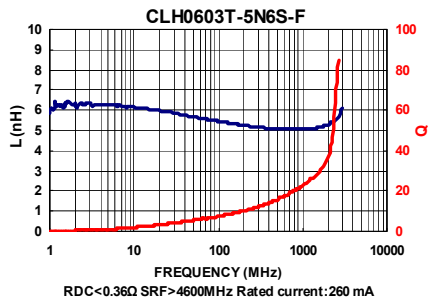

Please be sure to request approval specifications that provide further details of the products. Kindly note that the content of these specifications are subject to change or may be discontinued without advance notice. Please contact our sales department before ordering.

Test Instruments : Agilent E4991A Material/Impedance Analyzer

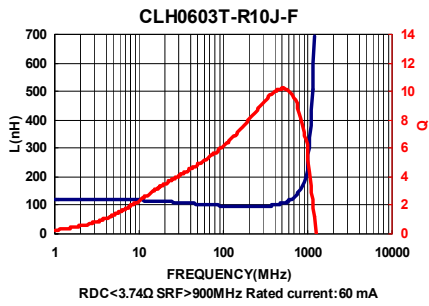
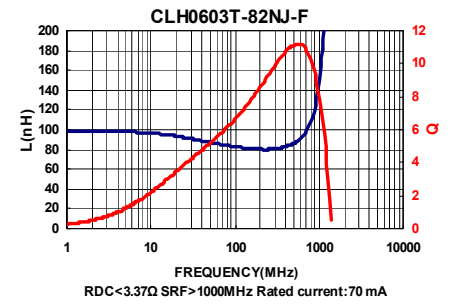
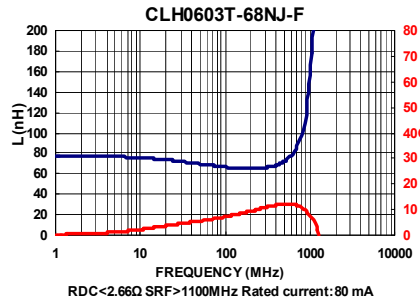
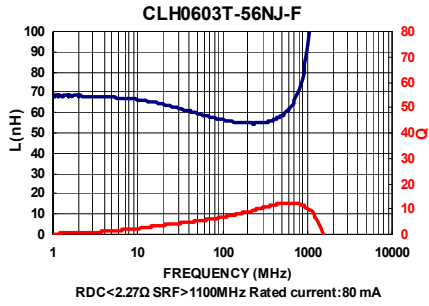

Please be sure to request approval specifications that provide further details of the products. Kindly note that the content of these specifications are subject to change or may be discontinued without advance notice. Please contact our sales department before ordering.

Electrical Characteristics

Part Number	Inductance (nH)	Tolerance (±%)	Test Frequency (MHz)	Q Min	SRF (MHz) Typ.	RDC (Ω) Max	IDC (mA) Max
CLH1005T-1N0□-S	1.0	±0.3nH	100	8	10000	0.07	400
CLH1005T-1N1□-S	1.1	±0.3nH	100	8	10000	0.07	400
CLH1005T-1N2□-S	1.2	±0.3nH	100	8	10000	0.09	400
CLH1005T-1N3□-S	1.3	±0.3nH	100	8	9000	0.10	400
CLH1005T-1N5□-S	1.5	±0.3nH	100	8	9000	0.10	400
CLH1005T-1N6□-S	1.6	±0.3nH	100	8	8700	0.10	400
CLH1005T-1N8□-S	1.8	±0.3nH	100	8	8700	0.10	400
CLH1005T-2N0□-S	2.0	±0.3nH	100	8	8100	0.10	400
CLH1005T-2N2□-S	2.2	±0.3nH	100	8	8100	0.12	400
CLH1005T-2N4□-S	2.4	±0.3nH	100	8	7700	0.15	400
CLH1005T-2N7□-S	2.7	±0.3nH	100	8	7700	0.15	400
CLH1005T-3N0□-S	3.0	±0.3nH	100	8	6300	0.15	400
CLH1005T-3N3□-S	3.3	±0.3nH/10	100	8	6300	0.15	400
CLH1005T-3N6□-S	3.6	±0.3nH/10	100	8	6100	0.15	400
CLH1005T-3N9□-S	3.9	±0.3nH/10	100	8	6100	0.18	400
CLH1005T-4N3□-S	4.3	±0.3nH/10	100	8	6000	0.18	400
CLH1005T-4N7□-S	4.7	±0.3nH/10	100	8	6000	0.18	400
CLH1005T-5N0□-S	5.0	±0.3nH/10	100	8	5100	0.20	400
CLH1005T-5N1□-S	5.1	±0.3nH/10	100	8	5300	0.20	400
CLH1005T-5N6□-S	5.6	±0.3nH/10	100	8	5100	0.20	400
CLH1005T-6N8□-S	6.8	5 / 10	100	8	4550	0.24	400
CLH1005T-8N0□-S	8.0	5 / 10	100	8	4100	0.30	300
CLH1005T-8N2□-S	8.2	5 / 10	100	8	4100	0.24	300
CLH1005T-9N1□-S	9.1	5 / 10	100	8	3900	0.26	300
CLH1005T-10N□-S	10	5 / 10	100	8	3900	0.26	300
CLH1005T-12N□-S	12	5 / 10	100	8	3000	0.40	300
CLH1005T-15N□-S	15	5 / 10	100	8	2800	0.50	300
CLH1005T-18N□-S	18	5 / 10	100	8	2500	0.55	300
CLH1005T-22N□-S	22	5 / 10	100	8	2200	0.70	300
CLH1005T-24N□-S	24	5 / 10	100	8	2100	0.70	300
CLH1005T-27N□-S	27	5 / 10	100	8	2000	0.80	300
CLH1005T-33N□-S	33	5 / 10	100	8	1800	0.9	200
CLH1005T-39N□-S	39	5 / 10	100	8	1600	1.0	150
CLH1005T-47N□-S	47	5 / 10	100	8	1400	1.2	150
CLH1005T-56N□-S	56	5 / 10	100	8	1300	1.3	150
CLH1005T-68N□-S	68	5 / 10	100	8	1100	1.5	100

Note: When ordering, please specify tolerance code. Tolerance : S=±0.3nH , J=±5% , K=±10%

- Operating temperature range - 55°C ~ 125°C(Including self - temperature rise)
- IDC : Applied the current to coils, the inductance shall be less than 10% initial value
- Measure Equipment :
 L & Q : Agilent E4991A+Agilent 16197A
 SRF : HP8753D
 RDC : HP4338B or CHEN HWA 502

Please be sure to request approval specifications that provide further details of the products. Kindly note that the content of these specifications are subject to change or may be discontinued without advance notice. Please contact our sales department before ordering.

Electrical Characteristics

Part Number	Inductance (nH)	Tolerance (±%)	Test Frequency (MHz)	Q Min	SRF (MHz) Typ.	RDC (Ω) Max	IDC (mA) Max
CLH1005T-75N□-S	75	5 / 10	100	8	1080	1.5	100
CLH1005T-82N□-S	82	5 / 10	100	8	1000	1.6	100
CLH1005T-R10□-S	100	5 / 10	100	8	900	2.0	100
CLH1005T-R12□-S	120	5 / 10	100	8	800	2.2	100
CLH1005T-R15□-S	150	5 / 10	100	8	700	3.5	100
CLH1005T-R18□-S	180	5 / 10	100	8	600	3.8	100
CLH1005T-R22□-S	220	5 / 10	100	8	500	4.2	100
CLH1005T-R27□-S	270	5 / 10	100	8	500	4.8	100

Note: When ordering, please specify tolerance code. Tolerance : S=±0.3nH , J=±5% , K=±10%

- Operating temperature range - 55°C ~ 125°C(Including self - temperature rise)
- IDC : Applied the current to coils, the inductance shall be less than 10% initial value
- Measure Equipment :
 L & Q : Agilent E4991A+Agilent 16197A
 SRF : HP8753D
 RDC : HP4338B or CHEN HWA 502

Test Instruments : Agilent E4991A Material/Impedance Analyzer

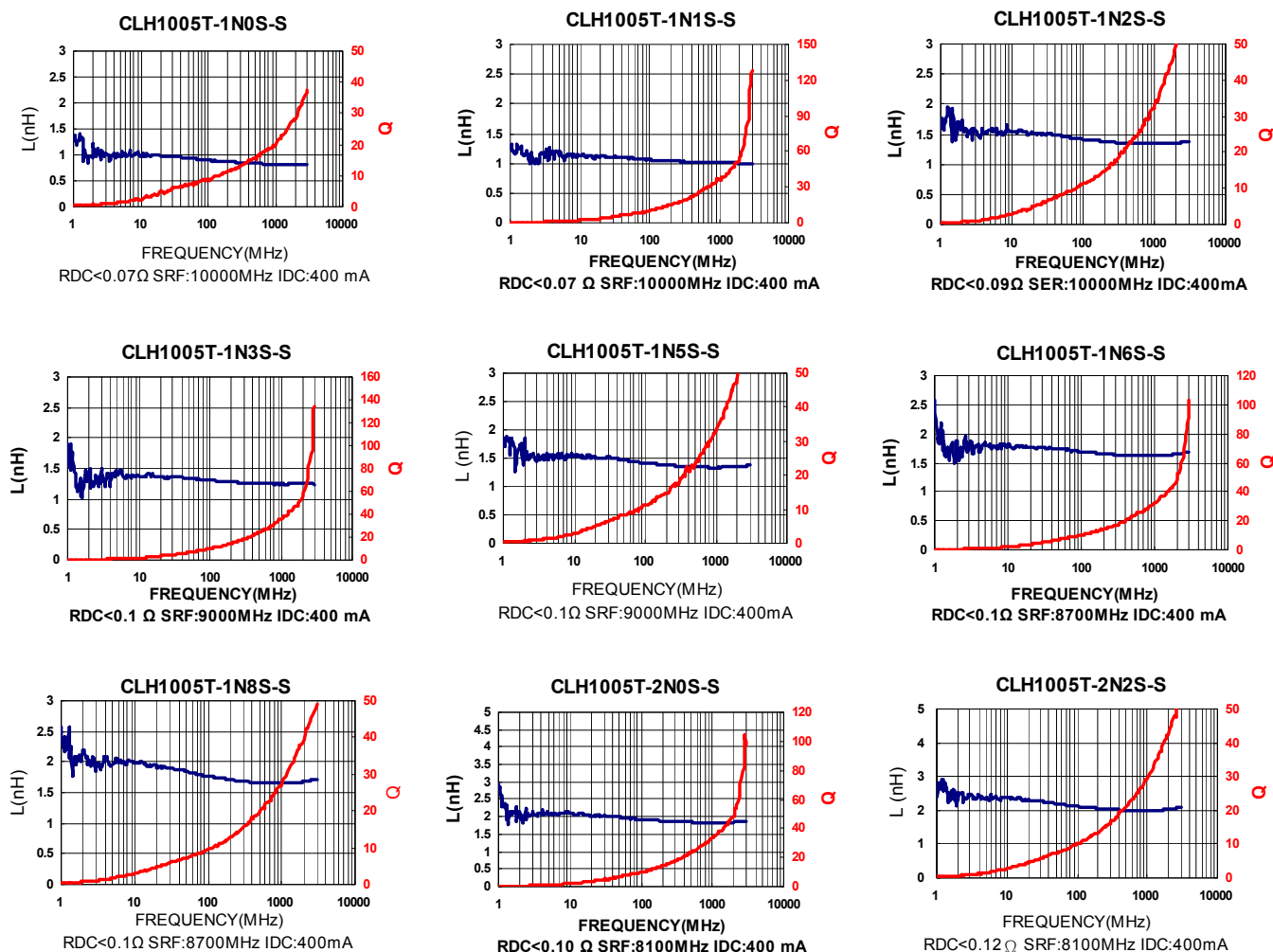

Please be sure to request approval specifications that provide further details of the products. Kindly note that the content of these specifications are subject to change or may be discontinued without advance notice. Please contact our sales department before ordering.

Test Instruments : Agilent E4991A Material/Impedance Analyzer

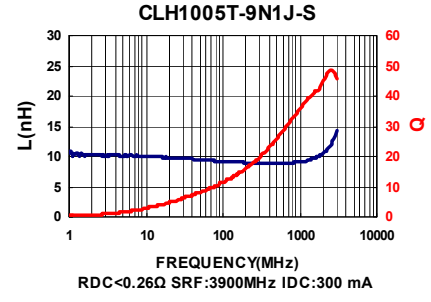
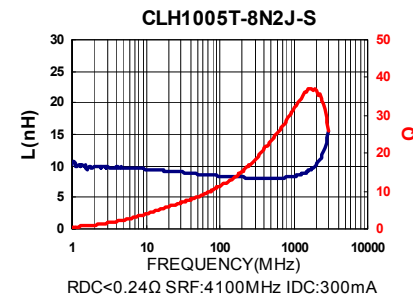
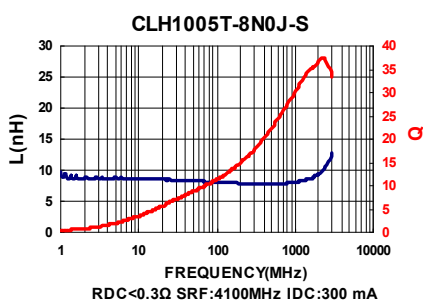
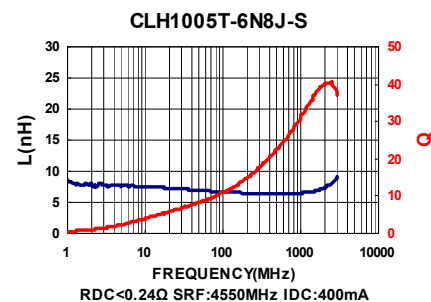
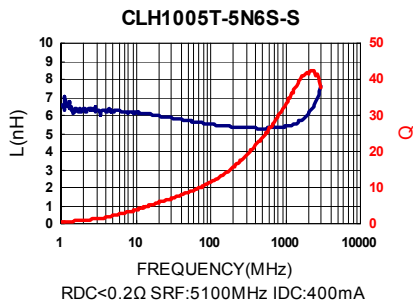
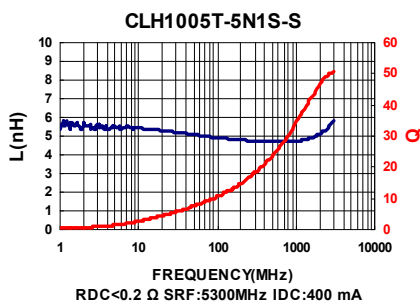
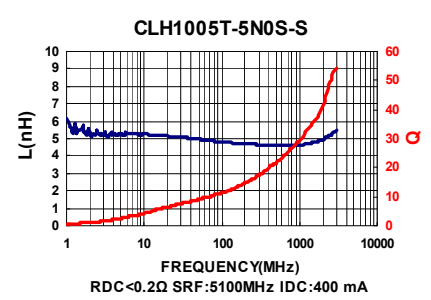
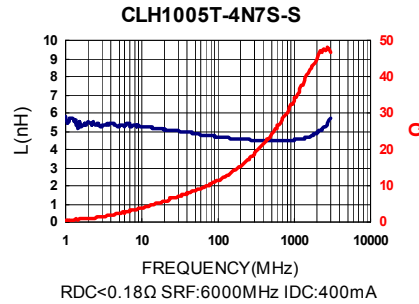
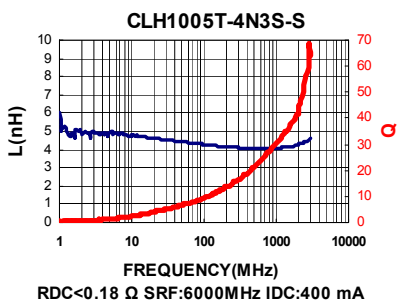
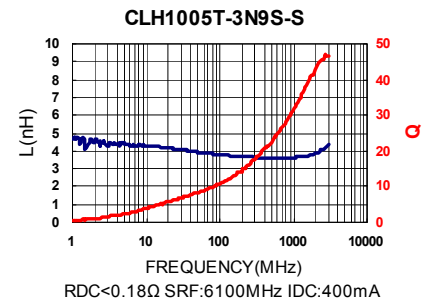
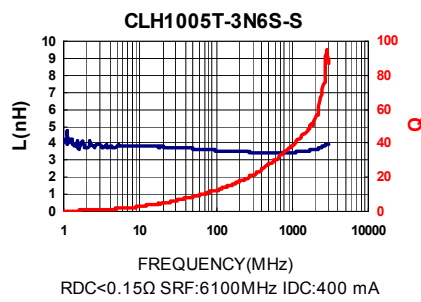
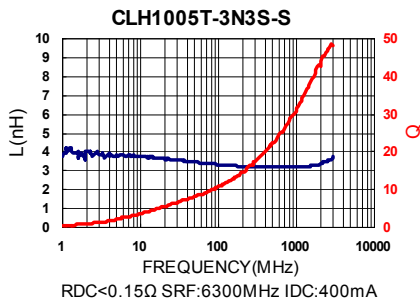
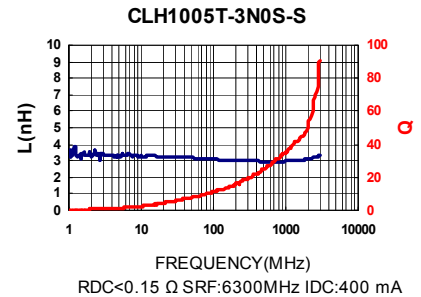
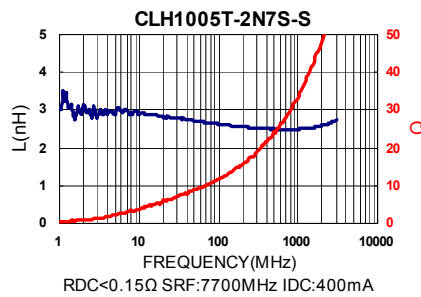
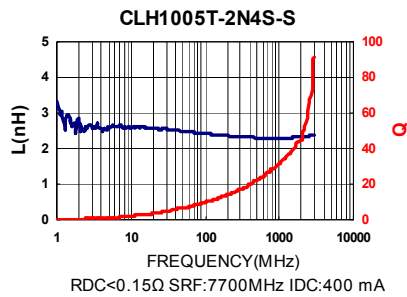

Please be sure to request approval specifications that provide further details of the products. Kindly note that the content of these specifications are subject to change or may be discontinued without advance notice. Please contact our sales department before ordering.

Test Instruments : Agilent E4991A Material/Impedance Analyzer

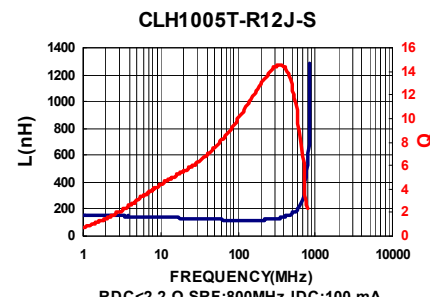
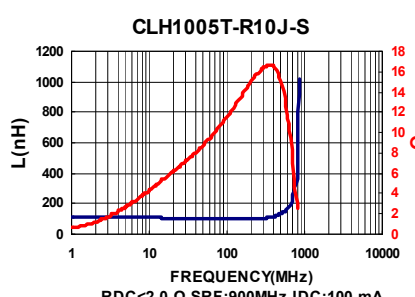
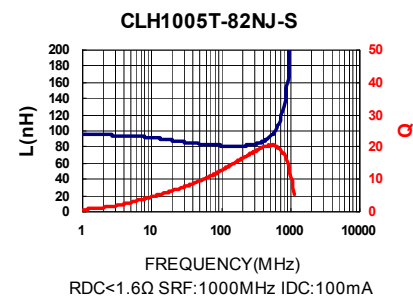
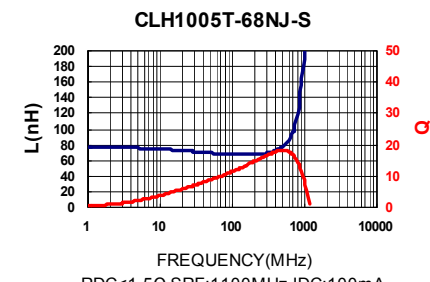
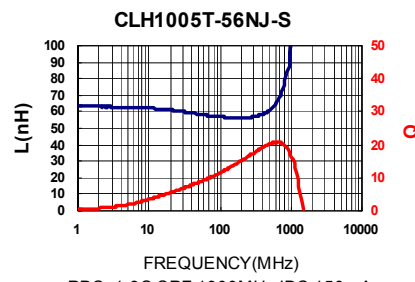
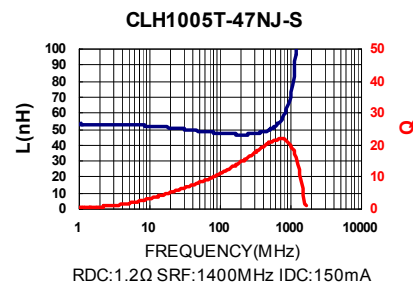
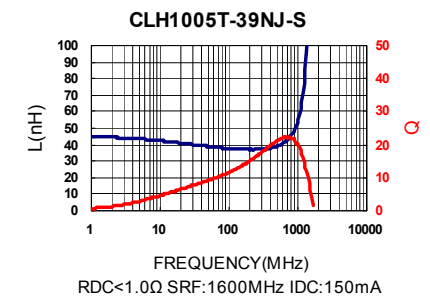
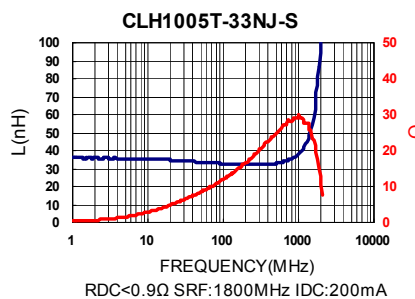
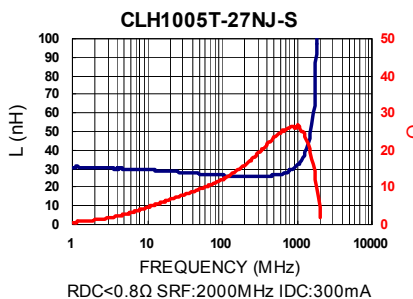
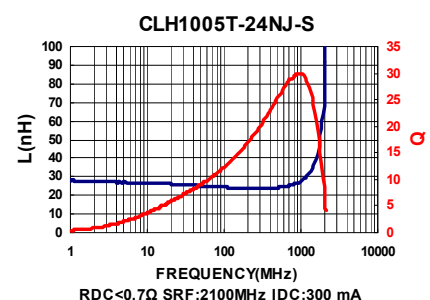
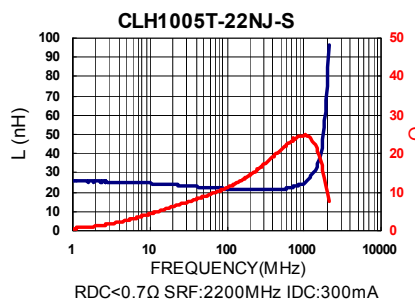
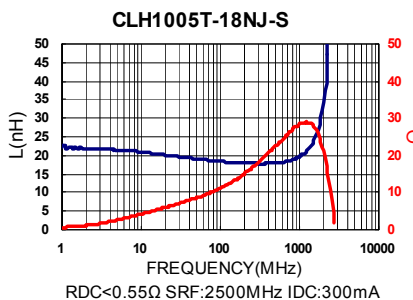
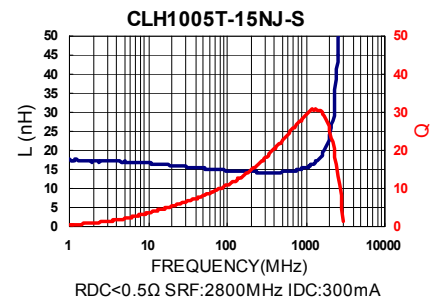
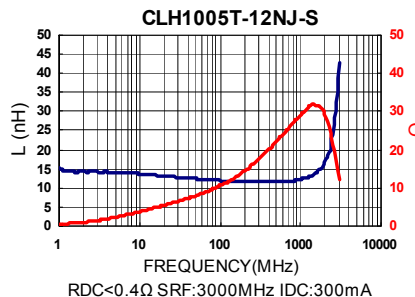
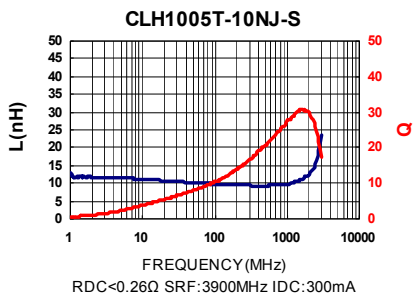

Please be sure to request approval specifications that provide further details of the products. Kindly note that the content of these specifications are subject to change or may be discontinued without advance notice. Please contact our sales department before ordering.

Test Instruments : Agilent E4991A Material/Impedance Analyzer

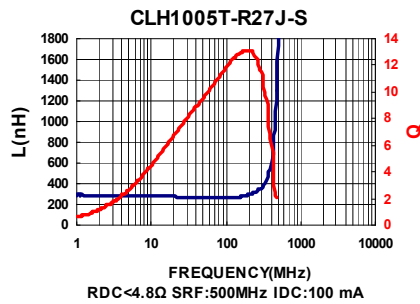
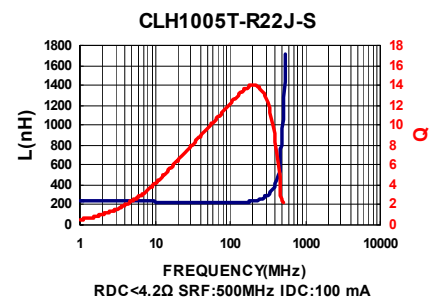
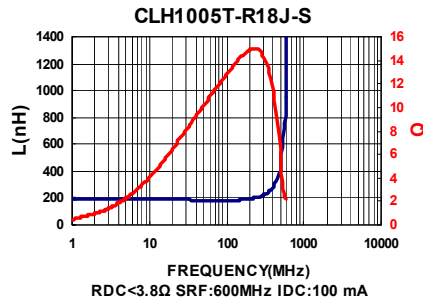
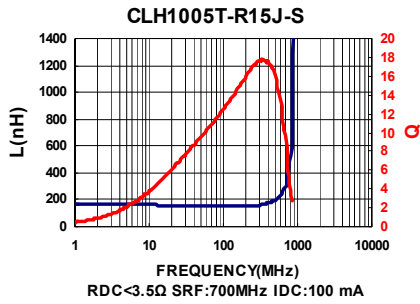

Please be sure to request approval specifications that provide further details of the products. Kindly note that the content of these specifications are subject to change or may be discontinued without advance notice. Please contact our sales department before ordering.

Electrical Characteristics

Part Number	Inductance (nH)	Tolerance (±%)	Test Frequency (MHz)	Q Min	SRF (MHz) Typ.	RDC (Ω) Max	Rated Current (mA) Max
CLH1005T-1N0□-S-NP	1.0	±0.2nH/±0.3nH	100	8	10000	0.07	400
CLH1005T-1N1□-S-NP	1.1	±0.3nH	100	8	6000	0.09	300
CLH1005T-1N2□-S-NP	1.2	±0.2nH/±0.3nH	100	8	10000	0.09	400
CLH1005T-1N3□-S-NP	1.3	±0.3nH	100	8	6000	0.09	300
CLH1005T-1N5□-S-NP	1.5	±0.3nH	100	8	9000	0.10	400
CLH1005T-1N6□-S-NP	1.6	±0.3nH	100	8	6000	0.10	400
CLH1005T-1N8□-S-NP	1.8	±0.3nH	100	8	8700	0.10	400
CLH1005T-2N0□-S-NP	2.0	±0.3nH	100	8	8100	0.10	400
CLH1005T-2N2□-S-NP	2.2	±0.3nH	100	8	8100	0.12	400
CLH1005T-2N4□-S-NP	2.4	±0.3nH	100	8	7700	0.15	400
CLH1005T-2N7□-S-NP	2.7	±0.3nH	100	8	7700	0.15	400
CLH1005T-3N0□-S-NP	3.0	±0.3nH	100	8	6300	0.15	400
CLH1005T-3N3□-S-NP	3.3	±0.3nH	100	8	6300	0.15	400
CLH1005T-3N6□-S-NP	3.6	±0.3nH	100	8	6100	0.15	400
CLH1005T-3N9□-S-NP	3.9	±0.3nH	100	8	6100	0.18	400
CLH1005T-4N3□-S-NP	4.3	±0.3nH	100	8	6000	0.18	400
CLH1005T-4N7□-S-NP	4.7	±0.3nH	100	8	6000	0.18	400
CLH1005T-5N1□-S-NP	5.1	±0.3nH	100	8	5300	0.20	400
CLH1005T-5N6□-S-NP	5.6	±0.3nH	100	8	5100	0.20	400
CLH1005T-6N2□-S-NP	6.2	±0.3nH/5/10	100	8	4500	0.22	400
CLH1005T-6N8□-S-NP	6.8	5 / 10	100	8	4550	0.24	400
CLH1005T-7N5□-S-NP	7.5	5 / 10	100	8	4200	0.24	300
CLH1005T-8N2□-S-NP	8.2	5 / 10	100	8	4100	0.24	300
CLH1005T-9N1□-S-NP	9.1	5 / 10	100	8	3900	0.26	300
CLH1005T-10N□-S-NP	10	5 / 10	100	8	3900	0.26	300
CLH1005T-12N□-S-NP	12	5 / 10	100	8	3000	0.28	300
CLH1005T-15N□-S-NP	15	5 / 10	100	8	2500	0.32	300
CLH1005T-18N□-S-NP	18	5 / 10	100	8	2200	0.36	300
CLH1005T-22N□-S-NP	22	5 / 10	100	8	1900	0.42	300
CLH1005T-27N□-S-NP	27	5 / 10	100	8	1700	0.46	300
CLH1005T-33N□-S-NP	33	5 / 10	100	8	1600	0.58	200
CLH1005T-39N□-S-NP	39	5 / 10	100	8	1200	0.65	200
CLH1005T-47N□-S-NP	47	5 / 10	100	8	1000	0.72	200
CLH1005T-56N□-S-NP	56	5 / 10	100	8	800	0.82	200
CLH1005T-68N□-S-NP	68	5 / 10	100	8	800	0.92	180
CLH1005T-82N□-S-NP	82	5 / 10	100	8	700	1.20	150

Note: When ordering, please specify tolerance code. Tolerance : C=±0.2nH , S=±0.3nH , J=±5% , K=±10%

- Operating temperature range - 55°C ~ 125°C(Including self - temperature rise)
- Rate Current : Applied the current to coils, the temperature rise shall not be more than 30°C
- Measure Equipment :
L & Q : Agilent E4991A+Agilent 16197A
SRF : HP8753D
RDC : HP4338B or CHEN HWA 502

Test Instruments : Agilent E4991A Material/Impedance Analyzer

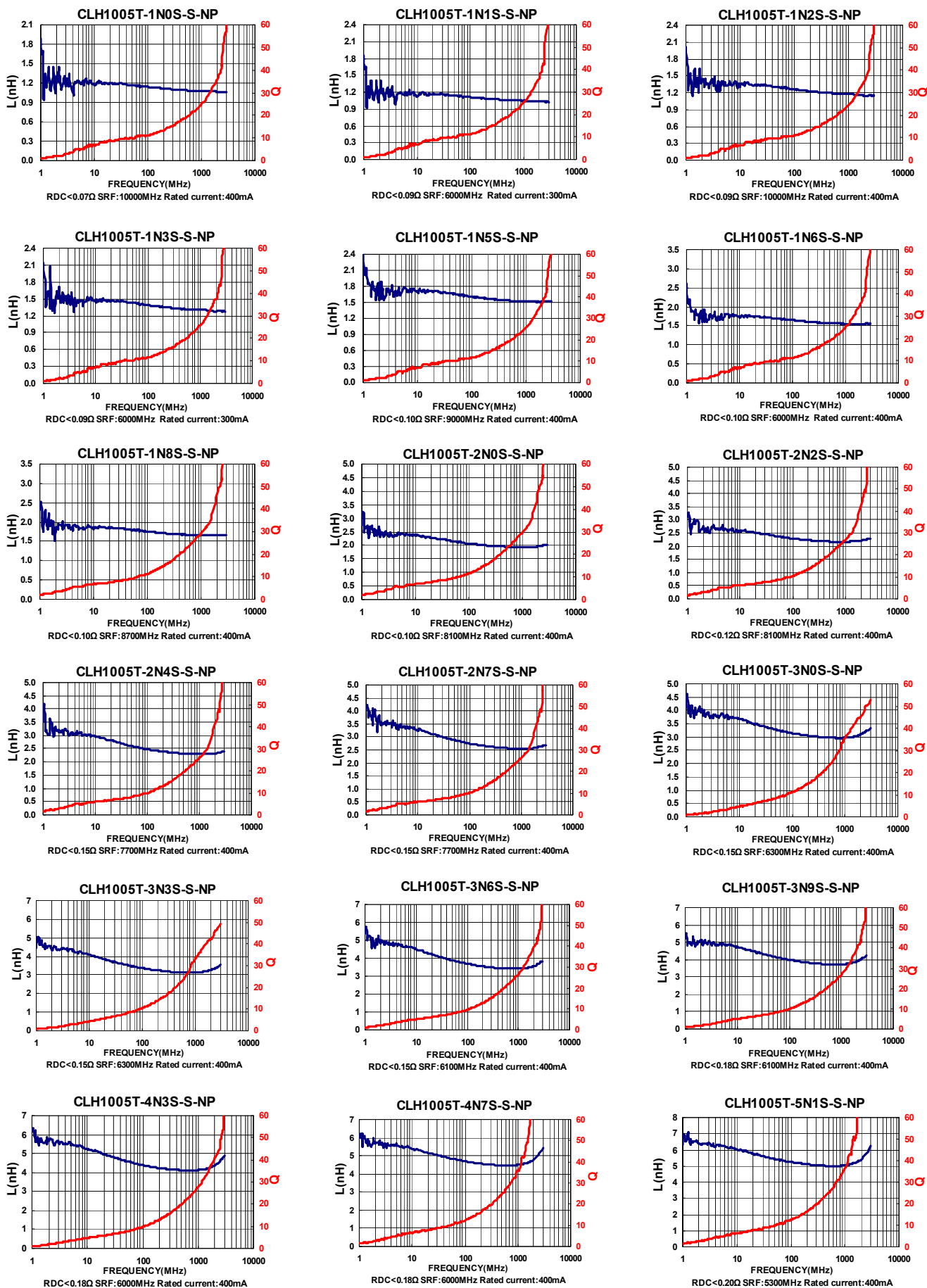

Please be sure to request approval specifications that provide further details of the products. Kindly note that the content of these specifications are subject to change or may be discontinued without advance notice. Please contact our sales department before ordering.

Test Instruments : Agilent E4991A Material/Impedance Analyzer

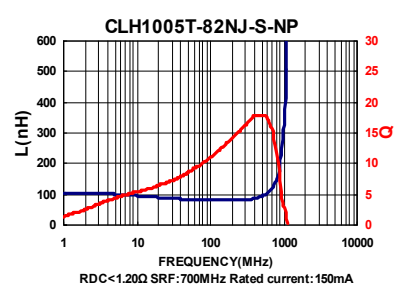
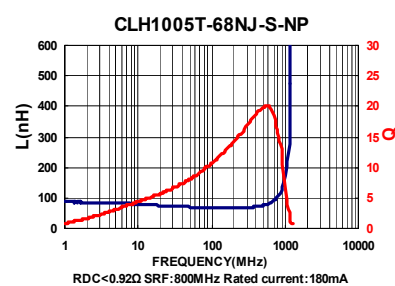
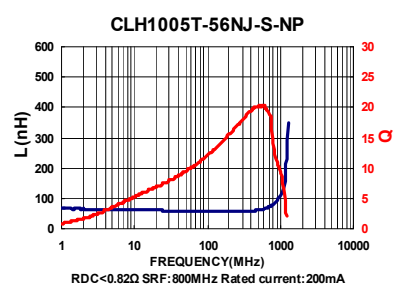
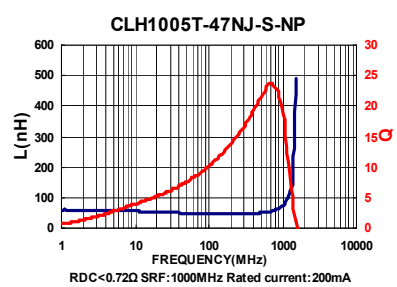
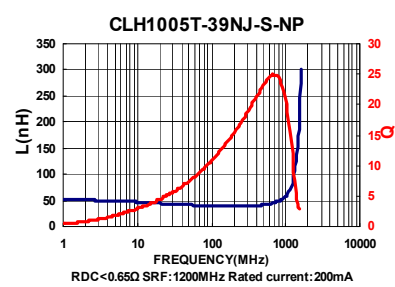
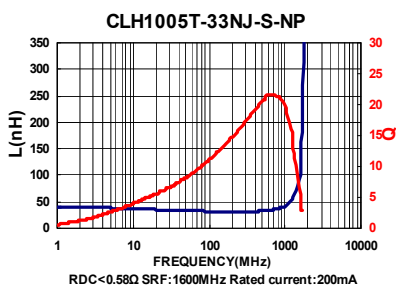
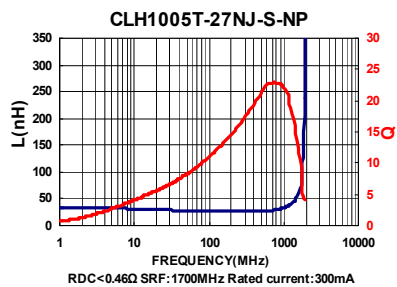
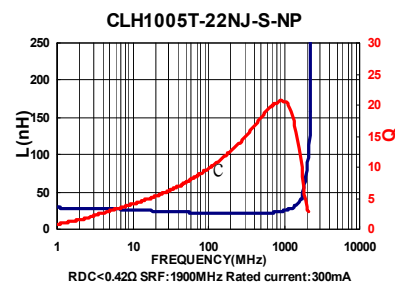
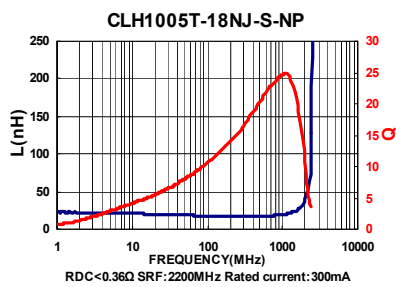
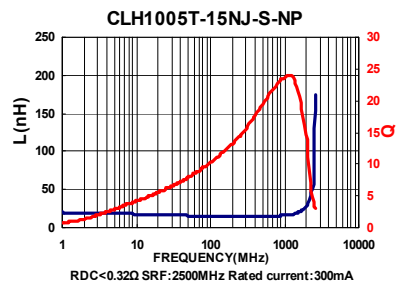
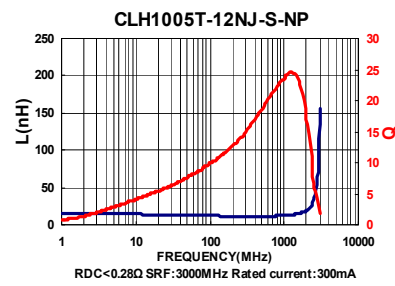
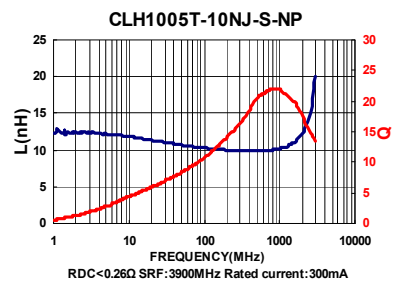
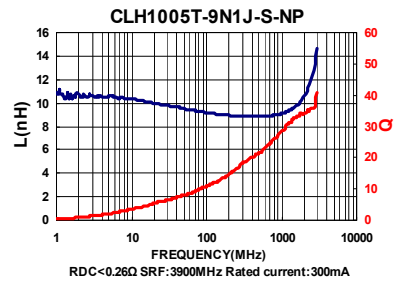
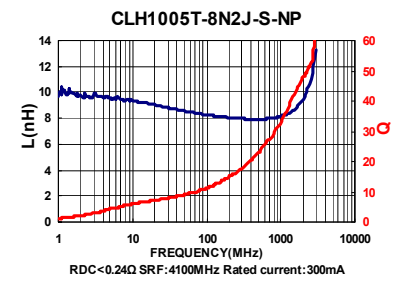
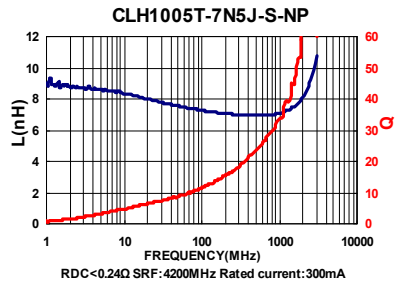
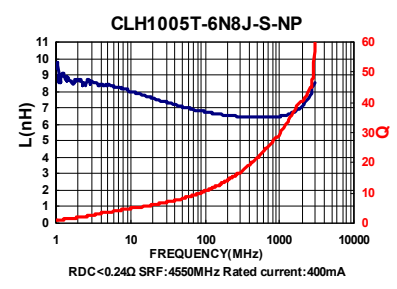
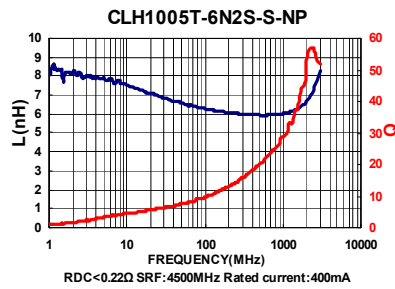
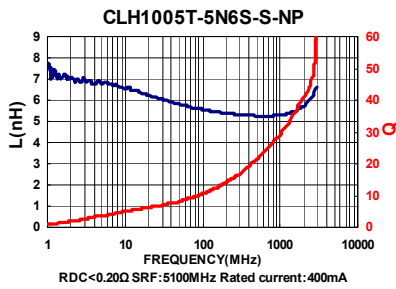

Please be sure to request approval specifications that provide further details of the products. Kindly note that the content of these specifications are subject to change or may be discontinued without advance notice. Please contact our sales department before ordering.

Electrical Characteristics

Part Number	Inductance (nH)	Tolerance (±%)	Test Frequency (MHz)	Q Min	SRF (MHz) Typ.	RDC (Ω) Max	IDC (mA) Max
CLH1608T-1N0S-S	1.0	±0.3nH	100	8	10000	0.10	600
CLH1608T-1N2S-S	1.2	±0.3nH	100	8	10000	0.10	600
CLH1608T-1N5S-S	1.5	±0.3nH	100	8	8000	0.10	600
CLH1608T-1N6S-S	1.6	±0.3nH	100	8	8000	0.10	600
CLH1608T-1N8S-S	1.8	±0.3nH	100	8	8000	0.10	600
CLH1608T-2N2S-S	2.2	±0.3nH	100	8	7200	0.10	600
CLH1608T-2N7S-S	2.7	±0.3nH	100	10	6200	0.10	600
CLH1608T-3N0S-S	3.0	±0.3nH	100	10	5200	0.12	600
CLH1608T-3N3□-S	3.3	±0.3nH/10	100	10	5200	0.12	600
CLH1608T-3N6S-S	3.6	±0.3nH	100	10	5000	0.14	600
CLH1608T-3N9□-S	3.9	±0.3nH/10	100	10	5000	0.14	600
CLH1608T-4N3□-S	4.3	±0.3nH/10	100	10	4750	0.16	600
CLH1608T-4N7□-S	4.7	±0.3nH /10	100	10	4750	0.16	600
CLH1608T-5N1□-S	5.1	±0.3nH /10	100	10	4100	0.18	600
CLH1608T-5N6□-S	5.6	±0.3nH/10	100	10	4100	0.18	600
CLH1608T-6N2□-S	6.2	5 / 10	100	10	3750	0.22	600
CLH1608T-6N8□-S	6.8	5 / 10	100	10	3750	0.22	600
CLH1608T-7N5□-S	7.5	5 / 10	100	10	3300	0.24	600
CLH1608T-8N2□-S	8.2	5 / 10	100	10	3300	0.24	600
CLH1608T-10N□-S	10	5 / 10	100	12	3000	0.26	600
CLH1608T-12N□-S	12	5 / 10	100	12	2600	0.28	600
CLH1608T-15N□-S	15	5 / 10	100	12	2500	0.32	600
CLH1608T-16N□-S	16	5 / 10	100	12	2400	0.35	600
CLH1608T-18N□-S	18	5 / 10	100	12	2400	0.35	600
CLH1608T-22N□-S	22	5 / 10	100	12	2000	0.40	500
CLH1608T-27N□-S	27	5 / 10	100	12	1900	0.45	500
CLH1608T-33N□-S	33	5 / 10	100	12	1600	0.55	400
CLH1608T-39N□-S	39	5 / 10	100	12	1400	0.60	400
CLH1608T-47N□-S	47	5 / 10	100	12	1300	0.70	400
CLH1608T-56N□-S	56	5 / 10	100	12	1100	0.75	400
CLH1608T-62N□-S	62	5 / 10	100	12	1050	0.85	400
CLH1608T-68N□-S	68	5 / 10	100	12	1050	0.85	400
CLH1608T-75N□-S	75	5 / 10	100	12	900	1.00	300
CLH1608T-82N□-S	82	5 / 10	100	12	900	1.00	300
CLH1608T-R10□-S	100	5 / 10	100	12	770	1.20	300
CLH1608T-R12□-S	120	5 / 10	50	8	650	1.30	300
CLH1608T-R15□-S	150	5 / 10	50	8	550	1.70	250
CLH1608T-R18□-S	180	5 / 10	50	8	520	1.90	250
CLH1608T-R22□-S	220	5 / 10	50	8	500	2.00	250
CLH1608T-R27□-S	270	5 / 10	50	8	470	2.20	150
CLH1608T-R33□-S	330	5 / 10	50	8	320	2.80	100
CLH1608T-R39□-S	390	5 / 10	50	8	300	3.00	100

Note: When ordering, please specify tolerance code. Tolerance : S=±0.3nH , J=±5% , K=±10%

- Operating temperature range - 55°C ~ 125°C(Including self - temperature rise)
- IDC : Applied the current to coils, the inductance shall be less than 10% initial value
- Measure Equipment :
 L & Q : Agilent E4991A+Agilent 16197A
 SRF : HP8753D
 RDC : HP4338B or CHEN HWA 502

Please be sure to request approval specifications that provide further details of the products. Kindly note that the content of these specifications are subject to change or may be discontinued without advance notice. Please contact our sales department before ordering.

Test Instruments : Agilent E4991A Material/Impedance Analyzer

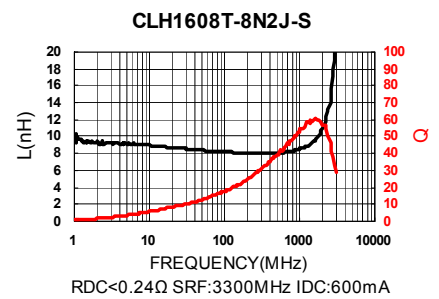
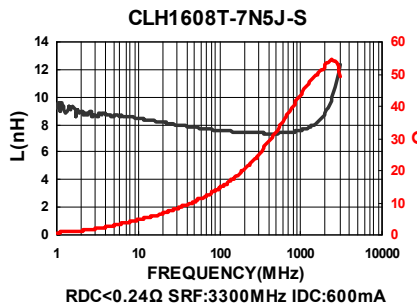
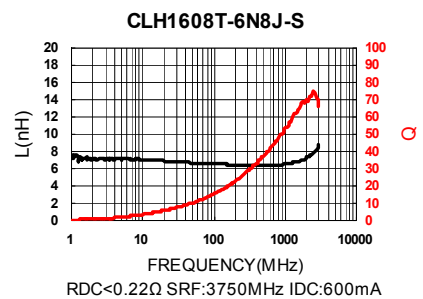
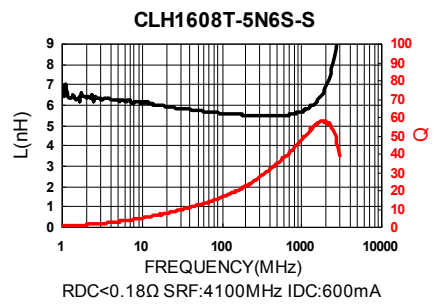
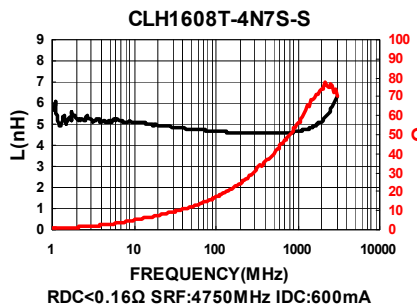
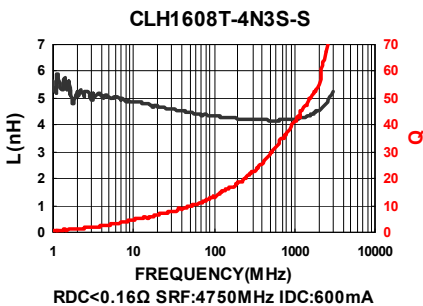
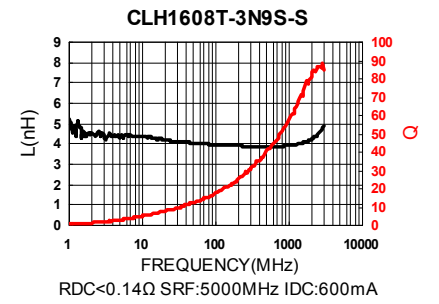
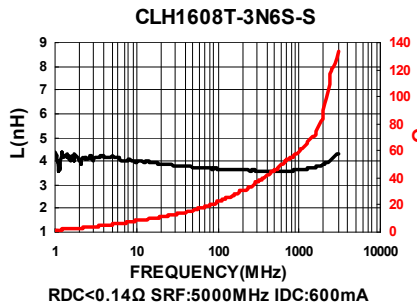
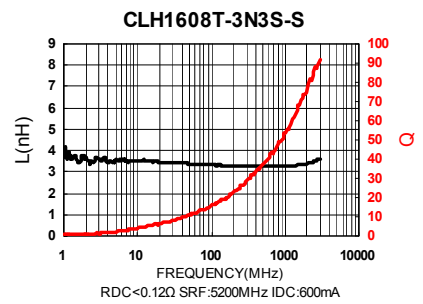
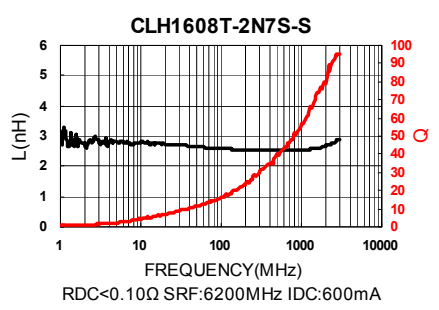
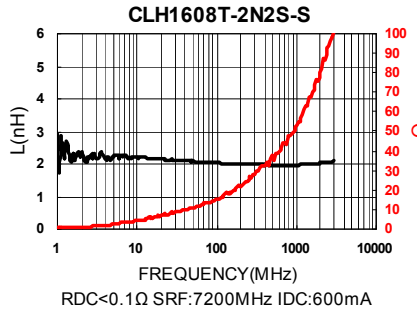
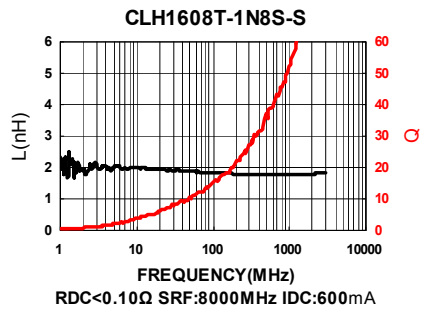
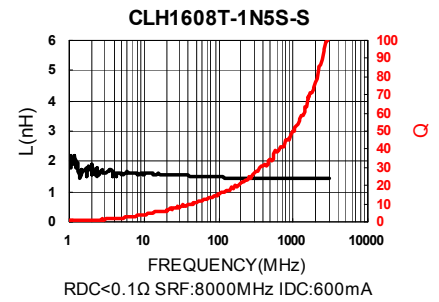
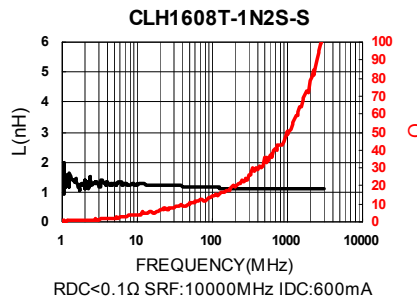
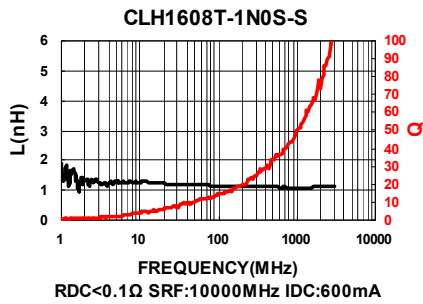

Please be sure to request approval specifications that provide further details of the products. Kindly note that the content of these specifications are subject to change or may be discontinued without advance notice. Please contact our sales department before ordering.

Test Instruments : Agilent E4991A Material/Impedance Analyzer

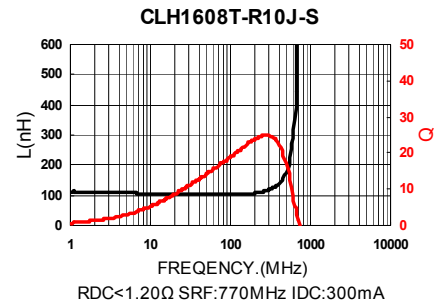
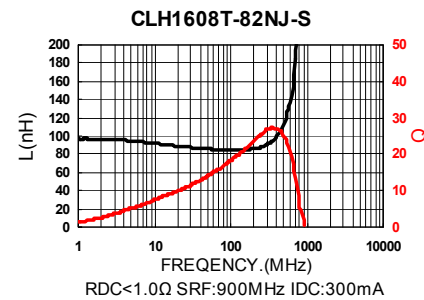
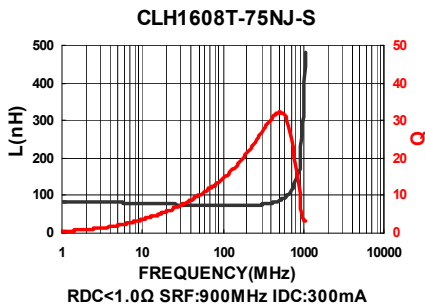
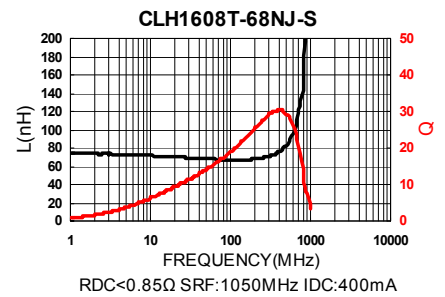
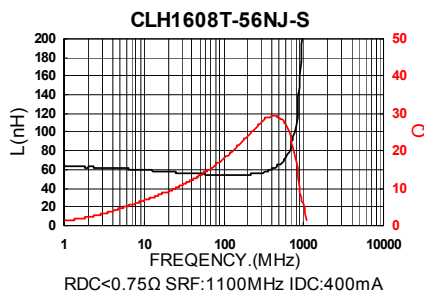
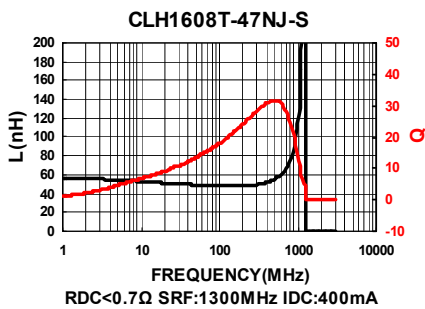
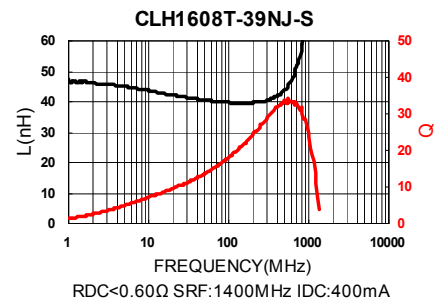
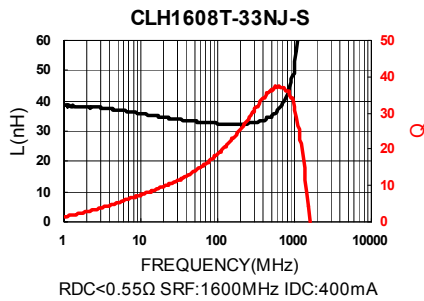
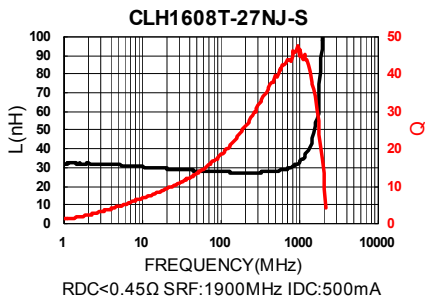
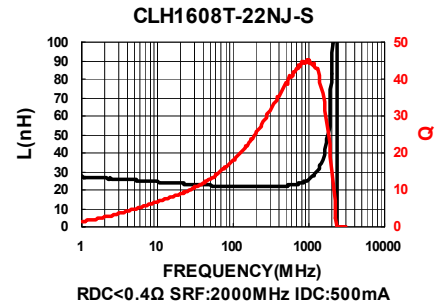
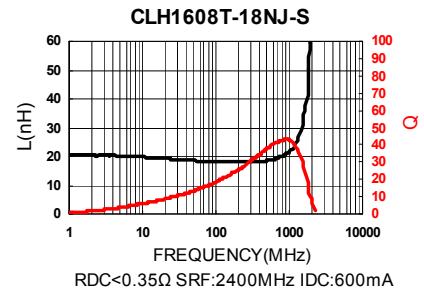
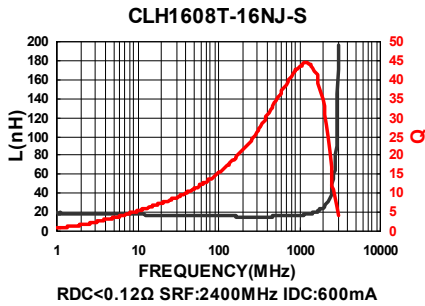
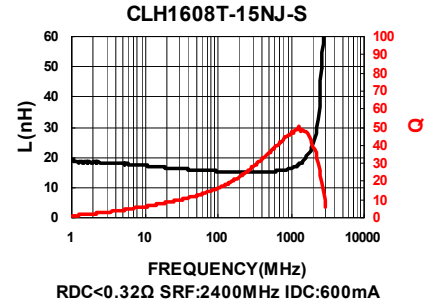
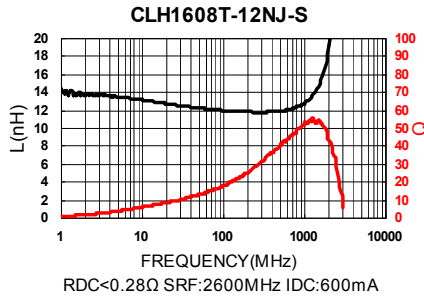
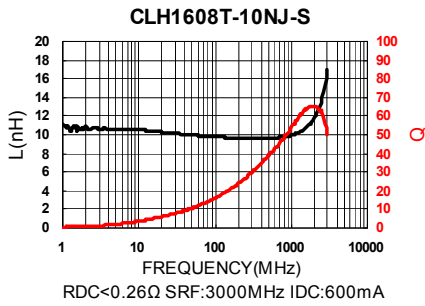

Please be sure to request approval specifications that provide further details of the products. Kindly note that the content of these specifications are subject to change or may be discontinued without advance notice. Please contact our sales department before ordering.

Test Instruments : Agilent E4991A Material/Impedance Analyzer

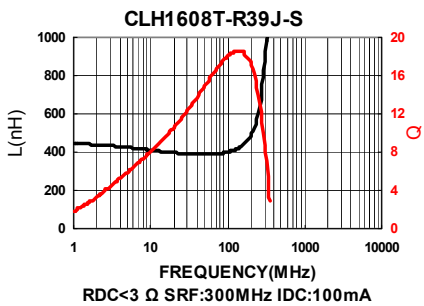
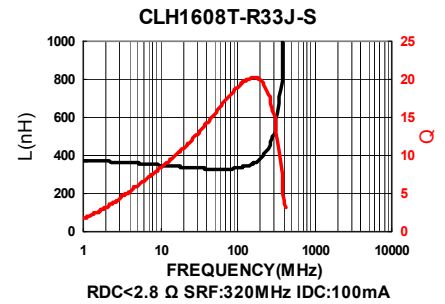
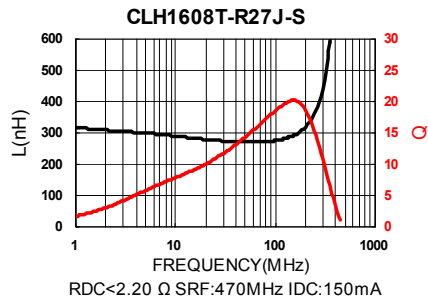
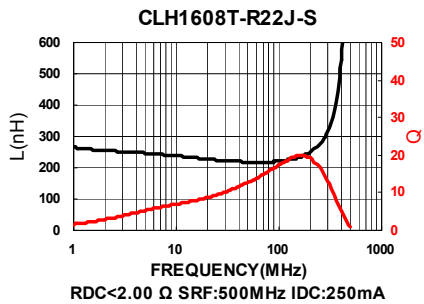
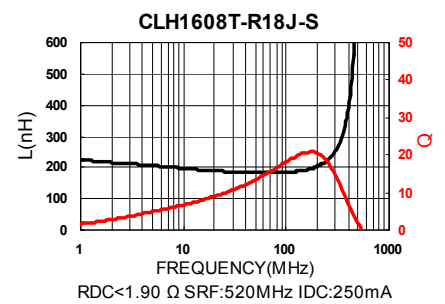
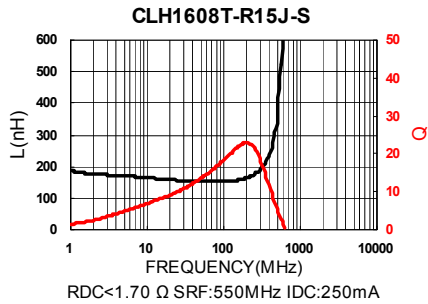
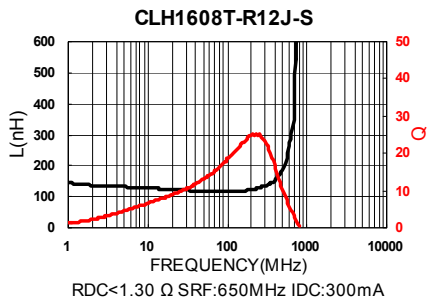

Please be sure to request approval specifications that provide further details of the products. Kindly note that the content of these specifications are subject to change or may be discontinued without advance notice. Please contact our sales department before ordering.

Packaging Specifications

Tape Dimensions

Figure A

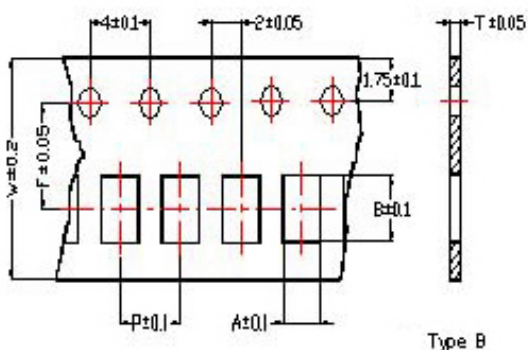

Tape Material

Figure A

Carrier Tape: Polycarbonate (Tape A)
 Carrier Tape: Paper (Tape B)
 Cover Tape: Polystyrene

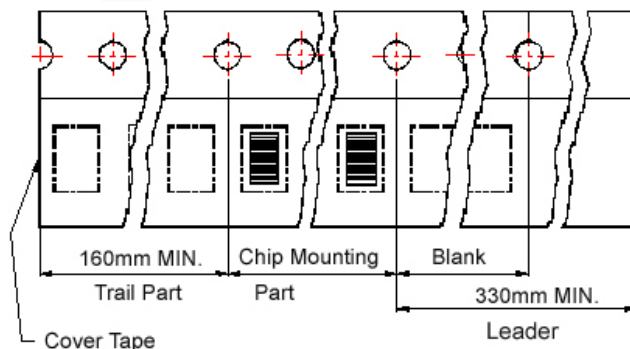
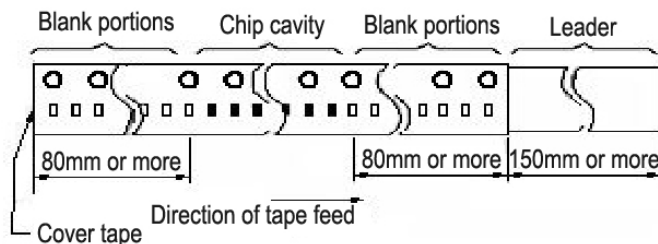
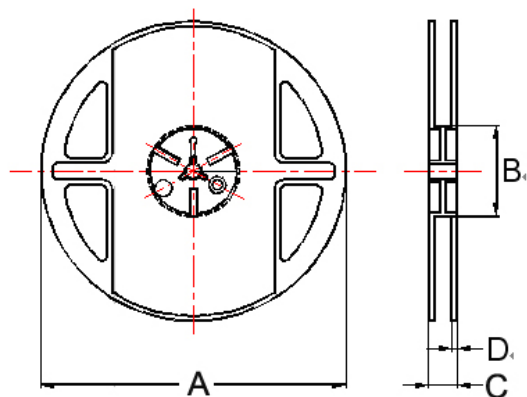

Figure B

Carrier tape : Paper
 Cover tape : Polyethylene



Reel Dimensions



Dimensions in mm

TYPE	Tape Dimensions							Tape Material	Reel Dimensions				Quantity PCS / Reel
	A	B	T	W	P	F	A		B	C	D		
CLH0603	0.37	0.67	0.42	8	2	3.5	A	B	180	60	13	1.5	15000
CLH1005	0.62	1.12	0.60	8	2	3.5	A	A	178	60	12	1.5	10000
CLH1608	1.00	1.80	0.95	8	4	3.5	A	A	178	60	12	1.5	4000

CM Series



Due to accurate wire winding technology, these chip inductors are designed for filtering impedance matching, resonance and choke circuits for RF designer. Both standard series and custom designs are available.

Features

- RoHS Compliant
- Ceramic body and wire wound construction provide high SRFs
- Exceptional Q value even at high frequencies
- Ceramic construction delivers the highest possible SRFs as well as high Q value
- Low DC resistance design supports low loss, high output and low power consumption
- CM series is standard for RF designers

Applications

- RF products for cellular phone
- GPS receiver
- Base Station
- Repeater
- Wireless LAN/ mouse/ keyboard/ earphone
- Remote control
- Security system and other RF modules

Product Identification

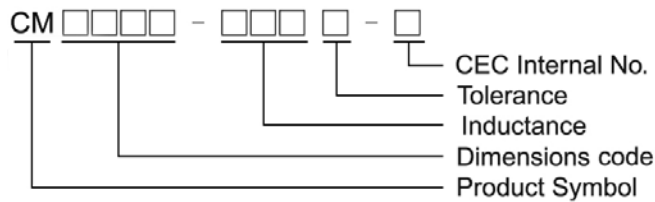

Shape and Dimensions / Recommended Pattern

CM0402

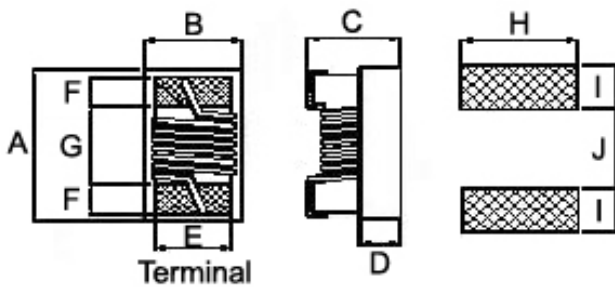

CM0603

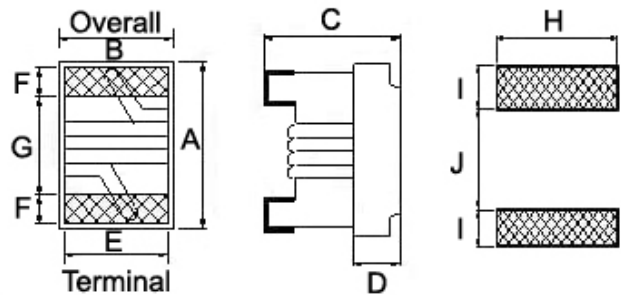

Dimensions

	A Max	B Max	C Max	D	E	F	G	H	I	J
CM0402	1.19	0.70	0.66	0.25	0.51	0.23	0.56	0.66	0.36	0.46
CM0603	1.6 ^{+0.2} _{-0.1}	1.02 ± 0.1	0.82 ^{+0.2} _{-0.1}	0.35	0.70	0.30	0.95	1.02	0.64	0.64

Electrical Characteristics

Part Number	Inductance (nH)	Tolerance (±%)	Test Frequency (MHz)	Q Min	Test Frequency (MHz)	SRF (GHz) Min	RDC (Ω) Max	Irms (mA) Max
CM0402-1N5□-N	1.5	±0.1nH/±0.2nH/±0.5nH	100	10	250	18.0	0.03	1000
CM0402-2N4□-N	2.4	±0.1nH/±0.2nH/±0.5nH	100	20	250	15.0	0.05	850
CM0402-2N5□-N	2.5	±0.1nH/±0.2nH/±0.5nH	100	20	250	15.0	0.05	850
CM0402-2N7□-N	2.7	±0.1nH/±0.2nH/±0.5nH	100	20	250	15.0	0.05	850
CM0402-2N9□-N	2.9	±0.1nH/±0.2nH/±0.5nH	100	20	250	15.0	0.07	750
CM0402-3N9□-N	3.9	3 / 5	100	25	250	10.0	0.07	750
CM0402-4N1□-N	4.1	3 / 5	100	25	250	10.0	0.07	750
CM0402-4N3□-N	4.3	3 / 5	100	25	250	10.0	0.07	750
CM0402-4N7□-N	4.7	3 / 5	100	25	250	8.0	0.07	750
CM0402-5N1□-N	5.1	3 / 5	100	25 typ	250	8.0	0.12	600
CM0402-5N8□-N	5.8	3 / 5	100	25	250	8.0	0.12	700
CM0402-6N2□-N	6.2	3 / 5	100	25	250	8.0	0.09	700
CM0402-6N8□-N	6.8	3 / 5	100	25	250	6.0	0.09	700
CM0402-7N3□-N	7.3	3 / 5	100	25	250	6.0	0.13	570
CM0402-7N5□-N	7.5	3 / 5	100	25	250	6.0	0.13	570
CM0402-8N2□-N	8.2	3 / 5	100	25	250	5.5	0.14	540
CM0402-8N7□-N	8.7	3 / 5	100	25	250	5.5	0.14	540
CM0402-9N1□-N	9.1	3 / 5	100	25	250	5.5	0.14	540
CM0402-9N5□-N	9.5	3 / 5	100	25	250	5.5	0.14	540
CM0402-10N□-N	10	2 / 3 / 5	100	25	250	5.5	0.17	500
CM0402-11N□-N	11	2 / 3 / 5	100	30	250	5.5	0.14	500
CM0402-12N□-N	12	2 / 3 / 5	100	30	250	5.5	0.14	500
CM0402-13N□-N	13	2 / 3 / 5	100	25	250	5.0	0.21	430
CM0402-15N□-N	15	2 / 3 / 5	100	30	250	5.0	0.16	460
CM0402-16N□-N	16	2 / 3 / 5	100	25	250	4.5	0.24	370
CM0402-18N□-N	18	2 / 3 / 5	100	25	250	4.5	0.27	370
CM0402-19N□-N	19	2 / 3 / 5	100	25	250	4.5	0.27	370
CM0402-20N□-N	20	2 / 3 / 5	100	25	250	4.0	0.27	370
CM0402-22N□-N	22	2 / 3 / 5	100	25	250	4.0	0.30	310
CM0402-23N□-N	23	2 / 3 / 5	100	25	250	3.8	0.30	310
CM0402-24N□-N	24	2 / 3 / 5	100	25	250	3.5	0.52	280
CM0402-27N□-N	27	2 / 3 / 5	100	25	250	3.5	0.52	280
CM0402-30N□-N	30	2 / 3 / 5	100	25	250	3.3	0.58	270
CM0402-33N□-N	33	2 / 3 / 5	100	25	250	3.2	0.63	260
CM0402-36N□-N	36	2 / 3 / 5	100	25	250	3.1	0.63	260
CM0402-39N□-N	39	2 / 3 / 5	100	25	250	3.0	0.70	250
CM0402-40N□-N	40	2 / 3 / 5	100	25	250	3.0	0.70	250
CM0402-47N□-N	47	2 / 3 / 5	100	25	200	2.9	1.08	210
CM0402-51N□-N	51	2 / 3 / 5	100	25	200	2.85	1.08	210
CM0402-56N□-N	56	2 / 3 / 5	100	25	200	2.80	1.17	200
CM0402-62N□-N	62	2 / 3 / 5	100	20	200	2.60	1.82	145

Note: When ordering, please specify tolerance code. Tolerance : B=±0.1nH , C=±0.2nH , D=±0.5nH , G=±2% , H=±3% , J=±5%

- Operating temperature range - 40°C ~ 125°C(Including self - temperature rise)
- Irms for a 15°C temperature rise from 25°C ambient with current
- Measure Equipment :
 L & Q : Agilent E4991A+Agilent HP16197A
 SRF : Agilent HP8753D/Agilent HP8722ES
 RDC : Chroma 16502
 Irms : HP4284A+HP42841A/HP4285A+HP42841A

Please be sure to request approval specifications that provide further details of the products. Kindly note that the content of these specifications are subject to change or may be discontinued without advance notice. Please contact our sales department before ordering.

Electrical Characteristics

Part Number	Inductance (nH)	Tolerance (±%)	Test Frequency (MHz)	Q Min	Test Frequency (MHz)	SRF (GHz) Min	RDC (Ω) Max	Irms (mA) Max
CM0402-68N□-N	68	2 / 3 / 5	100	20	200	2.50	1.96	140
CM0402-72N□-N	72	2 / 3 / 5	100	20	150	2.50	2.10	135
CM0402-75N□-N	75	2 / 3 / 5	100	20	150	2.40	2.10	135
CM0402-82N□-N	82	2 / 3 / 5	100	20	150	2.30	2.24	130
CM0402-91N□-N	91	2 / 3 / 5	100	20	150	2.10	2.38	125
CM0402-R10□-N	100	2 / 3 / 5	100	20	150	1.50	2.52	120
CM0402-R12□-N	120	2 / 3 / 5	100	20	150	1.00	2.66	110

Note: When ordering, please specify tolerance code. Tolerance : B=±0.1nH , C=±0.2nH , D=±0.5nH , G=±2% , H=±3% , J=±5%

- Operating temperature range - 40°C ~ 125°C(Including self - temperature rise)
- I rms for a 15°C temperature rise from 25°C ambient with current
- Measure Equipment :
 L & Q : Agilent E4991A+Agilent HP16197A
 SRF : Agilent HP8753D/Agilent HP8722ES
 RDC : Chroma 16502
 I rms : HP4284A+HP42841A/HP4285A+HP42841A

Typical **L** vs. **F** Frequency

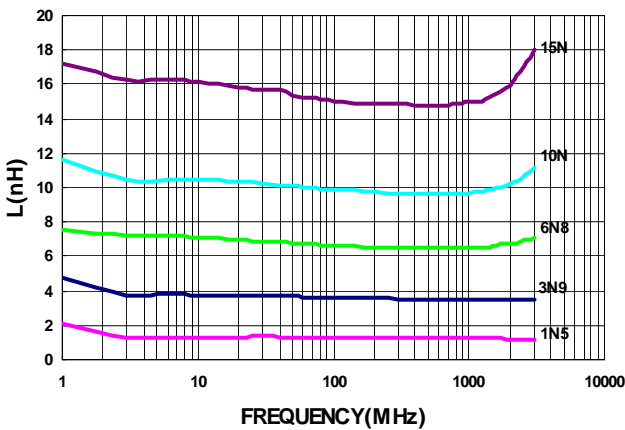

Typical **Q** vs. **F** Frequency

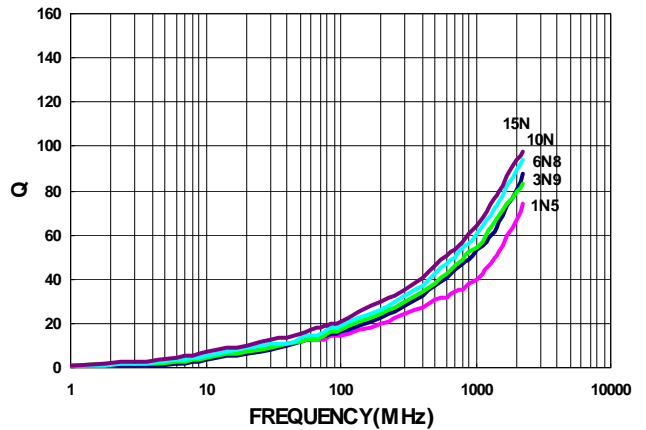

Please be sure to request approval specifications that provide further details of the products. Kindly note that the content of these specifications are subject to change or may be discontinued without advance notice. Please contact our sales department before ordering.

Electrical Characteristics

Part Number	Inductance (nH)	Tolerance (±%)	Test Frequency (MHz)	Q Min	Test Frequency (MHz)	SRF (GHz) Min	RDC (Ω) Max	Irms (mA) Max
CM0603-2N2□-N	2.2	±0.1nH/±0.2nH/±0.5nH	100	16	250	6.0	0.049	700
CM0603-3N6□-N	3.6	3 / 5	100	25	250	6.0	0.059	850
CM0603-3N9□-N	3.9	3 / 5	100	35	250	6.0	0.059	850
CM0603-4N3□-N	4.3	3 / 5	100	35	250	6.0	0.059	850
CM0603-4N7□-N	4.7	3 / 5	100	35	250	6.0	0.059	850
CM0603-5N6□-N	5.6	3 / 5	100	35	250	6.0	0.082	750
CM0603-6N2□-N	6.2	3 / 5	100	35	250	6.0	0.082	750
CM0603-6N8□-N	6.8	3 / 5	100	35	250	6.0	0.082	750
CM0603-7N5□-N	7.5	3 / 5	100	35	250	6.0	0.082	750
CM0603-8N2□-N	8.2	3 / 5	100	35	250	6.0	0.110	650
CM0603-8N7□-N	8.7	3 / 5	100	35	250	6.0	0.110	650
CM0603-9N1□-N	9.1	3 / 5	100	35	250	6.0	0.110	650
CM0603-9N5□-N	9.5	3 / 5	100	35	250	6.0	0.110	650
CM0603-10N□-N	10	2 / 3 / 5	100	35	250	6.0	0.110	650
CM0603-11N□-N	11	2 / 3 / 5	100	35	250	6.0	0.110	650
CM0603-12N□-N	12	2 / 3 / 5	100	35	250	6.0	0.130	600
CM0603-13N□-N	13	2 / 3 / 5	100	35	250	6.0	0.130	600
CM0603-15N□-N	15	2 / 3 / 5	100	40	250	6.0	0.130	600
CM0603-16N□-N	16	2 / 3 / 5	100	40	250	5.5	0.160	550
CM0603-18N□-N	18	2 / 3 / 5	100	40	250	5.5	0.160	550
CM0603-20N□-N	20	2 / 3 / 5	100	40	250	4.9	0.160	550
CM0603-22N□-N	22	2 / 3 / 5	100	40	250	4.6	0.170	500
CM0603-24N□-N	24	2 / 3 / 5	100	40	250	3.8	0.210	500
CM0603-27N□-N	27	2 / 3 / 5	100	40	250	3.7	0.210	440
CM0603-30N□-N	30	2 / 3 / 5	100	40	250	3.3	0.230	420
CM0603-33N□-N	33	2 / 3 / 5	100	40	250	3.2	0.230	420
CM0603-36N□-N	36	2 / 3 / 5	100	40	250	2.9	0.260	400
CM0603-39N□-N	39	2 / 3 / 5	100	40	250	2.8	0.260	400
CM0603-43N□-N	43	2 / 3 / 5	100	40	200	2.7	0.290	380
CM0603-47N□-N	47	2 / 3 / 5	100	38	200	2.6	0.290	380
CM0603-51N□-N	51	2 / 3 / 5	100	38	200	2.5	0.330	370
CM0603-56N□-N	56	2 / 3 / 5	100	38	200	2.4	0.350	360
CM0603-62N□-N	62	2 / 3 / 5	100	38	200	2.3	0.510	280
CM0603-68N□-N	68	2 / 3 / 5	100	38	200	2.2	0.380	340
CM0603-72N□-N	72	2 / 3 / 5	100	34	150	2.1	0.560	270
CM0603-75N□-N	75	2 / 3 / 5	100	34	150	2.05	0.560	270
CM0603-82N□-N	82	2 / 3 / 5	100	34	150	2.00	0.600	250
CM0603-91N□-N	91	2 / 3 / 5	100	34	150	1.90	0.640	230
CM0603-R10□-N	100	2 / 3 / 5	100	34	150	1.80	0.680	220
CM0603-R11□-N	110	2 / 3 / 5	100	32	150	1.70	1.200	200

Note: When ordering, please specify tolerance code. Tolerance : B=±0.1nH , C=±0.2nH , D=±0.5nH , G=±2% , H=±3% , J=±5%

- Operating temperature range - 40°C ~ 125°C(Including self - temperature rise)
- Irms for a 15°C temperature rise from 25°C ambient with current
- Measure Equipment :
L & Q : Agilent E4991A+Agilent HP16197A
SRF : Agilent HP8753D/Agilent HP8722ES
RDC : Chroma 16502
Irms : HP4284A+HP42841A/HP4285A+HP42841A

Please be sure to request approval specifications that provide further details of the products. Kindly note that the content of these specifications are subject to change or may be discontinued without advance notice. Please contact our sales department before ordering.

Electrical Characteristics

Part Number	Inductance (nH)	Tolerance (±%)	Test Frequency (MHz)	Q Min	Test Frequency (MHz)	SRF (GHz) Min	RDC (Ω) Max	Irms (mA) Max
CM0603-R12□-N	120	2 / 3 / 5	100	32	150	1.60	1.300	180
CM0603-R13□-N	130	2 / 3 / 5	100	32	150	1.45	1.400	170
CM0603-R15□-N	150	2 / 3 / 5	100	32	150	1.40	1.500	160
CM0603-R16□-N	160	2 / 3 / 5	100	32	150	1.35	2.100	150
CM0603-R18□-N	180	2 / 3 / 5	100	25	100	1.30	2.200	140
CM0603-R20□-N	200	2 / 3 / 5	100	25	100	1.25	2.400	120
CM0603-R22□-N	220	2 / 3 / 5	100	25	100	1.20	2.500	120
CM0603-R27□-N	270	2 / 3 / 5	100	30	100	0.96	3.400	110
CM0603-R33□-N	330	2 / 3 / 5	100	30	100	0.80	5.500	85
CM0603-R39□-N	390	2 / 3 / 5	100	30	100	0.80	6.200	80
CM0603-R47□-N	470	2 / 3 / 5	100	30	100	0.70	7.000	75

Note: When ordering, please specify tolerance code. Tolerance : B=±0.1nH , C=±0.2nH , D=±0.5nH , G=±2% , H=±3% , J=±5%

- Operating temperature range - 40°C ~ 125°C(Including self - temperature rise)
- I rms for a 15°C temperature rise from 25°C ambient with current
- Measure Equipment :
 L & Q : Agilent E4991A+Agilent HP16197A
 SRF : Agilent HP8753D/Agilent HP8722ES
 RDC : Chroma 16502
 I rms : HP4284A+HP42841A/HP4285A+HP42841A

Typical **L** vs. **F**requency

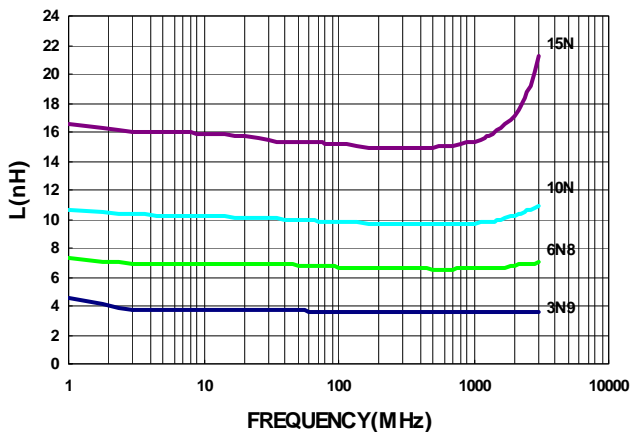

Typical **Q** vs. **F**requency

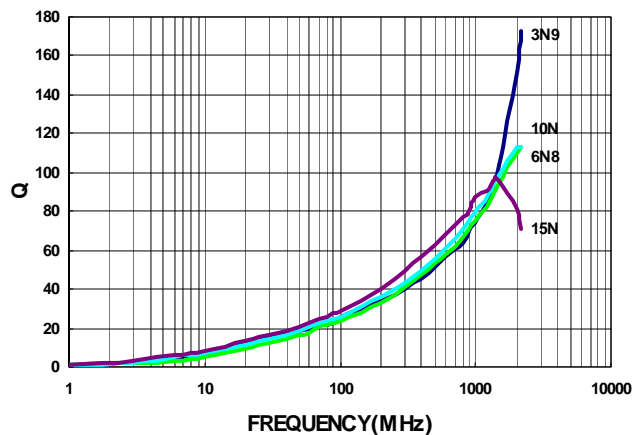

Please be sure to request approval specifications that provide further details of the products. Kindly note that the content of these specifications are subject to change or may be discontinued without advance notice. Please contact our sales department before ordering.

Packaging Specifications

Tape Dimensions

Figure 1

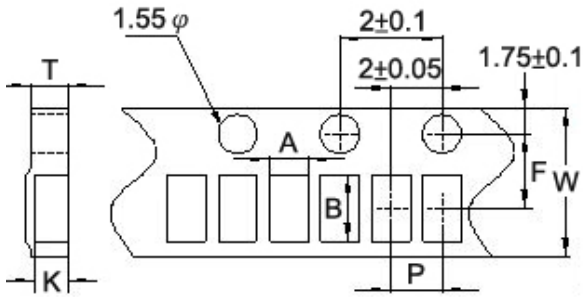

Tape Material

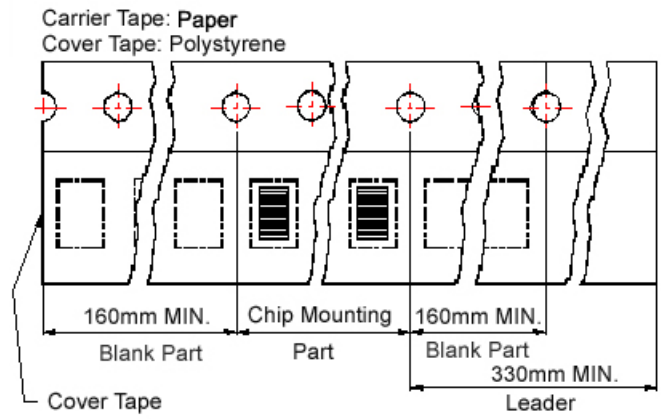
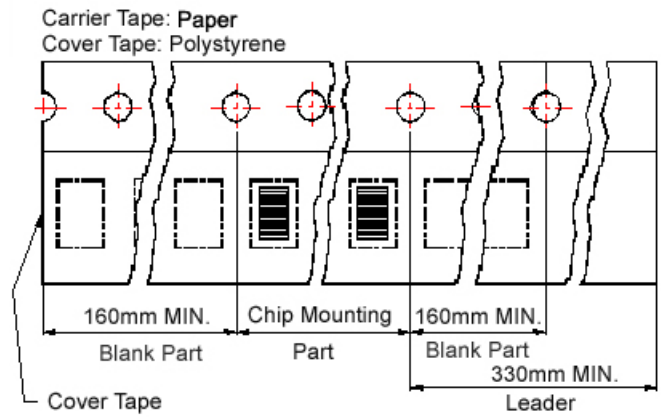
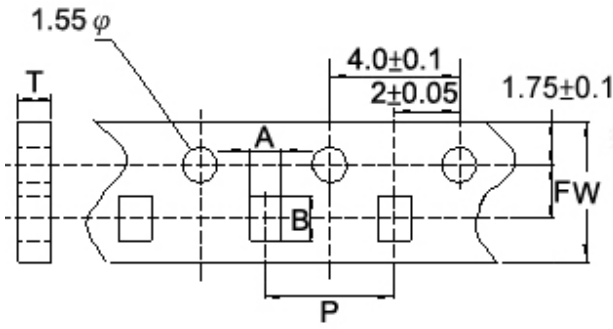
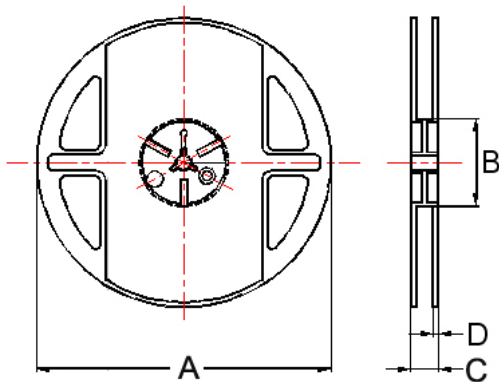

Figure 2



Reel Dimensions



Dimensions in mm

TYPE	Fig.	Tape Dimensions							Reel Dimensions				Quantity PCS / Reel
		A	B	T	W	P	F	K	A	B	C	D	
CM0402	1	0.67	1.20	0.75	8	2	3.5	0.59	178	60	12	1.5	4000
CM0603	2	1.20	1.80	1.05	8	4	3.5	-	178	60	12	1.5	4000

CS Series



Due to accurate wire winding technology, these chip inductors are designed for filtering, impedance matching, resonance and choke circuits for RF designer. Both standard series custom designs are available.

Features

- RoHS Compliant
- Ceramic body and wire wound construction provide high SRFs
- Exceptional Q values even at high frequencies
- Highest possible SRFs as well as excellent Q values
- The non-magnetic coil form assures utmost thermal stability, predictability and batch consistency
- CS series is standard for RF designers

Applications

- RF products for cellular phone
- GPS receiver
- Base Station
- Repeater
- Wireless LAN/ mouse/ keyboard/ earphone
- Remote control
- Security system and other RF modules

Product Identification

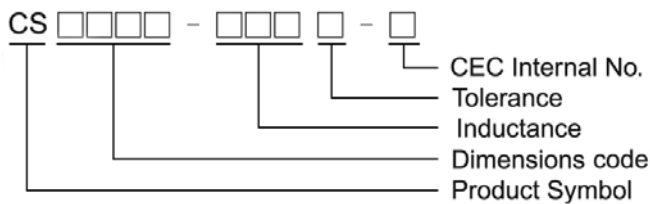

Shape and Dimensions / Recommended Pattern

CS0201

CS0402

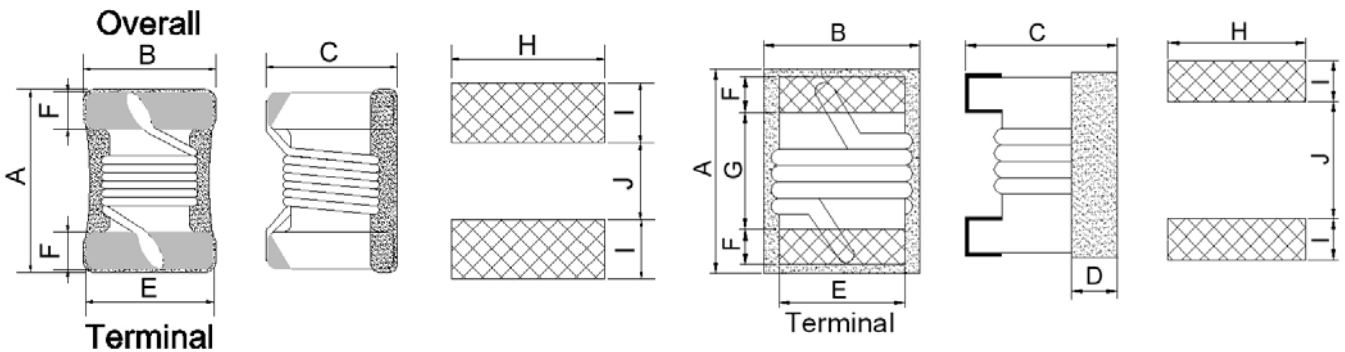

Dimensions

		A Max	B Max	C Max	D	E	F	G	H	I	J
CS0201	inch	0.023	0.018	0.018	-	0.015	0.004	-	0.018	0.007	0.009
	mm	0.58	0.46	0.45	-	0.38	0.1	-	0.46	0.18	0.23
CS0402	inch	0.047	0.028	0.026	0.010	0.020	0.009	0.022	0.026	0.014	0.018
	mm	1.19	0.70	0.66	0.25	0.51	0.23	0.56	0.66	0.36	0.46

CS0603/0805/1008

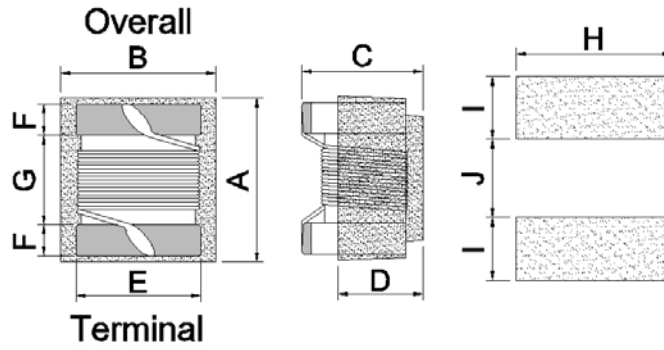

Dimensions

		A	B	C	D	E	F	G	H	I	J
CS0603	mm	1.6 ^{+0.2} _{-0.1}	1.02±0.1	0.82 ^{+0.2} _{-0.1}	0.51	0.76	0.33	0.86	1.02	0.64	0.64
		A Max	B Max	C Max	D	E	F	G	H	I	J
CS0805	inch	0.093	0.068	0.06	0.028	0.050	0.020	0.040	0.070	0.040	0.030
	mm	2.35	1.73	1.52	0.71	1.27	0.51	1.02	1.78	1.02	0.76
CS1008	inch	0.115	0.110	0.083	0.046	0.080	0.020	0.060	0.100	0.040	0.050
	mm	2.92	2.79	2.1	1.16	2.03	0.51	1.52	2.54	1.02	1.27

Electrical Characteristics

Part Number	Inductance (nH)	Tolerance (±%)	Test Frequency (MHz)	Q Min	SRF (GHz) Typ	RDC (Ω) Max	I _{rms} (mA) Typ
CS0201-0N5□-S	0.5	10	250	4	23.5	0.02	1250
CS0201-0N6□-S	0.6	10	250	6	24.5	0.03	1000
CS0201-1N2□-S	1.2	5	250	13	17.9	0.042	870
CS0201-1N3□-S	1.3	5	250	11	17.6	0.048	820
CS0201-1N4□-S	1.4	5	250	14	17	0.08	630
CS0201-1N5□-S	1.5	5	250	11	17	0.09	600
CS0201-2N2□-S	2.2	5	250	15	16.7	0.07	700
CS0201-2N3□-S	2.3	5	250	18	16.5	0.07	670
CS0201-2N4□-S	2.4	5	250	13	13	0.082	620
CS0201-2N5□-S	2.5	5	250	16	12.5	0.165	440
CS0201-3N3□-S	3.3	5	250	14	12.8	0.08	630
CS0201-3N4□-S	3.4	5	250	11	12.7	0.08	630
CS0201-3N5□-S	3.5	5	250	16	12.4	0.08	630
CS0201-3N6□-S	3.6	5	250	18	12.5	0.105	550
CS0201-3N7□-S	3.7	5	250	15	10.6	0.105	550
CS0201-3N8□-S	3.8	5	250	16	10.2	0.18	420
CS0201-3N9□-S	3.9	5	250	12	11.2	0.24	360
CS0201-4N8□-S	4.8	5	250	17	11	0.096	570
CS0201-4N9□-S	4.9	5	250	18	11.7	0.13	510
CS0201-5N0□-S	5.0	5	250	18	11.5	0.13	510
CS0201-5N1□-S	5.1	5	250	18	11.1	0.13	510
CS0201-5N2□-S	5.2	5	250	18	10	0.17	430
CS0201-5N3□-S	5.3	5	250	18	10.6	0.13	510
CS0201-5N4□-S	5.4	5	250	18	10.2	0.13	510
CS0201-5N5□-S	5.5	5	250	16	9.5	0.285	330
CS0201-6N7□-S	6.7	5	250	18	6.8	0.15	460
CS0201-6N8□-S	6.8	5	250	18	9.5	0.15	460
CS0201-6N9□-S	6.9	5	250	18	9.3	0.15	460
CS0201-7N0□-S	7.0	5	250	18	6.7	0.21	390
CS0201-7N1□-S	7.1	5	250	18	9.5	0.25	390
CS0201-7N2□-S	7.2	5	250	18	9.4	0.25	390
CS0201-7N3□-S	7.3	5	250	18	9.3	0.25	390
CS0201-7N4□-S	7.4	5	250	18	9.1	0.25	390
CS0201-7N5□-S	7.5	5	250	15	6.8	0.34	300
CS0201-7N6□-S	7.6	5	250	17	9.3	0.3	340
CS0201-7N7□-S	7.7	5	250	17	9.2	0.3	340
CS0201-7N8□-S	7.8	5	250	17	9.2	0.3	340
CS0201-7N9□-S	7.9	5	250	17	9.1	0.3	340
CS0201-8N0□-S	8.0	5	250	17	9.2	0.3	340
CS0201-8N1□-S	8.1	5	250	17	9.1	0.3	340
CS0201-8N2□-S	8.2	5	250	17	6.4	0.27	340

Note: When ordering, please specify tolerance code. Tolerance : J=±5% , K=±10%

- Operating temperature range - 40°C ~ 125°C(Including self - temperature rise)
- I_{rms} for a 15°C temperature rise from 25°C ambient with current
- Measure Equipment :
 L & Q : Agilent E4991A+Agilent HP16197A
 SRF : Agilent HP8753D/Agilent HP8722ES
 RDC : HP4287A
 I_{rms} : HP4284A+HP42841A/HP4285A+HP42841A

Please be sure to request approval specifications that provide further details of the products. Kindly note that the content of these specifications are subject to change or may be discontinued without advance notice. Please contact our sales department before ordering.

Electrical Characteristics

Part Number	Inductance (nH)	Tolerance (±%)	Test Frequency (MHz)	Q Min	SRF (GHz) Typ	RDC (Ω) Max	Irms (mA) Typ
CS0201-8N3□-S	8.3	5	250	17	8.9	0.3	340
CS0201-8N4□-S	8.4	5	250	15	8.9	0.38	300
CS0201-8N5□-S	8.5	5	250	15	8.9	0.38	300
CS0201-8N7□-S	8.7	5	250	15	6.3	0.38	300
CS0201-9N0□-S	9.0	5	250	15	6.4	0.38	300
CS0201-9N4□-S	9.4	5	250	16	6.4	0.4	280
CS0201-9N6□-S	9.6	5	250	16	6.2	0.4	280
CS0201-11N□-S	11	5	250	16	5.7	0.44	280
CS0201-12N□-S	12	5	250	17	5.6	0.36	300
CS0201-13N□-S	13	5	250	16	6.7	0.5	270
CS0201-14N□-S	14	5	250	16	5.1	0.5	270

Note: When ordering, please specify tolerance code. Tolerance : J=±5% , K=±10%

- Operating temperature range - 40°C ~ 125°C(Including self - temperature rise)
- Irms for a 15°C temperature rise from 25°C ambient with current
- Measure Equipment :
 L & Q : Agilent E4991A+Agilent HP16197A
 SRF : Agilent HP8753D/Agilent HP8722ES
 RDC : HP4287A
 Irms : HP4284A+HP42841A/HP4285A+HP42841A

Typical L vs. Frequency

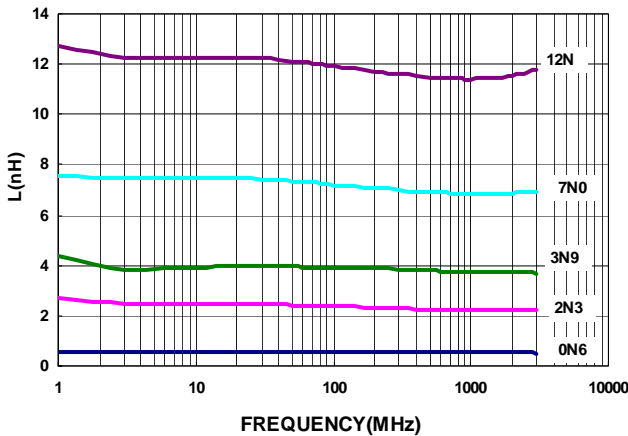

Typical Q vs. Frequency

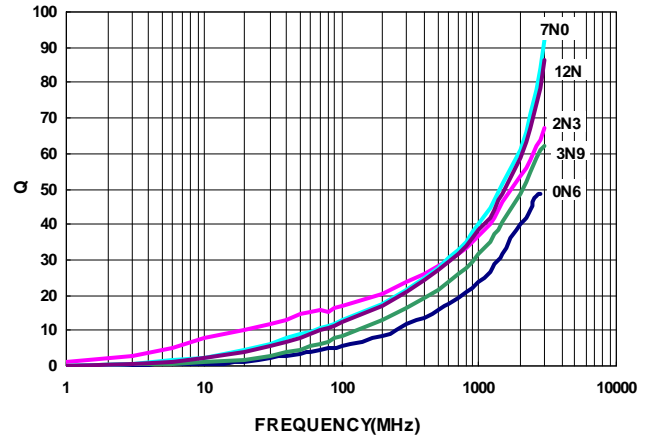

Please be sure to request approval specifications that provide further details of the products. Kindly note that the content of these specifications are subject to change or may be discontinued without advance notice. Please contact our sales department before ordering.

Electrical Characteristics

Part Number	Inductance (nH)	Tolerance (±%)	Test Frequency (MHz)	Q Min	SRF (GHz) Min	RDC (Ω) Max	Irms (mA) Max
CS0402-1N0□-S	1.0	10 / 5 / ±0.1nH	250	16	12.7	0.045	1360
CS0402-1N2□-S	1.2	10 / 5 / ±0.1nH	250	10	10.4	0.140	640
CS0402-1N3□-S	1.3	10 / ±0.1nH	250	10	10.4	0.140	640
CS0402-1N9□-S	1.9	10 / 5 / ±0.1nH	250	16	11.3	0.070	1040
CS0402-2N0□-S	2.0	10 / 5 / ±0.1nH	250	16	11.1	0.070	1040
CS0402-2N2□-S	2.2	10 / 5 / ±0.1nH	250	19	10.8	0.070	960
CS0402-2N4□-S	2.4	10 / 5 / ±0.1nH	250	15	10.5	0.068	790
CS0402-2N5□-S	2.5	10 / 5 / ±0.1nH	250	13	10.4	0.150	640
CS0402-2N7□-S	2.7	10 / 5 / ±0.1nH	250	16	10.4	0.120	640
CS0402-3N3□-S	3.3	10 / 5 / 3	250	19	7.00	0.066	840
CS0402-3N6□-S	3.6	10 / 5 / 3	250	19	6.80	0.066	840
CS0402-3N9□-S	3.9	10 / 5 / 3	250	19	6.00	0.066	840
CS0402-4N3□-S	4.3	10 / 5 / 3	250	18	6.00	0.091	700
CS0402-4N7□-S	4.7	10 / 5 / 3	250	15	4.77	0.130	640
CS0402-5N1□-S	5.1	10 / 5 / 3	250	20	4.80	0.083	800
CS0402-5N6□-S	5.6	10 / 5 / 3	250	20	4.80	0.083	760
CS0402-5N8□-S	5.8	10 / 5 / 3	250	20	4.80	0.083	760
CS0402-6N2□-S	6.2	10 / 5 / 3	250	20	4.80	0.083	760
CS0402-6N8□-S	6.8	10 / 5 / 3	250	20	4.80	0.083	680
CS0402-7N3□-S	7.3	10 / 5 / 3	250	20	4.80	0.12	680
CS0402-7N5□-S	7.5	10 / 5 / 3	250	22	4.80	0.10	680
CS0402-8N2□-S	8.2	10 / 5 / 3	250	22	4.40	0.10	680
CS0402-8N7□-S	8.7	10 / 5 / 3	250	18	4.10	0.20	480
CS0402-9N0□-S	9.0	10 / 5 / 3	250	22	4.16	0.10	680
CS0402-9N1□-S	9.1	10 / 5 / 3	250	22	4.16	0.10	680
CS0402-9N5□-S	9.5	10 / 5 / 3	250	18	4.00	0.20	480
CS0402-10N□-S	10	10 / 5 / 3 / 2	250	21	3.90	0.20	480
CS0402-11N□-S	11	10 / 5 / 3 / 2	250	24	3.68	0.12	640
CS0402-12N□-S	12	10 / 5 / 3 / 2	250	24	3.60	0.12	640
CS0402-13N□-S	13	10 / 5 / 3 / 2	250	24	3.45	0.21	440
CS0402-15N□-S	15	10 / 5 / 3 / 2	250	24	3.28	0.17	560
CS0402-16N□-S	16	10 / 5 / 3 / 2	250	24	3.10	0.22	560
CS0402-18N□-S	18	10 / 5 / 3 / 2	250	25	3.10	0.23	420
CS0402-19N□-S	19	10 / 5 / 3 / 2	250	24	3.04	0.20	480
CS0402-20N□-S	20	10 / 5 / 3 / 2	250	25	3.00	0.25	420
CS0402-22N□-S	22	10 / 5 / 3 / 2	250	25	2.80	0.30	400
CS0402-23N□-S	23	10 / 5 / 3 / 2	250	22	2.72	0.30	400
CS0402-24N□-S	24	10 / 5 / 3 / 2	250	25	2.70	0.30	400
CS0402-27N□-S	27	10 / 5 / 3 / 2	250	24	2.48	0.30	400
CS0402-30N□-S	30	10 / 5 / 3 / 2	250	25	2.35	0.35	400

Note: When ordering, please specify tolerance code. Tolerance : B=±0.1nH , G=±2% , H=±3% , J=±5% , K=±10%

- Operating temperature range - 40°C ~ 125°C(Including self - temperature rise)
- Irms for a 15°C temperature rise from 25°C ambient with current
- Measure Equipment :
 L & Q : Agilent E4991A+Agilent HP16197A
 SRF : Agilent HP8753D/Agilent HP8722ES
 RDC : HP4287A
 Irms : HP4284A+HP42841A/HP4285A+HP42841A

Please be sure to request approval specifications that provide further details of the products. Kindly note that the content of these specifications are subject to change or may be discontinued without advance notice. Please contact our sales department before ordering.

Electrical Characteristics

Part Number	Inductance (nH)	Tolerance (±%)	Test Frequency (MHz)	Q Min	SRF (GHz) Min	RDC (Ω) Max	Irms (mA) Max
CS0402-33N□-S	33	10 / 5 / 3 / 2	250	24	2.35	0.40	400
CS0402-36N□-S	36	10 / 5 / 3 / 2	250	24	2.32	0.44	320
CS0402-39N□-S	39	10 / 5 / 3 / 2	250	25	2.10	0.55	200
CS0402-40N□-S	40	10 / 5 / 3 / 2	250	24	2.24	0.65	320
CS0402-43N□-S	43	10 / 5 / 3 / 2	250	25	2.03	0.81	100
CS0402-47N□-S	47	10 / 5 / 3 / 2	250	20	2.10	0.83	150
CS0402-51N□-S	51	10 / 5 / 3 / 2	250	25	1.75	0.82	100
CS0402-56N□-S	56	10 / 5 / 3 / 2	250	22	1.76	0.97	100
CS0402-68N□-S	68	10 / 5 / 3 / 2	250	22	1.62	1.12	100
CS0402-82N□-S	82	10 / 5 / 3 / 2	250	20	1.26	1.55	50
CS0402-R10□-S	100	10 / 5 / 3 / 2	250	20	1.16	2.00	30
CS0402-R18□-S	180	10 / 5 / 3 / 2	100	8	0.70	2.70	50
CS0402-R22□-S	220	10 / 5 / 3 / 2	100	8	0.70	4.00	50

Note: When ordering, please specify tolerance code. Tolerance : B=±0.1nH , G=±2% , H=±3% , J=±5% , K=±10%

- Operating temperature range - 40°C ~ 125°C(Including self - temperature rise)
- I_{rms} for a 15°C temperature rise from 25°C ambient with current
- Measure Equipment :
 L & Q : Agilent E4991A+Agilent HP16197A
 SRF : Agilent HP8753D/Agilent HP8722ES
 RDC : HP4287A
 I_{rms} : HP4284A+HP42841A/HP4285A+HP42841A

Typical **L** vs. **F** Frequency

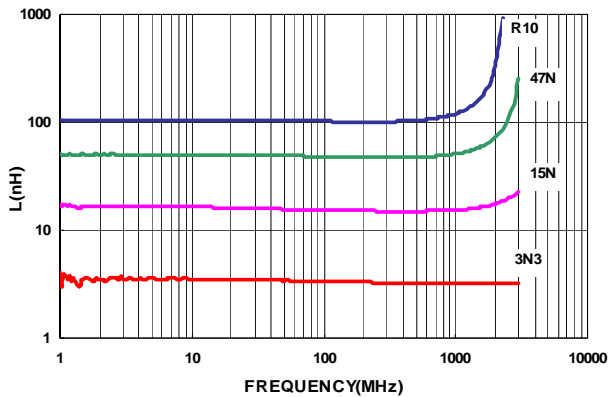

Typical **Q** vs. **F** Frequency

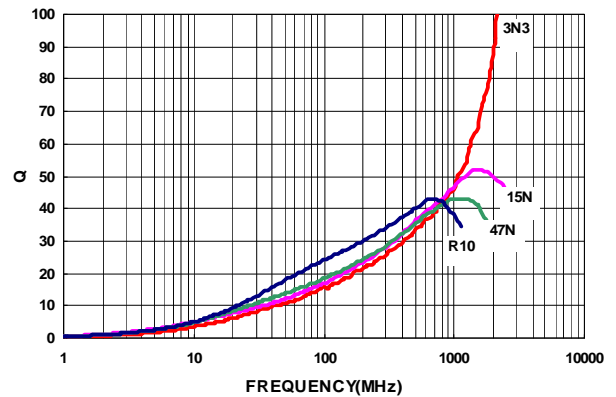

Please be sure to request approval specifications that provide further details of the products. Kindly note that the content of these specifications are subject to change or may be discontinued without advance notice. Please contact our sales department before ordering.

Electrical Characteristics

Part Number	Inductance (nH)	Tolerance (±%)	Test Frequency (MHz)	Q Min	SRF (MHz) Min	RDC (Ω) Max	Irms (mA) Max	Color
CS0603-1N6□-S	1.6	10 / 5 / ±0.1nH	250	24	12500	0.030	700	Red
CS0603-1N8□-S	1.8	10 / 5 / ±0.1nH	250	16	12500	0.045	700	Black
CS0603-2N2□-S	2.2	10 / 5 / ±0.1nH	250	13	12500	0.250	700	Yellow
CS0603-3N3□-S	3.3	10 / 5 / 3	250	35	5900	0.045	700	Blue
CS0603-3N6□-S	3.6	10 / 5 / 3 / 2	250	22	5900	0.063	700	Red
CS0603-3N9□-S	3.9	10 / 5 / 3 / 2	250	22	6900	0.080	700	Brown
CS0603-4N3□-S	4.3	10 / 5 / 3 / 2	250	22	5900	0.063	700	Orange
CS0603-4N7□-S	4.7	10 / 5 / 3 / 2	250	20	5800	0.116	700	Violet
CS0603-5N1□-S	5.1	10 / 5 / 3 / 2	250	20	5700	0.140	700	Green
CS0603-5N6□-S	5.6	10 / 5 / 3 / 2	250	20	5800	0.170	700	Yellow
CS0603-6N3□-S	6.3	10 / 5 / 3 / 2	250	20	5700	0.140	700	White
CS0603-6N8□-S	6.8	10 / 5 / 3 / 2	250	27	5800	0.110	700	Red
CS0603-7N5□-S	7.5	10 / 5 / 3 / 2	250	28	4800	0.106	700	Brown
CS0603-8N2□-S	8.2	10 / 5 / 3 / 2	250	28	4700	0.109	700	White
CS0603-8N7□-S	8.7	10 / 5 / 3 / 2	250	28	4600	0.109	700	Yellow
CS0603-9N1□-S	9.1	10 / 5 / 3 / 2	250	28	4800	0.120	700	Violet
CS0603-9N5□-S	9.5	10 / 5 / 3 / 2	250	28	5400	0.135	700	Blue
CS0603-10N□-S	10	10 / 5 / 3 / 2	250	31	4800	0.130	700	Orange
CS0603-11N□-S	11	10 / 5 / 3 / 2	250	33	4000	0.086	700	Gray
CS0603-12N□-S	12	10 / 5 / 3 / 2	250	35	4000	0.130	700	Yellow
CS0603-13N□-S	13	10 / 5 / 3 / 2	250	30	4000	0.160	700	Black
CS0603-15N□-S	15	10 / 5 / 3 / 2	250	35	4000	0.170	700	Green
CS0603-16N□-S	16	10 / 5 / 3 / 2	250	34	3300	0.104	700	White
CS0603-18N□-S	18	10 / 5 / 3 / 2	250	35	3100	0.170	700	Blue
CS0603-20N□-S	20	10 / 5 / 3 / 2	250	38	3000	0.190	700	Red
CS0603-22N□-S	22	10 / 5 / 3 / 2	250	38	3000	0.190	700	Violet
CS0603-23N□-S	23	10 / 5 / 3 / 2	250	38	2850	0.190	700	Orange
CS0603-24N□-S	24	10 / 5 / 3 / 2	250	37	2650	0.135	700	Black
CS0603-27N□-S	27	10 / 5 / 3 / 2	250	40	2800	0.220	600	Gray
CS0603-30N□-S	30	10 / 5 / 3 / 2	250	37	2250	0.144	600	Brown
CS0603-33N□-S	33	10 / 5 / 3 / 2	250	40	2300	0.220	600	White
CS0603-36N□-S	36	10 / 5 / 3 / 2	250	38	2080	0.250	600	Red
CS0603-39N□-S	39	10 / 5 / 3 / 2	250	40	2200	0.250	600	Black
CS0603-43N□-S	43	10 / 5 / 3 / 2	250	39	2000	0.280	600	Orange
CS0603-47N□-S	47	10 / 5 / 3 / 2	200	38	2000	0.280	600	Brown
CS0603-51N□-S	51	10 / 5 / 3 / 2	200	38	1900	0.310	600	Brown
CS0603-56N□-S	56	10 / 5 / 3 / 2	200	38	1900	0.310	600	Red
CS0603-68N□-S	68	10 / 5 / 3 / 2	200	37	1700	0.340	600	Orange
CS0603-72N□-S	72	10 / 5 / 3 / 2	150	34	1700	0.490	400	Yellow
CS0603-82N□-S	82	10 / 5 / 3 / 2	150	34	1700	0.540	400	Green
CS0603-91N□-S	91	10 / 5 / 3 / 2	150	34	1400	0.580	400	Black

Note: When ordering, please specify tolerance code. Tolerance : B=±0.1nH , G=±2% , H=±3% , J=±5% , K=±10%

- Operating temperature range - 40°C ~ 125°C(Including self - temperature rise)
- Irms for a 15°C temperature rise from 25°C ambient with current
- Measure Equipment :
L & Q : Agilent E4991A+Agilent HP16197A
SRF : Agilent HP8753D/Agilent E4991A
RDC : Chroma 16502
Irms : HP4284A+HP42841A/HP4285A+HP42841A

Please be sure to request approval specifications that provide further details of the products. Kindly note that the content of these specifications are subject to change or may be discontinued without advance notice. Please contact our sales department before ordering.



Electrical Characteristics

Part Number	Inductance (nH)	Tolerance (±%)	Test Frequency (MHz)	Q Min	SRF (MHz) Min	RDC (Ω) Max	Irms (mA) Max	Color
CS0603-R10□-S	100	10 / 5 / 3 / 2	150	34	1400	0.580	400	Blue
CS0603-R11□-S	110	10 / 5 / 3 / 2	150	32	1350	0.610	300	Violet
CS0603-R12□-S	120	10 / 5 / 3 / 2	150	32	1300	0.750	300	Gray
CS0603-R15□-S	150	10 / 5 / 3 / 2	150	28	990	0.920	280	White
CS0603-R16□-S	160	10 / 5 / 3 / 2	100	25	990	1.250	240	Yellow
CS0603-R18□-S	180	10 / 5 / 3 / 2	100	25	990	1.250	240	Black
CS0603-R20□-S	200	10 / 5 / 3 / 2	100	25	900	2.100	200	Red
CS0603-R21□-S	210	10 / 5 / 3 / 2	100	27	895	2.060	200	Gray
CS0603-R22□-S	220	10 / 5 / 3 / 2	100	25	900	2.100	200	Brown
CS0603-R24□-S	240	10 / 5 / 3 / 2	100	25	900	2.200	200	Green
CS0603-R25□-S	250	10 / 5 / 3 / 2	100	25	822	3.550	120	Violet
CS0603-R27□-S	270	10 / 5 / 3 / 2	100	24	900	2.800	170	Red
CS0603-R33□-S	330	10 / 5 / 3 / 2	100	25	900	3.890	100	Orange
CS0603-R39□-S	390	10 / 5 / 3 / 2	100	25	900	4.350	100	Yellow
CS0603-R47□-S	470	10 / 5 / 3 / 2	100	25	500	4.500	100	Brown
CS0603-R56□-S	560	10 / 5 / 3 / 2	100	23	460	4.700	90	Blue

Note: When ordering, please specify tolerance code. Tolerance : B=±0.1nH , G=±2% , H=±3% , J=±5% , K=±10%

- Operating temperature range - 40°C ~ 125°C(Including self - temperature rise)
- Irms for a 15°C temperature rise from 25°C ambient with current
- Measure Equipment :
 L & Q : Agilent E4991A+Agilent HP16197A
 SRF : Agilent HP8753D/Agilent E4991A
 RDC : Chroma 16502
 Irms : HP4284A+HP42841A/HP4285A+HP42841A

Typical L vs. Frequency

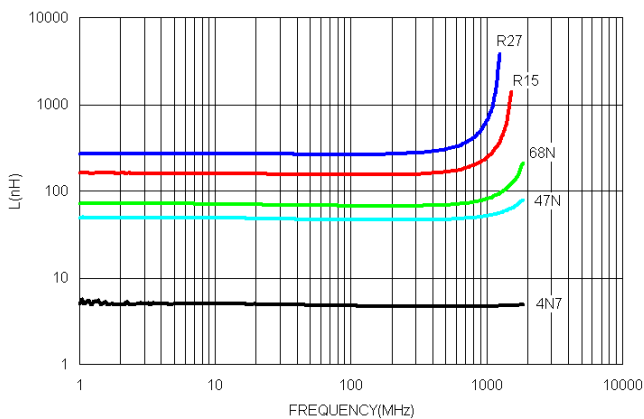

Typical Q vs. Frequency

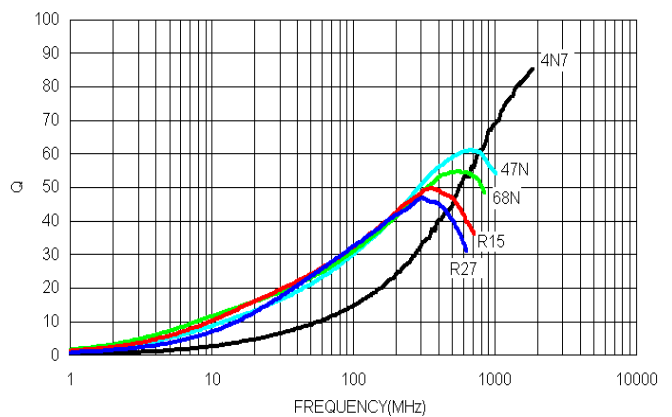

Please be sure to request approval specifications that provide further details of the products. Kindly note that the content of these specifications are subject to change or may be discontinued without advance notice. Please contact our sales department before ordering.

Electrical Characteristics

Part Number	Inductance (nH)	Tolerance (±%)	Test Frequency (MHz)	Q Min	Test Frequency (MHz)	SRF (MHz) Min	RDC (Ω) Max	Irms (mA) Max	Color
CS0805-2N7□-S	2.7	10 / 5 / 2	250	50	1500	7900	0.06	800	Yellow
CS0805-2N8□-S	2.8	10 / 5 / 2	250	80	1500	7900	0.06	800	Gray
CS0805-3N0□-S	3.0	10 / 5 / 2	250	65	1500	7900	0.06	800	White
CS0805-3N3□-S	3.3	10 / 5 / 2	250	50	1500	7900	0.08	600	Black
CS0805-5N6□-S	5.6	10 / 5 / 2	250	65	1000	5500	0.08	600	Orange
CS0805-6N8□-S	6.8	10 / 5 / 2	250	50	1000	5500	0.11	600	Brown
CS0805-7N5□-S	7.5	10 / 5 / 2	250	50	1000	4500	0.14	600	Green
CS0805-8N2□-S	8.2	10 / 5 / 2	250	50	1000	4700	0.12	600	Red
CS0805-10N□-S	10	10 / 5 / 2	250	60	500	4200	0.10	600	Blue
CS0805-12N□-S	12	10 / 5 / 2	250	50	500	4000	0.15	600	Orange
CS0805-15N□-S	15	10 / 5 / 2	250	50	500	3400	0.17	600	Yellow
CS0805-18N□-S	18	10 / 5 / 2	250	50	500	3300	0.20	600	Green
CS0805-22N□-S	22	10 / 5 / 2	250	55	500	2600	0.22	500	Blue
CS0805-24N□-S	24	10 / 5 / 2	250	50	500	2000	0.22	500	Gray
CS0805-27N□-S	27	10 / 5 / 2	250	55	500	2500	0.25	500	Violet
CS0805-33N□-S	33	10 / 5 / 2	250	60	500	2050	0.27	500	Gray
CS0805-36N□-S	36	10 / 5 / 2	250	55	500	1700	0.27	500	Orange
CS0805-39N□-S	39	10 / 5 / 2	250	60	500	2000	0.29	500	White
CS0805-43N□-S	43	10 / 5 / 2	200	60	500	1650	0.34	500	Yellow
CS0805-47N□-S	47	10 / 5 / 2	200	60	500	1650	0.31	500	Black
CS0805-56N□-S	56	10 / 5 / 2	200	60	500	1550	0.34	500	Brown
CS0805-68N□-S	68	10 / 5 / 2	200	60	500	1450	0.38	500	Red
CS0805-82N□-S	82	10 / 5 / 2	150	65	500	1300	0.42	400	Orange
CS0805-91N□-S	91	10 / 5 / 2	150	65	500	1200	0.48	400	Black
CS0805-R10□-S	100	10 / 5 / 2	150	65	500	1200	0.46	400	Yellow
CS0805-R11□-S	110	10 / 5 / 2	150	50	250	1000	0.48	400	Brown
CS0805-R12□-S	120	10 / 5 / 2	150	50	250	1100	0.51	400	Green
CS0805-R15□-S	150	10 / 5 / 2	100	50	250	920	0.56	400	Blue
CS0805-R18□-S	180	10 / 5 / 2	100	50	250	870	0.64	400	Violet
CS0805-R20□-S	200	10 / 5 / 2	100	50	250	860	0.68	400	Red
CS0805-R22□-S	220	10 / 5 / 2	100	50	250	850	0.70	400	Gray
CS0805-R24□-S	240	10 / 5 / 2	100	44	250	690	1.00	350	Red
CS0805-R25□-S	250	10 / 5 / 2	100	45	250	660	1.20	350	Yellow
CS0805-R27□-S	270	10 / 5 / 2	100	48	250	650	1.00	350	White
CS0805-R30□-S	300	10 / 5 / 2	100	25	250	450	1.40	310	Orange
CS0805-R33□-S	330	10 / 5 / 2	100	48	250	600	1.40	310	Black
CS0805-R39□-S	390	10 / 5 / 2	100	48	250	450	1.50	290	Brown
CS0805-R47□-S	470	10 / 5 / 2	50	33	100	375	1.76	250	Violet
CS0805-R51□-S	510	10 / 5 / 2	25	23	50	340	1.90	230	Gray
CS0805-R56□-S	560	10 / 5 / 2	25	23	50	340	1.90	230	Orange
CS0805-R62□-S	620	10 / 5 / 2	25	23	50	220	2.20	210	Yellow
CS0805-R68□-S	680	10 / 5 / 2	25	23	50	188	2.20	190	Green

Note: When ordering, please specify tolerance code. Tolerance : G=±2% , J=±5% , K=±10%

- Operating temperature range - 40°C ~ 125°C(Including self - temperature rise)
- I rms for a 15°C temperature rise from 25°C ambient with current
- Measure Equipment :
L & Q : Agilent E4991A+Agilent HP16197A
SRF : Agilent HP8753D/Agilent E4991A
RDC : Chroma 16502
I rms : HP4284A+HP42841A/HP4285A+HP42841A

Please be sure to request approval specifications that provide further details of the products. Kindly note that the content of these specifications are subject to change or may be discontinued without advance notice. Please contact our sales department before ordering.



Electrical Characteristics

Part Number	Inductance (nH)	Tolerance (±%)	Test Frequency (MHz)	Q Min	Test Frequency (MHz)	SRF (MHz) Min	RDC (Ω) Max	Irms (mA) Max	Color
CS0805-R82□-S	820	10 / 5 / 2	25	23	50	215	2.35	180	Blue
CS0805-1R0□-S	1000	10 / 5 / 2	25	20	50	100	2.50	170	Gray
CS0805-1R2□-S	1200	10 / 5	7.9	18	25	100	2.50	170	White
CS0805-1R8□-S	1800	10 / 5 / 2	7.9	16	7.9	80	2.50	170	Orange
CS0805-3R3□-S	3300	10 / 5 / 2	7.9	15	7.9	40	4.40	90	Red
CS0805-4R7□-S	4700	10 / 5 / 2	7.9	15	7.9	40	6.40	90	Yellow

Note: When ordering, please specify tolerance code. Tolerance : G=±2% , J=±5% , K=±10%

- Operating temperature range - 40°C ~ 125°C(Including self - temperature rise)
- Irms for a 15°C temperature rise from 25°C ambient with current
- Measure Equipment :
 L & Q : Agilent E4991A+Agilent HP16197A
 SRF : Agilent HP8753D/Agilent E4991A
 RDC : Chroma 16502
 Irms : HP4284A+HP42841A/HP4285A+HP42841A

Typical L vs. Frequency

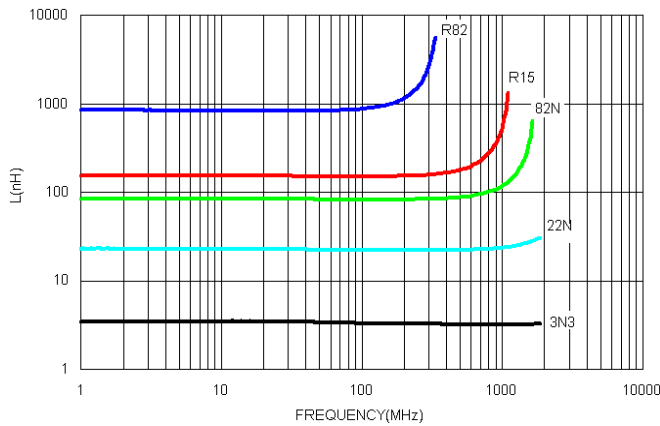

Typical Q vs. Frequency

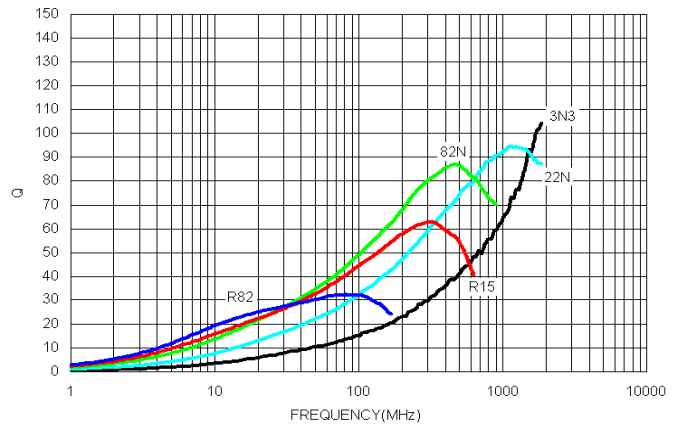

Please be sure to request approval specifications that provide further details of the products. Kindly note that the content of these specifications are subject to change or may be discontinued without advance notice. Please contact our sales department before ordering.

Electrical Characteristics

Part Number	Inductance (nH)	Tolerance (±%)	Test Frequency (MHz)	Q Min	Test Frequency (MHz)	SRF (MHz) Min	RDC (Ω) Max	Irms (mA) Max	Color Coding		
									1 ST	2 ND	3 RD
CS1008-10N□-S	10	10 / 5 / 2	50	50	500	4100	0.08	1000	Brown	Black	Black
CS1008-12N□-S	12	10 / 5 / 2	50	50	500	3300	0.09	1000	Brown	Red	Black
CS1008-15N□-S	15	10 / 5 / 2	50	50	500	2500	0.10	1000	Brown	Green	Black
CS1008-18N□-S	18	10 / 5 / 2	50	50	350	2500	0.11	1000	Brown	Gray	Black
CS1008-22N□-S	22	10 / 5 / 2	50	55	350	2400	0.12	1000	Red	Red	Black
CS1008-27N□-S	27	10 / 5 / 2	50	55	350	1600	0.13	1000	Red	Violet	Black
CS1008-33N□-S	33	10 / 5 / 2	50	60	350	1600	0.14	1000	Orange	Orange	Black
CS1008-39N□-S	39	10 / 5 / 2	50	60	350	1500	0.15	1000	Orange	White	Black
CS1008-47N□-S	47	10 / 5 / 2	50	65	350	1500	0.16	1000	Yellow	Violet	Black
CS1008-56N□-S	56	10 / 5 / 2	50	65	350	1300	0.18	1000	Green	Blue	Black
CS1008-68N□-S	68	10 / 5 / 2	50	65	350	1300	0.20	1000	Blue	Gray	Black
CS1008-82N□-S	82	10 / 5 / 2	50	60	350	1000	0.22	1000	Gray	Red	Black
CS1008-R10□-S	100	10 / 5 / 2	25	60	350	1000	0.56	650	Brown	Black	Brown
CS1008-R12□-S	120	10 / 5 / 2	25	60	350	950	0.63	650	Brown	Red	Brown
CS1008-R15□-S	150	10 / 5 / 2	25	45	100	850	0.70	580	Brown	Green	Brown
CS1008-R18□-S	180	10 / 5 / 2	25	45	100	750	0.77	620	Brown	Gray	Brown
CS1008-R20□-S	200	10 / 5 / 2	25	45	100	700	0.84	500	Red	Black	Brown
CS1008-R22□-S	220	10 / 5 / 2	25	45	100	700	0.84	500	Red	Red	Brown
CS1008-R27□-S	270	10 / 5 / 2	25	45	100	600	0.91	500	Red	Violet	Brown
CS1008-R33□-S	330	10 / 5 / 2	25	45	100	570	1.05	450	Orange	Orange	Brown
CS1008-R39□-S	390	10 / 5 / 2	25	45	100	500	1.12	470	Orange	White	Brown
CS1008-R47□-S	470	10 / 5 / 2	25	45	100	450	1.19	470	Yellow	Violet	Brown
CS1008-R56□-S	560	10 / 5 / 2	25	45	100	415	1.33	400	Green	Blue	Brown
CS1008-R62□-S	620	10 / 5 / 2	25	45	100	375	1.40	300	Blue	Red	Brown
CS1008-R68□-S	680	10 / 5 / 2	25	45	100	375	1.47	400	Blue	Gray	Brown
CS1008-R75□-S	750	10 / 5 / 2	25	45	100	360	1.54	360	Violet	Green	Brown
CS1008-R82□-S	820	10 / 5 / 2	25	45	100	350	1.61	400	Gray	Red	Brown
CS1008-R91□-S	910	10 / 5 / 2	25	35	50	320	1.68	380	White	Brown	Brown
CS1008-1R0□-S	1000	10 / 5 / 2	25	35	50	290	1.75	370	Brown	Black	Red
CS1008-1R2□-S	1200	10 / 5 / 2	7.9	35	50	250	2.0	310	Brown	Red	Red
CS1008-1R5□-S	1500	10 / 5 / 2	7.9	28	50	200	2.3	330	Brown	Green	Red
CS1008-1R8□-S	1800	10 / 5 / 2	7.9	28	50	160	2.6	300	Brown	Gray	Red
CS1008-2R2□-S	2200	10 / 5 / 2	7.9	28	50	160	2.8	280	Red	Red	Red
CS1008-2R7□-S	2700	10 / 5 / 2	7.9	22	25	140	3.2	290	Red	Violet	Red
CS1008-3R3□-S	3300	10 / 5 / 2	7.9	22	25	110	3.4	290	Orange	Orange	Red
CS1008-3R9□-S	3900	10 / 5 / 2	7.9	20	25	100	3.6	260	Orange	White	Red
CS1008-4R7□-S	4700	10 / 5 / 2	7.9	20	25	90	4.0	260	Yellow	Violet	Red
CS1008-5R6□-S	5600	10 / 5 / 2	7.9	18	7.9	45	4.0	240	Green	Blue	Red
CS1008-6R8□-S	6800	10 / 5 / 2	7.9	18	7.9	40	4.9	200	Blue	Gray	Red
CS1008-8R2□-S	8200	10 / 5 / 2	7.9	18	7.9	25	6.0	170	Gray	Red	Red
CS1008-100□-S	10000	10 / 5 / 2	2.52	18	7.9	25	8.0	150	Brown	Black	Orange
CS1008-150□-S	15000	10 / 5 / 2	2.52	15	7.9	20	11	100	Brown	Green	Orange

Note: When ordering, please specify tolerance code. Tolerance : G=±2% , J=±5% , K=±10%

- Operating temperature range - 40°C ~ 125°C(Including self - temperature rise)
- Irms for a 15°C temperature rise from 25°C ambient with current
- Measure Equipment :

L & Q : Agilent E4991A+Agilent HP16197A

SRF : Agilent HP8753D/Agilent E4991A

RDC : Chroma 16502

Irms : HP4284A+HP42841A/HP4285A+HP42841A

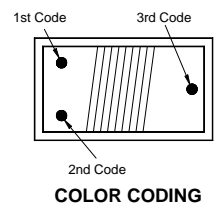

Please be sure to request approval specifications that provide further details of the products. Kindly note that the content of these specifications are subject to change or may be discontinued without advance notice. Please contact our sales department before ordering.

Typical **L** vs. **F** Frequency

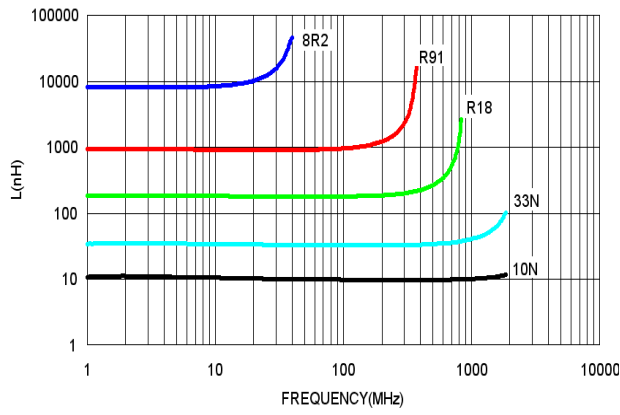

Typical **Q** vs. **F** Frequency

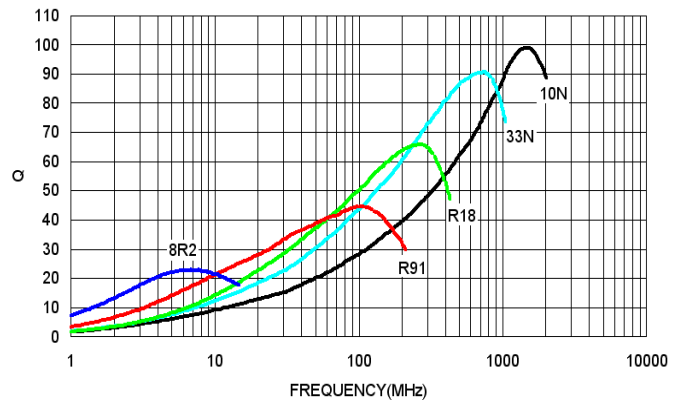

Please be sure to request approval specifications that provide further details of the products. Kindly note that the content of these specifications are subject to change or may be discontinued without advance notice. Please contact our sales department before ordering.

Packaging Specifications

Tape Dimensions

Figure 1

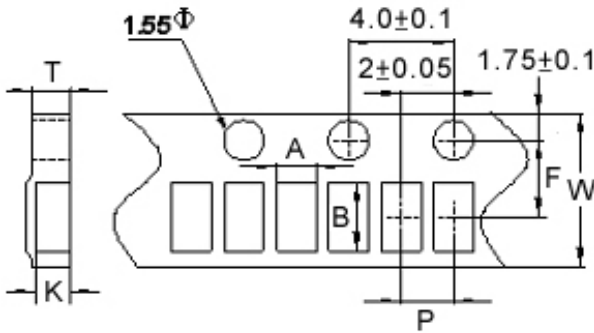

Figure 2

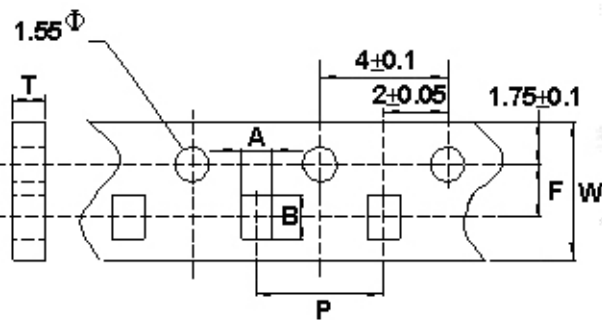
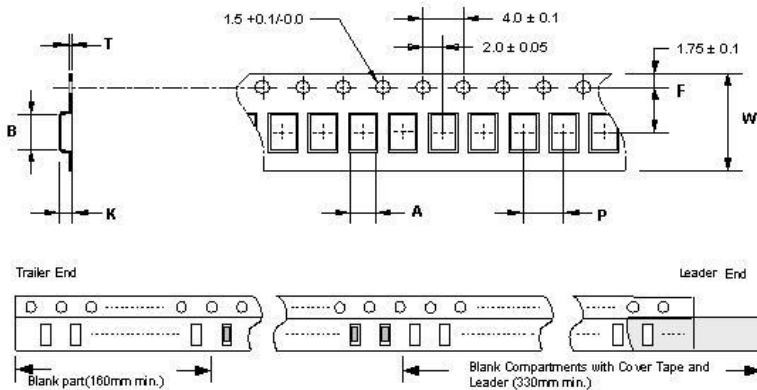
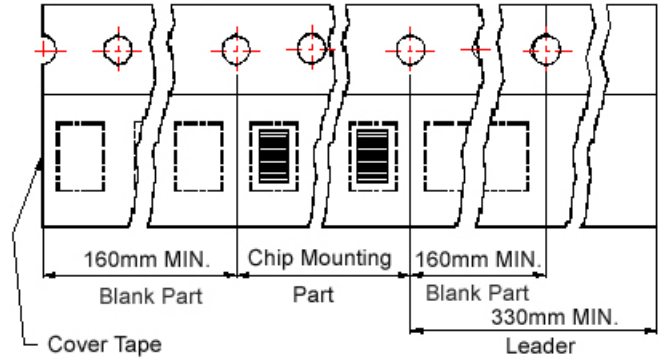

Figure 3



Tape Material

Carrier Tape: Paper
Cover Tape: Polystyrene



Carrier Tape: Paper
Cover Tape: Polystyrene

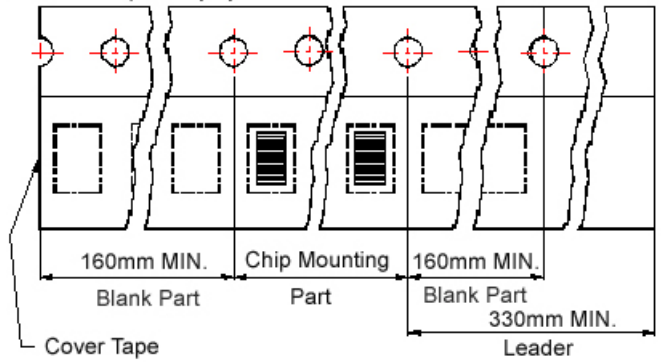

Reel Dimensions

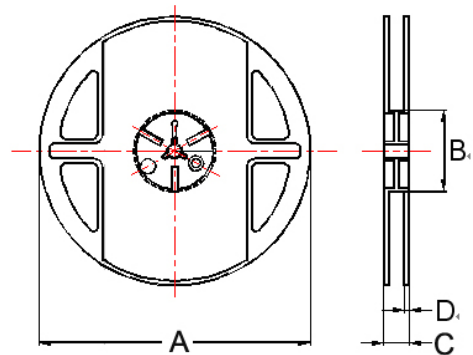

Dimensions in mm

TYPE	Fig.	Tape Dimensions							Reel Dimensions				Quantity PCS / Reel
		A	B	T	W	P	F	K	A	B	C	D	
CS0201	1	0.47	0.57	0.65	8	2	3.5	0.45	178	60	12	1.5	4000
CS0402	1	0.67	1.20	0.75	8	2	3.5	0.59	178	60	12	1.5	4000
CS0603	2	1.20	1.80	1.05	8	4	3.5	-	178	60	12	1.5	4000
CS0805	3	1.85	2.45	0.23	8	4	3.5	1.50	178	60	12	1.5	2000
CS1008	3	2.80	2.95	0.23	8	4	3.5	2.20	178	60	12	1.5	2000

PM Series



Due to accurate wire winding technology, these chip inductors are designed for filtering, impedance matching, resonance and choke circuits for RF designer. Both standard series custom designs are available.

Features

- RoHS Compliant and Halogen Free
- Ceramic body and wire wound construction provide high Q and SRFs
- Higher Q and lower DCR than other inductors
- Exceptional current handling capability
- PM series is for high power and high frequency application

Applications

- Wireless embedded portable devices
- GPS receiver
- Base Station
- Repeater
- Set Top Box
- Cable / IP Modem
- Security system and other RF modules

Product Identification

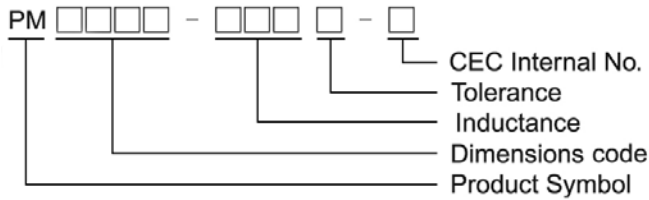

Shape and Dimensions / Recommended Pattern

PM0603

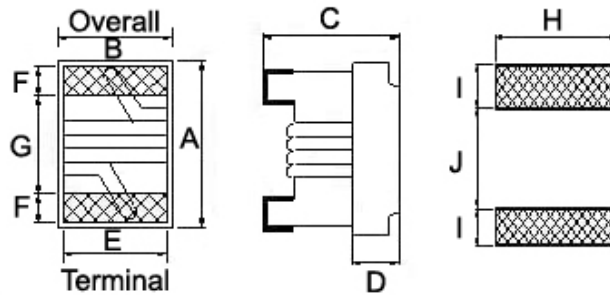

Dimensions

	A	B	C	D	E	F	G	H	I	J
PM0603	1.6 ^{+0.2} _{-0.1}	1.12 ± 0.1	0.82 ^{+0.2} _{-0.1}	0.30	0.95	0.30	0.70	1.02	0.64	0.64

Electrical Characteristics

Part Number	Inductance (nH)	Tolerance (±%)	Test Frequency (MHz)	Q Min	Test Frequency (MHz)	SRF (GHz) Min	RDC (Ω) Max	Irms (mA) Max	Color
PM0603-2N2□-N	2.2	±0.5nH	100	25	250	18	0.018	1400	Black
PM0603-3N9□-N	3.9	±0.2nH/±0.5nH	100	38	250	11	0.032	1000	Brown
PM0603-5N6□-N	5.6	±0.5nH	100	38	250	10	0.045	900	Red
PM0603-6N8□-N	6.8	±0.2nH/±0.5nH	100	38	250	7	0.045	900	Orange
PM0603-8N2□-N	8.2	±0.5nH	100	38	250	7	0.058	800	Yellow
PM0603-10N□-N	10	5 / 2	100	38	250	5	0.058	800	Green
PM0603-12N□-N	12	5 / 2	100	38	250	5	0.071	750	Blue
PM0603-15N□-N	15	5	100	42	250	4.5	0.085	700	Violet
PM0603-18N□-N	18	5 / 2	100	42	250	3.5	0.085	700	Gray
PM0603-22N□-N	22	5 / 2	100	42	250	3.3	0.099	640	White
PM0603-27N□-N	27	5 / 2	100	42	250	2.8	0.116	590	Black
PM0603-33N□-N	33	5	100	42	250	2.5	0.132	550	Brown

Note: When ordering, please specify tolerance code. Tolerance : C=±0.2nH , D=±0.5nH , G=±2% , J=±5%

- Operating temperature range - 40°C ~ 125°C(Including self - temperature rise)
- Irms for a 15°C temperature rise from 25°C ambient with current
- Measure Equipment :
 L & Q : Agilent E4991A+Agilent HP16197A
 SRF : Agilent HP8753D
 RDC : Chroma 16502
 Irms : HP4284A+HP42841A/HP4285A+HP42841A

Typical **L** vs. **F** Frequency

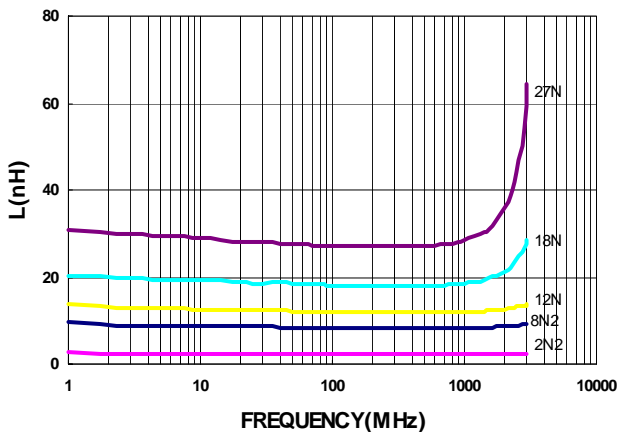

Typical **Q** vs. **F** Frequency

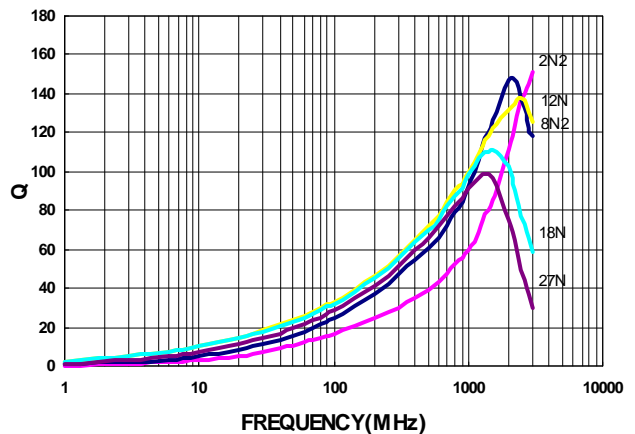

Please be sure to request approval specifications that provide further details of the products. Kindly note that the content of these specifications are subject to change or may be discontinued without advance notice. Please contact our sales department before ordering.

Packaging Specifications

Tape Dimensions

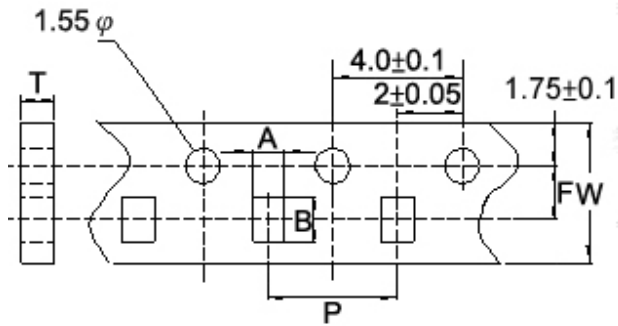

Tape Material



Reel Dimensions

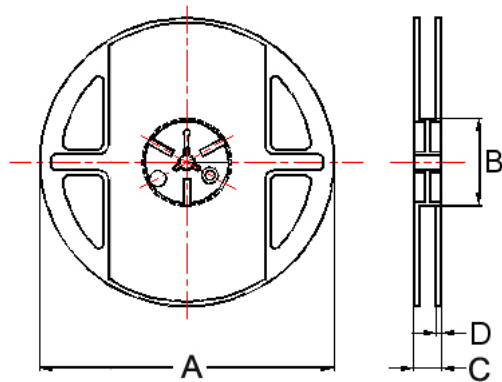

Dimensions in mm

TYPE	Tape Dimensions						Reel Dimensions				Quantity PCS / Reel
	A	B	T	W	P	F	A	B	C	D	
PM0603	1.23	1.90	1.05	8	4	3.5	178	60	12	1.5	4000

HP Series



Due to accurate wire winding technology, these chip inductors are designed for filtering, impedance matching, resonance and choke circuits for RF designer. Both standard series custom designs are available.

Features

- RoHS Compliant and Halogen Free
- Ceramic body and wire wound construction provide high Q and SRFs
- Higher Q and lower DCR than other inductors
- Exceptional current handling capability
- HP series is for high power and high frequency application

Applications

- Wireless embedded portable devices
- GPS receiver
- Base Station
- Repeater
- Set Top Box
- Cable / IP Modem
- Security system and other RF modules

Product Identification

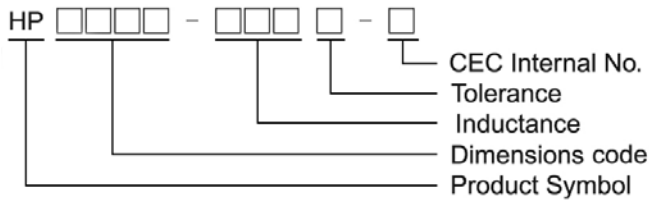

Shape and Dimensions / Recommended Pattern

HP0402

HP0603

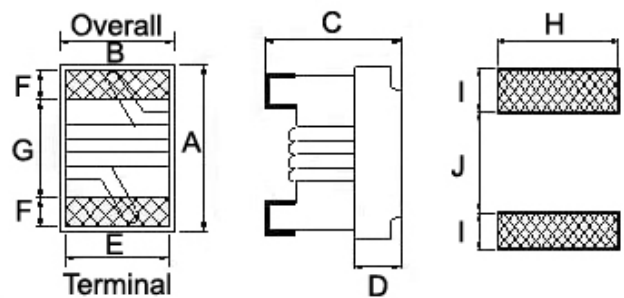
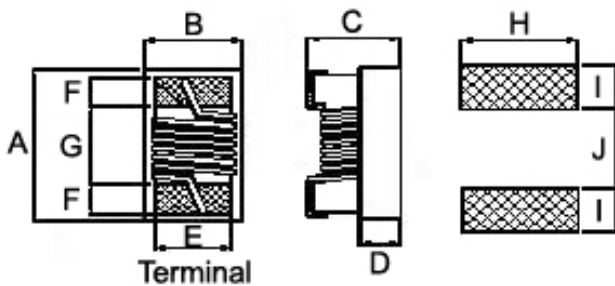

Dimensions

	A	B	C	D	E	F	G	H	I	J
HP0402	1.1 ± 0.05	0.70 ± 0.05	0.6 ± 0.05	0.25	0.45	0.20	0.54	0.66	0.36	0.51
HP0603	1.6 ^{+0.2} _{-0.1}	1.00 ± 0.1	0.82 ^{+0.2} _{-0.1}	0.30	0.70	0.30	0.95	1.02	0.64	0.64

Electrical Characteristics

Part Number	Inductance (nH)	Tolerance (±%)	Test Frequency (MHz)	Q Typ.	Test Frequency (MHz)	SRF (GHz) Typ.	RDC (Ω) Max	Irms (mA) Max
HP0402-1N0□-N	1.0	±0.1nH	250	18	250	16.0	0.030	2300
HP0402-2N0□-N	2.0	±0.2nH	250	18	250	15.2	0.038	2100
HP0402-2N2□-N	2.2	±0.2nH	250	25	250	15.1	0.045	2100
HP0402-2N4□-N	2.4	±0.2nH	250	25	250	14.0	0.045	2000
HP0402-2N7□-N	2.7	±0.2nH	250	20	250	13.0	0.090	1500
HP0402-3N3□-N	3.3	3 / 5	250	20	250	12.8	0.050	1700
HP0402-3N6□-N	3.6	3 / 5	250	28	250	11.7	0.065	1700
HP0402-3N9□-N	3.9	3 / 5	250	28	250	9.50	0.065	1700
HP0402-4N3□-N	4.3	3 / 5	250	22	250	7.15	0.060	1600
HP0402-4N7□-N	4.7	3 / 5	250	18	250	6.85	0.115	1500
HP0402-5N1□-N	5.1	3 / 5	250	20	250	6.80	0.125	1200
HP0402-5N6□-N	5.6	3 / 5	250	28	250	6.80	0.070	1600
HP0402-6N2□-N	6.2	3 / 5	250	25	250	5.80	0.070	1600
HP0402-6N8□-N	6.8	3 / 5	250	25	250	5.80	0.095	1500
HP0402-7N5□-N	7.5	3 / 5	250	25	250	5.40	0.130	1400
HP0402-8N2□-N	8.2	3 / 5	250	30	250	5.40	0.080	1500
HP0402-8N7□-N	8.7	3 / 5	250	30	250	5.00	0.085	1500
HP0402-9N0□-N	9.0	3 / 5	250	28	250	5.00	0.090	1400
HP0402-9N5□-N	9.5	3 / 5	250	30	250	4.70	0.095	1400
HP0402-10N□-N	10	3 / 5	250	30	250	4.70	0.120	1300
HP0402-11N□-N	11	3 / 5	250	30	250	4.70	0.095	1400
HP0402-12N□-N	12	3 / 5	250	25	250	4.40	0.110	1200
HP0402-13N□-N	13	3 / 5	250	30	250	4.20	0.140	870
HP0402-15N□-N	15	3 / 5	250	30	250	3.90	0.130	1100
HP0402-16N□-N	16	3 / 5	250	30	250	3.70	0.150	850
HP0402-18N□-N	18	3 / 5	250	30	250	3.55	0.160	900
HP0402-19N□-N	19	3 / 5	250	30	250	3.50	0.175	850
HP0402-20N□-N	20	3 / 5	250	30	250	3.50	0.220	780
HP0402-21N□-N	21	3 / 5	250	30	250	1.70	0.360	450
HP0402-22N□-N	22	3 / 5	250	30	250	3.30	0.210	800
HP0402-23N□-N	23	3 / 5	250	30	250	3.15	0.210	700
HP0402-24N□-N	24	3 / 5	250	30	250	3.15	0.260	700
HP0402-25N□-N	25	3 / 5	250	30	250	3.15	0.310	700
HP0402-26N□-N	26	3 / 5	250	30	250	3.15	0.275	700
HP0402-27N□-N	27	3 / 5	250	30	250	3.20	0.300	450
HP0402-30N□-N	30	3 / 5	250	30	250	2.90	0.350	450
HP0402-33N□-N	33	3 / 5	250	30	250	2.80	0.380	490
HP0402-36N□-N	36	3 / 5	250	30	250	2.80	0.480	480
HP0402-37N□-N	37	3 / 5	250	30	250	2.70	0.490	470
HP0402-39N□-N	39	3 / 5	250	30	250	2.60	0.520	450
HP0402-40N□-N	40	3 / 5	250	30	250	2.60	0.520	450
HP0402-43N□-N	43	3 / 5	250	29	250	2.50	0.720	450
HP0402-47N□-N	47	3 / 5	250	30	250	2.40	0.720	420
HP0402-51N□-N	51	3 / 5	250	30	250	2.30	0.980	360

Note: When ordering, please specify tolerance code. Tolerance : B=±0.1nH , C=±0.2nH , H=±3% , J=±5%

- Operating temperature range - 40°C ~ 125°C(Including self - temperature rise)
- I rms for a 15°C temperature rise from 25°C ambient with current
- Measure Equipment :
L & Q : Agilent E4991A+Agilent HP16197A
SRF : Agilent HP8753D/Agilent HP8722ES
RDC : Chroma 16502
I rms : HP4284A+HP42841A/HP4285A+HP42841A

Please be sure to request approval specifications that provide further details of the products. Kindly note that the content of these specifications are subject to change or may be discontinued without advance notice. Please contact our sales department before ordering.

Electrical Characteristics

Part Number	Inductance (nH)	Tolerance (±%)	Test Frequency (MHz)	Q Typ.	Test Frequency (MHz)	SRF (GHz) Typ.	RDC (Ω) Max	Irms (mA) Max	Color
HP0603-1N8□-N	1.8	5	250	23	250	16.0	0.033	2100	Black
HP0603-2N2□-N	2.2	5	250	13	250	15.0	0.182	900	Brown
HP0603-3N9□-N	3.9	5	250	26	250	7.50	0.062	1600	Red
HP0603-4N3□-N	4.3	3 / 5	250	26	250	7.50	0.088	1300	Orange
HP0603-4N7□-N	4.7	3 / 5	250	25	250	7.90	0.130	1100	Yellow
HP0603-6N8□-N	6.8	3 / 5	250	40	250	5.80	0.065	1400	Green
HP0603-7N2□-N	7.2	3 / 5	250	32	250	5.40	0.100	1400	Blue
HP0603-7N5□-N	7.5	3 / 5	250	32	250	5.30	0.100	1300	Violet
HP0603-11N□-N	11	3 / 5	250	41	250	4.10	0.086	1400	Gray
HP0603-15N□-N	15	3 / 5	250	42	250	3.60	0.110	1200	White
HP0603-16N□-N	16	3 / 5	250	40	250	3.50	0.125	1100	Black
HP0603-22N□-N	22	3 / 5	250	40	250	3.15	0.195	850	Brown
HP0603-23N□-N	23	3 / 5	250	40	250	3.00	0.150	850	Red
HP0603-24N□-N	24	3 / 5	250	42	250	2.95	0.125	1100	Orange
HP0603-27N□-N	27	3 / 5	250	42	250	2.80	0.200	780	Yellow
HP0603-30N□-N	30	3 / 5	250	49	250	2.80	0.130	920	Green
HP0603-33N□-N	33	3 / 5	250	45	250	2.70	0.170	680	Blue
HP0603-36N□-N	36	3 / 5	250	44	250	2.50	0.225	720	Violet
HP0603-39N□-N	39	3 / 5	250	48	250	2.45	0.190	680	Gray
HP0603-43N□-N	43	3 / 5	250	45	250	2.45	0.225	810	White
HP0603-47N□-N	47	3 / 5	200	43	250	2.30	0.240	680	Black
HP0603-51N□-N	51	3 / 5	200	42	250	2.30	0.280	660	Brown
HP0603-56N□-N	56	3 / 5	200	43	250	2.20	0.300	610	Red
HP0603-68N□-N	68	3 / 5	200	43	250	2.00	0.330	600	Orange
HP0603-72N□-N	72	3 / 5	150	37	250	1.90	0.420	550	Yellow
HP0603-75N□-N	75	3 / 5	150	37	250	1.90	0.520	500	Green
HP0603-82N□-N	82	3 / 5	150	38	250	1.80	0.460	510	Blue
HP0603-91N□-N	91	3 / 5	150	45	250	1.65	0.580	440	Violet
HP0603-R10□-N	100	3 / 5	150	49	250	1.70	0.540	470	Gray
HP0603-R11□-N	110	3 / 5	150	47	250	1.60	0.620	440	White
HP0603-R12□-N	120	3 / 5	150	47	250	1.55	0.720	420	Black
HP0603-R15□-N	150	3 / 5	150	47	250	1.35	1.150	390	Brown
HP0603-R18□-N	180	3 / 5	100	48	250	1.30	1.500	310	Red
HP0603-R20□-N	200	3 / 5	100	47	250	1.25	2.000	280	Orange
HP0603-R21□-N	210	3 / 5	100	48	250	1.20	2.000	280	Yellow
HP0603-R22□-N	220	3 / 5	100	47	250	1.10	2.000	280	Green
HP0603-R25□-N	250	3 / 5	100	45	250	1.05	3.000	240	Blue
HP0603-R27□-N	270	3 / 5	100	46	250	1.05	2.250	260	Violet
HP0603-R30□-N	300	3 / 5	100	47	250	0.99	2.800	220	Gray
HP0603-R33□-N	330	3 / 5	100	46	250	0.93	3.600	180	White
HP0603-R36□-N	360	3 / 5	100	47	250	0.93	4.000	170	Black
HP0603-R39□-N	390	3 / 5	100	47	250	0.88	4.000	170	Brown

Note: When ordering, please specify tolerance code. Tolerance : H=±3% , J=±5%

- Operating temperature range - 40°C ~ 125°C(Including self - temperature rise)
- Irms for a 15°C temperature rise from 25°C ambient with current
- Measure Equipment :
L & Q : Agilent E4991A+Agilent HP16197A
SRF : Agilent HP8753D/Agilent HP8722ES
RDC : Chroma 16502
Irms : HP4284A+HP42841A/HP4285A+HP42841A

Please be sure to request approval specifications that provide further details of the products. Kindly note that the content of these specifications are subject to change or may be discontinued without advance notice. Please contact our sales department before ordering.



Test Instruments : Agilent E4991A Material/Impedance Analyzer

HP0402

Typical **L** vs. **F** Frequency

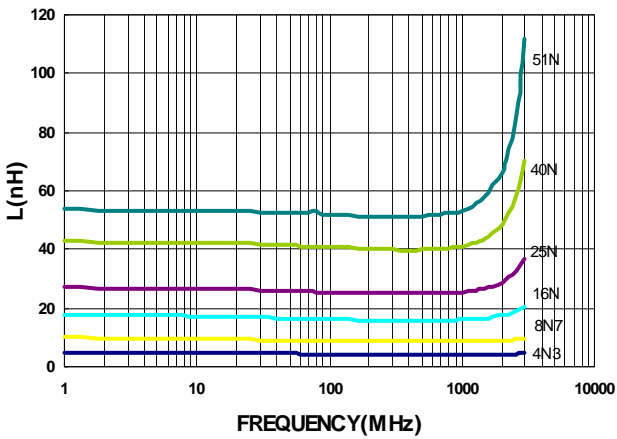

Typical **Q** vs. **F** Frequency

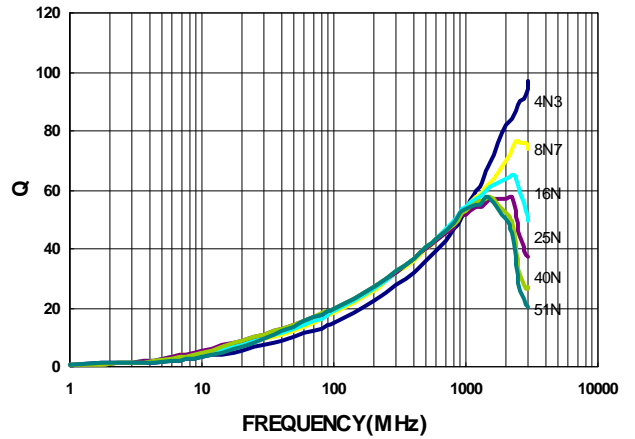

HP0603

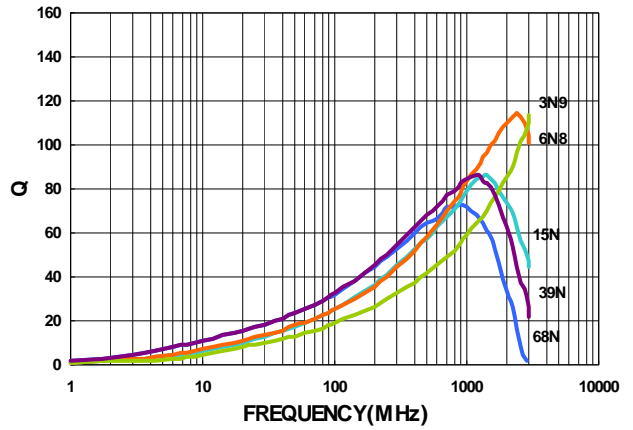
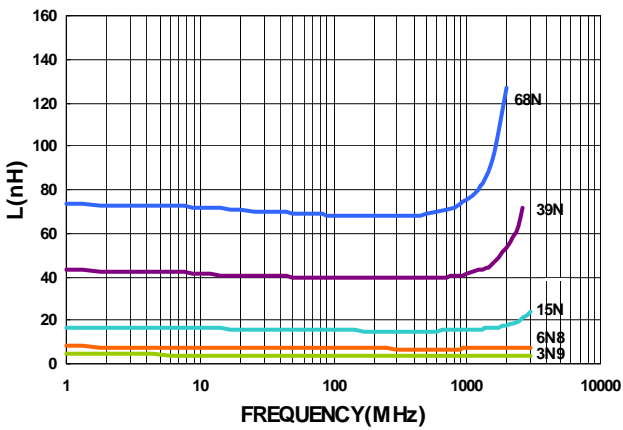

Please be sure to request approval specifications that provide further details of the products. Kindly note that the content of these specifications are subject to change or may be discontinued without advance notice. Please contact our sales department before ordering.

Packaging Specifications

Tape Dimensions

Figure 1

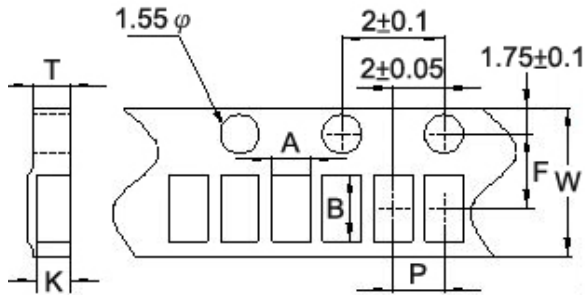

Tape Material



Figure 2

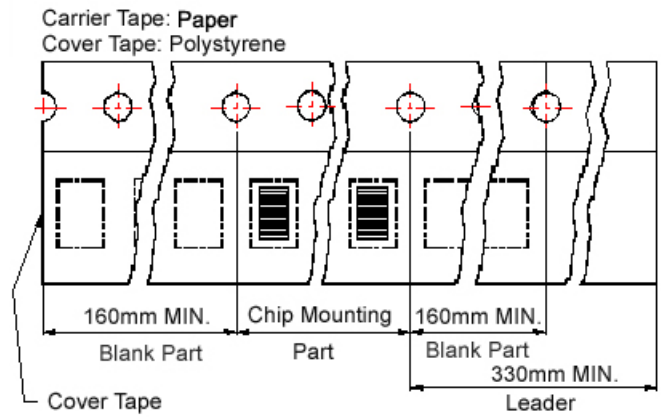
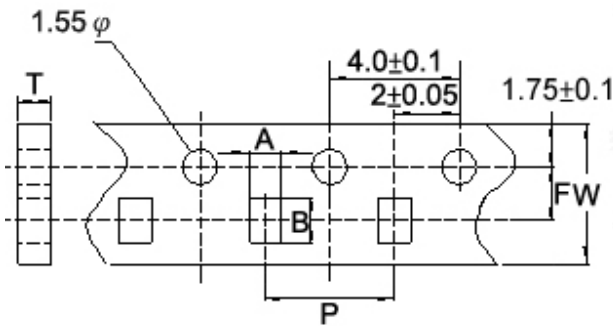

Reel Dimensions

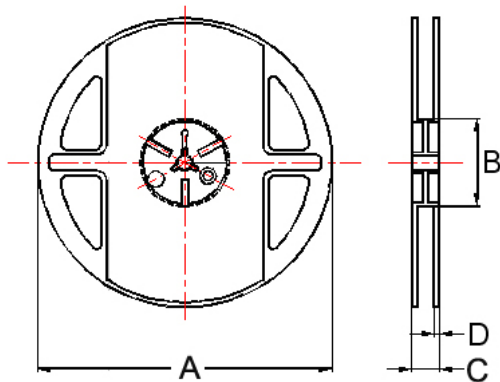

Dimensions in mm

TYPE	Fig.	Tape Dimensions							Reel Dimensions				Quantity PCS / Reel
		A	B	T	W	P	F	K	A	B	C	D	
HP0402	1	0.80	1.20	0.75	8	2	3.5	0.62	178	60	12	1.5	4000
HP0603	2	1.23	1.90	1.05	8	4	3.5	-	178	60	12	1.5	4000

HPH Series



Due to accurate wire winding technology, these chip inductors are designed for filtering, impedance matching, resonance and choke circuits for RF designer. Both standard series custom designs are available.

Features

- RoHS Compliant and Halogen Free
- Ceramic body and wire wound construction provide high Q and SRFs
- Higher Q and lower DCR than other inductors
- Exceptional current handling capability
- HPH series is for high power and high frequency application

Applications

- Wireless embedded portable devices
- GPS receiver
- Base Station
- Repeater
- Set Top Box
- Cable / IP Modem
- Security system and other RF modules

Product Identification

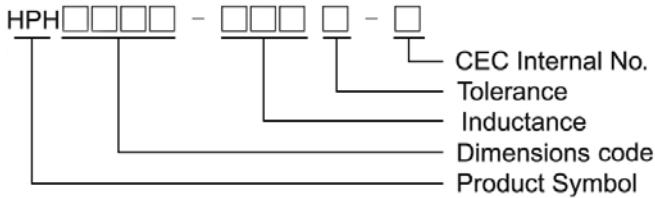

Shape and Dimensions / Recommended Pattern

HPH0603

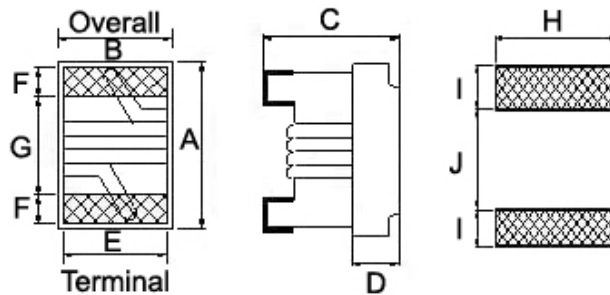

Dimensions

	A	B	C	D	E	F	G	H	I	J
HPH0603	1.6 ^{+0.2} _{-0.1}	1.12 ± 0.1	0.82 ^{+0.2} _{-0.1}	0.30	0.70	0.30	0.95	1.02	0.64	0.64

Electrical Characteristics

Part Number	Inductance (nH)	Tolerance (±%)	Test Frequency (MHz)	Q Typ.	Test Frequency (MHz)	SRF (GHz) Typ.	RDC (Ω) Max	Irms (mA) Max	Color Code
HPH0603-3N3□-N	3.3	5 / 3	250	36	250	9.6	0.034	1900	Black
HPH0603-3N6□-N	3.6	5 / 3	250	28	250	9.7	0.040	1900	Brown
HPH0603-5N1□-N	5.1	5 / 3	250	38	250	8.9	0.042	1700	Red
HPH0603-5N6□-N	5.6	5 / 3	250	35	250	6.6	0.042	1700	Orange
HPH0603-6N0□-N	6.0	5 / 3	250	49	250	6.0	0.042	1700	Yellow
HPH0603-8N2□-N	8.2	5 / 3	250	40	250	5.9	0.054	1400	Green
HPH0603-8N7□-N	8.7	5 / 3	250	46	250	5.5	0.054	1400	Blue
HPH0603-9N1□-N	9.1	5 / 3	250	40	250	5.1	0.052	1400	Violet
HPH0603-9N5□-N	9.5	5 / 3	250	42	250	4.9	0.054	1400	Gray
HPH0603-10N□-N	10	5 / 3	250	44	250	4.3	0.054	1400	White
HPH0603-12N□-N	12	5 / 3	250	40	250	4.1	0.088	1100	Black
HPH0603-18N□-N	18	5 / 3	250	45	250	3.3	0.082	1200	Brown

Note: When ordering, please specify tolerance code. Tolerance : H=±3% , J=±5%

- Operating temperature range - 40°C ~ 125°C(Including self - temperature rise)
- Irms for a 15°C temperature rise from 25°C ambient with current
- Measure Equipment :
 L & Q : Agilent E4991A+Agilent HP16197A
 SRF : Agilent E5071C
 RDC : Chroma 16502
 Irms : HP4284A+HP42841A/HP4285A+HP42841A

Typical **L** vs. **F**requency

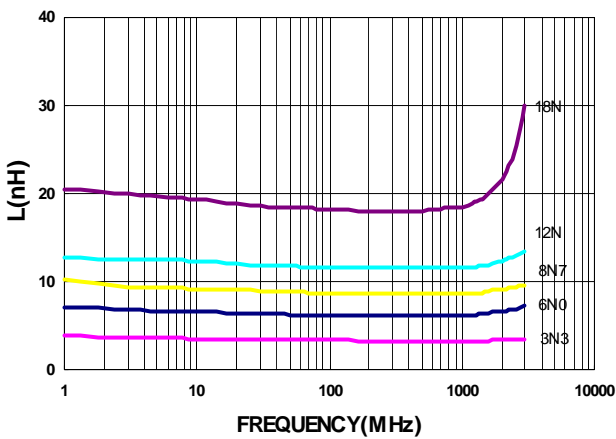

Typical **Q** vs. **F**requency

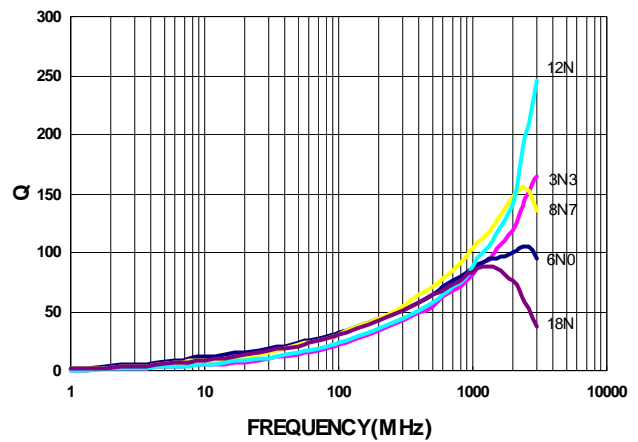

Please be sure to request approval specifications that provide further details of the products. Kindly note that the content of these specifications are subject to change or may be discontinued without advance notice. Please contact our sales department before ordering.

Packaging Specifications

Tape Dimensions

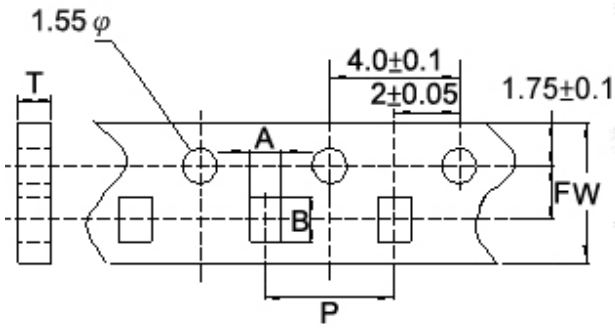

Tape Material



Reel Dimensions



Dimensions in mm

TYPE	Tape Dimensions						Reel Dimensions				Quantity
	A	B	T	W	P	F	A	B	C	D	PCS / Reel
HPH0603	1.23	1.90	1.05	8	4	3.5	178	60	12	1.5	4000

CT Series



Due to accurate wire winding technology, these chip inductors are designed for filtering, impedance matching, resonance and choke circuits for RF designer. Both standard series custom designs are available.

Features

- RoHS compliant.
- Ceramic body and wire wound construction provide highest SRFs
- Exceptional Q values even at high frequencies
- Highest possible SRFs as well as excellent Q values
- The non-magnetic coil form assures utmost thermal stability, predictability and batch consistency

Applications

- RF products for cellular phone
- GPS receiver
- Base Station
- Repeater
- Wireless LAN/ mouse/ keyboard/ earphone
- Remote control
- Security system and other RF modules

Product Identification

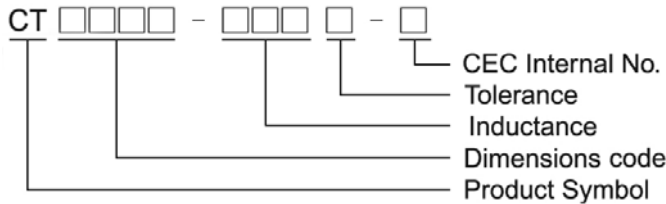

Shape and Dimensions/ Recommended Pattern

CT0603

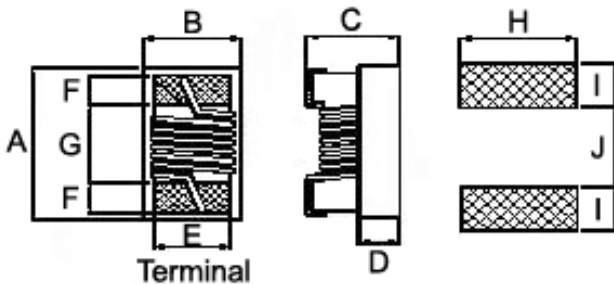

CT0805

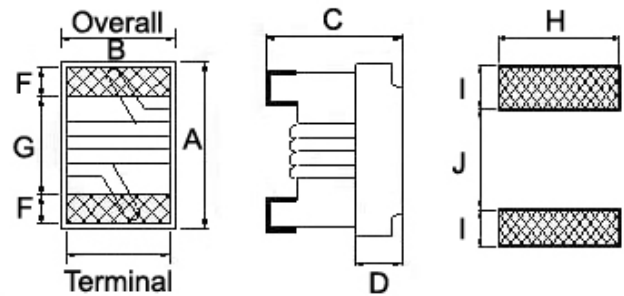

Dimensions

		A	B	C	D	E	F	G	H	I	J
CT0603	mm	1.6 ^{+0.2} _{-0.1}	0.9±0.1	0.55±0.05	0.25	0.76	0.30	0.92	1.02	0.64	0.64

		A Max	B Max	C Max	D	E	F	G	H	I	J
CT0805	inch	0.093	0.068	0.039	0.020	0.050	0.020	0.040	0.070	0.040	0.030
	mm	2.35	1.73	1.10	0.51	1.27	0.51	1.02	1.78	1.02	0.76

Electrical Characteristics

Part Number	Inductance (nH)	Tolerance (±%)	Test Frequency (MHz)	Q Min	Test Frequency (MHz)	SRF (MHz) Min	RDC (Ω) Max	Irms (mA) Max
CT0603-1N0□-N	1.0	10	250	13	250	16000	0.045	1600
CT0603-1N2□-N	1.2	10	250	12	250	16000	0.105	1100
CT0603-2N0□-N	2.0	5,10	250	21	250	12000	0.034	1900
CT0603-2N2□-N	2.2	5,10	250	21	250	10700	0.046	1600
CT0603-2N3□-N	2.3	5,10	250	25	250	11000	0.046	1600
CT0603-2N5□-N	2.5	5,10	250	20	250	11000	0.060	1300
CT0603-3N0□-N	3	5,10	250	25	250	10700	0.039	1600
CT0603-3N3□-N	3.3	3,5	250	26	250	7000	0.039	1600
CT0603-3N6□-N	3.6	3,5	250	28	250	7000	0.044	1600
CT0603-3N9□-N	3.9	3,5	250	26	250	6300	0.050	1400
CT0603-4N3□-N	4.3	3,5	250	22	250	6300	0.076	1300
CT0603-4N7□-N	4.7	3,5	250	22	250	5600	0.120	960
CT0603-5N1□-N	5.1	3,5	250	24	250	5500	0.050	1400
CT0603-5N6□-N	5.6	3,5	250	27	250	5050	0.058	1300
CT0603-6N8□-N	6.8	3,5	250	24	250	4500	0.080	1200
CT0603-7N2□-N	7.2	3,5	250	29	250	4500	0.047	1500
CT0603-8N2□-N	8.2	3,5	250	27	250	4250	0.075	1300
CT0603-9N5□-N	9.5	3,5	250	27	250	3950	0.092	1100
CT0603-10N□-N	10	2,5	250	27	250	3950	0.075	1300
CT0603-11N□-N	11	2,5	250	26	250	4000	0.110	1000
CT0603-12N□-N	12	2,5	250	28	250	3500	0.130	920
CT0603-15N□-N	15	2,5	250	26	250	3300	0.145	800
CT0603-16N□-N	16	2,5	250	26	250	3100	0.175	760
CT0603-18N□-N	18	2,5	250	26	250	2950	0.200	720
CT0603-20N□-N	20	2,5	250	28	250	2900	0.175	760
CT0603-22N□-N	22	2,5	250	28	250	2750	0.220	700
CT0603-24N□-N	24	2,5	250	29	250	2700	0.240	680
CT0603-27N□-N	27	2,5	250	27	250	2550	0.270	670
CT0603-30N□-N	30	2,5	250	27	250	2450	0.330	600
CT0603-33N□-N	33	2,5	250	27	250	2200	0.330	600
CT0603-36N□-N	36	2,5	250	28	250	2300	0.335	600
CT0603-39N□-N	39	2,5	250	28	250	2250	0.400	570
CT0603-43N□-N	43	2,5	250	27	250	2100	0.440	530
CT0603-47N□-N	47	2,5	250	27	250	1900	0.540	470
CT0603-51N□-N	51	2,5	250	26	250	1850	0.570	440
CT0603-56N□-N	56	2,5	250	26	250	1750	0.700	420

Note: When ordering, please specify tolerance code. Tolerance : G=±2% , H=±3% , J=±5% , K=±10%

- Operating temperature range - 40°C ~ 125°C(Including self - temperature rise)
- I rms for a 15°C temperature rise from 25°C ambient with current
- Measure Equipment :
L & Q : Agilent E4991A+Agilent HP16197A
SRF : Agilent/HP8753D/Agilent E4991A
RDC: HP4338B or Chroma 16502
I rms : HP4284A+HP42841A/HP4285A+HP42841A

Please be sure to request approval specifications that provide further details of the products. Kindly note that the content of these specifications are subject to change or may be discontinued without advance notice. Please contact our sales department before ordering.

Electrical Characteristics

Part Number	Inductance (nH)	Tolerance (±%)	Test Frequency (MHz)	Q Min	Test Frequency (MHz)	SRF (MHz) Min	RDC (Ω) Max	Irms (mA) Max	Color
CT0805-1N8□-S	1.8	10	250	55	1500	9400	0.03	800	Black
CT0805-3N9□-S	3.9	10	250	50	1000	6100	0.06	800	Brown
CT0805-4N7□-S	4.7	10 / 5	250	50	1000	5500	0.06	800	Red
CT0805-6N8□-S	6.8	10 / 5	250	50	1000	5500	0.08	800	Orange
CT0805-8N2□-S	8.2	10 / 5	250	50	1000	4800	0.08	800	Yellow
CT0805-10N□-S	10	10 / 5 / 2	250	55	750	3300	0.08	800	Green
CT0805-12N□-S	12	10 / 5 / 2	250	55	750	3800	0.10	800	Blue
CT0805-15N□-S	15	10 / 5 / 2	250	50	500	2950	0.10	800	Violet
CT0805-18N□-S	18	10 / 5 / 2	250	50	500	3100	0.13	800	Gray
CT0805-22N□-S	22	10 / 5 / 2	250	50	500	2900	0.15	800	White
CT0805-27N□-S	27	10 / 5 / 2	250	50	500	2450	0.23	600	Black
CT0805-33N□-S	33	10 / 5 / 2	250	55	500	2350	0.28	600	Brown
CT0805-39N□-S	39	10 / 5 / 2	250	55	500	2200	0.33	600	Red
CT0805-47N□-S	47	10 / 5 / 2	200	50	500	2000	0.39	600	Orange
CT0805-56N□-S	56	10 / 5 / 2	200	50	500	1850	0.39	500	Yellow
CT0805-68N□-S	68	10 / 5 / 2	200	50	500	1500	0.40	500	Green
CT0805-82N□-S	82	10 / 5 / 2	150	50	500	1500	0.44	500	Blue
CT0805-R10□-S	100	10 / 5 / 2	150	50	500	1200	0.64	400	Violet
CT0805-R12□-S	120	10 / 5 / 2	150	40	250	1150	0.68	300	Gray
CT0805-R15□-S	150	10 / 5 / 2	150	40	250	1050	0.80	300	White
CT0805-R18□-S	180	10 / 5 / 2	150	40	250	950	0.90	300	Black
CT0805-R22□-S	220	10 / 5 / 2	150	40	250	900	0.98	300	Brown
CT0805-R27□-S	270	10 / 5 / 2	150	40	250	850	1.30	300	Red
CT0805-R33□-S	330	10 / 5 / 2	100	40	250	800	1.45	300	Orange
CT0805-R39□-S	390	10 / 5 / 2	100	35	250	700	1.60	300	Yellow
CT0805-R47□-S	470	10 / 5 / 2	50	25	100	600	1.80	300	Green
CT0805-R56□-S	560	10 / 5 / 2	25	18	50	550	1.90	300	Blue
CT0805-R62□-S	620	10 / 5 / 2	25	18	50	450	2.00	300	Violet
CT0805-R68□-S	680	10 / 5 / 2	25	18	50	420	2.10	300	Gray
CT0805-R75□-S	750	10 / 5 / 2	25	18	50	400	2.20	300	White
CT0805-R82□-S	820	10 / 5 / 2	25	18	50	400	2.50	300	Black
CT0805-1R0□-S	1000	10 / 5	25	17	50	330	3.10	300	Brown

Note: When ordering, please specify tolerance code. Tolerance : G=±2% , J=±5% , K=±10%

- Operating temperature range - 40°C ~ 125°C(Including self - temperature rise)
- Irms for a 15°C temperature rise from 25°C ambient with current
- Measure Equipment :

L & Q : Agilent E4991A+Agilent HP16197A

SRF : Agilent/HP8753D/Agilent E4991A

RDC: HP4338B or Chroma 16502

Irms : HP4284A+HP42841A/HP4285A+HP42841A

SMD Wire Wound Ceramic Chip Inductors – CT Series

Test Instruments : Agilent E4991A Material/Impedance Analyzer

CT0603

Typical **L** vs. **F** Frequency

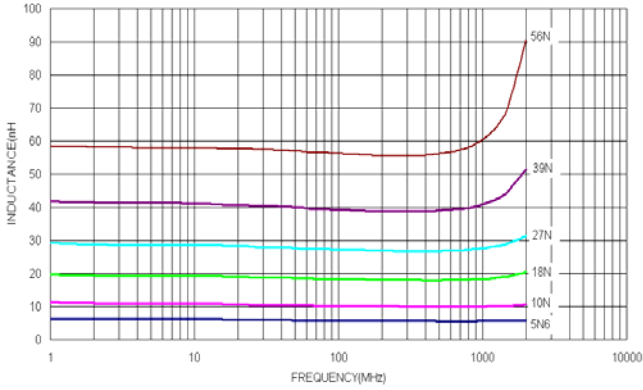

Typical **Q** vs. **F** Frequency

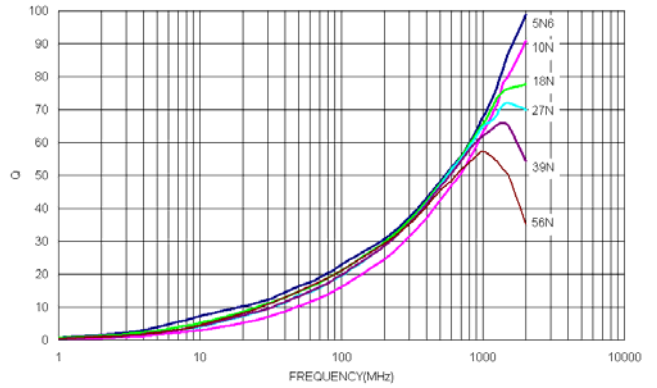

CT0805

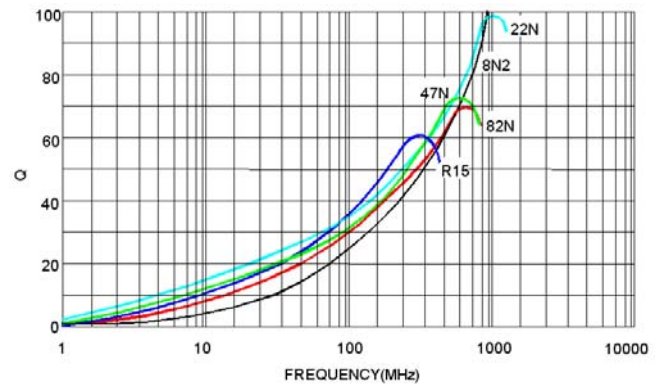
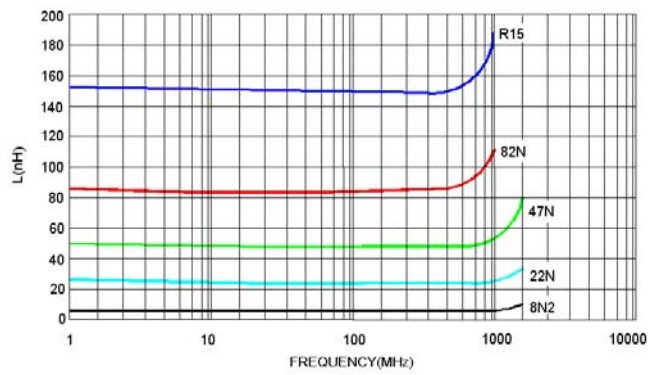

Please be sure to request approval specifications that provide further details of the products. Kindly note that the content of these specifications are subject to change or may be discontinued without advance notice. Please contact our sales department before ordering.

Packaging Specifications

Tape Dimensions

Figure 1

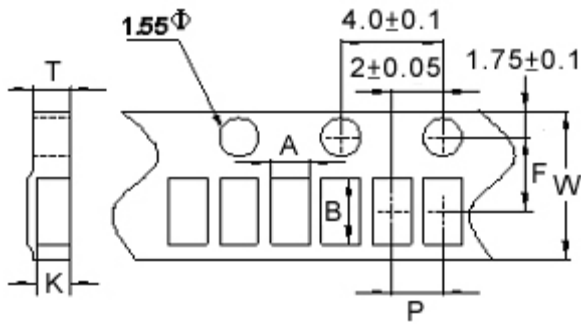

Tape Material



Figure 2

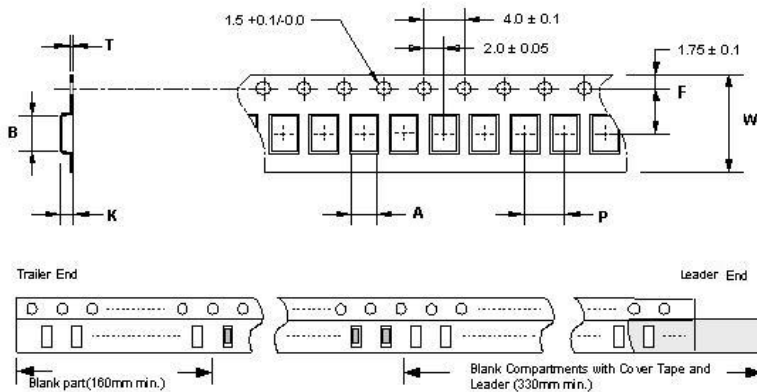

Reel Dimensions

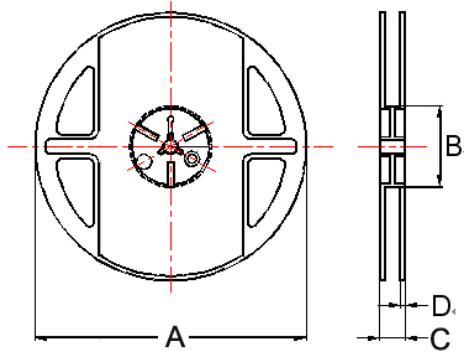

Dimensions in mm

TYPE	Fig.	Tape Dimensions							Reel Dimensions				Quantity PCS / Reel
		A	B	T	W	P	F	K	A	B	C	D	
CT0603	1	1.05	1.80	0.75	8	4	3.5	0.60	178	60	12	1.5	4000
CT0805	2	1.85	2.45	0.23	8	4	3.5	1.10	178	60	12	1.5	2000

HQ Series



Due to accurate wire winding technology, these chip inductors are designed for filtering, impedance matching, resonance and choke circuits for RF designer. Both standard series custom designs are available.

Features

- RoHS compliant.
- Ceramic body and wire wound construction provide highest SRFs
- Exceptional Q values even at high frequencies
- Highest possible SRFs as well as excellent Q values
- The non-magnetic coil form assures utmost thermal stability, predictability and batch consistency
- The highest Q factors and low RDC to fulfill the needs of mobile applications

Applications

- RF products for cellular phone
- GPS receiver
- Base Station
- Repeater
- Wireless LAN/ mouse/ keyboard/ earphone
- Remote control
- Security system and other RF modules

Product Identification

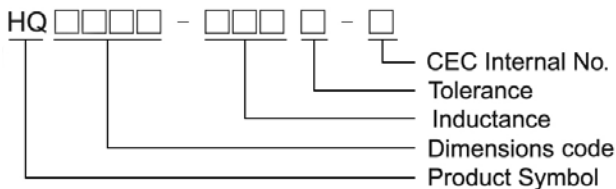

Shape and Dimensions/ Recommended Pattern

HQ0201

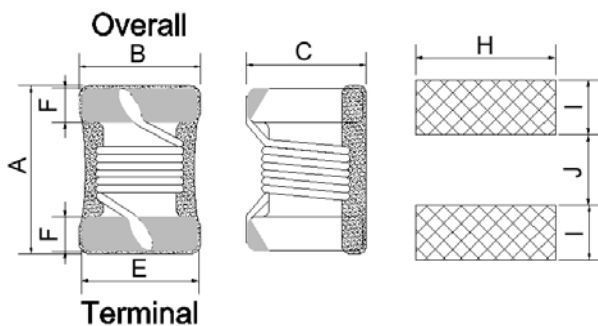

HQ0805/1008

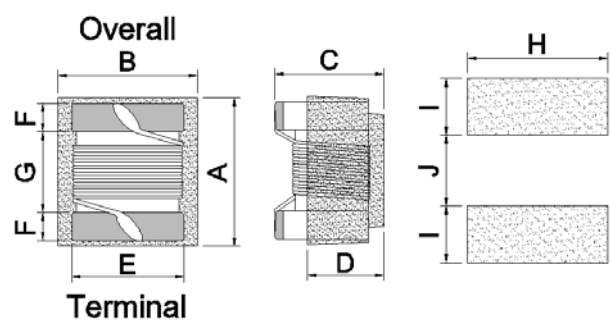

Dimensions

		A Max	B Max	C Max	D	E	F	G	H	I	J
HQ0201	inch	0.027	0.021	0.020	-	0.018	0.005	-	0.021	0.007	0.013
	mm	0.68	0.53	0.50	-	0.46	0.12	-	0.54	0.18	0.33
HQ0805	inch	0.090	0.070	0.061	0.020	0.050	0.017	0.050	0.070	0.040	0.030
	mm	2.29	1.78	1.56	0.50	1.27	0.44	1.27	1.78	1.02	0.76
HQ1008	inch	0.117	0.110	0.083	0.028	0.080	0.020	0.060	0.100	0.040	0.050
	mm	2.96	2.79	2.10	0.70	2.03	0.51	1.52	2.54	1.02	1.27

Electrical Characteristics

Part Number	Inductance (nH)	Tolerance (±%)	Q Min.	Test Frequency (MHz)	SRF (MHz)Min.	RDC (Ω)Max.	Irms (mA)Max.
HQ0201-0N8□-S	0.8	±0.1 / ±0.2nH	10	250	8500	0.05	1200
HQ0201-2N0□-S	2	10	18	250	8500	0.12	880
HQ0201-3N6□-S	3.6	10	16	250	8500	0.2	670
HQ0201-5N9□-S	5.9	10	20	250	8000	0.25	620
HQ0201-7N6□-S	7.6	10	18	250	6000	0.25	620
HQ0201-9N1□-S	9.1	10	20	250	6000	0.28	600
HQ0201-10N□-S	10	10	20	250	6000	0.28	600
HQ0201-15N□-S	15	10	22	250	4000	0.35	560
HQ0201-18N□-S	18	10	24	250	4000	0.40	460
HQ0201-22N□-S	22	10	24	250	4000	0.45	450
HQ0201-27N□-S	27	10	24	250	3500	0.50	440
HQ0201-34N□-S	34	10	22	250	3500	0.68	420
HQ0201-41N□-S	41	10	21	250	3500	1.1	330
HQ0201-48N□-S	48	10	21	250	3000	1.2	320
HQ0201-50N□-S	50	10	21	250	3000	1.55	290
HQ0201-56N□-S	56	10	21	250	3000	1.6	280
HQ0201-68N□-S	68	10	22	250	3000	2.3	250

Note: When ordering, please specify tolerance code. Tolerance : B=±0.1nH , C=±0.2nH , K=±10%

- Operating temperature range - 40°C ~ 125°C(Including self - temperature rise)
- I_{rms} for a 15°C temperature rise from 25°C ambient with current
- Measure Equipment :
 - L & Q : Agilent E4991A+Agilent HP16197A
 - SRF : Agilent HP8753D/Agilent HP8722ES
 - RDC : HP4287A
 - I_{rms} : HP4284A+HP42841A/HP4285A+HP42841A

Test Instruments : Agilent E4991A Material/Impedance Analyzer

Typical L vs. Frequency

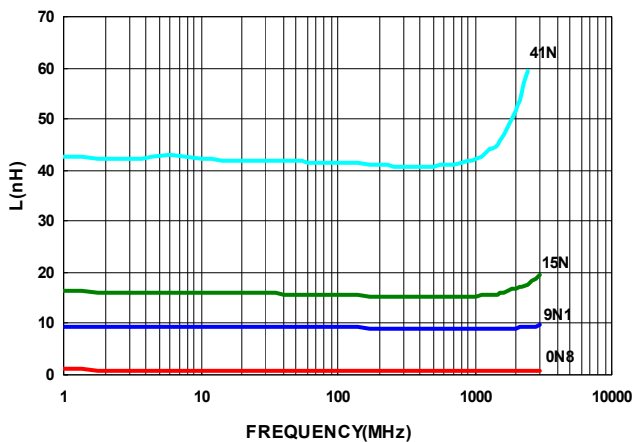

Typical Q vs. Frequency

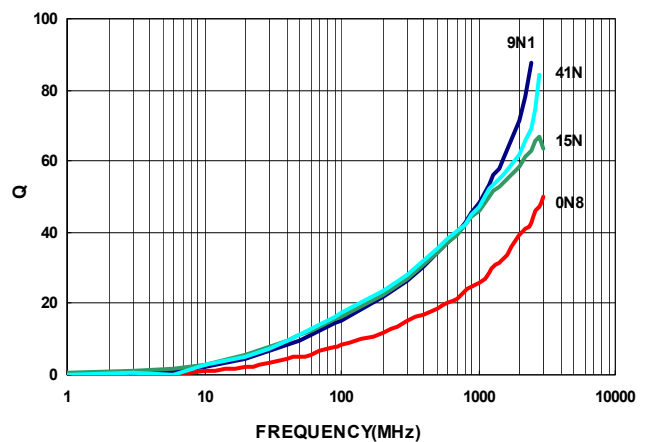

Please be sure to request approval specifications that provide further details of the products. Kindly note that the content of these specifications are subject to change or may be discontinued without advance notice. Please contact our sales department before ordering.

Electrical Characteristics

Part Number	Inductance (nH)	Tolerance (±%)	Test Frequency (MHz)	Q Min	Test Frequency (MHz)	SRF (MHz) Min	RDC (Ω) Max	Irms (mA) Max	Color
HQ0805-2N5□-S	2.5	10 / 5	250	80	1500	6000	0.020	1600	Black
HQ0805-5N6□-S	5.6	10 / 5	250	98	1500	6000	0.035	1600	Brown
HQ0805-6N2□-S	6.2	10 / 5	250	88	1000	4750	0.035	1600	Red
HQ0805-12N□-S	12.0	10 / 5	250	80	1000	3000	0.045	1600	Orange
HQ0805-16N□-S	16.0	10 / 5 / 2	250	72	500	2950	0.060	1500	Yellow
HQ0805-18N□-S	18.0	10 / 5 / 2	250	75	500	2550	0.060	1400	Green
HQ0805-20N□-S	20.0	10 / 5 / 2	250	70	500	2050	0.055	1400	Blue
HQ0805-27N□-S	27.0	10 / 5 / 2	250	75	500	2000	0.070	1300	Violet
HQ0805-30N□-S	30.0	10 / 5 / 2	250	65	500	1950	0.095	1200	Gray
HQ0805-39N□-S	39.0	10 / 5 / 2	250	65	500	1600	0.095	1100	White
HQ0805-48N□-S	48.0	10 / 5 / 2	200	65	500	1400	0.110	1200	Black
HQ0805-51N□-S	51.0	10 / 5 / 2	200	65	500	1400	0.120	1000	Brown

Note: When ordering, please specify tolerance code. Tolerance : G=±2% , J=±5% , K=±10%

- Operating temperature range - 40°C ~ 125°C(Including self - temperature rise)
- Irms for a 15°C temperature rise from 25°C ambient with current
- Measure Equipment :
 L & Q : Agilent E4991A+Agilent HP16197A
 SRF : Agilent HP8753D/Agilent E4991A
 RDC : HP 4338B or Chroma 16502
 Irms : HP4284A+HP42841A/HP4285A+HP42841A

Test Instruments : Agilent E4991A Material/Impedance Analyzer

Typical L vs. Frequency

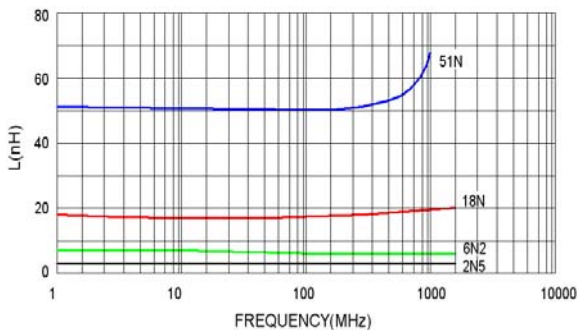

Typical Q vs. Frequency

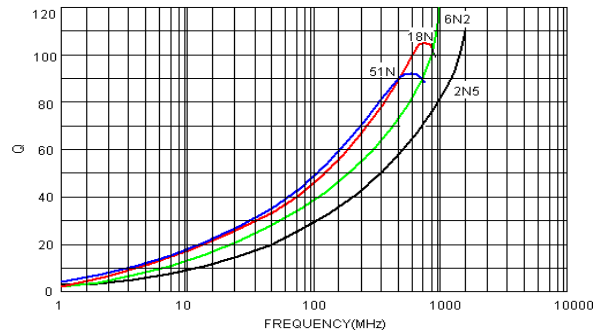

Please be sure to request approval specifications that provide further details of the products. Kindly note that the content of these specifications are subject to change or may be discontinued without advance notice. Please contact our sales department before ordering.

Electrical Characteristics

Part Number	Inductance (nH)	Tolerance (±%)	Test Frequency (MHz)	Q Min	Test Frequency (MHz)	SRF (MHz) Min	RDC (Ω) Max	I _{rms} (mA) Max	Color Coding		
									1 ST	2 ND	3 RD
HQ1008-4N1□-S	4.1	10 / 5	50	75	1500	6000	0.05	1600	Black	Yellow	Black
HQ1008-8N2□-S	8.2	10 / 5	50	60	500	3600	0.06	1600	Gray	Red	White
HQ1008-10N□-S	10	10 / 5	50	60	500	3600	0.06	1600	Brown	Black	Black
HQ1008-12N□-S	12	10 / 5 / 2	50	70	500	2800	0.06	1500	Brown	Red	Black
HQ1008-18N□-S	18	10 / 5 / 2	50	62	350	2700	0.07	1400	Brown	Gray	Black
HQ1008-22N□-S	22	10 / 5 / 2	50	62	350	2050	0.07	1400	Red	Red	Black
HQ1008-33N□-S	33	10 / 5 / 2	50	75	350	1700	0.09	1300	Orange	Orange	Black
HQ1008-39N□-S	39	10 / 5 / 2	50	75	350	1300	0.09	1300	Orange	White	Black
HQ1008-47N□-S	47	10 / 5 / 2	50	75	350	1450	0.12	1200	Yellow	Violet	Black
HQ1008-56N□-S	56	10 / 5 / 2	50	75	350	1230	0.12	1200	Green	Blue	Black
HQ1008-68N□-S	68	10 / 5 / 2	50	80	350	1150	0.13	1100	Blue	Gray	Black
HQ1008-82N□-S	82	10 / 5 / 2	50	80	350	1060	0.16	1100	Gray	Red	Black
HQ1008-R10□-S	100	10 / 5 / 2	50	62	350	1000	0.16	1000	Brown	Black	Brown
HQ1008-R12□-S	120	10 / 5 / 2	25	50	100	950	0.20	1000	Brown	Red	Brown
HQ1008-R15□-S	150	10 / 5 / 2	25	48	100	820	0.23	1000	Brown	Green	Brown
HQ1008-R22□-S	220	10 / 5 / 2	25	48	100	730	0.45	1000	Red	Red	Brown
HQ1008-R27□-S	270	10 / 5 / 2	25	48	100	650	0.50	900	Red	Violet	Brown
HQ1008-R33□-S	330	10 / 5 / 2	25	48	100	570	0.65	900	Orange	Orange	Brown
HQ1008-R39□-S	390	10 / 5 / 2	25	48	100	530	0.70	900	Orange	White	Brown

Note: When ordering, please specify tolerance code. Tolerance : G=±2% , J=±5% , K=±10%

- Operating temperature range - 40°C ~ 125°C(Including self - temperature rise)
- I_{rms} for a 15°C temperature rise from 25°C ambient with current
- Measure Equipment :
 L & Q : Agilent E4991A+Agilent HP16197A
 SRF : Agilent HP8753D/Agilent E4991A
 RDC : HP 4338B or Chroma 16502
 I_{rms} : HP4284A+HP42841A/HP4285A+HP42841A

Test Instruments : Agilent E4991A Material/Impedance Analyzer

Typical **L** vs. **F** Frequency

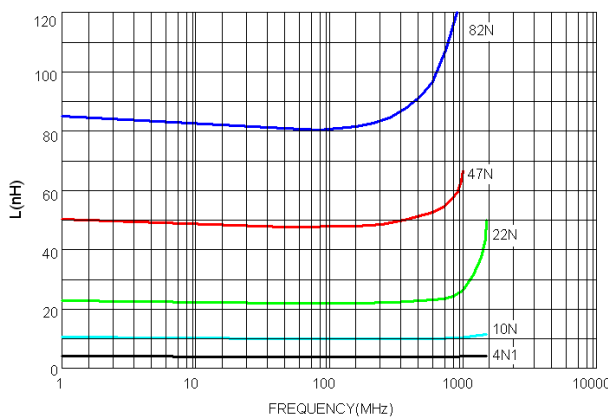

Typical **Q** vs. **F** Frequency

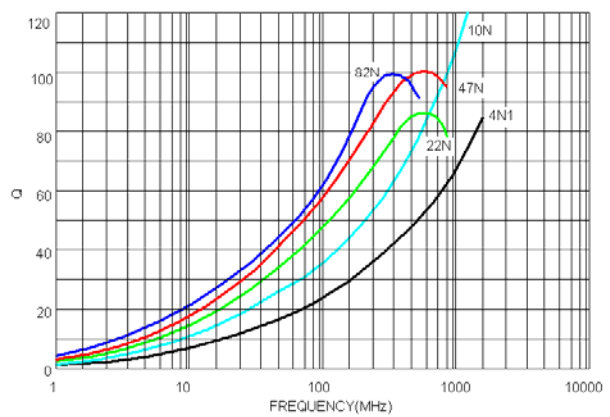

Please be sure to request approval specifications that provide further details of the products. Kindly note that the content of these specifications are subject to change or may be discontinued without advance notice. Please contact our sales department before ordering.

Packaging Specifications

Tape Dimensions

Reel Dimensions

Figure 1

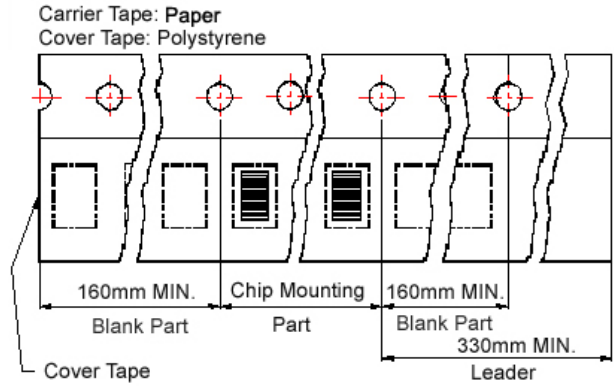
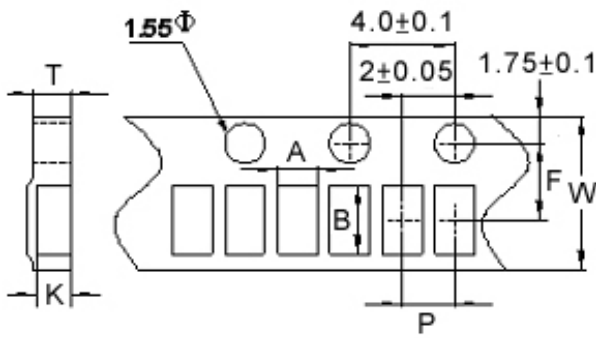
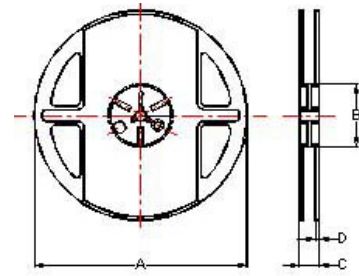
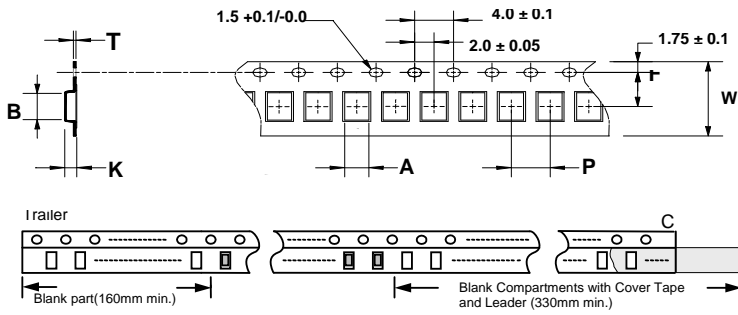

Figure 2



Dimensions in mm

TYPE	Fig.	Tape Dimensions							Reel Dimensions				Quantity PCS / REEL
		A	B	T	W	P	F	K	A	B	C	D	
HQ0201	1	0.56	0.71	0.65	8	2	3.5	0.54	178	60	12	1.5	2000
HQ0805	2	1.85	2.45	0.23	8	4	3.5	1.45	178	60	12	1.5	2000
HQ1008	2	2.80	2.95	0.23	8	4	3.5	2.20	178	60	12	1.5	2000

Electrical Characteristics

Part Number	Inductance (nH)	Tolerance (±%)	Test Frequency (MHz)	Q Min	Test Frequency (MHz)	SRF (MHz) Min	RDC (Ω) Max	I _{rms} (mA) Max	Color
HC0603-1N6□-S	1.6	10 / 5	250	24	250	12500	0.030	2400	Black
HC0603-3N6□-S	3.6	10 / 5	250	24	250	5900	0.048	2300	Brown
HC0603-3N9□-S	3.9	10 / 5	250	25	250	5900	0.054	2200	Red
HC0603-4N3□-S	4.3	10 / 5	250	35	250	5800	0.054	2100	Orange
HC0603-6N8□-S	6.8	10 / 5	250	35	250	5800	0.054	2100	Orange
HC0603-7N5□-S	7.5	10 / 5	250	35	250	3700	0.059	2100	Yellow
HC0603-8N2□-S	8.2	10 / 5	250	38	250	3700	0.071	2000	Brown
HC0603-10N□-S	10.0	10 / 5	250	38	250	3700	0.071	2000	Green
HC0603-12N□-S	12.0	10 / 5 / 2	250	38	250	3000	0.075	2000	Blue
HC0603-15N□-S	15.0	10 / 5 / 2	250	38	250	2800	0.080	1900	Violet
HC0603-18N□-S	18.0	10 / 5 / 2	250	40	250	2800	0.099	1900	Gray
HC0603-22N□-S	22.0	10 / 5 / 2	250	42	250	2400	0.099	1800	White
HC0603-24N□-S	24.0	10 / 5 / 2	250	42	250	2400	0.105	1800	Black

Note: When ordering, please specify tolerance code. Tolerance : G=±2% , J=±5% , K=±10%

- Operating temperature range - 40°C ~ 125°C(Including self - temperature rise)
- I_{rms} for a 20°C temperature rise from 25°C ambient with current
- Measure Equipment :
 - L & Q : Agilent E4991A+Agilent HP16197A
 - SRF : Agilent HP8753D
 - RDC : HP4338B or Chroma 16502
 - I_{rms} : HP4284A+HP42841A/HP4285A+HP42841A

Test Instruments : Agilent E4991A Material/Impedance Analyzer

Typical L vs. Frequency

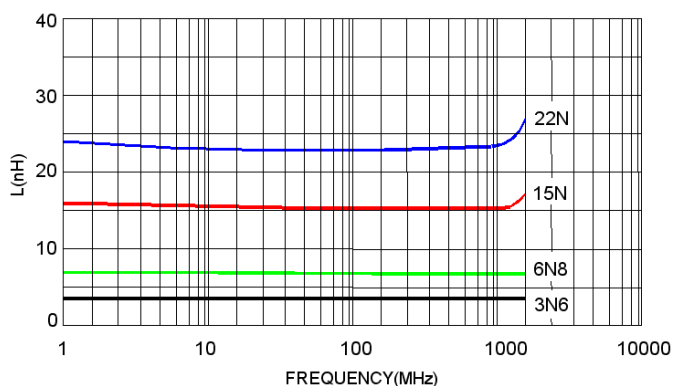

Typical Q vs. Frequency

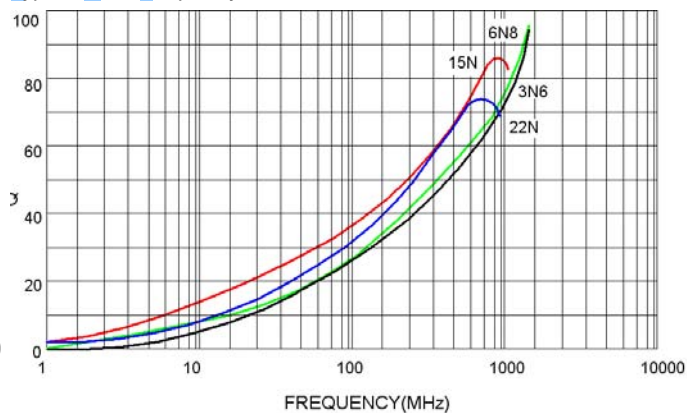

Please be sure to request approval specifications that provide further details of the products. Kindly note that the content of these specifications are subject to change or may be discontinued without advance notice. Please contact our sales department before ordering.

Packaging Specifications

Tape Dimensions

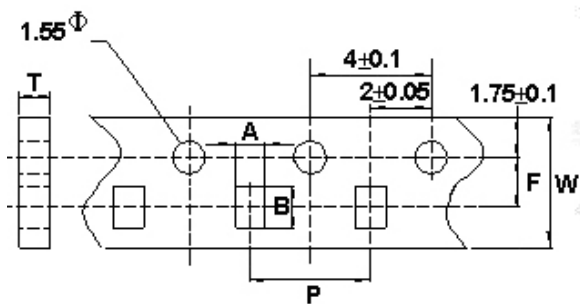

Tape Material

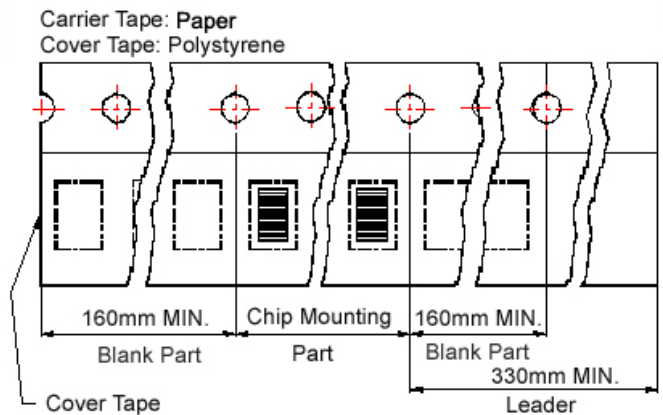

Reel Dimensions

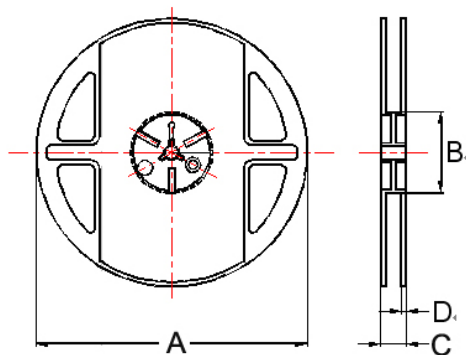

Dimensions in mm

TYPE	Tape Dimensions						Reel Dimensions				Quantity PCS / REEL
	A	B	T	W	P	F	A	B	C	D	
HC0603	1.20	1.80	1.05	8	4	3.5	178	60	12	1.5	4000

CL Series

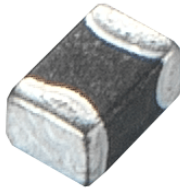

The SMD multi-layered ferrite chip inductors provide a cost-effective solution for densely packed PC board designs. CL series comes in 4 sizes and is suitable for low frequency applications.

Features

- RoHS compliant
- High mounting density of compact circuit due to crosstalk elimination that results from a closed magnetic flux in a ferrite material
- Suitable for flow and re-flow soldering
- Available in 5 sizes

Applications

- Personal computers, HDDs, other various electronic devices
- Any portable device where compact size and high mounting densities are required

Product Identification

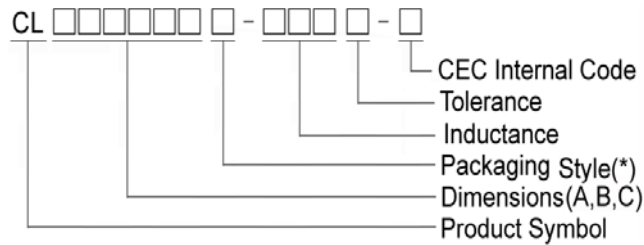

- Packaging : T : Tape and Reel ; B : Bulk

Shape and Dimensions

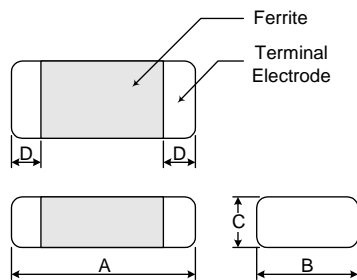

Recommended Pattern

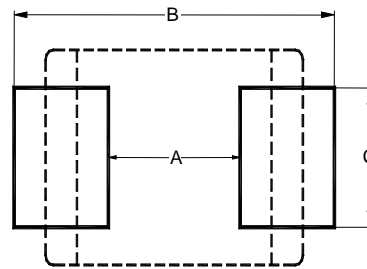

Dimensions in mm

TYPE	A	B	C	D
CL160808	1.6±0.20	0.80±0.20	0.80±0.20	0.3±0.20
CL201209	2.0±0.20	1.25±0.20	0.90±0.20	0.5±0.30
CL201212	2.0±0.20	1.25±0.20	1.25±0.20	0.5±0.30
CL321611	3.2±0.20	1.60±0.20	1.10±0.20	0.5±0.30

Dimensions in mm

TYPE	A	B	C
CL160808	0.7 ~ 0.8	1.8 ~ 2.0	0.6 ~ 0.8
CL201209	1.0 ~ 1.2	2.6 ~ 4.0	1.0 ~ 1.2
CL201212	1.0 ~ 1.2	2.6 ~ 4.0	1.0 ~ 1.2
CL321611	2.0	4.2 ~ 5.2	1.2

Electrical Characteristics

Part Number	Inductance (μH)	Tolerance ($\pm\%$)	Q Min	Test Frequency (MHz)	SRF (MHz) Min	RDC (Ω) Max	IDC (mA) Max
CL160808T-10N□-N	0.010	20	15	50	300	0.2	50
CL160808T-33N□-N	0.033	20	15	50	270	0.2	50
CL160808T-47N□-N	0.047	20	15	50	260	0.3	50
CL160808T-56N□-N	0.056	20	15	50	255	0.3	50
CL160808T-68N□-N	0.068	20	15	50	250	0.3	50
CL160808T-82N□-N	0.082	20	15	50	245	0.3	50
CL160808T-R10□-N	0.10	20 / 15 / 10	25	25	240	0.5	50
CL160808T-R12□-N	0.12	20 / 15 / 10	25	25	205	0.5	50
CL160808T-R15□-N	0.15	20 / 15 / 10	25	25	180	0.6	50
CL160808T-R18□-N	0.18	20 / 15 / 10	25	25	165	0.6	50
CL160808T-R22□-N	0.22	20 / 15 / 10	25	25	150	0.8	50
CL160808T-R27□-N	0.27	20 / 15 / 10	25	25	136	0.8	50
CL160808T-R33□-N	0.33	20 / 15 / 10	25	25	125	0.85	35
CL160808T-R39□-N	0.39	20 / 15 / 10	25	25	110	1.00	35
CL160808T-R47□-N	0.47	20 / 15 / 10	25	25	105	1.35	35
CL160808T-R56□-N	0.56	20 / 15 / 10	25	25	95	1.50	35
CL160808T-R68□-N	0.68	20 / 15 / 10	25	25	85	1.70	35
CL160808T-R82□-N	0.82	20 / 15 / 10	25	25	75	2.10	35
CL160808T-1R0□-N	1.0	20 / 15 / 10	35	10	65	0.60	25
CL160808T-1R2□-N	1.2	20 / 15 / 10	35	10	60	0.80	25
CL160808T-1R5□-N	1.5	20 / 15 / 10	35	10	55	0.80	25
CL160808T-1R8□-N	1.8	20 / 15 / 10	35	10	50	0.95	25
CL160808T-2R2□-N	2.2	20 / 15 / 10	35	10	45	1.00	15
CL160808T-2R7□-N	2.7	20 / 15 / 10	35	10	40	1.15	15
CL160808T-3R3□-N	3.3	20 / 15 / 10	35	10	38	1.30	15
CL160808T-3R9□-N	3.9	20 / 15 / 10	35	10	36	1.50	15
CL160808T-4R7□-N	4.7	20 / 15 / 10	35	10	33	1.60	15
CL160808T-5R6□-N	5.6	20 / 15 / 10	35	4	22	1.10	5
CL160808T-6R8□-N	6.8	20 / 15 / 10	35	4	20	1.30	5
CL160808T-8R2□-N	8.2	20 / 15 / 10	30	4	18	1.50	5
CL160808T-100□-N	10	20 / 15 / 10	30	2	17	1.70	5
CL160808T-120□-N	12	20 / 15 / 10	30	2	15	1.80	3
CL160808T-150□-N	15	20 / 15 / 10	20	1	14	1.50	1
CL160808T-220□-N	22	20 / 15 / 10	20	1	11	1.70	1

Note: When ordering, please specify tolerance code. Tolerance : K= $\pm 10\%$, L= $\pm 15\%$, M= $\pm 20\%$

- Operating temperature range - 40°C ~ 125°C(Including self - temperature rise)
- IDC : Applied the current to coils, the inductance shall be less than 10% initial value
- Measure Equipment :
 - L & Q : HP4291A
 - SRF : Agilent HP8753D/Agilent E4991A
 - RDC : HP4338B or CHEN HWA 502

Electrical Characteristics

Part Number	Inductance (μ H)	Tolerance (\pm %)	Q Min	Test Frequency (MHz)	SRF (MHz) Min	RDC (Ω) Max	IDC (mA) Max
CL201209T-22N□-N	0.022	20	20	50	320	0.20	300
CL201209T-33N□-N	0.033	20 / 15	20	50	320	0.20	300
CL201209T-47N□-N	0.047	20 / 15	20	50	320	0.20	300
CL201209T-56N□-N	0.056	20 / 15	20	50	320	0.20	300
CL201209T-68N□-N	0.068	20 / 15	20	50	280	0.20	300
CL201209T-82N□-N	0.082	20 / 15	20	50	255	0.20	300
CL201209T-R10□-N	0.10	20 / 15 / 0	25	25	235	0.30	250
CL201209T-R12□-N	0.12	20 / 15 / 10	25	25	220	0.30	250
CL201209T-R15□-N	0.15	20 / 15 / 10	25	25	200	0.40	250
CL201209T-R18□-N	0.18	20 / 15 / 10	25	25	185	0.40	250
CL201209T-R22□-N	0.22	20 / 15 / 10	25	25	170	0.50	250
CL201209T-R27□-N	0.27	20 / 15 / 10	25	25	150	0.50	250
CL201209T-R33□-N	0.33	20 / 15 / 10	25	25	145	0.55	250
CL201209T-R39□-N	0.39	20 / 15 / 10	25	25	135	0.65	250
CL201209T-R47□-N	0.47	20 / 15 / 10	25	25	125	0.65	250
CL201209T-R56□-N	0.56	20 / 15 / 10	25	25	115	0.75	150
CL201209T-R68□-N	0.68	20 / 15 / 10	25	25	105	0.80	150
CL201209T-R82□-N	0.82	20 / 15 / 10	25	25	100	1.00	150
CL201209T-1R0□-N	1.0	20 / 15 / 10	45	10	75	0.40	50
CL201209T-1R2□-N	1.2	20 / 15 / 10	45	10	65	0.50	50
CL201209T-1R5□-N	1.5	20 / 15 / 10	45	10	60	0.50	50
CL201209T-1R8□-N	1.8	20 / 15 / 10	45	10	55	0.60	50
CL201209T-2R2□-N	2.2	20 / 15 / 10	45	10	50	0.65	30

Note: When ordering, please specify tolerance code. Tolerance : K=±10% , L=±15% , M=±20%

- Operating temperature range - 40°C ~ 125°C(Including self - temperature rise)
- IDC : Applied the current to coils, the inductance shall be less than 10% initial value
- Measure Equipment :
 L & Q : HP4291A
 SRF : Agilent HP8753D/Agilent E4991A
 RDC : HP4338B or CHEN HWA 502

Electrical Characteristics

Part Number	Inductance (μ H)	Tolerance (\pm %)	Q Min	Test Frequency (MHz)	SRF (MHz) Min	RDC (Ω) Max	IDC (mA) Max
CL201212T-2R7□-N	2.7	20 / 15 / 10	45	10	45	0.75	30
CL201212T-3R3□-N	3.3	20 / 15 / 10	45	10	41	0.80	30
CL201212T-3R9□-N	3.9	20 / 15 / 10	45	10	38	0.90	30
CL201212T-4R7□-N	4.7	20 / 15 / 10	45	10	35	1.00	30
CL201212T-5R6□-N	5.6	20 / 15 / 10	45	4	32	0.90	15
CL201212T-6R8□-N	6.8	20 / 15 / 10	45	4	29	1.00	15
CL201212T-8R2□-N	8.2	20 / 15 / 10	45	4	26	1.10	15
CL201212T-100□-N	10	20 / 15 / 10	45	2	24	1.10	15
CL201212T-120□-N	12	20 / 15 / 10	45	2	22	1.20	15
CL201212T-150□-N	15	20 / 15 / 10	30	1	19	0.80	5
CL201212T-180□-N	18	20 / 15 / 10	30	1	18	0.90	5
CL201212T-220□-N	22	20 / 15 / 10	30	1	16	1.1	5

Note: When ordering, please specify tolerance code. Tolerance : K=±10% , L=±15% , M=±20%

- Operating temperature range - 40°C ~ 125°C(Including self - temperature rise)
- IDC : Applied the current to coils, the inductance shall be less than 10% initial value
- Measure Equipment :
 L & Q : HP4291A
 SRF : Agilent HP8753D/Agilent E4991A
 RDC : HP4338B or CHEN HWA 502

Please be sure to request approval specifications that provide further details of the products. Kindly note that the content of these specifications are subject to change or may be discontinued without advance notice. Please contact our sales department before ordering.

Electrical Characteristics

Part Number	Inductance (μ H)	Tolerance (\pm %)	Q Min	Test Frequency (MHz)	SRF (MHz) Min	RDC (Ω) Max	IDC (mA) Max
CL321611T-47N□-N	0.047	20	20	50	320	0.15	300
CL321611T-56N□-N	0.056	20	20	50	280	0.25	300
CL321611T-68N□-N	0.068	20	20	50	280	0.25	300
CL321611T-82N□-N	0.082	20	20	50	250	0.25	300
CL321611T-R10□-N	0.10	20 / 15 / 10	25	25	235	0.25	250
CL321611T-R12□-N	0.12	20 / 15 / 10	25	25	220	0.30	250
CL321611T-R15□-N	0.15	20 / 15 / 10	25	25	200	0.30	250
CL321611T-R18□-N	0.18	20 / 15 / 10	25	25	185	0.40	250
CL321611T-R22□-N	0.22	20 / 15 / 10	25	25	170	0.40	250
CL321611T-R27□-N	0.27	20 / 15 / 10	25	25	150	0.50	250
CL321611T-R33□-N	0.33	20 / 15 / 10	25	25	145	0.60	250
CL321611T-R39□-N	0.39	20 / 15 / 10	25	25	135	0.50	200
CL321611T-R47□-N	0.47	20 / 15 / 10	25	25	125	0.60	200
CL321611T-R56□-N	0.56	20 / 15 / 10	25	25	115	0.70	150
CL321611T-R68□-N	0.68	20 / 15 / 10	25	25	105	0.80	150
CL321611T-R82□-N	0.82	20 / 15 / 10	25	25	100	0.90	150
CL321611T-1R0□-N	1.0	20 / 15 / 10	45	10	75	0.40	100
CL321611T-1R2□-N	1.2	20 / 15 / 10	45	10	65	0.50	100
CL321611T-1R5□-N	1.5	20 / 15 / 10	45	10	60	0.50	80
CL321611T-1R8□-N	1.8	20 / 15 / 10	45	10	55	0.50	70
CL321611T-2R2□-N	2.2	20 / 15 / 10	45	10	50	0.60	60
CL321611T-2R7□-N	2.7	20 / 15 / 10	45	10	45	0.60	60
CL321611T-3R3□-N	3.3	20 / 15 / 10	45	10	41	0.70	60
CL321611T-3R9□-N	3.9	20 / 15 / 10	45	10	38	0.80	50
CL321611T-4R7□-N	4.7	20 / 15 / 10	45	10	35	0.90	50
CL321611T-5R6□-N	5.6	20 / 15 / 10	45	4	32	0.70	25
CL321611T-6R8□-N	6.8	20 / 15 / 10	45	4	29	0.80	25
CL321611T-8R2□-N	8.2	20 / 15 / 10	45	4	26	0.90	25
CL321611T-100□-N	10	20 / 15 / 10	45	2	24	1.00	25
CL321611T-120□-N	12	20 / 15 / 10	45	2	22	1.00	15
CL321611T-150□-N	15	20 / 15 / 10	35	1	19	0.70	5
CL321611T-180□-N	18	20 / 15 / 10	35	1	18	0.75	5
CL321611T-220□-N	22	20 / 15 / 10	35	1	16	0.90	5
CL321611T-270□-N	27	20 / 15 / 10	35	1	14	0.90	5

Note: When ordering, please specify tolerance code. Tolerance : K=±10% , L=±15% , M=±20%

- Operating temperature range - 40°C ~ 125°C(Including self - temperature rise)
- IDC : Applied the current to coils, the inductance shall be less than 10% initial value
- Measure Equipment :
 - L & Q : HP4291A
 - SRF : Agilent HP8753D/Agilent E4991A
 - RDC : HP4338B or CHEN HWA 502

Test Instruments : Agilent E4991A Impedance / Material Analyzer

CL160808

INDUCTANCE v.s. FREQUENCY CHARACTERISTICS

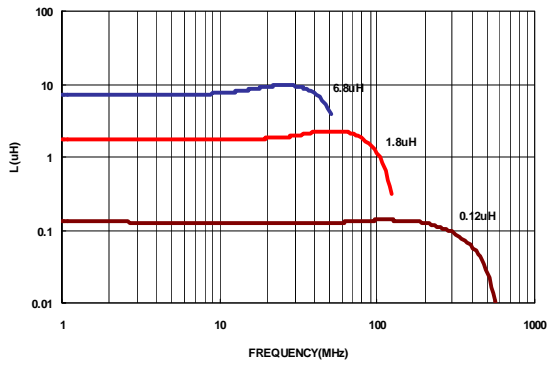

Q v.s. FREQUENCY CHARACTERISTICS

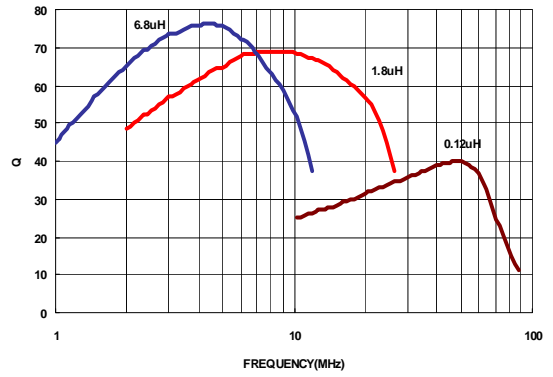

CL201209

INDUCTANCE v.s. FREQUENCY CHARACTERISTICS

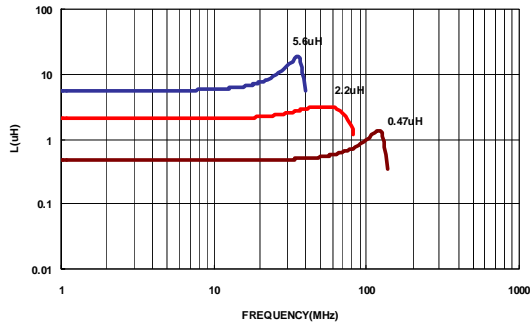

Q v.s. FREQUENCY CHARACTERISTICS

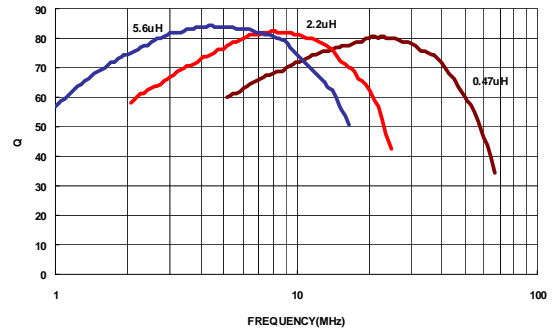

CL321611

INDUCTANCE v.s. FREQUENCY CHARACTERISTICS

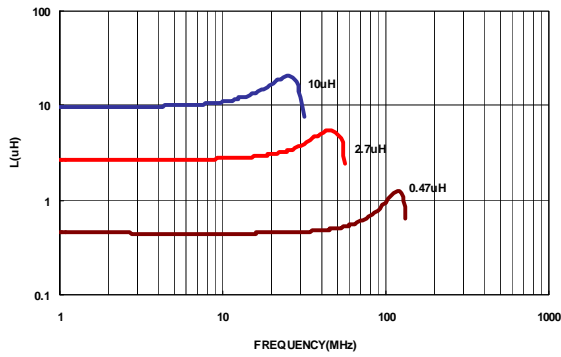

Q v.s. FREQUENCY CHARACTERISTICS

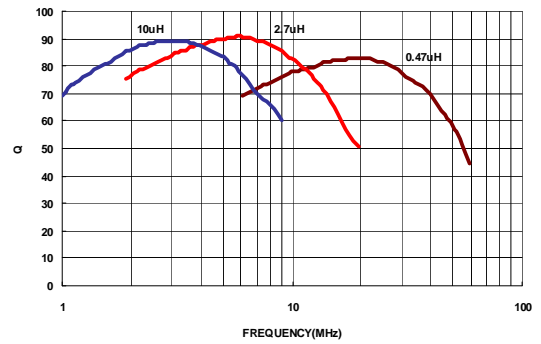

Packaging Specifications

Tape Dimensions

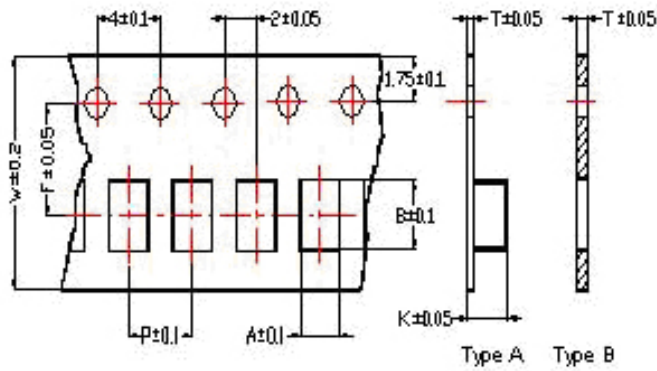

Tape Material

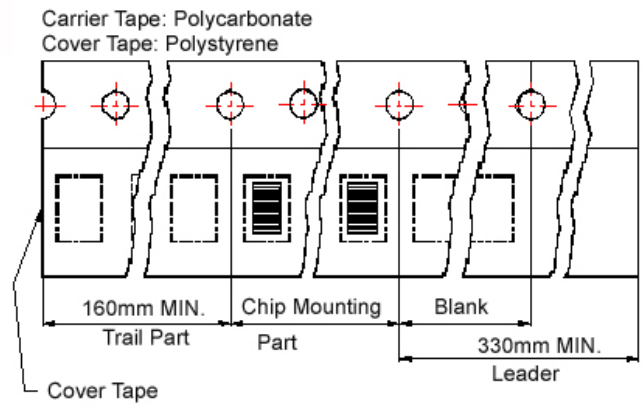

Reel Dimensions

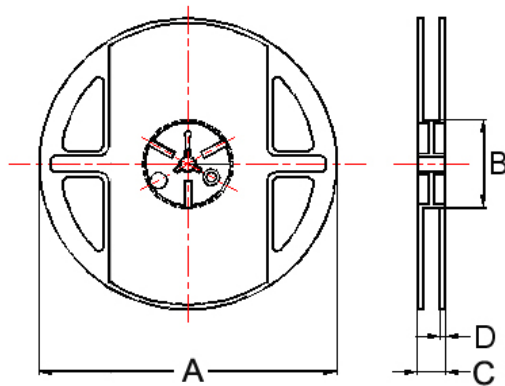

Dimensions in mm

TYPE	Tape Dimensions								Tape	Reel Dimensions				Quantity
	A	B	T	W	P	F	K	A		B	C	D	PCS / Reel	
CL160808	1.05	1.85	0.95	8.0	4.0	3.5	-	B	178	60	12	1.5	4000	
CL201209	1.50	2.30	0.97	8.0	4.0	3.5	-	B	178	60	12	1.5	4000	
CL201212	1.35	2.25	0.22	8.0	4.0	3.5	1.35	A	178	60	12	1.5	3000	
CL321611	1.88	3.50	0.22	8.0	4.0	3.5	1.27	A	178	60	12	1.5	3000	

NL Series



Features

- RoHS compliant
- Strong solderability by reflow soldering and soldering iron
- Highly accurate dimensions
- Can be mounted automatically
- Terminals are highly resistant to external forces
- Highly resistant to mechanical shocks and pressure
- Highly reliable in environments of sudden temperature change and humidity
- Superior Q characteristics and the broadest L selections among peers

Applications

- Microtelevisions
- Liquid crystal televisions
- Video cameras
- Portable VCRs
- Car radios
- Car stereos
- Thin tape radios
- Television tuners
- Mobile telephones
- Radio and other electronic devices

Product Identification

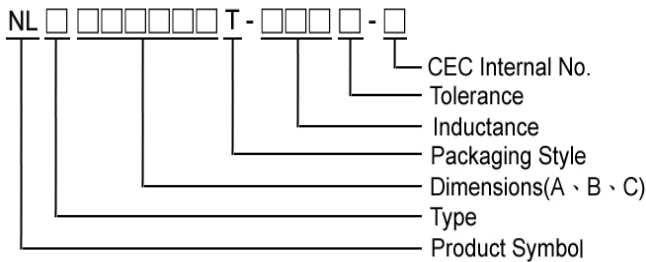

- Packaging: T : Tape and Reel

Shape and Dimensions

NL201614

NL252018

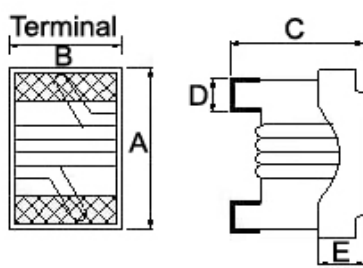
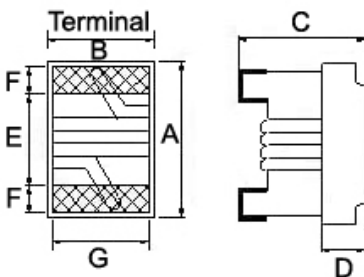

Recommended Pattern

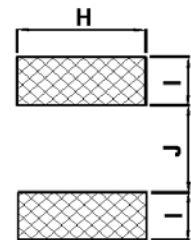

Dimensions in mm

TYPE	A Max	B Max	C Max	D	E	F	G	H	I	J
NL201614	2.40	1.72	1.52	0.70	1.02	0.50	1.27	1.78	1.02	0.76
NL252018	2.92	2.50 2.79	2.20	0.51	0.51	-	-	2.54	1.02	1.27

NL252018: B Max: 2.79 mm, at 5N0~R10,
2.50 mm, at R12~101

Electrical Characteristics

Part Number	Inductance (uH)	Tolerance (±%)	Q Min	Test Frequency (MHz)	SRF (MHz) Min	RDC (Ω) Max	IDC (mA)	Color
NL201614T-R12□-N	0.12	10 / 5	25	25.2	500	0.20	600	White
NL201614T-R15□-N	0.15	10 / 5	25	25.2	450	0.25	600	Black
NL201614T-R18□-N	0.18	10 / 5	25	25.2	410	0.30	570	Brown
NL201614T-R22□-N	0.22	10 / 5	25	25.2	350	0.35	550	Red
NL201614T-R27□-N	0.27	10 / 5	25	25.2	280	0.40	530	Orange
NL201614T-R33□-N	0.33	10 / 5	25	25.2	235	0.45	510	Yellow
NL201614T-R39□-N	0.39	10 / 5	25	25.2	210	0.50	490	Green
NL201614T-R47□-N	0.47	10 / 5	25	25.2	170	0.55	470	Blue
NL201614T-R56□-N	0.56	10 / 5	25	25.2	150	0.60	450	Violet
NL201614T-R68□-N	0.68	10 / 5	25	25.2	140	0.70	420	Gray
NL201614T-R82□-N	0.82	10 / 5	25	25.2	130	0.75	400	White
NL201614T-1R0□-N	1.00	10 / 5	15	7.96	115	0.80	350	Black
NL201614T-1R2□-N	1.20	10 / 5	15	7.96	95	0.90	325	Brown
NL201614T-1R5□-N	1.50	10 / 5	15	7.96	85	1.05	300	Red
NL201614T-1R8□-N	1.80	10 / 5	15	7.96	80	1.20	270	Orange
NL201614T-2R2□-N	2.20	10 / 5	15	7.96	75	1.40	250	Yellow
NL201614T-2R7□-N	2.70	10 / 5	15	7.96	70	1.60	230	Green
NL201614T-3R3□-N	3.30	10 / 5	15	7.96	60	1.80	210	Blue
NL201614T-3R9□-N	3.90	10 / 5	15	7.96	55	2.00	190	Violet
NL201614T-4R7□-N	4.70	10 / 5	15	7.96	45	2.40	170	Gray
NL201614T-5R6□-N	5.60	10 / 5	15	7.96	40	2.70	150	White
NL201614T-6R8□-N	6.80	10 / 5	15	7.96	36	3.20	140	Black
NL201614T-8R2□-N	8.20	10 / 5	15	7.96	33	3.60	120	Brown
NL201614T-100□-N	10.0	10 / 5	15	2.52	30	4.50	110	Red
NL201614T-120□-N	12.0	10 / 5	15	2.52	25	5.70	105	Orange
NL201614T-150□-N	15.0	10 / 5	15	2.52	23	6.50	90	Yellow
NL201614T-180□-N	18.0	10 / 5	15	2.52	21	7.00	85	Green
NL201614T-220□-N	22.0	10 / 5	15	2.52	20	8.00	78	Blue
NL201614T-270□-N	27.0	10 / 5	15	2.52	18	9.00	75	Violet
NL201614T-330□-N	33.0	10 / 5	15	2.52	17	10.0	70	Gray

Note: When ordering, please specify tolerance code. Tolerance : J=±5% , K=±10%

- Operating temperature range - 25°C ~ 105°C(Including self - temperature rise)
- IDC for Inductance drop 10% from its value with current
- Measure Equipment :
 L & Q : Agilent E4991A+Agilent HP16197A
 SRF : Agilent E4991A
 RDC : HP4338B or Chroma 16502

Test Instruments : Agilent E4991A Material/Impedance Analyzer

Typical L vs. Frequency

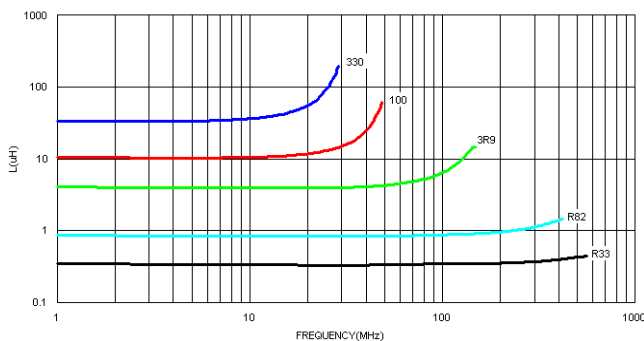

Typical Q vs. Frequency

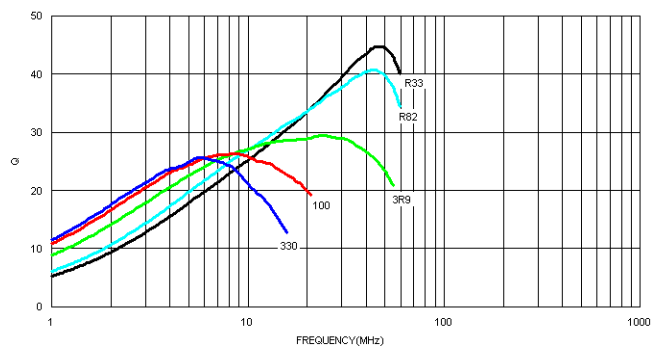

Please be sure to request approval specifications that provide further details of the products. Kindly note that the content of these specifications are subject to change or may be discontinued without advance notice. Please contact our sales department before ordering.

Electrical Characteristics

Part Number	Inductance (uH)	Tolerance (±%)	Q Min	Test Frequency (MHz)	SRF (MHz) Min	RDC (Ω) Max	IDC (mA)	Color Coding		
								1 ST	2 ND	3 RD
NL252018T-5N0□-N	0.005	10	10	100	3000	0.25	2000	Black	Green	Black
NL252018T-10N□-N	0.010	10	10	100	2500	0.25	1800	Brown	Black	Black
NL252018T-12N□-N	0.012	10	15	100	2400	0.26	1700	Brown	Red	Black
NL252018T-15N□-N	0.015	10	15	100	2300	0.28	1600	Brown	Green	Black
NL252018T-18N□-N	0.018	10	15	100	2200	0.30	1550	Brown	Gray	Black
NL252018T-22N□-N	0.022	10 / 5	20	100	2100	0.35	1500	Red	Red	Black
NL252018T-27N□-N	0.027	10 / 5	20	100	2000	0.40	1450	Red	Violet	Black
NL252018T-33N□-N	0.033	10 / 5	30	100	1600	0.42	1400	Orange	Orange	Black
NL252018T-39N□-N	0.039	10 / 5	35	100	1500	0.45	1350	Orange	White	Black
NL252018T-47N□-N	0.047	10 / 5	35	100	1400	0.50	1300	Yellow	Violet	Black
NL252018T-56N□-N	0.056	10 / 5	35	100	1300	0.60	1250	Green	Blue	Black
NL252018T-68N□-N	0.068	10 / 5	35	100	1200	0.65	1240	Blue	Gray	Black
NL252018T-82N□-N	0.082	10 / 5	35	100	1100	0.75	1230	Gray	Red	Black
NL252018T-R10□-N	0.10	10 / 5	35	100	800	0.80	1220	Brown	Black	Brown
NL252018T-R12□-N	0.12	10 / 5	30	25.2	700	0.30	900	Brown	Red	Brown
NL252018T-R15□-N	0.15	10 / 5	30	25.2	550	0.35	900	Brown	Green	Brown
NL252018T-R18□-N	0.18	10 / 5	30	25.2	500	0.40	850	Brown	Gray	Brown
NL252018T-R22□-N	0.22	10 / 5	30	25.2	450	0.50	840	Red	Red	Brown
NL252018T-R27□-N	0.27	10 / 5	30	25.2	425	0.55	830	Red	Violet	Brown
NL252018T-R33□-N	0.33	10 / 5	30	25.2	400	0.60	820	Orange	Orange	Brown
NL252018T-R39□-N	0.39	10 / 5	30	25.2	375	0.65	810	Orange	White	Brown
NL252018T-R47□-N	0.47	10 / 5	30	25.2	350	0.68	800	Yellow	Violet	Brown
NL252018T-R56□-N	0.56	10 / 5	30	25.2	325	0.75	800	Green	Blue	Brown
NL252018T-R68□-N	0.68	10 / 5	30	25.2	300	0.85	800	Blue	Gray	Brown
NL252018T-R82□-N	0.82	10 / 5	30	25.2	260	1.0	800	Gray	Red	Brown
NL252018T-1R0□-N	1.0	10 / 5	25	7.96	245	1.1	800	Brown	Black	Red
NL252018T-1R2□-N	1.2	10 / 5	25	7.96	230	1.2	790	Brown	Red	Red
NL252018T-1R5□-N	1.5	10 / 5	25	7.96	182	1.3	750	Brown	Green	Red
NL252018T-1R8□-N	1.8	10 / 5	25	7.96	135	1.45	750	Brown	Gray	Red
NL252018T-2R2□-N	2.2	10 / 5	25	7.96	105	1.55	750	Red	Red	Red
NL252018T-2R7□-N	2.7	10 / 5	25	7.96	70	1.7	740	Red	Violet	Red
NL252018T-3R3□-N	3.3	10 / 5	25	7.96	55	1.9	730	Orange	Orange	Red
NL252018T-3R9□-N	3.9	10 / 5	25	7.96	48	2.1	700	Orange	White	Red
NL252018T-4R7□-N	4.7	10 / 5	25	7.96	43	2.3	650	Yellow	Violet	Red
NL252018T-5R6□-N	5.6	10 / 5	20	7.96	42	2.5	640	Green	Blue	Red
NL252018T-6R8□-N	6.8	10 / 5	20	7.96	39	2.7	630	Blue	Gray	Red
NL252018T-8R2□-N	8.2	10 / 5	20	7.96	36	3.05	600	Gray	Red	Red
NL252018T-100□-N	10	10 / 5	15	2.52	33	3.5	600	Brown	Black	Orange
NL252018T-120□-N	12	10 / 5	15	2.52	30	3.8	550	Brown	Red	Orange
NL252018T-150□-N	15	10 / 5	15	2.52	26	4.4	430	Brown	Green	Orange
NL252018T-180□-N	18	10 / 5	15	2.52	24	4.8	400	Brown	Gray	Orange
NL252018T-220□-N	22	10 / 5	15	2.52	22	5.5	400	Red	Red	Orange
NL252018T-270□-N	27	10 / 5	15	2.52	21	6.3	360	Red	Violet	Orange
NL252018T-330□-N	33	10 / 5	15	2.52	20	7.1	350	Orange	Orange	Orange
NL252018T-390□-N	39	10 / 5	10	2.52	18	9.5	330	Orange	White	Orange
NL252018T-470□-N	47	10 / 5	10	2.52	17	11.1	300	Yellow	Violet	Orange
NL252018T-560□-N	56	10 / 5	10	2.52	16	12.1	270	Green	Blue	Orange
NL252018T-680□-N	68	10 / 5	10	2.52	15	16.6	250	Blue	Gray	Orange
NL252018T-820□-N	82	10 / 5	10	2.52	13	19	200	Gray	Red	Orange
NL252018T-101□-N	100	10 / 5	8	0.796	12	21	120	Brown	Black	Yellow

Note: When ordering, please specify tolerance code. Tolerance : J=±5% , K=±10%

- Operating temperature range - 25°C ~ 105°C(Including self - temperature rise)
- IDC for Inductance drop 10% from its value with current
- Measure Equipment :
L & Q : HP4291A/HP4285A
SRF : HP4291A/HP8753D
RDC : HP4338B or Chroma 16502

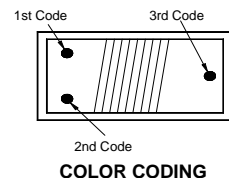

Please be sure to request approval specifications that provide further details of the products. Kindly note that the content of these specifications are subject to change or may be discontinued without advance notice. Please contact our sales department before ordering.

Test Instruments : Agilent E4991A Material/Impedance Analyzer

Typical L vs. Frequency

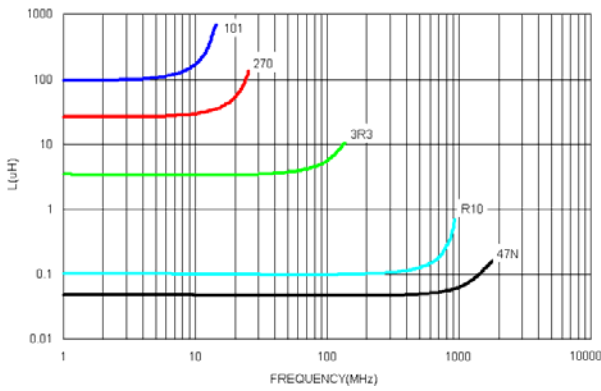

Typical Q vs. Frequency

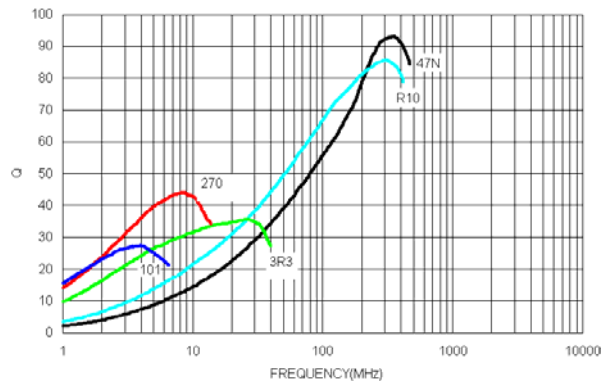

Tape Dimensions

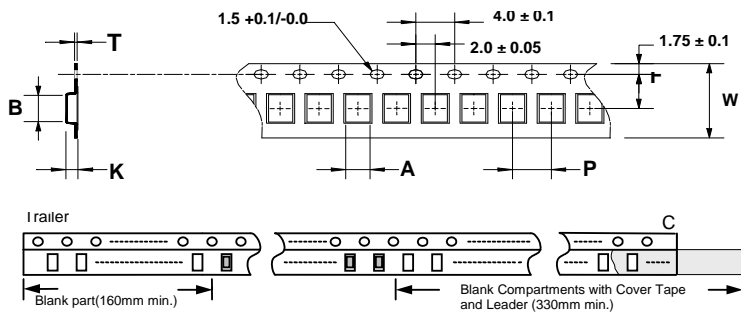

Reel Dimensions

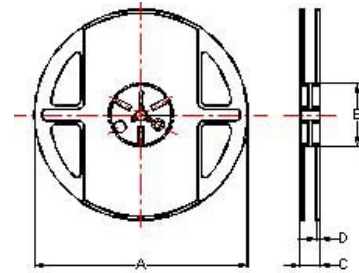

Dimensions in mm

TYPE	Tape Dimensions							Reel Dimensions				Quantity PCS / Reel
	A	B	T	W	P	F	K	A	B	C	D	
NL201614	1.85	2.45	0.23	8	4	3.5	1.45	178	60	12	1.5	2000
NL252018(5N0~R10)	2.80	2.95	0.23	8	4	3.5	2.20	178	60	12	1.5	2000
NL252018(R12~101)	2.40	2.93	0.26	8	4	3.5	2.25	178	60	12	1.5	2000

NLC Series



The characteristics of this series perform low RDC and carry large current. These unique open type inductors offer many superior features in opposition to the molding type one of Japanese peers.

Features

- RoHS compliant
- Very strong solderability by reflow soldering and soldering iron
- Highly accurate dimensions can be mounted automatically
- Terminals are highly resistant to pull forces
- Highly resistant to mechanical shocks and pressure
- Highly reliable in environments of sudden temperature change and humidity
- Superior IDC for DC/DC converter

Applications

- DC/DC converter such as DSC
- LCD TV
- Game console
- Portable VCRs
- Conveyable telephone and others

Product Identification

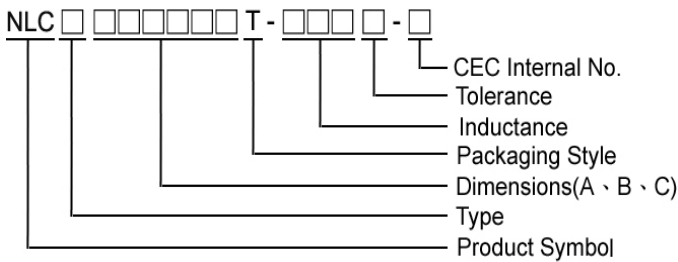

- Packaging: T : Tape and Reel

Shape and Dimensions

NLC252018

NLC322522

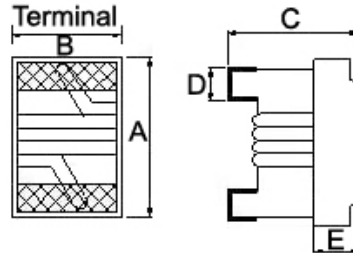
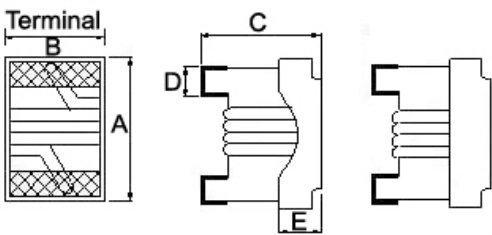

Recommended Pattern

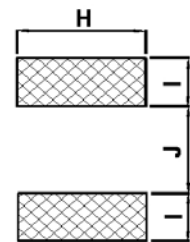

Dimensions in mm

TYPE	A Max	B Max	C Max	D	E	H	I	J
NLC252018	2.92	2.50	2.20	0.51	0.51	2.54	1.02	1.27
NLC322522	3.70	2.90	2.60	0.51	0.51	2.70	1.00	2.00

Electrical Characteristics

								Color Coding		
								1 ST	2 ND	3 RD
NLC252018T-1R0□-N	1.0	10 / 5	25	7.96	300	0.34	1500	Brown	Black	Red
NLC252018T-1R2□-N	1.2	10 / 5	25	7.96	280	0.40	1400	Brown	Red	Red
NLC252018T-1R5□-N	1.5	10 / 5	25	7.96	270	0.42	1400	Brown	Green	Red
NLC252018T-1R8□-N	1.8	10 / 5	25	7.96	150	0.45	1200	Brown	Gray	Red
NLC252018T-2R2□-N	2.2	10 / 5	25	7.96	140	0.50	1200	Red	Red	Red
NLC252018T-3R3□-N	3.3	10 / 5	25	7.96	95	0.65	1000	Orange	Orange	Red
NLC252018T-4R7□-N	4.7	10 / 5	25	7.96	90	0.80	800	Yellow	Violet	Red
NLC252018T-6R8□-N	6.8	10 / 5	25	7.96	68	1.00	730	Blue	Gray	Red
NLC252018T-100□-N	10	10 / 5	20	2.52	45	1.50	700	Brown	Black	Orange
NLC252018T-150□-N	15	10 / 5	20	2.52	40	2.20	500	Brown	Green	Orange
NLC252018T-220□-N	22	10 / 5	20	2.52	25	2.70	470	Red	Red	Orange
NLC252018T-330□-N	33	10 / 5	20	2.52	25	4.00	400	Orange	Orange	Orange
NLC252018T-390□-N	39	10 / 5	16	2.52	20	7.00	320	Orange	White	Orange
NLC252018T-470□-N	47	10 / 5	16	2.52	20	8.00	300	Yellow	Violet	Orange

Note: When ordering, please specify tolerance code. Tolerance : J=±5% , K=±10%

- Operating temperature range - 25°C ~ 105°C(Including self - temperature rise)
- IDC for Inductance drop 10% from its value with current
- Measure Equipment :
 L & Q : Agilent HP4291A/Agilent HP4285A+Agilent HP16197A
 SRF : Agilent HP4291A
 RDC : HP4338B or Chroma 16502

Test Instruments : Agilent HP4291A Material/Impedance Analyzer

Typical L vs. Frequency

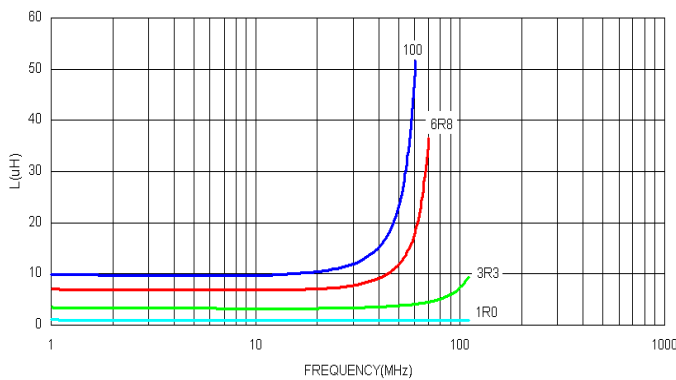

Typical Q vs. Frequency

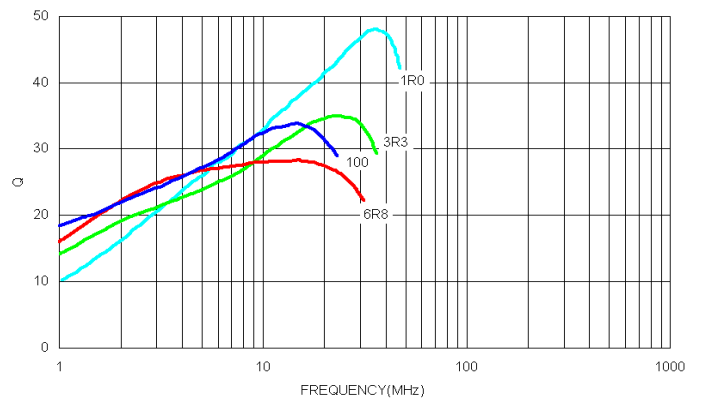

Please be sure to request approval specifications that provide further details of the products. Kindly note that the content of these specifications are subject to change or may be discontinued without advance notice. Please contact our sales department before ordering.

Electrical Characteristics

Part Number	Inductance (uH)	Tolerance (±%)	Q Min	Test Frequency (MHz)	SRF (MHz) Typ.	RDC (Ω)±30%	IDC (mA)	Color Coding		
								1 ST	2 ND	3 RD
NLC322522T-R47□-N	0.47	5 / 10	40	25.2	450	0.07	1800	Yellow	Violet	Brown
NLC322522T-1R0□-N	1.0	5 / 10	20	7.96	100	0.08	1500	Brown	Black	Red
NLC322522T-1R2□-N	1.2	5 / 10	20	7.96	90	0.12	1400	Brown	Red	Red
NLC322522T-1R5□-N	1.5	5 / 10	20	7.96	80	0.13	1125	Brown	Green	Red
NLC322522T-1R8□-N	1.8	5 / 10	20	7.96	70	0.13	970	Brown	Gray	Red
NLC322522T-2R2□-N	2.2	5 / 10	20	7.96	68	0.13	970	Red	Red	Red
NLC322522T-2R7□-N	2.7	5 / 10	20	7.96	62	0.15	900	Red	Violet	Red
NLC322522T-3R3□-N	3.3	5 / 10	20	7.96	54	0.16	837	Orange	Orange	Red
NLC322522T-4R7□-N	4.7	5 / 10	20	7.96	43	0.23	675	Yellow	Violet	Red
NLC322522T-5R6□-N	5.6	5 / 10	20	7.96	36	0.26	620	Green	Blue	Red
NLC322522T-6R8□-N	6.8	5 / 10	20	7.96	33	0.27	600	Blue	Gray	Red
NLC322522T-8R2□-N	8.2	5 / 10	20	7.96	30	0.32	580	Gray	Red	Red
NLC322522T-100□-N	10	5 / 10	15	2.52	28	0.36	520	Brown	Black	Orange
NLC322522T-120□-N	12	5 / 10	15	2.52	25	0.50	500	Brown	Red	Orange
NLC322522T-150□-N	15	5 / 10	15	2.52	19	0.56	480	Brown	Green	Orange
NLC322522T-180□-N	18	5 / 10	15	2.52	17	0.67	330	Brown	Gray	Orange
NLC322522T-220□-N	22	5 / 10	15	2.52	16	0.77	310	Red	Red	Orange
NLC322522T-270□-N	27	5 / 10	15	2.52	13	1.00	280	Red	Violet	Orange
NLC322522T-330□-N	33	5 / 10	15	2.52	12	1.10	270	Orange	Orange	Orange
NLC322522T-390□-N	39	5 / 10	15	2.52	11	1.40	220	Orange	White	Orange
NLC322522T-470□-N	47	5 / 10	15	2.52	10	1.64	210	Yellow	Violet	Orange
NLC322522T-560□-N	56	5 / 10	15	2.52	9	2.49	189	Green	Blue	Orange
NLC322522T-680□-N	68	5 / 10	15	2.52	9	2.80	189	Blue	Gray	Orange
NLC322522T-820□-N	82	5 / 10	15	2.52	6	3.00	145	Gray	Red	Orange
NLC322522T-101□-N	100	5 / 10	15	0.796	6	3.70	145	Brown	Black	Yellow
NLC322522T-151□-N	150	5 / 10	15	0.796	5	6.10	120	Brown	Green	Yellow
NLC322522T-181□-N	180	5 / 10	15	0.796	4	8.00	105	Brown	Gray	Yellow
NLC322522T-221□-N	220	5 / 10	15	0.796	4	8.40	100	Red	Red	Yellow
NLC322522T-331□-N	330	5 / 10	15	0.796	3.5	12.3	80	Orange	Orange	Yellow
NLC322522T-391□-N	390	5 / 10	15	0.796	2.8	17.6	75	Orange	White	Yellow
NLC322522T-471□-N	470	5 / 10	15	0.796	2.8	22.0	75	Yellow	Violet	Yellow
NLC322522T-561□-N	560	5 / 10	15	0.796	2.5	23.0	65	Green	Blue	Yellow
NLC322522T-681□-N	680	5 / 10	15	0.796	2	28.0	65	Blue	Gray	Yellow

Note: When ordering, please specify tolerance code. Tolerance : J=±5% , K=±10%

- Operating temperature range - 25°C ~ 105°C(Including self - temperature rise)
- IDC for Inductance drop 10% from its value with current
- Measure Equipment :
 L & Q : Agilent HP4291A(over 1MHz)/Agilent HP4285A+Agilent HP16197A (under 1MHz)
 SRF : Agilent HP4291A
 RDC : HP4338B or Chroma 16502

Test Instruments : Agilent HP4291A Material/Impedance Analyzer

Typical L vs. Frequency

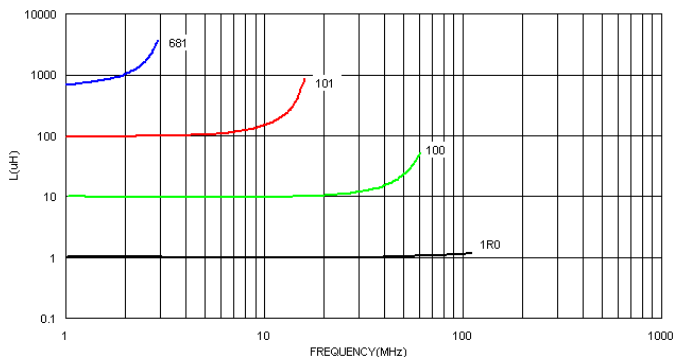

Typical Q vs. Frequency

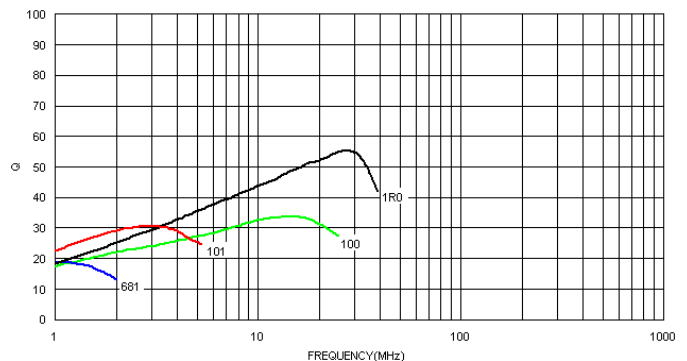

Please be sure to request approval specifications that provide further details of the products. Kindly note that the content of these specifications are subject to change or may be discontinued without advance notice. Please contact our sales department before ordering.

Packaging Specifications

Tape Dimensions

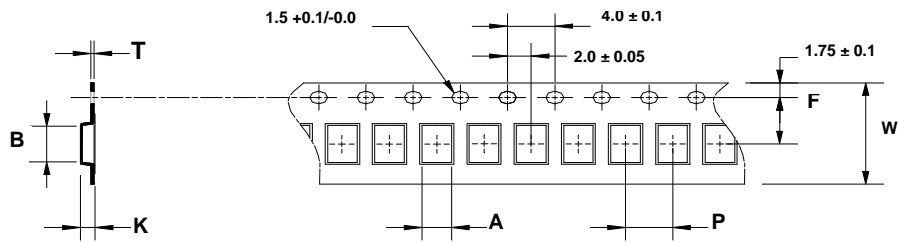

Trailer End

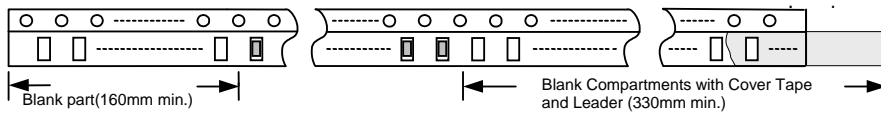

Reel Dimensions

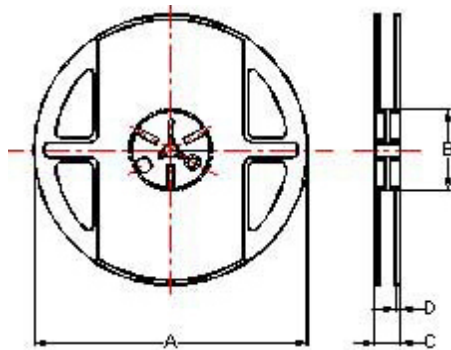

Dimensions in mm

TYPE	Tape Dimensions							Reel Dimensions				Quantity PCS / Reel
	A	B	T	W	P	F	K	A	B	C	D	
NLC252018	2.40	2.93	0.26	8	4	3.5	2.25	178	60	12	1.5	2000
NLC322522	2.85	3.58	0.25	12	4	5.5	2.55	178	60	16	1.4	2000

Electrical Characteristics

Part Number	Inductance (uH)	Tolerance (±%)	Test Frequency (MHz)	Q Typ.	SRF (MHz) Min	RDC (Ω±30%)	IDC (mA) Max	Color
LD0805-1R0□-N	1.0	10 / 20	7.96	18	100	0.10	800	Black
LD0805-1R5□-N	1.5	10 / 20	7.96	18	90	0.18	650	Brown
LD0805-2R2□-N	2.2	10 / 20	7.96	18	70	0.24	550	Red
LD0805-3R3□-N	3.3	10 / 20	7.96	18	55	0.30	450	Orange
LD0805-4R7□-N	4.7	10 / 20	7.96	18	50	0.47	360	Yellow
LD0805-6R8□-N	6.8	10 / 20	7.96	24	60	0.75	290	Green
LD0805-100□-N	10	10 / 20	2.52	18	25	0.90	290	Blue
LD0805-150□-N	15	10 / 20	2.52	18	25	1.60	230	Violet
LD0805-220□-N	22	10 / 20	2.52	18	17	1.95	190	Gray
LD0805-330□-N	33	10 / 20	2.52	17	15	2.60	120	White
LD0805-470□-N	47	10 / 20	2.52	17	11	3.90	95	Black
LD0805-680□-N	68	10 / 20	2.52	17	11	5.50	95	Brown
LD0805-101□-N	100	10 / 20	1.00	12	9	9.00	70	Red

Note: When ordering, please specify tolerance code. Tolerance: K=±10% , M=±20%

- Operating temperature range - 25°C ~ 105°C(Including self - temperature rise)
- IDC for Inductance drop 10% from its value with current
- Measure Equipment :
 L & Q : Agilent E4991A+Agilent HP16197A(over 1MHz)/Agilent HP4285A(under 1MHz)
 SRF : HP8753D/Agilent E4991A
 RDC : Chroma 16502
 IDC : HP4284A+HP42841A/HP4285A+HP42841A

Test Instruments : Agilent E4991A Material/Impedance Analyzer

Typical L vs. Frequency

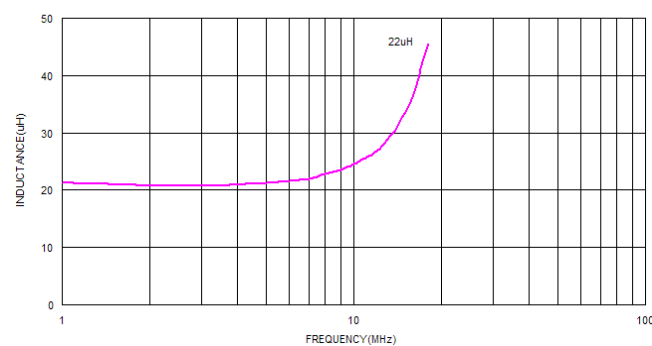

Typical Q vs. Frequency

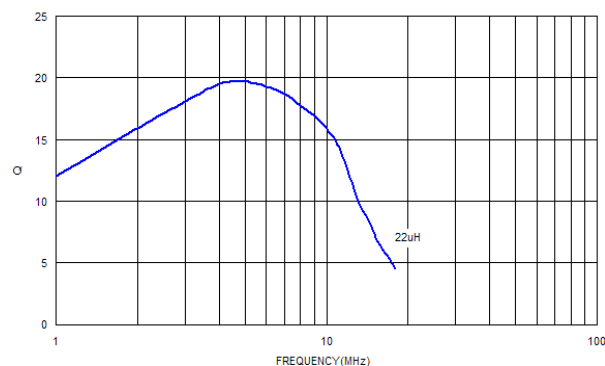

Please be sure to request approval specifications that provide further details of the products. Kindly note that the content of these specifications are subject to change or may be discontinued without advance notice. Please contact our sales department before ordering.

Electrical Characteristics

Part Number	Inductance (uH)	Tolerance (±%)	Test Frequency (MHz)	Q Typ.	SRF (MHz) Min	RDC (Ω) Max	IDC (mA) Typ.	Irms (mA) Max	Color		
									1 ST	2 ND	3 RD
LD1008-R90□-N	0.9	10	2.5	25	300	0.1	1400	1300	White	Black	Brown
LD1008-1R1□-N	1.1	10	2.5	24	275	0.105	1300	1200	Brown	Brown	Red
LD1008-1R3□-N	1.3	5 / 10	2.5	24	220	0.11	1200	1100	Brown	Orange	Red
LD1008-1R5□-N	1.5	5 / 10	2.5	22	210	0.125	1100	1000	Brown	Yellow	Red
LD1008-1R9□-N	1.9	5 / 10	2.5	22	165	0.14	1000	1000	Brown	White	Red
LD1008-2R2□-N	2.2	5 / 10	2.5	21	75	0.155	950	950	Red	Red	Red
LD1008-2R7□-N	2.7	5 / 10	2.5	22	57	0.19	800	900	Red	Violet	Red
LD1008-3R3□-N	3.3	5 / 10	2.5	21	54	0.21	750	800	Orange	Orange	Red
LD1008-3R9□-N	3.9	5 / 10	2.5	21	50	0.22	700	800	Orange	White	Red
LD1008-4R7□-N	4.7	5 / 10	2.5	27	48	0.435	700	650	Yellow	Violet	Red
LD1008-5R8□-N	5.8	5 / 10	2.5	21	33	0.28	550	750	Green	Gray	Red
LD1008-6R8□-N	6.8	5 / 10	2.5	20	28	0.315	500	700	Blue	Gray	Red
LD1008-8R2□-N	8.2	5 / 10	2.5	20	24	0.395	500	650	Gray	Red	Red
LD1008-100□-N	10	5 / 10	2.5	22	20	0.48	450	550	Brown	Black	Orange

Note: When ordering, please specify tolerance code. Tolerance: J=±5% , K=±10%

- Operating temperature range - 25°C ~ 105°C(Including self - temperature rise)
- IDC for Inductance drop 10% from its value with current
- Irms for a 40°C temperature rise from 25°C ambient with current
- Measure Equipment :
 L : Agilent E4991A/HP4287A+16197A
 SRF : HP8753D/Agilent E4991A
 RDC : Chroma 16502
 IDC : HP4284A+HP42841A/HP4285A+HP42841A

Test Instruments : Agilent E4991A Material/Impedance Analyzer

Typical L vs. Frequency

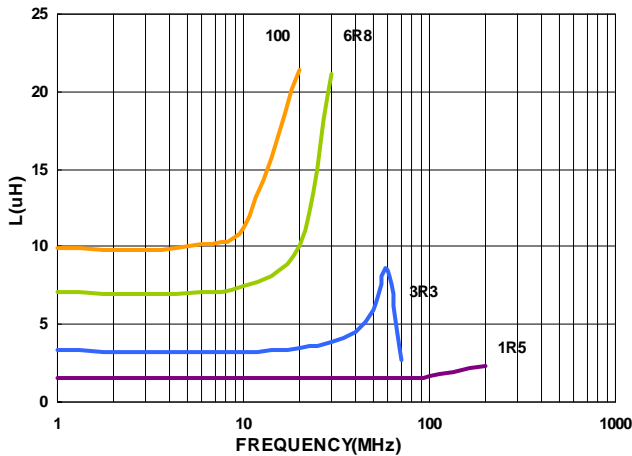

Typical Q vs. Frequency

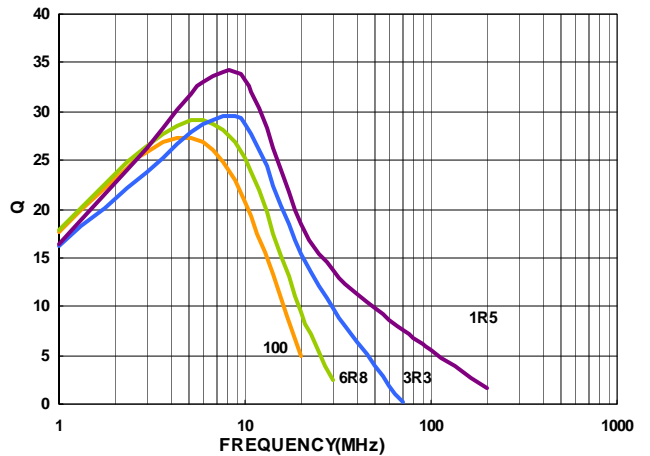

Please be sure to request approval specifications that provide further details of the products. Kindly note that the content of these specifications are subject to change or may be discontinued without advance notice. Please contact our sales department before ordering.

Packaging Specifications

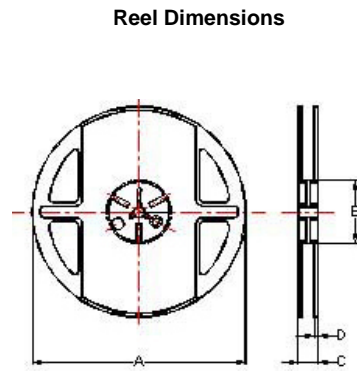
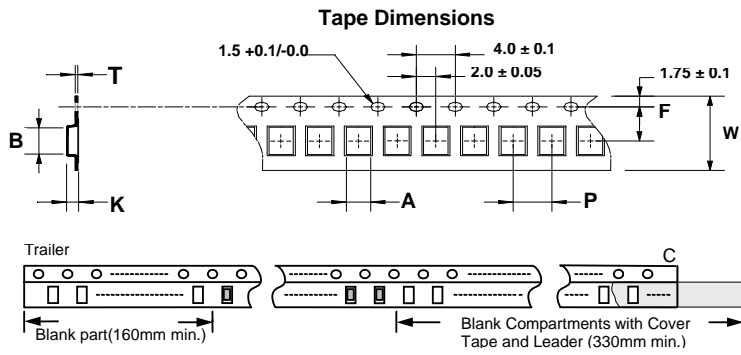

Dimensions in mm

TYPE	Tape Dimensions							Reel Dimensions				Quantity PCS / REEL
	A	B	T	W	P	F	K	A	B	C	D	
LD 0805	1.60	2.42	0.22	8	4	3.5	1.45	178	60	12	1.5	2000
LD 1008	2.40	2.93	0.26	8	4	3.5	2.25	178	60	12	1.5	2000

Electrical Characteristics

Part Number	Inductance (nH)	Tolerance (±%)	Test Frequency (MHz)	Q Typ.	SRF (MHz)Typ.	RDC (Ω)Max.	Irms (mA)Typ.
LS0201-2N2□-N	2.2	10	100	5	3000	0.09	1600
LS0201-6N8□-N	6.8	10 / 5	100	6	2400	0.11	950
LS0201-7N8□-N	7.8	10 / 5	100	7	2500	0.11	1050
LS0201-15N□-N	15	10 / 5	100	7	2300	0.12	750
LS0201-17N□-N	17	10 / 5	100	7	2400	0.13	750
LS0201-26N□-N	26	10 / 5	100	7	2200	0.20	750
LS0201-28N□-N	28	10 / 5	100	7	2400	0.2	700
LS0201-39N□-N	39	10 / 5	100	7	2300	0.24	580
LS0201-43N□-N	43	10 / 5	100	7	2200	0.24	600
LS0201-56N□-N	56	10 / 5	100	7	2200	0.26	550
LS0201-59N□-N	59	10 / 5	100	7	2200	0.26	500
LS0201-76N□-N	76	10 / 5	100	7	2000	0.30	500
LS0201-78N□-N	78	10 / 5	100	7	2000	0.30	500
LS0201-R10□-N	100	10 / 5	100	7	1500	0.41	430
LS0201-R13□-N	130	10 / 5	100	7	1500	0.44	400
LS0201-R16□-N	160	10 / 5	100	7	1400	0.71	350
LS0201-R20□-N	200	10 / 5	50	9	1400	0.95	260

Note: When ordering, please specify tolerance code. Tolerance : J=±5% , K=±10%

- Operating temperature range - 25°C ~ 105°C(Including self - temperature rise)
- I_{rms} for a 15°C temperature rise from 25°C ambient with current
- Measure Equipment :
 L & Q : Agilent E4991A+Agilent HP16197A
 SRF : Agilent E4991A
 RDC : Chroma 16502
 I_{rms} : HP4284A+HP42841A

Test Instruments : Agilent E4991A Material/Impedance Analyzer

Typical **L** vs. **F**requency

Typical **Q** vs. **F**requency

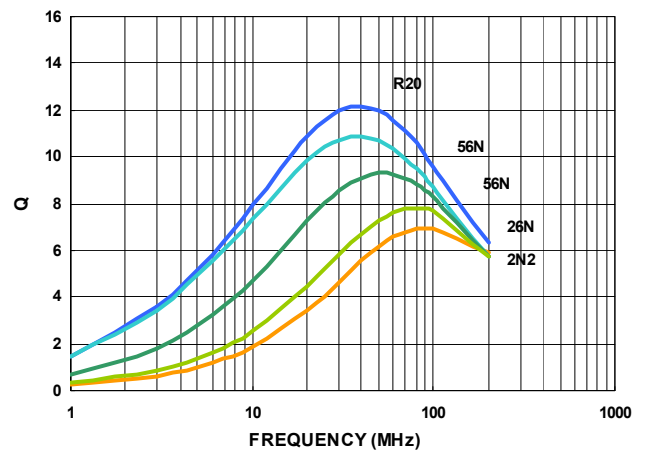
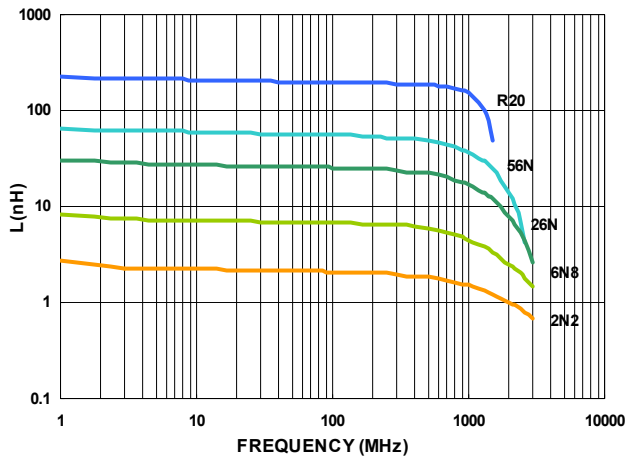

Please be sure to request approval specifications that provide further details of the products. Kindly note that the content of these specifications are subject to change or may be discontinued without advance notice. Please contact our sales department before ordering.

Electrical Characteristics

Part Number	Inductance (uH)	Tolerance (±%)	Test Frequency (MHz)	Q Typ.	SRF (MHz)Typ.	RDC (Ω) Max	Irms (mA)Typ.
LS0402-18N□-N	0.018	10 / 5	100	10	2600	0.055	1600
LS0402-20N□-N	0.020	10 / 5	100	10	2600	0.050	1600
LS0402-22N□-N	0.022	10	100	10	2500	0.072	1300
LS0402-33N□-N	0.033	10 / 5	100	10	2300	0.060	1400
LS0402-36N□-N	0.036	10 / 5	100	10	2300	0.092	1000
LS0402-39N□-N	0.039	10 / 5	100	10	2200	0.150	830
LS0402-51N□-N	0.051	10	100	10	1930	0.070	1100
LS0402-56N□-N	0.056	10	100	10	1900	0.125	900
LS0402-72N□-N	0.072	10 / 5	100	10	1650	0.100	900
LS0402-78N□-N	0.078	10 / 5	100	10	1600	0.190	850
LS0402-R10□-N	0.10	10	100	9	1400	0.160	900
LS0402-R14□-N	0.14	10 / 5	50	11	1220	0.260	540
LS0402-R18□-N	0.18	10	50	11	1150	0.330	560
LS0402-R20□-N	0.20	10 / 5	50	11	1000	0.440	400
LS0402-R22□-N	0.22	10 / 5	50	11	1150	0.530	380
LS0402-R25□-N	0.25	10 / 5	25	11	900	0.360	520
LS0402-R27□-N	0.27	10	25	11	860	0.550	360
LS0402-R30□-N	0.30	10 / 5	25	11	860	0.410	420
LS0402-R33□-N	0.33	10 / 5	7.9	11	820	0.680	350
LS0402-R36□-N	0.36	10 / 5	7.9	11	810	0.575	360
LS0402-R39□-N	0.39	10 / 5	7.9	11	760	0.890	300
LS0402-R42□-N	0.42	10 / 5	7.9	11	700	1.100	340
LS0402-R47□-N	0.47	10	7.9	11	650	0.730	310
LS0402-R56□-N	0.56	10 / 5	7.9	11	600	1.100	200

Note: When ordering, please specify tolerance code. Tolerance : J=±5% , K=±10%

- Operating temperature range - 25°C ~ 105°C(Including self - temperature rise)
- Irms for a 15°C temperature rise from 25°C ambient with current
- Measure Equipment :
 L & Q : Agilent E4991A+Agilent HP16197A
 SRF : Agilent E4991A
 RDC : Chroma 16502
 Irms : HP4284A+HP42841A

Test Instruments : Agilent E4991A Material/Impedance Analyzer

Typical **L** vs. **Frequency**

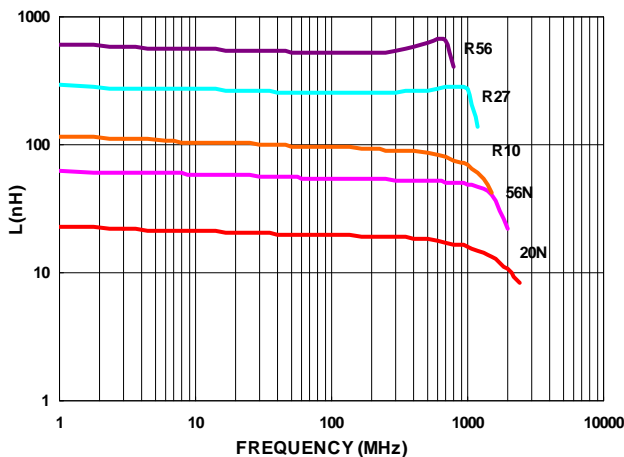

Typical **Q** vs. **Frequency**

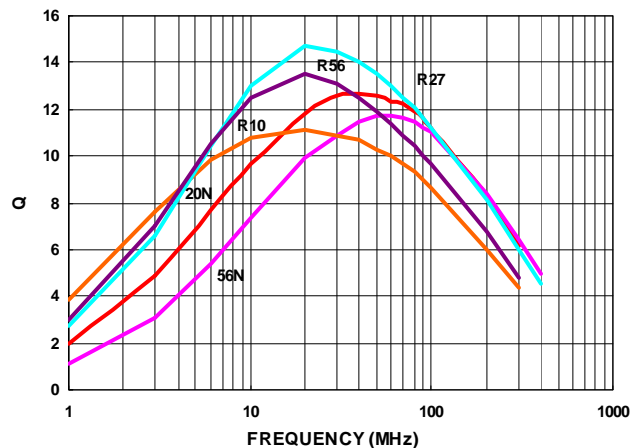

Please be sure to request approval specifications that provide further details of the products. Kindly note that the content of these specifications are subject to change or may be discontinued without advance notice. Please contact our sales department before ordering.

Electrical Characteristics

Part Number	Inductance (uH)	Tolerance (±%)	Test Frequency (MHz)	Q Typ.	SRF (MHz) Min	RDC (Ω) Max	IDC (mA)	Color
LS0603-47N□-N	0.047	10 / 5	7.9	17	1700	0.075	1500	Black
LS0603-72N□-N	0.072	10 / 5	7.9	17	1700	0.12	1500	Brown
LS0603-R10□-N	0.10	10 / 5	7.9	17	1650	0.13	1500	Red
LS0603-R12□-N	0.12	10 / 5	7.9	17	1350	0.15	1500	Orange
LS0603-R15□-N	0.15	10 / 5	7.9	17	1350	0.15	1450	Yellow
LS0603-R18□-N	0.18	10 / 5	7.9	17	1150	0.15	1400	Green
LS0603-R22□-N	0.22	10 / 5	7.9	17	1050	0.16	1350	Blue
LS0603-R24□-N	0.24	10 / 5	7.9	17	1050	0.19	1300	Violet
LS0603-R27□-N	0.27	10 / 5	7.9	17	1050	0.30	1050	Gray
LS0603-R33□-N	0.33	10 / 5	7.9	17	850	0.46	1200	White
LS0603-R39□-N	0.39	10 / 5	7.9	17	810	0.51	1200	Black
LS0603-R47□-N	0.47	10 / 5	7.9	17	720	0.62	1050	Brown
LS0603-R56□-N	0.56	10 / 5	7.9	17	600	0.44	850	Red
LS0603-R68□-N	0.68	10 / 5	7.9	17	600	0.52	850	Orange
LS0603-R78□-N	0.78	10 / 5	7.9	17	460	0.83	850	Yellow
LS0603-R82□-N	0.82	10 / 5	7.9	17	480	0.69	750	Green
LS0603-R91□-N	0.91	10 / 5	7.9	17	330	0.76	670	Black
LS0603-1R0□-N	1.0	10 / 5	7.9	18	310	0.81	600	Blue
LS0603-1R2□-N	1.2	10 / 5	7.9	17	270	0.87	550	Violet
LS0603-1R5□-N	1.5	10 / 5	7.9	17	270	1.06	540	Gray
LS0603-1R8□-N	1.8	10 / 5	7.9	17	230	1.10	520	White
LS0603-2R2□-N	2.2	10 / 5	7.9	17	140	1.20	500	Black
LS0603-2R7□-N	2.7	10 / 5	7.9	17	105	1.50	480	Brown
LS0603-3R3□-N	3.3	10 / 5	7.9	17	84	1.50	440	Red
LS0603-3R9□-N	3.9	10 / 5	7.9	17	80	1.60	430	Orange
LS0603-4R7□-N	4.7	10 / 5	7.9	18	69	2.10	420	Yellow
LS0603-5R6□-N	5.6	10 / 5	7.9	18	65	2.60	400	Green
LS0603-6R8□-N	6.8	10 / 5	7.9	19	55	3.10	400	Blue
LS0603-7R8□-N	7.8	10 / 5	7.9	17	47	3.50	400	Violet
LS0603-8R2□-N	8.2	10 / 5	7.9	17	42	3.80	400	Gray
LS0603-100□-N	10	10 / 5	7.9	19	40	4.80	300	White

Note: When ordering, please specify tolerance code. Tolerance : J=±5% , K=±10%

- Operating temperature range - 25°C ~ 105°C(Including self - temperature rise)
- IDC for Inductance drop 10% from its value without current
- Measure Equipment :
 - L & Q : Agilent E4991A+Agilent HP16197A
 - SRF : Agilent HP8753D/Agilent E4991A
 - RDC : Chroma 16502
 - IDC : HP4284A+HP42841A/HP4285A+HP42841A

Test Instruments : Agilent E4991A Material/Impedance Analyzer

Typical L vs. Frequency

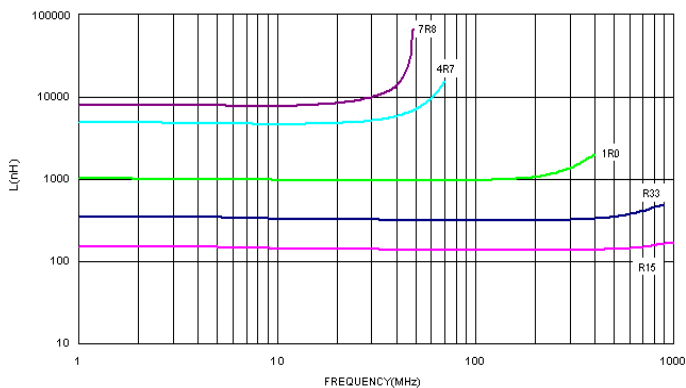

Typical Q vs. Frequency

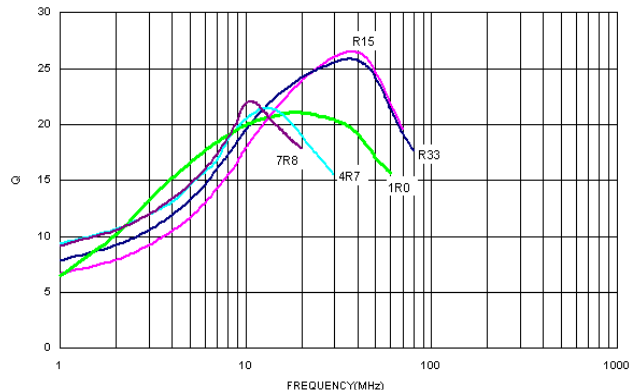

Please be sure to request approval specifications that provide further details of the products. Kindly note that the content of these specifications are subject to change or may be discontinued without advance notice. Please contact our sales department before ordering.

Electrical Characteristics

Part Number	Inductance (uH)	Tolerance (±%)	Test Frequency (MHz)	Q Typ.	SRF (MHz) Min	RDC (Ω) Max	IDC (mA)	Color
LS0805-78N□-N	0.078	10 / 5	7.9	19	1440	0.06	2000	Black
LS0805-90N□-N	0.090	10 / 5	7.9	19	1200	0.07	2000	Red
LS0805-R11□-N	0.11	10 / 5	7.9	19	1200	0.07	2000	Brown
LS0805-R47□-N	0.47	10 / 5	7.9	19	480	0.40	800	Red
LS0805-R56□-N	0.56	10 / 5	7.9	35	480	0.40	800	Yellow
LS0805-R68□-N	0.68	10 / 5	7.9	20	480	0.40	800	Orange
LS0805-R91□-N	0.91	10 / 5	7.9	20	400	0.69	700	Yellow
LS0805-1R0□-N	1.0	10 / 5	7.9	20	400	0.69	700	Yellow
LS0805-1R2□-N	1.2	10 / 5	7.9	20	330	0.83	700	Red
LS0805-1R5□-N	1.5	10 / 5	7.9	20	330	0.83	700	Green
LS0805-1R8□-N	1.8	10 / 5	7.9	20	300	1.00	650	Blue
LS0805-2R2□-N	2.2	10 / 5	7.9	20	250	1.10	650	Violet
LS0805-2R7□-N	2.7	10 / 5	7.9	23	200	1.25	650	Gray
LS0805-3R3□-N	3.3	10 / 5	7.9	23	160	1.45	650	White
LS0805-3R9□-N	3.9	10 / 5	7.9	23	90	1.50	600	Black
LS0805-4R7□-N	4.7	10 / 5	7.9	20	70	1.60	530	Brown
LS0805-5R6□-N	5.6	10 / 5	7.9	20	65	1.70	500	Red
LS0805-6R8□-N	6.8	10 / 5	7.9	20	45	1.95	470	Orange
LS0805-8R2□-N	8.2	10 / 5	2.5	16	45	2.10	450	Yellow
LS0805-100□-N	10	10 / 5	2.5	16	40	2.40	400	Green
LS0805-120□-N	12	10 / 5	2.5	16	38	3.20	360	Red
LS0805-150□-N	15	10 / 5	2.5	16	30	3.55	350	Blue
LS0805-180□-N	18	10 / 5	2.5	16	25	4.90	300	Orange
LS0805-220□-N	22	10 / 5	2.5	16	20	5.45	270	Violet
LS0805-270□-N	27	10 / 5	2.5	16	19	7.80	240	Gray
LS0805-330□-N	33	10 / 5	2.5	16	16	9.50	210	White
LS0805-470□-N	47	10 / 5	2.5	16	15	14.50	180	Brown

Note: When ordering, please specify tolerance code. Tolerance : J=±5% , K=±10%

- Operating temperature range - 25°C ~ 105°C(Including self - temperature rise)
- IDC for Inductance drop 10% from its value without current
- Measure Equipment :
 L & Q : Agilent E4991A+Agilent HP16197A
 SRF : Agilent E4991A
 RDC : HP4338B or Chroma 16502
 IDC : HP4284A+HP42841A/HP4285A+HP42841A

Test Instruments : Agilent E4991A Material/Impedance Analyzer

Typical L vs. Frequency

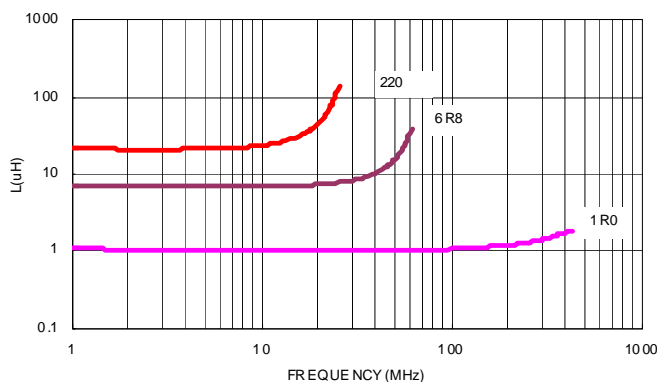

Typical Q vs. Frequency

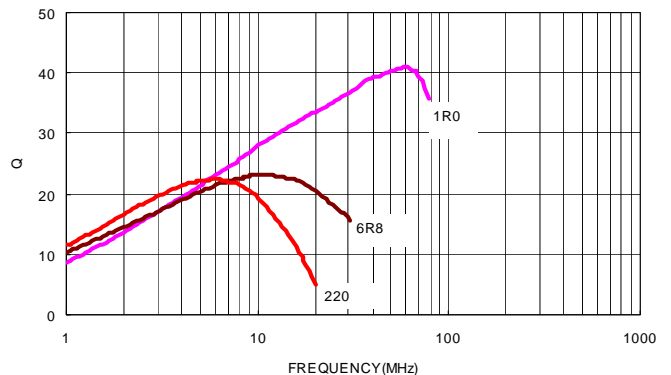

Please be sure to request approval specifications that provide further details of the products. Kindly note that the content of these specifications are subject to change or may be discontinued without advance notice. Please contact our sales department before ordering.

Electrical Characteristics

Part Number	Inductance (uH)	Tolerance (±%)	Test Frequency (MHz)	Q Typ.	Test Frequency (MHz)	SRF (MHz) Min	RDC (Ω) Max	IDC (mA)	Color Coding		
									1 ST	2 ND	3 RD
LS1008-1R2□-N	1.2	10 / 5	7.9	55	50	350	0.50	1200	Brown	Red	Red
LS1008-1R5□-N	1.5	10 / 5	7.9	58	50	300	0.65	1200	Brown	Green	Red
LS1008-1R8□-N	1.8	10 / 5	7.9	54	50	280	0.75	1050	Brown	Gray	Red
LS1008-2R2□-N	2.2	10 / 5	7.9	48	50	250	0.90	950	Red	Red	Red
LS1008-2R7□-N	2.7	10 / 5	7.9	51	50	200	1.00	950	Red	Violet	Red
LS1008-3R3□-N	3.3	10 / 5	7.9	58	50	200	1.15	900	Orange	Orange	Red
LS1008-3R9□-N	3.9	10 / 5	7.9	37	7.9	170	1.25	850	Orange	White	Red
LS1008-4R7□-N	4.7	10 / 5	7.9	37	7.9	130	1.35	700	Yellow	Violet	Red
LS1008-5R6□-N	5.6	10 / 5	7.9	36	7.9	110	1.45	700	Green	Blue	Red
LS1008-6R8□-N	6.8	10 / 5	7.9	33	7.9	105	1.60	600	Blue	Gray	Red
LS1008-8R2□-N	8.2	10 / 5	7.9	40	7.9	90	1.80	550	Gray	Red	Red
LS1008-100□-N	10	10 / 5	7.9	40	7.9	85	2.40	500	Brown	Black	Orange
LS1008-120□-N	12	10 / 5	7.9	40	7.9	80	2.40	450	Brown	Red	Orange
LS1008-150□-N	15	10 / 5	7.9	35	7.9	38	2.40	450	Brown	Green	Orange
LS1008-390□-N	39	10 / 5	2.5	33	2.5	26	10	170	Orange	White	Orange

Note: When ordering, please specify tolerance code. Tolerance : J=±5% , K=±10%

- Operating temperature range - 25°C ~ 105°C(Including self - temperature rise)
- IDC for Inductance drop 10% from its value without current
- Measure Equipment :
 L & Q : Agilent E4991A+Agilent HP16197A
 SRF : Agilent E4991A
 RDC : HP4338B or Chroma 16502
 IDC : HP4284A+HP42841A/HP4285A+HP42841A

Test Instruments : Agilent E4991A Material/Impedance Analyzer

Typical L vs. Frequency

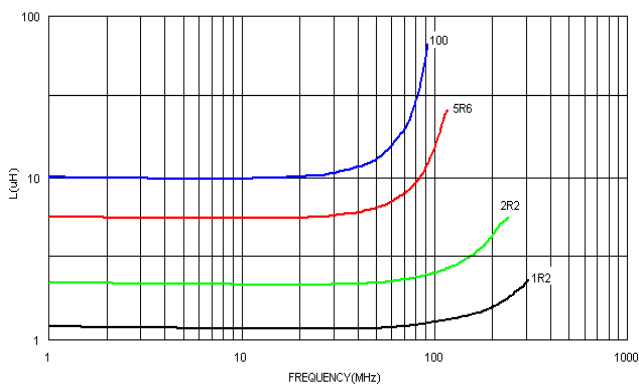

Typical Q vs. Frequency

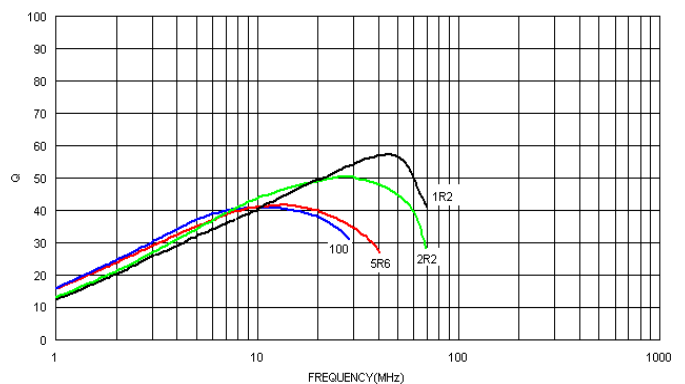

Please be sure to request approval specifications that provide further details of the products. Kindly note that the content of these specifications are subject to change or may be discontinued without advance notice. Please contact our sales department before ordering.

Packaging Specifications

Tape Dimensions

Tape Material

Figure 1

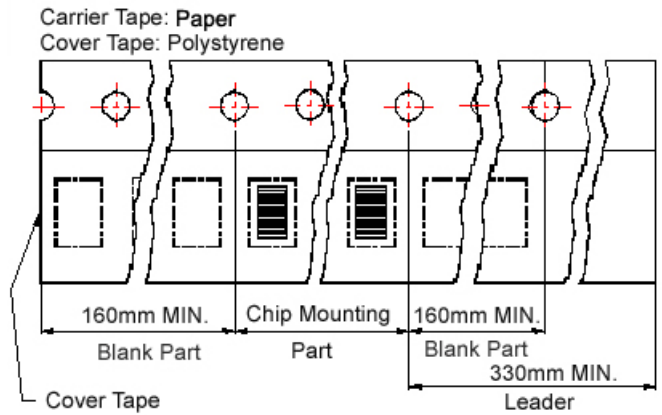
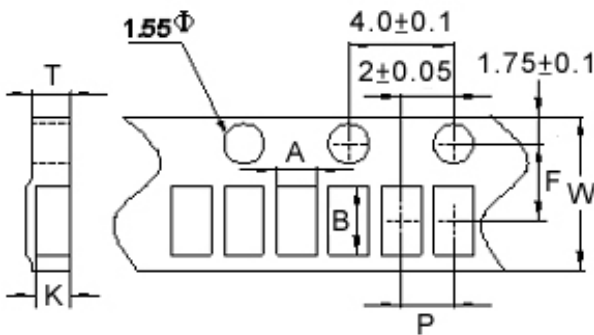

Figure 2

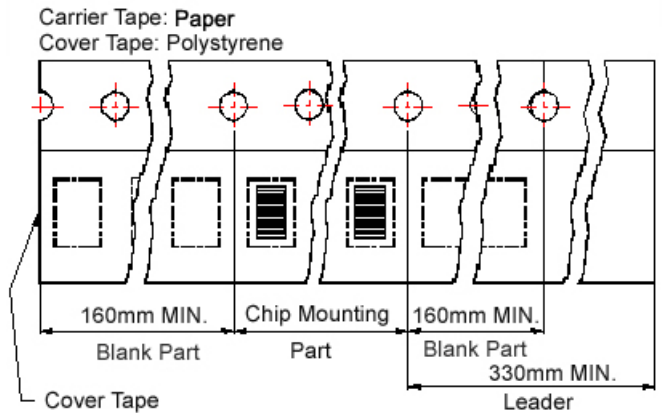
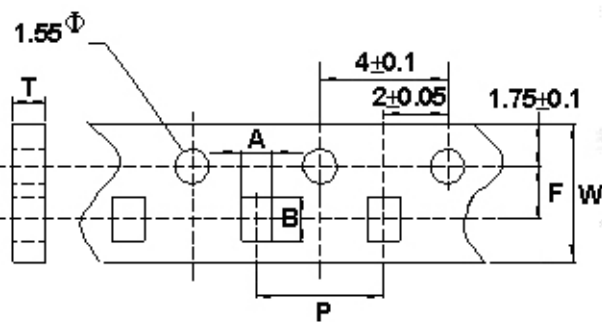
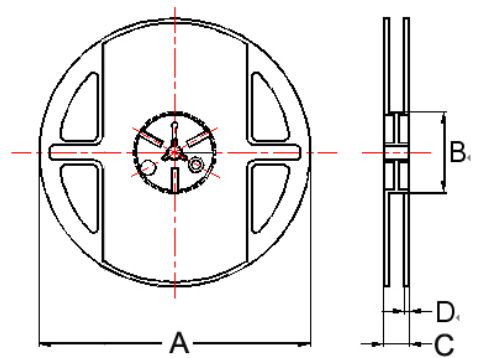
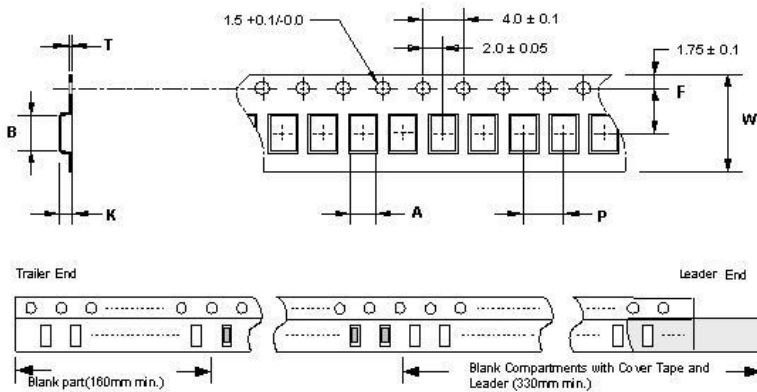

Figure 3

Reel Dimensions



Dimensions in mm

TYPE	Fig.	Tape Dimensions							Reel Dimensions				Quantity PCS / REEL
		A	B	T	W	P	F	K	A	B	C	D	
LS0201	1	0.44	0.62	0.61	8	2	3.5	0.46	178	60	12	1.5	4000
LS0402	1	0.67	1.20	0.75	8	2	3.5	0.59	178	60	12	1.5	4000
LS0603(47N~1R8)	2	1.20	1.80	1.05	8	4	3.5	-	178	60	12	1.5	4000
LS0603(2R2~100)	2	1.23	1.9	1.05	8	4	3.5	-	178	60	12	1.5	4000
LS0805	3	1.60	2.42	0.22	8	4	3.5	1.45	178	60	12	1.5	2000
LS1008	3	2.40	2.93	0.26	8	4	3.5	2.25	178	60	12	1.5	2000

PS Series



PS series is the newest shielding type ferrite wire wound chip inductor. This wire wound ferrite construction provides extremely low DCR and high rating current.

Features

- RoHS compliant
- Shielded power inductors
- Specially designed ferrite cover provides magnetic shielding
- Best possible surface for pick and place handling

Applications

- Notebook computers
- PC cards
- Wireless communication
- Handheld devices

Product Identification

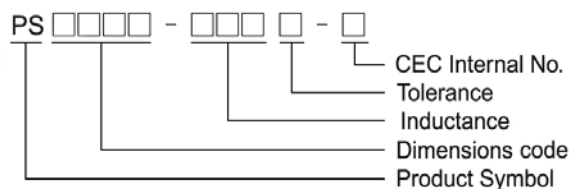

Shape and Dimensions / Recommended Pattern

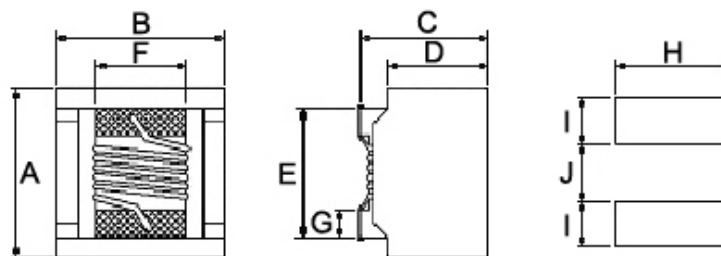

Dimensions in mm

TYPE	A Max	B Max	C Max	D	E	F	G	H	I	J	
PS1008	3.81	3.81	2.94	3.05	2.20	2.54	2.03	0.51	2.54	1.02	1.27

C : 2.94⁺⁰ mm at 1R0~331/ 561~102
 3.05⁺⁰ mm at 471

Electrical Characteristics

Part Number	Inductance (μ H)	Tolerance ($\pm\%$)	Test Frequency (MHz)	Q Typ.	Test Frequency (MHz)	SRF (MHz) Typ.	RDC (Ω) Max	IDC (A)
PS1008-1R0□-N	1.0	20 / 10	0.1	26	1	344	0.05	3.0
PS1008-1R5□-N	1.5	20 / 10	0.1	26	1	260	0.08	2.8
PS1008-1R8□-N	1.8	20 / 10	0.1	28	1	225	0.09	2.1
PS1008-2R7□-N	2.7	20 / 10	0.1	30	1	185	0.14	1.5
PS1008-3R9□-N	3.9	20 / 10	0.1	30	1	172	0.29	1.2
PS1008-4R7□-N	4.7	20 / 10	0.1	30	1	157	0.35	1.1
PS1008-5R6□-N	5.6	20 / 10	0.1	30	1	150	0.39	1.1
PS1008-6R8□-N	6.8	20 / 10	0.1	30	1	110	0.58	0.9
PS1008-100□-N	10	20 / 10	0.1	30	1	95	0.75	0.82
PS1008-150□-N	15	20 / 10	0.1	30	1	75	1.15	0.70
PS1008-220□-N	22	20 / 10	0.1	33	1	30	1.40	0.65
PS1008-330□-N	33	20 / 10	0.1	33	1	21	1.61	0.52
PS1008-390□-N	39	20 / 10	0.1	33	1	18	1.85	0.46
PS1008-470□-N	47	20 / 10	0.1	33	1	15	2.20	0.43
PS1008-680□-N	68	20 / 10	0.1	33	1	12	3.80	0.33
PS1008-820□-N	82	20 / 10	0.1	33	1	10	4.30	0.32
PS1008-101□-N	100	20 / 10	0.1	33	1	8	4.80	0.31
PS1008-121□-N	120	20 / 10	0.1	33	1	8	5.0	0.25
PS1008-151□-N	150	20 / 10	0.1	33	1	5.8	6.5	0.24
PS1008-221□-N	220	20 / 10	0.1	33	1	5.5	12.0	0.22
PS1008-331□-N	330	20 / 10	0.1	33	1	3.8	17.0	0.20
PS1008-471□-N	470	20 / 10	0.1	33	1	3.1	19.0	0.16
PS1008-561□-N	560	20 / 10	0.1	33	1	2.8	18.4	0.13
PS1008-681□-N	680	20 / 10	0.1	33	1	2.5	24.0	0.12
PS1008-821□-N	820	20 / 10	0.1	23	1	2.0	26.0	0.10
PS1008-102□-N	1000	20 / 10	0.1	20	1	1.5	29.2	0.10

Note: When ordering, please specify tolerance code. Tolerance : K= \pm 10% , M= \pm 20%

- Operating temperature range - 40°C ~ 105°C(Including self - temperature rise)
- IDC for Inductance drop 10% from its value without current
- Measure Equipment :
 - L : Agilent HP4285A
 - Q : Agilent HP4291A
 - SRF : Agilent HP4291A
 - RDC : HP4338B or Chroma 16502
 - IDC : CHEN HWA1061+301A

Packaging Specifications

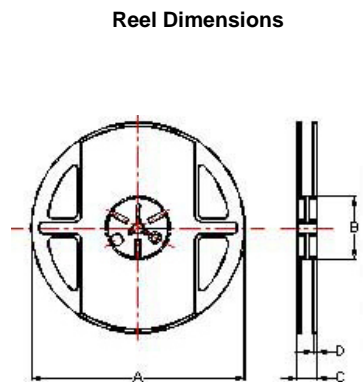
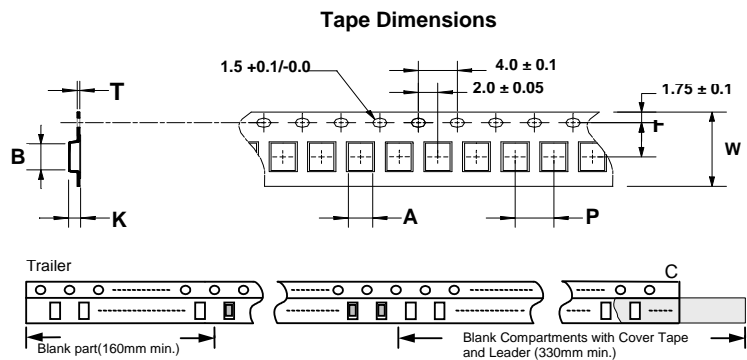

Dimensions in mm

TYPE	Tape Dimensions							Reel Dimensions				Quantity PCS / REEL
	A	B	T	W	P	F	K	A	B	C	D	
PS 1008	3.85	3.85	0.25	12	8	5.5	2.85	178	60	16	1.4	750

LT Series



LT series is the newest open type ferrite wire wound chip inductors. This wire wound ferrite construction supports thinness for low profile application.

Features

- RoHS compliant
- At just 1.05mm in height, these are one of Chilisin's lowest profile surface mount inductors
- Wire wound ferrite design supports lower Rdc, higher current ratings and exceptional Q values
- Inductance values from 0.12 to 39uH

Applications

- Boost IC for tiny panels of C-STN, TFT-LCD and OLED in backlight
- Buck/Boost IC using in DC to DC converter
- LC filter in power as well as signal lines

Product Identification

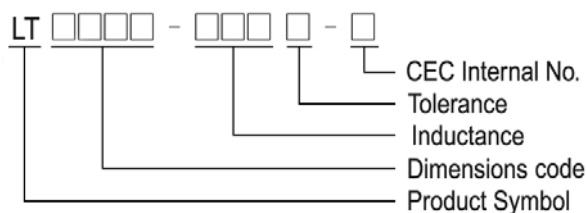

Shape and Dimensions / Recommended Pattern

LT0805/1210

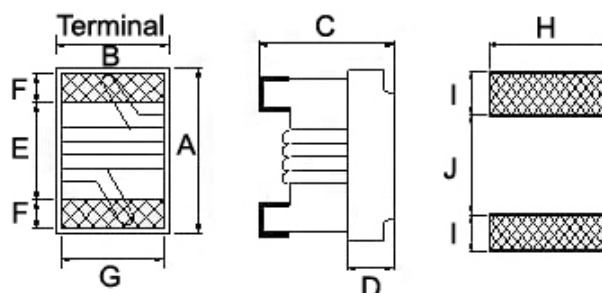

Dimensions in mm

TYPE	A Max	B Max	C Max	D Ref	E	F	G	H	I	J
LT0805	2.40	1.85	1.05	0.70	1.02	0.50	1.27	1.78	1.02	0.76
LT1210	3.75	3.10	1.05	0.65	1.80	0.65	2.35	2.70	1.00	2.00

Electrical Characteristics

Part Number	Inductance (μ H)	Tolerance (\pm %)	Test Frequency (MHz)	Q Min	SRF (MHz) Min	RDC (Ω) Max	IDC (mA) Max	Color
LT0805-R12□-N	0.12	10 / 5	25.2	22	1500	0.33	1200	Black
LT0805-R15□-N	0.15	10 / 5	25.2	22	1100	0.33	1200	Brown
LT0805-R18□-N	0.18	10 / 5	25.2	22	1100	0.36	1100	Red
LT0805-R22□-N	0.22	10 / 5	25.2	22	1100	0.39	1100	Orange
LT0805-R27□-N	0.27	10 / 5	25.2	22	950	0.43	1050	Yellow
LT0805-R33□-N	0.33	10 / 5	25.2	22	650	0.46	900	Green
LT0805-R39□-N	0.39	10 / 5	25.2	22	640	0.48	850	Blue
LT0805-R47□-N	0.47	10 / 5	25.2	22	570	0.65	800	Violet
LT0805-R56□-N	0.56	10 / 5	25.2	22	540	0.67	770	Gray
LT0805-R68□-N	0.68	10 / 5	25.2	22	500	0.73	750	White
LT0805-R82□-N	0.82	10 / 5	25.2	22	480	0.85	730	Black
LT0805-1R0□-N	1.0	10 / 5	7.96	15	470	0.87	720	Brown
LT0805-1R2□-N	1.2	10 / 5	7.96	15	450	0.97	690	Red
LT0805-1R5□-N	1.5	10 / 5	7.96	15	400	1.10	670	Orange
LT0805-1R8□-N	1.8	10 / 5	7.96	15	340	1.15	650	Yellow
LT0805-2R2□-N	2.2	10 / 5	7.96	15	265	1.28	630	Green
LT0805-2R7□-N	2.7	10 / 5	7.96	15	235	1.40	620	Blue
LT0805-3R3□-N	3.3	10 / 5	7.96	15	190	1.62	580	Violet
LT0805-3R9□-N	3.9	10 / 5	7.96	15	180	1.75	570	Gray
LT0805-4R7□-N	4.7	10 / 5	7.96	13	160	1.95	550	White
LT0805-5R6□-N	5.6	10 / 5	7.96	15	120	2.14	540	Black
LT0805-6R8□-N	6.8	10 / 5	7.96	15	45	2.28	520	Brown
LT0805-8R2□-N	8.2	10 / 5	7.96	15	42	2.55	500	Red
LT0805-100□-N	10	10 / 5	2.52	10	38	2.70	450	Orange
LT0805-120□-N	12	10 / 5	2.52	10	33	4.20	400	Yellow
LT0805-150□-N	15	10 / 5	2.52	10	30	4.80	380	Green
LT0805-180□-N	18	10 / 5	2.52	10	25	5.74	300	Blue
LT0805-220□-N	22	10 / 5	2.52	10	23	7.75	260	Violet
LT0805-270□-N	27	10 / 5	2.52	10	21	10.0	230	Gray
LT0805-330□-N	33	10 / 5	2.52	10	16	13.5	200	White
LT0805-390□-N	39	10 / 5	2.52	10	15	16.0	190	Black

Note: When ordering, please specify tolerance code. Tolerance : J= \pm 5% , K= \pm 10%

- Operating temperature range - 25°C ~ 105°C(Including self - temperature rise)
- IDC for Inductance drop 10% from its value without current
- Measure Equipment :
L & Q : Agilent E4991A+Agilent HP16197A
SRF : Agilent E4991A
RDC : HP4338B or Chroma 16502
IDC : HP4284A+HP42841A/HP4285A+HP42841A

Electrical Characteristics

Part Number	Inductance (uH)	Tolerance (±%)	Test Frequency (MHz)	Q Typ.	SRF (MHz) Min	RDC (Ω) Max	IDC (mA) Max	Color Coding		
								1 ST	2 ND	3 RD
LT1210-1R0□-N	1.0	10 / 5	7.96	20	350	0.45	1500	Brown	Black	Red
LT1210-1R2□-N	1.2	10 / 5	7.96	20	330	0.49	1300	Brown	Red	Red
LT1210-1R5□-N	1.5	10 / 5	7.96	20	310	0.68	1200	Brown	Green	Red
LT1210-1R8□-N	1.8	10 / 5	7.96	20	290	0.72	1150	Brown	Gray	Red
LT1210-2R2□-N	2.2	10 / 5	7.96	20	270	1.02	1020	Red	Red	Red
LT1210-2R7□-N	2.7	10 / 5	7.96	20	265	1.15	1000	Red	Violet	Red
LT1210-3R3□-N	3.3	10 / 5	7.96	20	195	1.20	970	Orange	Orange	Red
LT1210-3R9□-N	3.9	10 / 5	7.96	20	170	1.35	910	Orange	White	Red
LT1210-4R7□-N	4.7	10 / 5	7.96	20	155	1.48	880	Yellow	Violet	Red
LT1210-5R6□-N	5.6	10 / 5	7.96	20	125	1.65	820	Green	Blue	Red
LT1210-6R8□-N	6.8	10 / 5	7.96	20	110	1.68	750	Blue	Gray	Red
LT1210-8R2□-N	8.2	10 / 5	7.96	20	100	1.88	700	Gray	Red	Red
LT1210-100□-N	10	10 / 5	2.52	16	85	2.90	610	Brown	Black	Orange
LT1210-120□-N	12	10 / 5	2.52	16	70	3.05	540	Brown	Red	Orange
LT1210-150□-N	15	10 / 5	2.52	16	65	3.45	500	Brown	Green	Orange
LT1210-180□-N	18	10 / 5	2.52	16	55	4.79	420	Brown	Gray	Orange
LT1210-220□-N	22	10 / 5	2.52	16	50	5.20	350	Red	Red	Orange

Note: When ordering, please specify tolerance code. Tolerance : J=±5% , K=±10%

- Operating temperature range - 25°C ~ 105°C(Including self - temperature rise)
- IDC for Inductance drop 10% from its value without current
- Measure Equipment :
 L & Q : Agilent E4991A+Agilent HP16197A
 SRF : Agilent E4991A
 RDC : HP4338B or Chroma 16502
 IDC : HP4284A+HP42841A/HP4285A+HP42841A

Packaging Specifications

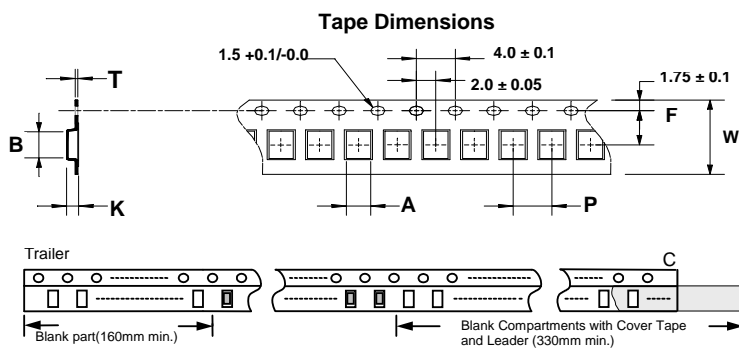

Reel Dimensions

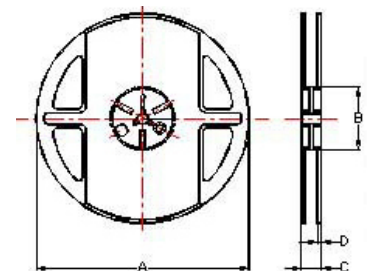

Dimensions in mm

TYPE	Tape Dimensions							Reel Dimensions				Quantity PCS / REEL
	A	B	T	W	P	F	K	A	B	C	D	
LT0805	1.85	2.45	0.23	8	4	3.5	1.0	178	60	12	1.5	2000
LT1210	3.05	3.70	0.25	12	4	5.5	1.1	178	60	12	1.5	2000

Please be sure to request approval specifications that provide further details of the products. Kindly note that the content of these specifications are subject to change or may be discontinued without advance notice. Please contact our sales department before ordering.

SQV Series



SQV Series comes in 2 sizes with wide inductance range, high Q value at high frequencies and low DC resistance.

Features

- RoHS compliant
- Miniature chip inductors wound on a special ferrite core
- High Q value at high frequencies and low DC resistance
- Wide inductance range
- Excellent solder heat resistance
- Both flow and reflow soldering methods can be employed

Applications

- Personal, cordless phone
- High Freq. communication products
- GPS (global position system)
- Personal computers

Product Identification

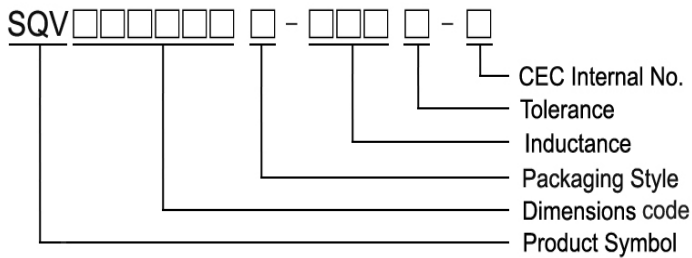

- Packaging: T : Tape and Reel

Shape and Dimensions

SQV322520

SQV453226

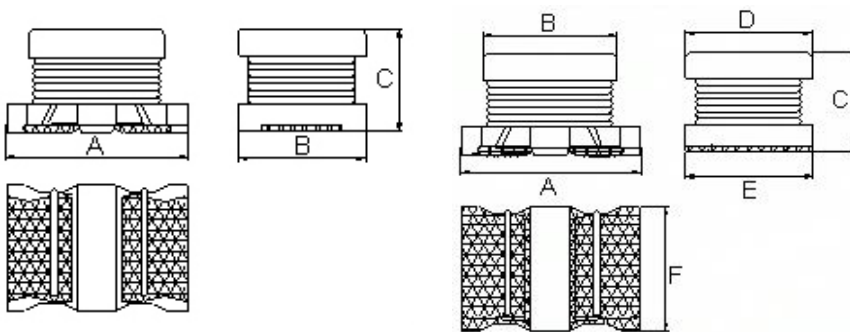

Dimensions in mm

TYPE	A	B	C	D	E	F
SQV322520	3.2±0.3	2.5±0.2	2.0±0.2	-	-	-
SQV453226	4.5±0.3	3.6±0.2	2.6±0.2	3.2±0.2	3.2±0.2	3.2±0.2

Recommended Pattern

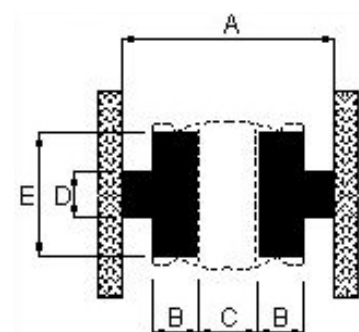

Dimensions in mm

TYPE	A	B	C	D	E
SQV322520	5.5	1.0	1.3	1.0	2.0
SQV453226	7.5	1.5	1.5	1.5	3.0

Electrical Characteristics

Part Number	Inductance (uH)	Tolerance (±%)	Test Frequency (MHz)	Q Min	Test Frequency (MHz)	SRF (MHz) Min	RDC (Ω) Max	Rated current (mA)
SQV322520T-R47□-N	0.47	20	1	20	1	150	0.06	1100
SQV322520T-R82□-N	0.82	20	1	20	1	120	0.25	450
SQV322520T-1R0□-N	1.0	20	1	20	1	100	0.50	445
SQV322520T-1R2□-N	1.2	20	1	20	1	100	0.60	425
SQV322520T-1R5□-N	1.5	20 / 10	1	20	1	75	0.60	400
SQV322520T-1R8□-N	1.8	20 / 10	1	20	1	60	0.70	390
SQV322520T-2R2□-N	2.2	20 / 10	1	20	1	50	0.80	370
SQV322520T-2R7□-N	2.7	20 / 10	1	20	1	43	0.90	320
SQV322520T-3R3□-N	3.3	20 / 10	1	20	1	38	1.0	300
SQV322520T-3R9□-N	3.9	20 / 10	1	20	1	35	1.1	290
SQV322520T-4R7□-N	4.7	20 / 10	1	20	1	31	1.2	270
SQV322520T-5R6□-N	5.6	20 / 10	1	20	1	28	1.3	250
SQV322520T-6R8□-N	6.8	20 / 10	1	20	1	25	1.5	240
SQV322520T-8R2□-N	8.2	20 / 10	1	20	1	23	1.6	225
SQV322520T-100□-N	10	20 / 10	1	35	1	20	1.8	190
SQV322520T-120□-N	12	20 / 10	1	35	1	18	2.0	180
SQV322520T-150□-N	15	20 / 10	1	35	1	16	2.2	170
SQV322520T-180□-N	18	20 / 10	1	35	1	15	2.5	165
SQV322520T-220□-N	22	20 / 10 / 5	1	35	1	14	2.8	150
SQV322520T-270□-N	27	20 / 10	1	35	1	13	3.1	125
SQV322520T-330□-N	33	20 / 10	1	40	1	12	3.5	115
SQV322520T-390□-N	39	20 / 10	1	40	1	11	3.9	110
SQV322520T-470□-N	47	20 / 10	1	40	1	11	4.3	100
SQV322520T-560□-N	56	20 / 10	1	40	1	10.0	4.9	85
SQV322520T-680□-N	68	20 / 10	1	40	1	9.0	5.5	80
SQV322520T-820□-N	82	20 / 10 / 5	1	40	1	8.5	6.2	70
SQV322520T-101□-N	100	20 / 10 / 5	1	40	0.796	8.0	7.0	80
SQV322520T-121□-N	120	20 / 10	1	40	0.796	7.5	8.0	75
SQV322520T-151□-N	150	20 / 10	1	40	0.796	7.0	9.3	70
SQV322520T-181□-N	180	20 / 10	1	40	0.796	6.0	10.2	65
SQV322520T-221□-N	220	20 / 10	1	40	0.796	5.5	11.8	65
SQV322520T-271□-N	270	20 / 10	1	40	0.796	5.0	12.5	65
SQV322520T-331□-N	330	20 / 10	1	40	0.796	5.0	13.0	65
SQV322520T-391□-N	390	20 / 10	1	50	0.796	5.0	22.0	50
SQV322520T-471□-N	470	20 / 10	0.001	50	0.796	5.0	25.0	45
SQV322520T-561□-N	560	20 / 10 / 5	0.001	50	0.796	2.0	28.0	40

Note: When ordering, please specify tolerance code. Tolerance : J=±5% , K=±10% , M=±20%

- Operating temperature range - 40°C ~ 125°C(Including self - temperature rise)
- Rated Current : Self temperature rise shall be limited to 35°C Max Inductance drop 10% typ.
- Measure Equipment :
 - L : Agilent HP4285A(1MHz)/Agilent HP4192A(1kHz)
 - Q : Agilent HP4285A
 - SRF : Agilent HP4286A
 - RDC : HP4338B or Chroma 16502
 - Rated Current : HP4284A+HP42841A

Please be sure to request approval specifications that provide further details of the products. Kindly note that the content of these specifications are subject to change or may be discontinued without advance notice. Please contact our sales department before ordering.

Electrical Characteristics

Part Number	Inductance (uH)	Tolerance (±%)	Test Frequency (MHz)	Q Min	Test Frequency (MHz)	SRF (MHz) Min	RDC (Ω) Max	Rated current (mA)
SQV453226T-1R0□-N	1.0	20	1	20	1	120	0.20	500
SQV453226T-1R2□-N	1.2	20	1	20	1	100	0.20	500
SQV453226T-1R5□-N	1.5	20	1	20	1	85	0.30	500
SQV453226T-1R8□-N	1.8	20	1	20	1	75	0.30	500
SQV453226T-2R2□-N	2.2	20	1	20	1	62	0.30	500
SQV453226T-2R7□-N	2.7	20	1	20	1	53	0.32	500
SQV453226T-3R3□-N	3.3	20	1	20	1	47	0.35	500
SQV453226T-3R9□-N	3.9	20	1	20	1	41	0.38	500
SQV453226T-4R7□-N	4.7	20 / 10	1	30	1	38	0.40	500
SQV453226T-5R6□-N	5.6	20 / 10	1	30	1	33	0.47	500
SQV453226T-6R8□-N	6.8	20 / 10	1	30	1	31	0.50	450
SQV453226T-8R2□-N	8.2	20 / 10	1	30	1	27	0.56	450
SQV453226T-100□-N	10	20 / 10	1	35	1	23	0.56	400
SQV453226T-120□-N	12	20 / 10	1	35	1	21	0.62	380
SQV453226T-150□-N	15	20 / 10 / 5	1	35	1	19	0.73	360
SQV453226T-180□-N	18	20 / 10	1	35	1	17	0.82	340
SQV453226T-220□-N	22	20 / 10 / 5	1	35	1	15	0.94	320
SQV453226T-270□-N	27	20 / 10 / 5	1	35	1	14	1.1	300
SQV453226T-330□-N	33	20 / 10	1	35	1	12	1.2	270
SQV453226T-390□-N	39	20 / 10 / 5	1	35	1	11	1.4	240
SQV453226T-470□-N	47	20 / 10 / 5	1	35	1	10	1.5	220
SQV453226T-560□-N	56	20 / 10	1	35	1	9.3	1.7	200
SQV453226T-680□-N	68	20 / 10 / 5	1	35	1	8.4	1.9	180
SQV453226T-820□-N	82	20 / 10	1	35	1	7.5	2.2	170
SQV453226T-101□-N	100	20 / 10 / 5	1	40	0.796	6.8	2.5	160
SQV453226T-121□-N	120	20 / 10	1	40	0.796	6.2	3.0	150
SQV453226T-151□-N	150	20 / 10	1	40	0.796	5.5	3.7	130
SQV453226T-181□-N	180	20 / 10	1	40	0.796	5.0	4.5	120
SQV453226T-221□-N	220	20 / 10 / 5	1	40	0.796	4.5	5.4	110
SQV453226T-271□-N	270	20 / 10	1	40	0.796	4.0	6.8	100
SQV453226T-331□-N	330	20 / 10	1	40	0.796	3.6	8.2	95
SQV453226T-391□-N	390	20 / 10 / 5	1	40	0.796	3.3	9.7	90
SQV453226T-471□-N	470	20 / 10 / 5	0.001	40	0.796	3.0	11.8	80
SQV453226T-561□-N	560	20 / 10 / 5	0.001	40	0.796	2.7	14.5	70
SQV453226T-681□-N	680	20 / 10	0.001	40	0.796	2.5	17.5	65
SQV453226T-821□-N	820	20 / 10	0.001	40	0.796	2.2	20.5	60
SQV453226T-102□-N	1000	20 / 10 / 5	0.001	40	0.252	2.0	25.0	50
SQV453226T-122□-N	1200	20 / 10	0.001	40	0.252	1.8	30.0	45
SQV453226T-152□-N	1500	20 / 10	0.001	40	0.252	1.6	37.0	40
SQV453226T-182□-N	1800	20 / 10	0.001	40	0.252	1.5	45.0	35
SQV453226T-222□-N	2200	20 / 10 / 5	0.001	40	0.252	1.3	50.0	30

Note: When ordering, please specify tolerance code. Tolerance : J=±5% , K=±10% , M=±20%

- Operating temperature range - 40°C ~ 125°C(Including self - temperature rise)
- Rated Current : Self temperature rise shall be limited to 35°C Max Inductance drop 10% typ.
- Measure Equipment :
 - L : Agilent HP4285A(1MHz)/Agilent HP4192A(1kHz)
 - Q : Agilent HP4285A
 - SRF : Agilent HP4291A
 - RDC : HP4338B or Chroma 16502
 - Rated Current : HP4284A+HP42841A

Please be sure to request approval specifications that provide further details of the products. Kindly note that the content of these specifications are subject to change or may be discontinued without advance notice. Please contact our sales department before ordering.

Packaging Specifications

Tape Dimensions

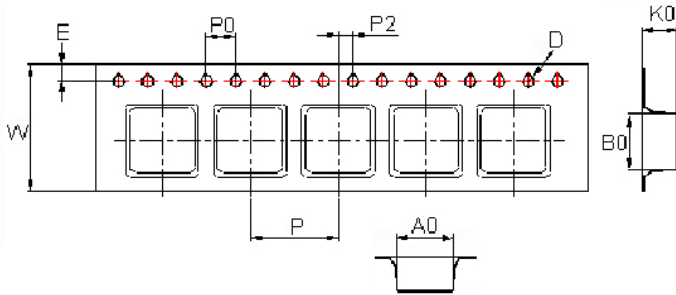

Tape Material

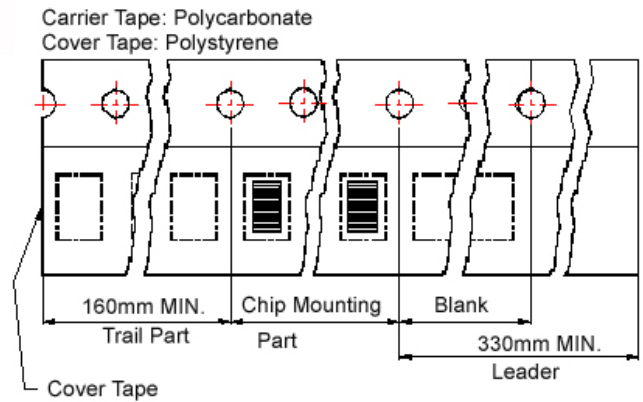

Reel Dimensions

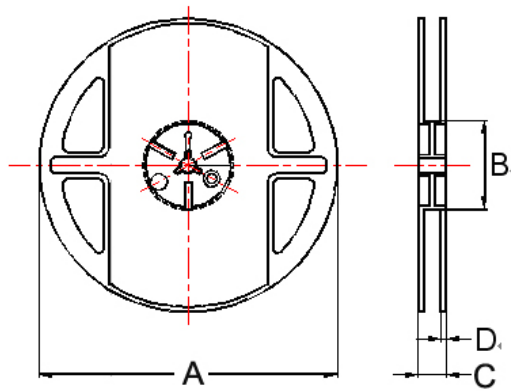

Dimensions in mm

TYPE	Tape Dimensions									Reel Dimensions				Quantity
	A0	B0	K0	D	E	W	P	P0	P2	A	B	C	D	PCS / REEL
SQV322520	2.90	3.60	2.25	1.5	1.75	8	4	4	2	178	60	9	1.5	2000
SQV453226	3.60	4.90	3.00	1.5	1.75	12	8	4	2	178	60	13.2	1.5	500

SQC Series



The SQC Series is a type of miniature wire-wound chip inductor designed on a special ferrite core. They are excellent for use in DC power supply circuits.

Features

- RoHS compliant
- Low DC resistance, high current capacity, and high impedance characteristics
- Excellent solder heat resistance
- Both flow and reflow soldering methods can be employed
- Available in 4 sizes

Applications

- Personal computers
- Disk drives and computer peripherals
- Pagers, cordless phone
- DC power supply circuit

Product Identification

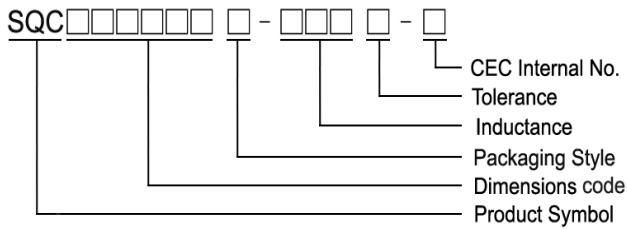

- Packaging: T : Tape and Reel

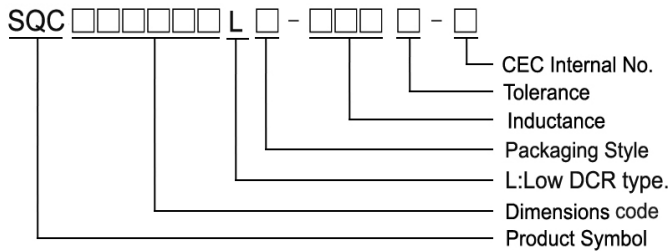

- Packaging: T : Tape and Reel

Shape and Dimensions

SQC322520 & SQC322520LT

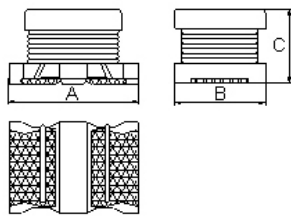

SQC322517 & SQC322517HP

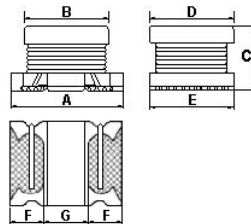

SQC453226

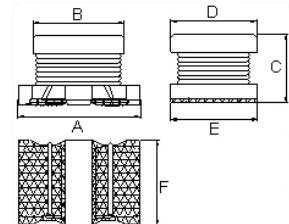

Dimensions in mm

TYPE	A	B	C	D	E	F	G
SQC322517	3.2 ± 0.3	2.5 ± 0.2	1.55 ± 0.15	2.5 ± 0.2	2.5 ± 0.2	0.9 ± 0.3	1.3 ± 0.2
SQC322517HP	3.2 ± 0.3	2.5 ± 0.2	1.55 ± 0.15	2.5 ± 0.2	2.5 ± 0.2	0.95 ± 0.3	1.2 ± 0.2
SQC322520	3.2 ± 0.3	2.5 ± 0.2	2.0 ± 0.2	-	-	-	-
SQC322520LT	3.2 ± 0.3	2.5 ± 0.2	2.0 ± 0.2	-	-	-	-
SQC453226	4.5 ± 0.3	3.6 ± 0.2	2.6 ± 0.2	3.2 ± 0.2	3.2 ± 0.2	3.2 ± 0.2	-

Please be sure to request approval specifications that provide further details of the products. Kindly note that the content of these specifications are subject to change or may be discontinued without advance notice. Please contact our sales department before ordering.

Recommended Pattern

SQC322517 & SQC322517HP

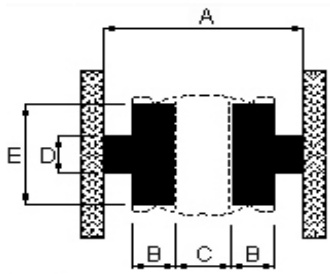

SQC322520 & SQC322520LT & SQC453226

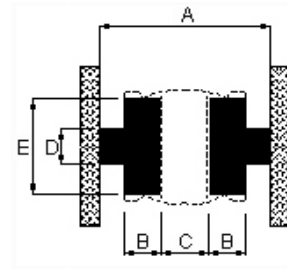

Dimensions in mm

TYPE	A	B	C	D	E
SQC322517	5.5	1.0	1.3	1.0	2.0
SQC322517HP	5.5	1.0	1.3	1.0	2.0
SQC322520	5.5	1.0	1.3	1.0	2.0
SQC322520LT	5.5	1.0	1.3	1.0	2.0
SQC453226	7.5	1.5	1.5	1.5	3.0

Electrical Characteristics

Part Number	Inductance (uH)	Tolerance (±%)	Test Frequency (MHz)	SRF (MHz) Min	RDC (Ω±20%)	Rated current (mA)	Irms (mA)
SQC322517HP-R47□-N	0.47	30	1	100	0.030	3400	2550
SQC322517HP-1R0□-N	1.0	30	1	100	0.045	2300	2050
SQC322517HP-1R5□-N	1.5	30	1	70	0.057	1750	1750
SQC322517HP-2R2□-N	2.2	30 / 20	1	70	0.076	1550	1600
SQC322517HP-3R3□-N	3.3	30 / 20	1	50	0.120	1250	1200
SQC322517HP-4R7□-N	4.7	30 / 20	1	40	0.180	1000	1000
SQC322517HP-6R8□-N	6.8	30 / 20	1	40	0.240	850	850
SQC322517HP-100□-N	10	30 / 20	1	30	0.380	750	700
SQC322517HP-150□-N	15	30 / 20	1	25	0.700	550	500
SQC322517HP-220□-N	22	30 / 20	1	20	0.810	500	450
SQC322517HP-330□-N	33	30 / 20	1	14	1.050	360	320
SQC322517HP-470□-N	47	30 / 20	1	11	1.480	280	240

Note: When ordering, please specify tolerance code. Tolerance : M=±20% ,T=±30%

- Operating temperature range - 25°C ~ 125°C(Including self - temperature rise)
- Rated Current : Self temperature rise shall be limited to 35°C Max Inductance drop 10% typ.
- Measure Equipment :
 - L : Agilent HP4192A
 - SRF : Agilent HP4291A
 - RDC : Chroma 16502

Rate Current : HP4284A+HP42841A

Electrical Characteristics

Part Number	Inductance (uH)	Tolerance (±%)	Test Frequency (MHz)	SRF (MHz) Min	RDC (Ω±30%)	Rated current (mA)
SQC322517T-2R2□-N	2.2	20	1	64	0.097	790
SQC322517T-3R3□-N	3.3	20	1	50	0.12	710
SQC322517T-6R8□-N	6.8	20	1	32	0.25	540
SQC322517T-100□-N	10	20 / 10	1	26	0.30	350
SQC322517T-220□-N	22	20 / 10	1	19	0.71	250
SQC322517T-101□-N	100	20 / 10	1	10	3.50	100

Note: When ordering, please specify tolerance code. Tolerance : K=±10% , M=±20%

- Operating temperature range - 25°C ~ 125°C(Including self - temperature rise)
- Rated Current for Inductance drop 10% from its value with current
- Measure Equipment :
 L : Agilent HP4192A
 SRF : Agilent HP4287A
 RDC : Chroma 16502

Electrical Characteristics

Part Number	Inductance (uH)	Tolerance (±%)	Test Frequency (MHz)	SRF (MHz) Min	RDC (Ω±30%)	Rated current (mA)
SQC322520T-R47□-N	0.47	20	1	150	0.042	1100
SQC322520T-1R0□-N	1.0	20	1	96	0.09	1000
SQC322520T-2R2□-N	2.2	20	1	64	0.13	600
SQC322520T-3R3□-N	3.3	20 / 10	1	60	0.15	600
SQC322520T-3R9□-N	3.9	20	1	50	0.16	500
SQC322520T-4R7□-N	4.7	20	1	43	0.20	450
SQC322520T-6R8□-N	6.8	20	1	30	0.26	400
SQC322520T-100□-N	10	20 / 10	1	26	0.44	300
SQC322520T-150□-N	15	20 / 10	1	22	0.55	350
SQC322520T-220□-N	22	20 / 10	1	19	0.71	250
SQC322520T-270□-N	27	20 / 10	1	15	0.90	230
SQC322520T-330□-N	33	20 / 10	1	15	1.10	200
SQC322520T-470□-N	47	20 / 10	1	15	1.30	170
SQC322520T-560□-N	56	20 / 10	1	12	2.30	150
SQC322520T-101□-N	100	20 / 10	1	10	3.50	100
SQC322520T-151□-N	150	20 / 10 / 5	1	7	6.00	80
SQC322520T-221□-N	220	20 / 10 / 5	1	6.8	8.40	70
SQC322520T-271□-N	270	20 / 10	1	6	10.0	65
SQC322520T-331□-N	330	20 / 10 / 5	1	5.6	10.0	60
SQC322520T-391□-N	390	20 / 10	1	5	17.0	60
SQC322520T-471□-N	470	20 / 10	0.001	5	19.0	60
SQC322520T-561□-N	560	20 / 10	0.001	5	22.0	60

Note: When ordering, please specify tolerance code. Tolerance : J=±5% , K=±10% , M=±20%

- Operating temperature range - 25°C ~ 125°C(Including self - temperature rise)
- Rated Current : Self temperature rise shall be limited to 35°C Max Inductance drop 10% typ.
- Measure Equipment :
 L : Agilent HP4192A
 SRF : Agilent HP4291A
 RDC : Chroma 16502
 Rate Current : HP4284A+HP42841A

Please be sure to request approval specifications that provide further details of the products. Kindly note that the content of these specifications are subject to change or may be discontinued without advance notice. Please contact our sales department before ordering.

Electrical Characteristics (LOW DCR Type)

Part Number	Inductance (uH)	Tolerance (±%)	Test Frequency (MHz)	SRF (MHz) Min	RDC (Ω±30%)	Rated current (mA)
SQC322520LT-R15□-N	0.15	20	1	400	0.028	1450
SQC322520LT-R27□-N	0.27	20	1	250	0.034	1250
SQC322520LT-R47□-N	0.47	20	1	150	0.042	1100
SQC322520LT-1R0□-N	1.0	20	1	100	0.060	1000
SQC322520LT-1R5□-N	1.5	20	1	85	0.085	900
SQC322520LT-2R2□-N	2.2	20	1	64	0.097	790
SQC322520LT-3R3□-N	3.3	20	1	55	0.13	700
SQC322520LT-4R7□-N	4.7	20 / 10	1	43	0.15	650
SQC322520LT-6R8□-N	6.8	20	1	30	0.21	600
SQC322520LT-100□-N	10	20 / 10	1	26	0.30	450

Note: When ordering, please specify tolerance code. Tolerance : K=±10% , M=±20%

- Operating temperature range - 40°C ~ 125°C(Including self - temperature rise)
- Rated Current : Self temperature rise shall be limited to 35°C Max Inductance drop 10% typ.
- Measure Equipment :
 L : Agilent HP4192A
 SRF : Agilent HP4291A
 RDC : Chroma 16502
 Rate Current : HP4284A+HP42841A

Electrical Characteristics

Part Number	Inductance (uH)	Tolerance (±%)	Test Frequency (MHz)	SRF (MHz) Min	RDC (Ω) Max	Rated current (mA)
SQC453226T-1R0□-N	1.0	20	1	100	0.08	1080
SQC453226T-1R5□-N	1.5	20	1	85	0.09	1000
SQC453226T-1R8□-N	1.8	20	1	65	0.10	900
SQC453226T-2R2□-N	2.2	20 / 10	1	60	0.11	900
SQC453226T-3R3□-N	3.3	20	1	47	0.13	800
SQC453226T-4R7□-N	4.7	20 / 10	1	35	0.15	750
SQC453226T-6R8□-N	6.8	20 / 10	1	30	0.20	720
SQC453226T-100□-N	10	20 / 10 / 5	1	23	0.24	650
SQC453226T-150□-N	15	20 / 10 / 5	1	20	0.32	570
SQC453226T-220□-N	22	20 / 10 / 5	1	15	0.60	420
SQC453226T-330□-N	33	20 / 10 / 5	1	12	1.0	310
SQC453226T-470□-N	47	20 / 10 / 5	1	10	1.1	280
SQC453226T-680□-N	68	20 / 10 / 5	1	8.4	1.7	220
SQC453226T-101□-N	100	20 / 10 / 5	1	6.8	2.2	190
SQC453226T-151□-N	150	20 / 10 / 5	1	5.5	3.5	130
SQC453226T-221□-N	220	20 / 10 / 5	1	4.5	4.0	110
SQC453226T-331□-N	330	20 / 10 / 5	1	3.6	6.8	100
SQC453226T-471□-N	470	20 / 10 / 5	1	3.0	8.5	90
SQC453226T-561□-N	560	20 / 10 / 5	0.001	2.5	10.4	80
SQC453226T-681□-N	680	20 / 10 / 5	0.001	2.2	14.7	70
SQC453226T-821□-N	820	20 / 10 / 5	0.001	2.0	20.0	60
SQC453226T-102□-N	1000	20 / 10 / 5	0.001	2.0	27.9	50
SQC453226T-152□-N	1500	20 / 10 / 5	0.001	1.8	35.0	40

Note: When ordering, please specify tolerance code. Tolerance : J=±5% , K=±10% , M=±20%

- Operating temperature range - 40°C ~ 125°C(Including self - temperature rise)
- Rated Current : Self temperature rise shall be limited to 35°C Max Inductance drop 10% typ.
- Measure Equipment :
 L : Agilent HP4192A
 SRF : Agilent HP4291A
 RDC : Chroma 16502
 Rate Current : HP4284A+HP42841A

Please be sure to request approval specifications that provide further details of the products. Kindly note that the content of these specifications are subject to change or may be discontinued without advance notice. Please contact our sales department before ordering.

Packaging Specifications

Tape Dimensions

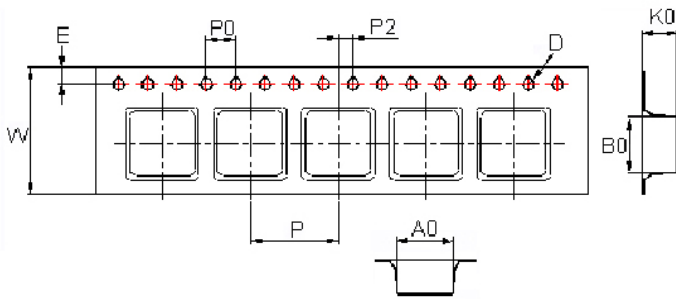

Tape Material

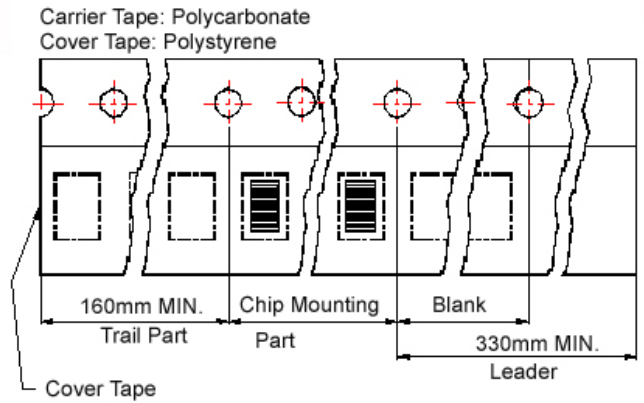

Reel Dimensions

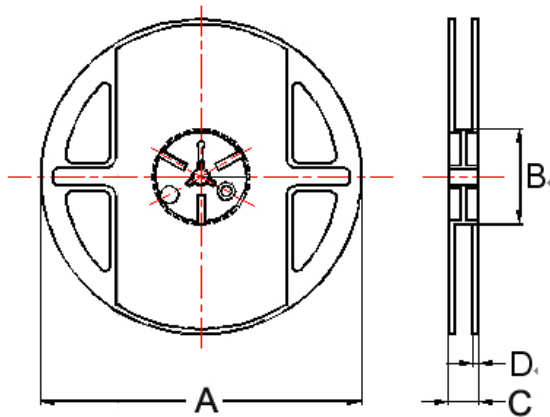

Dimensions in mm

TYPE	Tape Dimensions									Reel Dimensions				Quantity PCS / REEL
	A0	B0	K0	D	E	W	P	P0	P2	A	B	C	D	
SQC322517	2.85	3.56	1.80	1.55	1.75	8	4	4	2	178	60	9	1.5	2000
SQC322517HP	2.85	3.56	1.80	1.55	1.75	8	4	4	2	178	60	9	1.5	2000
SQC322520	2.90	3.60	2.25	1.5	1.75	8	4	4	2	178	60	9	1.5	2000
SQC322520LT	2.90	3.60	2.25	1.5	1.75	8	4	4	2	178	60	9	1.5	2000
SQC453226	3.60	4.90	3.00	1.5	1.75	12	8	4	2	178	60	13.2	1.5	500

Multilayer Ferrite Chip Beads



Chilisin offers a wide range of multi-layered ferrite chip beads with various sizes, frequency characteristics, and impedance values for EMI solutions. These ferrite formulas are used to compose seven types of EMI suppression chip beads: SB, GB, PB, UPB, NB, HF, and VPB series.

Product Identification

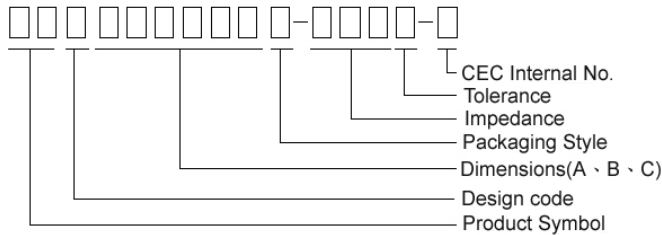

- Product symbol: SB, GB, PB, UPB, NB, HF, VPB
- Packaging: T : Tape and Reel ; B : Bulk
- Tolerance: Y = ± 25%; M = ± 20%; T:±30%
- Note: RoHS Compliant

Shape and Dimensions

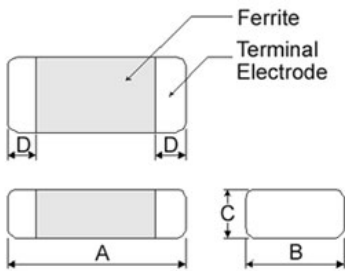

Recommended Pattern

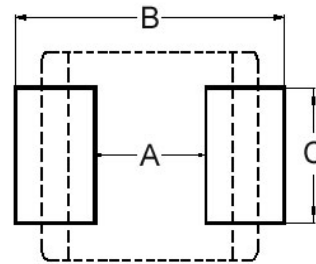

Dimensions in mm

TYPE	A	B	C	D
①060303	0.6±0.03	0.30±0.03	0.3±0.03	0.15±0.05
②100505	1.0±0.10	0.50±0.10	0.5±0.10	0.25±0.10
③160805	1.6±0.15	0.80±0.15	0.5±0.15	0.3±0.2
④160808	1.6±0.15	0.80±0.15	0.8±0.15	0.3±0.2
⑤201209	2.0±0.20	1.25±0.20	0.9±0.20	0.5±0.3
⑥321611	3.2±0.20	1.60±0.20	1.1±0.20	0.5±0.3

Dimensions in mm

TYPE	A	B	C
①060303	0.2 ~ 0.3	0.75 ~ 1.05	0.3
②100505	0.4	1.2 ~ 1.4	0.5
③160805	0.7 ~ 0.8	1.8 ~ 2.0	0.6 ~ 0.8
④160808	0.7 ~ 0.8	1.8 ~ 2.0	0.6 ~ 0.8
⑤201209	1.0 ~ 1.2	2.6 ~ 4.0	1.0 ~ 1.2
⑥321611	2.0	4.2 ~ 5.2	1.2

- ① : SBY / SBJ / NB / PB ② : SBY / SBJ / NB / PB / UPB / HF
 ③ : UPB ④ : SBK / SBJ / GB / PB / NB / UPB / VPB
 ⑤ : SBK / GB / PB / UPB ⑥ : SBY / SBK / PB / UPB

* Don't apply narrower pattern than listed above to PB and UPB. Narrow pattern might cause excessive heat or open circuit.

Dimension Conversion

Code	Dimension in mm (AxBxC)	EIA
060303	0.6X0.3X0.3	0201
100505	1.0X0.5X0.5	0402
160805	1.6x0.8x0.5	0603
160808	1.6x0.8x0.8	0603
201209	2.0x1.2x0.9	0805
321611	3.2x1.6x.1.1	1206

Electrical Characteristics

Part Number	Impedance ($\Omega \pm 25\%$)	Test Frequency (MHz)	RDC (Ω) Max	Rated current (mA) Max
SBY060303T-100Y-N	10	100	0.1	500
SBY060303T-600Y-N	60	100	0.4	200
SBY060303T-121Y-N	120	100	0.5	200
SBY060303T-241Y-N	240	100	0.8	200
SBY060303T-601Y-N	600	100	1.5	100

Note: When ordering, please specify tolerance code. Tolerance : Y= $\pm 25\%$

- Operating temperature range - 55°C ~ 125°C(Including self - temperature rise)
- Rate Current : Applied the current to coils, the temperature rise shall not be more than 30°C
- Measure Equipment :
Z : HP4291A
RDC : HP4338B or CHEN HWA 502

Test Instruments : Agilent E4991A Impedance / Material Analyzer

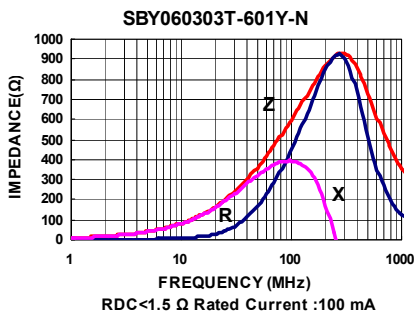
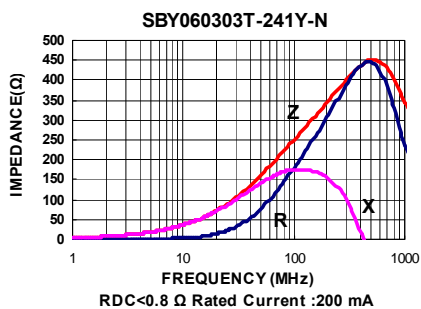
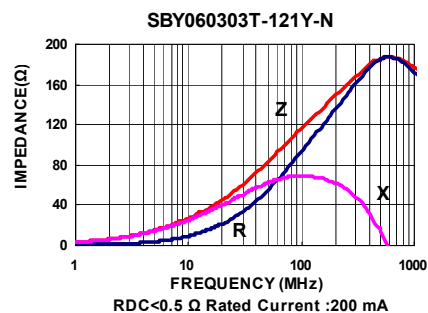
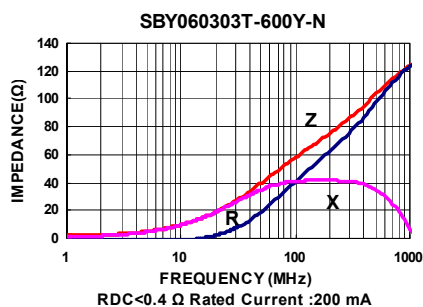
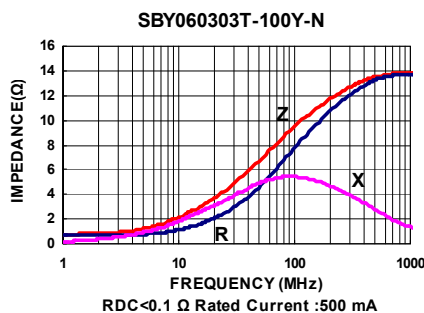

Please be sure to request approval specifications that provide further details of the products. Kindly note that the content of these specifications are subject to change or may be discontinued without advance notice. Please contact our sales department before ordering.

Electrical Characteristics

Part Number	Impedance ($\Omega \pm 25\%$)	Test Frequency (MHz)	RDC (Ω) Max	Rated current (mA) Max
SBY100505T-100Y-N	10	100	0.025	1000
SBY100505T-110Y-N	11	100	0.05	500
SBY100505T-150Y-N	15	100	0.10	500
SBY100505T-190Y-N	19	100	0.10	500
SBY100505T-220Y-N	22	100	0.15	500
SBY100505T-300Y-N	30	100	0.20	500
SBY100505T-320Y-N	32	100	0.20	500
SBY100505T-330Y-N	33	100	0.20	500
SBY100505T-400Y-N	40	100	0.20	500
SBY100505T-470Y-N	47	100	0.20	500
SBY100505T-500Y-N	50	100	0.20	500
SBY100505T-600Y-N	60	100	0.20	500
SBY100505T-700Y-N	70	100	0.15	600
SBY100505T-750Y-N	75	100	0.20	500
SBY100505T-800Y-N	80	100	0.20	500
SBY100505T-900Y-N	90	100	0.25	500
SBY100505T-101Y-N	100	100	0.25	500
SBY100505T-121Y-N	120	100	0.19	550
SBY100505T-151Y-N	150	100	0.40	400
SBY100505T-181Y-N	180	100	0.40	400
SBY100505T-221Y-N	220	100	0.29	450
SBY100505T-241Y-N	240	100	0.40	400
SBY100505T-301Y-N	300	100	0.50	300
SBY100505T-331Y-N	330	100	0.50	300
SBY100505T-471Y-N	470	100	0.50	300
SBY100505T-481Y-N	480	100	0.50	300
SBY100505T-601Y-N	600	100	0.52	300
SBY100505T-102Y-N	1000	100	0.65	300
SBY100505T-182Y-N	1800	100	1.40	100
SBY100505T-222Y-N	2200	100	1.40	100

Note: When ordering, please specify tolerance code. Tolerance : Y= $\pm 25\%$

- Operating temperature range - 55°C ~ 125°C(Including self - temperature rise)
- Rate Current : Applied the current to coils, the temperature rise shall not be more than 30°C
- Measure Equipment :
Z : HP4291A
RDC : HP4338B or CHEN HWA 502

Test Instruments : Agilent E4991A Impedance / Material Analyzer

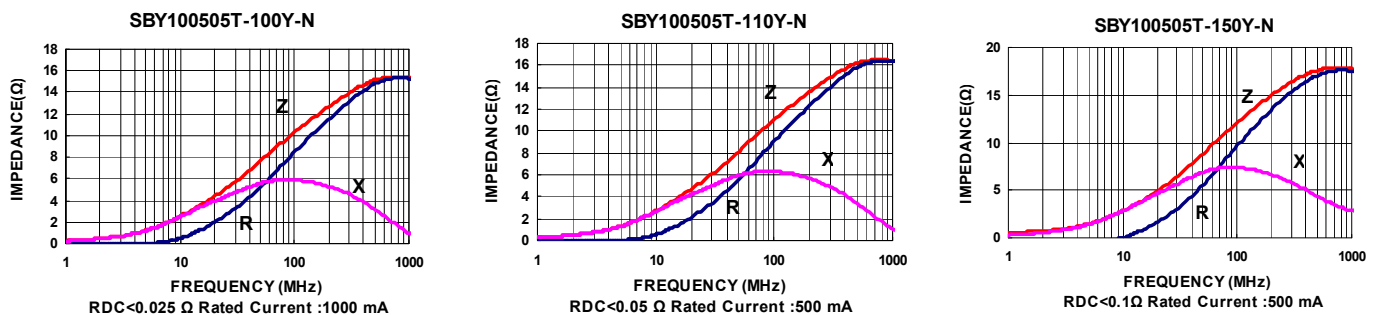

Please be sure to request approval specifications that provide further details of the products. Kindly note that the content of these specifications are subject to change or may be discontinued without advance notice. Please contact our sales department before ordering.

Test Instruments : Agilent E4991A Impedance / Material Analyzer

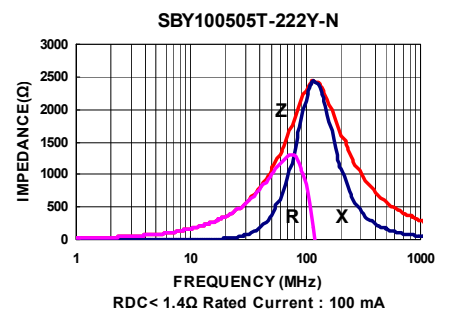
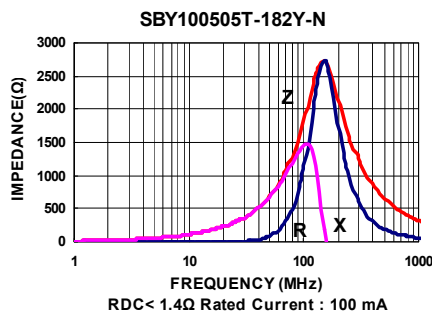
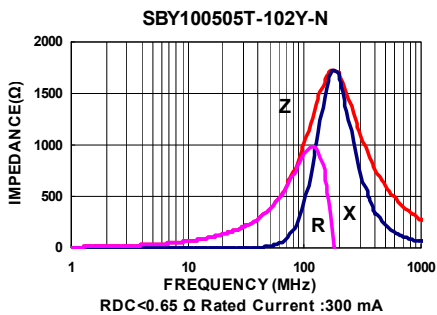
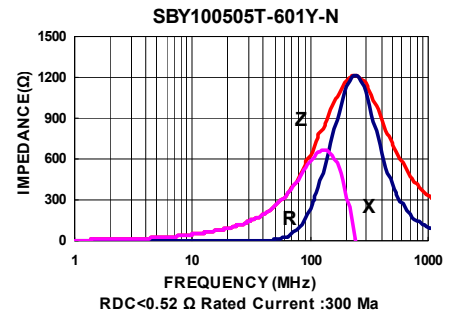
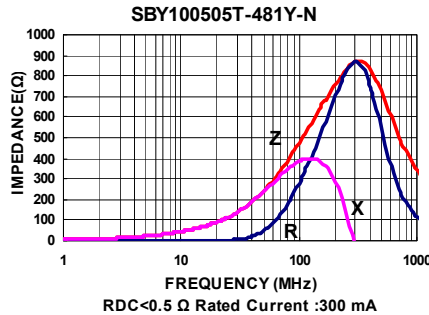
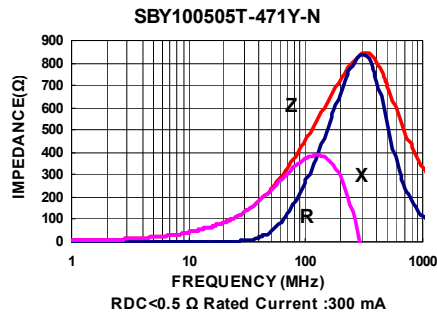
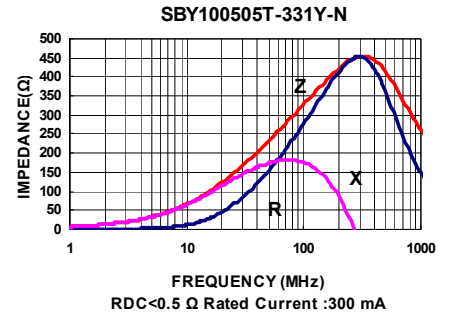
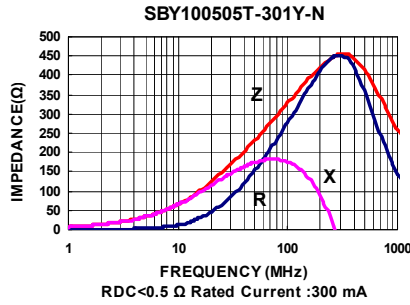
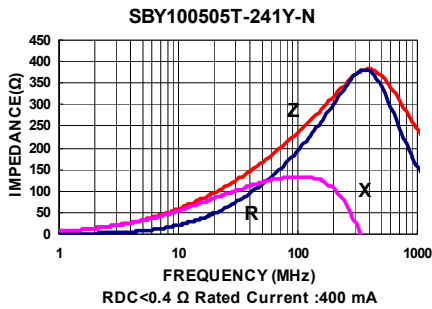
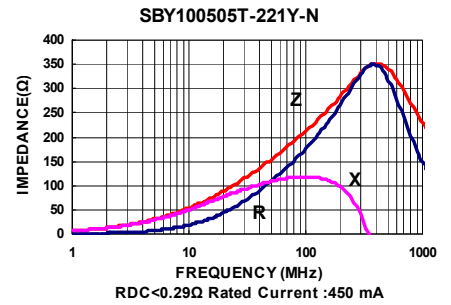
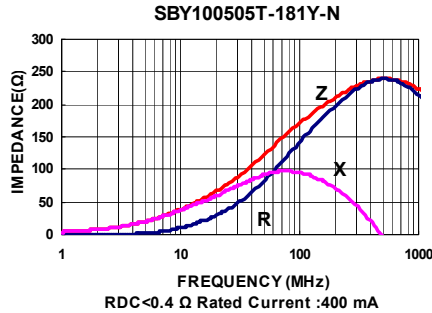
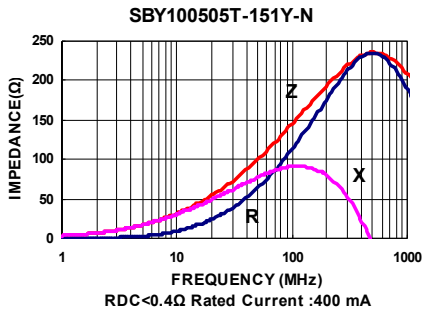

Please be sure to request approval specifications that provide further details of the products. Kindly note that the content of these specifications are subject to change or may be discontinued without advance notice. Please contact our sales department before ordering.

Electrical Characteristics

Part Number	Impedance ($\Omega \pm 25\%$)	Test Frequency (MHz)	RDC (Ω) Max	Rated current (mA) Max
SBK160808T-100Y-N	10	100	0.05	500
SBK160808T-110Y-N	11	100	0.05	500
SBK160808T-300Y-N	30	100	0.10	400
SBK160808T-310Y-N	31	100	0.10	400
SBK160808T-600Y-N	60	100	0.10	400
SBK160808T-800Y-N	80	100	0.15	400
SBK160808T-121Y-N	120	100	0.25	400
SBK160808T-221Y-N	220	100	0.30	300
SBK160808T-301Y-N	300	100	0.40	300
SBK160808T-471Y-N	470	100	0.50	300
SBK160808T-601Y-N	600	100	0.50	300
SBK160808T-102Y-N	1000	100	0.60	300
SBK160808T-152Y-N	1500	100	0.60	300
SBK160808T-182Y-N	1800	100	0.80	200
SBK160808T-202Y-N	2000	100	0.80	200
SBK160808T-222Y-N	2200	100	0.80	200
SBK160808T-252Y-N	2500	100	0.80	200
SBK160808T-272Y-N	2700	100	0.80	200

Note: When ordering, please specify tolerance code. Tolerance : Y= $\pm 25\%$

- Operating temperature range - 55°C ~ 125°C(Including self - temperature rise)
- Rate Current : Applied the current to coils, the temperature rise shall not be more than 30°C
- Measure Equipment :
Z : HP4291A
RDC : HP4338B or CHEN HWA 502

Test Instruments : Agilent E4991A Impedance / Material Analyzer

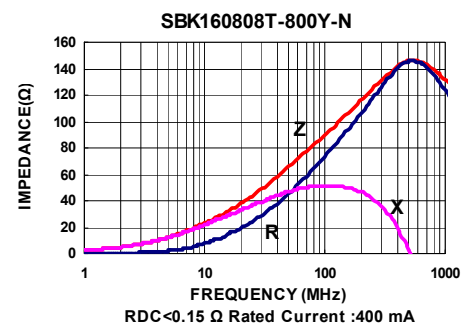
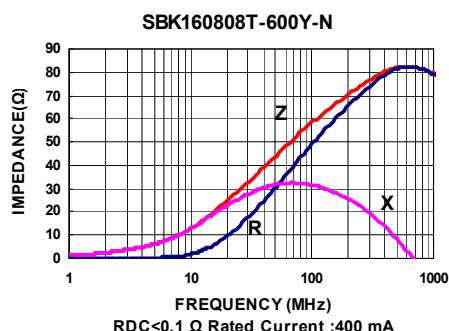
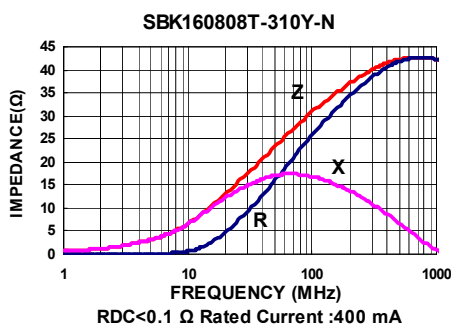
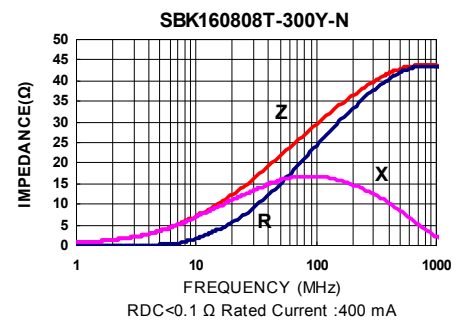
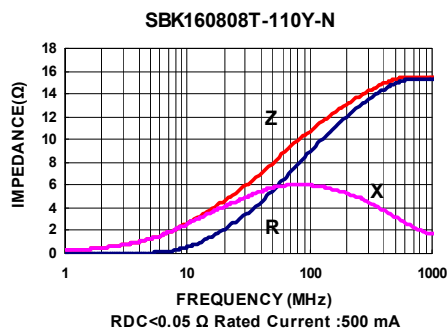
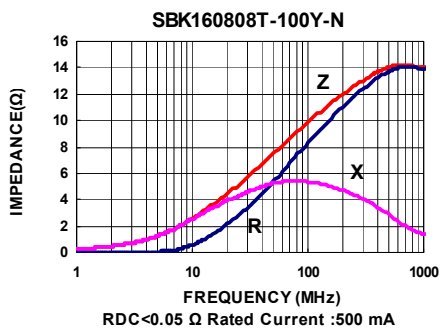

Please be sure to request approval specifications that provide further details of the products. Kindly note that the content of these specifications are subject to change or may be discontinued without advance notice. Please contact our sales department before ordering.

Test Instruments : Agilent E4991A Impedance / Material Analyzer

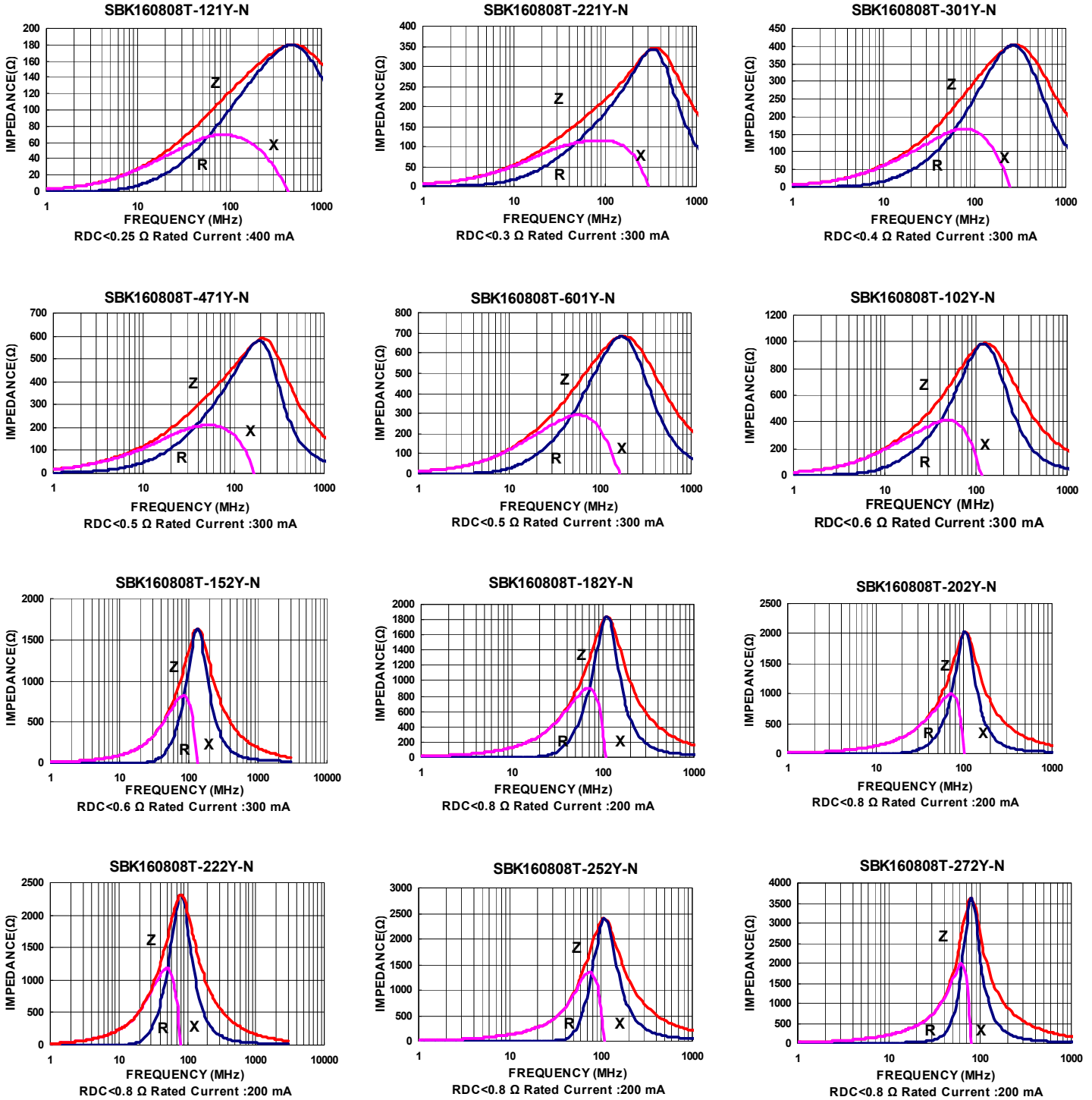

Please be sure to request approval specifications that provide further details of the products. Kindly note that the content of these specifications are subject to change or may be discontinued without advance notice. Please contact our sales department before ordering.

Electrical Characteristics

Part Number	Impedance ($\Omega \pm 25\%$)	Test Frequency (MHz)	DC Resistance (Ω) Max	Rated current (mA) Max
SBK201209T-600Y-N	60	100	0.15	500
SBK201209T-800Y-N	80	100	0.15	500
SBK201209T-121Y-N	120	100	0.25	300
SBK201209T-221Y-N	220	100	0.30	300
SBK201209T-301Y-N	300	100	0.30	300
SBK201209T-431Y-N	430	100	0.40	300
SBK201209T-471Y-N	470	100	0.40	300
SBK201209T-601Y-N	600	100	0.40	300
SBK201209T-102Y-N	1000	100	0.50	200
SBK201209T-122Y-N	1200	100	0.60	200
SBK201209T-152Y-N	1500	100	0.60	200
SBK201209T-202Y-N	2000	100	0.70	200
SBK201209T-222Y-N	2200	100	0.70	200
SBK201209T-252Y-N	2500	100	0.70	200
SBK201209T-272Y-N	2700	100	0.70	200

Note: When ordering, please specify tolerance code. Tolerance : Y=±25%

- Operating temperature range - 55°C ~ 125°C(Including self - temperature rise)
- Rate Current : Applied the current to coils, the temperature rise shall not be more than 30°C
- Measure Equipment :
Z : HP4291A
RDC : HP4338B or CHEN HWA 502

Test Instruments : Agilent E4991A Impedance / Material Analyzer

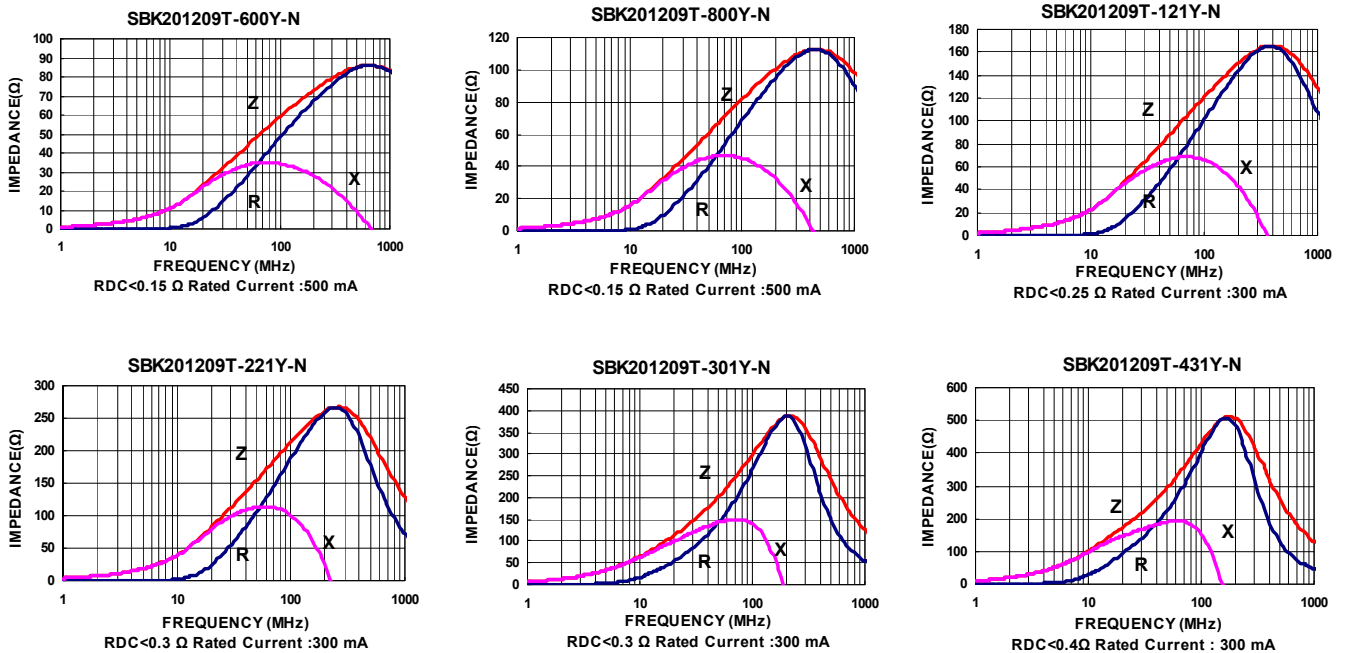

Please be sure to request approval specifications that provide further details of the products. Kindly note that the content of these specifications are subject to change or may be discontinued without advance notice. Please contact our sales department before ordering.

Test Instruments : Agilent E4991A Impedance / Material Analyzer

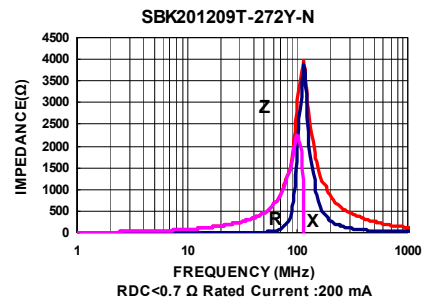
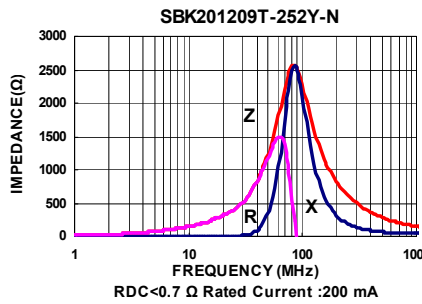
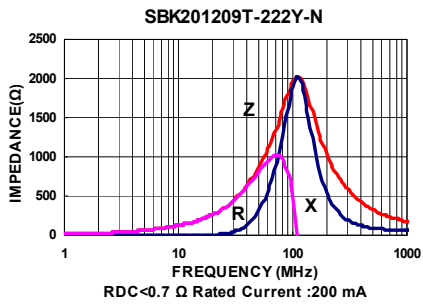
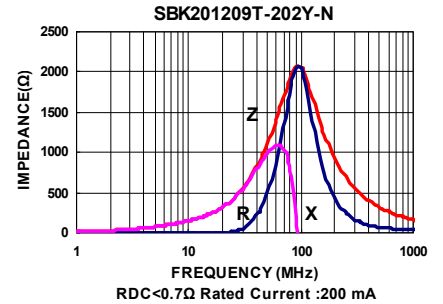
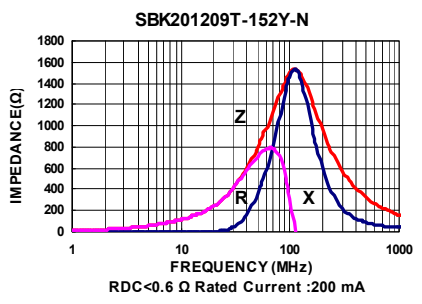
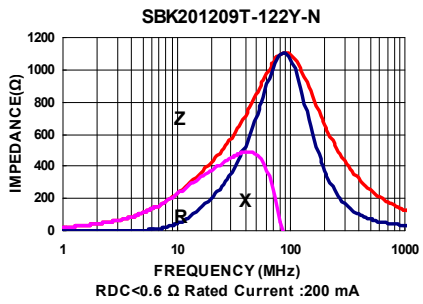
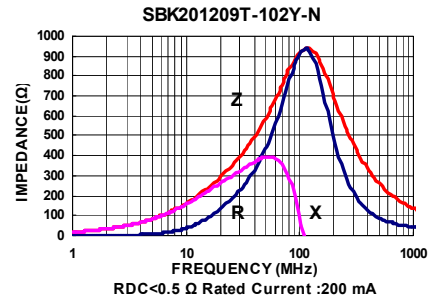
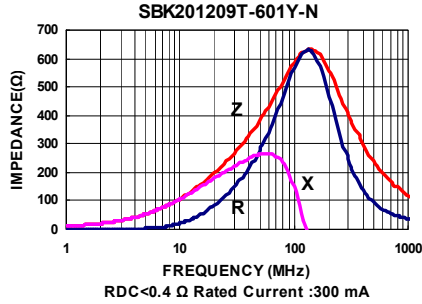
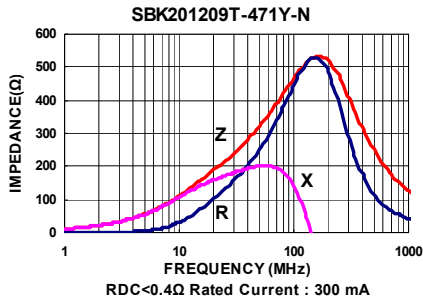

Please be sure to request approval specifications that provide further details of the products. Kindly note that the content of these specifications are subject to change or may be discontinued without advance notice. Please contact our sales department before ordering.

Electrical Characteristics

Part Number	Impedance ($\Omega \pm 25\%$)	Test Frequency (MHz)	RDC (Ω) Max	Rated current (mA) Max
SBK321611T-900Y-N	90	100	0.15	500
SBK321611T-121Y-N	120	100	0.15	500
SBK321611T-471Y-N	470	100	0.20	400
SBK321611T-601Y-N	600	100	0.30	400
SBK321611T-102Y-N	1000	50	0.40	200
SBK321611T-122Y-N	1200	50	0.40	200
SBK321611T-152Y-N	1500	50	0.45	200

Note: When ordering, please specify tolerance code. Tolerance : Y= $\pm 25\%$

- Operating temperature range - 55°C ~ 125°C(Including self - temperature rise)
- Rate Current : Applied the current to coils, the temperature rise shall not be more than 30°C
- Measure Equipment :
Z : HP4291A
RDC : HP4338B or CHEN HWA 502

Test Instruments : Agilent E4991A Impedance / Material Analyzer

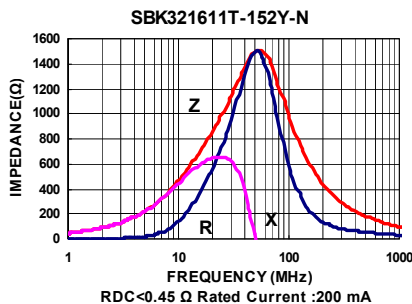
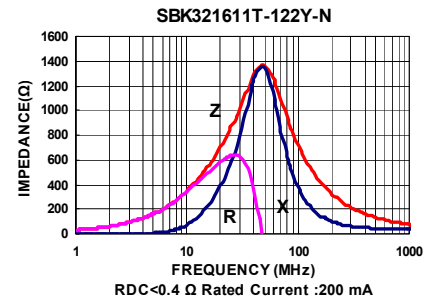
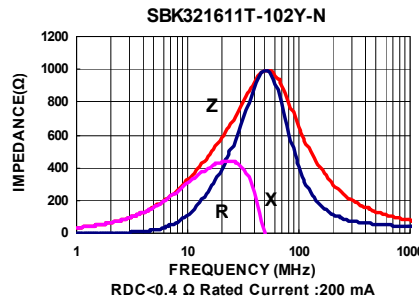
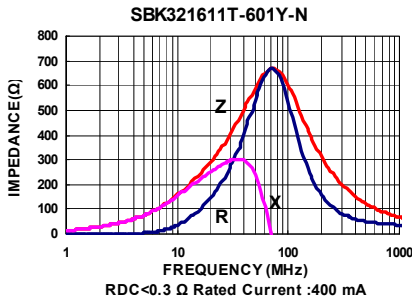
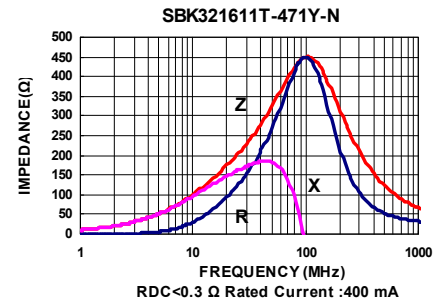
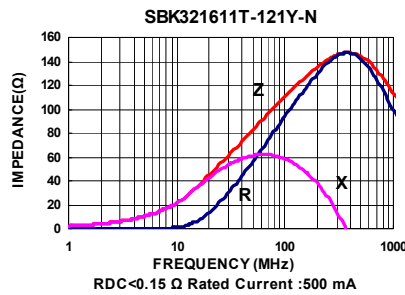
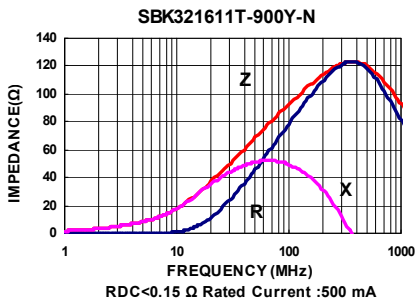

Please be sure to request approval specifications that provide further details of the products. Kindly note that the content of these specifications are subject to change or may be discontinued without advance notice. Please contact our sales department before ordering.

Packaging Specifications

Tape Dimensions

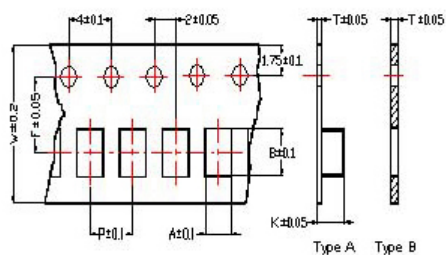

Tape Material

Carrier Tape: Polycarbonate (Tape A)
Carrier Tape: Paper (Tape B)
Cover Tape: Polystyrene

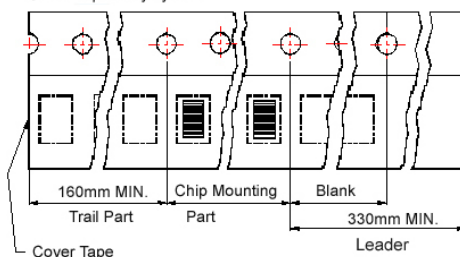

Reel Dimensions

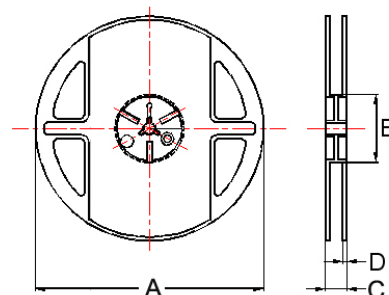

- ① : SBY / SBJ / NB / PB
- ② : SBY / SBJ / NB / PB / UPB / HF ③ : UPB
- ④ : SBK / SBJ / GB / PB / NB / UPB / VPB
- ⑤ : SBK / GB / PB / UPB ⑥ : SBY / SBK / PBY / UPB

Dimensions in mm

TYPE	Tape Dimensions								Reel Dimensions				Quantity PCS / REEL
	A	B	T	W	P	F	K	Tape	A	B	C	D	
①060303	0.37	0.67	0.42	8.0	2.0	3.5	-	B	178	60	10	2	15000
②100505	0.62	1.12	0.60	8.0	2.0	3.5	-	B	178	60	12	2	10000
③160805	1.05	1.85	0.60	8.0	2.0	3.5	-	B	178	60	12	2	10000
④160808	1.05	1.85	0.95	8.0	4.0	3.5	-	B	178	60	12	2	4000
⑤201209	1.50	2.30	0.97	8.0	4.0	3.5	-	B	178	60	12	2	4000
⑥321611	1.88	3.50	0.22	8.0	4.0	3.5	1.27	A	178	60	12	2	3000

Multilayer Ferrite Chip Beads



Chilisin offers a wide range of multi-layered ferrite chip beads with various sizes, frequency characteristics, and impedance values for EMI solutions. These ferrite formulas are used to compose seven types of EMI suppression chip beads: SB, GB, PB, UPB, NB, HF, and VPB series.

Product Identification

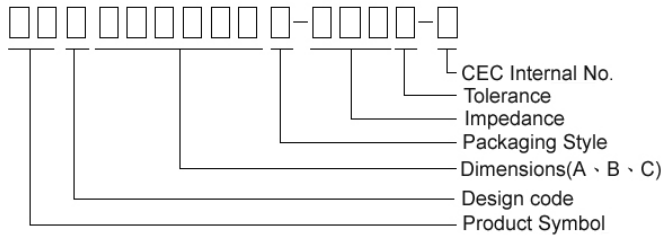

- Product symbol: SB, GB, PB, UPB, NB, HF, VPB
- Packaging: T : Tape and Reel ; B : Bulk
- Tolerance: Y = ± 25%; M = ± 20%; T:±30%
- Note: RoHS Compliant

Shape and Dimensions

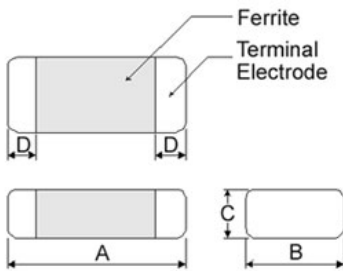

Recommended Pattern

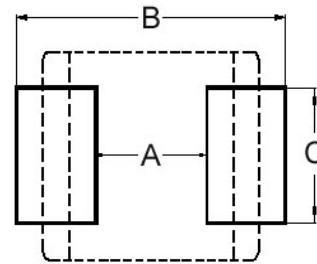

Dimensions in mm

TYPE	A	B	C	D
①060303	0.6±0.03	0.30±0.03	0.3±0.03	0.15±0.05
②100505	1.0±0.10	0.50±0.10	0.5±0.10	0.25±0.10
③160805	1.6±0.15	0.80±0.15	0.5±0.15	0.3±0.2
④160808	1.6±0.15	0.80±0.15	0.8±0.15	0.3±0.2
⑤201209	2.0±0.20	1.25±0.20	0.9±0.20	0.5±0.3
⑥321611	3.2±0.20	1.60±0.20	1.1±0.20	0.5±0.3

- ① : SBY / SBJ / NB / PB ② : SBY / SBJ / NB / PB / UPB / HF
 ③ : UPB ④ : SBK / SBJ / GB / PB / NB / UPB / VPB
 ⑤ : SBK / GB / PB / UPB ⑥ : SBY / SBK / PB / UPB

Dimensions in mm

TYPE	A	B	C
①060303	0.2 ~ 0.3	0.75 ~ 1.05	0.3
②100505	0.4	1.2 ~ 1.4	0.5
③160805	0.7 ~ 0.8	1.8 ~ 2.0	0.6 ~ 0.8
④160808	0.7 ~ 0.8	1.8 ~ 2.0	0.6 ~ 0.8
⑤201209	1.0 ~ 1.2	2.6 ~ 4.0	1.0 ~ 1.2
⑥321611	2.0	4.2 ~ 5.2	1.2

- * Don't apply narrower pattern than listed above to PB and UPB. Narrow pattern might cause excessive heat or open circuit.

Dimension Conversion

Code	Dimension in mm (AxBxC)	EIA
060303	0.6X0.3X0.3	0201
100505	1.0X0.5X0.5	0402
160805	1.6x0.8x0.5	0603
160808	1.6x0.8x0.8	0603
201209	2.0x1.2x0.9	0805
321611	3.2x1.6x.1.1	1206

Electrical Characteristics

Part Number	Impedance ($\Omega \pm 25\%$)	Test Frequency (MHz)	RDC (Ω) Max	Rated current (mA) Max
SBJ060303T-600Y-N	60	100	0.3	200
SBJ060303T-750Y-N	75	100	0.4	300
SBJ060303T-121Y-N	120	100	0.5	250
SBJ060303T-241Y-N	240	100	0.8	220

Note: When ordering, please specify tolerance code. Tolerance : Y=±25%

- Operating temperature range - 55°C ~ 125°C(Including self - temperature rise)
- Rate Current : Applied the current to coils, the temperature rise shall not be more than 30°C
- Measure Equipment :
Z : HP4291A
RDC : HP4338B or CHEN HWA 502

Test Instruments : Agilent E4991A Impedance / Material Analyzer

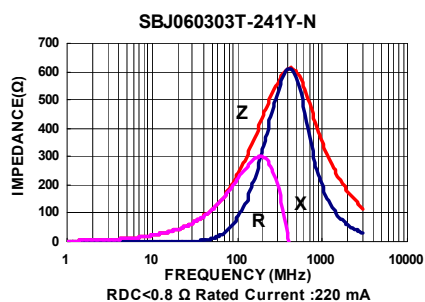
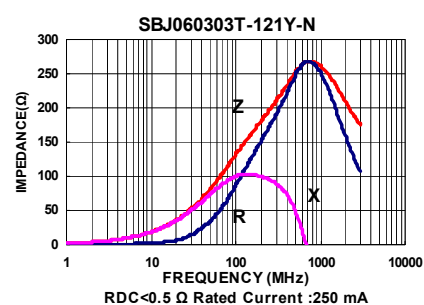
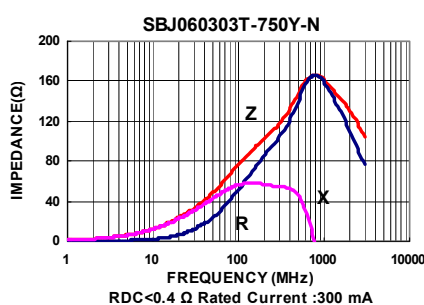
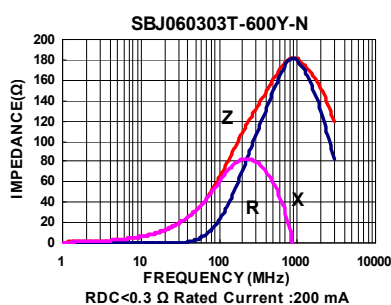

Please be sure to request approval specifications that provide further details of the products. Kindly note that the content of these specifications are subject to change or may be discontinued without advance notice. Please contact our sales department before ordering.

Electrical Characteristics

Part Number	Impedance ($\Omega \pm 25\%$)	Test Frequency (MHz)	RDC (Ω) Max	Rated current (mA) Max
SBJ100505T-300Y-N	30	100	0.20	500
SBJ100505T-600Y-N	60	100	0.20	500
SBJ100505T-121Y-N	120	100	0.25	500
SBJ100505T-221Y-N	220	100	0.40	400
SBJ100505T-301Y-N	300	100	0.50	300
SBJ100505T-481Y-N	480	100	0.50	300
SBJ100505T-601Y-N	600	100	0.60	300
SBJ100505T-102Y-N	1000	100	0.95	200
SBJ100505T-152Y-N	1500	100	1.15	100
SBJ100505T-182Y-N	1800	100	1.40	100
SBJ100505T-252Y-N	2500	100	1.80	100

Note: When ordering, please specify tolerance code. Tolerance : Y= $\pm 25\%$

- Operating temperature range - 55°C ~ 125°C(Including self - temperature rise)
- Rate Current : Applied the current to coils, the temperature rise shall not be more than 30°C
- Measure Equipment :
Z : HP4291A
RDC : HP4338B or CHEN HWA 502

Test Instruments : Agilent E4991A Impedance / Material Analyzer

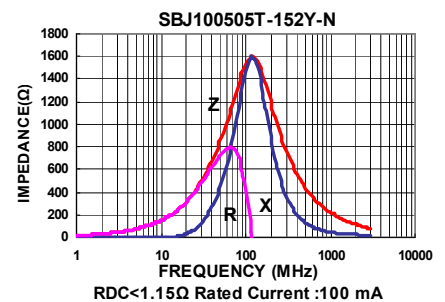
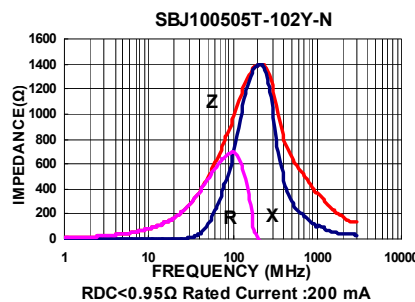
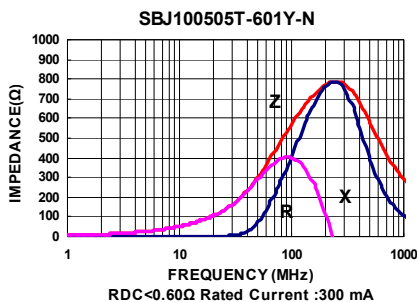
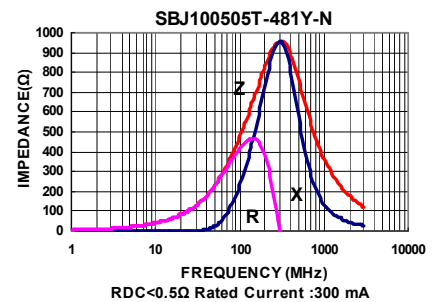
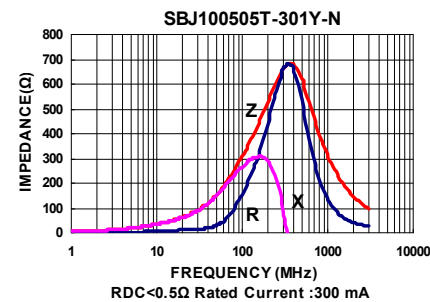
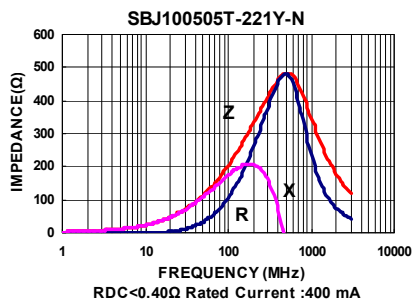
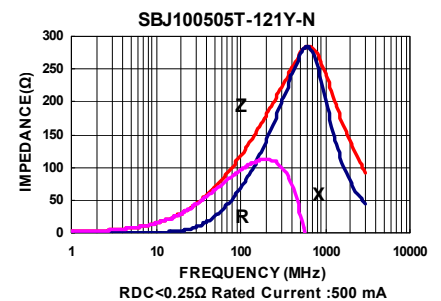
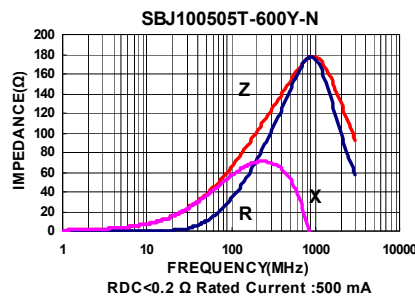
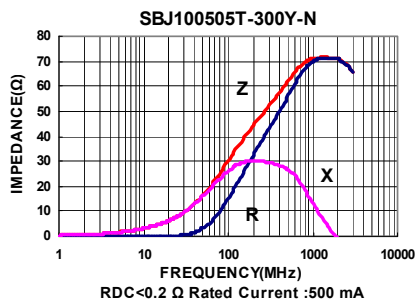

Please be sure to request approval specifications that provide further details of the products. Kindly note that the content of these specifications are subject to change or may be discontinued without advance notice. Please contact our sales department before ordering.

Test Instruments : Agilent E4991A Impedance / Material Analyzer

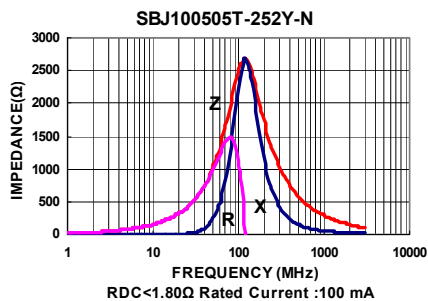
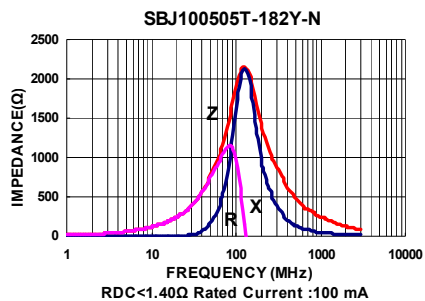

Please be sure to request approval specifications that provide further details of the products. Kindly note that the content of these specifications are subject to change or may be discontinued without advance notice. Please contact our sales department before ordering.

Electrical Characteristics

Part Number	Impedance ($\Omega \pm 25\%$)	Test Frequency (MHz)	RDC (Ω) Max	Rated current (mA) Max
SBJ160808T-600Y-N	60	100	0.10	400
SBJ160808T-121Y-N	120	100	0.25	400
SBJ160808T-221Y-N	220	100	0.30	400
SBJ160808T-601Y-N	600	100	0.40	400
SBJ160808T-102Y-N	1000	100	0.60	300
SBJ160808T-152Y-N	1500	100	0.80	200
SBJ160808T-182Y-N	1800	100	1.0	200
SBJ160808T-252Y-N	2500	100	1.0	200

Note: When ordering, please specify tolerance code. Tolerance : Y \pm 25%

- Operating temperature range - 55°C ~ 125°C(Including self - temperature rise)
- Rate Current : Applied the current to coils, the temperature rise shall not be more than 30°C
- Measure Equipment :
Z : HP4291A
RDC : HP4338B or CHEN HWA 502

Test Instruments : Agilent E4991A Impedance / Material Analyzer

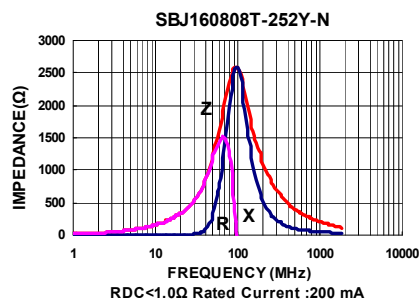
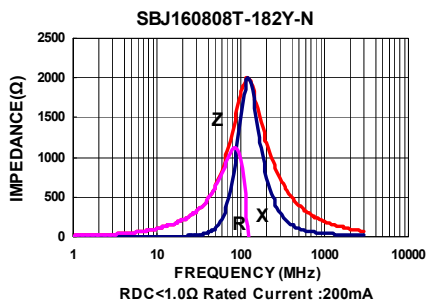
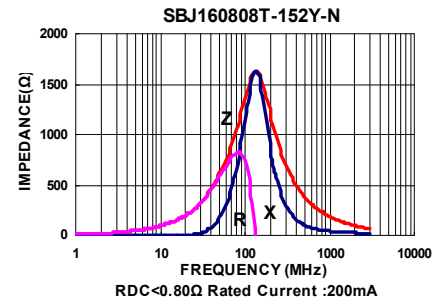
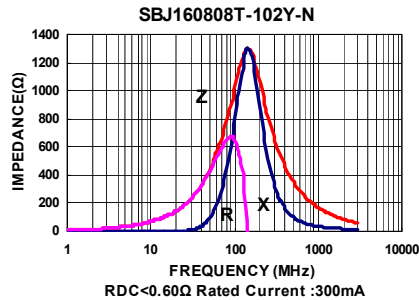
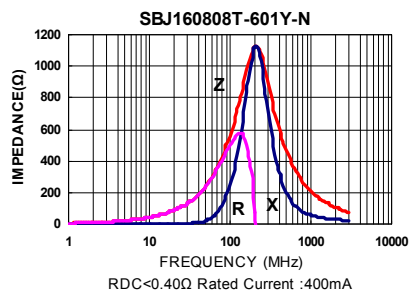
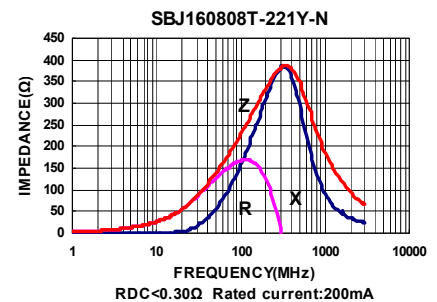
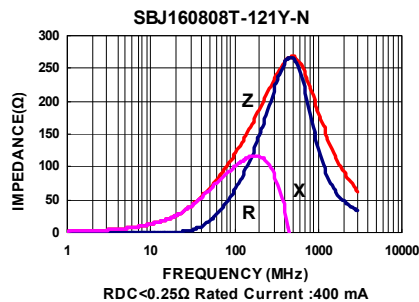
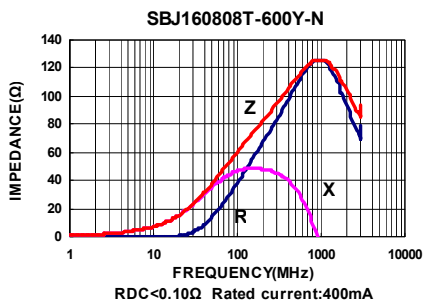

Please be sure to request approval specifications that provide further details of the products. Kindly note that the content of these specifications are subject to change or may be discontinued without advance notice. Please contact our sales department before ordering.

Packaging Specifications

Tape Dimensions

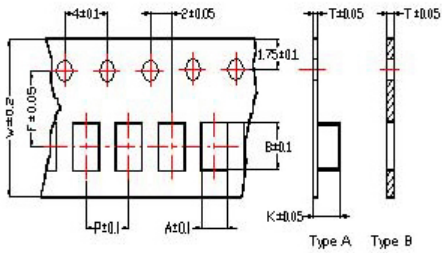

Tape Material

Carrier Tape: Polycarbonate (Tape A)
 Carrier Tape: Paper (Tape B)
 Cover Tape: Polystyrene

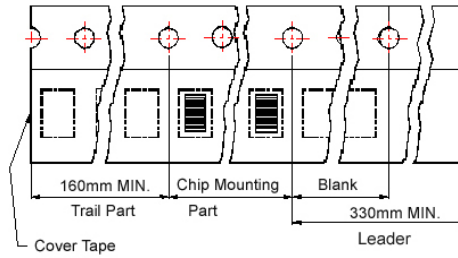

Reel Dimensions

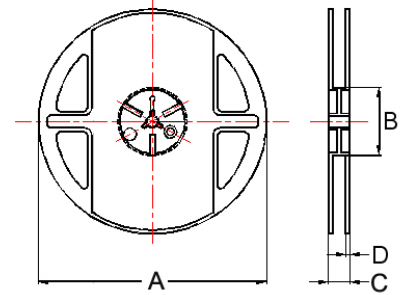

- ① : SBY / SBJ / NB / PB
- ② : SBY / SBJ / NB / PB / UPB / HF ③ : UPB
- ④ : SBK / SBJ / GB / PB / NB / UPB / VPB
- ⑤ : SBK / GB / PB / UPB ⑥ : SBY / SBK / PBY / UPB

Dimensions in mm

TYPE	Tape Dimensions								Reel Dimensions				Quantity PCS / REEL
	A	B	T	W	P	F	K	Tape	A	B	C	D	
①060303	0.37	0.67	0.42	8.0	2.0	3.5	-	B	178	60	10	2	15000
②100505	0.62	1.12	0.60	8.0	2.0	3.5	-	B	178	60	12	2	10000
③160805	1.05	1.85	0.60	8.0	2.0	3.5	-	B	178	60	12	2	10000
④160808	1.05	1.85	0.95	8.0	4.0	3.5	-	B	178	60	12	2	4000
⑤201209	1.50	2.30	0.97	8.0	4.0	3.5	-	B	178	60	12	2	4000
⑥321611	1.88	3.50	0.22	8.0	4.0	3.5	1.27	A	178	60	12	2	3000

Multilayer Ferrite Chip Beads



Chilisin offers a wide range of multi-layered ferrite chip beads with various sizes, frequency characteristics, and impedance values for EMI solutions. These ferrite formulas are used to compose seven types of EMI suppression chip beads: SB, GB, PB, UPB, NB, HF, and VPB series.

Product Identification

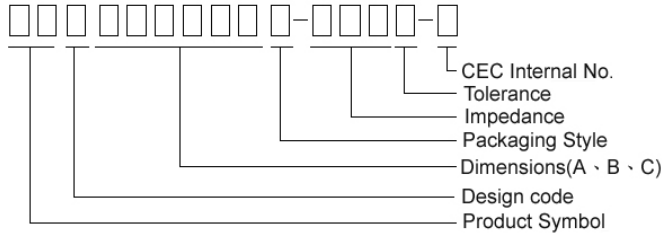

- Product symbol: SB, GB, PB, UPB, NB, HF, VPB
- Packaging: T : Tape and Reel ; B : Bulk
- Tolerance: Y = ± 25%; M = ± 20%; T:±30%
- Note: RoHS Compliant

Shape and Dimensions

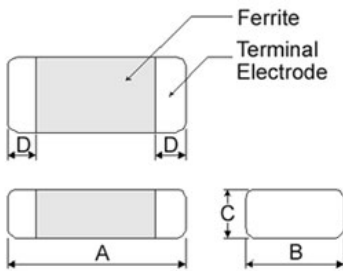

Recommended Pattern

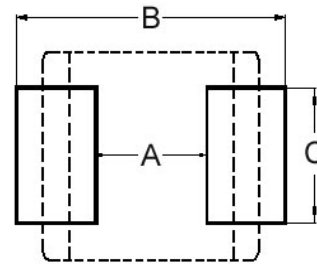

Dimensions in mm

TYPE	A	B	C	D
①060303	0.6±0.03	0.30±0.03	0.3±0.03	0.15±0.05
②100505	1.0±0.10	0.50±0.10	0.5±0.10	0.25±0.10
③160805	1.6±0.15	0.80±0.15	0.5±0.15	0.3±0.2
④160808	1.6±0.15	0.80±0.15	0.8±0.15	0.3±0.2
⑤201209	2.0±0.20	1.25±0.20	0.9±0.20	0.5±0.3
⑥321611	3.2±0.20	1.60±0.20	1.1±0.20	0.5±0.3

- ① : SBY / SBJ / NB / PB ② : SBY / SBJ / NB / PB / UPB / HF
 ③ : UPB ④ : SBK / SBJ / GB / PB / NB / UPB / VPB
 ⑤ : SBK / GB / PB / UPB ⑥ : SBY / SBK / PB / UPB

Dimensions in mm

TYPE	A	B	C
①060303	0.2 ~ 0.3	0.75 ~ 1.05	0.3
②100505	0.4	1.2 ~ 1.4	0.5
③160805	0.7 ~ 0.8	1.8 ~ 2.0	0.6 ~ 0.8
④160808	0.7 ~ 0.8	1.8 ~ 2.0	0.6 ~ 0.8
⑤201209	1.0 ~ 1.2	2.6 ~ 4.0	1.0 ~ 1.2
⑥321611	2.0	4.2 ~ 5.2	1.2

* Don't apply narrower pattern than listed above to PB and UPB. Narrow pattern might cause excessive heat or open circuit.

Dimension Conversion

Code	Dimension in mm (AxBxC)	EIA
060303	0.6X0.3X0.3	0201
100505	1.0X0.5X0.5	0402
160805	1.6x0.8x0.5	0603
160808	1.6x0.8x0.8	0603
201209	2.0x1.2x0.9	0805
321611	3.2x1.6x.1.1	1206

Electrical Characteristics

Part Number	Impedance ($\Omega \pm 25\%$)	Test Frequency (MHz)	RDC (Ω) Max	Rated current (mA) Max
GBK160808T-300Y-N	30	100	0.06	800
GBK160808T-600Y-N	60	100	0.06	700
GBK160808T-101Y-N	100	100	0.15	600
GBK160808T-121Y-N	120	100	0.15	600
GBK160808T-221Y-N	220	100	0.18	550
GBK160808T-301Y-N	300	100	0.25	500
GBK160808T-601Y-N	600	100	0.30	400
GBK160808T-102Y-N	1000	100	0.45	300
GBK160808T-152Y-N	1500	100	0.70	150

Note: When ordering, please specify tolerance code. Tolerance : Y= $\pm 25\%$

- Operating temperature range - 55°C ~ 125°C(Including self - temperature rise)
- Rate Current : Applied the current to coils, the temperature rise shall not be more than 30°C
- Measure Equipment :
 Z : HP4291A
 RDC : HP4338B or CHEN HWA 502

Test Instruments : Agilent E4991A Impedance / Material Analyzer

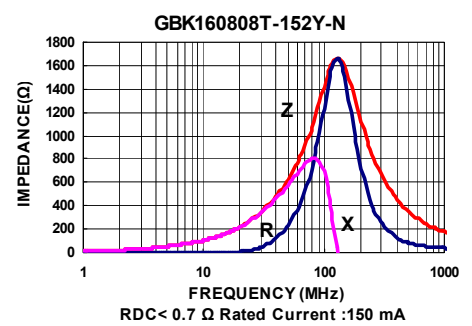
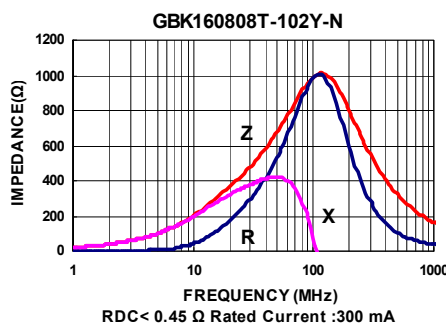
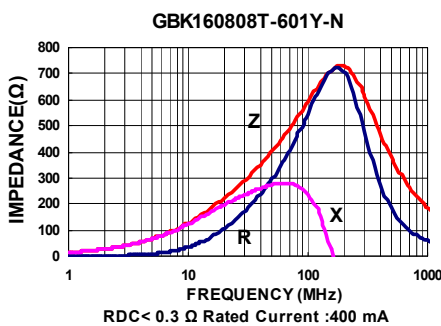
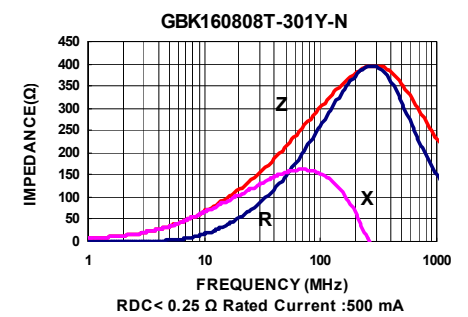
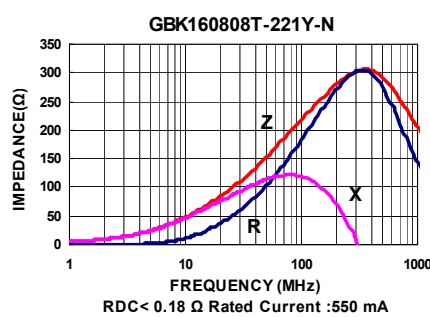
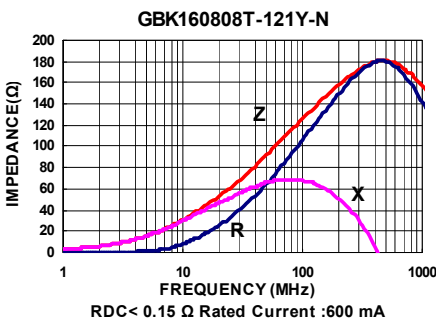
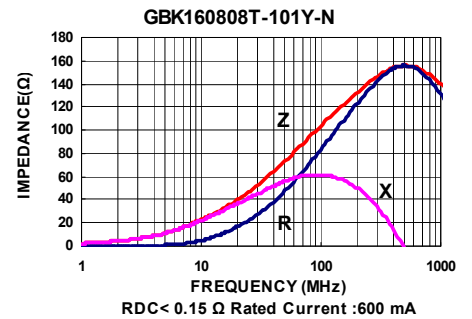
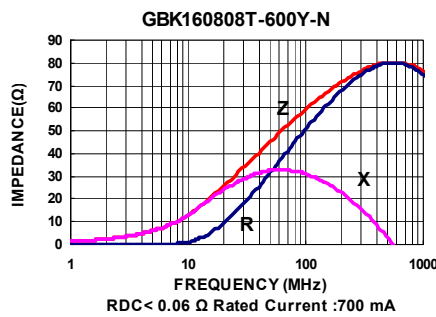
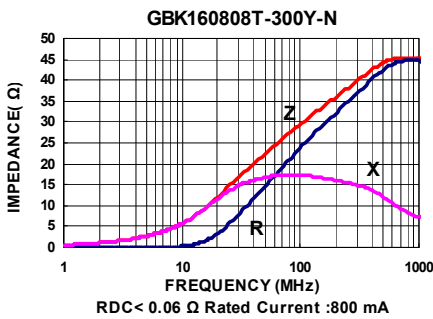

Please be sure to request approval specifications that provide further details of the products. Kindly note that the content of these specifications are subject to change or may be discontinued without advance notice. Please contact our sales department before ordering.

Electrical Characteristics

Part Number	Impedance ($\Omega \pm 25\%$)	Test Frequency (MHz)	RDC (Ω) Max	Rated current (mA) Max
GBK201209T-600Y-N	60	100	0.10	900
GBK201209T-121Y-N	120	100	0.15	800
GBK201209T-221Y-N	220	100	0.18	750
GBK201209T-301Y-N	300	100	0.18	700
GBK201209T-601Y-N	600	100	0.25	500
GBK201209T-102Y-N	1000	100	0.30	400
GBK201209T-152Y-N	1500	100	0.40	400
GBK201209T-202Y-N	2000	100	0.55	400

Note: When ordering, please specify tolerance code. Tolerance : Y= $\pm 25\%$

- Operating temperature range - 55°C ~ 125°C(Including self - temperature rise)
- Rate Current : Applied the current to coils, the temperature rise shall not be more than 30°C
- Measure Equipment :
 Z : HP4291A
 RDC : HP4338B or CHEN HWA 502

Test Instruments : Agilent E4991A Impedance / Material Analyzer

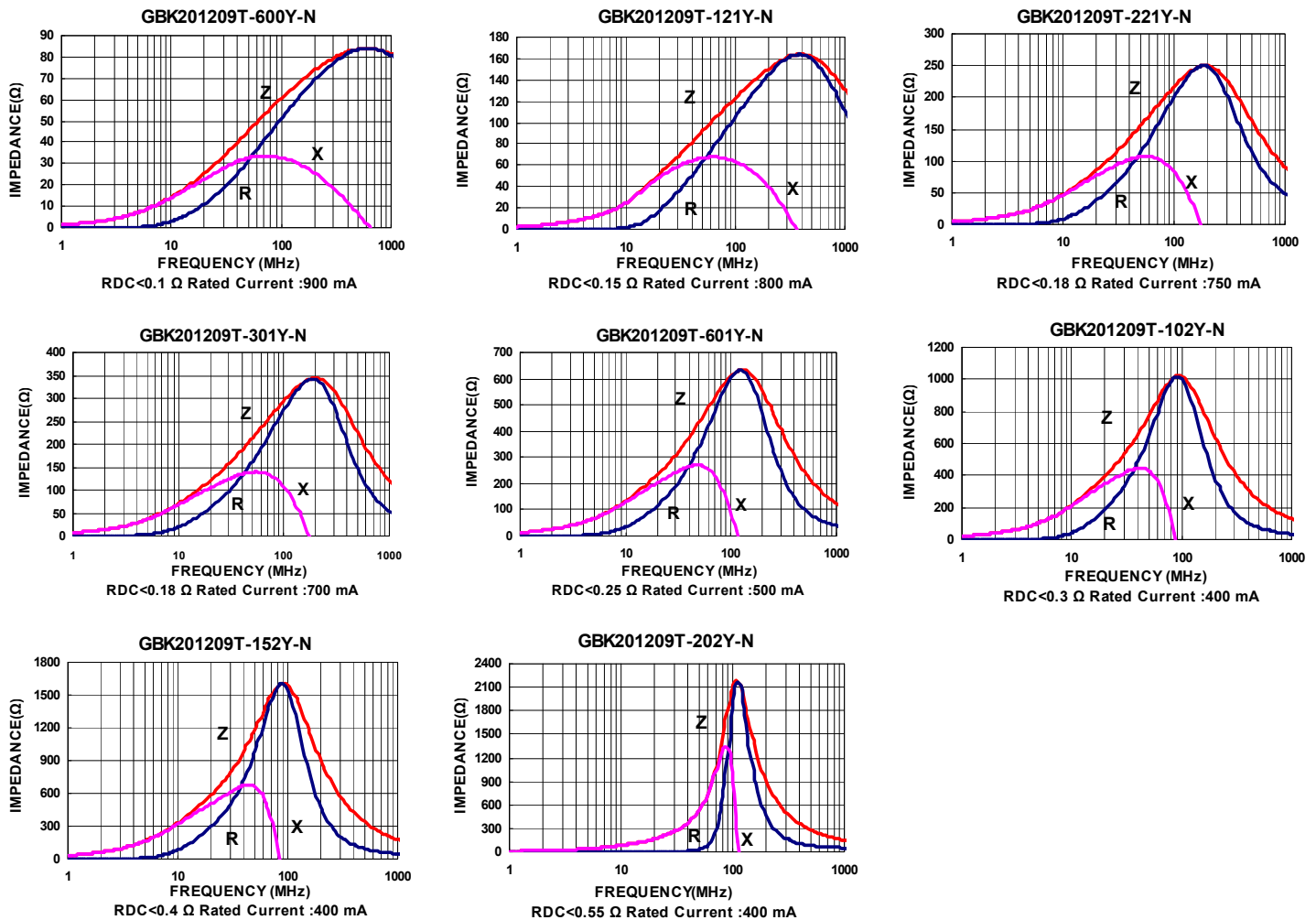

Please be sure to request approval specifications that provide further details of the products. Kindly note that the content of these specifications are subject to change or may be discontinued without advance notice. Please contact our sales department before ordering.

Packaging Specifications

Tape Dimensions

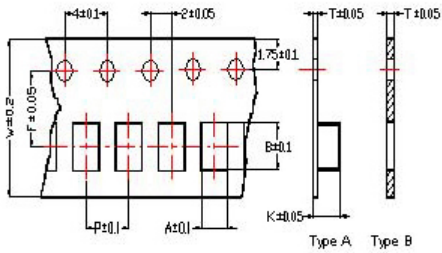

Tape Material

Carrier Tape: Polycarbonate (Tape A)
 Carrier Tape: Paper (Tape B)
 Cover Tape: Polystyrene

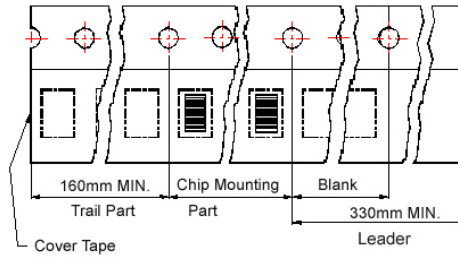

Reel Dimensions

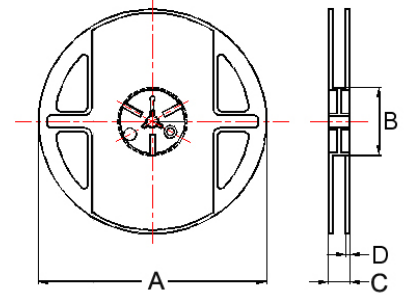

- ① : SBY / SBJ / NB / PB
- ② : SBY / SBJ / NB / PB / UPB / HF ③ : UPB
- ④ : SBK / SBJ / GB / PB / NB / UPB / VPB
- ⑤ : SBK / GB / PB / UPB ⑥ : SBY / SBK / PBY / UPB

Dimensions in mm

TYPE	Tape Dimensions								Reel Dimensions				Quantity PCS / REEL
	A	B	T	W	P	F	K	Tape	A	B	C	D	
①060303	0.37	0.67	0.42	8.0	2.0	3.5	-	B	178	60	10	2	15000
②100505	0.62	1.12	0.60	8.0	2.0	3.5	-	B	178	60	12	2	10000
③160805	1.05	1.85	0.60	8.0	2.0	3.5	-	B	178	60	12	2	10000
④160808	1.05	1.85	0.95	8.0	4.0	3.5	-	B	178	60	12	2	4000
⑤201209	1.50	2.30	0.97	8.0	4.0	3.5	-	B	178	60	12	2	4000
⑥321611	1.88	3.50	0.22	8.0	4.0	3.5	1.27	A	178	60	12	2	3000

Multilayer Ferrite Chip Beads



Chilisin offers a wide range of multi-layered ferrite chip beads with various sizes, frequency characteristics, and impedance values for EMI solutions. These ferrite formulas are used to compose seven types of EMI suppression chip beads: SB, GB, PB, UPB, NB, HF, and VPB series.

Product Identification



- Product symbol: SB, GB, PB, UPB, NB, HF, VPB
- Packaging: T : Tape and Reel ; B : Bulk
- Tolerance: Y = ± 25%; M = ± 20%; T:±30%
- Note: RoHS Compliant

Shape and Dimensions



Recommended Pattern

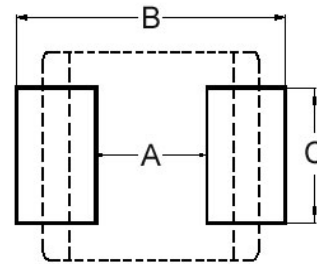

Dimensions in mm

TYPE	A	B	C	D
①060303	0.6±0.03	0.30±0.03	0.3±0.03	0.15±0.05
②100505	1.0±0.10	0.50±0.10	0.5±0.10	0.25±0.10
③160805	1.6±0.15	0.80±0.15	0.5±0.15	0.3±0.2
④160808	1.6±0.15	0.80±0.15	0.8±0.15	0.3±0.2
⑤201209	2.0±0.20	1.25±0.20	0.9±0.20	0.5±0.3
⑥321611	3.2±0.20	1.60±0.20	1.1±0.20	0.5±0.3

- ① : SBY / SBJ / NB / PB ② : SBY / SBJ / NB / PB / UPB / HF
 ③ : UPB ④ : SBK / SBJ / GB / PB / NB / UPB / VPB
 ⑤ : SBK / GB / PB / UPB ⑥ : SBY / SBK / PB / UPB

Dimensions in mm

TYPE	A	B	C
①060303	0.2 ~ 0.3	0.75 ~ 1.05	0.3
②100505	0.4	1.2 ~ 1.4	0.5
③160805	0.7 ~ 0.8	1.8 ~ 2.0	0.6 ~ 0.8
④160808	0.7 ~ 0.8	1.8 ~ 2.0	0.6 ~ 0.8
⑤201209	1.0 ~ 1.2	2.6 ~ 4.0	1.0 ~ 1.2
⑥321611	2.0	4.2 ~ 5.2	1.2

* Don't apply narrower pattern than listed above to PB and UPB. Narrow pattern might cause excessive heat or open circuit.

Dimension Conversion

Code	Dimension in mm (AxBxC)	EIA
060303	0.6X0.3X0.3	0201
100505	1.0X0.5X0.5	0402
160805	1.6x0.8x0.5	0603
160808	1.6x0.8x0.8	0603
201209	2.0x1.2x0.9	0805
321611	3.2x1.6x.1.1	1206

Electrical Characteristics

Part Number	Impedance ($\Omega \pm 25\%$)	Test Frequency (MHz)	RDC (Ω) Max	Rated current (mA) Max
NBQ060303T-100Y-N	10	100	0.4	300
NBQ060303T-220Y-N	22	100	0.5	200
NBQ060303T-470Y-N	47	100	0.7	200
NBQ060303T-750Y-N	75	100	1.0	200
NBQ060303T-121Y-N	120	100	1.5	100

Note: When ordering, please specify tolerance code. Tolerance : Y= $\pm 25\%$

- Operating temperature range - 55°C ~ 125°C(Including self - temperature rise)
- Rate Current : Applied the current to coils, the temperature rise shall not be more than 30°C
- Measure Equipment :
Z : HP4291A
RDC : HP4338B or CHEN HWA 502

Test Instruments : Agilent E4991A Impedance / Material Analyzer

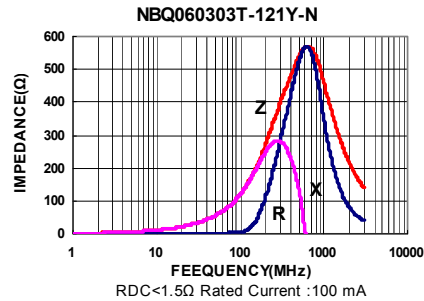
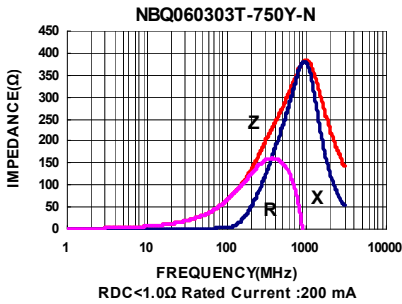
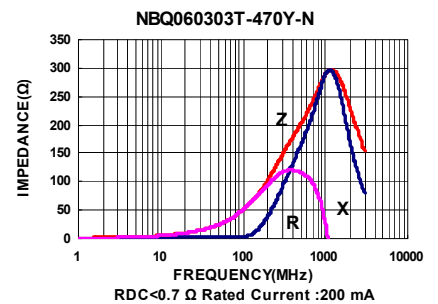
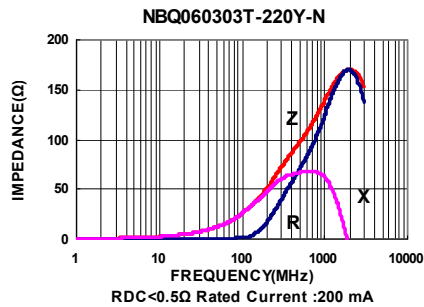
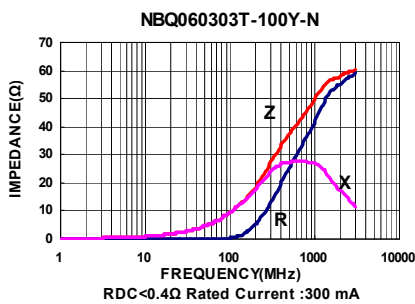

Please be sure to request approval specifications that provide further details of the products. Kindly note that the content of these specifications are subject to change or may be discontinued without advance notice. Please contact our sales department before ordering.

Electrical Characteristics

Part Number	Impedance ($\Omega \pm 25\%$)	Test Frequency (MHz)	RDC (Ω) Max	Rated current (mA) Max
NBQ100505T-100Y-N	10	100	0.10	500
NBQ100505T-470Y-N	47	100	0.30	400
NBQ100505T-750Y-N	75	100	0.30	400
NBQ100505T-121Y-N	120	100	0.40	350
NBQ100505T-221Y-N	220	100	0.60	200
NBQ100505T-301Y-N	300	100	0.80	200
NBQ100505T-471Y-N	470	100	1.10	200
NBQ100505T-601Y-N	600	100	1.20	200

Note: When ordering, please specify tolerance code. Tolerance : Y= $\pm 25\%$

- Operating temperature range - 55°C ~ 125°C(Including self - temperature rise)
- Rate Current : Applied the current to coils, the temperature rise shall not be more than 30°C
- Measure Equipment :
Z : HP4291A
RDC : HP4338B or CHEN HWA 502

Test Instruments : Agilent E4991A Impedance / Material Analyzer

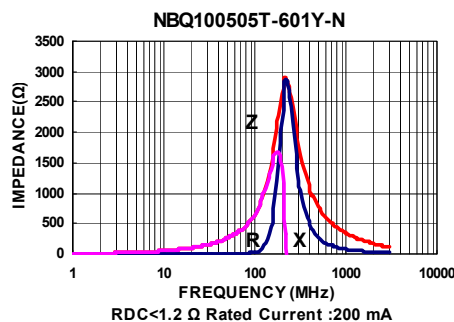
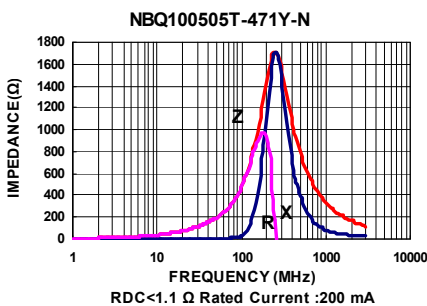
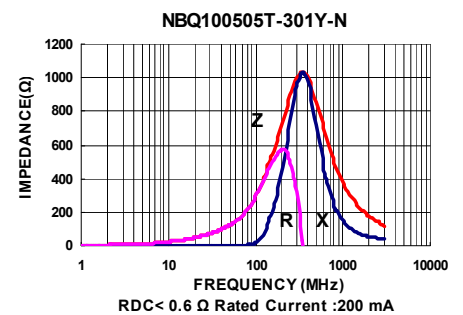
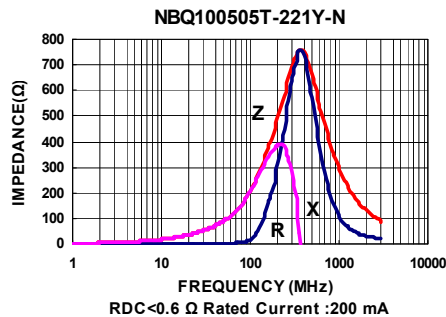
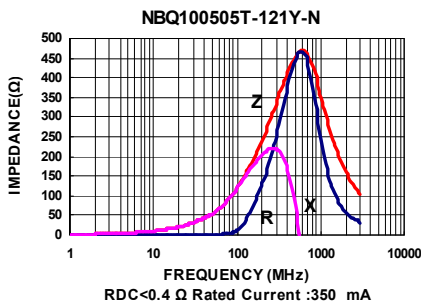
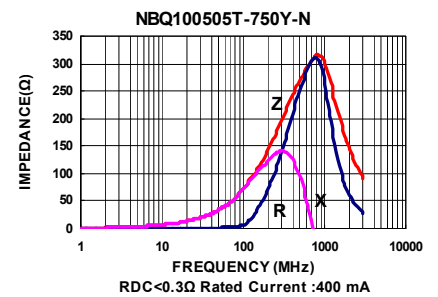
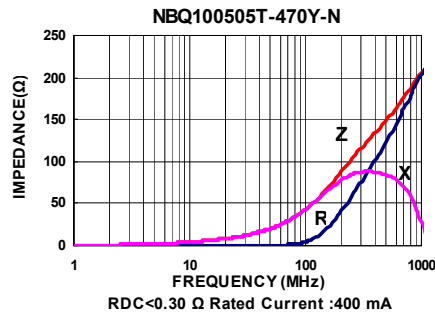
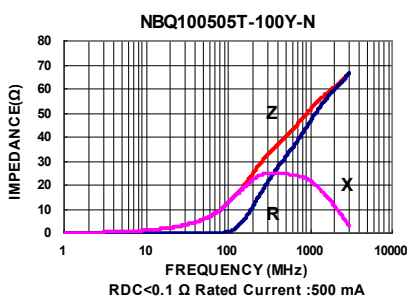

Please be sure to request approval specifications that provide further details of the products. Kindly note that the content of these specifications are subject to change or may be discontinued without advance notice. Please contact our sales department before ordering.

Electrical Characteristics

Part Number	Impedance ($\Omega \pm 25\%$)	Test Frequency (MHz)	RDC (Ω) Max	Rated current (mA) Max
NBQ160808T-600Y-N	60	100	0.25	500
NBQ160808T-750Y-N	75	100	0.25	500
NBQ160808T-121Y-N	120	100	0.30	400
NBQ160808T-241Y-N	240	100	0.35	400
NBQ160808T-301Y-N	300	100	0.40	400
NBQ160808T-601Y-N	600	100	0.50	200
NBQ160808T-102Y-N	1000	100	0.60	200
NBQ160808T-182Y-N	1800	100	0.80	100
NBQ160808T-222Y-N	2200	100	1.0	100
NBQ160808T-252Y-N	2500	100	1.0	100

Note: When ordering, please specify tolerance code. Tolerance : Y=±25%

- Operating temperature range - 55°C ~ 125°C(Including self - temperature rise)
- Rate Current : Applied the current to coils, the temperature rise shall not be more than 30°C
- Measure Equipment :
Z : HP4291A
RDC : HP4338B or CHEN HWA 502

Test Instruments : Agilent E4991A Impedance / Material Analyzer

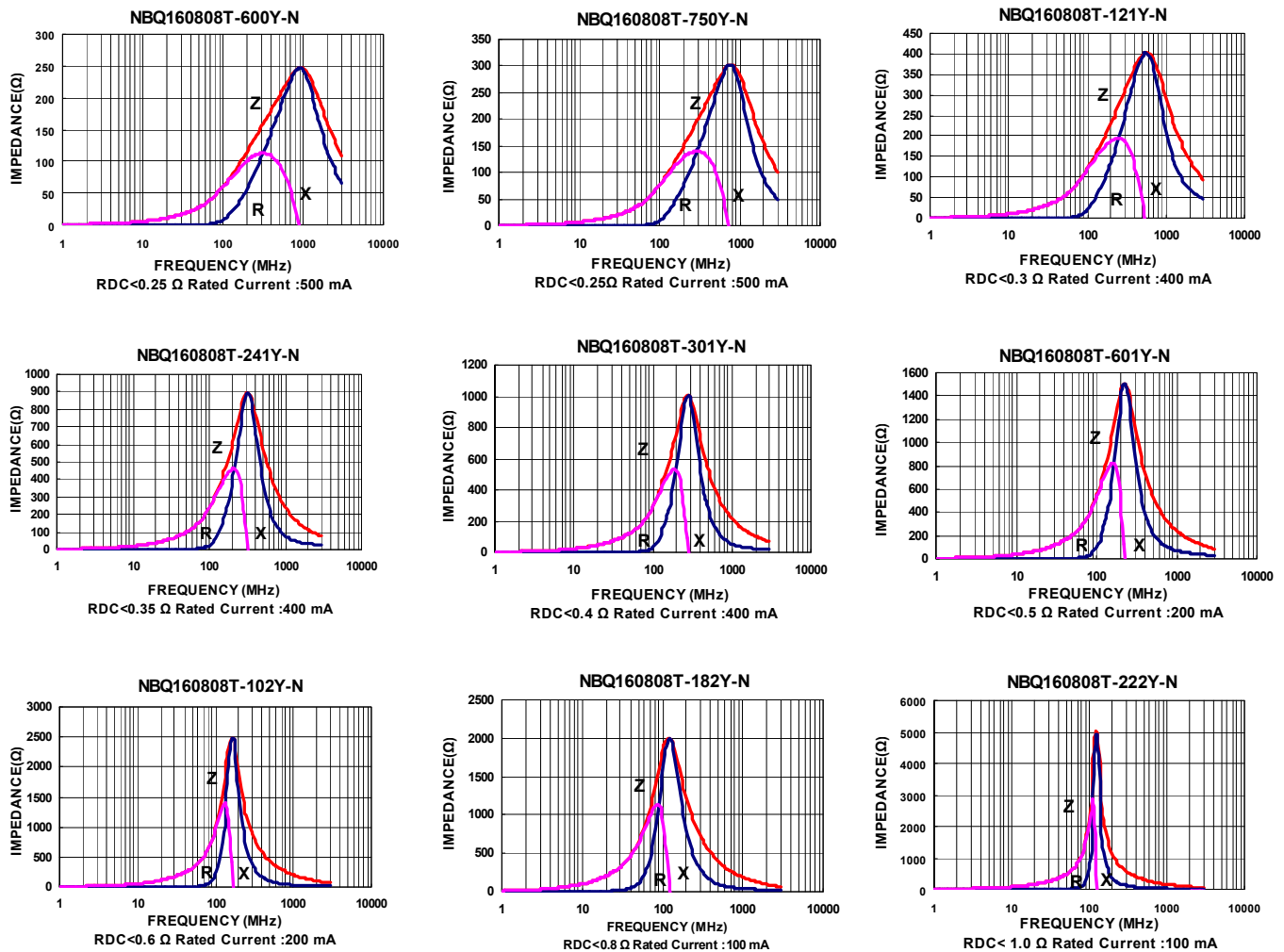

Please be sure to request approval specifications that provide further details of the products. Kindly note that the content of these specifications are subject to change or may be discontinued without advance notice. Please contact our sales department before ordering.

Packaging Specifications

Tape Dimensions

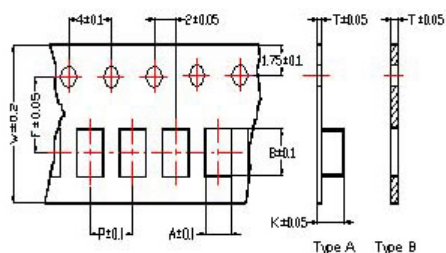

Tape Material

Carrier Tape: Polycarbonate (Tape A)
 Carrier Tape: Paper (Tape B)
 Cover Tape: Polystyrene

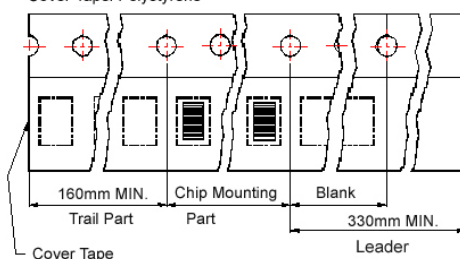

Reel Dimensions

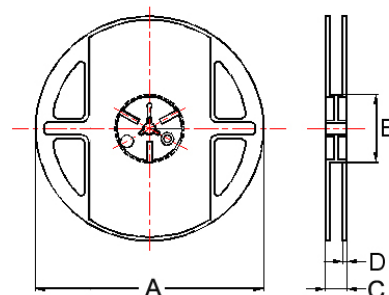

- ① : SBY / SBJ / NB / PB
- ② : SBY / SBJ / NB / PB / UPB / HF ③ : UPB
- ④ : SBK / SBJ / GB / PB / NB / UPB / VPB
- ⑤ : SBK / GB / PB / UPB ⑥ : SBY / SBK / PBY / UPB

Dimensions in mm

TYPE	Tape Dimensions								Reel Dimensions				Quantity PCS / REEL
	A	B	T	W	P	F	K	Tape	A	B	C	D	
①060303	0.37	0.67	0.42	8.0	2.0	3.5	-	B	178	60	10	2	15000
②100505	0.62	1.12	0.60	8.0	2.0	3.5	-	B	178	60	12	2	10000
③160805	1.05	1.85	0.60	8.0	2.0	3.5	-	B	178	60	12	2	10000
④160808	1.05	1.85	0.95	8.0	4.0	3.5	-	B	178	60	12	2	4000
⑤201209	1.50	2.30	0.97	8.0	4.0	3.5	-	B	178	60	12	2	4000
⑥321611	1.88	3.50	0.22	8.0	4.0	3.5	1.27	A	178	60	12	2	3000

Multilayer Ferrite Chip Beads



Chilisin offers a wide range of multi-layered ferrite chip beads with various sizes, frequency characteristics, and impedance values for EMI solutions. These ferrite formulas are used to compose seven types of EMI suppression chip beads: SB, GB, PB, UPB, NB, HF, and VPB series.

Product Identification

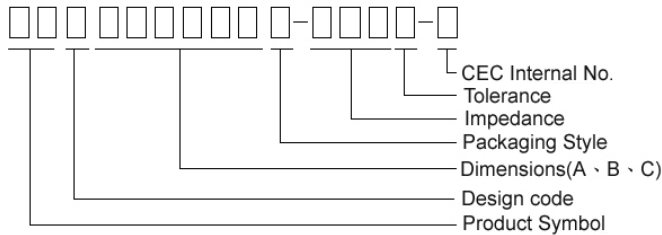

- Product symbol: SB, GB, PB, UPB, NB, HF, VPB
- Packaging: T : Tape and Reel ; B : Bulk
- Tolerance: Y = ± 25%; M = ± 20%; T:±30%
- Note: RoHS Compliant

Shape and Dimensions



Recommended Pattern

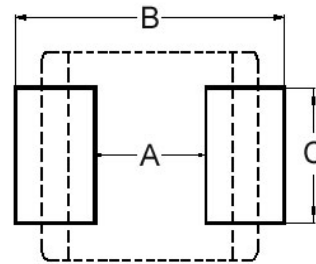

Dimensions in mm

TYPE	A	B	C	D
①060303	0.6±0.03	0.30±0.03	0.3±0.03	0.15±0.05
②100505	1.0±0.10	0.50±0.10	0.5±0.10	0.25±0.10
③160805	1.6±0.15	0.80±0.15	0.5±0.15	0.3±0.2
④160808	1.6±0.15	0.80±0.15	0.8±0.15	0.3±0.2
⑤201209	2.0±0.20	1.25±0.20	0.9±0.20	0.5±0.3
⑥321611	3.2±0.20	1.60±0.20	1.1±0.20	0.5±0.3

Dimensions in mm

TYPE	A	B	C
①060303	0.2 ~ 0.3	0.75 ~ 1.05	0.3
②100505	0.4	1.2 ~ 1.4	0.5
③160805	0.7 ~ 0.8	1.8 ~ 2.0	0.6 ~ 0.8
④160808	0.7 ~ 0.8	1.8 ~ 2.0	0.6 ~ 0.8
⑤201209	1.0 ~ 1.2	2.6 ~ 4.0	1.0 ~ 1.2
⑥321611	2.0	4.2 ~ 5.2	1.2

- ① : SBY / SBJ / NB / PB ② : SBY / SBJ / NB / PB / UPB / HF
 ③ : UPB ④ : SBK / SBJ / GB / PB / NB / UPB / VPB
 ⑤ : SBK / GB / PB / UPB ⑥ : SBY / SBK / PB / UPB

* Don't apply narrower pattern than listed above to PB and UPB. Narrow pattern might cause excessive heat or open circuit.

Dimension Conversion

Code	Dimension in mm (AxBxC)	EIA
060303	0.6X0.3X0.3	0201
100505	1.0X0.5X0.5	0402
160805	1.6x0.8x0.5	0603
160808	1.6x0.8x0.8	0603
201209	2.0x1.2x0.9	0805
321611	3.2x1.6x.1.1	1206

Electrical Characteristics

Part Number	Impedance ($\Omega \pm 25\%$)	Test Frequency (MHz)	RDC (Ω) Max	Rated current (mA) Max
PBY060303T-100Y-N	10	100	0.050	1000
PBY060303T-220Y-N	22	100	0.065	1000
PBY060303T-330Y-N	33	100	0.090	750
PBY060303T-470Y-N	47	100	0.120	500
PBY060303T-800Y-N	80	100	0.180	500
PBY060303T-121Y-N	120	100	0.230	450
PBY060303T-241Y-N	240	100	0.400	350
PBY060303T-331Y-N	330	100	0.500	300

Note: When ordering, please specify tolerance code. Tolerance : Y= $\pm 25\%$

- Operating temperature range - 55°C ~ 125°C(Including self - temperature rise)
- Rate Current : Applied the current to coils, the temperature rise shall not be more than 30°C
- Measure Equipment :
Z : HP4291A
RDC : HP4338B or CHEN HWA 502

Test Instruments : Agilent E4991A Impedance / Material Analyzer

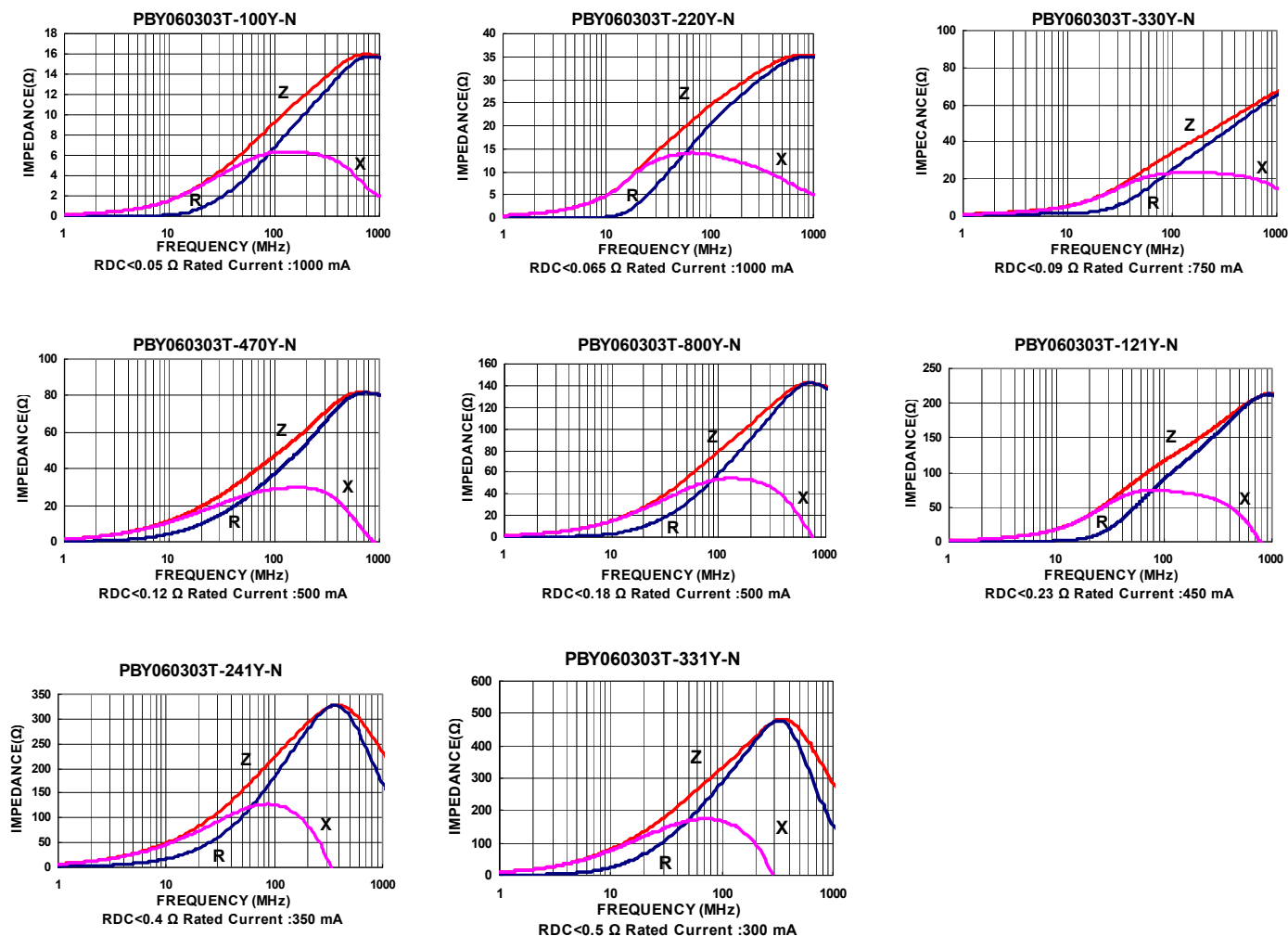

Please be sure to request approval specifications that provide further details of the products. Kindly note that the content of these specifications are subject to change or may be discontinued without advance notice. Please contact our sales department before ordering.

Electrical Characteristics

Part Number	Impedance ($\Omega \pm 25\%$)	Test Frequency (MHz)	RDC (Ω) Max	Rated current (mA) Max
PBY100505T-100Y-N	10	100	0.03	2000
PBY100505T-250Y-N	25	100	0.05	1700
PBY100505T-300Y-N	30	100	0.05	1700
PBY100505T-320Y-N	32	100	0.05	1700
PBY100505T-400Y-N	40	100	0.075	1500
PBY100505T-500Y-N	50	100	0.075	1500
PBY100505T-600Y-N	60	100	0.075	1500
PBY100505T-680Y-N	68	100	0.09	1200
PBY100505T-700Y-N	70	100	0.09	1200
PBY100505T-800Y-N	80	100	0.09	1200
PBY100505T-101Y-N	100	100	0.09	1200
PBY100505T-121Y-N	120	100	0.09	1400
PBY100505T-151Y-N	150	100	0.14	1400
PBY100505T-181Y-N	180	100	0.14	900
PBY100505T-221Y-N	220	100	0.18	1100
PBY100505T-601Y-N	600	100	0.34	700
PBY100505T-102Y-N	1000	100	0.49	500

Note: When ordering, please specify tolerance code. Tolerance : Y= $\pm 25\%$

- Operating temperature range - 55°C ~ 125°C(Including self - temperature rise)
- Rate Current : Applied the current to coils, the temperature rise shall not be more than 30°C
- Measure Equipment :
Z : HP4291A
RDC : HP4338B or CHEN HWA 502

Test Instruments : Agilent E4991A Impedance / Material Analyzer

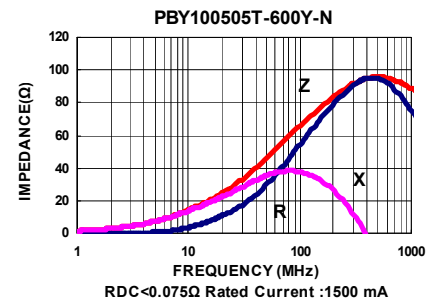
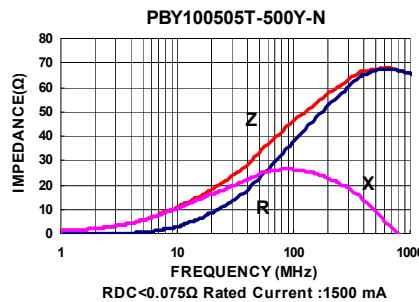
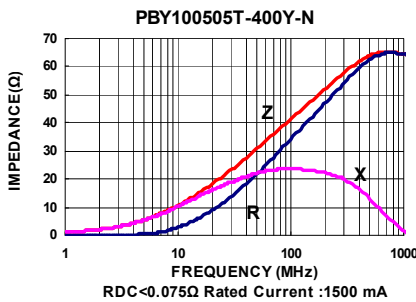
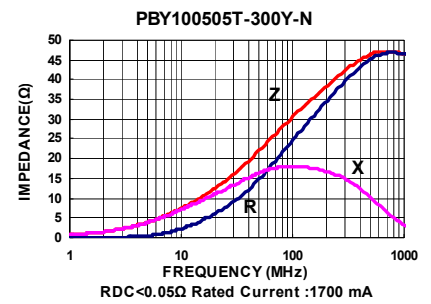
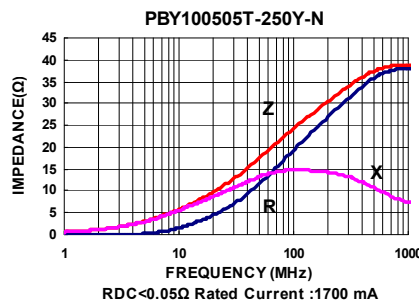
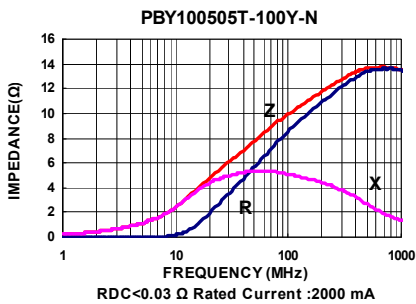

Please be sure to request approval specifications that provide further details of the products. Kindly note that the content of these specifications are subject to change or may be discontinued without advance notice. Please contact our sales department before ordering.

Test Instruments : Agilent E4991A Impedance / Material Analyzer

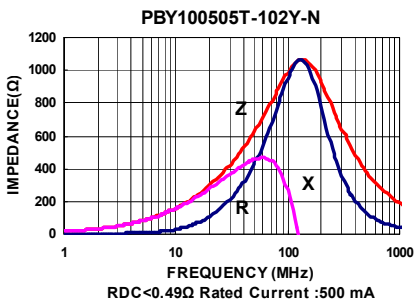
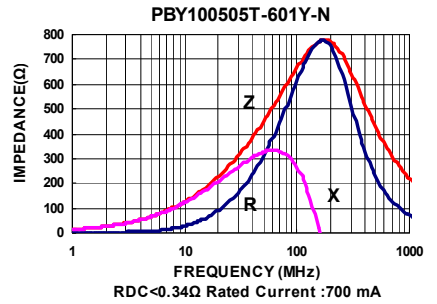
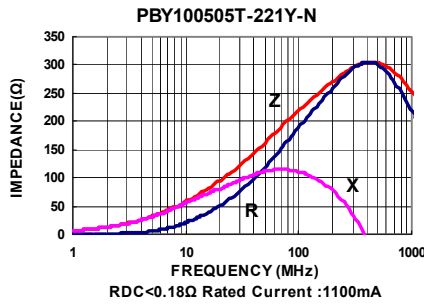
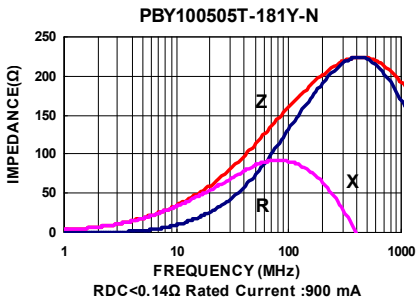
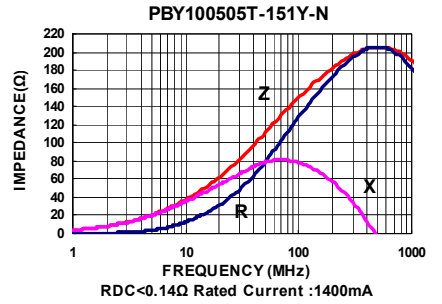
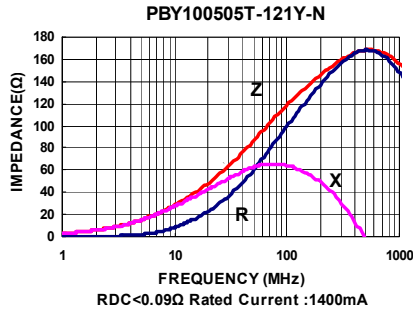
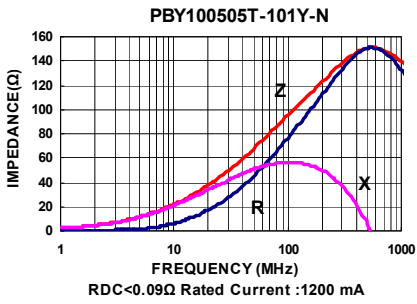
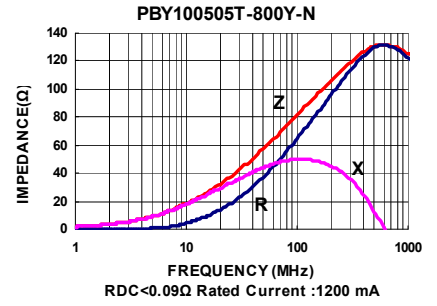
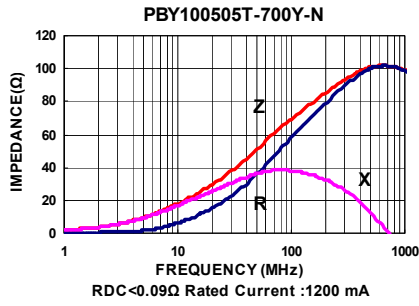
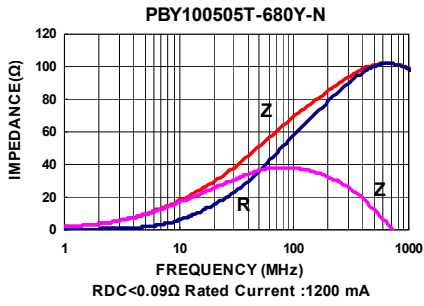

Please be sure to request approval specifications that provide further details of the products. Kindly note that the content of these specifications are subject to change or may be discontinued without advance notice. Please contact our sales department before ordering.

Electrical Characteristics

Part Number	Impedance ($\Omega \pm 25\%$)	Test Frequency (MHz)	RDC (Ω) Max	Rated current (mA) Max
PBY160808T-100Y-N	10	100	0.020	4000
PBY160808T-110Y-N	11	100	0.020	4000
PBY160808T-300Y-N	30	100	0.030	3000
PBY160808T-330Y-N	33	100	0.035	3000
PBY160808T-400Y-N	40	100	0.035	3000
PBY160808T-600Y-N	60	100	0.040	3000
PBY160808T-800Y-N	80	100	0.050	2500
PBY160808T-101Y-N	100	100	0.050	2500
PBY160808T-121Y-N	120	100	0.080	2500
PBY160808T-151Y-N	150	100	0.085	2000
PBY160808T-181Y-N	180	100	0.090	2000
PBY160808T-221Y-N	220	100	0.100	2000
PBY160808T-301Y-N	300	100	0.120	1500
PBY160808T-331Y-N	330	100	0.120	1500
PBY160808T-471Y-N	470	100	0.150	1500
PBY160808T-601Y-N	600	100	0.200	1000
PBY160808T-102Y-N	1000	100	0.250	800
PBY160808T-122Y-N	1200	100	0.250	800
PBY160808T-152Y-N	1500	100	0.400	500

Note: When ordering, please specify tolerance code. Tolerance : Y= $\pm 25\%$

- Operating temperature range - 55°C ~ 125°C(Including self - temperature rise)
- Rate Current : Applied the current to coils, the temperature rise shall not be more than 30°C
- Measure Equipment :
Z : HP4291A
RDC : HP4338B or CHEN HWA 502

Test Instruments : Agilent E4991A Impedance / Material Analyzer

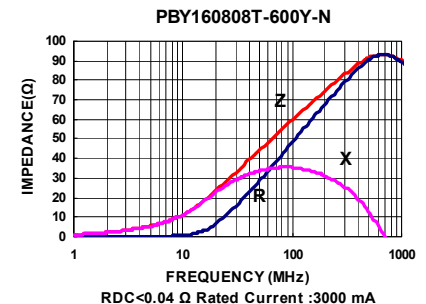
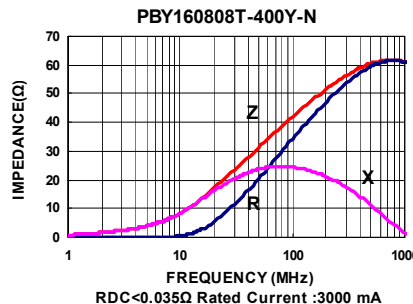
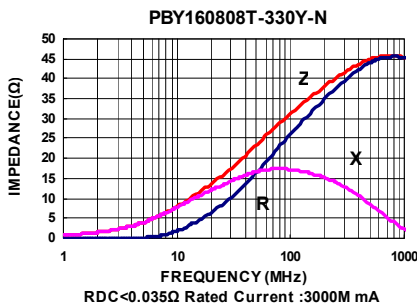
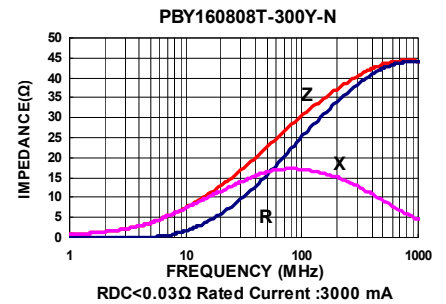
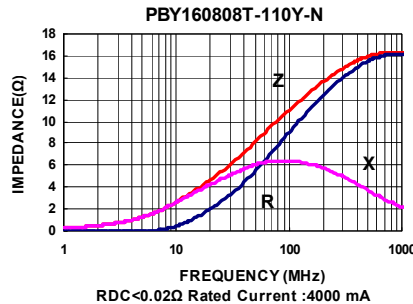
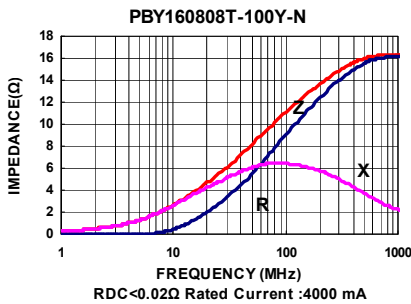

Please be sure to request approval specifications that provide further details of the products. Kindly note that the content of these specifications are subject to change or may be discontinued without advance notice. Please contact our sales department before ordering.

Test Instruments : Agilent E4991A Impedance / Material Analyzer

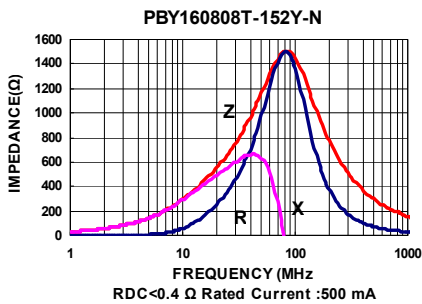
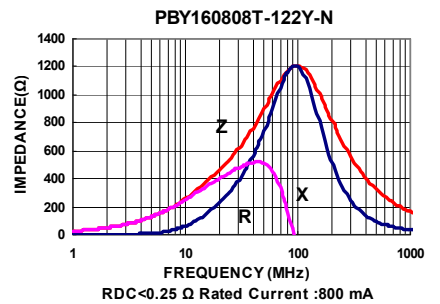
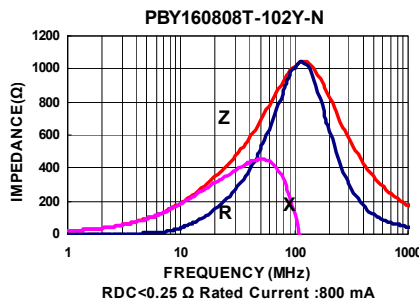
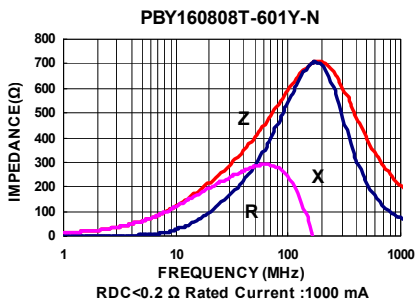
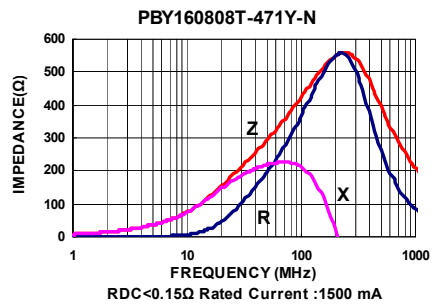
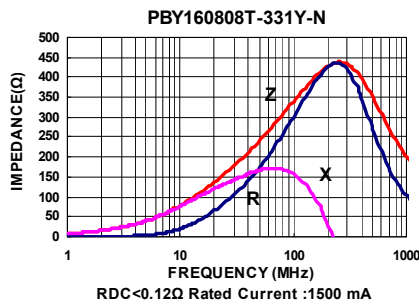
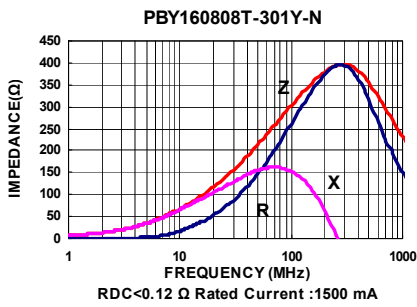
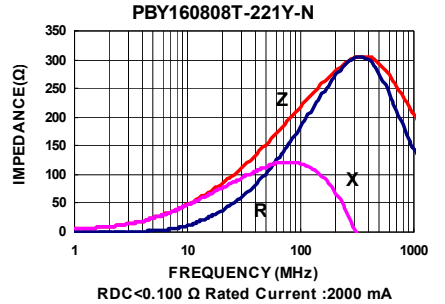
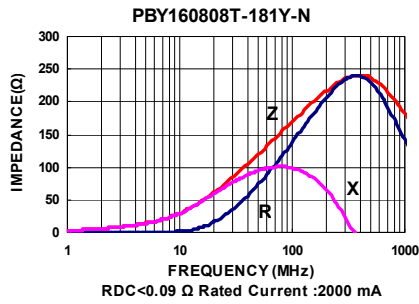
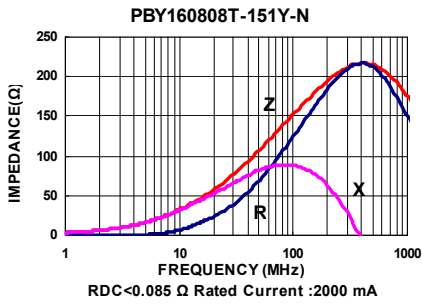
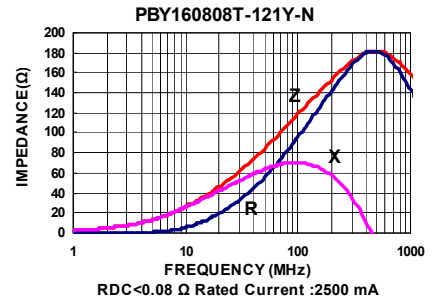
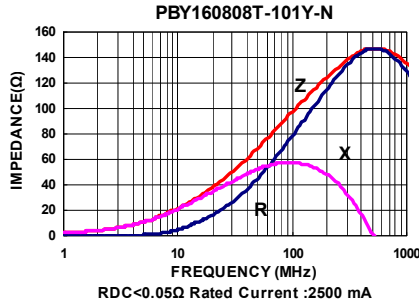
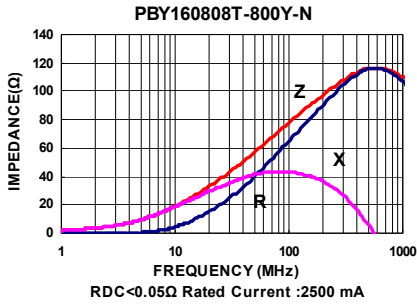

Please be sure to request approval specifications that provide further details of the products. Kindly note that the content of these specifications are subject to change or may be discontinued without advance notice. Please contact our sales department before ordering.

Electrical Characteristics

Part Number	Impedance ($\Omega \pm 25\%$)	Test Frequency (MHz)	RDC (Ω) Max	Rated current (mA) Max
PBY201209T-100Y-N	10	100	0.01	6000
PBY201209T-110Y-N	11	100	0.01	6000
PBY201209T-170Y-N	17	100	0.02	5000
PBY201209T-300Y-N	30	100	0.015	4000
PBY201209T-500Y-N	50	100	0.025	3000
PBY201209T-600Y-N	60	100	0.03	3000
PBY201209T-800Y-N	80	100	0.04	3000
PBY201209T-101Y-N	100	100	0.04	3000
PBY201209T-121Y-N	120	100	0.04	3000
PBY201209T-221Y-N	220	100	0.08	2000
PBY201209T-301Y-N	300	100	0.08	2000
PBY201209T-331Y-N	330	100	0.08	2000
PBY201209T-471Y-N	470	100	0.10	2000
PBY201209T-601Y-N	600	100	0.10	2000
PBY201209T-102Y-N	1000	100	0.12	1500
PBY201209T-152Y-N	1500	100	0.30	1000

Note: When ordering, please specify tolerance code. Tolerance : Y= $\pm 25\%$

- Operating temperature range - 55°C ~ 125°C(Including self - temperature rise)
- Rate Current : Applied the current to coils, the temperature rise shall not be more than 30°C
- Measure Equipment :
 Z : HP4291A
 RDC : HP4338B or CHEN HWA 502

Test Instruments : Agilent E4991A Impedance / Material Analyzer

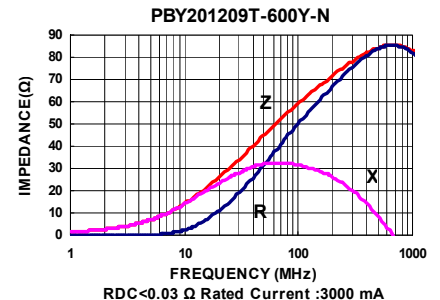
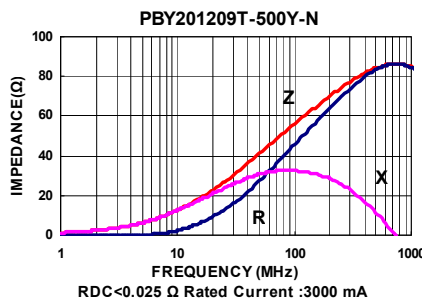
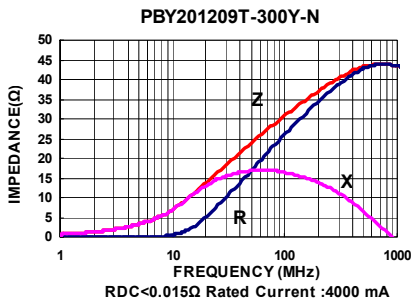
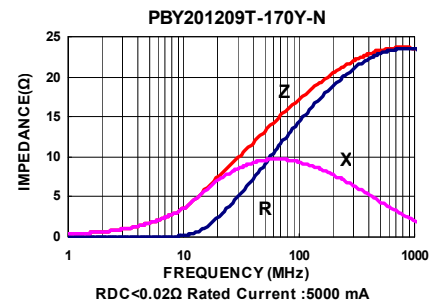
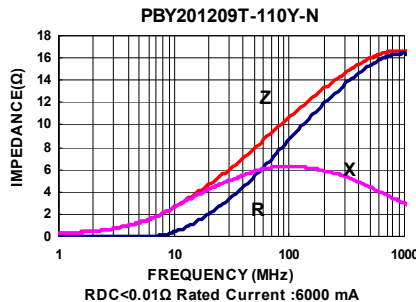
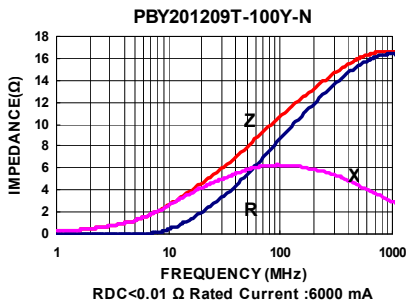

Please be sure to request approval specifications that provide further details of the products. Kindly note that the content of these specifications are subject to change or may be discontinued without advance notice. Please contact our sales department before ordering.

Test Instruments : Agilent E4991A Impedance / Material Analyzer

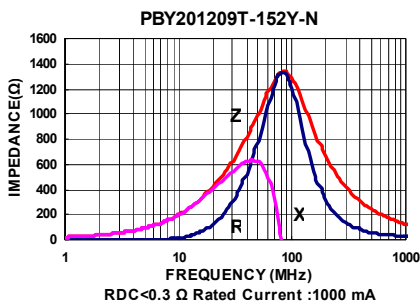
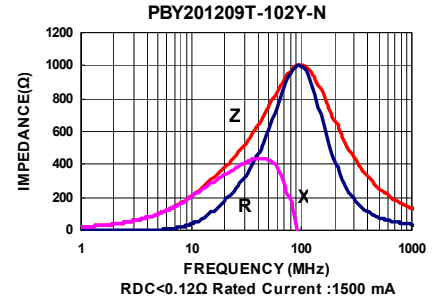
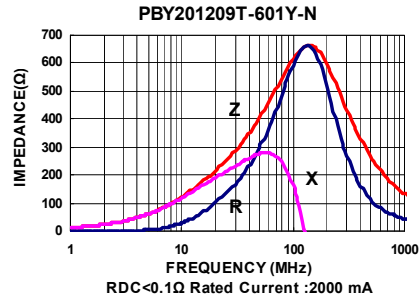
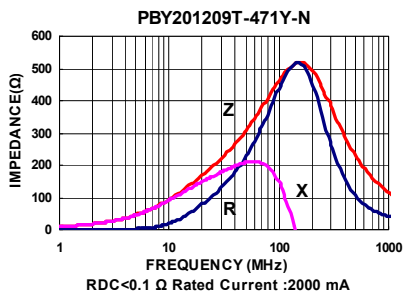
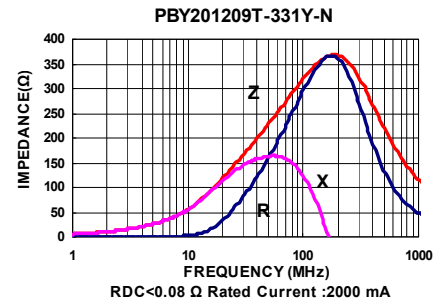
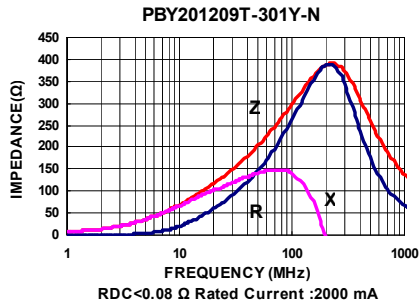
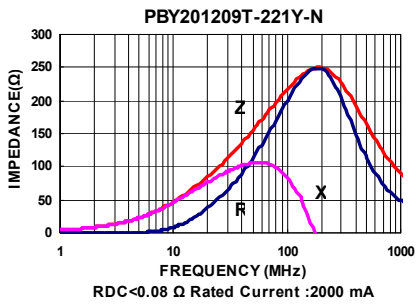
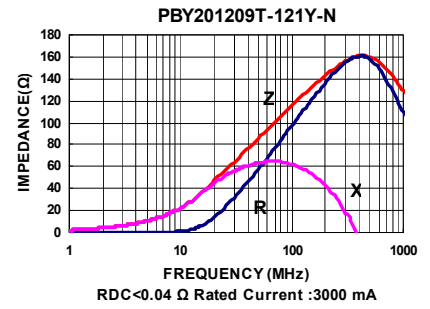
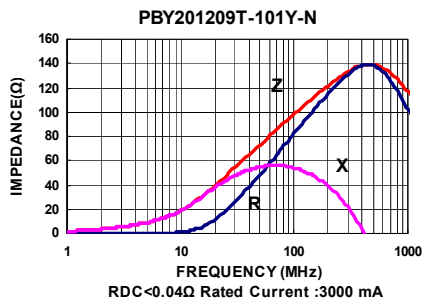
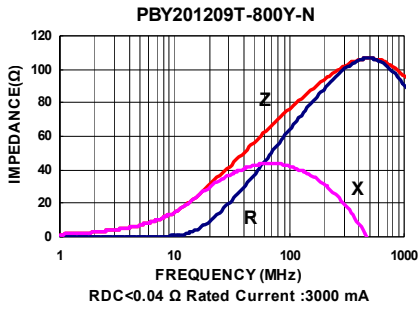

Please be sure to request approval specifications that provide further details of the products. Kindly note that the content of these specifications are subject to change or may be discontinued without advance notice. Please contact our sales department before ordering.

Electrical Characteristics

Part Number	Impedance ($\Omega \pm 25\%$)	Test Frequency (MHz)	RDC (Ω) Max	Rated current (mA) Max
PBY321611T-100Y-N	10	100	0.015	6000
PBY321611T-300Y-N	30	100	0.015	4000
PBY321611T-600Y-N	60	100	0.020	4000
PBY321611T-101Y-N	100	100	0.030	3000
PBY321611T-121Y-N	120	100	0.030	3000
PBY321611T-221Y-N	220	100	0.050	2000
PBY321611T-301Y-N	300	100	0.060	2000
PBY321611T-601Y-N	600	100	0.100	2000
PBY321611T-102Y-N	1000	50	0.150	1200
PBY321611T-122Y-N	1200	50	0.180	1000
PBY321611T-152Y-N	1500	50	0.200	800

Note: When ordering, please specify tolerance code. Tolerance : Y= $\pm 25\%$

- Operating temperature range - 55°C ~ 125°C(Including self - temperature rise)
- Rate Current : Applied the current to coils, the temperature rise shall not be more than 30°C
- Measure Equipment :
 - Z : HP4291A
 - RDC : HP4338B or CHEN HWA 502

Test Instruments : Agilent E4991A Impedance / Material Analyzer

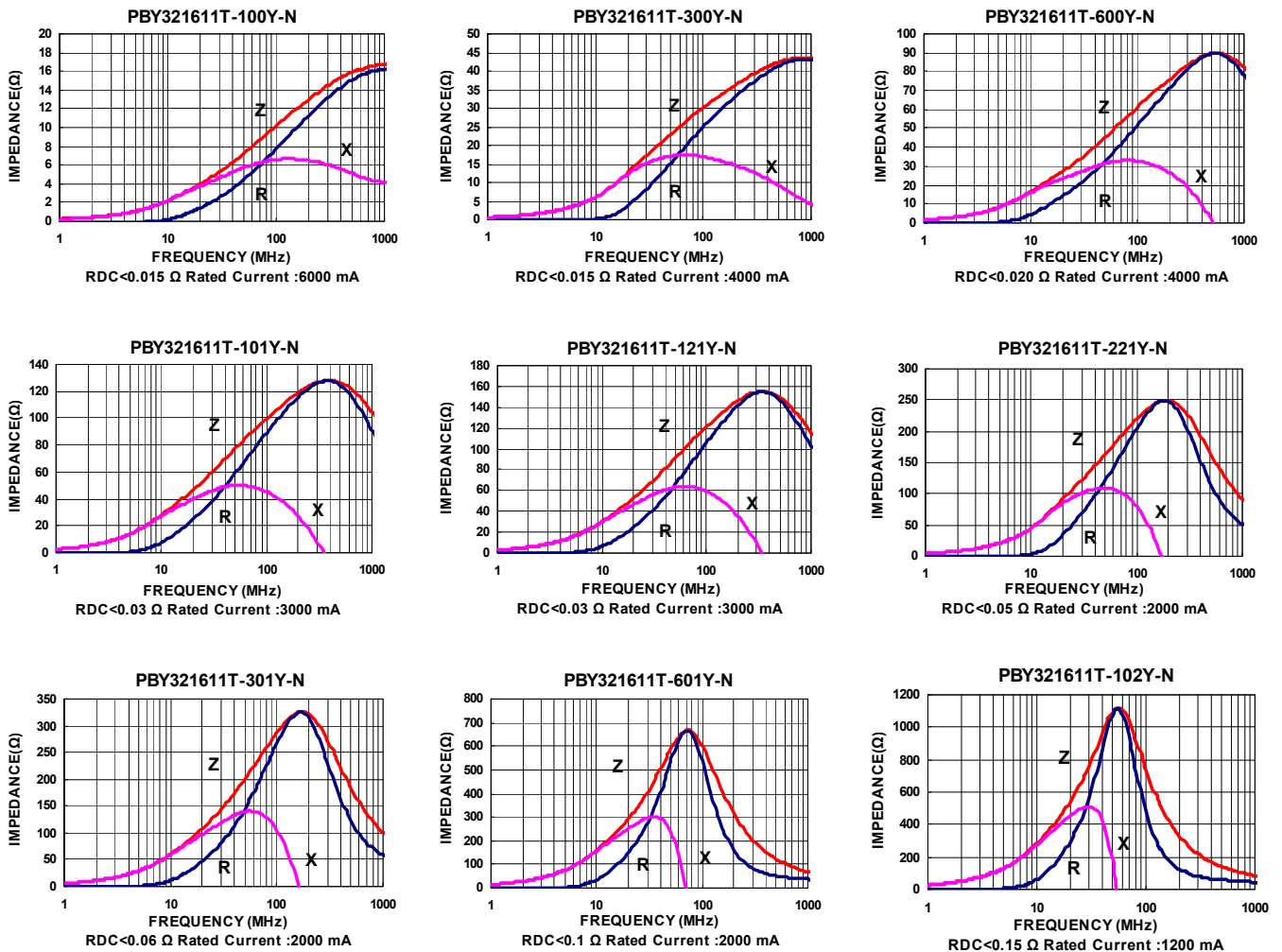

Please be sure to request approval specifications that provide further details of the products. Kindly note that the content of these specifications are subject to change or may be discontinued without advance notice. Please contact our sales department before ordering.

Packaging Specifications

Tape Dimensions

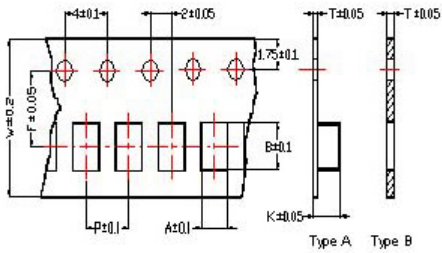

Tape Material

Carrier Tape: Polycarbonate (Tape A)
 Carrier Tape: Paper (Tape B)
 Cover Tape: Polystyrene

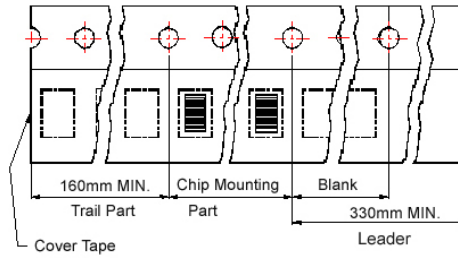

Reel Dimensions

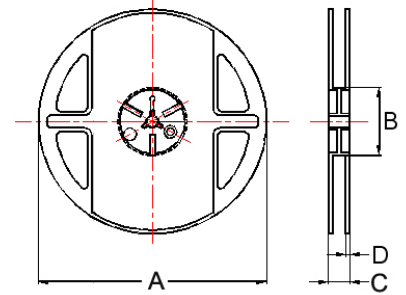

- ① : SBY / SBJ / NB / PB
- ② : SBY / SBJ / NB / PB / UPB / HF ③ : UPB
- ④ : SBK / SBJ / GB / PB / NB / UPB / VPB
- ⑤ : SBK / GB / PB / UPB ⑥ : SBY / SBK / PBY / UPB

Dimensions in mm

TYPE	Tape Dimensions								Reel Dimensions				Quantity PCS / REEL
	A	B	T	W	P	F	K	Tape	A	B	C	D	
①060303	0.37	0.67	0.42	8.0	2.0	3.5	-	B	178	60	10	2	15000
②100505	0.62	1.12	0.60	8.0	2.0	3.5	-	B	178	60	12	2	10000
③160805	1.05	1.85	0.60	8.0	2.0	3.5	-	B	178	60	12	2	10000
④160808	1.05	1.85	0.95	8.0	4.0	3.5	-	B	178	60	12	2	4000
⑤201209	1.50	2.30	0.97	8.0	4.0	3.5	-	B	178	60	12	2	4000
⑥321611	1.88	3.50	0.22	8.0	4.0	3.5	1.27	A	178	60	12	2	3000

Multilayer Ferrite Chip Beads



Chilisin offers a wide range of multi-layered ferrite chip beads with various sizes, frequency characteristics, and impedance values for EMI solutions. These ferrite formulas are used to compose seven types of EMI suppression chip beads: SB, GB, PB, UPB, NB, HF, and VPB series.

Product Identification

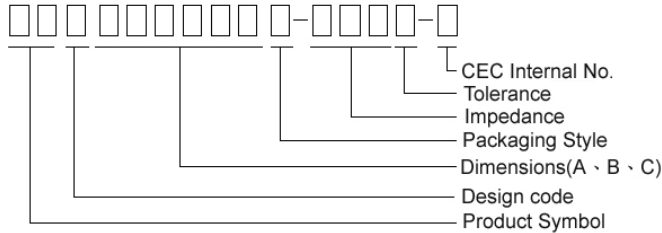

- Product symbol: SB, GB, PB, UPB, NB, HF, VPB
- Packaging: T : Tape and Reel ; B : Bulk
- Tolerance: Y = ± 25%; M = ± 20%; T:±30%
- Note: RoHS Compliant

Shape and Dimensions

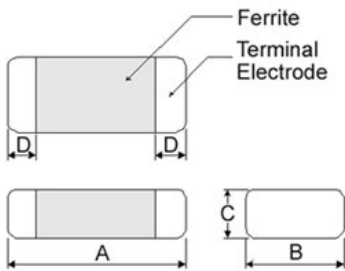

Recommended Pattern

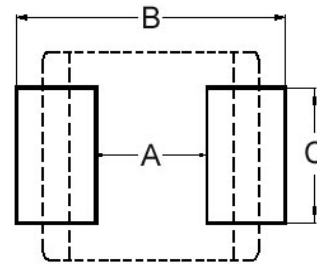

Dimensions in mm

TYPE	A	B	C	D
①060303	0.6±0.03	0.30±0.03	0.3±0.03	0.15±0.05
②100505	1.0±0.10	0.50±0.10	0.5±0.10	0.25±0.10
③160805	1.6±0.15	0.80±0.15	0.5±0.15	0.3±0.2
④160808	1.6±0.15	0.80±0.15	0.8±0.15	0.3±0.2
⑤201209	2.0±0.20	1.25±0.20	0.9±0.20	0.5±0.3
⑥321611	3.2±0.20	1.60±0.20	1.1±0.20	0.5±0.3

- ① : SBY / SBJ / NB / PB ② : SBY / SBJ / NB / PB / UPB / HF
 ③ : UPB ④ : SBK / SBJ / GB / PB / NB / UPB / VPB
 ⑤ : SBK / GB / PB / UPB ⑥ : SBY / SBK / PB / UPB

Dimensions in mm

TYPE	A	B	C
①060303	0.2 ~ 0.3	0.75 ~ 1.05	0.3
②100505	0.4	1.2 ~ 1.4	0.5
③160805	0.7 ~ 0.8	1.8 ~ 2.0	0.6 ~ 0.8
④160808	0.7 ~ 0.8	1.8 ~ 2.0	0.6 ~ 0.8
⑤201209	1.0 ~ 1.2	2.6 ~ 4.0	1.0 ~ 1.2
⑥321611	2.0	4.2 ~ 5.2	1.2

* Don't apply narrower pattern than listed above to PB and UPB. Narrow pattern might cause excessive heat or open circuit.

Dimension Conversion

Code	Dimension in mm (AxBxC)	EIA
060303	0.6X0.3X0.3	0201
100505	1.0X0.5X0.5	0402
160805	1.6x0.8x0.5	0603
160808	1.6x0.8x0.8	0603
201209	2.0x1.2x0.9	0805
321611	3.2x1.6x.1.1	1206

Electrical Characteristics

Part Number	Impedance ($\Omega \pm 25\%$)	Test Frequency (MHz)	RDC (Ω) Max	Rated current (mA) Max
VPB160808T-100Y-N	10	100	0.010	6000
VPB160808T-300Y-N	30	100	0.015	4000
VPB160808T-600Y-N	60	100	0.030	3000
VPB160808T-121Y-N	120	100	0.040	3000
VPB160808T-201Y-N	200	100	0.050	2500
VPB160808T-221Y-N	220	100	0.080	2000
VPB160808T-301Y-N	300	100	0.080	2000
VPB160808T-331Y-N	330	100	0.080	2000
VPB160808T-471Y-N	470	100	0.100	2000
VPB160808T-601Y-N	600	100	0.100	2000

Note: When ordering, please specify tolerance code. Tolerance : Y=±25%

- Operating temperature range - 55°C ~ 125°C(Including self - temperature rise)
- Rate Current : Applied the current to coils, the temperature rise shall not be more than 30°C
- Measure Equipment :
 Z : HP4291A
 RDC : HP4338B or CHEN HWA 502

Test Instruments : Agilent E4991A Impedance / Material Analyzer

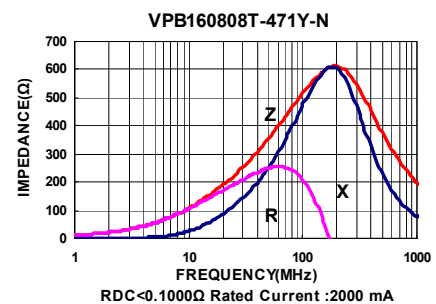
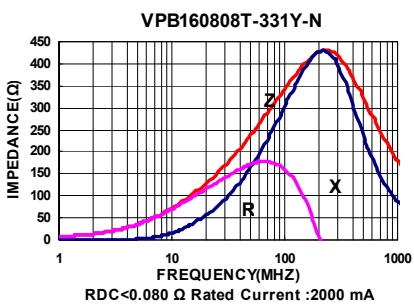
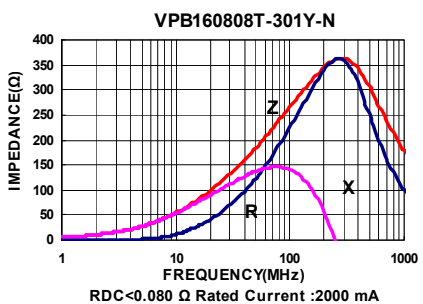
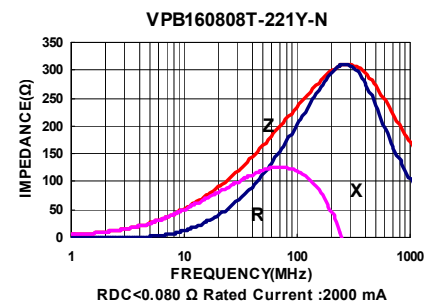
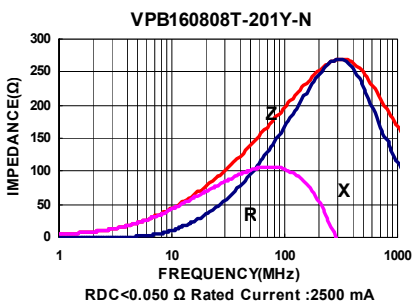
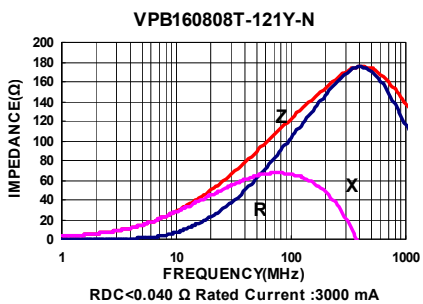
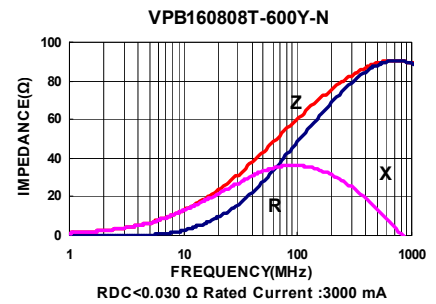
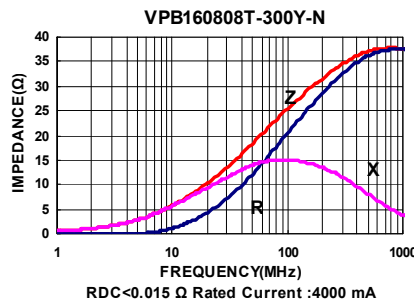
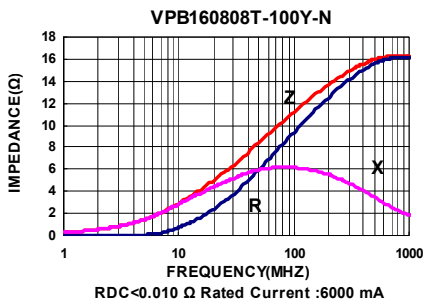

Please be sure to request approval specifications that provide further details of the products. Kindly note that the content of these specifications are subject to change or may be discontinued without advance notice. Please contact our sales department before ordering.

Test Instruments : Agilent E4991A Impedance / Material Analyzer

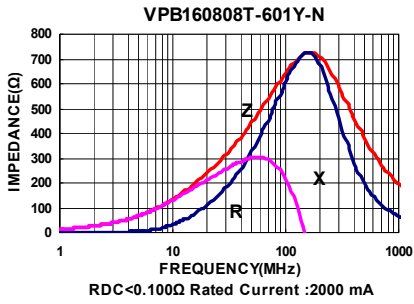

Packaging Specifications

Tape Dimensions

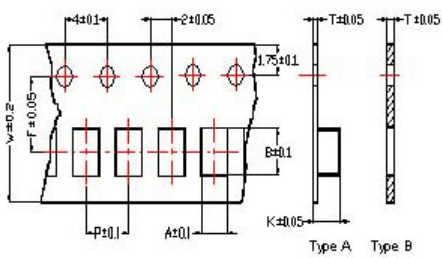

Tape Material

Carrier Tape: Polycarbonate (Tape A)
Carrier Tape: Paper (Tape B)
Cover Tape: Polystyrene

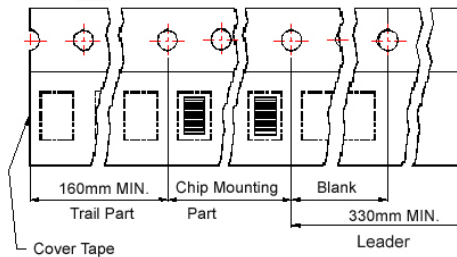

Reel Dimensions

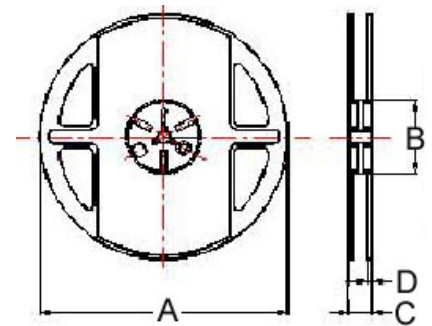

Dimensions in mm

TYPE	Tape Dimensions							Reel Dimensions				Quantity
	A	B	T	W	P	F	Tape Type	A	B	C	D	PCS / Reel
160808	1.05	1.85	0.95	8.0	4.0	3.5	B	178	60	12	2	4000

Please be sure to request approval specifications that provide further details of the products. Kindly note that the content of these specifications are subject to change or may be discontinued without advance notice. Please contact our sales department before ordering.

Multilayer Ferrite Chip Beads



Chilisin offers a wide range of multi-layered ferrite chip beads with various sizes, frequency characteristics, and impedance values for EMI solutions. These ferrite formulas are used to compose seven types of EMI suppression chip beads: SB, GB, PB, UPB, NB, HF, and VPB series.

Product Identification



- Product symbol: SB, GB, PB, UPB, NB, HF, VPB
- Packaging: T : Tape and Reel ; B : Bulk
- Tolerance: Y = ± 25%; M = ± 20%; T:±30%
- Note: RoHS Compliant

Shape and Dimensions

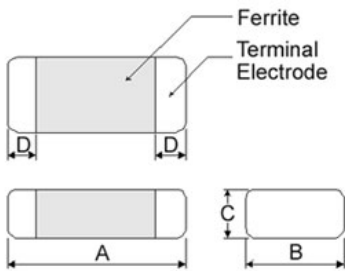

Recommended Pattern

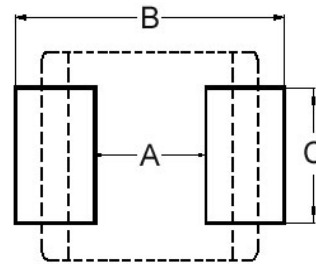

Dimensions in mm

TYPE	A	B	C	D
①060303	0.6±0.03	0.30±0.03	0.3±0.03	0.15±0.05
②100505	1.0±0.10	0.50±0.10	0.5±0.10	0.25±0.10
③160805	1.6±0.15	0.80±0.15	0.5±0.15	0.3±0.2
④160808	1.6±0.15	0.80±0.15	0.8±0.15	0.3±0.2
⑤201209	2.0±0.20	1.25±0.20	0.9±0.20	0.5±0.3
⑥321611	3.2±0.20	1.60±0.20	1.1±0.20	0.5±0.3

Dimensions in mm

TYPE	A	B	C
①060303	0.2 ~ 0.3	0.75 ~ 1.05	0.3
②100505	0.4	1.2 ~ 1.4	0.5
③160805	0.7 ~ 0.8	1.8 ~ 2.0	0.6 ~ 0.8
④160808	0.7 ~ 0.8	1.8 ~ 2.0	0.6 ~ 0.8
⑤201209	1.0 ~ 1.2	2.6 ~ 4.0	1.0 ~ 1.2
⑥321611	2.0	4.2 ~ 5.2	1.2

- ① : SBY / SBJ / NB / PB ② : SBY / SBJ / NB / PB / UPB / HF
 ③ : UPB ④ : SBK / SBJ / GB / PB / NB / UPB / VPB
 ⑤ : SBK / GB / PB / UPB ⑥ : SBY / SBK / PB / UPB

* Don't apply narrower pattern than listed above to PB and UPB. Narrow pattern might cause excessive heat or open circuit.

Dimension Conversion

Code	Dimension in mm (AxBxC)	EIA
060303	0.6X0.3X0.3	0201
100505	1.0X0.5X0.5	0402
160805	1.6x0.8x0.5	0603
160808	1.6x0.8x0.8	0603
201209	2.0x1.2x0.9	0805
321611	3.2x1.6x.1.1	1206

Electrical Characteristics

Part Number	Impedance ($\Omega \pm 25\%$)	Test Frequency (MHz)	RDC (Ω) Max	Rated current (mA) Max
UPB100505T-330Y-N	33	100	0.022	3000
UPB100505T-600Y-N	60	100	0.032	2500
UPB100505T-800Y-N	80	100	0.038	2300
UPB100505T-121Y-N	120	100	0.055	2000
UPB100505T-181Y-N	180	100	0.090	1500
UPB100505T-221Y-N	220	100	0.100	1400
UPB100505T-331Y-N	330	100	0.150	1200
UPB100505T-471Y-N	470	100	0.200	1000

Note: When ordering, please specify tolerance code. Tolerance : Y= $\pm 25\%$

- Operating temperature range - 55°C ~ 125°C(Including self - temperature rise)
- Rate Current : Applied the current to coils, the temperature rise shall not be more than 30°C
- Measure Equipment :
Z : HP4291A
RDC : HP4338B or CHEN HWA 502

Test Instruments : Agilent E4991A Impedance / Material Analyzer

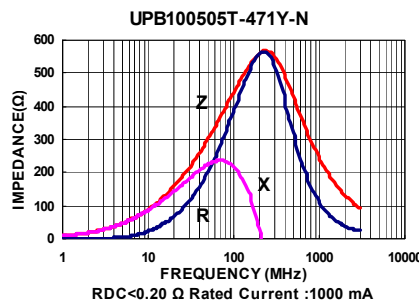
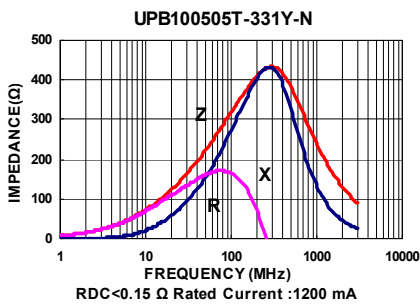
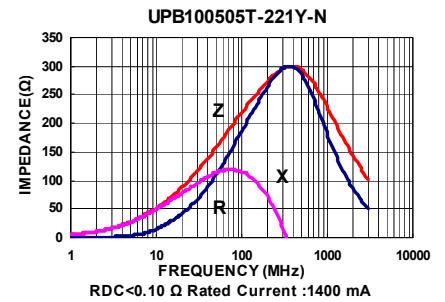
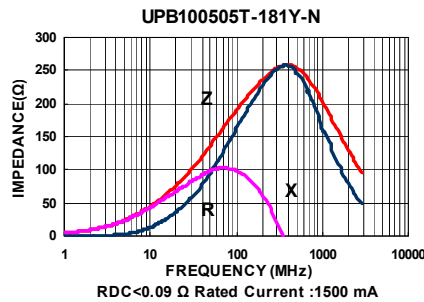
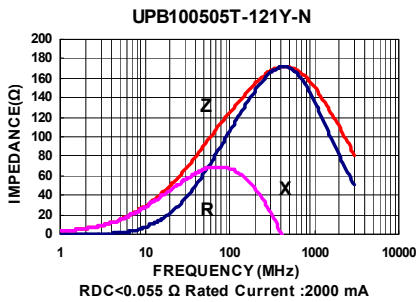
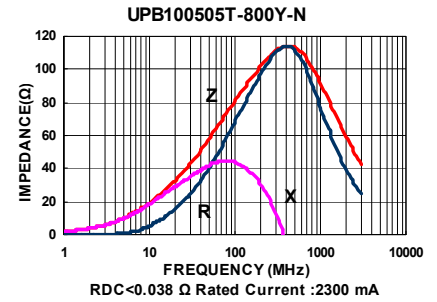
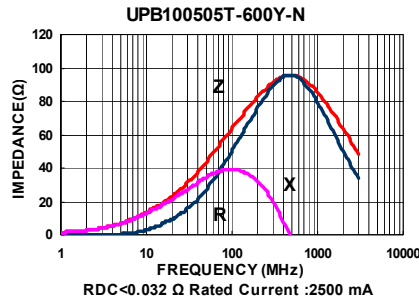
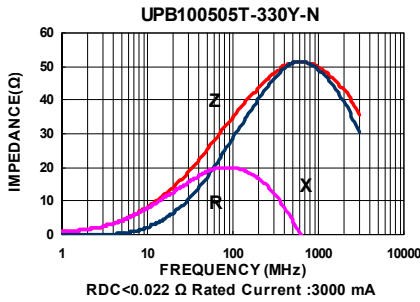

Please be sure to request approval specifications that provide further details of the products. Kindly note that the content of these specifications are subject to change or may be discontinued without advance notice. Please contact our sales department before ordering.

Electrical Characteristics

Part Number	Impedance ($\Omega \pm 25\%$)	Test Frequency (MHz)	RDC (Ω) Max	Rated current (mA) Max
UPB160805T-260Y-N	26	100	0.007	6000
UPB160805T-300Y-N	30	100	0.007	6000
UPB160805T-700Y-N	70	100	0.020	4000
UPB160805T-101Y-N	100	100	0.025	3000
UPB160805T-121Y-N	120	100	0.025	3000
UPB160805T-221Y-N	220	100	0.040	2500
UPB160805T-331Y-N	330	100	0.070	1500

Note: When ordering, please specify tolerance code. Tolerance : Y= $\pm 25\%$

- Operating temperature range - 55°C ~ 125°C(Including self - temperature rise)
- Rate Current : Applied the current to coils, the temperature rise shall not be more than 30°C
- Measure Equipment :
Z : HP4291A
RDC : HP4338B or CHEN HWA 502

Test Instruments : Agilent E4991A Impedance / Material Analyzer

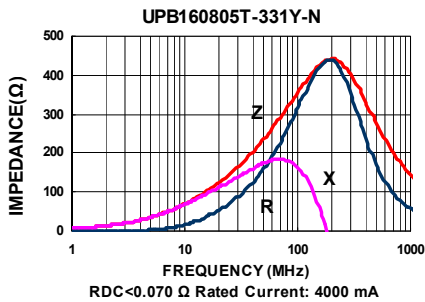
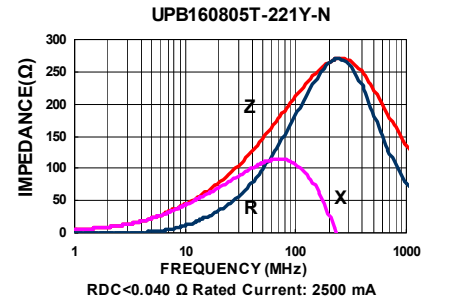
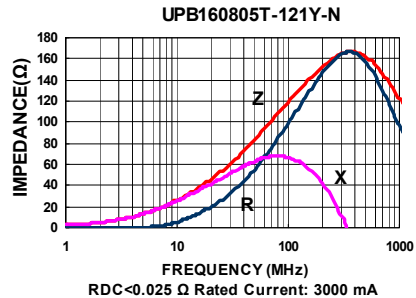
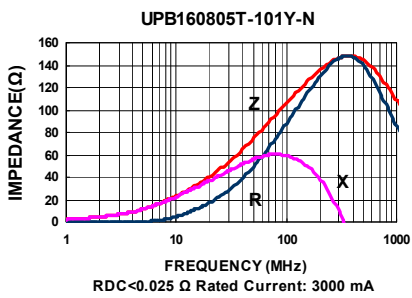
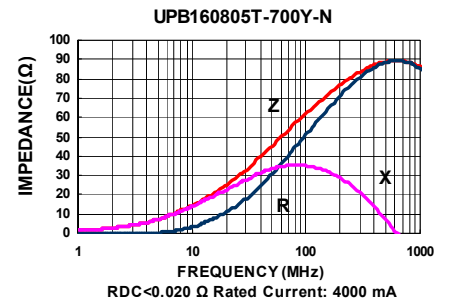
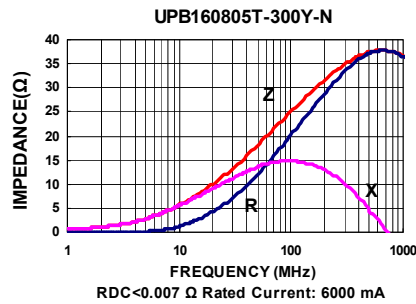
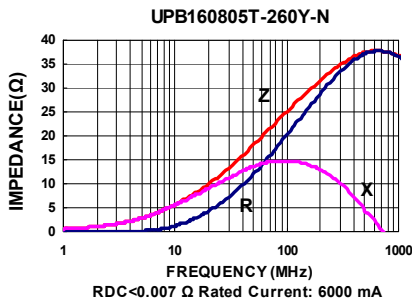

Please be sure to request approval specifications that provide further details of the products. Kindly note that the content of these specifications are subject to change or may be discontinued without advance notice. Please contact our sales department before ordering.

Electrical Characteristics

Part Number	Impedance ($\Omega \pm 25\%$)	Test Frequency (MHz)	RDC (Ω) Max	Rated current (mA) Max
UPB160808T-100Y-N	10	100	0.010	5000
UPB160808T-300Y-N	30	100	0.015	4500
UPB160808T-600Y-N	60	100	0.020	4000
UPB160808T-700Y-N	70	100	0.020	4000
UPB160808T-101Y-N	100	100	0.030	3000
UPB160808T-121Y-N	120	100	0.030	3000
UPB160808T-181Y-N	180	100	0.050	2000
UPB160808T-221Y-N	220	100	0.040	2500

Note: When ordering, please specify tolerance code. Tolerance : Y= $\pm 25\%$

- Operating temperature range - 55°C ~ 125°C(Including self - temperature rise)
- Rate Current : Applied the current to coils, the temperature rise shall not be more than 30°C
- Measure Equipment :
Z : HP4291A
RDC : HP4338B or CHEN HWA 502

Test Instruments : Agilent E4991A Impedance / Material Analyzer

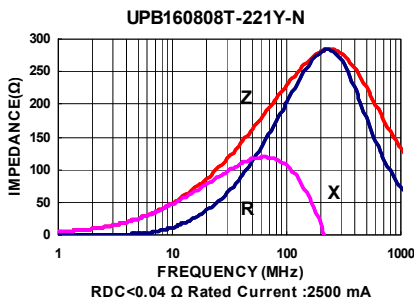
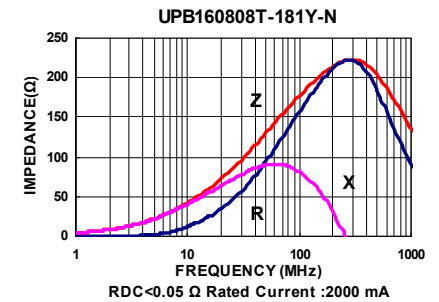
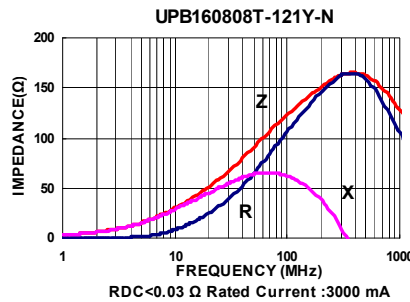
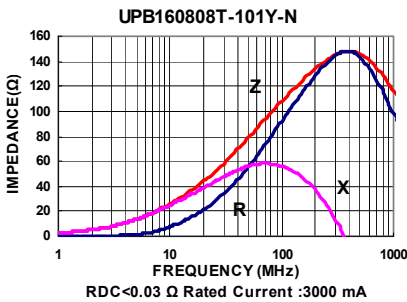
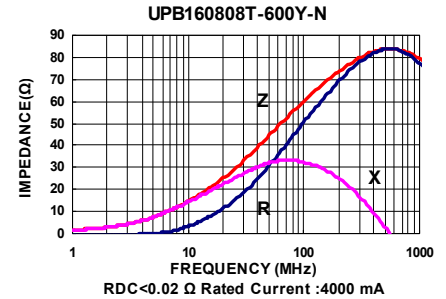
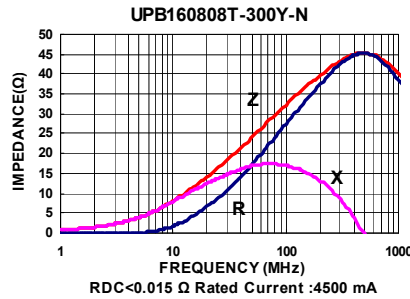
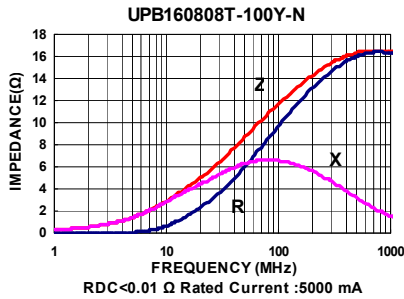

Please be sure to request approval specifications that provide further details of the products. Kindly note that the content of these specifications are subject to change or may be discontinued without advance notice. Please contact our sales department before ordering.

Electrical Characteristics

Part Number	Impedance ($\Omega \pm 25\%$)	Test Frequency (MHz)	RDC (Ω) Max	Rated current (mA) Max
UPB201209T-150Y-N	15	100	0.012	6000
UPB201209T-220Y-N	22	100	0.012	6000
UPB201209T-300Y-N	30	100	0.012	6000
UPB201209T-500Y-N	50	100	0.015	6000
UPB201209T-600Y-N	60	100	0.018	6000
UPB201209T-800Y-N	80	100	0.02	6000
UPB201209T-101Y-N	100	100	0.02	5000
UPB201209T-121Y-N	120	100	0.02	5000
UPB201209T-201Y-N	200	100	0.04	3000
UPB201209T-221Y-N	220	100	0.04	3000
UPB201209T-301Y-N	300	100	0.05	3000
UPB201209T-331Y-N	330	100	0.05	3000

Note: When ordering, please specify tolerance code. Tolerance : Y= $\pm 25\%$

- Operating temperature range - 55°C ~ 125°C(Including self - temperature rise)
- Rate Current : Applied the current to coils, the temperature rise shall not be more than 30°C
- Measure Equipment :
 Z : HP4291A
 RDC : HP4338B or CHEN HWA 502

Test Instruments : Agilent E4991A Impedance / Material Analyzer

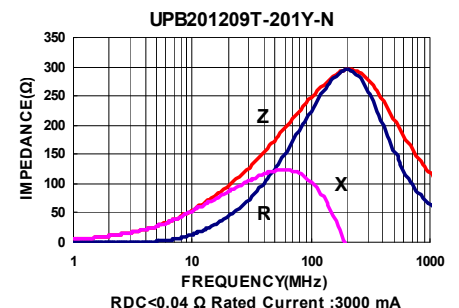
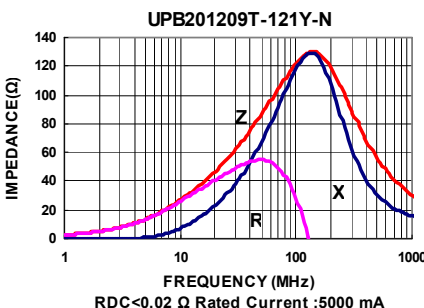
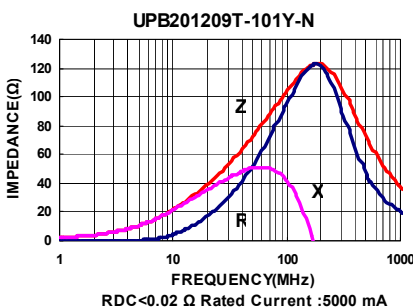
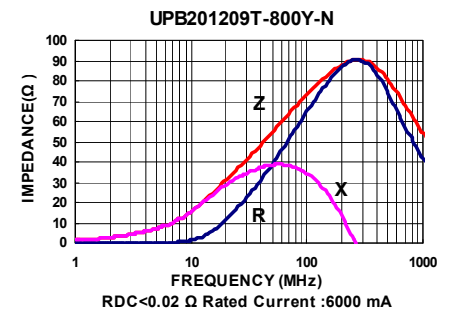
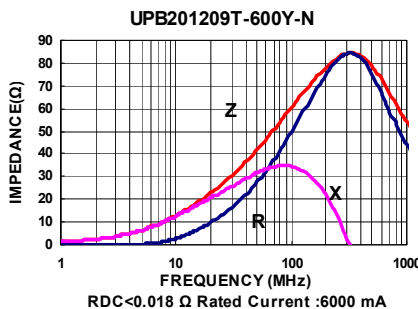
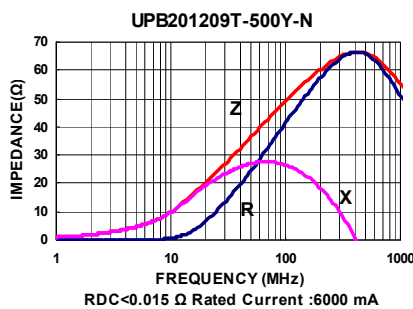
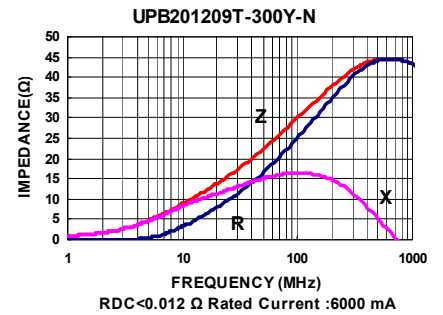
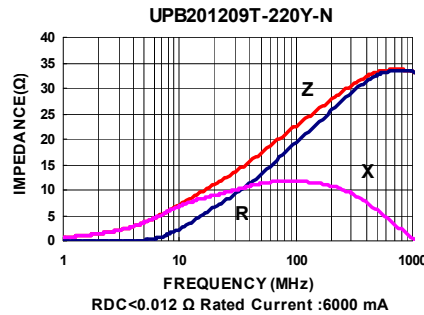
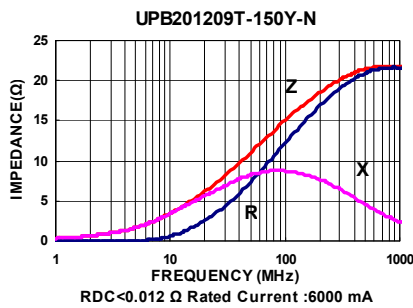

Please be sure to request approval specifications that provide further details of the products. Kindly note that the content of these specifications are subject to change or may be discontinued without advance notice. Please contact our sales department before ordering.

Test Instruments : Agilent E4991A Impedance / Material Analyzer

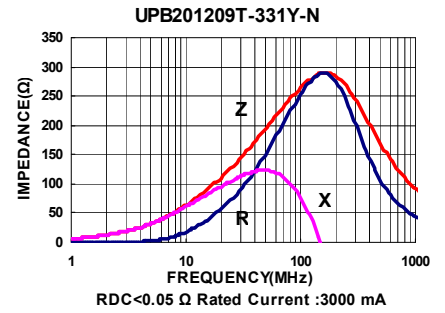
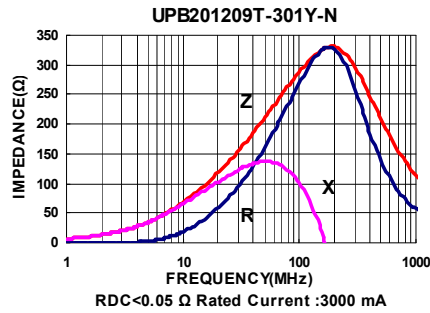
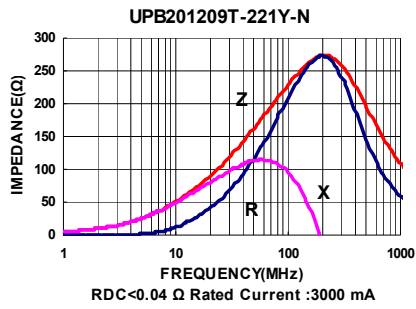

Please be sure to request approval specifications that provide further details of the products. Kindly note that the content of these specifications are subject to change or may be discontinued without advance notice. Please contact our sales department before ordering.

Electrical Characteristics

Part Number	Impedance ($\Omega \pm 25\%$)	Test Frequency (MHz)	RDC (Ω) Max	Rated current (mA) Max
UPB321611T-300Y-N	30	100	0.012	6000
UPB321611T-600Y-N	60	100	0.012	6000
UPB321611T-800Y-N	80	100	0.012	6000
UPB321611T-101Y-N	100	100	0.012	6000
UPB321611T-121Y-N	120	100	0.012	6000
UPB321611T-151Y-N	150	100	0.020	4500
UPB321611T-181Y-N	180	100	0.020	4500
UPB321611T-221Y-N	220	100	0.020	4500

Note: When ordering, please specify tolerance code. Tolerance : Y=±25%

- Operating temperature range - 55°C ~ 125°C(Including self - temperature rise)
- Rate Current : Applied the current to coils, the temperature rise shall not be more than 30°C
- Measure Equipment :
Z : HP4291A
RDC : HP4338B or CHEN HWA 502

Test Instruments : Agilent E4991A Impedance / Material Analyzer

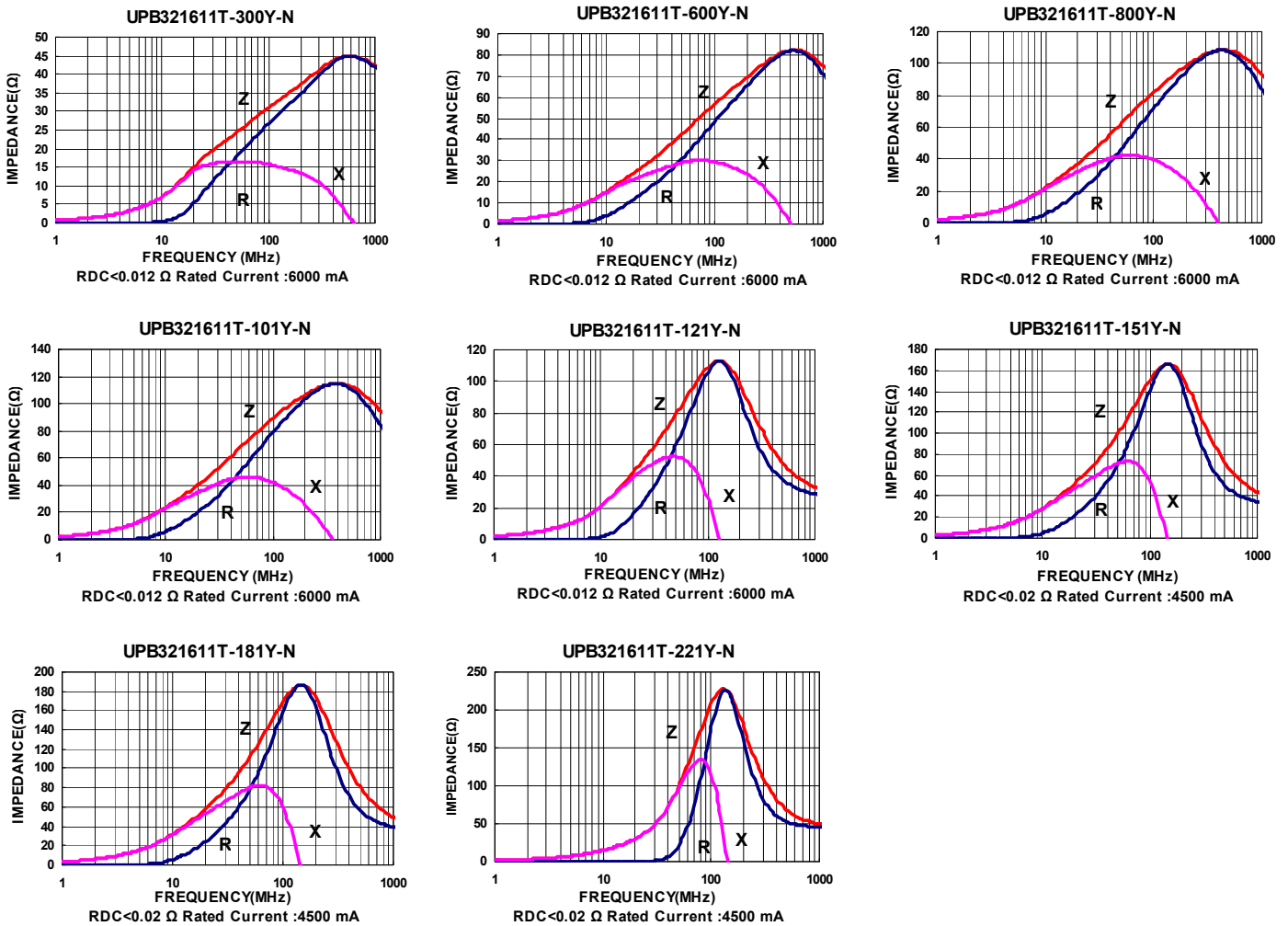

Please be sure to request approval specifications that provide further details of the products. Kindly note that the content of these specifications are subject to change or may be discontinued without advance notice. Please contact our sales department before ordering.

Packaging Specifications

Tape Dimensions

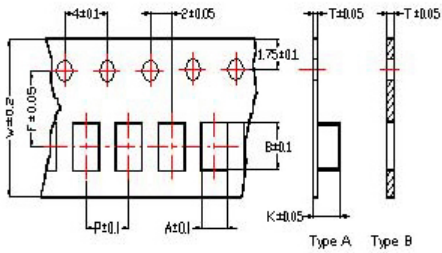

Tape Material

Carrier Tape: Polycarbonate (Tape A)
 Carrier Tape: Paper (Tape B)
 Cover Tape: Polystyrene

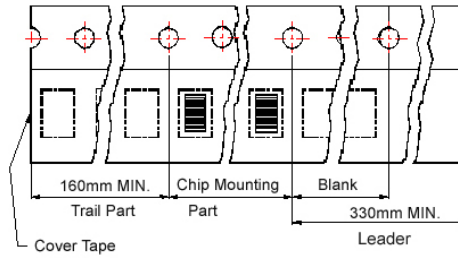

Reel Dimensions

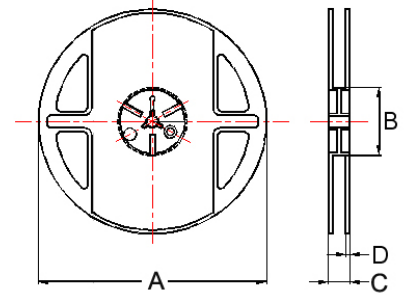

- ① : SBY / SBJ / NB / PB
- ② : SBY / SBJ / NB / PB / UPB / HF ③ : UPB
- ④ : SBK / SBJ / GB / PB / NB / UPB / VPB
- ⑤ : SBK / GB / PB / UPB ⑥ : SBY / SBK / PBY / UPB

Dimensions in mm

TYPE	Tape Dimensions								Reel Dimensions				Quantity PCS / REEL
	A	B	T	W	P	F	K	Tape	A	B	C	D	
①060303	0.37	0.67	0.42	8.0	2.0	3.5	-	B	178	60	10	2	15000
②100505	0.62	1.12	0.60	8.0	2.0	3.5	-	B	178	60	12	2	10000
③160805	1.05	1.85	0.60	8.0	2.0	3.5	-	B	178	60	12	2	10000
④160808	1.05	1.85	0.95	8.0	4.0	3.5	-	B	178	60	12	2	4000
⑤201209	1.50	2.30	0.97	8.0	4.0	3.5	-	B	178	60	12	2	4000
⑥321611	1.88	3.50	0.22	8.0	4.0	3.5	1.27	A	178	60	12	2	3000

Multilayer Ferrite Chip Beads



Chilisin offers a wide range of multi-layered ferrite chip beads with various sizes, frequency characteristics, and impedance values for EMI solutions. These ferrite formulas are used to compose seven types of EMI suppression chip beads: SB, GB, PB, UPB, NB, HF, and VPB series.

Product Identification

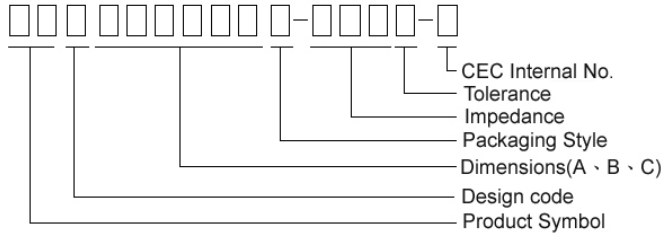

- Product symbol: SB, GB, PB, UPB, NB, HF, VPB
- Packaging: T : Tape and Reel ; B : Bulk
- Tolerance: Y = ± 25%; M = ± 20%; T:±30%
- Note: RoHS Compliant

Shape and Dimensions

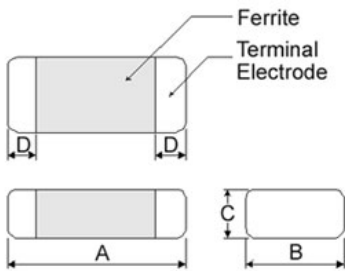

Recommended Pattern

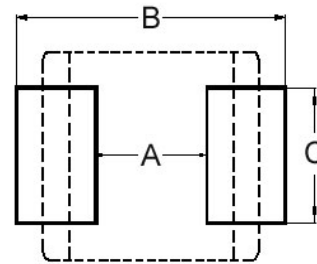

Dimensions in mm

TYPE	A	B	C	D
①060303	0.6±0.03	0.30±0.03	0.3±0.03	0.15±0.05
②100505	1.0±0.10	0.50±0.10	0.5±0.10	0.25±0.10
③160805	1.6±0.15	0.80±0.15	0.5±0.15	0.3±0.2
④160808	1.6±0.15	0.80±0.15	0.8±0.15	0.3±0.2
⑤201209	2.0±0.20	1.25±0.20	0.9±0.20	0.5±0.3
⑥321611	3.2±0.20	1.60±0.20	1.1±0.20	0.5±0.3

Dimensions in mm

TYPE	A	B	C
①060303	0.2 ~ 0.3	0.75 ~ 1.05	0.3
②100505	0.4	1.2 ~ 1.4	0.5
③160805	0.7 ~ 0.8	1.8 ~ 2.0	0.6 ~ 0.8
④160808	0.7 ~ 0.8	1.8 ~ 2.0	0.6 ~ 0.8
⑤201209	1.0 ~ 1.2	2.6 ~ 4.0	1.0 ~ 1.2
⑥321611	2.0	4.2 ~ 5.2	1.2

- ① : SBY / SBJ / NB / PB ② : SBY / SBJ / NB / PB / UPB / HF
 ③ : UPB ④ : SBK / SBJ / GB / PB / NB / UPB / VPB
 ⑤ : SBK / GB / PB / UPB ⑥ : SBY / SBK / PB / UPB

* Don't apply narrower pattern than listed above to PB and UPB. Narrow pattern might cause excessive heat or open circuit.

Dimension Conversion

Code	Dimension in mm (AxBxC)	EIA
060303	0.6X0.3X0.3	0201
100505	1.0X0.5X0.5	0402
160805	1.6x0.8x0.5	0603
160808	1.6x0.8x0.8	0603
201209	2.0x1.2x0.9	0805
321611	3.2x1.6x.1.1	1206

Electrical Characteristics

Part Number	Impedance ($\Omega \pm 25\%$)	Test Frequency (MHz)	Impedance ($\Omega \pm 40\%$)	Test Frequency (MHz)	RDC (Ω) Max	Rated current (mA) Max
HFY100505T-221Y-N	220	100	270	1000	0.55	450
HFY100505T-301Y-N	300	100	450	1000	0.55	350
HFY100505T-471Y-N	470	100	650	1000	0.60	300
HFY100505T-601Y-N	600	100	1000	1000	0.7	300
HFY100505T-102Y-N	1000	100	1400	1000	1.1	250

Note: When ordering, please specify tolerance code. Tolerance : Y= $\pm 25\%$

- Operating temperature range - 55°C ~ 125°C(Including self - temperature rise)
- Rate Current : Applied the current to coils, the temperature rise shall not be more than 30°C
- Measure Equipment :
Z : HP4291A
RDC : HP4338B or CHEN HWA 502

Test Instruments : Agilent E4991A Impedance / Material Analyzer

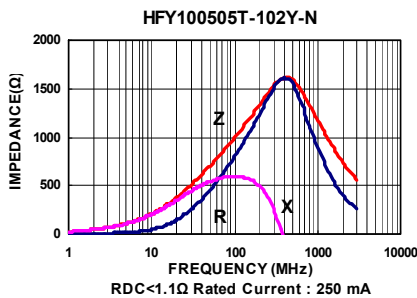
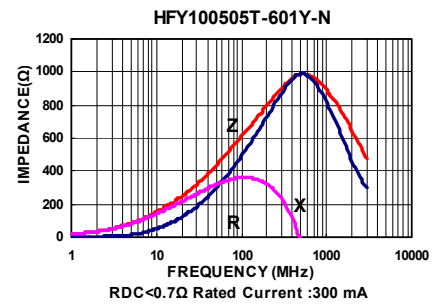
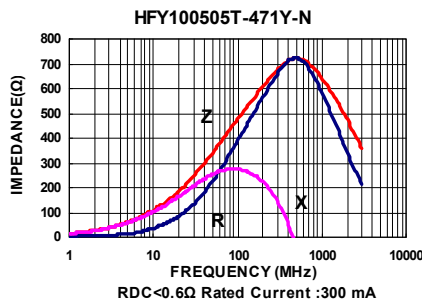
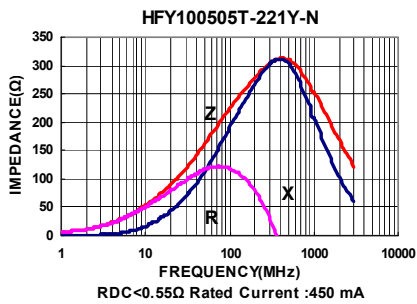

Please be sure to request approval specifications that provide further details of the products. Kindly note that the content of these specifications are subject to change or may be discontinued without advance notice. Please contact our sales department before ordering.

Packaging Specifications

Tape Dimensions

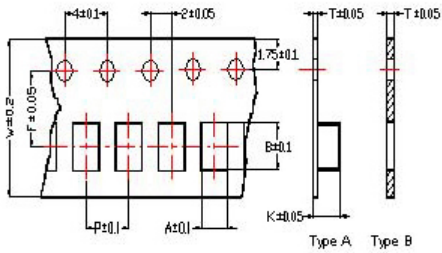

Tape Material

Carrier Tape: Polycarbonate (Tape A)
Carrier Tape: Paper (Tape B)
Cover Tape: Polystyrene

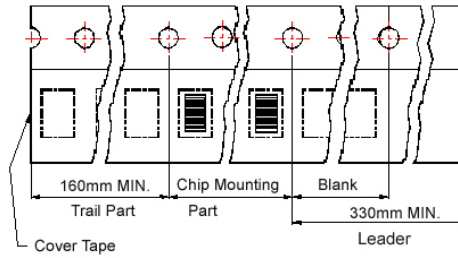

Reel Dimensions

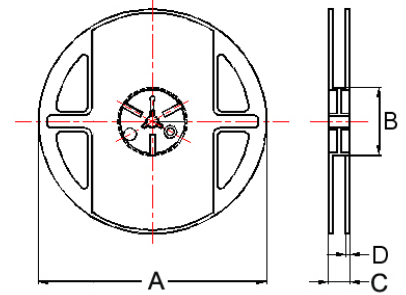

- ① : SBY / SBJ / NB / PB
- ② : SBY / SBJ / NB / PB / UPB / HF ③ : UPB
- ④ : SBK / SBJ / GB / PB / NB / UPB / VPB
- ⑤ : SBK / GB / PB / UPB ⑥ : SBY / SBK / PBY / UPB

Dimensions in mm

TYPE	Tape Dimensions								Reel Dimensions				Quantity PCS / REEL
	A	B	T	W	P	F	K	Tape	A	B	C	D	
①060303	0.37	0.67	0.42	8.0	2.0	3.5	-	B	178	60	10	2	15000
②100505	0.62	1.12	0.60	8.0	2.0	3.5	-	B	178	60	12	2	10000
③160805	1.05	1.85	0.60	8.0	2.0	3.5	-	B	178	60	12	2	10000
④160808	1.05	1.85	0.95	8.0	4.0	3.5	-	B	178	60	12	2	4000
⑤201209	1.50	2.30	0.97	8.0	4.0	3.5	-	B	178	60	12	2	4000
⑥321611	1.88	3.50	0.22	8.0	4.0	3.5	1.27	A	178	60	12	2	3000

Multilayer Ferrite Chip Beads



Chilisin offers a wide range of multi-layered ferrite chip beads with various sizes, frequency characteristics, and impedance values for EMI solutions. These ferrite formulas are used to compose seven types of EMI suppression chip beads: SB, GB, PB, UPB, NB, HF, and VPB series.

Product Identification

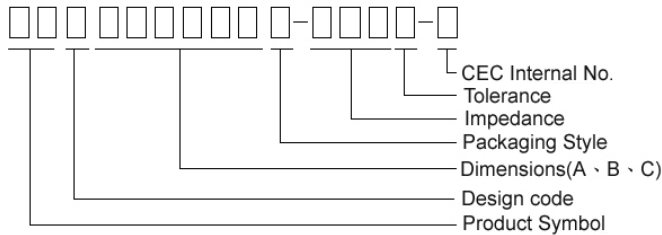

- Product symbol: SB, GB, PB, UPB, NB, HF, VPB
- Packaging: T : Tape and Reel ; B : Bulk
- Tolerance: Y = ± 25%; M = ± 20%; T:±30%
- Note: RoHS Compliant

Shape and Dimensions



Recommended Pattern

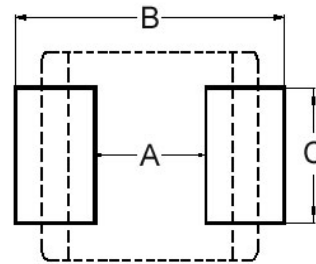

Dimensions in mm

TYPE	A	B	C	D
①060303	0.6±0.03	0.30±0.03	0.3±0.03	0.15±0.05
②100505	1.0±0.10	0.50±0.10	0.5±0.10	0.25±0.10
③160805	1.6±0.15	0.80±0.15	0.5±0.15	0.3±0.2
④160808	1.6±0.15	0.80±0.15	0.8±0.15	0.3±0.2
⑤201209	2.0±0.20	1.25±0.20	0.9±0.20	0.5±0.3
⑥321611	3.2±0.20	1.60±0.20	1.1±0.20	0.5±0.3

Dimensions in mm

TYPE	A	B	C
①060303	0.2 ~ 0.3	0.75 ~ 1.05	0.3
②100505	0.4	1.2 ~ 1.4	0.5
③160805	0.7 ~ 0.8	1.8 ~ 2.0	0.6 ~ 0.8
④160808	0.7 ~ 0.8	1.8 ~ 2.0	0.6 ~ 0.8
⑤201209	1.0 ~ 1.2	2.6 ~ 4.0	1.0 ~ 1.2
⑥321611	2.0	4.2 ~ 5.2	1.2

- ① : SBY / SBJ / NB / PB ② : SBY / SBJ / NB / PB / UPB / HF
 ③ : UPB ④ : SBK / SBJ / GB / PB / NB / UPB / VPB
 ⑤ : SBK / GB / PB / UPB ⑥ : SBY / SBK / PB / UPB

* Don't apply narrower pattern than listed above to PB and UPB. Narrow pattern might cause excessive heat or open circuit.

Dimension Conversion

Code	Dimension in mm (AxBxC)	EIA
060303	0.6X0.3X0.3	0201
100505	1.0X0.5X0.5	0402
160805	1.6x0.8x0.5	0603
160808	1.6x0.8x0.8	0603
201209	2.0x1.2x0.9	0805
321611	3.2x1.6x.1.1	1206

Electrical Characteristics

Part Number	Impedance ($\Omega \pm 25\%$)	Test Frequency (MHz)	Impedance ($\Omega \pm 40\%$)	Test Frequency (MHz)	RDC (Ω) Max	Rated current (mA) Max
HFJ100505T-601Y-N	600	100	1400	1000	0.85	300
HFJ100505T-102Y-N	1000	100	2000	1000	1.25	250
HFJ100505T-152Y-N	1500	100	2400	1000	1.80	230
HFJ100505T-182Y-N	1800	100	2700	1000	2.20	200

Note: When ordering, please specify tolerance code. Tolerance : Y= $\pm 25\%$

- Operating temperature range - 55°C ~ 125°C(Including self - temperature rise)
- Rate Current : Applied the current to coils, the temperature rise shall not be more than 30°C
- Measure Equipment :
 Z : HP4291A
 RDC : HP4338B or CHEN HWA 502

Test Instruments : Agilent E4991A Impedance / Material Analyzer

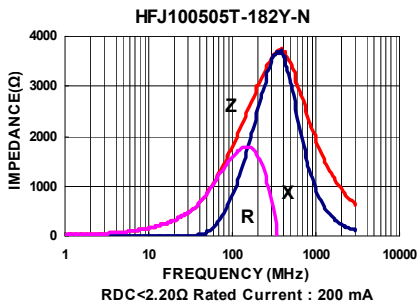
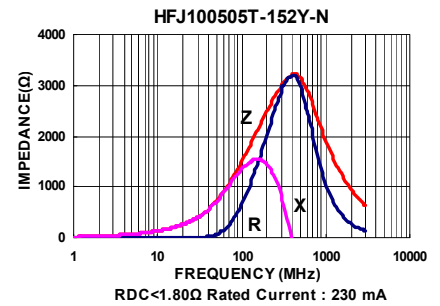
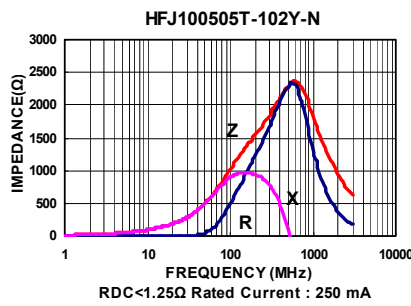
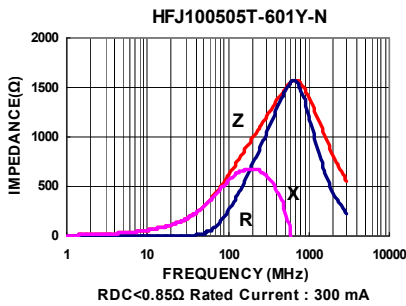

Please be sure to request approval specifications that provide further details of the products. Kindly note that the content of these specifications are subject to change or may be discontinued without advance notice. Please contact our sales department before ordering.

Packaging Specifications

Tape Dimensions

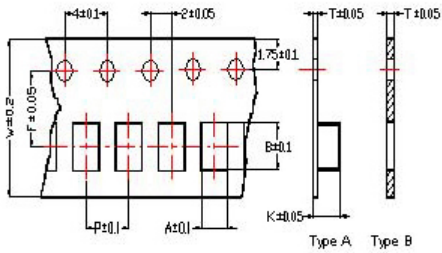

Tape Material

Carrier Tape: Polycarbonate (Tape A)
 Carrier Tape: Paper (Tape B)
 Cover Tape: Polystyrene

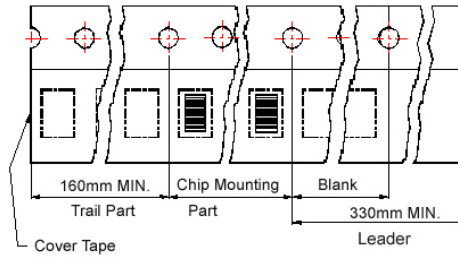

Reel Dimensions

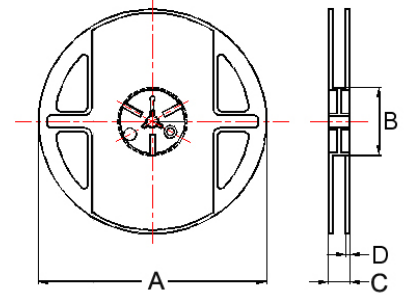

- ① : SBY / SBJ / NB / PB
- ② : SBY / SBJ / NB / PB / UPB / HF ③ : UPB
- ④ : SBK / SBJ / GB / PB / NB / UPB / VPB
- ⑤ : SBK / GB / PB / UPB ⑥ : SBY / SBK / PBY / UPB

Dimensions in mm

TYPE	Tape Dimensions								Reel Dimensions				Quantity PCS / REEL
	A	B	T	W	P	F	K	Tape	A	B	C	D	
①060303	0.37	0.67	0.42	8.0	2.0	3.5	-	B	178	60	10	2	15000
②100505	0.62	1.12	0.60	8.0	2.0	3.5	-	B	178	60	12	2	10000
③160805	1.05	1.85	0.60	8.0	2.0	3.5	-	B	178	60	12	2	10000
④160808	1.05	1.85	0.95	8.0	4.0	3.5	-	B	178	60	12	2	4000
⑤201209	1.50	2.30	0.97	8.0	4.0	3.5	-	B	178	60	12	2	4000
⑥321611	1.88	3.50	0.22	8.0	4.0	3.5	1.27	A	178	60	12	2	3000

Multilayer Ferrite Chip Beads



Chilisin offers a wide range of multi-layered ferrite chip beads with various sizes, frequency characteristics, and impedance values for EMI solutions. These ferrite formulas are used to compose seven types of EMI suppression chip beads: SB, GB, PB, UPB, NB, HF, and VPB series.

Product Identification



- Product symbol: SB, GB, PB, UPB, NB, HF, VPB
- Packaging: T : Tape and Reel ; B : Bulk
- Tolerance: Y = ± 25%; M = ± 20%; T:±30%
- Note: RoHS Compliant

Shape and Dimensions



Recommended Pattern

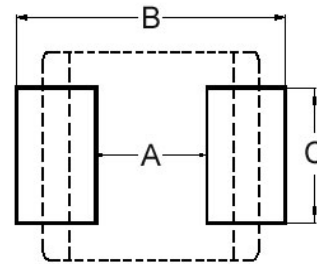

Dimensions in mm

TYPE	A	B	C	D
①060303	0.6±0.03	0.30±0.03	0.3±0.03	0.15±0.05
②100505	1.0±0.10	0.50±0.10	0.5±0.10	0.25±0.10
③160805	1.6±0.15	0.80±0.15	0.5±0.15	0.3±0.2
④160808	1.6±0.15	0.80±0.15	0.8±0.15	0.3±0.2
⑤201209	2.0±0.20	1.25±0.20	0.9±0.20	0.5±0.3
⑥321611	3.2±0.20	1.60±0.20	1.1±0.20	0.5±0.3

Dimensions in mm

TYPE	A	B	C
①060303	0.2 ~ 0.3	0.75 ~ 1.05	0.3
②100505	0.4	1.2 ~ 1.4	0.5
③160805	0.7 ~ 0.8	1.8 ~ 2.0	0.6 ~ 0.8
④160808	0.7 ~ 0.8	1.8 ~ 2.0	0.6 ~ 0.8
⑤201209	1.0 ~ 1.2	2.6 ~ 4.0	1.0 ~ 1.2
⑥321611	2.0	4.2 ~ 5.2	1.2

- ① : SBY / SBJ / NB / PB ② : SBY / SBJ / NB / PB / UPB / HF
 ③ : UPB ④ : SBK / SBJ / GB / PB / NB / UPB / VPB
 ⑤ : SBK / GB / PB / UPB ⑥ : SBY / SBK / PB / UPB

* Don't apply narrower pattern than listed above to PB and UPB. Narrow pattern might cause excessive heat or open circuit.

Dimension Conversion

Code	Dimension in mm (AxBxC)	EIA
060303	0.6X0.3X0.3	0201
100505	1.0X0.5X0.5	0402
160805	1.6x0.8x0.5	0603
160808	1.6x0.8x0.8	0603
201209	2.0x1.2x0.9	0805
321611	3.2x1.6x.1.1	1206

Electrical Characteristics

Part Number	Impedance ($\Omega \pm 25\%$)	Test Frequency (MHz)	Impedance ($\Omega \pm 40\%$)	Test Frequency (MHz)	RDC (Ω) Max	Rated current (mA) Max
HFY100505T-121Y-NP	120	100	150	1000	0.095	1500
HFY100505T-221Y-NP	220	100	270	1000	0.280	700

Note: When ordering, please specify tolerance code. Tolerance : Y= $\pm 25\%$

- Operating temperature range - 55°C ~ 125°C(Including self - temperature rise)
- Rate Current : Applied the current to coils, the temperature rise shall not be more than 30°C
- Measure Equipment :
 Z : HP4291A
 RDC : HP4338B or CHEN HWA 502

Test Instruments : Agilent E4991A Impedance / Material Analyzer

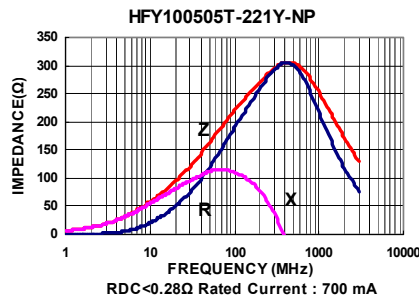
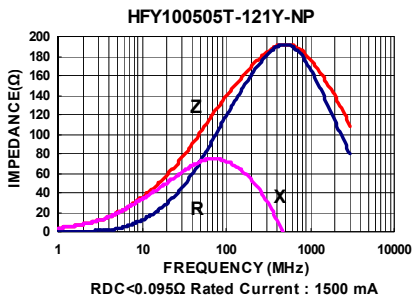

Packaging Specifications

Tape Dimensions

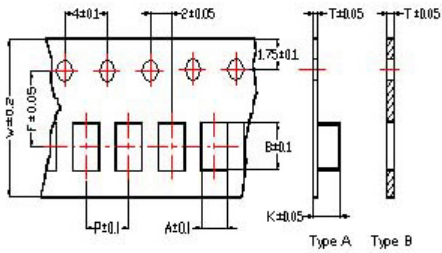

Tape Material

Carrier Tape: Polycarbonate (Tape A)
 Carrier Tape: Paper (Tape B)
 Cover Tape: Polystyrene

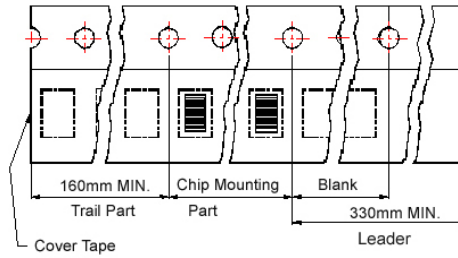

Reel Dimensions

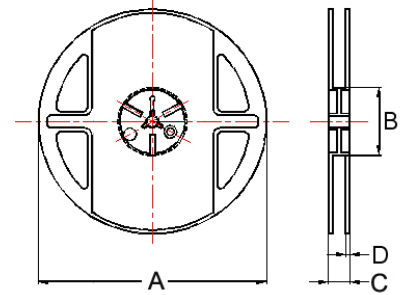

- ① : SBY / SBJ / NB / PB
- ② : SBY / SBJ / NB / PB / UPB / HF ③ : UPB
- ④ : SBK / SBJ / GB / PB / NB / UPB / VPB
- ⑤ : SBK / GB / PB / UPB ⑥ : SBY / SBK / PBY / UPB

Dimensions in mm

TYPE	Tape Dimensions								Reel Dimensions				Quantity PCS / REEL
	A	B	T	W	P	F	K	Tape	A	B	C	D	
①060303	0.37	0.67	0.42	8.0	2.0	3.5	-	B	178	60	10	2	15000
②100505	0.62	1.12	0.60	8.0	2.0	3.5	-	B	178	60	12	2	10000
③160805	1.05	1.85	0.60	8.0	2.0	3.5	-	B	178	60	12	2	10000
④160808	1.05	1.85	0.95	8.0	4.0	3.5	-	B	178	60	12	2	4000
⑤201209	1.50	2.30	0.97	8.0	4.0	3.5	-	B	178	60	12	2	4000
⑥321611	1.88	3.50	0.22	8.0	4.0	3.5	1.27	A	178	60	12	2	3000

MCF Series



The MCF series is a type of common mode filter designed and produced using the multilayer technology. The multilayer construction allows for excellent noise suppression for signal lines used in high-speed and high-density digital equipment such as personal computers, facsimiles, DSC, STB, etc. Both standard series and custom-design products are available.

Features

- Multilayer construction for effective suppression of common mode noise at high frequency
- Excellent solderability
- Compact design

Applications

- High speed interfaces (IEEE1394, USB2.0, and LVDS) in electronic devices
- PDP, LCD TV, DVD player, PC, Audio player, DSC
- Digital audio and video equipment such as PDAs, DVC, CD player, MD player, etc.

Product Identification

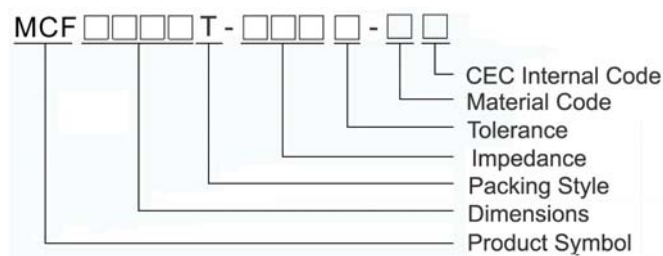

Shape and Dimensions

MCF11

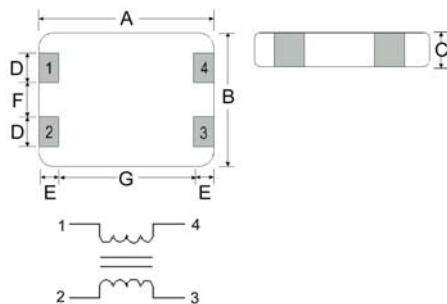

MCF21

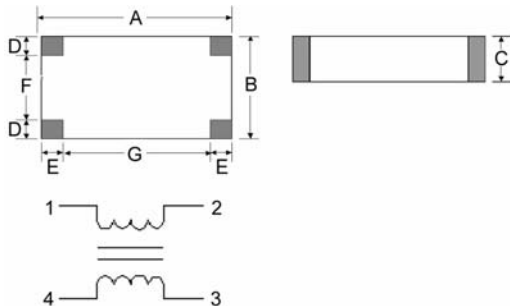

Dimensions in mm

TYPE	A	B	C	D	E	F	G
MCF11	1.25±0.15	1.00±0.15	0.60±0.15	0.30±0.15	0.20±0.15	0.25±0.15	0.85±0.15
MCF21	2.00±0.20	1.25±0.20	1.00±0.20	0.35±0.10	0.40±0.10	0.55±0.20	1.20±0.20

Recommended Pattern

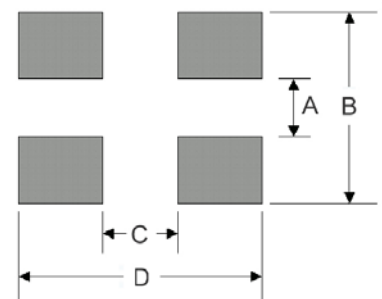

Dimensions in mm

TYPE	A	B	C	D
MCF11	0.2~0.3	0.7~1.0	0.7~0.8	1.6~1.9
MCF21	0.50	1.30	0.80	2.60

Electrical Characteristics

Part Number	Impedance (Ω)	Test Frequency (MHz)	Tolerance (±%)	RDC (Ω)Max	Rated Current (mA)Max	Rated Voltage (Vdc)Max	Insulation Resistance (MΩ) Min
MCF11T-670M-N2	67	100	20	1.35	200	10	200
MCF11T-900M-N2	90	100	20	1.45	200	10	200

Note: When ordering, please specify tolerance code. Tolerance: M=±20%

- Operating temperature range - 40°C ~ 105°C(Including self - temperature rise)
- Rated current : ΔT=30°C
- Measure Equipment :
 Z : Agilent E4991
 RDC : HP4338B or CHEN HWA 502(Single Wire Test Value)
 Insulation Resistance : Agilent HP4339B

Test Instruments : Agilent E4991A Material/Impedance Analyzer

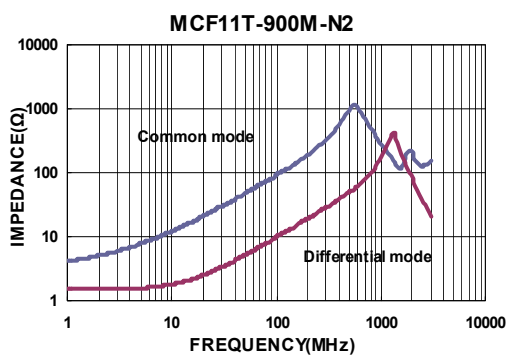
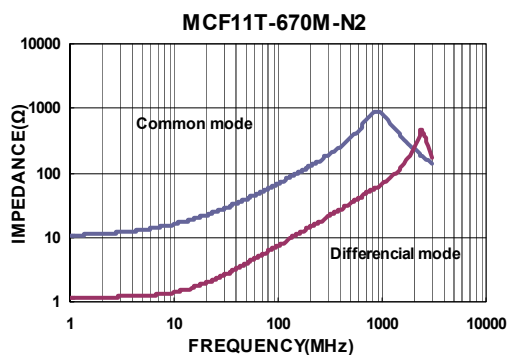

Please be sure to request approval specifications that provide further details of the products. Kindly note that the content of these specifications are subject to change or may be discontinued without advance notice. Please contact our sales department before ordering.

Electrical Characteristics

Part Number	Impedance (Ω)	Tolerance (±%)	Test Frequency (MHz)	RDC (Ω)Max	Rated Current (mA)Max	Rated Voltage (Vdc)Max	Insulation Resistance (MΩ) Min
MCF21T-670M-N2	67	20	100	0.80	400	30	200
MCF21T-900M-N2	90	20	100	0.85	400	30	200
MCF21T-121M-N2	120	20	100	0.90	300	30	200

Note: When ordering, please specify tolerance code. Tolerance: M=±20%

- Operating temperature range - 40°C ~ 105°C(Including self - temperature rise)
- Rated current : ΔT=30°C
- Measure Equipment :
 Z : Agilent E4991
 RDC : HP4338B or CHEN HWA 502(Single Wire Test Value)
 Insulation Resistance : Agilent HP4339B

Test Instruments : Agilent E4991A Material/Impedance Analyzer

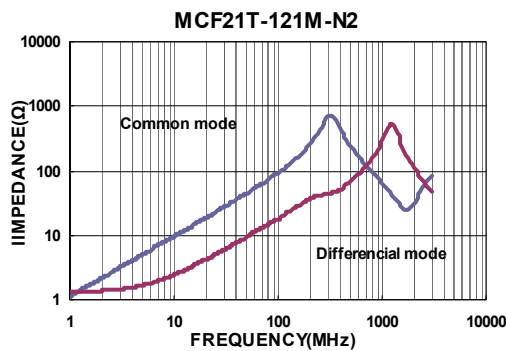
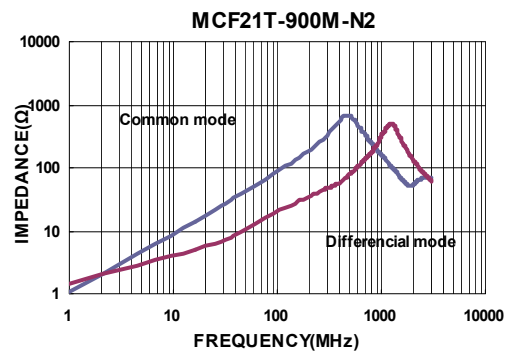
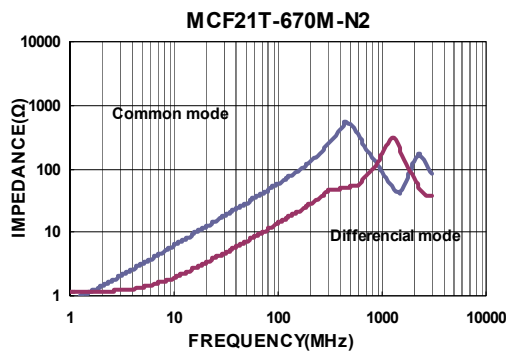

Please be sure to request approval specifications that provide further details of the products. Kindly note that the content of these specifications are subject to change or may be discontinued without advance notice. Please contact our sales department before ordering.

Packaging Specifications

Tape Dimensions

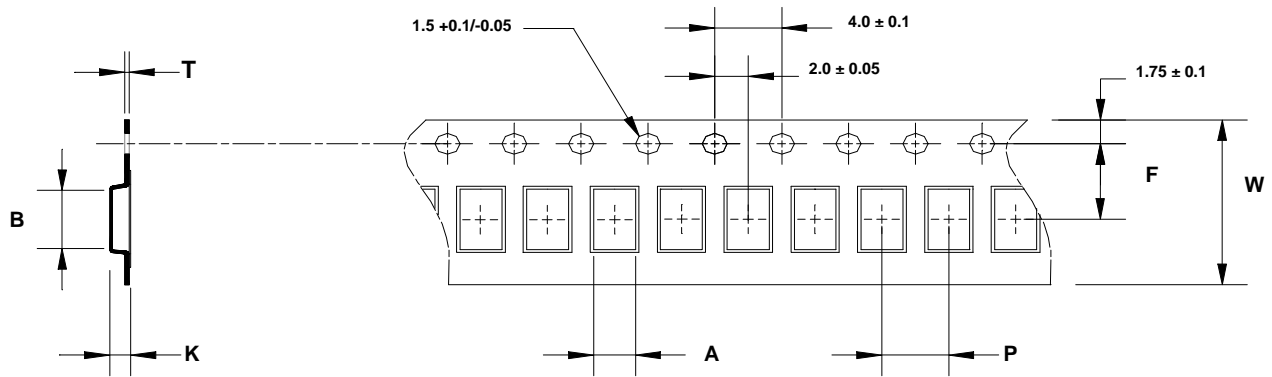

Trailer End

Leader End

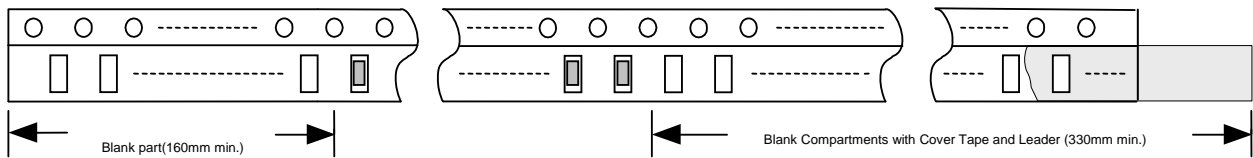

Reel Dimensions

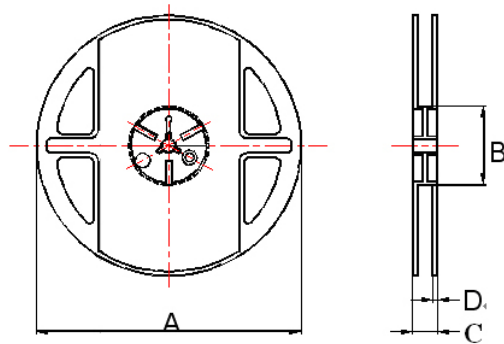

Dimensions in mm

TYPE	Tape Dimensions							Reel Dimensions				Quantity
	A	B	T	W	P	F	K	A	B	C	D	PCS / Reel
MCF11	1.15	1.50	0.25	8	4	3.5	0.72	178	60	12	1.5	4000
MCF21	1.45	2.30	0.22	8	4	3.5	1.13	178	60	12	1.5	3000

MCUF Series



MCUF Series are design to suppress the common mode noise and reduce the skew of differential mode signal in high frequency application. Both standard series and custom designs are available.

Features

- RoHS Compliant
- High frequency differential mode transmission application
- Miniaturization
- Excellent solderability

Applications

- USB3.0
- HDMI 2.0

Product Identification

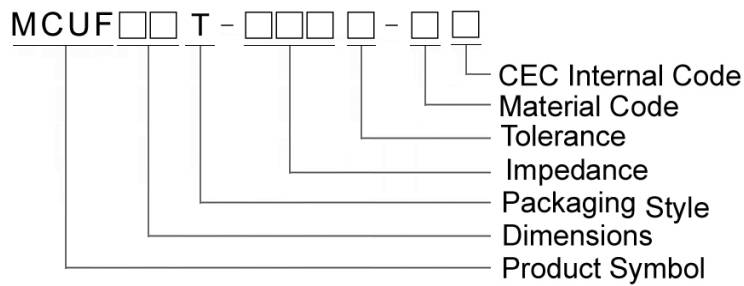

Shape and Dimensions

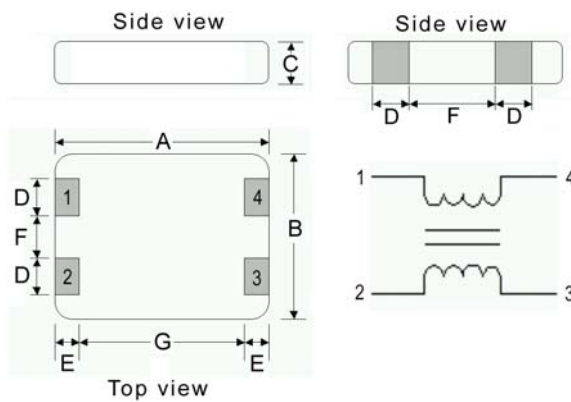

Dimensions in mm

TYPE	A	B	C	D	E	F	G
MCUF11	1.25±0.15	1.00±0.15	0.60±0.15	0.30±0.15	0.20±0.15	0.25±0.15	0.85±0.15

Recommended Pattern

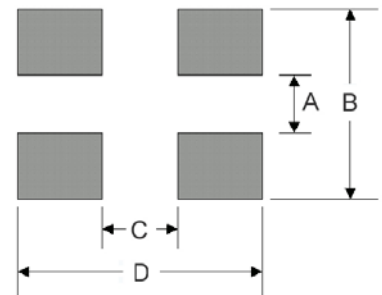

Dimensions in mm

TYPE	A	B	C	D
MCUF11	0.2~0.3	0.7~1.0	0.7~0.8	1.6~1.9

Electrical Characteristics

Part Number	Impedance (Ω)	Test Frequency (MHz)	Tolerance ($\pm\%$)	RDC (Ω)Max	Rated Current (mA)Max	Rated Voltage (Vdc)Max	Insulation Resistance (M Ω) Min
MCUF11T-670M-N1	67	100	20	3.6	100	5	200
MCUF11T-900M-N1	90	100	20	4.0	100	5	200
MCUF11T-121M-N1	120	100	20	4.4	100	5	200

Note: When ordering, please specify tolerance code. Tolerance: M=±20%

- Operating temperature range - 40°C ~ 105°C(Including self - temperature rise)
- Rated current : $\Delta T=30^\circ\text{C}$
- Measure Equipment :
 Z : Agilent E4991
 RDC : HP4338B or CHEN HWA 502(Single Wire Test Value)
 Insulation Resistance : Agilent HP4339B

Test Instruments : Agilent E4991A Material/Impedance Analyzer

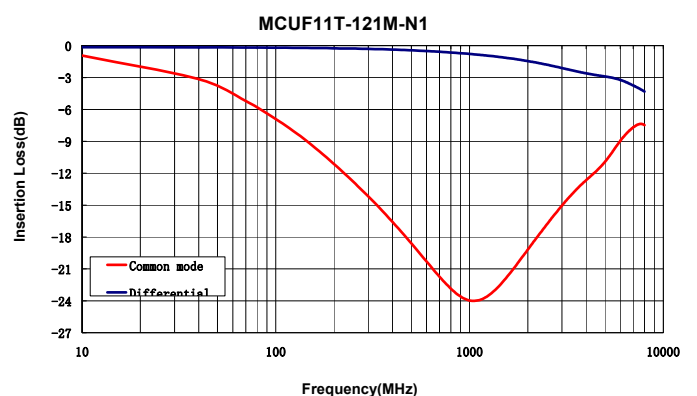
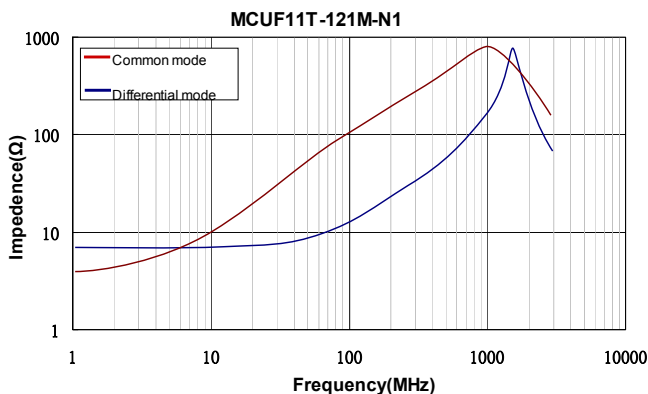
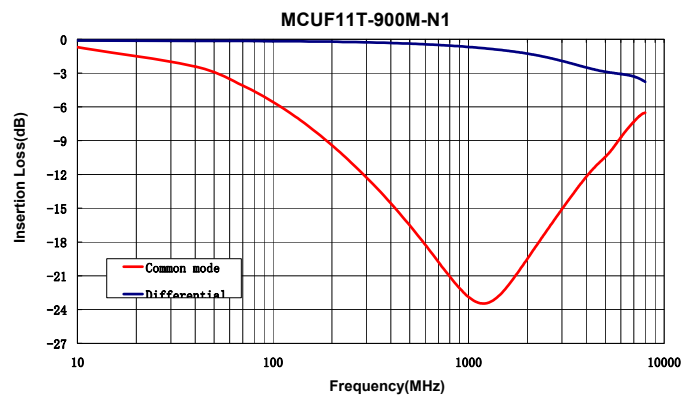
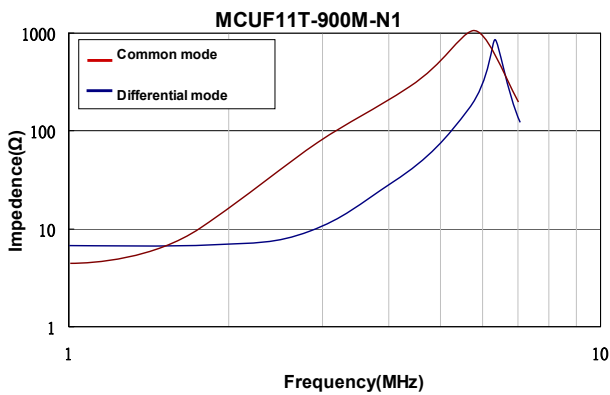
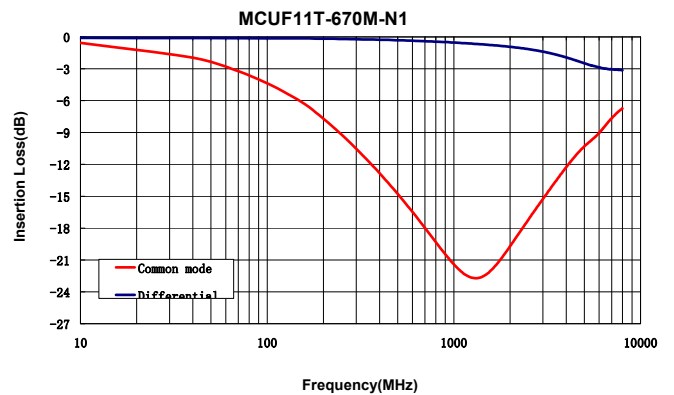
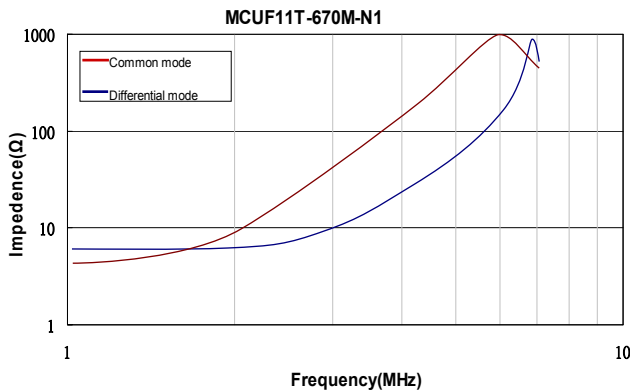

Please be sure to request approval specifications that provide further details of the products. Kindly note that the content of these specifications are subject to change or may be discontinued without advance notice. Please contact our sales department before ordering.

Packaging Specifications

Tape Dimensions

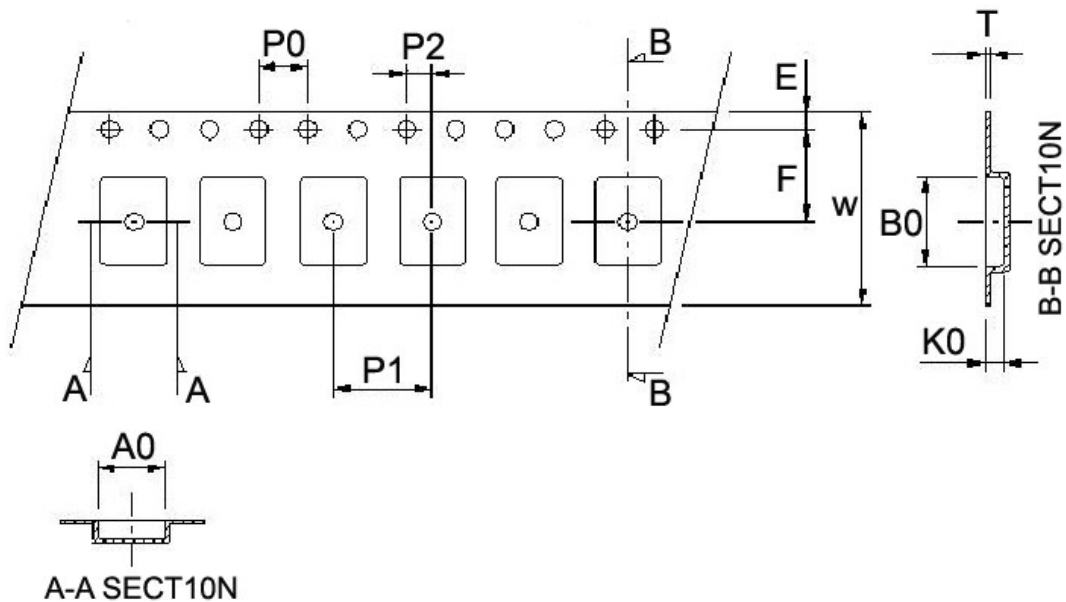

Reel Dimensions

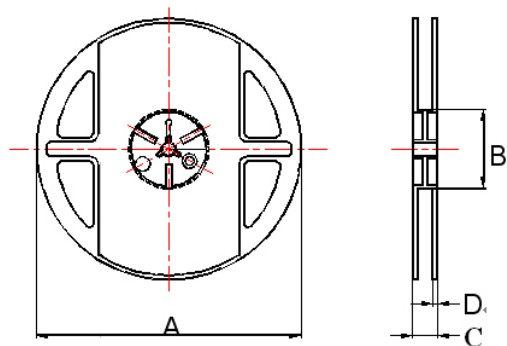

Dimensions in mm

TYPE	Tape Dimensions										Reel Dimensions				Quantity
	A0	B0	W	E	F	P0	P1	P2	T	K0	A	B	C	D	PCS / Reel
MCUF11	1.15	1.5	8	1.75	3.5	4	4	2	0.25	0.72	178	60	12	1.5	4000

CUW Series For USB 2.0, IEEE1394b, LVDS Applications

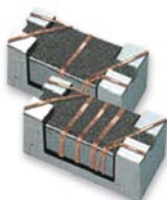

A full series of common mode choke is designed for excellent noise attenuation with compact sizing for use in wide range of applications. Both standard series and custom designs are available.

Features

- RoHS Compliant
- Miniature SMD type common mode filter for fully automated assembly
- Wide impedance range (30Ω ~ 2200Ω) for noise suppression
- Excellent solderability

Applications

- USB line for personal computers and peripheral
- IEEE 1394 line for personal computers, DVC, STB
- LVDS, panel line for liquid display panels, graph card, etc.

Product Identification

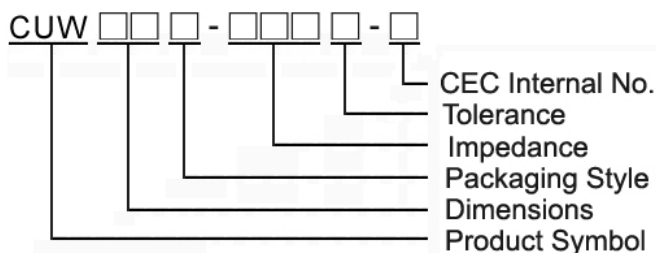

- Packaging: T : Tape and Reel

Shape and Dimensions

CUW10/11/31

CUW21

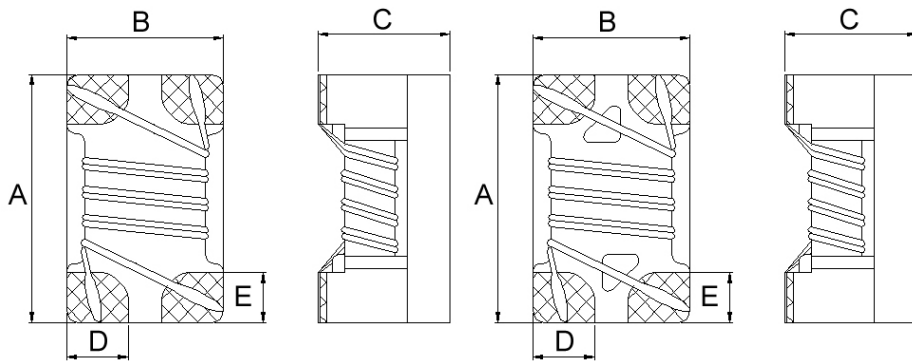

Recommended Pattern

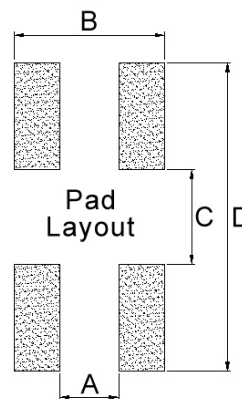

Dimensions in mm

TYPE	A	B	C	D	E
CUW10	1.60±0.2	0.80±0.2	1.10±0.2	0.25	0.33
CUW11	1.25±0.2	1.00±0.2	0.8±0.1	0.32	0.33
CUW21	2.05±0.2	1.25±0.2	1.20±0.2	0.50	0.40
CUW31	3.20±0.2	1.60±0.2	1.90±0.2	0.50	0.60

Dimensions in mm

TYPE	A	B	C	D
CUW10	0.25	0.75	0.61	2.29
CUW11	0.36	1.00	0.59	1.75
CUW21	0.50	1.27	0.80	2.60
CUW31	0.40	1.60	1.60	3.70

Electrical Characteristics

Part Number	Impedance (Ω)	Tolerance (±%)	Test Frequency (MHz)	RDC (Ω) Max	I _{rms} (mA) Max	Rated Voltage (Vdc)	Insulation Resistance (MΩ) Min
CUW10T-250M-N	25	20,25	100	0.077	500	50	10
CUW10T-600M-N	60	20,25	100	0.109	500	50	10
CUW10T-900M-N	90	20,25	100	0.142	500	50	10
CUW10T-121M-N	120	20,25	100	0.160	500	50	10
CUW10T-141M-N	140	20,25	100	0.174	500	50	10
CUW10T-221M-N	220	20,25	100	0.209	500	50	10

Note: When ordering, please specify tolerance code. Tolerance: M=±20% , Y=±25%

- Operating temperature range - 40°C ~ 105°C(Including self - temperature rise)
- rms for 20°C rise from 25°C ambient
- Measure Equipment :
 Z : Agilent HP4287A+Agilent 16197A
 RDC : HP4338B or Chroma 16502 (Single Wire Test Value)
 I_{rms} : HP4284A+HP42841A/HP4285A+HP42841A
 Insulation Resistance : Agilent HP4339B

Test Instruments : HP4287A Material/Impedance Analyzer

Typical Impedance vs. Frequency

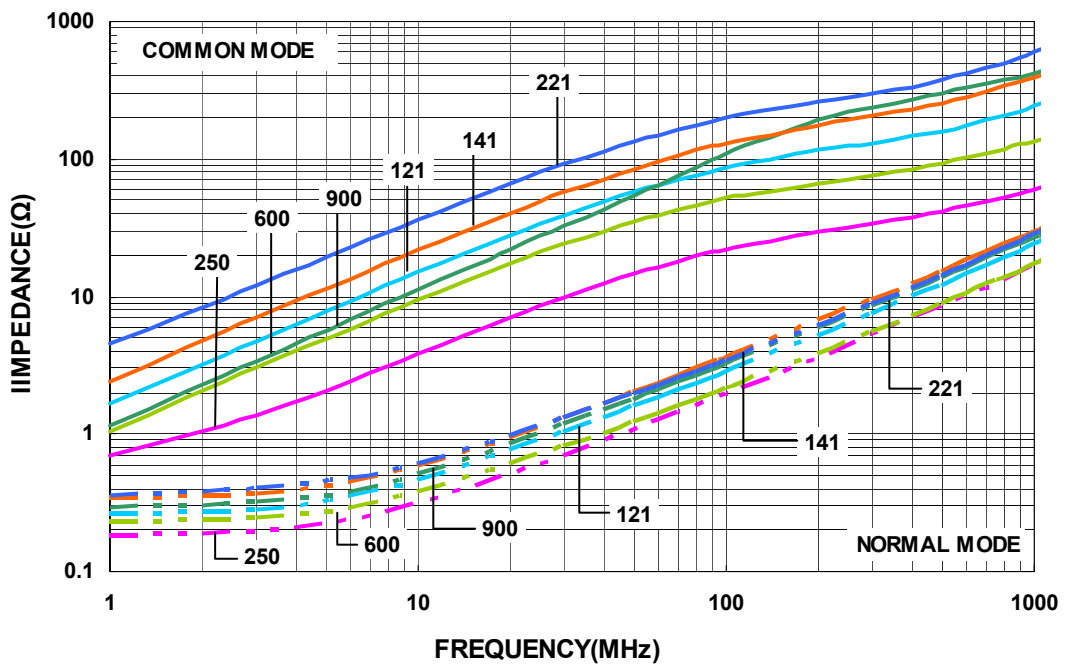

Please be sure to request approval specifications that provide further details of the products. Kindly note that the content of these specifications are subject to change or may be discontinued without advance notice. Please contact our sales department before ordering.

Electrical Characteristics

Part Number	Impedance (Ω)	Tolerance (±%)	Test Frequency (MHz)	RDC (Ω) Max	IDC (mA) Max	Rated Voltage (Vdc)	Insulation Resistance (MΩ) Min
CUW11T-250T-N	25	30	100	0.30	400	20	10
CUW11T-600M-N	60	20	100	0.40	300	20	10
CUW11T-670M-N	67	20	100	0.25	300	50	10
CUW11T-900M-N	90	20	100	0.30	250	50	10
CUW11T-121M-N	120	20	100	0.40	200	50	10
CUW11T-161M-N	160	20	100	0.43	160	50	10
CUW11T-201M-N	200	20	100	0.80	120	50	10
CUW11T-331Y-N	330	25	100	1.30	100	50	10

Note: When ordering, please specify tolerance code. Tolerance: M=±20% , Y=±25% , T=±30%

- Operating temperature range - 40°C ~ 105°C(Including self - temperature rise)
- IDC for Inductance drop 10% from its value without current
- Measure Equipment :
 Z : Agilent HP4287A+Agilent 16197A
 RDC : Chroma 16502 (Single Wire Test Value)
 IDC : HP4284A+HP42841A/HP4285A+HP42841A
 Insulation Resistance : Agilent HP4339B

Test Instruments : HP4287A Material/Impedance Analyzer

Typical Impedance vs. Frequency

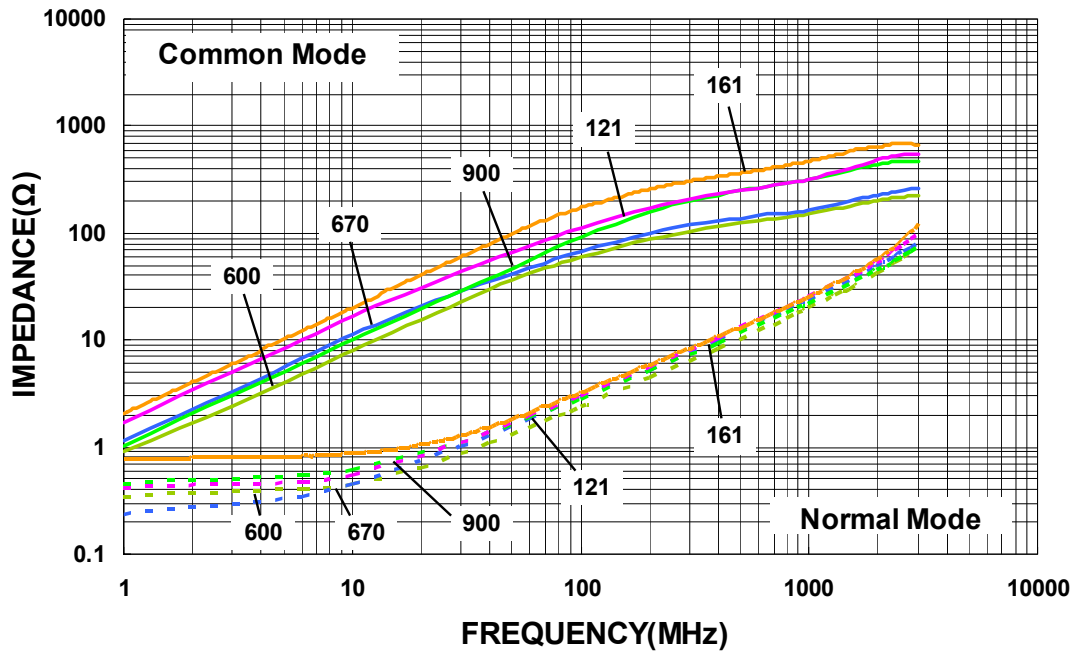

Please be sure to request approval specifications that provide further details of the products. Kindly note that the content of these specifications are subject to change or may be discontinued without advance notice. Please contact our sales department before ordering.

Electrical Characteristics

Part Number	Impedance (Ω)	Tolerance (±%)	Test Frequency (MHz)	RDC (Ω) Max	IDC (mA) Max	Rated Voltage (Vdc)	Insulation Resistance (MΩ) Min
CUW21T-300M-N	30	20	100	0.20	450	50	10
CUW21T-670M-N	67	20	100	0.25	400	50	10
CUW21T-750M-N	75	20	100	0.30	360	50	10
CUW21T-900M-N	90	20	100	0.35	330	50	10
CUW21T-121M-N	120	20	100	0.30	400	50	10
CUW21T-161M-N	160	20	100	0.35	350	50	10
CUW21T-181M-N	180	20	100	0.35	330	50	10
CUW21T-201M-N	200	20	100	0.35	330	50	10
CUW21T-221M-N	220	20	100	0.35	310	50	10
CUW21T-261M-N	260	20	100	0.40	300	50	10
CUW21T-301M-N	300	20	100	0.40	290	50	10
CUW21T-361M-N	360	20	100	0.45	280	50	10
CUW21T-371M-N	370	20	100	0.45	280	50	10
CUW21T-501M-N	500	20	100	0.55	170	50	10
CUW21T-671M-N	670	20	100	0.60	140	50	10
CUW21T-901M-N	900	20	100	0.60	80	50	10

Note: When ordering, please specify tolerance code. Tolerance: M=±20%

- Operating temperature range - 40°C ~ 105°C(Including self - temperature rise)
- IDC for Inductance drop 10% from its value without current
- Measure Equipment :
 Z : Agilent HP4287A+Agilent 16197A
 RDC : Chroma 16502 (Single Wire Test Value)
 IDC : HP4284A+HP42841A/HP4285A+HP42841A
 Insulation Resistance : Agilent HP4339B

Test Instruments : HP4291A Material/Impedance Analyzer

Typical Impedance vs. Frequency

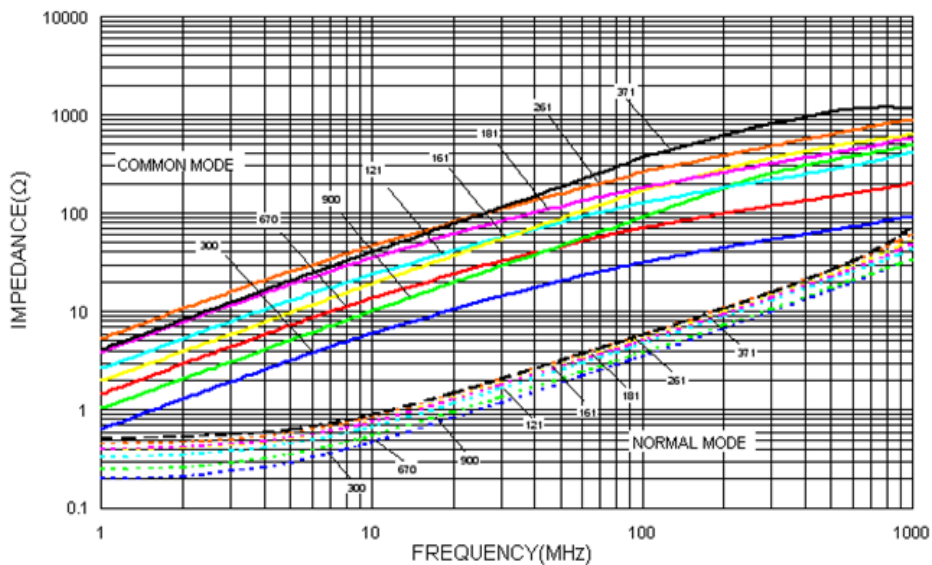

Please be sure to request approval specifications that provide further details of the products. Kindly note that the content of these specifications are subject to change or may be discontinued without advance notice. Please contact our sales department before ordering.

Electrical Characteristics

Part Number	Impedance (Ω)	Tolerance (±%)	Test Frequency (MHz)	RDC (Ω) Max	IDC (mA) Max	Rated Voltage (Vdc)	Insulation Resistance (MΩ) Min
CUW31T-900M-N	90	20	100	0.3	370	50	10
CUW31T-121M-N	120	20	100	0.3	370	50	10
CUW31T-161M-N	160	20	100	0.4	340	50	10
CUW31T-221M-N	220	20	100	0.4	320	50	10
CUW31T-261M-N	260	20	100	0.5	310	50	10
CUW31T-601M-N	600	20	100	0.8	260	50	10
CUW31T-102M-N	1000	20	100	1.0	230	50	10
CUW31T-222M-N	2200	20	100	1.2	200	50	10

Note: When ordering, please specify tolerance code. Tolerance: M=±20%

- Operating temperature range - 40°C ~ 105°C(Including self - temperature rise)
- IDC for Inductance drop 10% from its value without current
- Measure Equipment :
 Z : Agilent HP4287A+Agilent 16197A
 RDC : Chroma 16502 (Single Wire Test Value)
 IDC : HP4284A+HP42841A/HP4285A+HP42841A
 Insulation Resistance : Agilent HP4339B

Test Instruments : HP4291A Material/Impedance Analyzer

Typical Impedance vs. Frequency

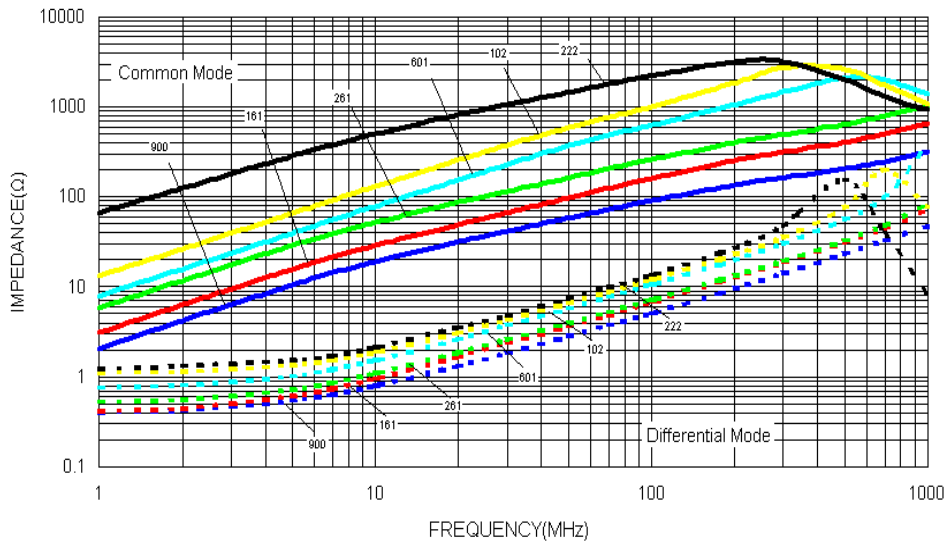

Please be sure to request approval specifications that provide further details of the products. Kindly note that the content of these specifications are subject to change or may be discontinued without advance notice. Please contact our sales department before ordering.

Packaging Specifications

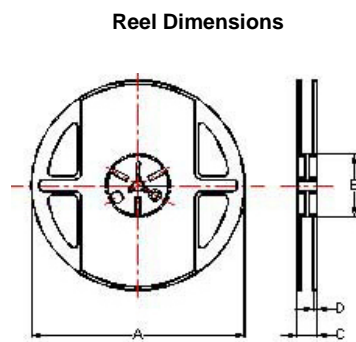
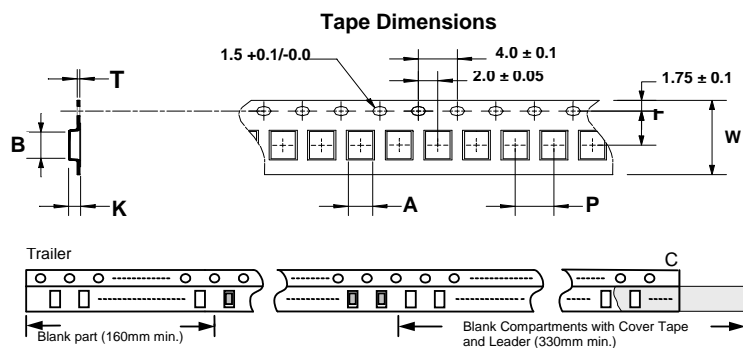

Dimensions in mm

TYPE	Tape Dimensions							Reel Dimensions				Quantity PCS / Reel
	A	B	T	W	P	F	K	A	B	C	D	
CUW10	0.95	1.70	0.24	8	4	3.5	1.15	178	60	12	1.5	2000
CUW11	1.15	1.45	0.24	8	4	3.5	1.00	178	60	12	1.5	2000
CUW21	1.50	2.25	0.24	8	4	3.5	1.35	178	60	12	1.5	2000
CUW31	1.76	3.47	0.22	8	4	3.5	2.05	178	60	12	1.5	2000

Electrical Characteristics

Part Number	Impedance (Ω)	Tolerance (±%)	Test Frequency (MHz)	RDC (Ω) Max	IDC (mA) Max	Rated Voltage (Vdc)	Insulation Resistance (MΩ) Min
CUW0805-300M-N	30	20	100	0.20	1300	50	10
CUW0805-420M-N	42	20	100	0.20	1300	50	10
CUW0805-670M-N	67	20	100	0.25	1200	50	10
CUW0805-900M-N	90	20	100	0.27	1000	50	10
CUW0805-121M-N	120	20	100	0.30	900	50	10
CUW0805-181M-N	180	20	100	0.40	700	50	10
CUW0805-261M-N	260	20	100	0.60	700	50	10

Note: When ordering, please specify tolerance code. Tolerance: M=±20%

- Operating temperature range - 40°C ~ 105°C(Including self - temperature rise)
- IDC for Inductance drop 10% from its value without current.
- Measure Equipment :
 Z : Agilent HP4291A
 RDC : HP4338B or Chroma 16502 (Single Wire Test Value)
 IDC : HP4284A+HP42841A/HP4285A+HP42841A
 Insulation Resistance : Agilent HP4339B

Test Instruments : HP4291A Material/Impedance Analyzer

Typical Impedance vs. Frequency

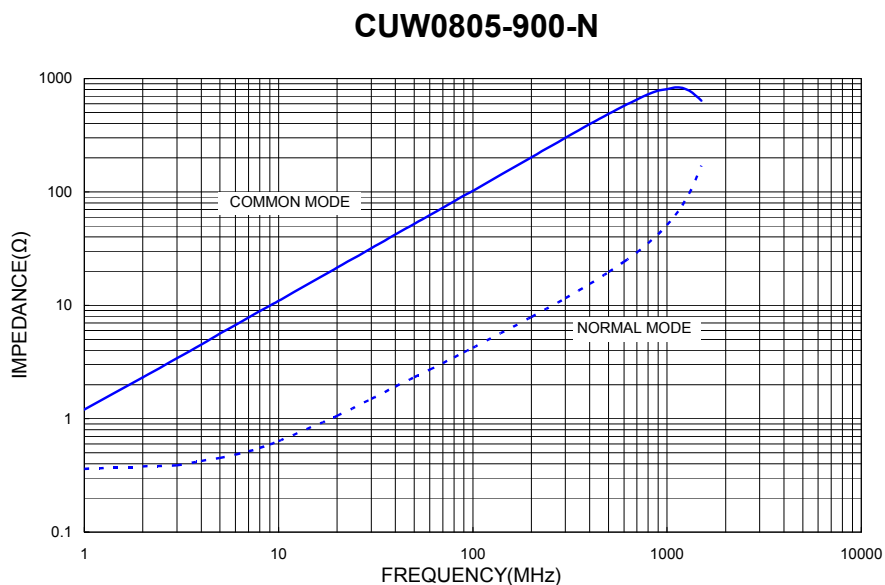

Please be sure to request approval specifications that provide further details of the products. Kindly note that the content of these specifications are subject to change or may be discontinued without advance notice. Please contact our sales department before ordering.

Packaging Specifications

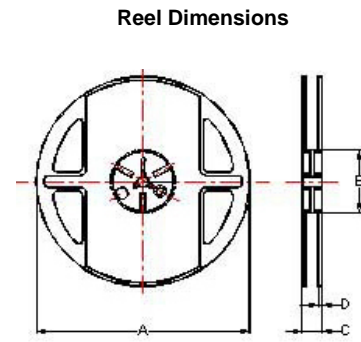
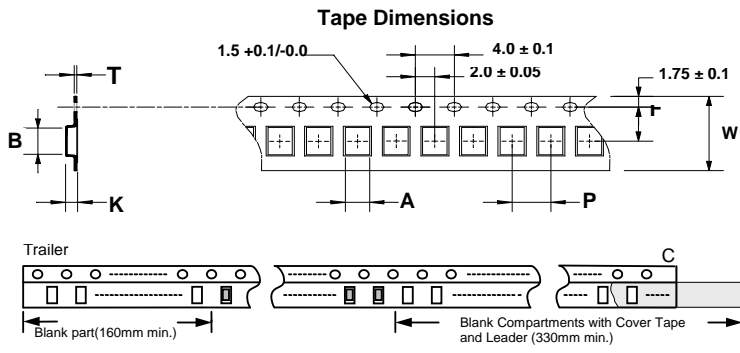

Dimensions in mm

TYPE	Tape Dimensions								Reel Dimensions				Quantity PCS / Reel
	A	B	T	W	P	F	K	A	B	C	D		
CUW0805	1.60	2.42	0.26	8	4	3.5	1.14	178	60	12	1.5	2000	

CUWI Series For HDMI, USB 3.0

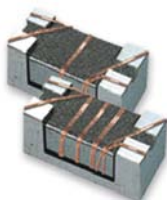

A full series of common mode choke is designed for excellent noise attenuation and compact sizing for use in wide range of applications. Both standard series and custom designs are available.

Features

- RoHS Compliant
- Miniature SMD type common mode filter for fully automated assembly
- Excellent solderability

Applications

- HDMI
- USB lines (for personal computers and peripheral), DVC, STB, LVDS, panel line for liquid display panels, etc.

Product Identification

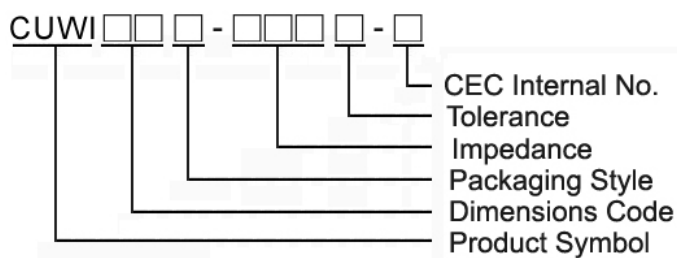

- Packaging: T : Tape and Reel

Shape and Dimensions

CUWI11

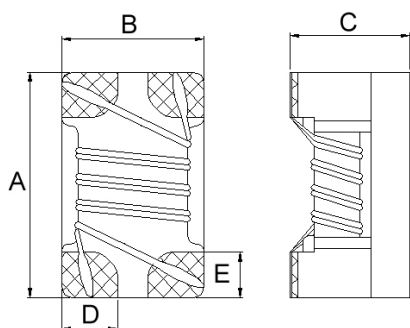

CUWI21

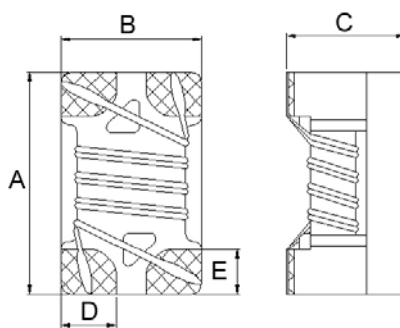

Dimensions in mm

TYPE	A	B	C	D	E
CUWI11	1.25±0.2	1.00±0.2	0.80±0.1	0.32	0.33
CUWI21	2.05±0.2	1.25±0.2	1.20±0.2	0.50	0.40

Recommended Pattern

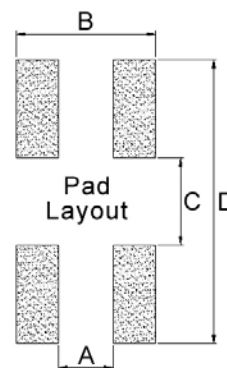

Dimensions in mm

TYPE	A	B	C	D
CUWI11	0.36	1.00	0.59	1.75
CUWI21	0.50	1.27	0.80	2.60

Electrical Characteristics

Part Number	Impedance (Ω)	Tolerance (±%)	Test Frequency (MHz)	RDC (Ω) Max	IDC (mA) Max	Rated Voltage (Vdc)	Insulation Resistance (MΩ) Min
CUWI11T-600Y-N	60	25	100	0.40	250	20	10
CUWI11T-900Y-N	90	25	100	0.30	250	20	10

Note: When ordering, please specify tolerance code. Tolerance: Y=±25%

- Operating temperature range - 40°C ~ 105°C(Including self - temperature rise)
- IDC for Inductance drop 10% from its value without current.
- Measure Equipment :
 Z : HP4286A/HP4287A/Agilent E4991A+Agilent16197A
 RDC : Chroma 16502 (Single Wire Test Value)
 IDC : HP4284A+HP42841A/HP4285A+HP42841A
 Insulation Resistance : Agilent HP4339B

Test Instruments : HP4291A Material/Impedance Analyzer

Typical Impedance vs. Frequency

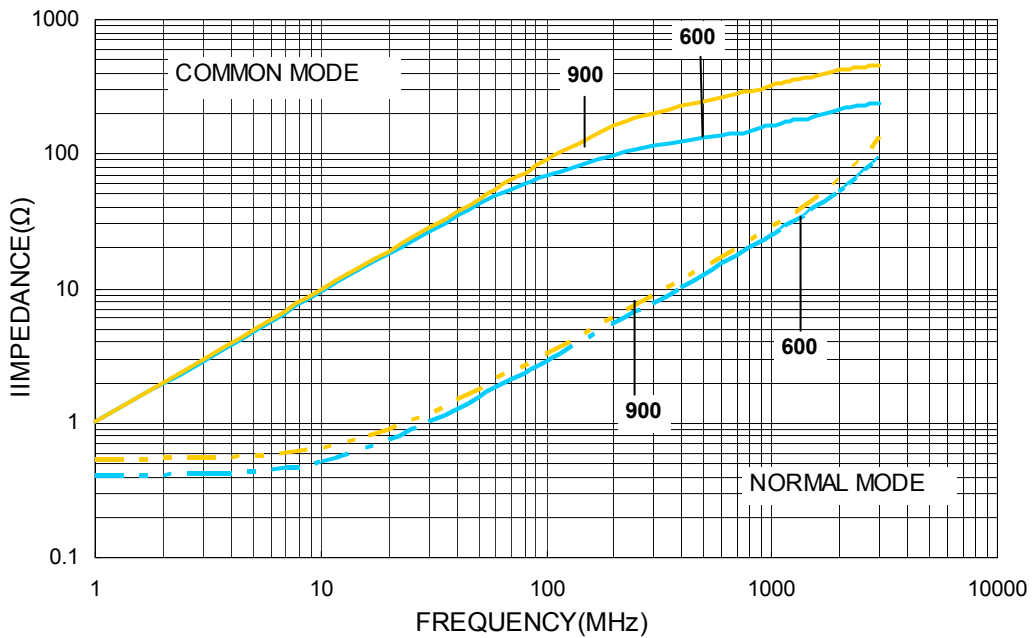

Please be sure to request approval specifications that provide further details of the products. Kindly note that the content of these specifications are subject to change or may be discontinued without advance notice. Please contact our sales department before ordering.

CUWI11T-600Y-N

Insertion Loss For HDMI2.0 Testing:

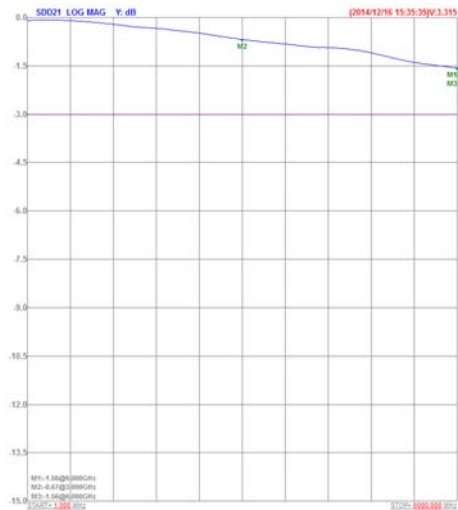

Insertion Loss For USB3.0 Testing:

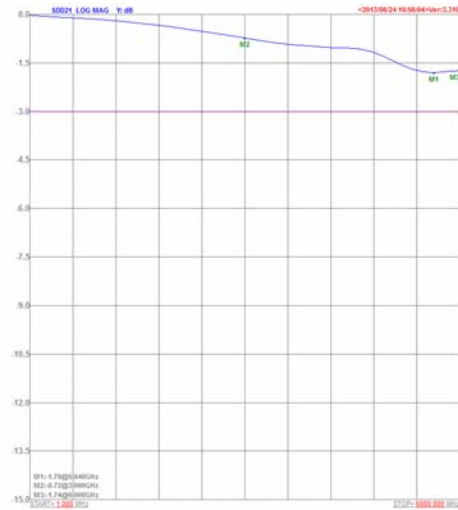

TDR For HDMI2.0 Testing:

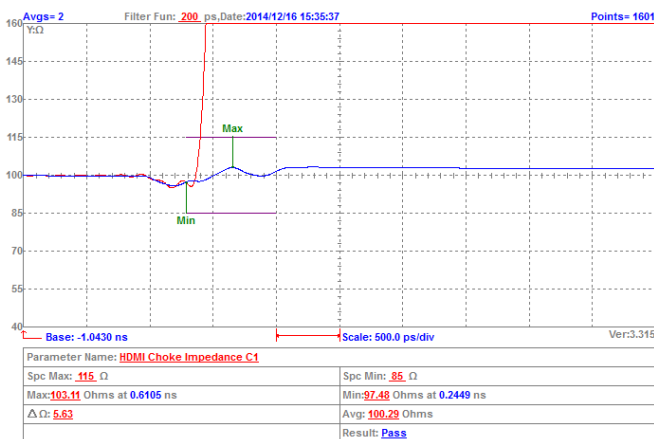

TDR For USB3.0 Testing:

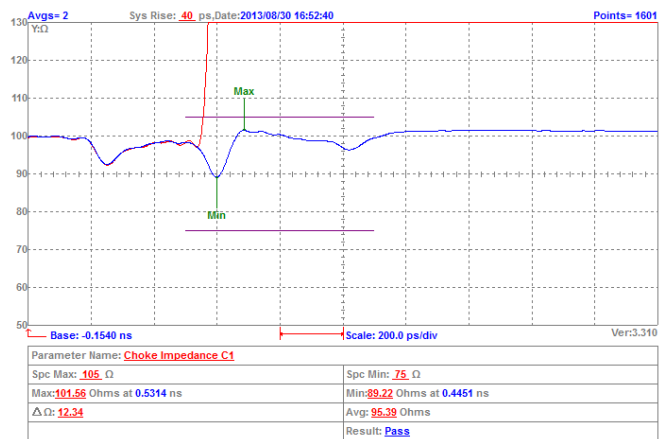

Eye Diagram For HDMI2.0 Testing:

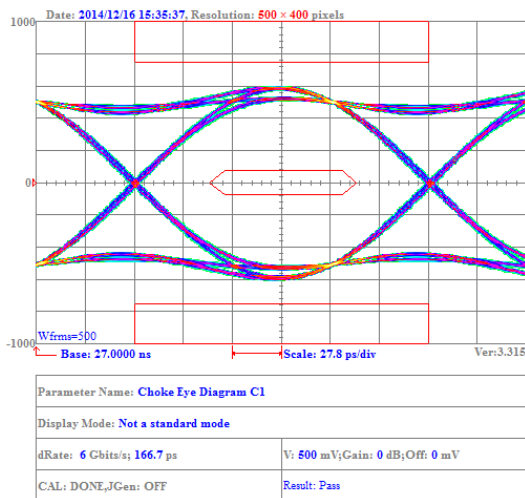

Eye Diagram For USB3.0 Testing:

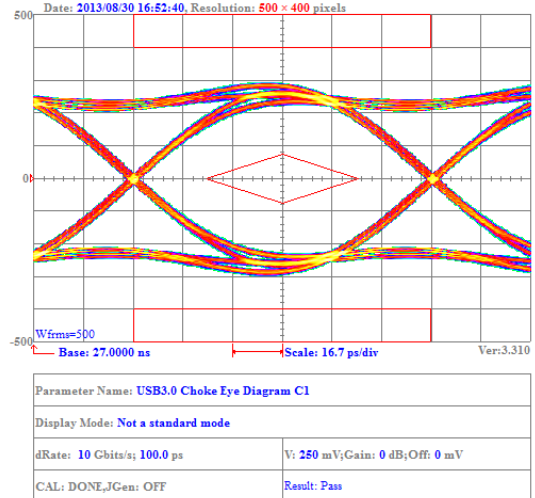

Please be sure to request approval specifications that provide further details of the products. Kindly note that the content of these specifications are subject to change or may be discontinued without advance notice. Please contact our sales department before ordering.

CUWI11T-900Y-N

Insertion Loss For HDMI2.0 Testing:

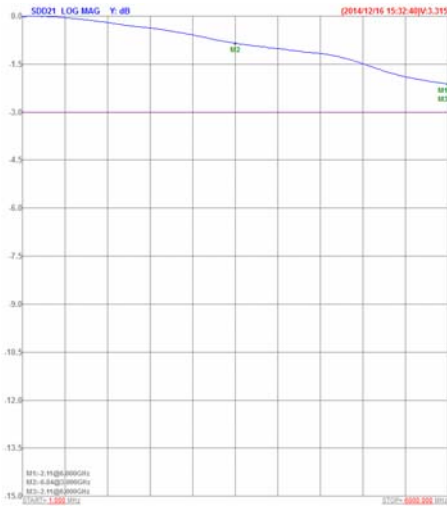

Insertion Loss For USB3.0 Testing:

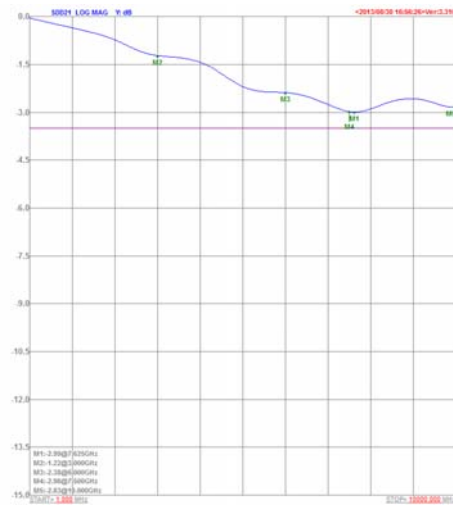

TDR For HDMI2.0 Testing:

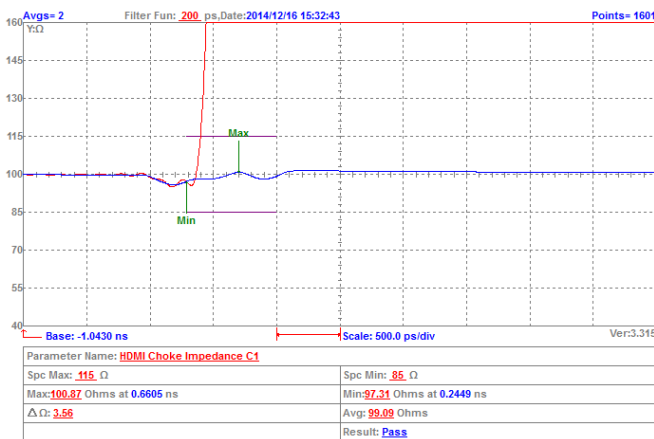

TDR For USB3.0 Testing:

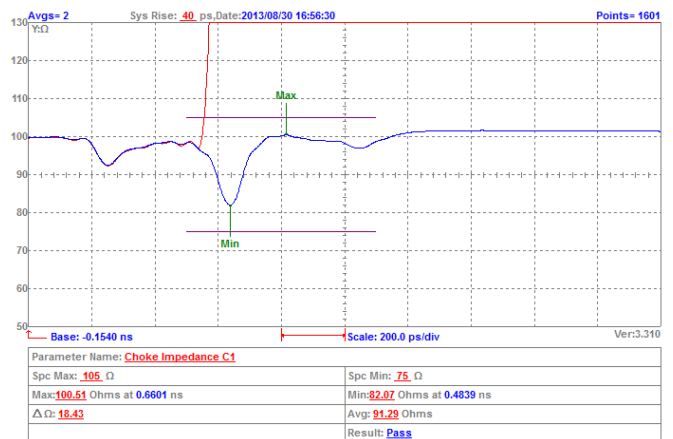

Eye Diagram For HDMI2.0 Testing:

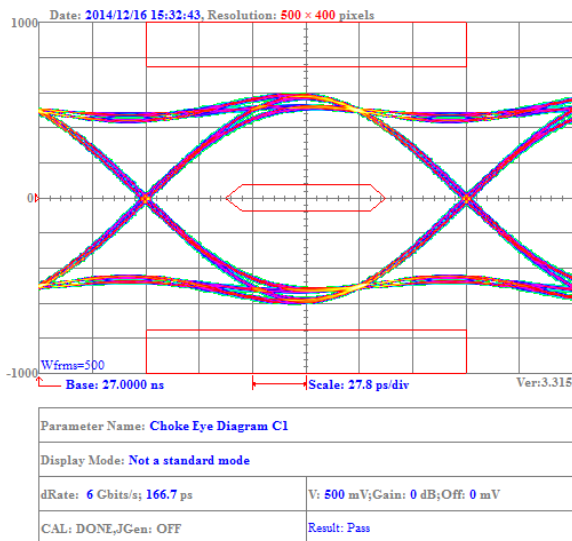

Eye Diagram For USB3.0 Testing:

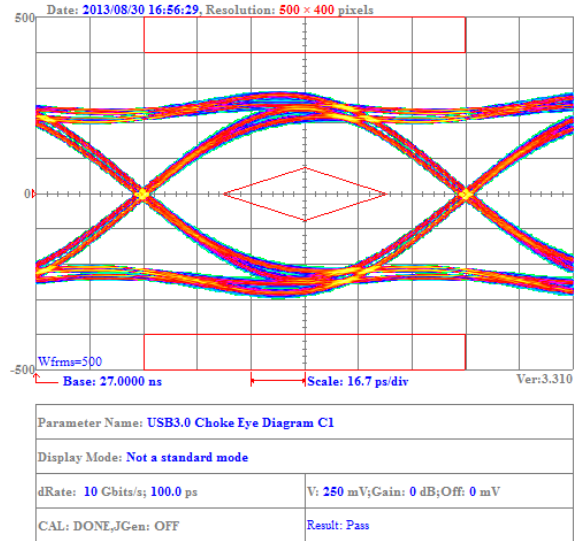

Please be sure to request approval specifications that provide further details of the products. Kindly note that the content of these specifications are subject to change or may be discontinued without advance notice. Please contact our sales department before ordering.

Electrical Characteristics

Part Number	Impedance (Ω)	Tolerance (±%)	Test Frequency (MHz)	RDC (Ω) Max	IDC (mA) Max	Rated Voltage (Vdc)	Insulation Resistance (MΩ) Min
CUWI21T-500Y-N	50	25	100	0.20	500	50	10
CUWI21T-670Y-N	67	25	100	0.30	500	50	10
CUWI21T-900Y-N	90	25	100	0.30	500	50	10
CUWI21T-121Y-N	120	25	100	0.35	330	50	10
CUWI21T-131Y-N	130	25	100	0.40	300	50	10

Note: When ordering, please specify tolerance code. Tolerance: Y=±25%

- Operating temperature range - 40°C ~ 105°C(Including self - temperature rise)
- IDC for Inductance drop 10% from its value without current.
- Measure Equipment :
 Z : HP4286A/HP4287A/Agilent E4991A+Agilent16197A
 RDC : Chroma 16502 (Single Wire Test Value)
 IDC : HP4284A+HP42841A/HP4285A+HP42841A
 Insulation Resistance : Agilent HP4339B

Test Instruments : HP4291A Material/Impedance Analyzer

Typical Impedance vs. Frequency

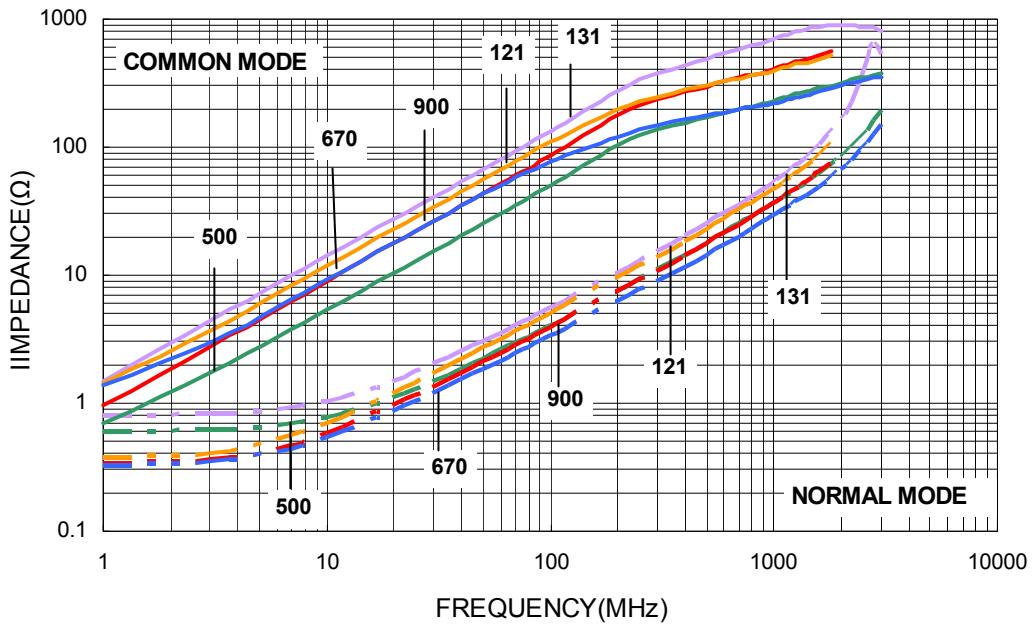

Please be sure to request approval specifications that provide further details of the products. Kindly note that the content of these specifications are subject to change or may be discontinued without advance notice. Please contact our sales department before ordering.

CUWI21T-500Y-N

Insertion Loss For HDMI2.0 Testing:

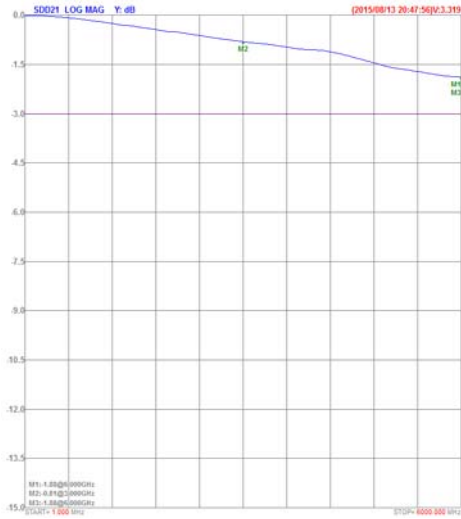

Insertion Loss For USB3.0 Testing:

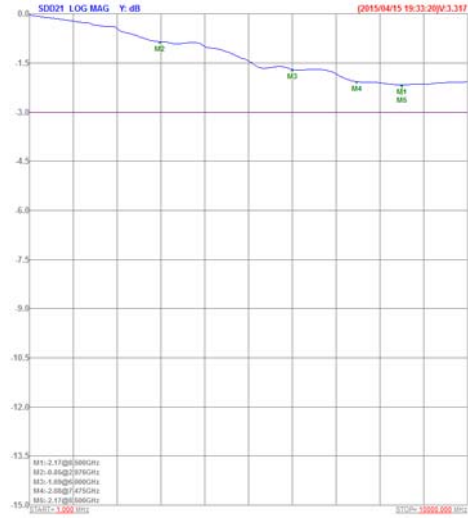

TDR For HDMI2.0 Testing:

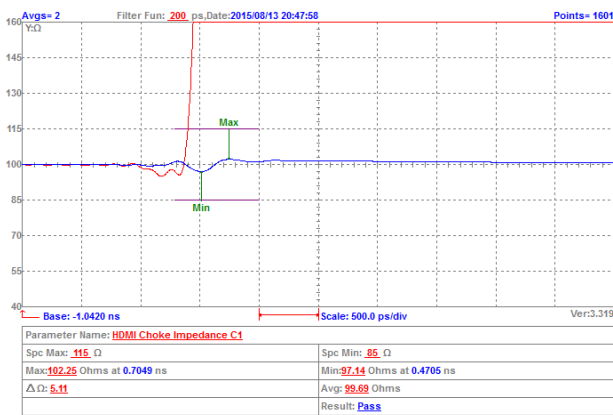

TDR For USB3.0 Testing:

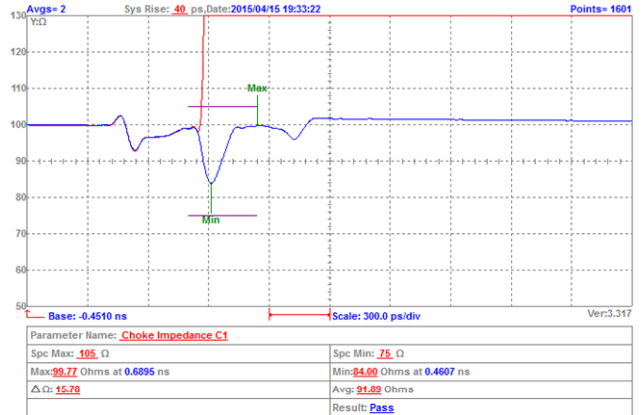

Eye Diagram For HDMI2.0 Testing:

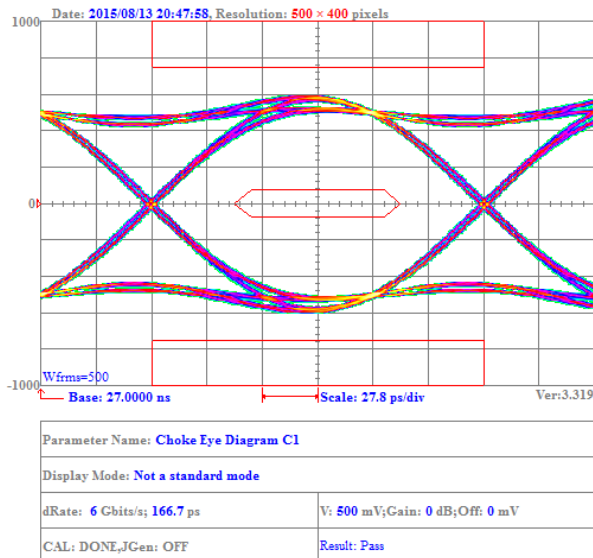

Eye Diagram For USB3.0 Testing:

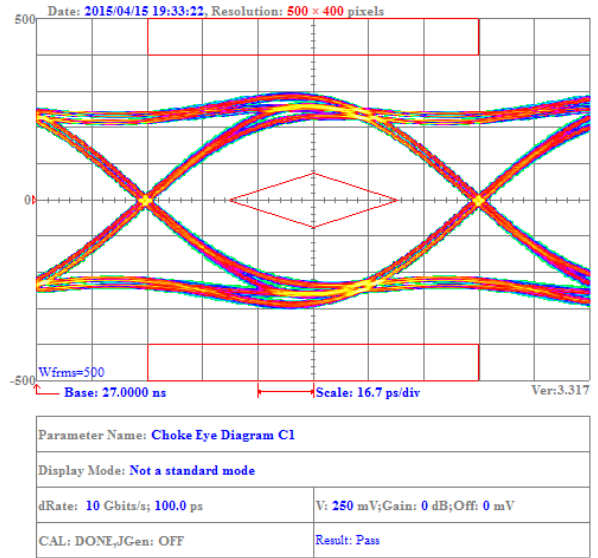

Please be sure to request approval specifications that provide further details of the products. Kindly note that the content of these specifications are subject to change or may be discontinued without advance notice. Please contact our sales department before ordering.

CUWI21T-670Y-N

Insertion Loss For HDMI2.0 Testing:



Insertion Loss For USB3.0 Testing:

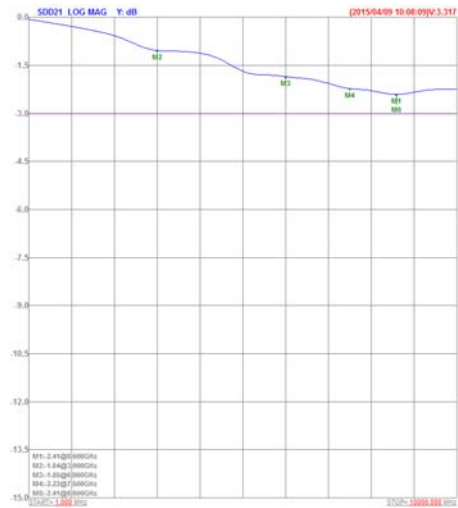

TDR For HDMI2.0 Testing:

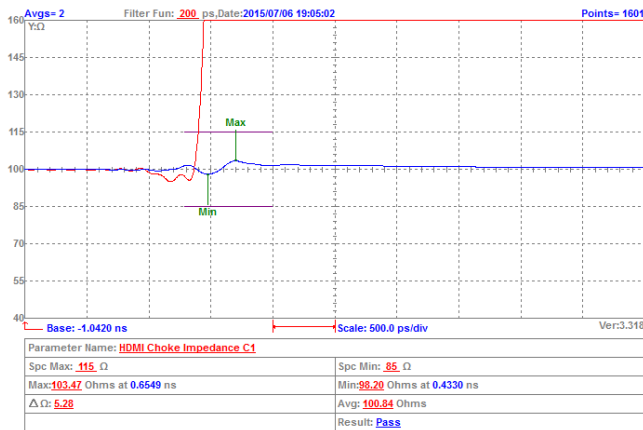

TDR For USB3.0 Testing:

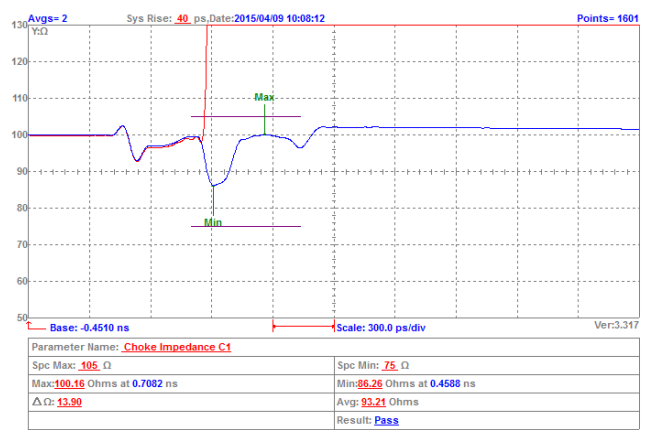

Eye Diagram For HDMI2.0 Testing:

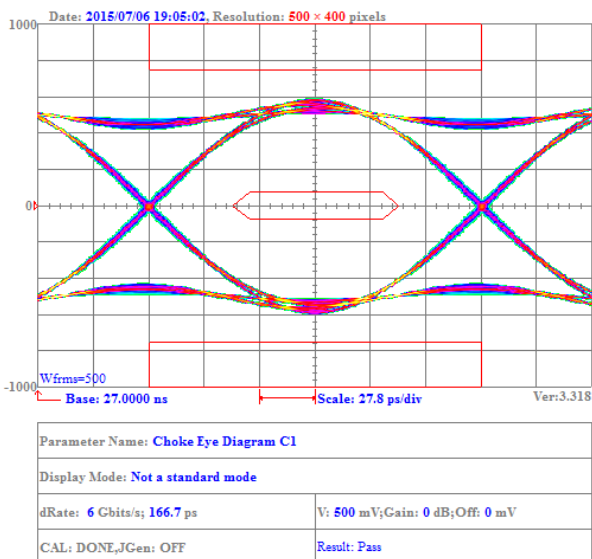

Eye Diagram For USB3.0 Testing:

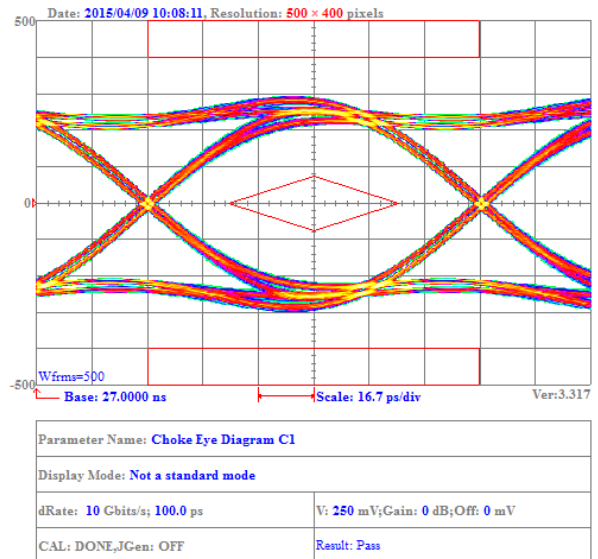

Please be sure to request approval specifications that provide further details of the products. Kindly note that the content of these specifications are subject to change or may be discontinued without advance notice. Please contact our sales department before ordering.

CUWI21T-900Y-N

Insertion Loss For HDMI2.0 Testing:

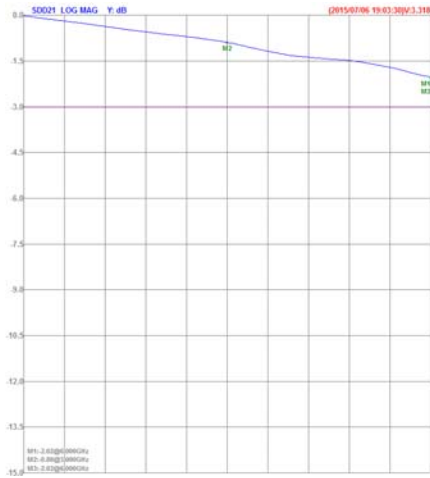

Insertion Loss For USB3.0 Testing:

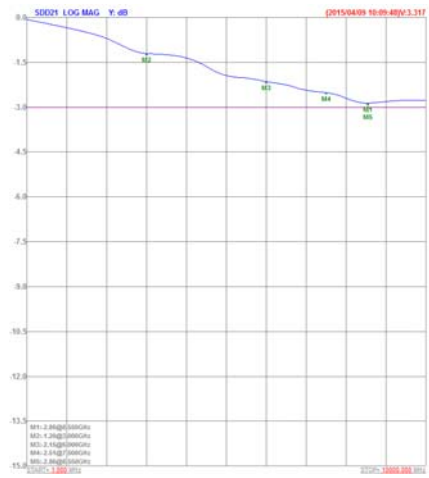

TDR For HDMI2.0 Testing:

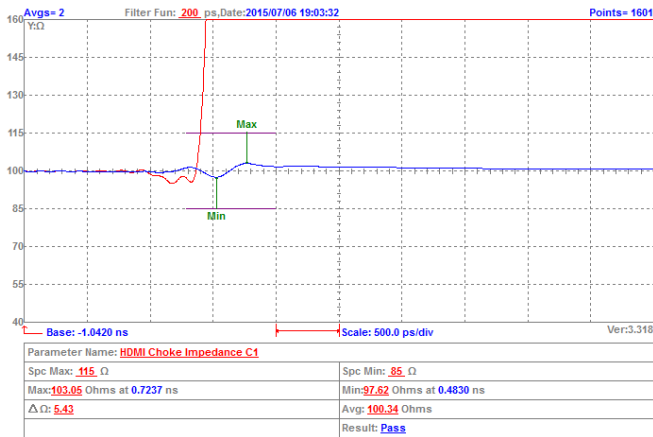

TDR For USB3.0 Testing:

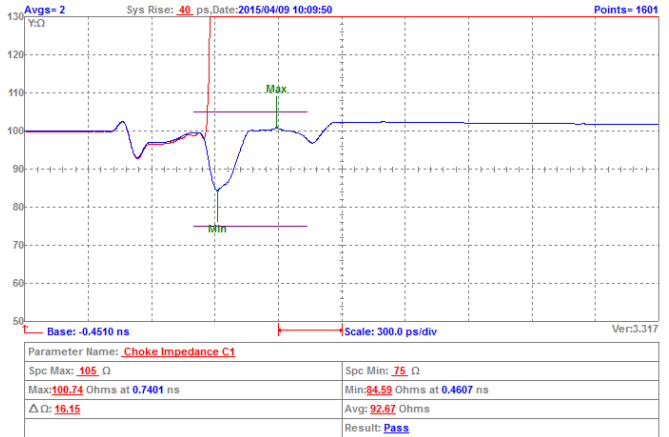

Eye Diagram For HDMI2.0 Testing:

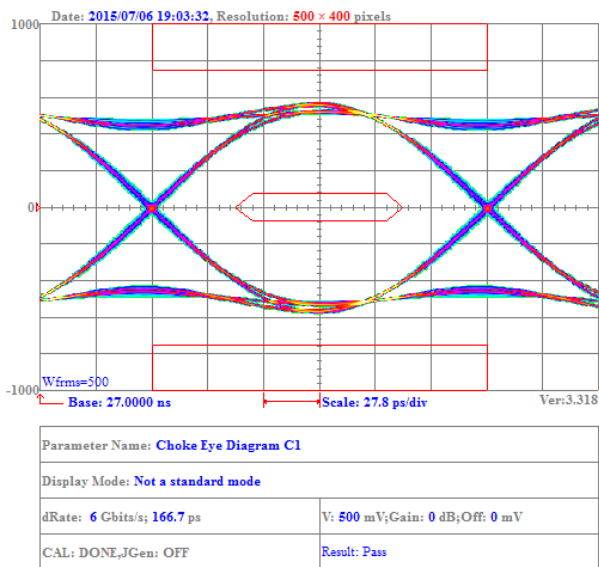

Eye Diagram For USB3.0 Testing:

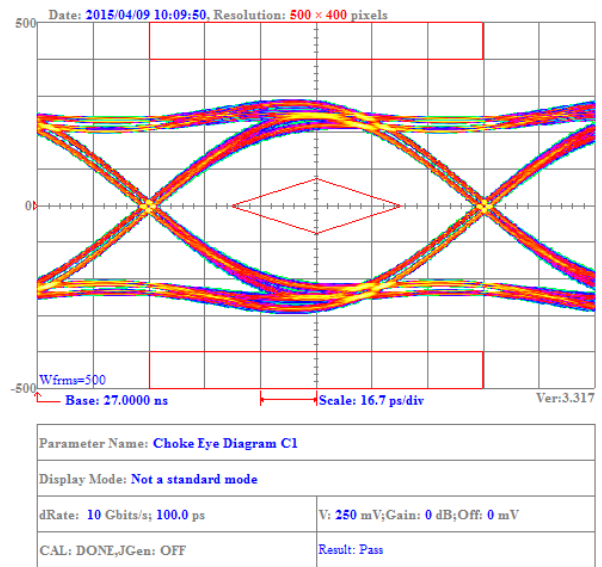

Please be sure to request approval specifications that provide further details of the products. Kindly note that the content of these specifications are subject to change or may be discontinued without advance notice. Please contact our sales department before ordering.

CUWI21T-121Y-N

Insertion Loss For HDMI2.0 Testing:

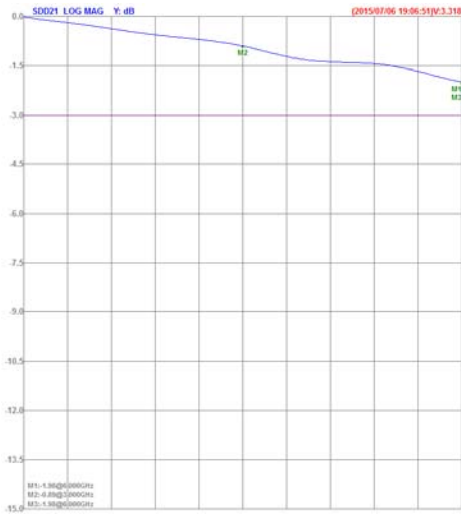

Insertion Loss For USB3.0 Testing:

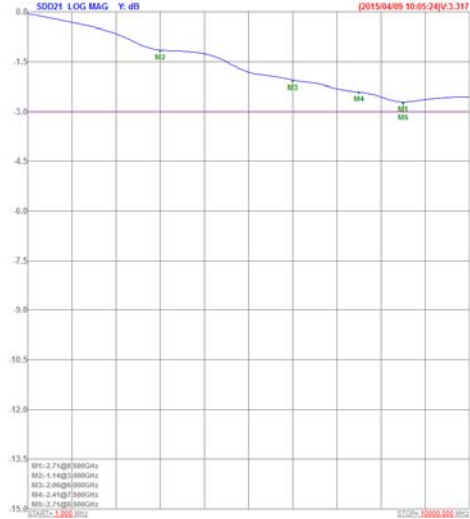

TDR For HDMI2.0 Testing:

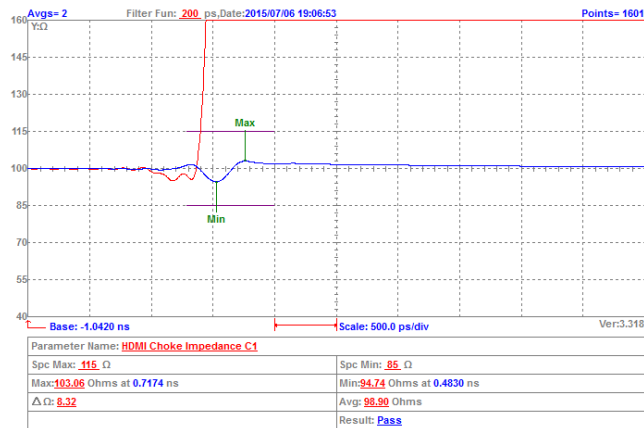

TDR For USB3.0 Testing:

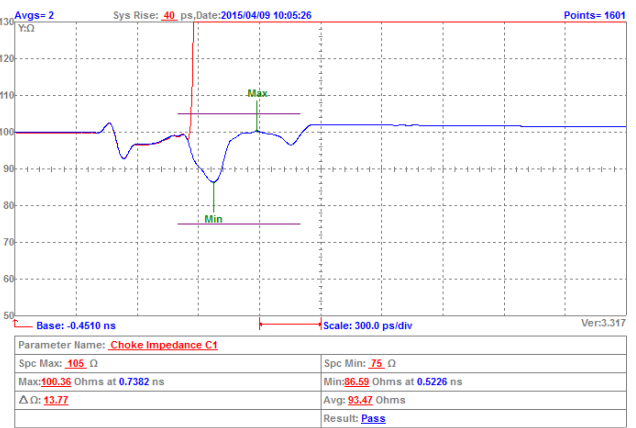

Eye Diagram For HDMI2.0 Testing:

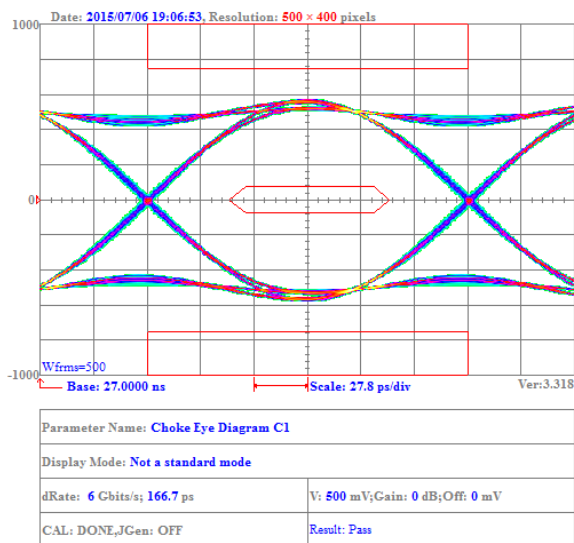

Eye Diagram For USB3.0 Testing:

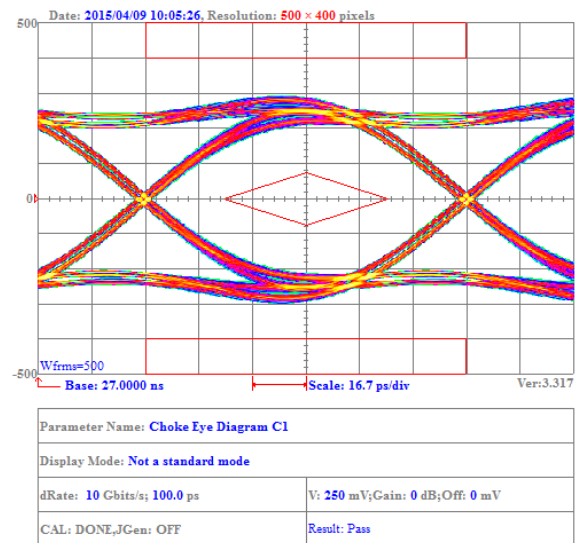

Please be sure to request approval specifications that provide further details of the products. Kindly note that the content of these specifications are subject to change or may be discontinued without advance notice. Please contact our sales department before ordering.

CUWI21T-131Y-N

Insertion Loss For HDMI Testing:

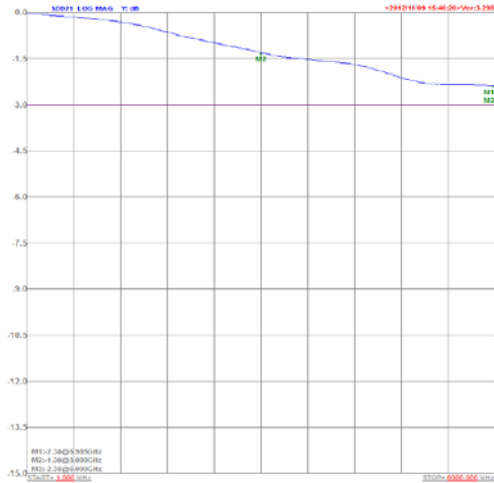

Insertion Loss For USB3.0 Testing:

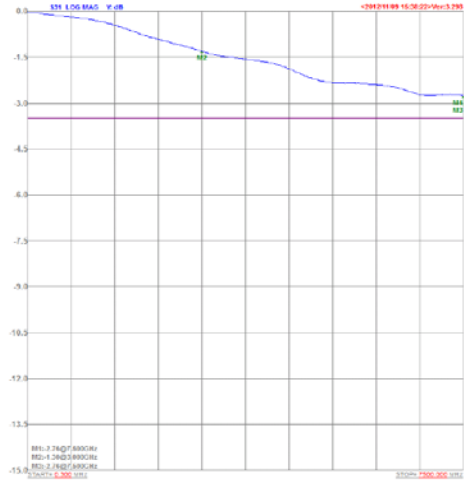

TDR For HDMI Testing:

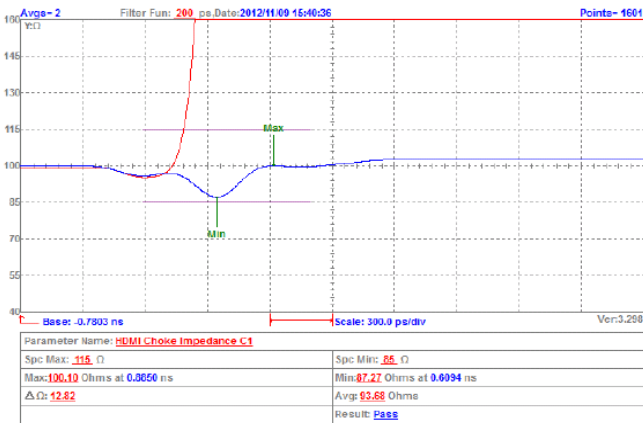

TDR For USB3.0 Testing:

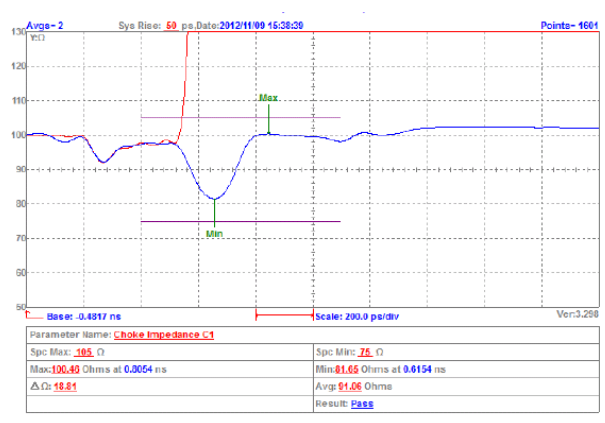

Eye Diagram For HDMI Testing:

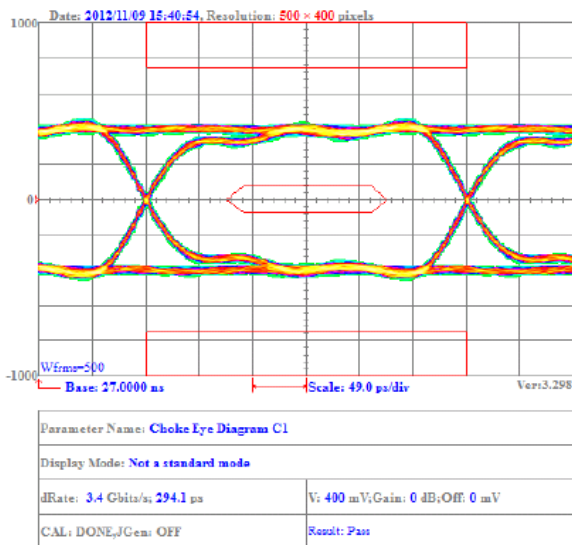

Eye Diagram For USB3.0 Testing:

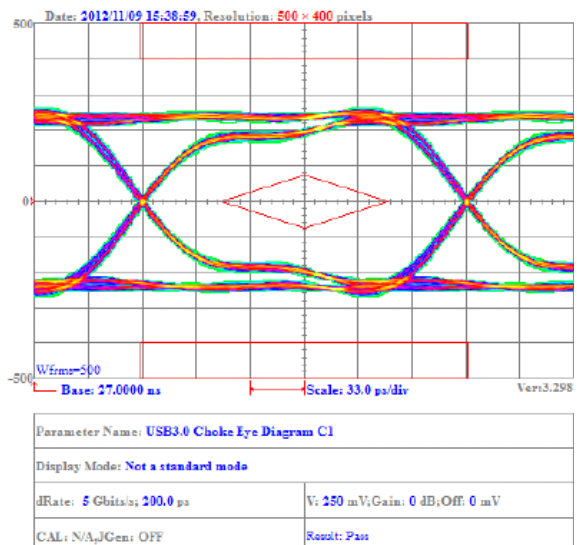

Please be sure to request approval specifications that provide further details of the products. Kindly note that the content of these specifications are subject to change or may be discontinued without advance notice. Please contact our sales department before ordering.

Packaging Specifications

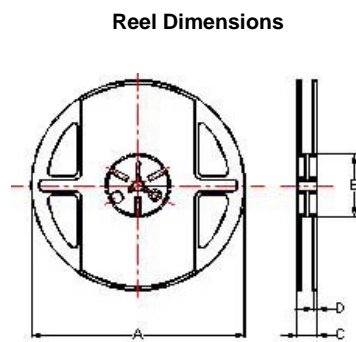
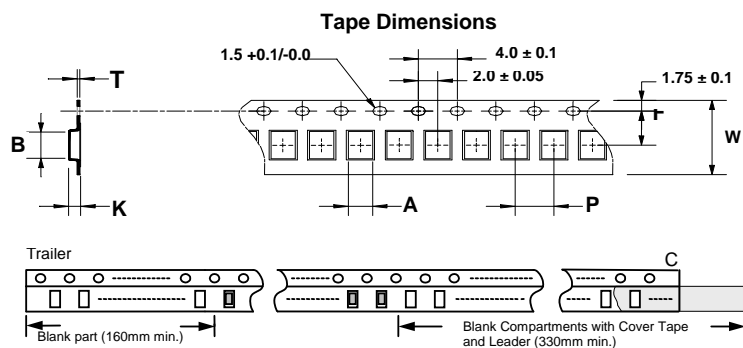

Dimensions in mm

TYPE	Tape Dimensions							Reel Dimensions				Quantity PCS / Reel
	A	B	T	W	P	F	K	A	B	C	D	
CUWI11	1.15	1.45	0.25	8	4	3.5	1.00	178	60	12	1.5	2000
CUWI21	1.50	2.25	0.24	8	4	3.5	1.35	178	60	12	1.5	2000



Total Solution Provider for EMI, Power and RF.

Inductors Leaded Components



DMI Series



DMI series is designed with low RDC and ultra large current. Its molded magnetic shielded type is suitable for high-density mounting and ultra low buzz noise. Soldering conditions can be easily confirmed when mounting onto the board. This series also provides customers with embossed carrier type packaging for automatic mounting machine.

Features

- Shield construction
- Ultra low buzz noise, due to un-assembly structure
- 100% Lead free

Applications

- High density DC/DC converters
- POL convertes
- High current VRM/VRD for notebook / Server / desktop CPUs
- High speed charger

Product Identification

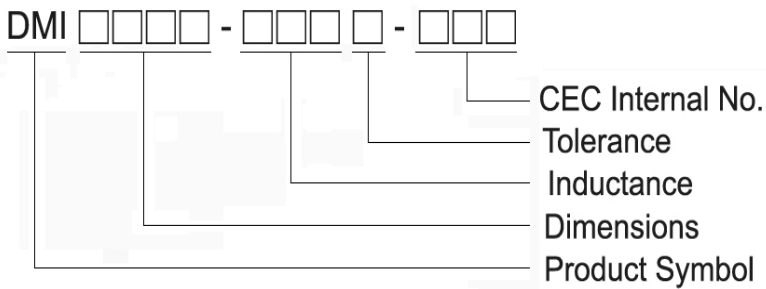

Shapes and Dimensions

FIG 1

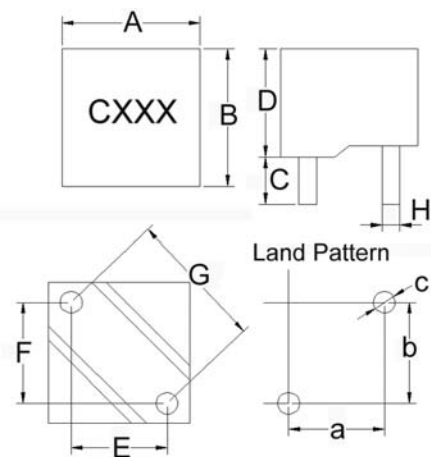

FIG 2

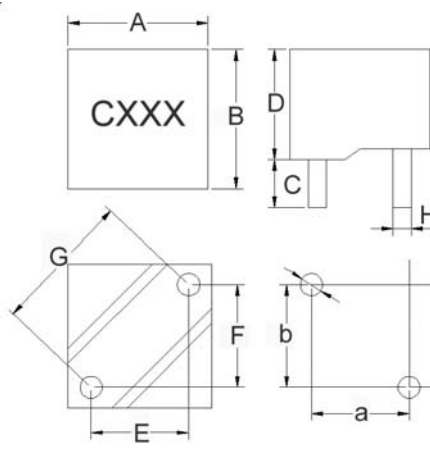
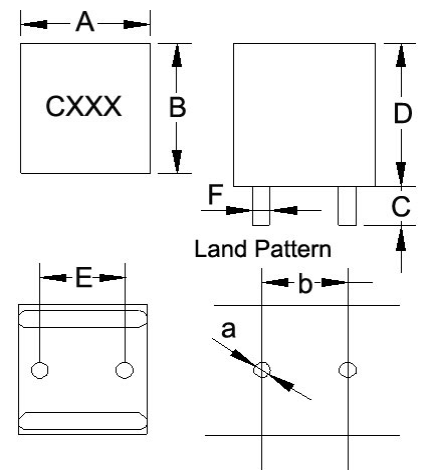

FIG 3



Leaded Power Chokes DMI Series

Dimensions in mm

TYPE	FIG	A	B	C	D	E	F	G	H	a	b	c
DMI0707-R40M-N	2	7.2±0.5	7.2±0.5	3.4±0.5	7.5Max	3.8±0.5	3.8±0.5	5.4±0.5	0.9Φ±0.1	4.3	4.3	1.4
DMI0805-R40M-N	2	8.0±0.5	8.0±0.5	3.4±0.5	5.5±0.5	4.7±0.5	4.7±0.5	6.6±0.5	1.0Φ±0.1	5.2	5.2	1.5
DMI0806-R47M-N	2	8.0±0.5	8.0±0.5	3.4±0.5	6.0Max	4.7±0.5	4.7±0.5	6.6±0.5	1.0Φ±0.1	5.2	5.2	1.5
DMI0807-1R0M-N	3	8.5±0.5	8.5±0.5	3.4±0.5	7.5Max	5.0±0.5	0.8ø±0.1	-	-	1.3	5.5	-
DMI0808-R30M-N	1	8.5Max	8.5Max	3.4±0.5	9.0Max	4.7±0.5	4.7±0.5	6.6±0.5	1.1ø±0.1	5.2	5.2	1.6
DMI0808-1R0M-N	3	9.0Max	9.0Max	3.4±0.5	9.0Max	5.0±0.5	0.8ø±0.1	-	-	1.3	5.5	-
DMI0809-1R0M-N	1	8.0Max	8.0Max	3.4±0.5	9.5Max	4.2±0.5	4.2±0.5	5.9±0.5	1.1ø±0.1	4.7	4.7	1.6
DMI0809-2R2M-N	1	8.0Max	8.0Max	3.4±0.5	9.5Max	4.2±0.5	4.2±0.5	5.9±0.5	0.9ø±0.1	4.7	4.7	1.4
DMI0809-2R2M-N1	2	8.5±0.5	8.5±0.5	3.4±0.5	9.8Max	4.0±0.5	5.5±0.5	6.8±0.5	0.9Φ±0.1	4.5	6	1.4
DMI0809-R20M-N64	2	8.5Max	8.5Max	3.4±0.5	9.5Max	4.7±0.5	4.7±0.5	6.6±0.5	1.2Φ±0.1	5.2	5.2	1.7
DMI0809-R50M-NA	1	8.5±0.5	8.5±0.5	3.4±0.5	8.5Max	3.5±0.5	5.5±0.5	6.52±0.5	1.1Φ±0.1	4.0	6.0	1.6
DMI0809-R56M-N	2	8.5Max	8.5Max	3.4±0.5	9.5Max	4.7±0.5	4.7±0.5	6.6 ^{+0.3} _{-0.5}	1.2ø±0.1	5.2	5.2	1.7
DMI0809-R56M-N18	2	8.5Max	8.5Max	3.4±0.5	9.5Max	4.7±0.5	4.7±0.5	6.6±0.5	1.2Φ±0.1	5.2	5.2	1.7
DMI0909-1R2M-N	1	9.0Max	9.0Max	3.4±0.5	9.0Max	4.6±0.5	4.6±0.5	6.5±0.5	0.9Φ±0.1	5.1	5.1	1.4
DMI0909-R25M-N	2	9.0Max	8.2Max	3.4±0.5	9.5Max	6.5±0.5	2.7±0.5	6.85±0.5	1.2ø±0.1	7	3.2	1.7
DMI0810-1R0M-NA	1	8.5±0.5	8.5±0.5	3.4±0.5	10.0Max	3.5±0.5	5.5±0.5	6.5±0.5	1.0Φ±0.1	4.0	6.0	1.5
DMI1007-R18M-NA	2	10.7Max	7.2Max	3.4±0.5	7.5±0.5	5.4±0.3	3.6±0.3	6.5±0.3	1.0Φ±0.1	5.9	4.1	1.5
DMI1007A-R18M-NA	2	10.7Max	7.2Max	3.4±0.5	7.0±0.5	5.4±0.3	3.6±0.3	6.5±0.3	1.1Φ±0.1	5.9	4.1	1.6
DMI1007-R36M-NA	2	10.7Max	7.2Max	3.4±0.5	6.6±0.5	5.4±0.3	3.6±0.3	6.5±0.3	1.1Φ±0.1	5.9	4.1	1.6
DMI1007-R60M-NA	2	10.7Max	7.2Max	3.4±0.5	7.5±0.5	5.4±0.3	3.6±0.3	6.5±0.3	1.0Φ±0.1	5.9	4.1	1.5
DMI1007A-R60M-NA	2	10.7Max	7.2Max	3.4±0.5	7.5±0.5	5.4±0.3	3.6±0.3	6.5±0.3	1.1Φ±0.1	5.9	4.1	1.6
DMI1008-R47M-N	2	10±0.5	10±0.5	3.4±0.5	8.0Max	5.6±0.5	5.6±0.5	7.9±0.5	1.2Φ±0.1	6.1	6.1	1.7
DMI1008-R56M-N	2	10±0.5	10±0.5	3.4±0.5	8.0Max	5.6±0.5	5.6±0.5	7.9±0.5	1.2Φ±0.1	6.1	6.1	1.7
DMI1008-R68M-N	2	10±0.5	10±0.5	3.4±0.5	8.0Max	5.6±0.5	5.6±0.5	7.9±0.5	1.2Φ±0.1	6.1	6.1	1.7
DMI1008-R82M-N	2	10±0.5	10±0.5	3.4±0.5	8.0Max	5.6±0.5	5.6±0.5	7.9±0.5	1.2Φ±0.1	6.1	6.1	1.7
DMI1008-1R0M-N	2	10±0.5	10±0.5	3.4±0.5	8.0Max	5.6±0.5	5.6±0.5	7.9±0.5	1.2Φ±0.1	6.1	6.1	1.7
DMI1008-1R2M-N	2	10±0.5	10±0.5	3.4±0.5	8.0Max	5.6±0.5	5.6±0.5	7.9±0.5	1.2Φ±0.1	6.1	6.1	1.7
DMI1009-R22M-N	2	10±0.5	10±0.5	3.4±0.5	9.8Max	5.6±0.5	5.6±0.5	7.9±0.5	1.2Φ±0.1	6.1	6.1	1.7
DMI1009-R68M-N	2	10.5Max	10.5Max	3.4±0.5	9.8Max	5.6±0.5	5.6±0.5	7.9±0.5	1.4ø±0.1	6.1	6.1	1.9
DMI1009-R80M-N	2	10.5Max	10.5Max	3.4±0.5	9.8Max	4.5±0.5	6.0±0.5	7.5±0.5	1.2Φ±0.1	5.0	6.5	1.7
DMI1009-R80M-NA	1	10.5±0.5	10.5±0.5	3.4±0.5	9.0±0.5	4.5±0.5	6.0±0.5	7.5±0.5	1.3Φ±0.1	5.0	6.5	1.8
DMI1009-1R0M-N	2	10±0.5	10±0.5	3.4±0.5	9.8Max	5.6±0.5	5.6±0.5	7.9±0.5	1.2Φ±0.1	6.1	6.1	1.7
DMI1009-1R0M-N1	2	10±0.5	10±0.5	3.4±0.5	9.8Max	6.5±0.5	4.5±0.5	7.9±0.5	1.2Φ±0.1	7.0	5.0	1.7
DMI1009-1R2M-N	2	10.5Max	10.5Max	3.4±0.5	9.8Max	5.6±0.5	5.6±0.5	7.9±0.5	1.3ø±0.1	6.1	6.1	1.8
DMI10507-R15M-NA	3	10.3±0.3	5.3±0.3	3.3±0.5	7.5±0.45	-	-	6.1±0.3	1.1Φ±0.1	-	-	1.6
DMI10507-R30M-NA	3	10.3±0.3	5.3±0.3	3.3±0.5	7.5±0.45	-	-	6.1±0.3	1.1Φ±0.1	-	-	1.6
DMI10507-R60M-NA	3	10.3±0.3	5.3±0.3	3.3±0.5	7.5±0.45	-	-	6.1±0.3	0.8Φ±0.1	-	-	1.3
DMI10709-1R0M-N	2	10±0.5	7.0±0.5	3.4±0.5	9.8Max	3.6±0.5	6.2±0.5	7.2±0.5	0.9Φ±0.1	4.1	6.7	1.4

Leaded Power Chokes DMI Series

Dimensions in mm

TYPE	FIG	A	B	C	D	E	F	G	H	a	b	c
DMI10709-R47M-N	2	10±0.5	7.0±0.5	3.4±0.5	9.8Max	3.6±0.5	6.2±0.5	7.2±0.5	1.0Φ±0.1	4.1	6.7	1.5
DMI10709-R56M-N	2	10±0.5	7.0±0.5	3.4±0.5	9.8Max	3.6±0.5	6.2±0.5	7.2±0.5	1.0Φ±0.1	4.1	6.7	1.5
DMI10709-R68M-N	2	10±0.5	7.0±0.5	3.4±0.5	9.8Max	3.6±0.5	6.2±0.5	7.2±0.5	1.0Φ±0.1	4.1	6.7	1.5
DMI10709-R82M-N	2	10±0.5	7.0±0.5	3.4±0.5	9.8Max	3.6±0.5	6.2±0.5	7.2±0.5	1.0Φ±0.1	4.1	6.7	1.5
DMI1107-R36M-N	1	11.5±0.5	11.5±0.5	3.5±0.5	7.4±0.2	5.7±0.5	6.3±0.5	8.5±0.5	1.5Φ±0.1	6.2	6.8	2
DMI1107-R47M-N	1	11.5±0.5	11.5±0.5	3.4±0.5	7.5±0.5	6.7±0.5	5.6±0.5	8.73±0.5	1.5Φ±0.1	7.2	6.1	2
DMI1108-R30M-N	1	11.5Max	9.5Max	3.4±0.5	8.5Max	6.6±0.5	4.2±0.5	7.8±0.5	1.5ø±0.1	7.1	4.7	2
DMI1108-R36M-N	1	11.7Max	9.7Max	3.5±0.5	8.8Max	6.6±0.5	4.2±0.5	7.8±0.5	1.4ø±0.1	7.1	4.7	1.9
DMI1108-R60M-N	1	11.7Max	11.7Max	3.5±0.5	8.5Max	6.3±0.5	5.7±0.5	8.5±0.5	1.5ø±0.1	6.8	6.2	2
DMI1108-1R8M-N	1	11.7Max	11.7Max	3.5±0.5	8.5Max	6.6±0.5	6.6±0.5	9.3±0.5	1.2ø±0.1	7.1	7.1	1.7
DMI1109-1R0M-N	2	11.8Max	11.8Max	3.4±0.5	9.8Max	6.0±0.5	6.7±0.5	9.0±0.5	1.5Φ±0.1	6.5	7.2	2
DMI1109-1R2M-N	2	11.5Max	11.5Max	3.4±0.5	9.8Max	6.7±0.5	6.0±0.5	9 ^{+0.3} _{-0.5}	1.5ø±0.1	7.2	6.5	2
DMI1109-1R5M-N	1	11.5±0.5	11.5±0.5	3.4±0.5	9.5±0.5	7.3±0.5	7.3±0.5	10.3±0.5	1.4ø±0.1	7.8	7.8	1.9
DMI1109-R30M-N	1	11.5±0.5	11.5±0.5	3.4±0.5	9.5±0.5	7.3±0.5	6.0±0.5	9.4±0.5	1.4ø±0.1	7.8	6.5	1.9
DMI1109-R56M-N	1	11.7Max	9.7Max	3.5±0.5	9.5Max	6.6±0.5	4.2±0.5	7.8±0.5	1.3ø±0.1	7.1	4.7	1.8
DMI1109-R60M-N	2	11.8Max	11.8Max	3.4±0.5	9.8Max	6.0±0.5	6.7±0.5	9.0±0.5	1.5Φ±0.1	6.5	7.2	2
DMI1109-R68M-N	2	11.8Max	11.8Max	3.4±0.5	9.8Max	6.7±0.5	6.0±0.5	9 ^{+0.3} _{-0.5}	1.5ø±0.1	7.2	6.5	2
DMI1110-R60M-N	1	11.6Max	11.6Max	3.4±0.5	10Max	7.3±0.5	6.0±0.5	9.4±0.3	1.4ø±0.1	7.8	6.5	1.9
DMI1110-1R1M-N	1	11.6Max	11.6Max	3.2±0.5	10Max	6.7±0.5	6.0±0.5	9.0±0.5	1.4ø±0.1	7.2	6.5	1.9
DMI1208-R22M-N	2	12Max	12Max	3.4±0.5	8.0Max	7.3±0.5	6.0±0.5	9.4±0.5	1.4ø±0.1	7.8	6.5	1.9
DMI1208-R36M-N	1	11.5±0.5	11.5±0.5	3.5±0.5	7.4±0.2	5.7±0.5	6.3±0.5	8.5±0.5	1.5ø±0.1	6.2	6.8	2
DMI1208-R47M-N	2	12Max	12Max	3.4±0.5	8.0Max	7.3±0.5	6.0±0.5	9.4±0.5	1.4ø±0.1	7.8	6.5	1.9
DMI1208-R56M-N	2	12Max	12Max	3.4±0.5	8.0Max	7.3±0.5	6.0±0.5	9.4±0.5	1.4ø±0.1	7.8	6.5	1.9
DMI1209-R33M-N	2	12Max	12Max	3.4±0.5	9.0Max	7.3±0.5	6.0±0.5	9.4±0.5	1.4ø±0.1	7.8	6.5	1.9
DMI1209-R47M-N	2	12Max	12Max	3.4±0.5	9.0Max	7.3±0.5	6.0±0.5	9.4±0.5	1.4ø±0.1	7.8	6.5	1.9
DMI1209-R68M-N	2	12Max	12Max	3.4±0.5	9.0Max	7.3±0.5	6.0±0.5	9.4±0.5	1.4ø±0.1	7.8	6.5	1.9
DMI1209-1R0M-N	2	12Max	12Max	3.4±0.5	9.0Max	7.3±0.5	6.0±0.5	9.4±0.5	1.5ø±0.1	7.8	6.5	2
DMI1209-2R5M-N	1	12Max	12Max	3.4±0.5	9.0Max	6.6±0.5	6.6±0.5	9.3±0.5	1.2ø±0.1	7.1	7.1	1.7
DMI1210-100M-N	2	12.0±0.5	12.0±0.5	3.4±0.5	10.0Max	7.0±0.5	7.0±0.5	10.0±0.3	1.0Φ±0.1	7.5	7.5	2
DMI1210-1R2M-N58	2	11.8Max	11.8Max	3.4±0.5	9.8Max	6.0±0.5	6.7±0.5	9.0±0.5	1.5Φ±0.1	6.5	7.2	2
DMI1210-1R8M-N	2	12Max	12Max	3.4±0.5	10.5Max	6.0±0.5	6.0±0.5	8.5±0.5	1.1ø±0.1	6.5	6.5	1.6
DMI1210-4R7M-N	1	12Max	12Max	3.4±0.5	12Max	7.0±0.5	7.0±0.5	10±0.5	1.1ø±0.1	7.5	7.5	1.6
DMI1210-R30M-N	1	12Max	12Max	3.4±0.5	10Max	7.3±0.5	6.0±0.5	9.4±0.5	1.4ø±0.1	7.8	6.5	1.9
DMI1210-R36M-N63	2	11.8Max	11.8Max	3.4±0.5	9.8Max	6.0±0.5	6.7±0.5	9.0±0.5	1.5Φ±0.1	6.5	7.2	2
DMI1210-R47M-N	1	12Max	12Max	3.4±0.5	10Max	7.3±0.5	6.0±0.5	9.4±0.5	1.4ø±0.1	7.8	6.5	1.9
DMI1210-R68M-N61	2	11.8Max	11.8Max	3.4±0.5	9.8Max	6.0±0.5	6.7±0.5	9.0±0.5	1.5Φ±0.1	6.5	7.2	2
DMI1213-1R0M-N1	2	13.0±0.5	12.0±0.5	3.4±0.5	10.0Max	7.6±0.5	6.6±0.5	10.0±0.5	1.5Φ±0.2	8.1	7.1	2

Electrical Characteristics

Part Number	Inductance (μ H)	Tolerance (\pm %)	Test Frequency (KHz)	RDC (m Ω) Max	Isat (A) Typ.	Irms (A) Typ.
DMI0808-R30M-N	0.30	20	100/ 1V	1.0	35	32
DMI0808-1R0M-N	1.00	20	100/ 1V	4.0	12	16
DMI0809-R56M-N	0.56	20	100/ 1V	1.3	25	25
DMI0809-1R0M-N	1.00	20	100/ 1V	1.8	23	35
DMI0809-2R2M-N	2.20	20	100/ 1V	3.5	13	17
DMI0909-R25M-N	0.25	20	100/ 1V	0.8	28	35
DMI1007-R18M-NA	0.18	20	100/ 1V	0.59	45	40
DMI1007A-R18M-NA	0.18	20	100/ 1V	0.65	45	45
DMI1009-R80M-NA	0.80	20	100/ 1V	1.1	30	30
DMI10507-R15M-NA	0.15	20	100/ 1V	0.52	40	42
DMI10507-R30M-NA	0.30	20	100/ 1V	0.82	30	43
DMI10507-R60M-NA	0.60	20	100/ 1V	2.05	22	30
DMI1108-R30M-N	0.30	20	100/ 1V	1.0	50	38
DMI1108-R36M-N	0.36	20	100/ 1V	0.7	50	43
DMI1108-1R8M-N	1.80	20	100/ 1V	3.0	24	24
DMI1109-R56M-N	0.56	20	100/ 1V	1.08	50	37
DMI1109-R68M-N	0.68	20	100/ 1V	1.2	40	35
DMI1110-R60M-N	0.60	20	100/ 1V	1.2	40	42
DMI1110-1R1M-N	1.10	20	100/ 1V	1.5	35	28
DMI1208-R22M-N	0.22	20	100/ 1V	0.6	75	38
DMI1208-R47M-N	0.47	20	100/ 1V	0.9	55	38
DMI1208-R56M-N	0.56	20	100/ 1V	0.9	45	38
DMI1209-R33M-N	0.33	20	100/ 1V	0.9	70	35
DMI1209-R47M-N	0.47	20	100/ 1V	0.9	50	38
DMI1209-R68M-N	0.68	20	100/ 1V	1.2	45	35
DMI1209-1R0M-N	1.00	20	100/ 1V	1.5	35	35
DMI1209-2R5M-N	2.50	20	100/ 1V	2.6	25	27
DMI1210-R47M-N	0.47	20	100/ 1V	1.0	50	30
DMI1210-1R8M-N	1.80	20	100/ 1V	3.3	29	22
DMI1210-4R7M-N	4.70	20	100/ 1V	6.0	12	17

Note: When ordering, please specify tolerance code. Tolerance: M= \pm 20%

- Customized Specifications are welcome
- Isat for Inductance drop 20% from its value with current
- Irms for a 40°C temperature rise from 25°C ambient with current
- Measure Equipment :
L : WK4237
RDC : CHEN HWA502
Isat & Irms : WK3260B/ 3265

Electrical Characteristics

Part Number	Inductance (μ H)	Tolerance (\pm %)	Test Frequency (KHz)	RDC (m Ω) Max	Isat (A) Typ.	Irms (A) Typ.
DMI0809-R50M-NA	0.50	20	100/ 1V	1.32	30	30
DMI0810-1R0M-NA	1.00	20	100/ 1V	2.25	25	25
DMI1007-R36M-NA	0.36	20	100/ 1V	0.89	30	30
DMI1007-R60M-NA	0.60	20	100/ 1V	1.39	25	25
DMI1007A-R60M-NA	0.60	20	100/ 1V	1.51	25	25

Note: When ordering, please specify tolerance code. Tolerance: M= \pm 20%

- Customized Specifications are welcome
- Isat for Inductance drop 25% from its value with current
- Irms for a 40°C temperature rise from 25°C ambient with current
- Measure Equipment :
L : WK4237
RDC : CHEN HWA502
Isat & Irms : WK3260B/ 3265

Electrical Characteristics

Part Number	Inductance (μ H)	Tolerance (\pm %)	Test Frequency (KHz)	RDC (m Ω) Max	Isat (A) Typ.	Irms (A) Typ.
DMI0707-R40M-N	0.4	20	100/ 1V	1.60	27	16
DMI0805-R40M-N	0.4	20	100/ 1V	1.45	31	25
DMI0806-R47M-N	0.47	20	100/ 1V	1.50	22 Max	22 Max
DMI0807-1R0M-N	1.0	20	100/ 1V	4.00	28	15
DMI0809-R20M-N64	0.2	20	100/ 1V	0.80	30 Max	25 Max
DMI0809-R20M-NA	0.2	20	100/ 1V	0.80	40	30 Max
DMI0809-R56M-N18	0.56	20	100/ 1V	1.30	23 Max	20 Max
DMI0809-2R2M-N1	2.2	20	100/ 1V	4.50	17	16 Max
DMI0909-1R2M-N	1.2	20	100/ 1V	3.00	20 Max	20 Max
DMI1008-R47M-N	0.47	20	100/ 1V	1.05	48	20
DMI1008-R56M-N	0.56	20	100/ 1V	1.25	43	35
DMI1008-R68M-N	0.68	20	100/ 1V	1.35	35	28
DMI1008-R82M-N	0.82	20	100/ 1V	1.50	38	28
DMI1008-1R0M-N	1.0	20	100/ 1V	1.6	33	25
DMI1008-1R2M-N	1.2	20	100/ 1V	1.65	36	28
DMI1009-R22M-N	0.22	20	100/ 1V	0.7	41 Max	25 Max
DMI1009-R68M-N	0.68	20	100/ 1V	1.2	49	30
DMI1009-R80M-N	0.8	20	100/ 1V	1.2	25 Max	30 Max
DMI1009-1R0M-N	1.0	20	100/ 1V	1.65	22 Max	24 Max
DMI1009-1R0M-N1	1.0	20	100/ 1V	1.65	22 Max	24 Max
DMI1009-1R2M-N	1.2	20	100/ 1V	1.7	33	28
DMI1107-R36M-N	0.36	20	100/ 1V	0.8	60 Max	45 Max
DMI1107-R47M-N	0.47	20	100/ 1V	1.0	40	32
DMI1108-R60M-N	0.6	20	100/ 1V	1.0	40	35

Note: When ordering, please specify tolerance code. Tolerance: M= \pm 20%

- Customized Specifications are welcome
- Isat for Inductance drop 25% from its value with current
- Irms for a 40°C temperature rise from 25°C ambient with current
- Measure Equipment :
L : WK4237
RDC : CHEN HWA502
Isat & Irms : WK3260B/ 3265

Electrical Characteristics

Part Number	Inductance (μ H)	Tolerance (\pm %)	Test Frequency (KHz)	RDC (m Ω) Max	Isat (A) Typ.	Irms (A) Typ.
DMI1109-R30M-N	0.3	20	100/ 1V	0.7	46	40
DMI1109-R60M-N	0.6	20	100/ 1V	0.93	31 Max	40 Max
DMI1109-1R0M-N	1.0	20	100/ 1V	1.37	31 Max	25 Max
DMI1109-1R2M-N	1.2	20	100/ 1V	1.2	40	30
DMI1109-1R5M-N	1.5	20	100/ 1V	1.85	42	28
DMI1208-R36M-N	0.36	20	100/ 1V	0.8	60	40
DMI1209-R68M-N	0.68	20	100/ 1V	1.2	45	35
DMI1210-R30M-N	0.3	20	100/ 1V	0.65	45	40
DMI1210-R36M-N63	0.36	20	100/ 1V	0.8	38 Max	30 Max
DMI1210-R68M-N61	0.68	20	100/ 1V	1.2	40 Max	35 Max
DMI1210-1R2M-N58	1.2	20	100/ 1V	1.2	38 Max	30 Max
DMI1210-4R7M-N	4.7	20	200/ 0.1V	6	16	15
DMI1210-100M-N	10	20	200/ 0.1V	9.3	8	8
DMI1213-1R0M-N1	1.0	20	200/ 0.1V	1.3	40	30
DMI10709-R47M-N	0.47	20	100/ 1V	1.3	37	25
DMI10709-R56M-N	0.56	20	100/ 1V	1.6	33	15
DMI10709-R68M-N	0.68	20	100/ 1V	1.9	28	30
DMI10709-R82M-N	0.82	20	100/ 1V	2.2	26	15
DMI10709-1R0M-N	1.0	20	100/ 1V	2.9	22	18
DMI10709-1R2M-N	1.2	20	100/ 1V	3.3	20	16

Note: When ordering, please specify tolerance code. Tolerance: M= \pm 20%

- Customized Specifications are welcome
- Isat for Inductance drop 30% from its value with current
- I rms for a 40°C temperature rise from 25°C ambient with current
- Measure Equipment :
 L : WK4237
 RDC : CHEN HWA502
 Isat & I rms : WK3260B/ 3265

DMI Series



DMI series is designed with low RDC and ultra large current. Its molded magnetic shielded type is suitable for high-density mounting and ultra low buzz noise. Soldering conditions can be easily confirmed when mounting onto the board. This series also provides customers with embossed carrier type packaging for automatic mounting machine.

Features

- Shielded type
- Low RDC
- High saturation current
- High rated current
- AEC-Q200 qualified

Applications

- DC/DC converters
- Engine and transmission control units
- Noise suppression for motors
 - Windshield wipers
 - Power seats
 - Heating and ventilation blowers
 - HID lighting
- LED drivers

Product Identification

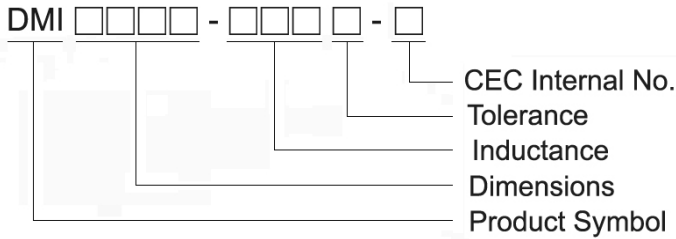

Shapes and Dimensions

FIG 4

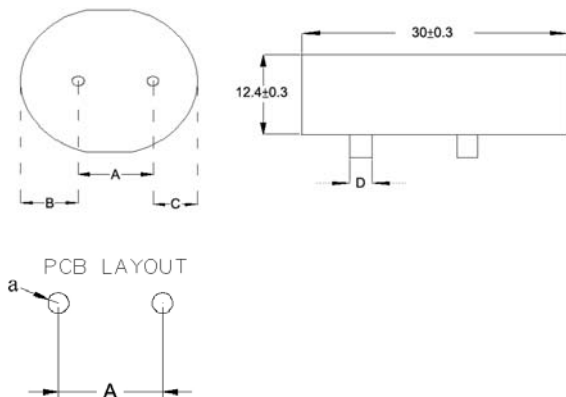

Dimensions in mm

TYPE	FIG	A	B	C	D	a
DMI3012-1R0M-N	4	15±0.5	8.8±0.5	6.2±0.5	2.5±0.1	2.9
DMI3012-2R2M-N	4	15±0.5	8.8±0.5	6.2±0.5	2.5±0.1	2.9
DMI3012-3R3M-N	4	15±0.5	7.5±0.5	7.5±0.5	2.0±0.1	2.4
DMI3012-4R7M-N	4	15±0.5	8.8±0.5	6.2±0.5	2.3±0.1	2.7
DMI3012-6R8M-N	4	15±0.5	8.8±0.5	6.2±0.5	2.3±0.1	2.7
DMI3012-8R2M-N	4	15±0.5	9.5±0.5	5.5±0.5	2.0±0.1	2.4
DMI3012-100M-N	4	15±0.5	9.5±0.5	5.5±0.5	1.8±0.1	2.2
DMI3012-150M-N	4	15±0.5	9.5±0.5	5.5±0.5	1.8±0.1	2.2
DMI3012-220M-N	4	15±0.5	9.25±0.5	5.75±0.5	1.6±0.1	2.0
DMI3012-330M-N	4	15±0.5	9.6±0.5	5.4±0.5	1.3±0.1	1.7
DMI3012-470M-N	4	15±0.5	9.6±0.5	5.4±0.5	1.3±0.1	1.7
DMI3012-680M-N	4	15±0.5	9.3±0.5	5.7±0.5	1.1±0.1	1.5
DMI3012-101M-N	4	15±0.5	9.3±0.5	5.7±0.5	1.1±0.1	1.5
DMI3012-121M-N	4	15±0.5	9.3±0.5	5.7±0.5	1.1±0.1	1.5

Electrical Characteristics

Part Number	Inductance (μ H)	Tolerance (\pm %)	Test Frequency (KHz)	RDC(m Ω) Typ. (Max)	Isat (A) Typ.	Irms (A) Typ.
DMI3012-1R0M-N	1.00	20	100/ 1V	0.39(0.50)	65	90
DMI3012-2R2M-N	2.20	20	100/ 1V	0.71(0.77)	65	72
DMI3012-3R3M-N	3.30	20	100/ 1V	1.31(1.50)	62	60
DMI3012-4R7M-N	4.70	20	100/ 1V	1.30(1.43)	53	54
DMI3012-6R8M-N	6.80	20	100/ 1V	1.81(1.97)	44	46
DMI3012-8R2M-N	8.20	20	100/ 1V	2.56(3.00)	34	36
DMI3012-100M-N	10	20	100/ 1V	3.20(3.64)	32	34
DMI3012-150M-N	15	20	100/ 1V	4.25(4.76)	28	28
DMI3012-220M-N	22	20	100/ 1V	6.40(6.83)	23	23
DMI3012-330M-N	33	20	100/ 1V	10.6(11.3)	18	18
DMI3012-470M-N	47	20	100/ 1V	13.5(14.6)	16.2	16
DMI3012-680M-N	68	20	100/ 1V	25.5(27.4)	11	12
DMI3012-101M-N	100	20	100/ 1V	29.5(32.2)	9	11
DMI3012-121M-N	120	20	100/ 1V	34.2(36.5)	8	9

Note: When ordering, please specify tolerance code. Tolerance: M= \pm 20%

- Customized Specifications are welcome
- Isat for Inductance drop 20% from its value with current
- Irms for a 40°C temperature rise from 25°C ambient with current
- Measure Equipment :

L : WK4237

RDC : CHEN HWA502

Isat & Irms : WK3260B/ 3265

Packaging

PLATE DIMENSIONS

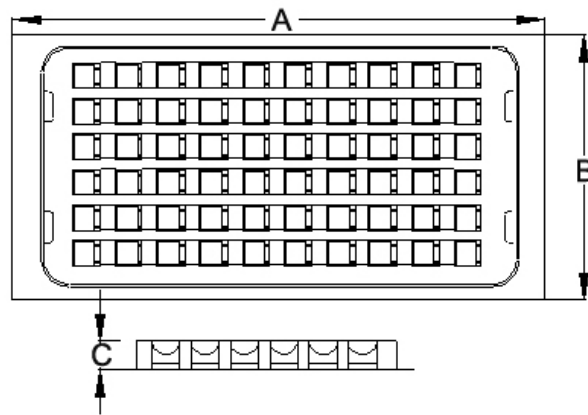

PACKAGING QUANTITY

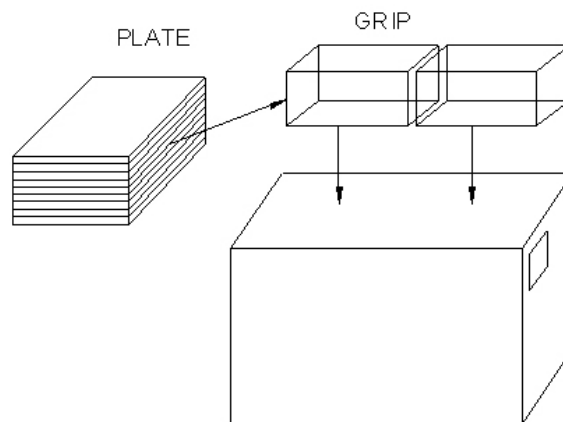

Dimensions in mm

TYPE	PLATE DIMENSIONS			QUANTITY				
	A	B	C	BULK	PLATE	PLATE/GRIP	GRIP	BOX
DMI0707	250	220	10	✓	100	10	2	2000
DMI0805	252	140	11	✓	140	9	2	2520
DMI0806	252	14	11	✓	140	9	2	2520
DMI0807	250	220	10	✓	100	10	2	2000
DMI0808	250	220	10	✓	100	10	2	2000
DMI0809	250	220	10	✓	100	10	2	2000
DMI0909	250	220	13.5	✓	100	8	2	1600
DMI1007	230	125	14.5	✓	60	12	2	1440
DMI1008	250	220	13.5	✓	100	8	8	1600
DMI1009	251	138	13.0	✓	60	8	2	960
DMI10507	240	135	11.5	✓	60	15	2	1800
DMI10709	250	220	13.5	✓	100	8	2	1600
DMI1107	250	220	13.5	✓	100	8	2	1600
DMI1108	250	220	13.5	✓	100	8	2	1600
DMI1109	250	220	13.5	✓	100	8	2	1600
DMI1110	250	220	13.5	✓	100	8	2	1600
DMI1208	250	220	13.5	✓	100	8	2	1600
DMI1209	250	220	13.5	✓	100	8	2	1600
DMI1210	250	220	13.5	✓	100	8	2	1600
DMI1213	250	220	12	✓	50	8	2	800
DMI3012	250	220	24	✓	25	5	2	250

CPUD Series



CPUD series is designed for low RDC and ultra large current application. Its assembly model magnetic shielded type is suitable for high-density mounting and ultra low buzz noise. Soldering conditions can be easily confirmed when mounting onto the board.

Features

- Excellent for power line DC-DC conversion applications
- Shielded construction
- Low DCR/ uH, in this package series
- Handle high transient current spikes without saturation
- Ultra low buzz noise, due to composite construction

Applications

- Excellent for power line DC-DC conversion applications used in power switching, personal computers and other handheld electronic equipment

Product Identification

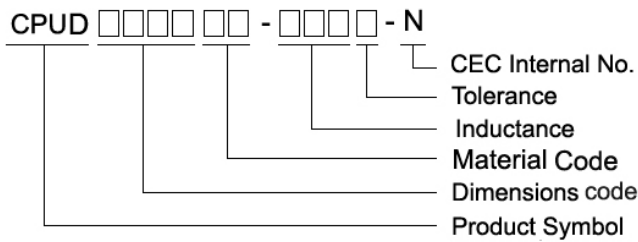

Shapes and Dimensions

FIG 1

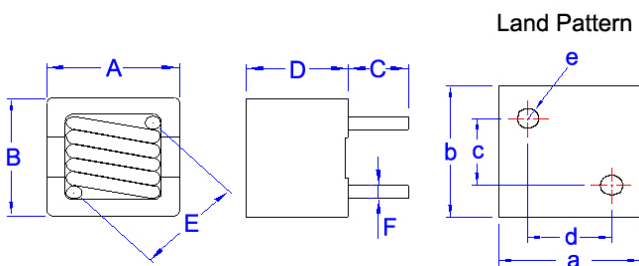
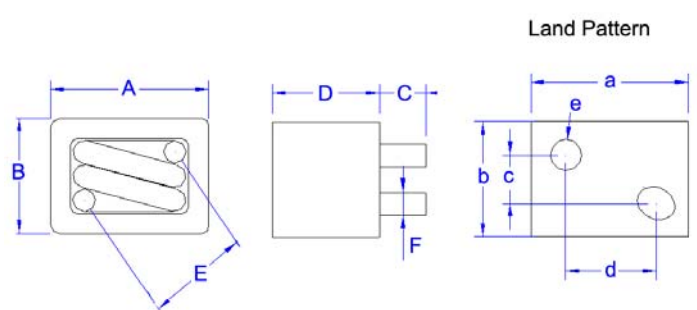

FIG 2



Dimensions in mm

TYPE	FIG	A	B	C	D	E	F	a	b	c	d	e
CPUD0806MN	1	8.2 ⁺⁰	8.2 ⁺⁰	3.5±0.5	7.5 ⁺⁰	6.5±0.5	0.8±0.1	9.0	9.0	4.3±0.5	4.9±0.5	2
CPUD1108IR	2	11.7 ⁺⁰	9.7 ⁺⁰	3.5±0.5	8.5 ⁺⁰	7.8±0.5	1.4±0.1	12.0	10.0	4.2±0.5	6.6±0.5	2
CPUD1310IR	2	13.5 ⁺⁰	12.5 ⁺⁰	3.5±0.5	10 ⁺⁰	10.5±0.5	1.0±0.1	14.2	13.2	7.0±0.5	7.8±0.5	2

Electrical Characteristics

Part Number	Inductance (μ H)	Tolerance (\pm %)	Test Frequency (kHz)	RDC (m Ω) \pm 8%	Isat (A) Max	Irms (A) Max	Marking
CPUD0806MN-R60M-N	0.6	20	100	2.1	24	20	R60
CPUD0806MN-1R0M-N	1.0	20	100	3.0	15	18	1R0
CPUD0806MN-1R5M-N	1.5	20	100	4.5	11	13	1R5
CPUD0806MN-2R2M-N	2.2	20	100	4.5	8	13	2R2
CPUD0806MN-3R3M-N	3.3	20	100	6.8	7	11	3R3
CPUD0806MN-4R7M-N	4.7	20	100	12.0	5	7	4R7
CPUD1108IR-R30M-N	0.30	20	100	0.65	50	43	R30
CPUD1108IR-R56M-N	0.56	20	100	1.00	42	35	R56
CPUD1108IR-1R0M-N	1.0	20	100	2.00	50	28	1R0
CPUD1108IR-1R5M-N	1.5	20	100	3.65	30	20	1R5
CPUD1108IR-2R0M-N	2.0	20	100	5.20	27	15	2R0
CPUD1310IR-1R0M-N	1.0	20	100	1.15	42	32	1R0
CPUD1310IR-1R5M-N	1.5	20	100	1.85	42	26	1R5
CPUD1310IR-2R0M-N	2.0	20	100	3.50	35	21	2R0
CPUD1310IR-3R3M-N	3.3	20	100	5.00	22	17	3R3
CPUD1310IR-4R7M-N	4.7	20	100	8.60	17	12	4R7

Note: When ordering, please specify tolerance code. Tolerance: M= \pm 20%

- Customized Specifications are welcome
- Isat for Inductance drop 20% from its value with current
- Irms for a 40 $^{\circ}$ C temperature rise from 25 $^{\circ}$ C ambient with current
- Measure Equipment :
L : WK4237
RDC : CHEN HWA502
Isat & Irms : WK3260B/ 3265

Packaging

PLATE DIMENSIONS

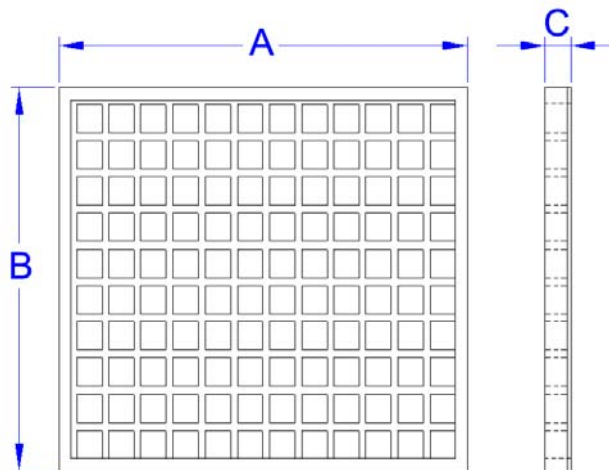

PACKAGING QUANTITY

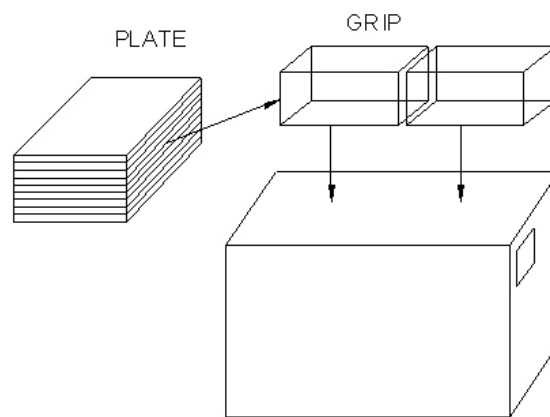

Dimensions in mm

TYPE	PLATE DIMENSIONS			QUANTITY				
	A	B	C	BULK	PLATE	PLATE/GRIP	GRIP	BOX
CPUD0806MN	255	210	14	✓	200	10	2	4000
CPUD1108IR	230	150	12	✓	120	10	2	2400
CPUD1310IR	230	150	15	✓	100	10	2	2000

Certificate

CERTIFICATE
 Number: 2034245-2
 The management system of
Chilisin Electronics Corp.
 No. 29, Lane 301, Tehching Rd.
 Hsinchu Village, Hsinchu Hsiang
 303 Hsinchu Hsien
 Taiwan

Including the implementation meets the requirements of the standard
ISO 9001:2008

Scope
 Design, manufacture, sales and distribution of inductors, RF components, sensors, protection devices and magnetic components.

Certificate expiry date: 11 August 2014
 Certified for the first time: 1 April 2009
 Certificate effective date: 8 August 2011

DEKRA Certification B.V.
 Dr. G.J. Zeebroek
 Managing Director
 Mr. H.J. Beilman
 Certification Manager

© Integral publication of this certificate and adjoining reports is allowed.

At testing, inspection, auditing and certification activities of the former KEMA Quality are an integral part of the DEKRA Certification Group.

DEKRA Certification B.V. | Dierikweg 111 | 6812 JH Arnhem | P.O. Box 5190 | 6803 SD Arnhem, The Netherlands
 T +31 (0) 265 2000 - F +31 (0) 265 2002 | www.dekra-certification.com | Company registration: 0806204

BUREAU VERITAS
 Certification

Certification
 Awarded to
CHILISIN ELECTRONICS CORP.
 奇力新電子股份有限公司

NO. 29, LANE 301, TEHCHING ROAD, HSIANG HSIANG, HSIANGCHU, TAIWAN, R.O.C.
 新竹縣竹東鎮奇力新街301號 29號
 中華民國 - 台灣

Bureau Veritas Certification certifies that the Management System of the above organization has been audited and found to be in accordance with the requirements of the management system standards detailed below

Standards
ISO 14001:2004

Scope of supply
 DESIGN, MANUFACTURE, SALES AND DISTRIBUTION OF INDUCTORS, FILTERS, RF COMPONENTS, SENSORS, PROTECTION DEVICES AND MAGNETIC COMPONENTS
 電感、濾波器、射頻元件、感測器、保護元件、磁波元件之設計、製造與銷售。

Original Approval Date: 14 December 2004

Subject to the continued satisfactory operation of the organization's Management System, this certificate is valid until 11 Dec. 2013
 To check this certificate validity please call +886 2 2370 7855
 Further conditions regarding the scope of this certificate and the applicability of the management system requirements may be obtained by consulting the organization.

Date: 27 Apr. 2010
 Certificate Number: TW10416E

DEKRA Certification B.V. | Dierikweg 111 | 6812 JH Arnhem | P.O. Box 5190 | 6803 SD Arnhem, The Netherlands
 T +31 (0) 265 2000 - F +31 (0) 265 2002 | www.dekra-certification.com | Company registration: 0806204

CERTIFICATE
ISO/TS 16949:2009

DEKRA
 Certification

herby certifies that the company
Chilisin Electronics Corp.

Location
 No. 29, Lane 301, Tehching Rd. Hsinchu Village, Hsiang-Hsiang * ROC-303 Hsinchu Hsien
 Business field:
 Design, manufacture of inductors, RF components, sensors, protection devices and magnetic components for automotive applications

has implemented a quality management system and applies it effect vely. Audit no took place in agreement with the requirements of ISO/TS 16949:2009 (2009 06 15). Evidence of conformity was found during the certification audit Report No. 2084115, Was 7.3 Product Development.

Date of the first certification: 12 08 2008
 This certificate is valid from: 08 08 2011
 (last audit day: 21 07 2011)
 This certificate is valid to: 07 08 2014
 Certificate registration no.: 160811082
 IATF number: 0126385

DEKRA Certification GmbH | Heimbachstraße 19 | D-70569 Stuttgart | www.dekra-certification.com

SONY

2011 / 08 / 15

Notification of Green Partner Certification

Attn : Chilisin Electronics Corp.

Thank you for your cooperating Sony Green Partner Audit.
 We will inform you of new certified factories and Green Partner validity expiry date.

認定工場・業 / Green Partner Certified Factories

FC	MC Name(ENG)	FC Name(ENG)	Expiry Date
FC004116	Chilisin Electronics Corp.		2013/08/31
FC011607	Dongguan Chilisin Electronics Co., Ltd.		2013/08/31

Green Partner Secretariat
 Procurement Group
 Sony Corporation

SAMSUNG **Eco-Partner Certificate**

Certificate Number : **69C-6816**
 Certificate Period : **Apr '11 -- Apr '13**

Samsung Electronics hereby certifies that
CHILISIN ELECTRONICS CORP.
 as Eco-Partner Affiliate Company. This company has fulfilled the Samsung Electronics Standards for control of substances with environmental impacts within products, and has established stable environmental quality control system.

Apr.08th , 2011
 Yoon-Woo Lee
 Vice Chairman & C.E.O

Yoon Woo Lee

Samsung Electronics Co., Ltd.

X-ON Electronics

Largest Supplier of Electrical and Electronic Components

Click to view similar products for [Fixed Inductors](#) category:

Click to view products by [Chilisin](#) manufacturer:

Other Similar products are found below :

[MLZ1608M6R8WTD25](#) [MLZ1608N6R8LT000](#) [MLZ1608N3R3LTD25](#) [MLZ1608N3R3LT000](#) [MLZ1608N150LT000](#)

[MLZ1608M150WTD25](#) [MLZ1608M3R3WTD25](#) [MLZ1608M3R3WT000](#) [MLZ1608M150WT000](#) [MLZ1608A1R5WT000](#)

[MLZ1608N1R5LT000](#) [B82432C1333K000](#) [PCMB053T-1R0MS](#) [PCMB053T-1R5MS](#) [PCMB104T-1R5MS](#) [CR32NP-100KC](#) [CR32NP-](#)

[151KC](#) [CR32NP-180KC](#) [CR32NP-181KC](#) [CR32NP-1R5MC](#) [CR32NP-390KC](#) [CR32NP-3R9MC](#) [CR32NP-680KC](#) [CR32NP-820KC](#)

[CR32NP-8R2MC](#) [CR43NP-390KC](#) [CR43NP-560KC](#) [CR43NP-680KC](#) [CR54NP-181KC](#) [CR54NP-470LC](#) [CR54NP-820KC](#) [CR54NP-8R5MC](#)

[MGDQ4-00004-P](#) [MGDU1-00016-P](#) [MHL1ECTTP18NJ](#) [MHL1JCTTD12NJ](#) [PE-51506NL](#) [PE-53601NL](#) [PE-53630NL](#) [PE-53824SNLT](#) [PE-](#)

[62892NL](#) [PE-92100NL](#) [PG0434.801NLT](#) [PG0936.113NLT](#) [PM06-2N7](#) [PM06-39NJ](#) [HC2LP-R47-R](#) [HC2-R47-R](#) [HC3-2R2-R](#) [HC8-1R2-R](#)