

Multilayer Power Inductors



The MPx Series is a miniature type of multilayer power inductor constructed using low-loss ferrite material to support high-speed switching frequencies. The compact size and high efficiency is ideal for DC-DC converter applications in space-limited boards.

Features

- RoHS compliant
- Small size
- Low profile
- High current
- Magnetically shielded configuration allowing for high density mounting

Applications

- DC-DC converters
- Power modules
- Cellular phones
- DSC, PND, DVD
- Wireless card and other electronic devices.

Product Identification

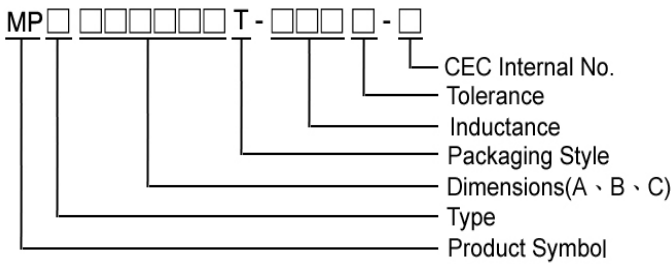

- Product Symbol : MPA, MPB
- Type : A : General , B : Low RDC
- Packaging : T : Tape and Reel , B : Bulk
- Tolerance : M = $\pm 20\%$, T = $\pm 30\%$

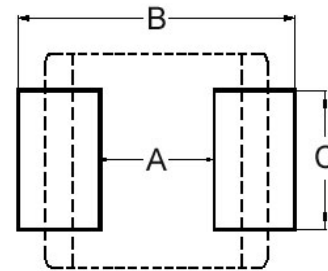
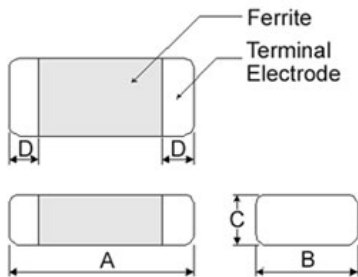

Dimensions in mm

TYPE	A	B	C	D
160808	1.6 \pm 0.15	0.8 \pm 0.15	0.8 \pm 0.15	0.3 \pm 0.2
201205	2.0 \pm 0.20	1.25 \pm 0.20	0.55 Max	0.5 \pm 0.3
201210	2.0 \pm 0.20	1.25 \pm 0.20	1.0 Max	0.5 \pm 0.3
201212	2.0 \pm 0.20	1.25 \pm 0.20	1.25 \pm 0.20	0.5 \pm 0.3
201610	2.0 \pm 0.20	1.6 \pm 0.20	1.0 Max	0.5 \pm 0.3
252010	2.5 \pm 0.20	2.0 \pm 0.20	1.0 Max	0.5 \pm 0.3
252012	2.5 \pm 0.20	2.0 \pm 0.20	1.2 Max	0.5 \pm 0.3

Dimensions in mm

TYPE	A	B	C
160808	0.7 ~ 0.8	1.8 ~ 2.0	0.6 ~ 0.8
201205	0.8 ~ 1.2	2.3 ~ 2.9	1.0 ~ 1.4
201210	0.8 ~ 1.2	2.3 ~ 2.9	1.0 ~ 1.4
201212	0.8 ~ 1.2	2.3 ~ 2.9	1.0 ~ 1.4
201610	0.8 ~ 1.2	2.1 ~ 2.7	1.6 ~ 2.0
252010	1.3 ~ 1.9	2.7 ~ 3.5	2.0 ~ 2.6
252012	1.3 ~ 1.9	2.7 ~ 3.5	2.0 ~ 2.6

Electrical Characteristics

MPA : General Series

Part Number	Inductance (uH)	Test Frequency (MHz)	Tolerance (±%)	RDC (Ω) ±30%	Rated current (mA) Max
MPA201210T-1R0□-N	1.0	1	20, 30	0.18	1100
MPA201210T-1R5□-N	1.5	1	20, 30	0.19	1000
MPA201210T-2R2□-N	2.2	1	20, 30	0.22	900
MPA201210T-3R3□-N	3.3	1	20, 30	0.25	700
MPA201210T-4R7□-N	4.7	1	20, 30	0.35	600

- Tolerance : M = ±20% , T = ±30%
- Packaging: Clear tape and reel {standard}.
- L : Agilent/HP4287A+16197A, 1MHz 200mV
- RDC : HP 4338B, or equivalent
- Rated Current : Applied the current to coils, the temperature rise shall not be more than 40°C
- Operating temperature range from -55°C to 125°C. (Including self - temperature rise)

Test Instruments : HP4287A Inductance / Material Analyzer

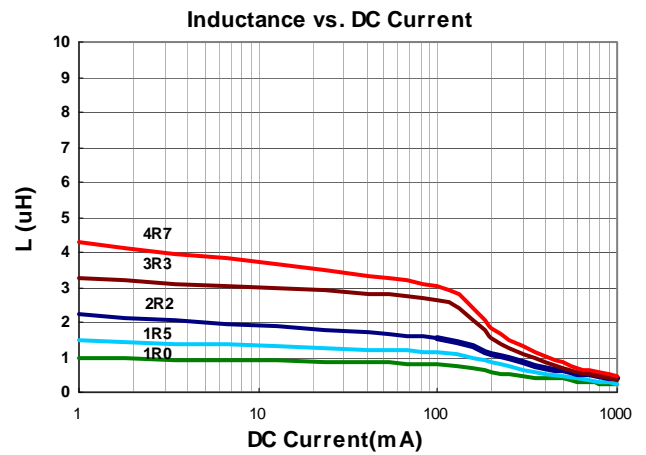
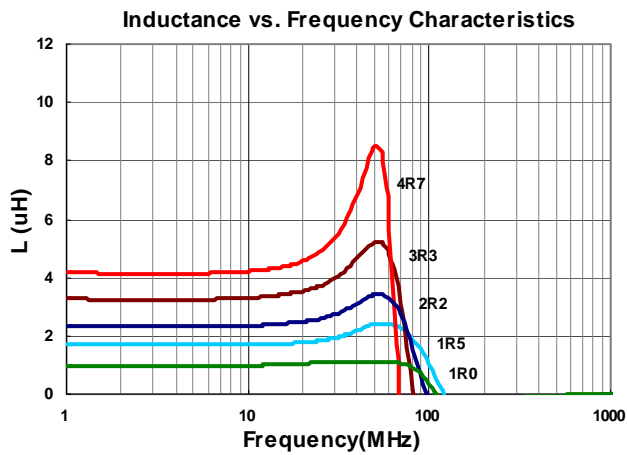

Electrical Characteristics

MPA : General Series

Part Number	Inductance (uH)	Test Frequency (MHz)	Tolerance (±%)	RDC (Ω) ±30%	Rated current (mA) Max
MPA252010T-1R0□-N	1.0	1	20, 30	0.11	1200
MPA252010T-1R5□-N	1.5	1	20, 30	0.13	1100
MPA252010T-2R2□-N	2.2	1	20, 30	0.15	1000
MPA252010T-3R3□-N	3.3	1	20, 30	0.18	1000
MPA252010T-4R7□-N	4.7	1	20, 30	0.25	900

- Tolerance : M = ±20% , T = ±30%
- Packaging: Clear tape and reel {standard}.
- L : Agilent/HP4287A+16197A, 1MHz 200mV
- RDC : HP 4118B, or equivalent
- Rated Current : Applied the current to coils, the temperature rise shall not be more than 40°C
- Operating temperature range from -55°C to 125°C . (Including self - temperature rise)

Test Instruments : HP4287A Inductance / Material Analyzer

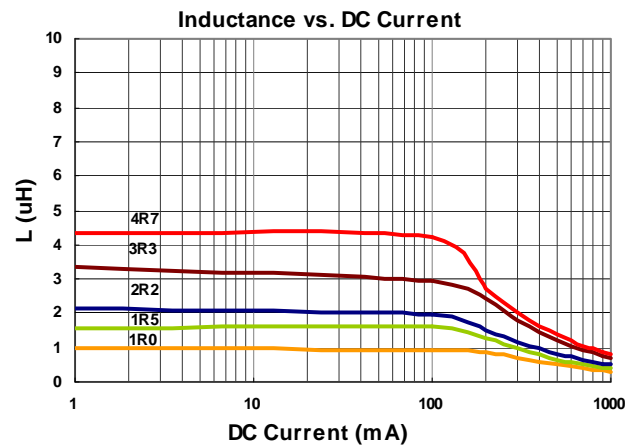
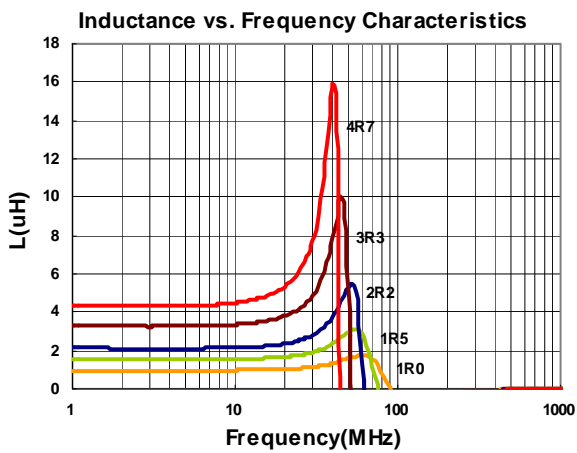

Electrical Characteristics

MPB : Low RDC Series

Part Number	Inductance (uH)	Test Frequency (MHz)	Tolerance (±%)	RDC (Ω) ±30%	Rated current (mA) Max
MPB160808T-R56□-NA2	0.56	3	20, 30	0.23	900
MPB160808T-1R0□-NA2	1.0	3	20, 30	0.28	800
MPB160808T-2R2□-NA2	2.2	3	20, 30	0.40	600

- Tolerance : M = ±20% , T = ±30%
- Packaging: Clear tape and reel {standard}.
- L : Agilent/HP4287A+16197A, 3MHz 200mV
- RDC : HP 4338B, or equivalent
- Rated Current : Applied the current to coils, the temperature rise shall not be more than 40°C
- Operating temperature range from -55°C to 125°C. (Including self - temperature rise)

Test Instruments : HP4287A Inductance / Material Analyzer

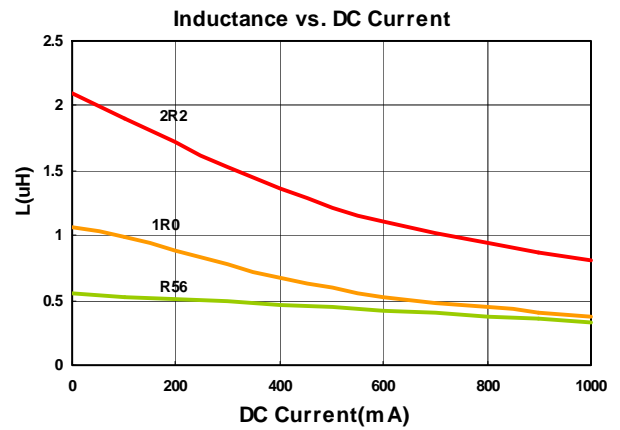
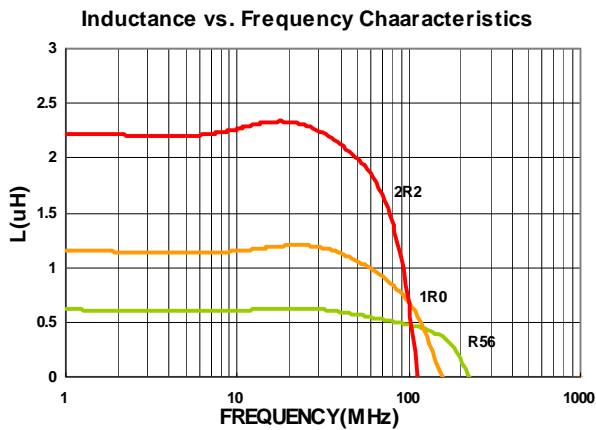

Electrical Characteristics

MPB : Low RDC Series

Part Number	Inductance (uH)	Test Frequency (MHz)	Tolerance (±%)	RDC (Ω) ±30%	Rated current (mA) Max
MPB201205T-R47□-NA2	0.47	3	20, 30	0.11	1200
MPB201205T-1R0□-NA2	1.0	3	20, 30	0.16	900
MPB201205T-1R5□-NA2	1.5	3	20, 30	0.18	800
MPB201206T-2R2□-NA2	2.2	3	20, 30	0.29	600

- Tolerance : M = ±20% ,T = ±30%
- Packaging: Clear tape and reel {standard}
- L : Agilent/HP4287A+16197A, 3MHz 200mV
- RDC : HP 4338B, or equivalent
- Rated Current : Applied the current to coils, the temperature rise shall not be more than 40°C
- Operating temperature range from -55°C to 125°C . (Including self - temperature rise)

Test Instruments : HP4287A Inductance / Material Analyzer

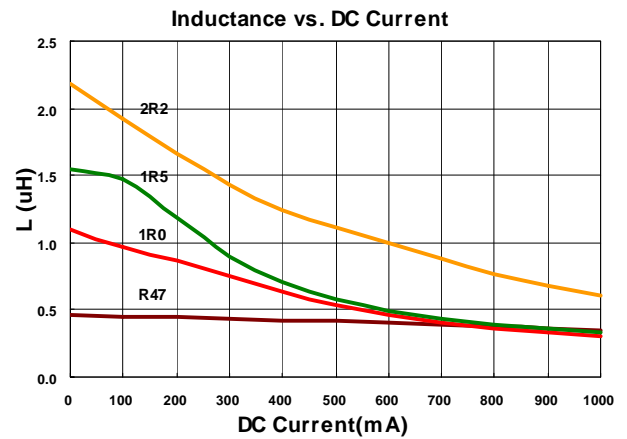
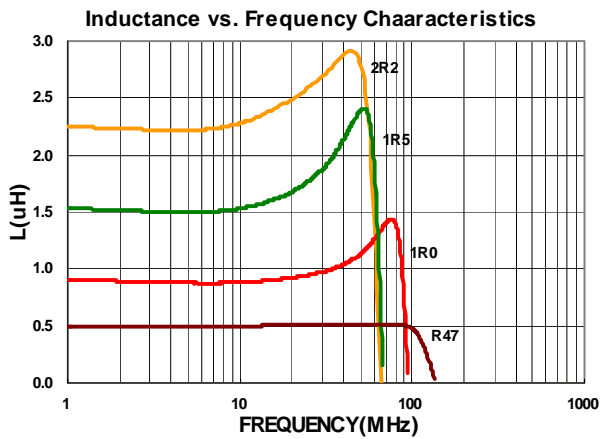

Electrical Characteristics

MPB : Low RDC Series

Part Number	Inductance (uH)	Test Frequency (MHz)	Tolerance (±%)	RDC (Ω) ±30%	Rated current (mA) Max
MPB201210T-R47□-NA2	0.47	3	20, 30	0.09	1300
MPB201210T-1R0□-NA2	1.0	3	20, 30	0.12	1200
MPB201210T-1R5□-NA2	1.5	3	20, 30	0.15	1100
MPB201210T-2R2□-NA2	2.2	3	20, 30	0.19	1100
MPB201210T-3R3□-NA2	3.3	3	20, 30	0.24	800
MPB201210T-4R7□-NA2	4.7	3	20, 30	0.26	700

- Tolerance : M = ±20% ,T = ±30%
- Packaging: Clear tape and reel {standard}.
- L : Agilent/HP4287A+16197A, 3MHz 200mV
- RDC : HP 4338B, or equivalent
- Rated Current : Applied the current to coils, the temperature rise shall not be more than 40°C
- Operating temperature range from -55°C to 125°C . (Including self - temperature rise)

Test Instruments : HP4287A Inductance / Material Analyzer

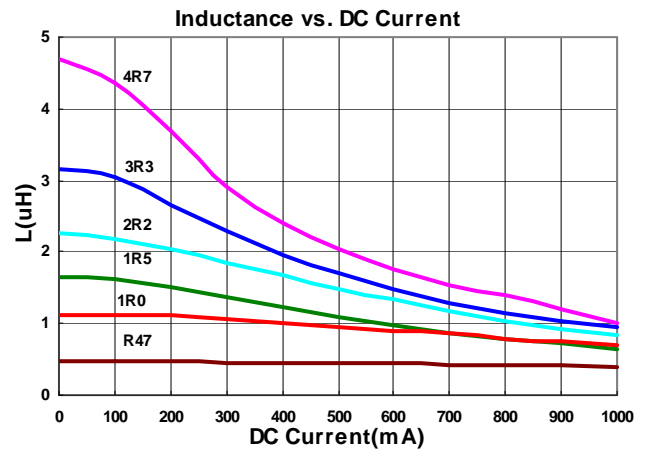
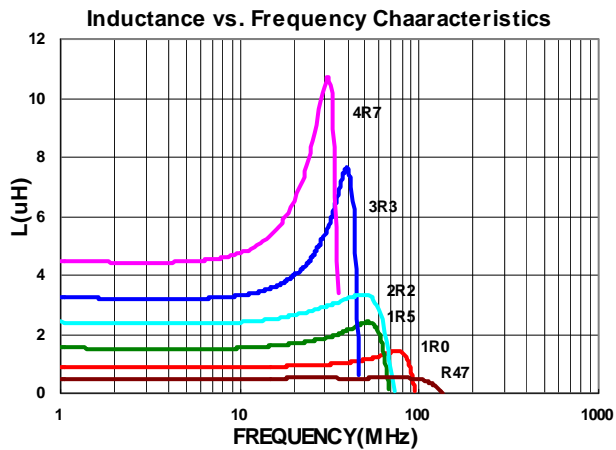

Electrical Characteristics

MPB : Low RDC Series

Part Number	Inductance (uH)	Test Frequency (MHz)	Tolerance (±%)	RDC (Ω) ±30%	Rated current (mA) Max
MPB201212T-1R0□-NA2	1.0	3	20, 30	0.13	1200
MPB201212T-1R5□-NA2	1.5	3	20, 30	0.16	1100
MPB201212T-2R2□-NA2	2.2	3	20, 30	0.23	900
MPB201212T-3R3□-NA2	3.3	3	20, 30	0.23	900
MPB201212T-4R7□-NA2	4.7	3	20, 30	0.27	700

- Tolerance : M = ±20% , T = ±30%
- Packaging: Clear tape and reel {standard}.
- L : Agilent/HP4287A+16197A, 3MHz 200mV
- RDC : HP 4338B, or equivalent
- Rated Current : Applied the current to coils, the temperature rise shall not be more than 40°C
- Operating temperature range from -55°C to 125°C. (Including self - temperature rise)

Test Instruments : HP4287A Inductance / Material Analyzer

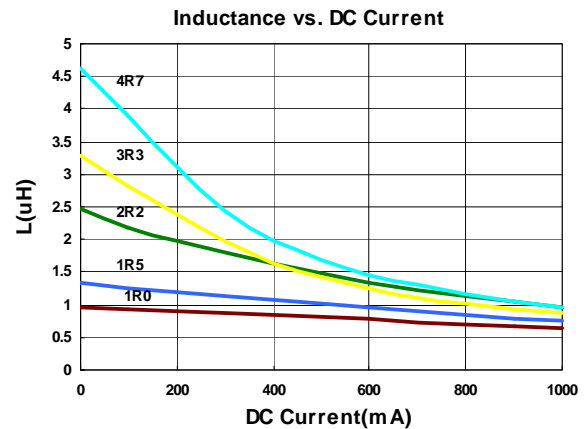
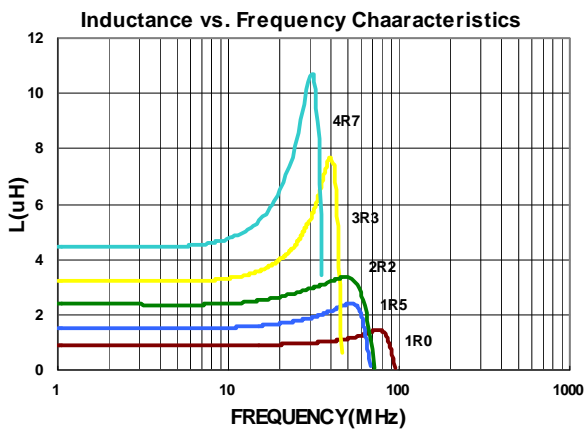

Electrical Characteristics

MPB : Low RDC Series

Part Number	Inductance (uH)	Test Frequency (MHz)	Tolerance (±%)	RDC (Ω) ±30%	Rated current (mA) Max
MPB201610T-R47□-NA2	0.47	3	20, 30	0.06	1600
MPB201610T-1R0□-NA2	1.0	3	20, 30	0.09	1300
MPB201610T-2R2□-NA2	2.2	3	20, 30	0.13	1000
MPB201610T-3R3□-NA2	3.3	3	20, 30	0.17	850
MPB201610T-4R7□-NA2	4.7	3	20, 30	0.21	800

- Tolerance : M = ±20% , T = ±30%
- Packaging: Clear tape and reel {standard}.
- L : Agilent/HP4287A+16197A, 3MHz 200mV
- RDC : HP 4338B, or equivalent
- Rated Current : Applied the current to coils, the temperature rise shall not be more than 40°C
- Operating temperature range from -55°C to 125°C. (Including self - temperature rise)

Test Instruments : HP4287A Inductance / Material Analyzer

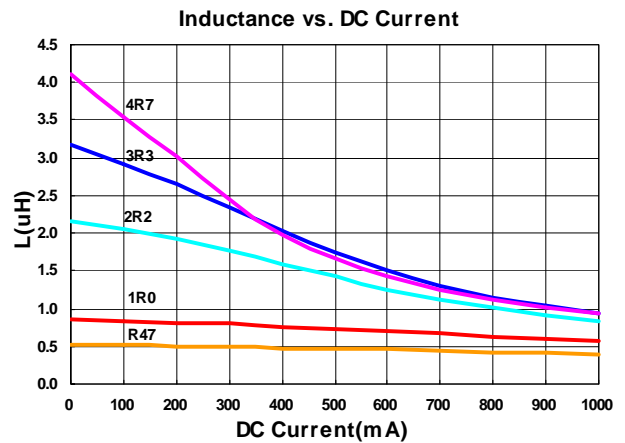
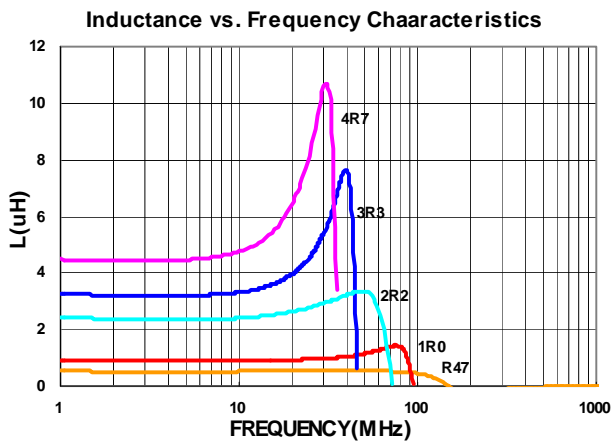

Electrical Characteristics

MPB : Low RDC Series

Part Number	Inductance (uH)	Test Frequency (MHz)	Tolerance (±%)	RDC (Ω) ±30%	Rated current (mA) Max
MPB252010T-R47□-NA2	0.47	3	20, 30	0.04	1800
MPB252010T-1R0□-NA2	1.0	3	20, 30	0.06	1500
MPB252010T-1R5□-NA2	1.5	3	20, 30	0.07	1400
MPB252010T-2R2□-NA2	2.2	3	20, 30	0.10	1200
MPB252010T-3R3□-NA2	3.3	3	20, 30	0.12	1100
MPB252010T-4R7□-NA2	4.7	3	20, 30	0.14	1000

- Tolerance : M = ±20% ,T = ±30%
- Packaging: Clear tape and reel {standard}.
- L : Agilent/HP4287A+16197A, 3MHz 200mV
- RDC : HP 4338B, or equivalent
- Rated Current : Applied the current to coils, the temperature rise shall not be more than 40°C
- Operating temperature range from -55°C to 125°C . (Including self - temperature rise)

Test Instruments : HP4287A Inductance / Material Analyzer

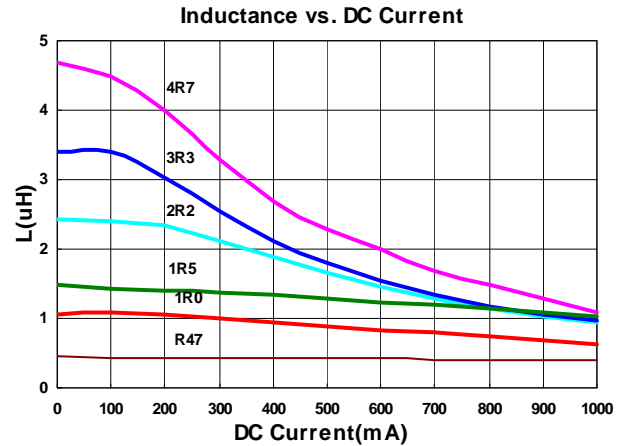
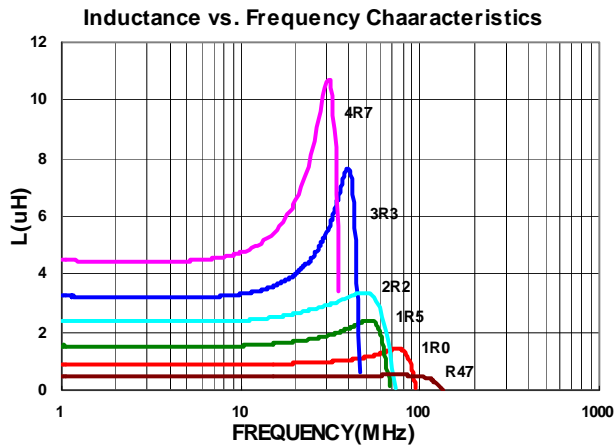

Electrical Characteristics

MPB : Low RDC Series

Part Number	Inductance (uH)	Test Frequency (MHz)	Tolerance (±%)	RDC (Ω) ±30%	Rated current (mA) Max
MPB252012T-R47□-NA2	0.47	3	20, 30	0.04	1800
MPB252012T-1R0□-NA2	1.0	3	20, 30	0.05	1600
MPB252012T-1R5□-NA2	1.5	3	20, 30	0.07	1400
MPB252012T-2R2□-NA2	2.2	3	20, 30	0.10	1200
MPB252012T-3R3□-NA2	3.3	3	20, 30	0.12	1100
MPB252012T-4R7□-NA2	4.7	3	20, 30	0.14	1000
MPB252012T-6R8□-NA2	6.8	3	20, 30	0.16	900
MPB252012T-100□-NA2	10	3	20, 30	0.20	500

- Tolerance : M = ±20% ,T = ±30%
- Packaging: Clear tape and reel {standard}.
- L : Agilent/HP4287A+16197A, 3MHz 200mV
- RDC : HP 4338B, or equivalent
- Rated Current : Applied the current to coils, the temperature rise shall not be more than 40°C
- Operating temperature range from -55°C to 125°C . (Including self - temperature rise)

Test Instruments : HP4287A Inductance / Material Analyzer

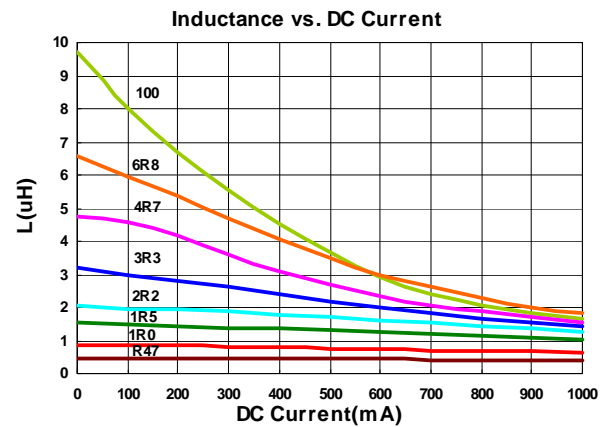
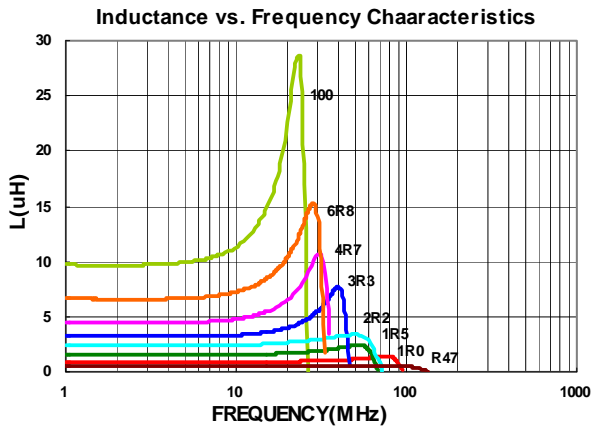

Packaging Specifications

Tape Dimensions

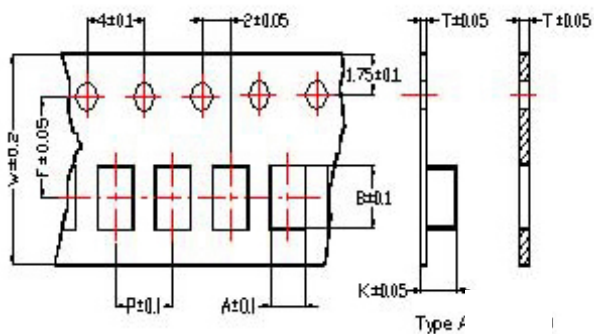

Tape Material

Carrier Tape: Polycarbonate (Tape A)
 Carrier Tape: Paper (Tape B)
 Cover Tape: Polystyrene

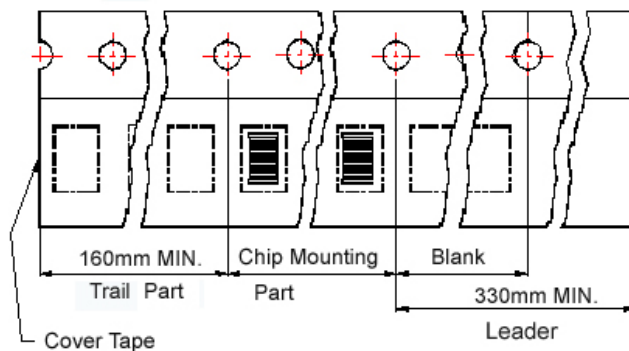

Reel Dimensions

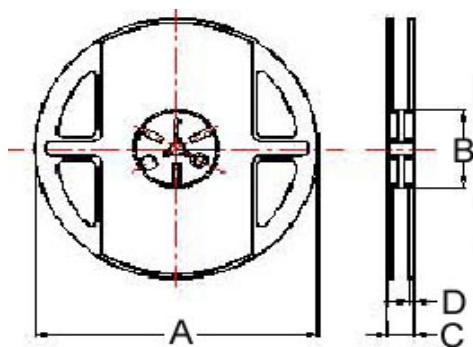

Dimensions in mm

TYPE	Tape Dimensions								Reel Dimensions				Quantity PCS / REEL
	A	B	T	W	P	F	K	Tape Type	A	B	C	D	
160808	1.05	1.85	0.95	8.0	4.0	3.5	0.80	B	178	60	12	1.5	4000
201205	1.42	2.25	0.22	8.0	4.0	3.5	0.80	A	178	60	12	1.5	4000
201210	1.45	2.25	0.22	8.0	4.0	3.5	1.04	A	178	60	12	1.5	3000
201212	1.35	2.25	0.22	8.0	4.0	3.5	1.35	A	178	60	12	1.5	3000
201610	1.80	2.20	0.22	8.0	4.0	3.5	1.15	A	178	60	12	1.5	3000
252010	2.25	2.8	0.25	8.0	4.0	3.5	1.35	A	178	60	12	1.5	3000
252012	2.25	2.8	0.25	8.0	4.0	3.5	1.35	A	178	60	12	1.5	3000

X-ON Electronics

Largest Supplier of Electrical and Electronic Components

Click to view similar products for [Fixed Inductors](#) category:

Click to view products by [Chilisin](#) manufacturer:

Other Similar products are found below :

[CR32NP-100KC](#) [CR32NP-151KC](#) [CR32NP-180KC](#) [CR32NP-181KC](#) [CR32NP-1R5MC](#) [CR32NP-390KC](#) [CR32NP-3R9MC](#) [CR32NP-680KC](#) [CR32NP-820KC](#) [CR32NP-8R2MC](#) [CR43NP-390KC](#) [CR43NP-560KC](#) [CR43NP-680KC](#) [CR54NP-181KC](#) [CR54NP-470LC](#) [CR54NP-820KC](#) [CR54NP-8R5MC](#) [70F224AI](#) [MGDQ4-00004-P](#) [MHL1ECTTP18NJ](#) [MHQ1005P10NJ](#) [MHQ1005P1N0S](#) [MHQ1005P2N4S](#) [MHQ1005P3N6S](#) [MHQ1005P5N1S](#) [MHQ1005P8N2J](#) [PE-51506NL](#) [PE-53601NL](#) [PE-53602NL](#) [PE-53630NL](#) [PE-53824SNLT](#) [PE-92100NL](#) [PG0434.801NLT](#) [PG0936.113NLT](#) [9220-20](#) [9310-16](#) [PM06-2N7](#) [PM06-39NJ](#) [A01TK](#) [1206CS-471XJ](#) [HC2LP-R47-R](#) [HC2-R47-R](#) [HC3-2R2-R](#) [HCF1305-3R3-R](#) [1206CS-151XG](#) [RCH664NP-140L](#) [RCH664NP-4R7M](#) [RCH8011NP-221L](#) [RCP1317NP-332L](#) [RCP1317NP-391L](#)