

## Multilayer Power Inductors



The MPx Series is a miniature type of multilayer power inductor constructed using low-loss ferrite material to support high-speed switching frequencies. The compact size and high efficiency is ideal for DC-DC converter applications in space-limited boards.

### Features

- RoHS compliant
- Small size
- Low profile
- High current
- Magnetically shielded configuration allowing for high density mounting

### Applications

- DC-DC converters
- Power modules
- Cellular phones
- DSC, PND, DVD
- Wireless card and other electronic devices.

### Product Identification

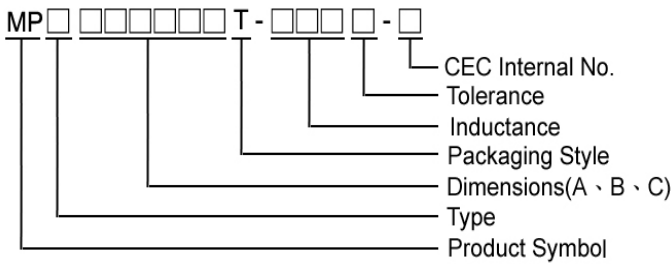

- Product Symbol : MPA, MPB
- Type : A : General , B : Low RDC
- Packaging : T : Tape and Reel , B : Bulk
- Tolerance : M =  $\pm 20\%$  , T =  $\pm 30\%$

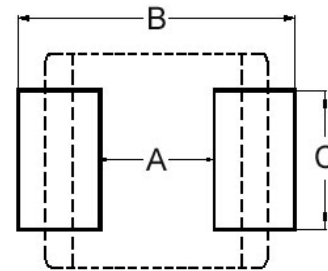
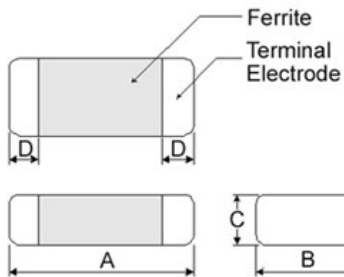

Dimensions in mm

TYPE	A	B	C	D
160808	1.6 $\pm$ 0.15	0.8 $\pm$ 0.15	0.8 $\pm$ 0.15	0.3 $\pm$ 0.2
201205	2.0 $\pm$ 0.20	1.25 $\pm$ 0.20	0.55 Max	0.5 $\pm$ 0.3
201210	2.0 $\pm$ 0.20	1.25 $\pm$ 0.20	1.0 Max	0.5 $\pm$ 0.3
201212	2.0 $\pm$ 0.20	1.25 $\pm$ 0.20	1.25 $\pm$ 0.20	0.5 $\pm$ 0.3
201610	2.0 $\pm$ 0.20	1.6 $\pm$ 0.20	1.0 Max	0.5 $\pm$ 0.3
252010	2.5 $\pm$ 0.20	2.0 $\pm$ 0.20	1.0 Max	0.5 $\pm$ 0.3
252012	2.5 $\pm$ 0.20	2.0 $\pm$ 0.20	1.2 Max	0.5 $\pm$ 0.3

Dimensions in mm

TYPE	A	B	C
160808	0.7 ~ 0.8	1.8 ~ 2.0	0.6 ~ 0.8
201205	0.8 ~ 1.2	2.3 ~ 2.9	1.0 ~ 1.4
201210	0.8 ~ 1.2	2.3 ~ 2.9	1.0 ~ 1.4
201212	0.8 ~ 1.2	2.3 ~ 2.9	1.0 ~ 1.4
201610	0.8 ~ 1.2	2.1 ~ 2.7	1.6 ~ 2.0
252010	1.3 ~ 1.9	2.7 ~ 3.5	2.0 ~ 2.6
252012	1.3 ~ 1.9	2.7 ~ 3.5	2.0 ~ 2.6

## Electrical Characteristics

### MPA : General Series

Part Number	Inductance (uH)	Test Frequency (MHz)	Tolerance (±%)	RDC (Ω) ±30%	Rated current (mA) Max
MPA201210T-1R0□-N	1.0	1	20, 30	0.18	1100
MPA201210T-1R5□-N	1.5	1	20, 30	0.19	1000
MPA201210T-2R2□-N	2.2	1	20, 30	0.22	900
MPA201210T-3R3□-N	3.3	1	20, 30	0.25	700
MPA201210T-4R7□-N	4.7	1	20, 30	0.35	600

- Tolerance : M = ±20% , T = ±30%
- Packaging: Clear tape and reel {standard}.
- L : Agilent/HP4287A+16197A, 1MHz 200mV
- RDC : HP 4338B, or equivalent
- Rated Current : Applied the current to coils, the temperature rise shall not be more than 40°C
- Operating temperature range from -55°C to 125°C. (Including self - temperature rise)

### Test Instruments : HP4287A Inductance / Material Analyzer

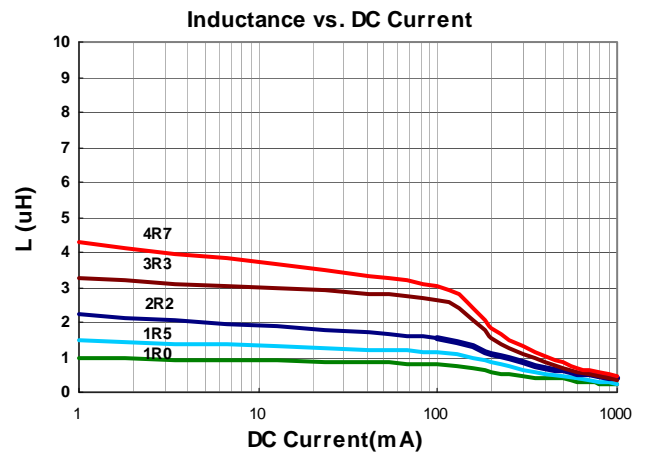
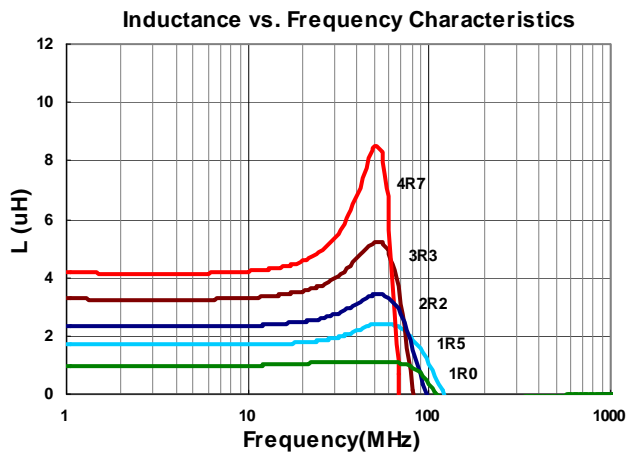

## Electrical Characteristics

### MPA : General Series

Part Number	Inductance (uH)	Test Frequency (MHz)	Tolerance (±%)	RDC (Ω) ±30%	Rated current (mA) Max
MPA252010T-1R0□-N	1.0	1	20, 30	0.11	1200
MPA252010T-1R5□-N	1.5	1	20, 30	0.13	1100
MPA252010T-2R2□-N	2.2	1	20, 30	0.15	1000
MPA252010T-3R3□-N	3.3	1	20, 30	0.18	1000
MPA252010T-4R7□-N	4.7	1	20, 30	0.25	900

- Tolerance : M = ±20% , T = ±30%
- Packaging: Clear tape and reel {standard}.
- L : Agilent/HP4287A+16197A, 1MHz 200mV
- RDC : HP 4118B, or equivalent
- Rated Current : Applied the current to coils, the temperature rise shall not be more than 40°C
- Operating temperature range from -55°C to 125°C. (Including self - temperature rise)

### Test Instruments : HP4287A Inductance / Material Analyzer

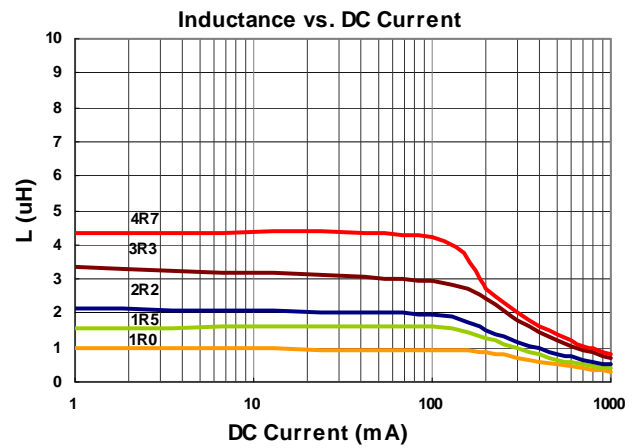
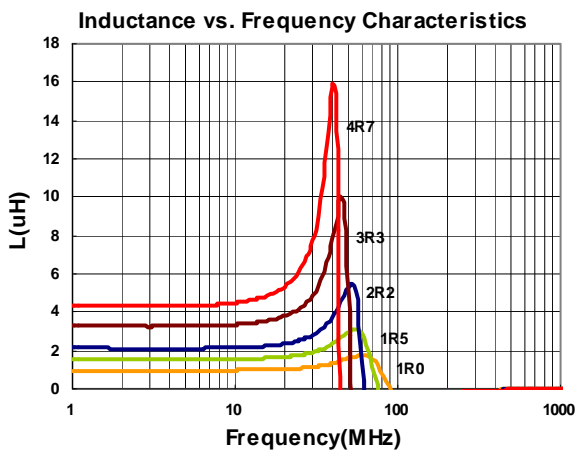

## Electrical Characteristics

### MPB : Low RDC Series

Part Number	Inductance (uH)	Test Frequency (MHz)	Tolerance (±%)	RDC (Ω) ±30%	Rated current (mA) Max
MPB160808T-R56□-NA2	0.56	3	20, 30	0.23	900
MPB160808T-1R0□-NA2	1.0	3	20, 30	0.28	800
MPB160808T-2R2□-NA2	2.2	3	20, 30	0.40	600

- Tolerance : M = ±20% , T = ±30%
- Packaging: Clear tape and reel {standard}.
- L : Agilent/HP4287A+16197A, 3MHz 200mV
- RDC : HP 4338B, or equivalent
- Rated Current : Applied the current to coils, the temperature rise shall not be more than 40°C
- Operating temperature range from -55°C to 125°C. (Including self - temperature rise)

### Test Instruments : HP4287A Inductance / Material Analyzer

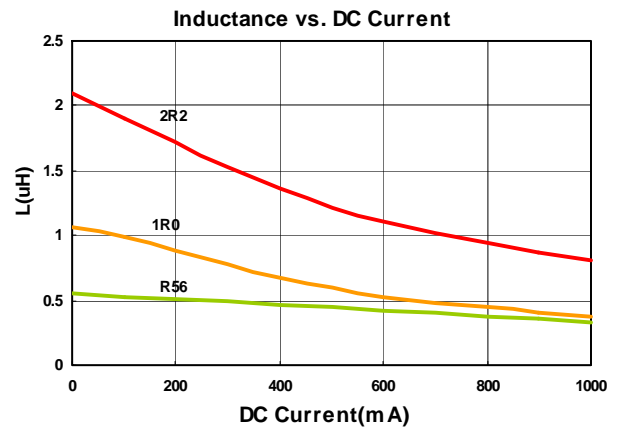
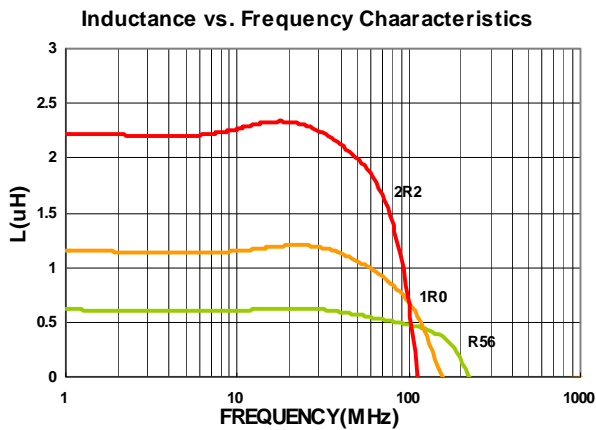

## Electrical Characteristics

### MPB : Low RDC Series

Part Number	Inductance (uH)	Test Frequency (MHz)	Tolerance (±%)	RDC (Ω) ±30%	Rated current (mA) Max
MPB201205T-R47□-NA2	0.47	3	20, 30	0.11	1200
MPB201205T-1R0□-NA2	1.0	3	20, 30	0.16	900
MPB201205T-1R5□-NA2	1.5	3	20, 30	0.18	800
MPB201206T-2R2□-NA2	2.2	3	20, 30	0.29	600

- Tolerance : M = ±20% ,T = ±30%
- Packaging: Clear tape and reel {standard}
- L : Agilent/HP4287A+16197A, 3MHz 200mV
- RDC : HP 4338B, or equivalent
- Rated Current : Applied the current to coils, the temperature rise shall not be more than 40°C
- Operating temperature range from -55°C to 125°C . (Including self - temperature rise)

### Test Instruments : HP4287A Inductance / Material Analyzer

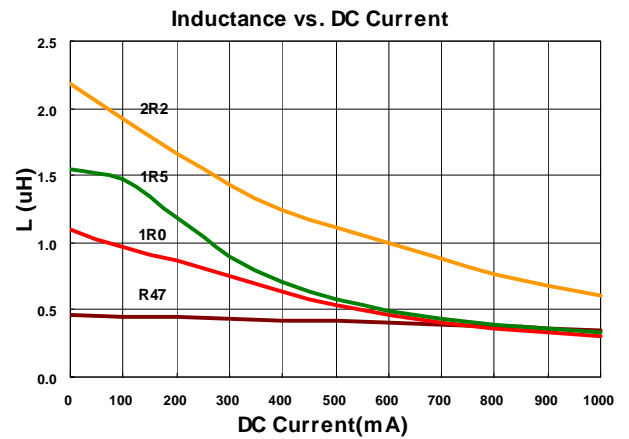
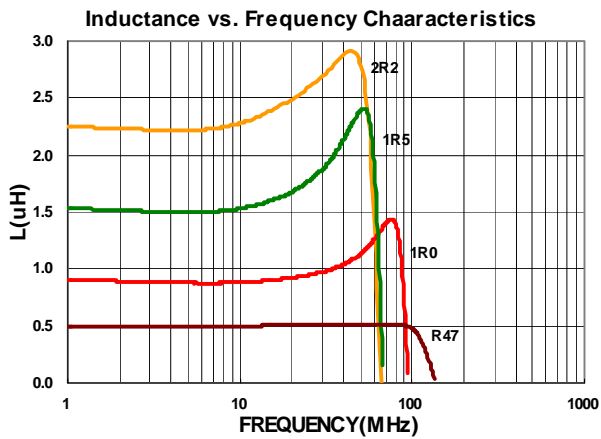

## Electrical Characteristics

### MPB : Low RDC Series

Part Number	Inductance (uH)	Test Frequency (MHz)	Tolerance (±%)	RDC (Ω) ±30%	Rated current (mA) Max
MPB201210T-R47□-NA2	0.47	3	20, 30	0.09	1300
MPB201210T-1R0□-NA2	1.0	3	20, 30	0.12	1200
MPB201210T-1R5□-NA2	1.5	3	20, 30	0.15	1100
MPB201210T-2R2□-NA2	2.2	3	20, 30	0.19	1100
MPB201210T-3R3□-NA2	3.3	3	20, 30	0.24	800
MPB201210T-4R7□-NA2	4.7	3	20, 30	0.26	700

- Tolerance : M = ±20% ,T = ±30%
- Packaging: Clear tape and reel {standard}.
- L : Agilent/HP4287A+16197A, 3MHz 200mV
- RDC : HP 4338B, or equivalent
- Rated Current : Applied the current to coils, the temperature rise shall not be more than 40°C
- Operating temperature range from -55°C to 125°C . (Including self - temperature rise)

### Test Instruments : HP4287A Inductance / Material Analyzer

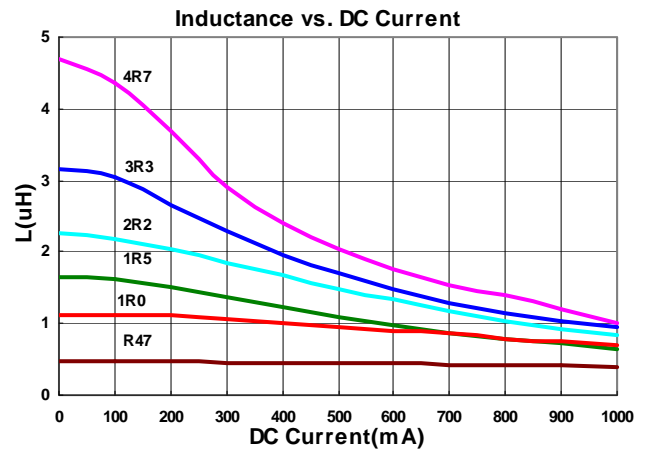
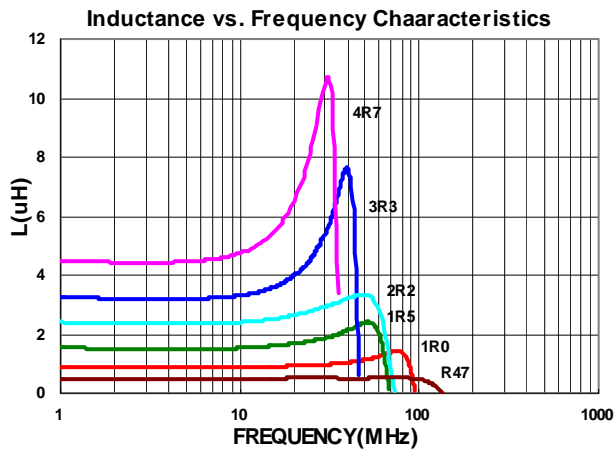

## Electrical Characteristics

### MPB : Low RDC Series

Part Number	Inductance (uH)	Test Frequency (MHz)	Tolerance (±%)	RDC (Ω) ±30%	Rated current (mA) Max
MPB201212T-1R0□-NA2	1.0	3	20, 30	0.13	1200
MPB201212T-1R5□-NA2	1.5	3	20, 30	0.16	1100
MPB201212T-2R2□-NA2	2.2	3	20, 30	0.23	900
MPB201212T-3R3□-NA2	3.3	3	20, 30	0.23	900
MPB201212T-4R7□-NA2	4.7	3	20, 30	0.27	700

- Tolerance : M = ±20% , T = ±30%
- Packaging: Clear tape and reel {standard}.
- L : Agilent/HP4287A+16197A, 3MHz 200mV
- RDC : HP 4338B, or equivalent
- Rated Current : Applied the current to coils, the temperature rise shall not be more than 40°C
- Operating temperature range from -55°C to 125°C. (Including self - temperature rise)

### Test Instruments : HP4287A Inductance / Material Analyzer

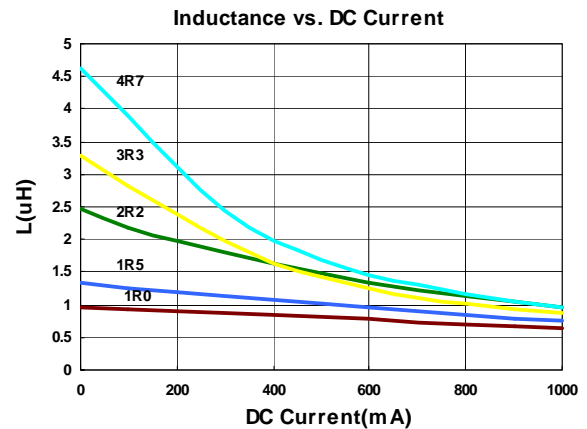
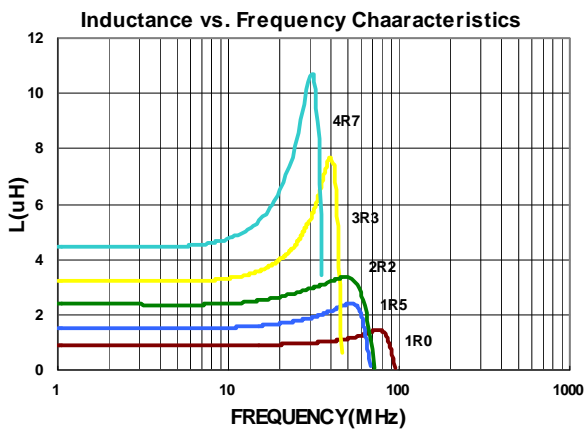

## Electrical Characteristics

### MPB : Low RDC Series

Part Number	Inductance (uH)	Test Frequency (MHz)	Tolerance (±%)	RDC (Ω) ±30%	Rated current (mA) Max
MPB201610T-R47□-NA2	0.47	3	20, 30	0.06	1600
MPB201610T-1R0□-NA2	1.0	3	20, 30	0.09	1300
MPB201610T-2R2□-NA2	2.2	3	20, 30	0.13	1000
MPB201610T-3R3□-NA2	3.3	3	20, 30	0.17	850
MPB201610T-4R7□-NA2	4.7	3	20, 30	0.21	800

- Tolerance : M = ±20% , T = ±30%
- Packaging: Clear tape and reel {standard}.
- L : Agilent/HP4287A+16197A, 3MHz 200mV
- RDC : HP 4338B, or equivalent
- Rated Current : Applied the current to coils, the temperature rise shall not be more than 40°C
- Operating temperature range from -55°C to 125°C. (Including self - temperature rise)

### Test Instruments : HP4287A Inductance / Material Analyzer

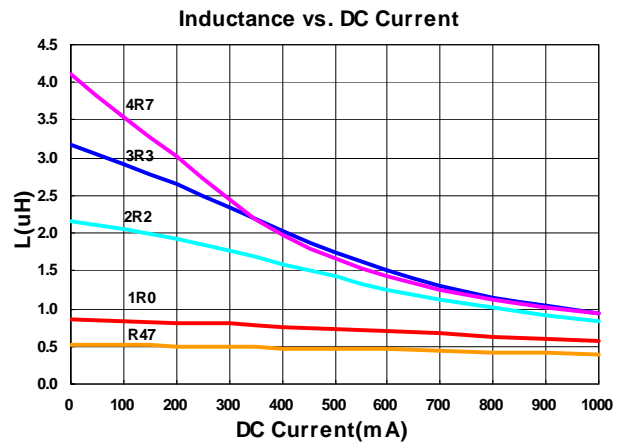
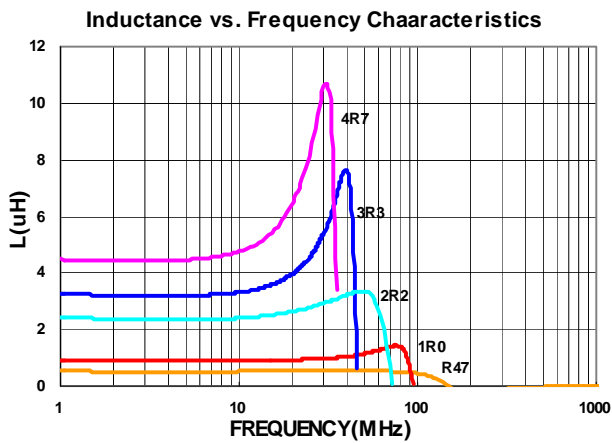



## Electrical Characteristics

### MPB : Low RDC Series

Part Number	Inductance (uH)	Test Frequency (MHz)	Tolerance (±%)	RDC (Ω) ±30%	Rated current (mA) Max
MPB252010T-R47□-NA2	0.47	3	20, 30	0.04	1800
MPB252010T-1R0□-NA2	1.0	3	20, 30	0.06	1500
MPB252010T-1R5□-NA2	1.5	3	20, 30	0.07	1400
MPB252010T-2R2□-NA2	2.2	3	20, 30	0.10	1200
MPB252010T-3R3□-NA2	3.3	3	20, 30	0.12	1100
MPB252010T-4R7□-NA2	4.7	3	20, 30	0.14	1000

- Tolerance : M = ±20% ,T = ±30%
- Packaging: Clear tape and reel {standard}.
- L : Agilent/HP4287A+16197A, 3MHz 200mV
- RDC : HP 4338B, or equivalent
- Rated Current : Applied the current to coils, the temperature rise shall not be more than 40°C
- Operating temperature range from -55°C to 125°C . (Including self - temperature rise)

### Test Instruments : HP4287A Inductance / Material Analyzer

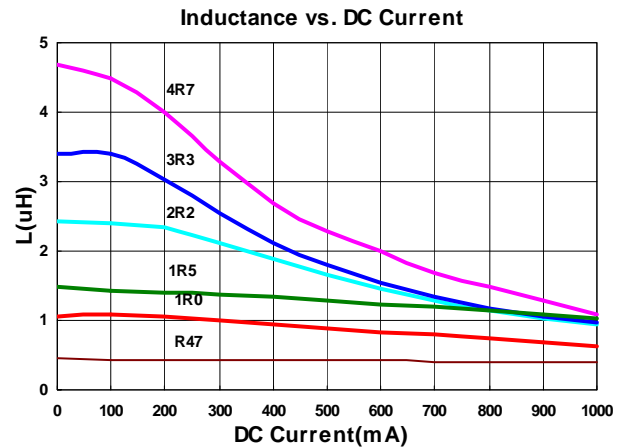
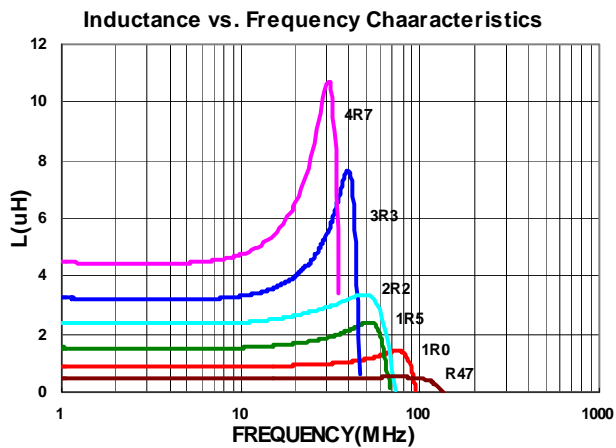

## Electrical Characteristics

### MPB : Low RDC Series

Part Number	Inductance (uH)	Test Frequency (MHz)	Tolerance (±%)	RDC (Ω) ±30%	Rated current (mA) Max
MPB252012T-R47□-NA2	0.47	3	20, 30	0.04	1800
MPB252012T-1R0□-NA2	1.0	3	20, 30	0.05	1600
MPB252012T-1R5□-NA2	1.5	3	20, 30	0.07	1400
MPB252012T-2R2□-NA2	2.2	3	20, 30	0.10	1200
MPB252012T-3R3□-NA2	3.3	3	20, 30	0.12	1100
MPB252012T-4R7□-NA2	4.7	3	20, 30	0.14	1000
MPB252012T-6R8□-NA2	6.8	3	20, 30	0.16	900
MPB252012T-100□-NA2	10	3	20, 30	0.20	500

- Tolerance : M = ±20% ,T = ±30%
- Packaging: Clear tape and reel {standard}.
- L : Agilent/HP4287A+16197A, 3MHz 200mV
- RDC : HP 4338B, or equivalent
- Rated Current : Applied the current to coils, the temperature rise shall not be more than 40°C
- Operating temperature range from -55°C to 125°C . (Including self - temperature rise)

### Test Instruments : HP4287A Inductance / Material Analyzer

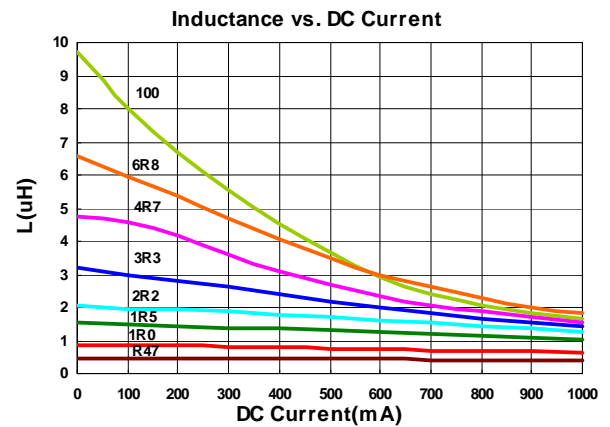
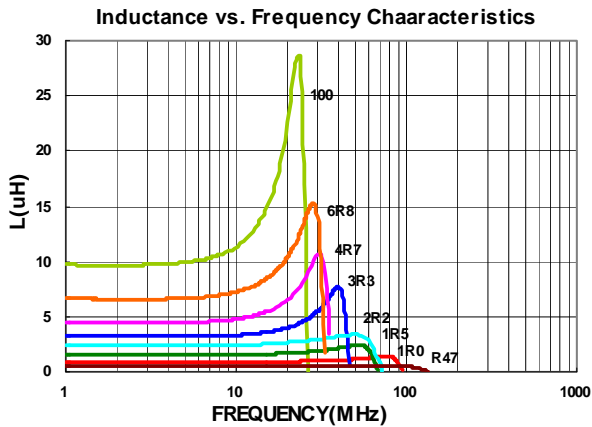

Packaging Specifications

Tape Dimensions

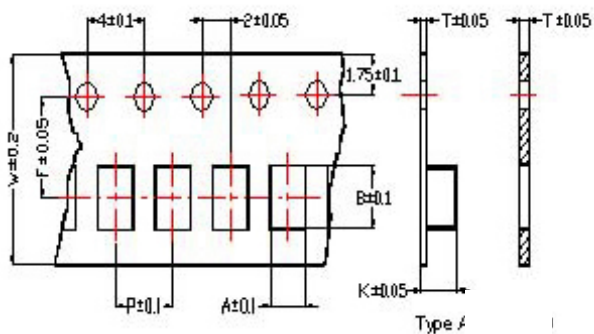

Tape Material

Carrier Tape: Polycarbonate (Tape A)  
 Carrier Tape: Paper (Tape B)  
 Cover Tape: Polystyrene

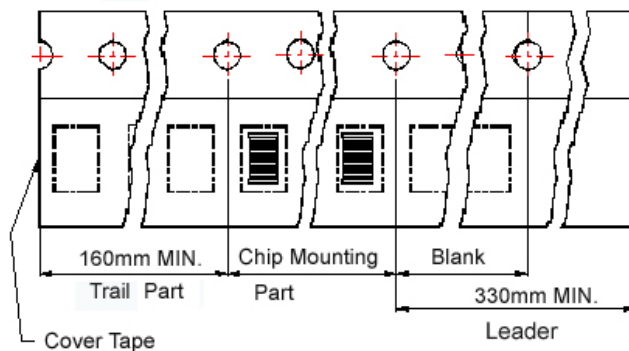

Reel Dimensions

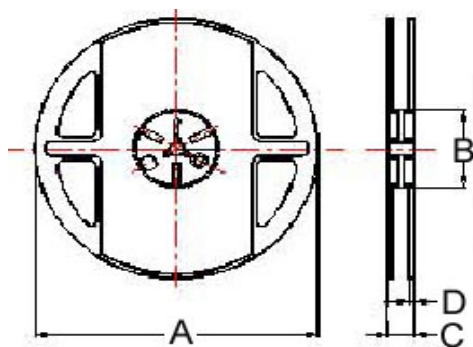

Dimensions in mm

TYPE	Tape Dimensions								Reel Dimensions				Quantity PCS / REEL
	A	B	T	W	P	F	K	Tape Type	A	B	C	D	
160808	1.05	1.85	0.95	8.0	4.0	3.5	0.80	B	178	60	12	1.5	4000
201205	1.42	2.25	0.22	8.0	4.0	3.5	0.80	A	178	60	12	1.5	4000
201210	1.45	2.25	0.22	8.0	4.0	3.5	1.04	A	178	60	12	1.5	3000
201212	1.35	2.25	0.22	8.0	4.0	3.5	1.35	A	178	60	12	1.5	3000
201610	1.80	2.20	0.22	8.0	4.0	3.5	1.15	A	178	60	12	1.5	3000
252010	2.25	2.8	0.25	8.0	4.0	3.5	1.35	A	178	60	12	1.5	3000
252012	2.25	2.8	0.25	8.0	4.0	3.5	1.35	A	178	60	12	1.5	3000

## X-ON Electronics

Largest Supplier of Electrical and Electronic Components

*Click to view similar products for [Fixed Inductors](#) category:*

*Click to view products by [Chilisin](#) manufacturer:*

Other Similar products are found below :

[CR32NP-100KC](#) [CR32NP-151KC](#) [CR32NP-180KC](#) [CR32NP-181KC](#) [CR32NP-1R5MC](#) [CR32NP-390KC](#) [CR32NP-3R9MC](#) [CR32NP-680KC](#) [CR32NP-820KC](#) [CR32NP-8R2MC](#) [CR43NP-390KC](#) [CR43NP-560KC](#) [CR43NP-680KC](#) [CR54NP-181KC](#) [CR54NP-470LC](#) [CR54NP-820KC](#) [CR54NP-8R5MC](#) [70F224AI](#) [MGDQ4-00004-P](#) [MHL1ECTTP18NJ](#) [MHQ1005P10NJ](#) [MHQ1005P1N0S](#) [MHQ1005P2N4S](#) [MHQ1005P3N6S](#) [MHQ1005P5N1S](#) [MHQ1005P8N2J](#) [PE-51506NL](#) [PE-53601NL](#) [PE-53602NL](#) [PE-53630NL](#) [PE-53824SNLT](#) [PE-92100NL](#) [PG0434.801NLT](#) [PG0936.113NLT](#) [9220-20](#) [9310-16](#) [PM06-2N7](#) [PM06-39NJ](#) [A01TK](#) [1206CS-471XJ](#) [HC2LP-R47-R](#) [HC2-R47-R](#) [HC3-2R2-R](#) [HCF1305-3R3-R](#) [1206CS-151XG](#) [RCH664NP-140L](#) [RCH664NP-4R7M](#) [RCH8011NP-221L](#) [RCP1317NP-332L](#) [RCP1317NP-391L](#)