



Form No.: QF-1274
Edition: 2

ISO9001 & ISO14001 & TS16949 CHILISIN ELECTRONICS CORP.

RoHS & Halogen Free & REACH Compliance.

SPECIFICATION FOR APPROVAL

Customer : 深圳市福伯特电子有限公司

Customer P/N:

Drawing No :

Quantity : 0 Pcs. Date : 2018/08/28

Chilisin P/N : PCI0945T-701-NLM

SPECIFICATION ACCEPTED BY:	
COMPONENT ENGINEER	
ELECTRICAL ENGINEER	
MECHANICAL ENGINEER	
APPROVED	
REJECTED	

注意事項

此產品屬於工業級標準品，非車規產品！不能使用汽車配件中，若客戶未明確告知而私自使用到汽車配件中，產生任何後果，原廠不予負責售後服務，謝謝！

Drawn by
bingzhi.huang

Checked by
jingying.zhang

Approved by
steven



PCI0945T Series Specification

1 Scope: This specification applies to PCI FILTER

2 Part Numbering:

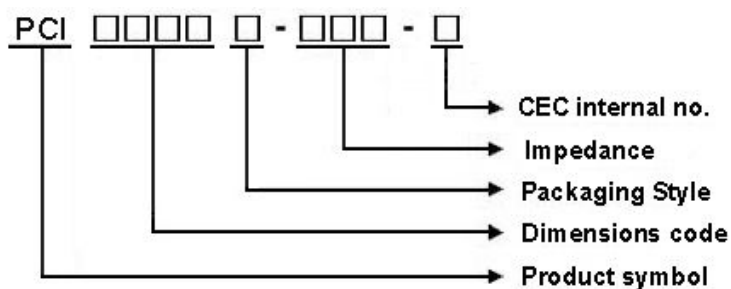

3 Rating:

Operating Temperature: $-40^{\circ}\text{C} \sim 105^{\circ}\text{C}$ (Including self - temperature rise)

Storage Temperature: $20^{\circ}\text{C} \sim 25^{\circ}\text{C}$ R.H. 65% (In Tape & Reel Condition)

4 Marking:

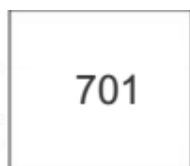

Ex : **PCI0945T-701-N**

Marking : **701**

Marking color : **White**

5 Standard Testing Condition

	Unless otherwise specified	In case of doubt
Temperature	Ordinary Temperature(15 to 35°C)	20 to 30°C
Humidity	Ordinary Humidity(25 to 85% RH)	50 to 80 %RH

PCI0945T Series Specification

6 Configuration and Dimensions:

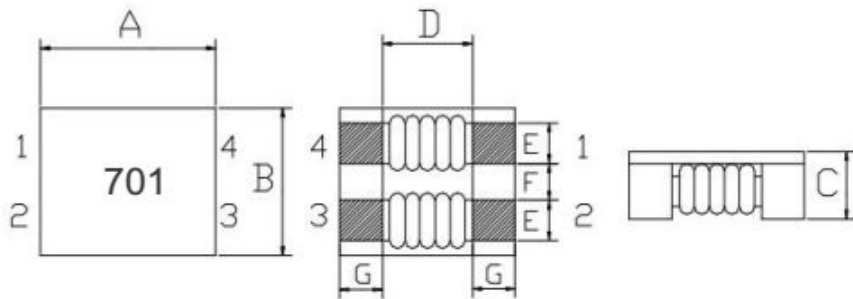

Dimensions in mm

TYPE	PCI0945T
A	9.0±0.5
B	7.0±0.5
C	4.8Max
D	5.7Typ
E	1.5±0.2
F	2.0±0.2
G	1.7±0.2

7 Electrical Characteristics:

Part No.	Impedance (Ω)Min/Typ.	Test Freq.	RDC (m Ω)Max.	I _{rms} (A)	IR (m Ω)Min.	Rated Voltage (V)Max	Marking
PCI0945T-701-NLM	500/700	100MHz,200mV	10	5	10	50	701

NOTE:

- Operating temperature range - 40°C ~ 105°C (Including self - temperature rise)
 - I_{rms} for a 40°C temperature rise from 25°C ambient.
 - Z:1,2-4,3 Common mode
 - The actual use current is suggested not to be out of I_{sat}*80%
- "-N" FOR COMPLETELY LEAD FREE TYPE(INCLUDING FERRITE BODY & SOLDER)

PCI0945T Series Specification

8 PCI0945T Series

8.1 Construction:

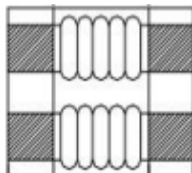
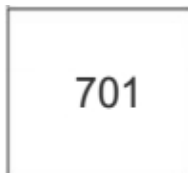

8.2 Material List:

NO.	ITEM	DESCRIPTION
1	CORE	FERRITE
2	COVER	LCP
3	WIRE	P180 Grd1
4	SOLDER	Sn99.3:Cu0.7
5	INK	BLACK

PCI0945T Series Specification

10 Packaging:

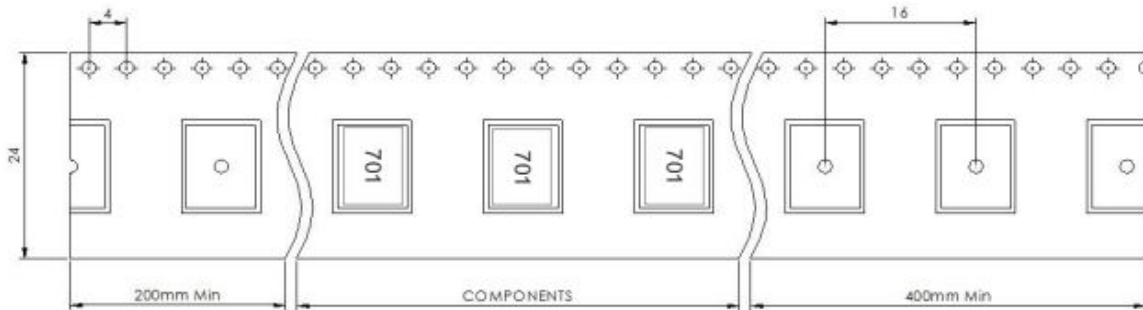

Transparent carrier and cover tape/透明載帶和自粘上帶

Adhesive strength of cover tape is 20 to 120 gf
The conduction band direction

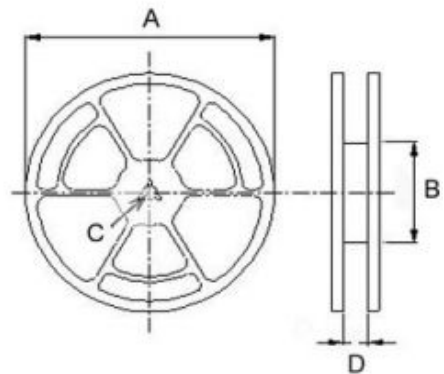
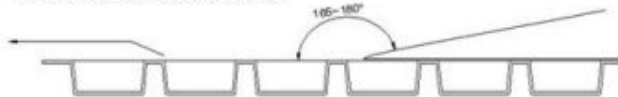

Reel Dimensions (Unit: mm)				Quantity
A	B	C	D	Pcs/Reel
330	100	13	24.5	700

11 Graph:

Note:

- Please make sure that your product is has been evaluated and confirmed against your specifications when our product is mounted to your product.
- Do not knock nor drop.
- All the items and parameters in this product specification have been prescribed on the premise that our product is used for the purpose, under the condition and in the environment agreed upon between you and us. You are requested not to use our product deviating from such agreement.
- Please keep the distance between transformer/coil and other components (refer to the standard IEC 950)
- The moisture sensitivity level (MSL) of products is classified as level 1.

X-ON Electronics

Largest Supplier of Electrical and Electronic Components

Click to view similar products for [Common Mode Chokes / Filters](#) category:

Click to view products by [Chilisin](#) manufacturer:

Other Similar products are found below :

[PE-64683](#) [RD5122-6-9M6](#) [ST6118T-R](#) [FE3X025-10-7NL](#) [T8114NLT](#) [TCM0806G-350-2P-T](#) [TCM0806G-650-2P-T](#) [IND-0110](#)
[UAL21VR0802000](#) [UALSC023000000](#) [UALSC1020JH000](#) [UALSU10VD20010](#) [UALSU9VD070100](#) [36-00037](#) [CM7060M132R-10](#)
[UALW21HS072450](#) [UALSU9H0208000](#) [UAL24VK06450CH](#) [PLT10HH501100PNB](#) [PLT10HH401100PNB](#) [PLT10HH1026R0PNB](#) [36-](#)
[00029-01](#) [PE-67531](#) [TLH10UB 113 OR5](#) [2752045447](#) [CM8663Z161B-10](#) [7351V](#) [CMF16-153131](#) [T8116NLT](#) [CMS2-10-R](#) [FE2X10-4-2NL](#)
[T8003NLT](#) [CTX01-13663](#) [CTX66-19521-R](#) [RC212-0.5-10M](#) [RC112-0.4-15M](#) [RC212-0.6-6M8](#) [RC212-0.4-15M](#) [RC112-0.3-30M](#) [4534-3](#)
[WTCF2012Z0M751PB](#) [PH9408.814NLT](#) [B82498B3221J000](#) [PAC6006.364NLT](#) [PAC6006.444NLT](#) [PAC6006.204NLT](#) [PH9407.204NLT](#)
[PAC6006.264NLT](#) [PH9408.105NLT](#) [PH9408.494NLT](#)