

Cautions and Warnings

Please be noted that this spec is only for reference if you have projects designed with the product number listed in. If you are looking for new project design-in, please find BBSY/BBBK Series specification/datasheet on Chilisin website. Or you may find our sales contact for more information on old part number at your convenience. Appreciated your attention and understanding.

Note: Please be sure to request approval specifications that provide further details of the products. Kindly note that the content of these specifications are subject to change or may be discontinued without prior notice. This product may not be designed/used in medical or high risk applications without Chilisin approval. Please contact our sales department before ordering.

Multilayer Ferrite Chip Beads



Chilisin offers a wide range of multi-layered ferrite chip beads with various sizes, frequency characteristics, and impedance values for EMI solutions. These ferrite formulas are used to compose seven types of EMI suppression chip beads: SB, GB, PB, UPB, NB, HF, and VPB series.

Product Identification

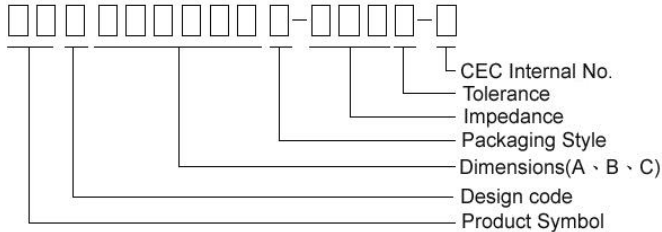

- Product symbol: SB, GB, PB, UPB, NB, HF, VPB
- Packaging: T : Tape and Reel ; B : Bulk
- Tolerance: Y = ± 25%; M = ± 20%; T:±30%
- Note: RoHS Compliant

Shape and Dimensions

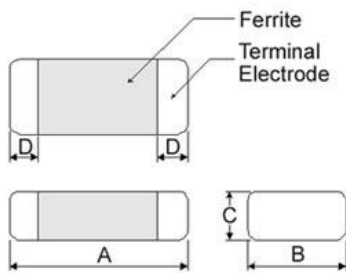

Recommended Pattern

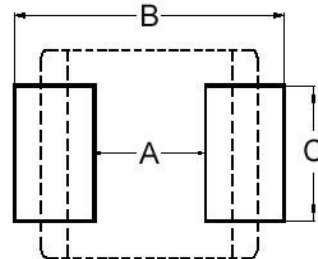

Dimensions in mm

| TYPE | A | B | C | D |
|---------|----------|-----------|----------|-----------|
| ①060303 | 0.6±0.03 | 0.30±0.03 | 0.3±0.03 | 0.15±0.05 |
| ②100505 | 1.0±0.10 | 0.50±0.10 | 0.5±0.10 | 0.25±0.10 |
| ③160805 | 1.6±0.15 | 0.80±0.15 | 0.5±0.15 | 0.3±0.2 |
| ④160808 | 1.6±0.15 | 0.80±0.15 | 0.8±0.15 | 0.3±0.2 |
| ⑤201209 | 2.0±0.20 | 1.25±0.20 | 0.9±0.20 | 0.5±0.3 |
| ⑥321611 | 3.2±0.20 | 1.60±0.20 | 1.1±0.20 | 0.5±0.3 |

- ① : SBY / SBJ / NB / PB ② : SBY / SBJ / NB / PB / UPB / HF
 ③ : UPB ④ : SBK / SBJ / GB / PB / NB / UPB / VPB
 ⑤ : SBK / GB / PB / UPB ⑥ : SBY / SBK / PB / UPB

Dimensions in mm

| TYPE | A | B | C |
|---------|-----------|-------------|-----------|
| ①060303 | 0.2 ~ 0.3 | 0.75 ~ 1.05 | 0.3 |
| ②100505 | 0.4 | 1.2 ~ 1.4 | 0.5 |
| ③160805 | 0.7 ~ 0.8 | 1.8 ~ 2.0 | 0.6 ~ 0.8 |
| ④160808 | 0.7 ~ 0.8 | 1.8 ~ 2.0 | 0.6 ~ 0.8 |
| ⑤201209 | 1.0 ~ 1.2 | 2.6 ~ 4.0 | 1.0 ~ 1.2 |
| ⑥321611 | 2.0 | 4.2 ~ 5.2 | 1.2 |

- * Don't apply narrower pattern than listed above to PB and UPB. Narrow pattern might cause excessive heat or open circuit.

Dimension Conversion

| Code | Dimension in mm (AxBxC) | EIA |
|--------|----------------------------|------|
| 060303 | 0.6X0.3X0.3 | 0201 |
| 100505 | 1.0X0.5X0.5 | 0402 |
| 160805 | 1.6x0.8x0.5 | 0603 |
| 160808 | 1.6x0.8x0.8 | 0603 |
| 201209 | 2.0x1.2x0.9 | 0805 |
| 321611 | 3.2x1.6x1.1 | 1206 |

SMD Multilayer Ferrite Chip Beads – SBY/SBK Series

Electrical Characteristics

| Part Number | Impedance ($\Omega \pm 25\%$) | Test Frequency (MHz) | RDC (Ω) Max | Rated current (mA) Max |
|-------------------|------------------------------------|-------------------------|-------------------------|---------------------------|
| SBY060303T-100Y-N | 10 | 100 | 0.1 | 500 |
| SBY060303T-600Y-N | 60 | 100 | 0.4 | 200 |
| SBY060303T-121Y-N | 120 | 100 | 0.5 | 200 |
| SBY060303T-241Y-N | 240 | 100 | 0.8 | 200 |
| SBY060303T-601Y-N | 600 | 100 | 1.5 | 100 |

Note: When ordering, please specify tolerance code. Tolerance : Y= $\pm 25\%$

- Operating temperature range - 55°C ~ 125°C(Including self - temperature rise)
- Rate Current : Applied the current to coils, the temperature rise shall not be more than 30°C
- Measure Equipment :
Z : HP4291A
RDC : HP4338B or CHEN HWA 502

Test Instruments : Agilent E4991A Impedance / Material Analyzer

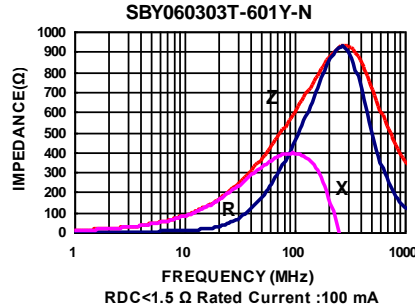
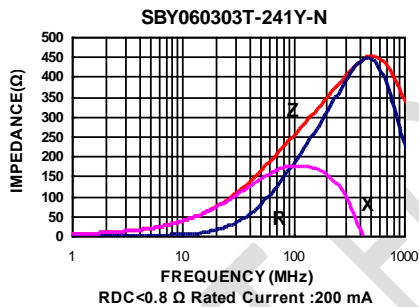
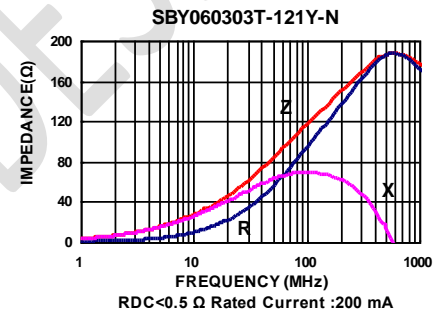
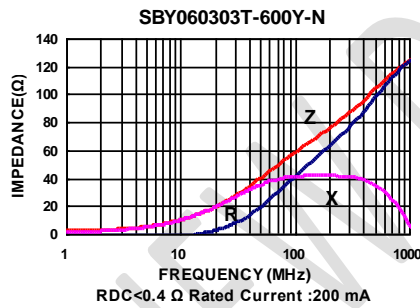
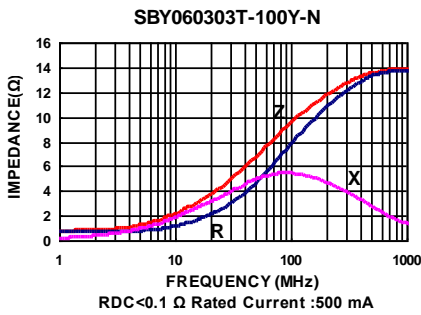

SMD Multilayer Ferrite Chip Beads – SBY/SBK Series

Electrical Characteristics

| Part Number | Impedance ($\Omega \pm 25\%$) | Test Frequency (MHz) | RDC (Ω) Max | Rated current (mA) Max |
|-------------------|------------------------------------|-------------------------|-------------------------|---------------------------|
| SBY100505T-100Y-N | 10 | 100 | 0.025 | 1000 |
| SBY100505T-110Y-N | 11 | 100 | 0.05 | 500 |
| SBY100505T-150Y-N | 15 | 100 | 0.10 | 500 |
| SBY100505T-190Y-N | 19 | 100 | 0.10 | 500 |
| SBY100505T-220Y-N | 22 | 100 | 0.15 | 500 |
| SBY100505T-300Y-N | 30 | 100 | 0.20 | 500 |
| SBY100505T-320Y-N | 32 | 100 | 0.20 | 500 |
| SBY100505T-330Y-N | 33 | 100 | 0.20 | 500 |
| SBY100505T-400Y-N | 40 | 100 | 0.20 | 500 |
| SBY100505T-470Y-N | 47 | 100 | 0.20 | 500 |
| SBY100505T-500Y-N | 50 | 100 | 0.20 | 500 |
| SBY100505T-600Y-N | 60 | 100 | 0.20 | 500 |
| SBY100505T-700Y-N | 70 | 100 | 0.15 | 600 |
| SBY100505T-750Y-N | 75 | 100 | 0.20 | 500 |
| SBY100505T-800Y-N | 80 | 100 | 0.20 | 500 |
| SBY100505T-900Y-N | 90 | 100 | 0.25 | 500 |
| SBY100505T-101Y-N | 100 | 100 | 0.25 | 500 |
| SBY100505T-121Y-N | 120 | 100 | 0.19 | 550 |
| SBY100505T-151Y-N | 150 | 100 | 0.40 | 400 |
| SBY100505T-181Y-N | 180 | 100 | 0.40 | 400 |
| SBY100505T-221Y-N | 220 | 100 | 0.29 | 450 |
| SBY100505T-241Y-N | 240 | 100 | 0.40 | 400 |
| SBY100505T-301Y-N | 300 | 100 | 0.50 | 300 |
| SBY100505T-331Y-N | 330 | 100 | 0.50 | 300 |
| SBY100505T-471Y-N | 470 | 100 | 0.50 | 300 |
| SBY100505T-481Y-N | 480 | 100 | 0.50 | 300 |
| SBY100505T-601Y-N | 600 | 100 | 0.52 | 300 |
| SBY100505T-102Y-N | 1000 | 100 | 0.65 | 300 |
| SBY100505T-182Y-N | 1800 | 100 | 1.40 | 100 |
| SBY100505T-222Y-N | 2200 | 100 | 1.40 | 100 |

Note: When ordering, please specify tolerance code. Tolerance : Y= $\pm 25\%$

- Operating temperature range - 55°C ~ 125°C(Including self - temperature rise)
- Rate Current : Applied the current to coils, the temperature rise shall not be more than 30°C
- Measure Equipment :
Z : HP4291A
RDC : HP4338B or CHEN HWA 502

Test Instruments : Agilent E4991A Impedance / Material Analyzer

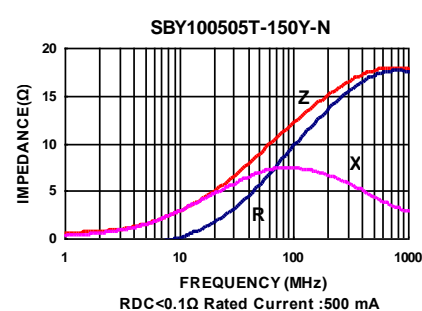
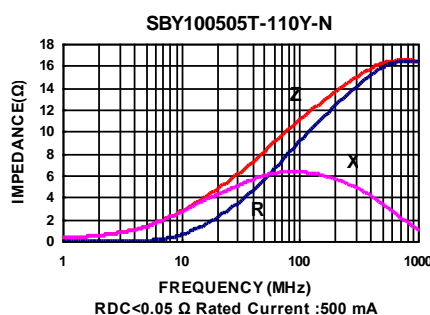
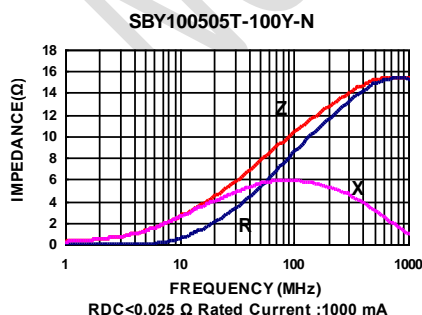

SMD Multilayer Ferrite Chip Beads – SBY/SBK Series

Test Instruments : Agilent E4991A Impedance / Material Analyzer

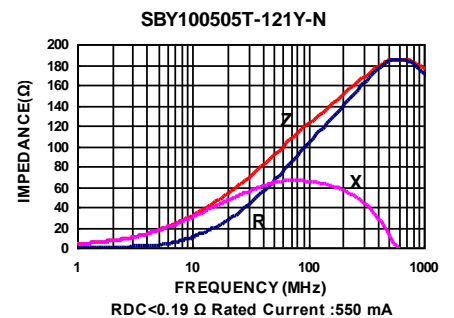
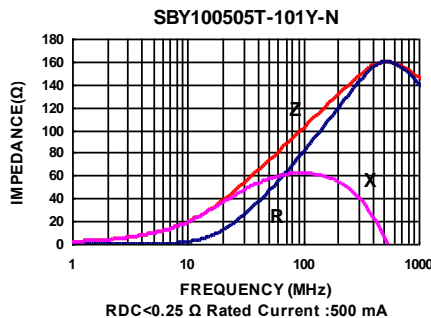
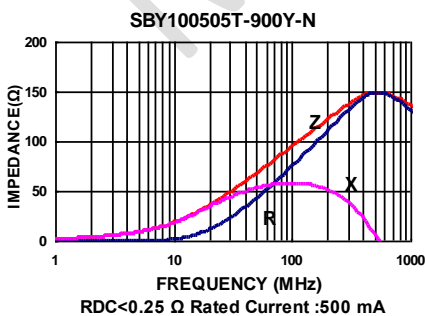
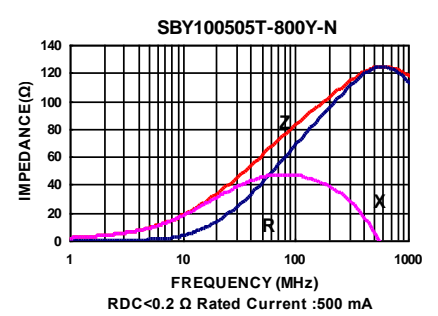
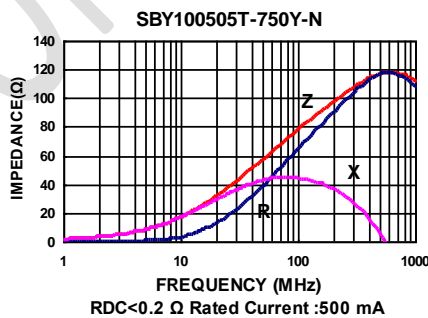
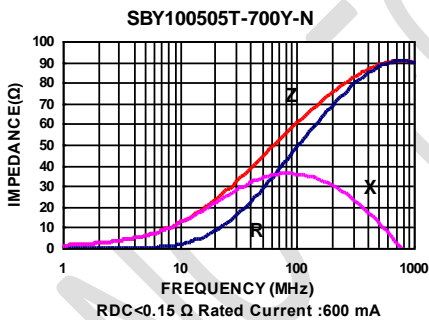
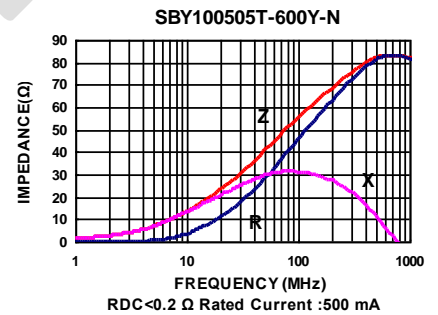
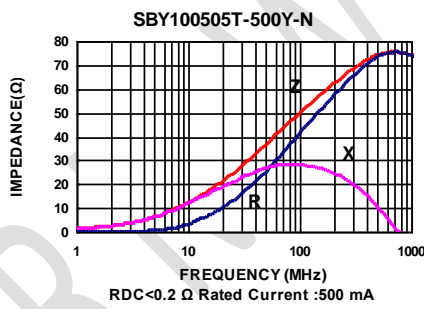
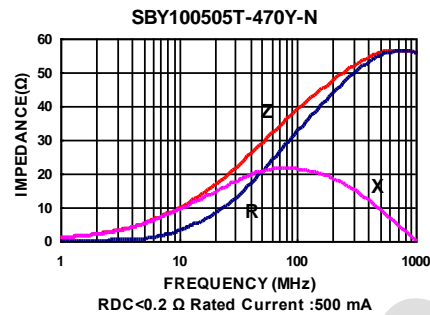
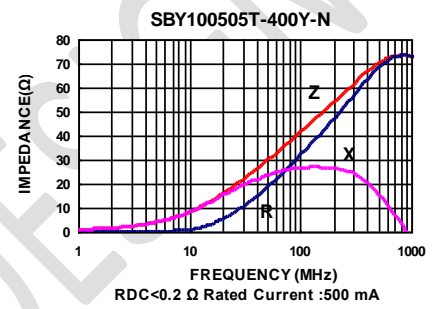
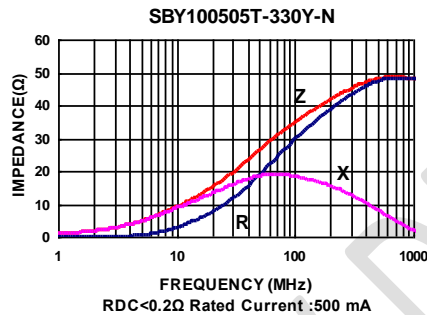
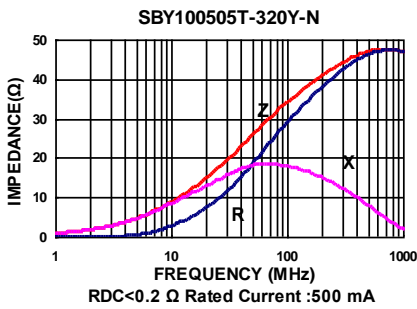
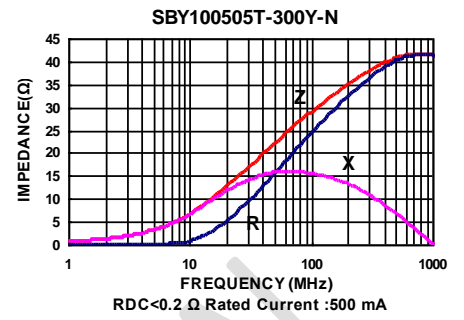
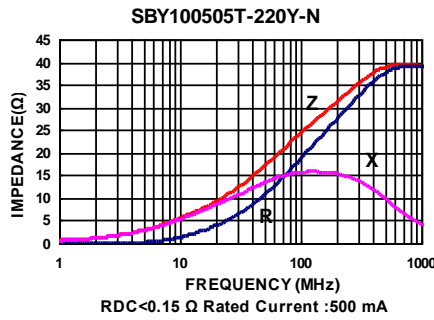
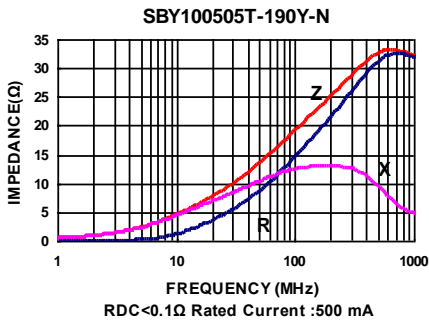

Please be sure to request approval specifications that provide further details of the products. Kindly note that the content of these specifications are subject to change or may be discontinued without prior notice. This product may not be designed/used in medical or high risk applications without Chilisin approval. Please contact our sales department before ordering.

SMD Multilayer Ferrite Chip Beads – SBY/SBK Series

Test Instruments : Agilent E4991A Impedance / Material Analyzer

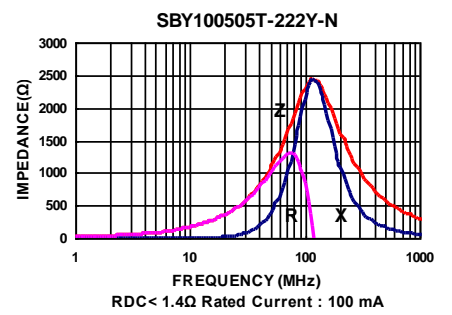
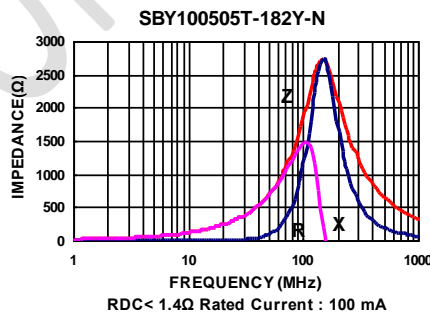
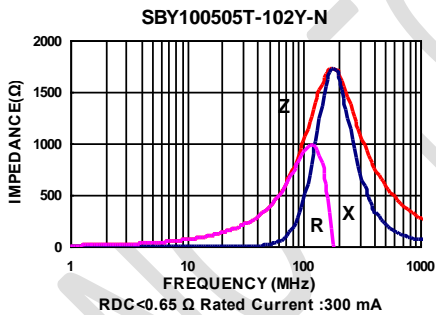
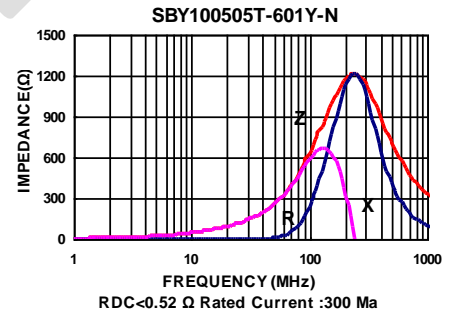
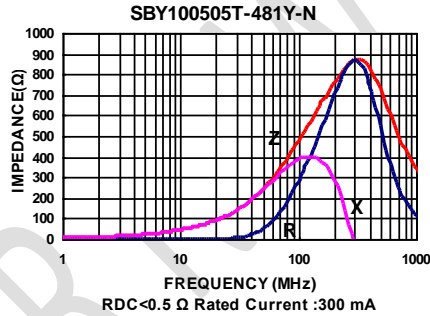
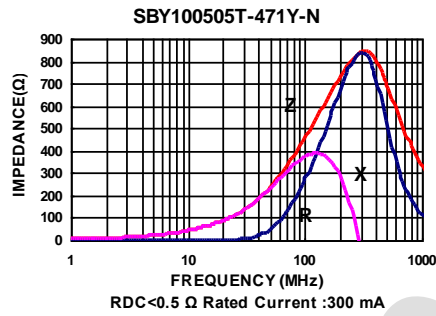
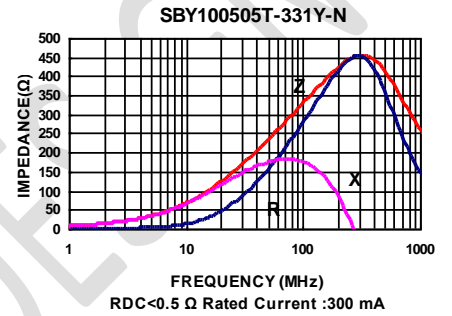
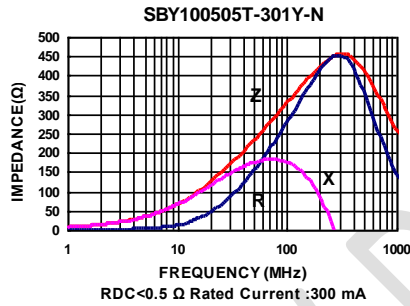
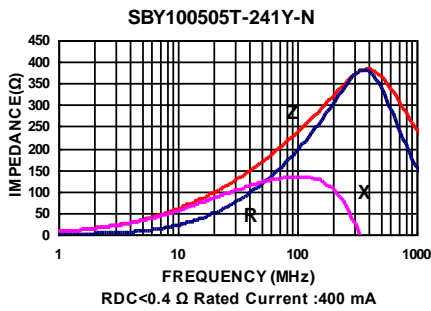
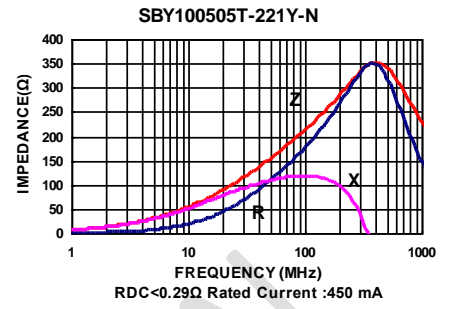
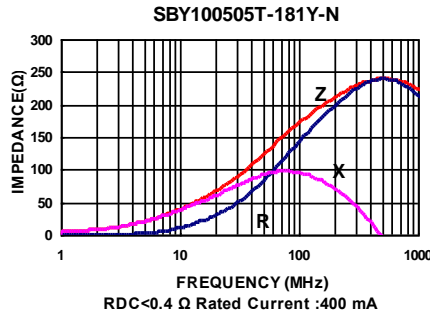
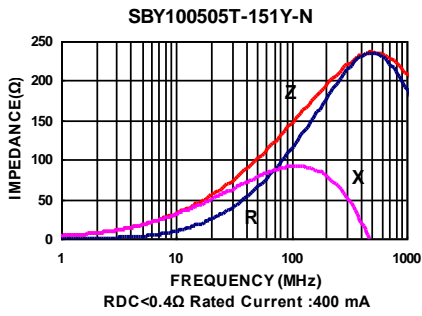

Please be sure to request approval specifications that provide further details of the products. Kindly note that the content of these specifications are subject to change or may be discontinued without prior notice. This product may not be designed/used in medical or high risk applications without Chilisin approval. Please contact our sales department before ordering.

SMD Multilayer Ferrite Chip Beads – SBY/SBK Series

Electrical Characteristics

| Part Number | Impedance ($\Omega \pm 25\%$) | Test Frequency (MHz) | RDC (Ω) Max | Rated current (mA) Max |
|-------------------|------------------------------------|-------------------------|-------------------------|---------------------------|
| SBK160808T-100Y-N | 10 | 100 | 0.05 | 500 |
| SBK160808T-110Y-N | 11 | 100 | 0.05 | 500 |
| SBK160808T-300Y-N | 30 | 100 | 0.10 | 400 |
| SBK160808T-310Y-N | 31 | 100 | 0.10 | 400 |
| SBK160808T-600Y-N | 60 | 100 | 0.10 | 400 |
| SBK160808T-800Y-N | 80 | 100 | 0.15 | 400 |
| SBK160808T-121Y-N | 120 | 100 | 0.25 | 400 |
| SBK160808T-221Y-N | 220 | 100 | 0.30 | 300 |
| SBK160808T-301Y-N | 300 | 100 | 0.40 | 300 |
| SBK160808T-471Y-N | 470 | 100 | 0.50 | 300 |
| SBK160808T-601Y-N | 600 | 100 | 0.50 | 300 |
| SBK160808T-102Y-N | 1000 | 100 | 0.60 | 300 |
| SBK160808T-152Y-N | 1500 | 100 | 0.60 | 300 |
| SBK160808T-182Y-N | 1800 | 100 | 0.80 | 200 |
| SBK160808T-202Y-N | 2000 | 100 | 0.80 | 200 |
| SBK160808T-222Y-N | 2200 | 100 | 0.80 | 200 |
| SBK160808T-252Y-N | 2500 | 100 | 0.80 | 200 |
| SBK160808T-272Y-N | 2700 | 100 | 0.80 | 200 |

Note: When ordering, please specify tolerance code. Tolerance : Y= $\pm 25\%$

- Operating temperature range - 55°C ~ 125°C(Including self - temperature rise)
- Rate Current : Applied the current to coils, the temperature rise shall not be more than 30°C
- Measure Equipment :
Z : HP4291A
RDC : HP4338B or CHEN HWA 502

Test Instruments : Agilent E4991A Impedance / Material Analyzer

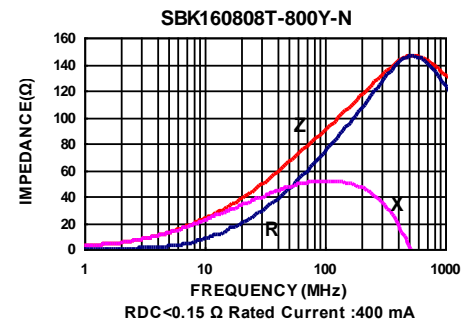
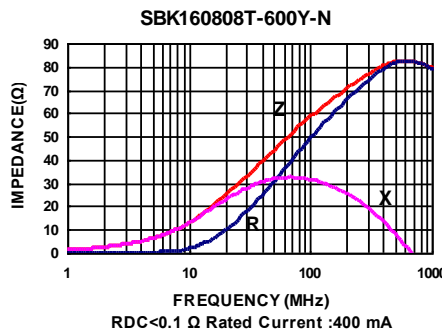
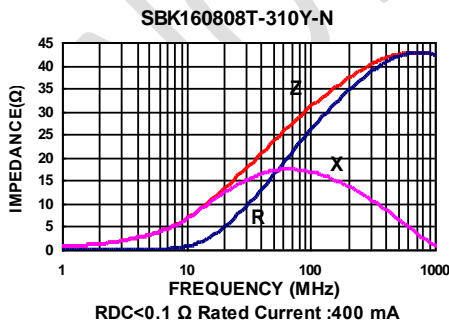
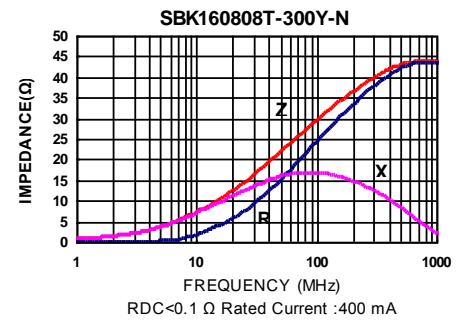
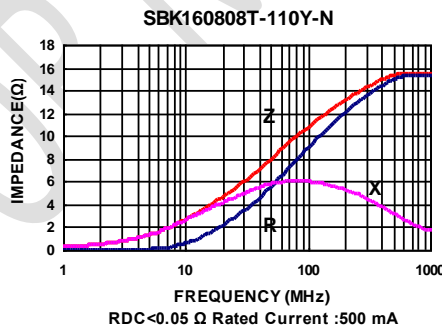
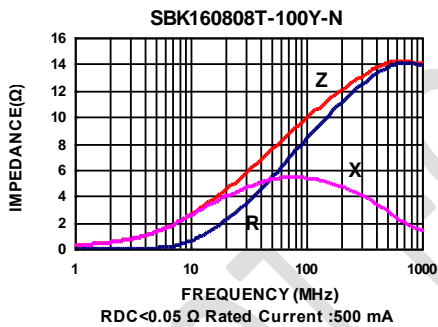

SMD Multilayer Ferrite Chip Beads – SBY/SBK Series

Test Instruments : Agilent E4991A Impedance / Material Analyzer

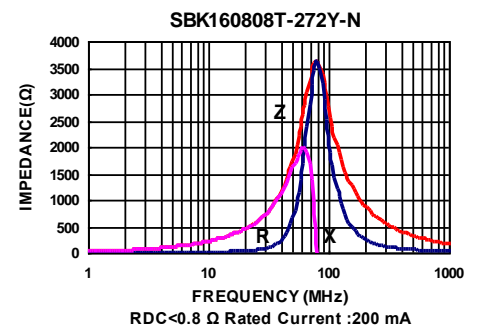
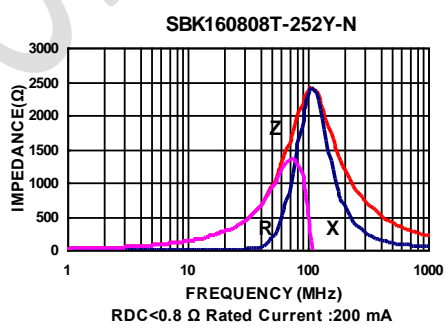
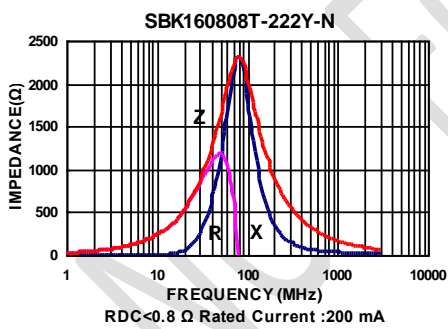
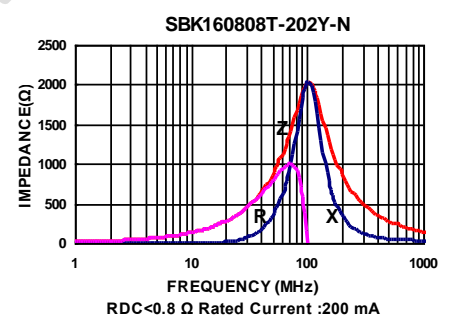
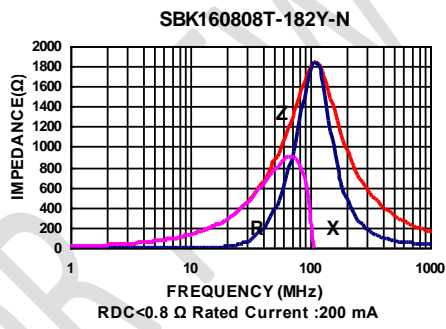
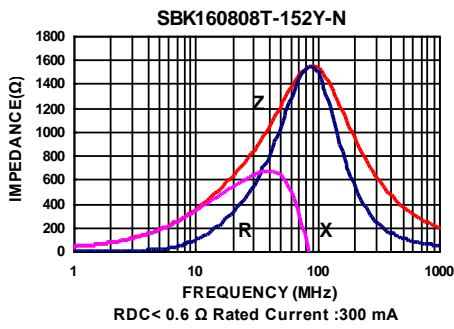
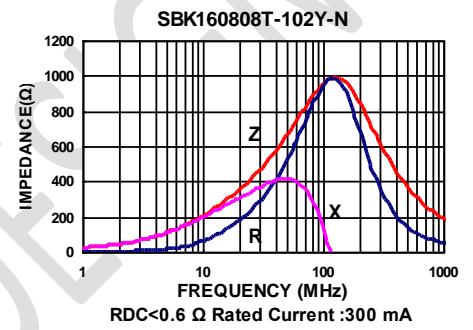
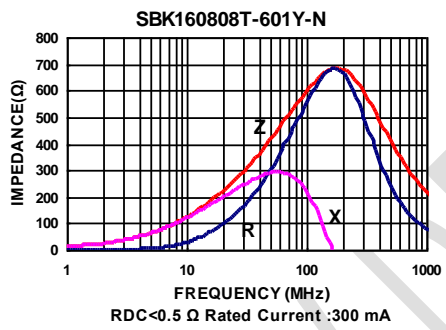
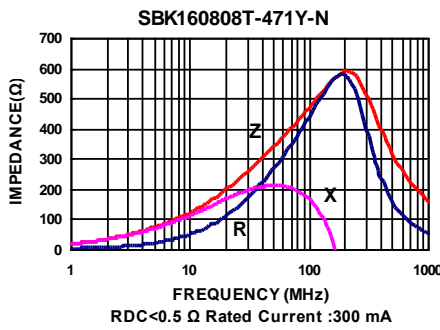
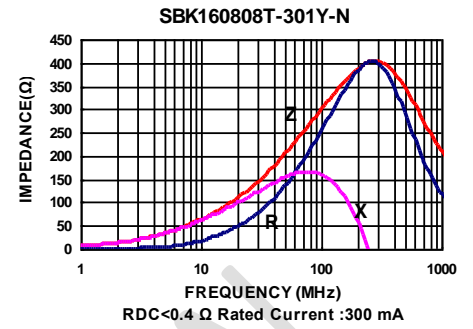
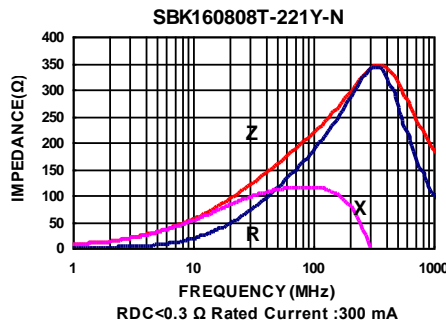
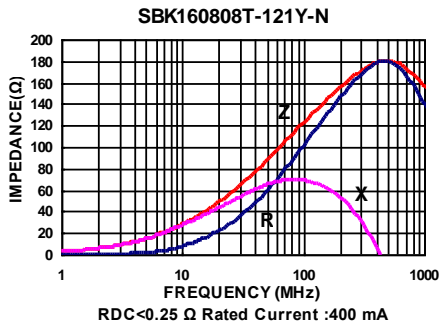

Please be sure to request approval specifications that provide further details of the products. Kindly note that the content of these specifications are subject to change or may be discontinued without prior notice. This product may not be designed/used in medical or high risk applications without Chilisin approval. Please contact our sales department before ordering.

SMD Multilayer Ferrite Chip Beads – SBY/SBK Series

Electrical Characteristics

| Part Number | Impedance ($\Omega \pm 25\%$) | Test Frequency (MHz) | DC Resistance (Ω) Max | Rated current (mA) Max |
|-------------------|------------------------------------|-------------------------|-----------------------------------|---------------------------|
| SBK201209T-600Y-N | 60 | 100 | 0.15 | 500 |
| SBK201209T-800Y-N | 80 | 100 | 0.15 | 500 |
| SBK201209T-121Y-N | 120 | 100 | 0.25 | 300 |
| SBK201209T-221Y-N | 220 | 100 | 0.30 | 300 |
| SBK201209T-301Y-N | 300 | 100 | 0.30 | 300 |
| SBK201209T-431Y-N | 430 | 100 | 0.40 | 300 |
| SBK201209T-471Y-N | 470 | 100 | 0.40 | 300 |
| SBK201209T-601Y-N | 600 | 100 | 0.40 | 300 |
| SBK201209T-102Y-N | 1000 | 100 | 0.50 | 200 |
| SBK201209T-122Y-N | 1200 | 100 | 0.60 | 200 |
| SBK201209T-152Y-N | 1500 | 100 | 0.60 | 200 |
| SBK201209T-202Y-N | 2000 | 100 | 0.70 | 200 |
| SBK201209T-222Y-N | 2200 | 100 | 0.70 | 200 |
| SBK201209T-252Y-N | 2500 | 100 | 0.70 | 200 |
| SBK201209T-272Y-N | 2700 | 100 | 0.70 | 200 |

Note: When ordering, please specify tolerance code. Tolerance : Y= $\pm 25\%$

- Operating temperature range - 55°C ~ 125°C(Including self - temperature rise)
- Rate Current : Applied the current to coils, the temperature rise shall not be more than 30°C
- Measure Equipment :
Z : HP4291A
RDC : HP4338B or CHEN HWA 502

Test Instruments : Agilent E4991A Impedance / Material Analyzer

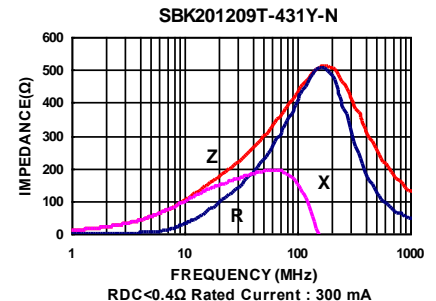
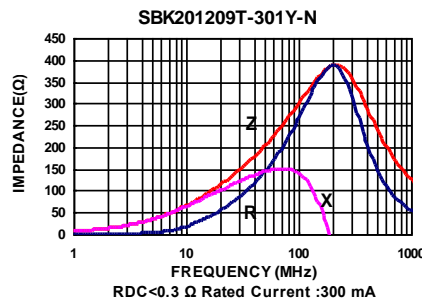
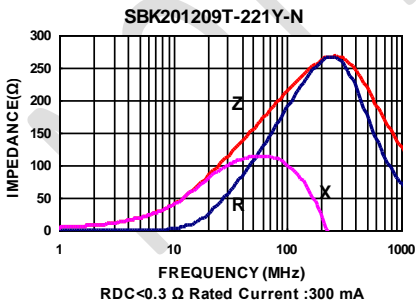
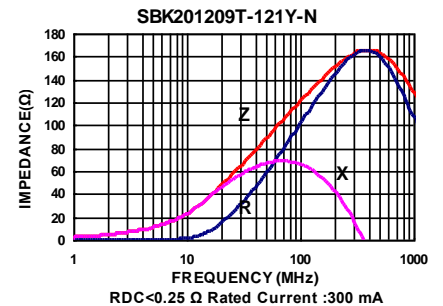
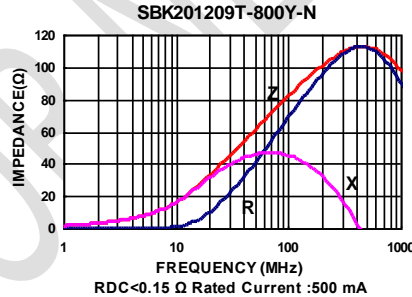
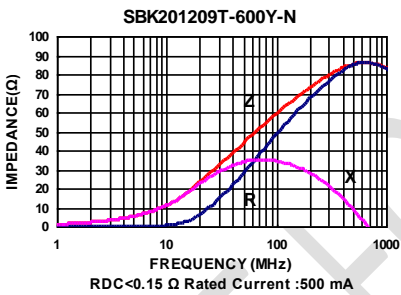

SMD Multilayer Ferrite Chip Beads – SBY/SBK Series

Test Instruments : Agilent E4991A Impedance / Material Analyzer

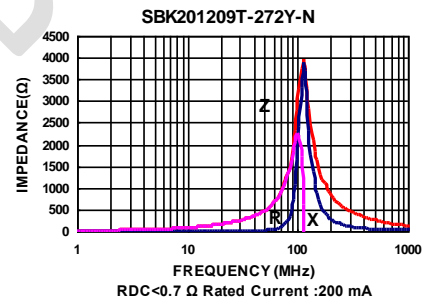
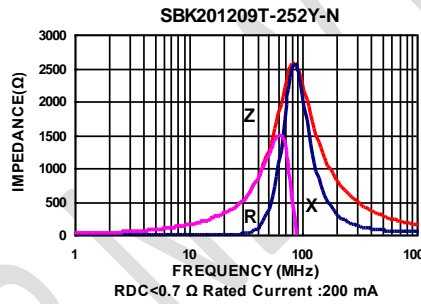
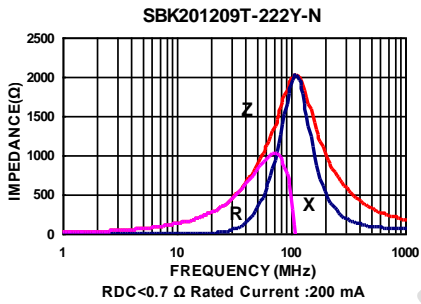
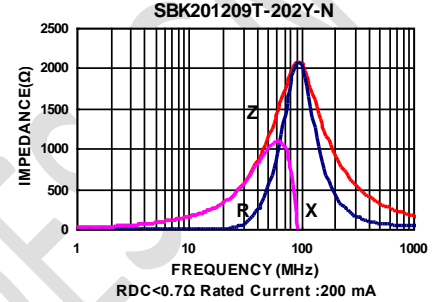
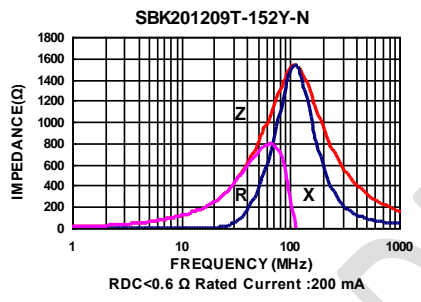
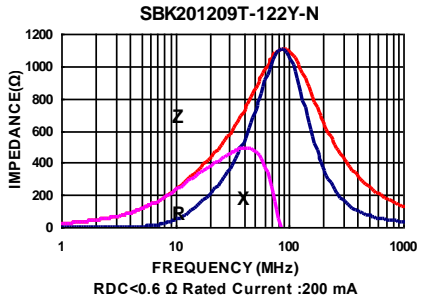
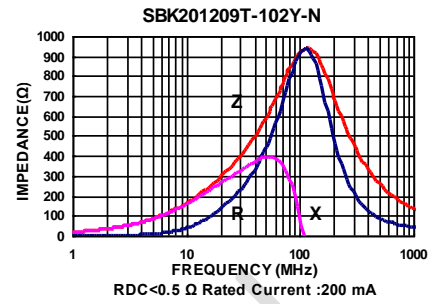
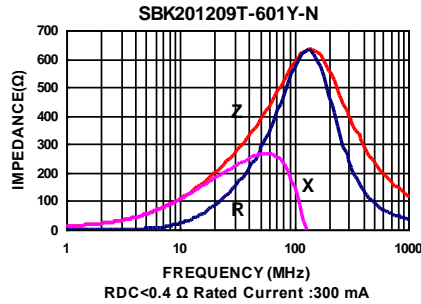
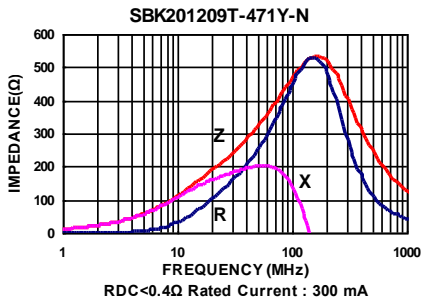

Please be sure to request approval specifications that provide further details of the products. Kindly note that the content of these specifications are subject to change or may be discontinued without prior notice. This product may not be designed/used in medical or high risk applications without Chilisin approval. Please contact our sales department before ordering.

SMD Multilayer Ferrite Chip Beads – SBY/SBK Series

Electrical Characteristics

| Part Number | Impedance ($\Omega \pm 25\%$) | Test Frequency (MHz) | RDC (Ω) Max | Rated current (mA) Max |
|-------------------|------------------------------------|-------------------------|-------------------------|---------------------------|
| SBK321611T-900Y-N | 90 | 100 | 0.15 | 500 |
| SBK321611T-121Y-N | 120 | 100 | 0.15 | 500 |
| SBK321611T-471Y-N | 470 | 100 | 0.20 | 400 |
| SBK321611T-601Y-N | 600 | 100 | 0.30 | 400 |
| SBK321611T-102Y-N | 1000 | 50 | 0.40 | 200 |
| SBK321611T-122Y-N | 1200 | 50 | 0.40 | 200 |
| SBK321611T-152Y-N | 1500 | 50 | 0.45 | 200 |

Note: When ordering, please specify tolerance code. Tolerance : $Y \pm 25\%$

- Operating temperature range - 55°C ~ 125°C(Including self - temperature rise)
- Rate Current : Applied the current to coils, the temperature rise shall not be more than 30°C
- Measure Equipment :
Z : HP4291A
RDC : HP4338B or CHEN HWA 502

Test Instruments : Agilent E4991A Impedance / Material Analyzer

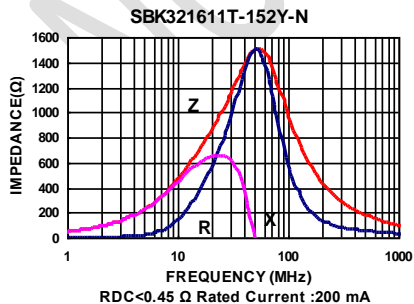
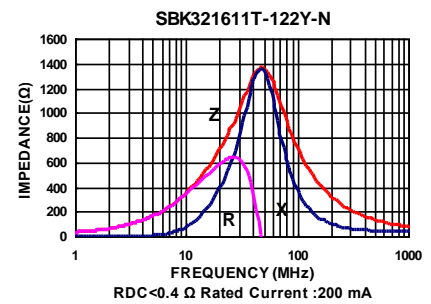
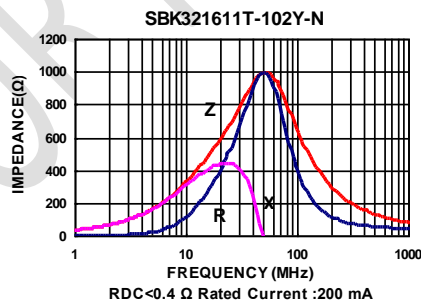
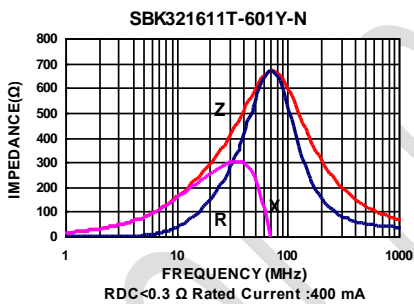
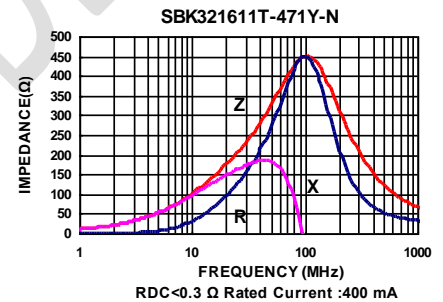
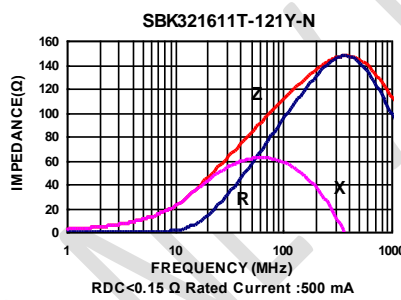
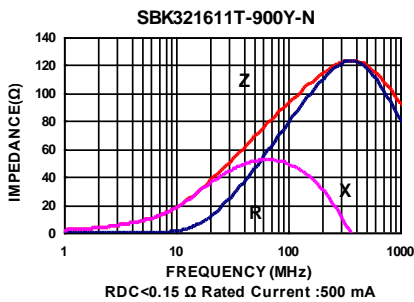

SMD Multilayer Chip Beads

Packaging Specifications

Tape Dimensions

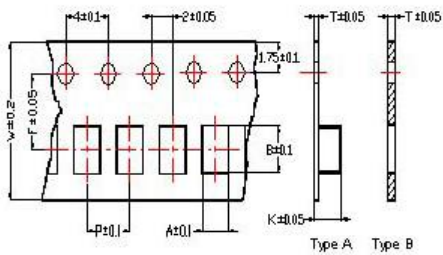

Tape Material

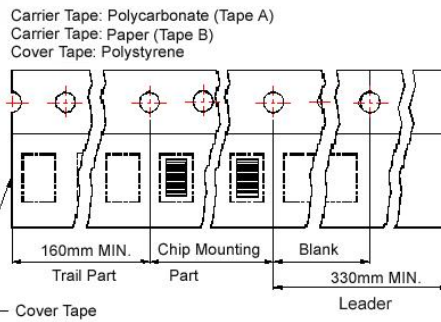

Reel Dimensions

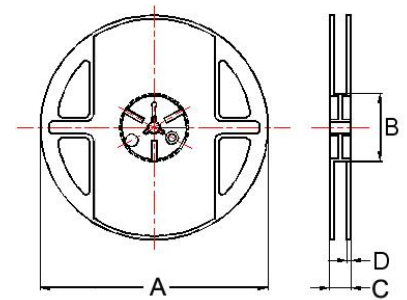

- ① : SBY / SBJ / NB / PB
- ② : SBY / SBJ / NB / PB / UPB / HF ③ : UPB
- ④ : SBK / SBJ / GB / PB / NB / UPB / VPB
- ⑤ : SBK / GB / PB / UPB ⑥ : SBY / SBK / PBY / UPB

Dimensions in mm

| TYPE | Tape Dimensions | | | | | | | | Reel Dimensions | | | | Quantity PCS / REEL |
|---------|-----------------|------|------|-----|-----|-----|------|------|-----------------|----|----|---|------------------------|
| | A | B | T | W | P | F | K | Tape | A | B | C | D | |
| ①060303 | 0.37 | 0.67 | 0.42 | 8.0 | 2.0 | 3.5 | - | B | 178 | 60 | 10 | 2 | 15000 |
| ②100505 | 0.62 | 1.12 | 0.60 | 8.0 | 2.0 | 3.5 | - | B | 178 | 60 | 12 | 2 | 10000 |
| ③160805 | 1.05 | 1.85 | 0.60 | 8.0 | 2.0 | 3.5 | - | B | 178 | 60 | 12 | 2 | 10000 |
| ④160808 | 1.05 | 1.85 | 0.95 | 8.0 | 4.0 | 3.5 | - | B | 178 | 60 | 12 | 2 | 4000 |
| ⑤201209 | 1.50 | 2.30 | 0.97 | 8.0 | 4.0 | 3.5 | - | B | 178 | 60 | 12 | 2 | 4000 |
| ⑥321611 | 1.88 | 3.50 | 0.22 | 8.0 | 4.0 | 3.5 | 1.27 | A | 178 | 60 | 12 | 2 | 3000 |

X-ON Electronics

Largest Supplier of Electrical and Electronic Components

Click to view similar products for [Ferrite Beads](#) category:

Click to view products by [Chilisin](#) manufacturer:

Other Similar products are found below :

[CZB1EGTTP700P](#) [CZB1JGTTD152P](#) [CZB1JGTTD601P](#) [CZB2AFTTD800P](#) [CZB2AGTTD121P](#) [CZB2AGTTD601P](#) [CZB2BFTTE600P](#)
[PE-0402FB121ST](#) [NCB0603R301TR050F](#) [NCB0805A320TR050F](#) [NCB-H1206B680TR300F](#) [SMB2.5-1TR](#) [SMB2.5R-2](#) [CZB1EGTTP121P](#)
[CZB1JGTTD102P](#) [CZB1JGTTD121P](#) [CZB1JGTTD221P](#) [CZB1JGTTD600P](#) [CZB2AGTTD301P](#) [CZB2BFTTE301P](#) [CZB2BFTTE601P](#)
[4221R-1](#) [4221R-2](#) [432703041971](#) [EMI0805R-2000](#) [EMI0805R-600](#) [SBY100505T-100Y-N](#) [NCB-GH0402D121TR060F](#) [NCB-](#)
[H1812D125TR150F](#) [CZB2AGTTD102P](#) [NCB0402P301TR005F](#) [NCB0603R152TR030F](#) [NCB0805A121TR050F](#) [NCB3312K900TR500F](#)
[NCB-H0805A102TR150F](#) [NCB-H0805A221TR300F](#) [NCB-H1806E181TR300F](#) [NCB0402P300TR030F](#) [NCB0402P700TR050F](#)
[NCB0805A102TR040F](#) [NCB1806E151TR020F](#) [NCB-H0603R121TR300F](#) [NCB-H0805A220TR600F](#) [NCB-H0805A390TR400F](#) [NCB-](#)
[H1206B121TR300F](#) [NCB-H1206B601TR200F](#) [CIM21J252NE](#) [EMI0805R-220](#) [74279250](#) [7427924](#)