



Inductive Solution Provider for Power, EMI and RF.

Inductors SMD Components



Multilayer Power Inductors



The MPx Series is a miniature type of multilayer power inductor constructed using low-loss ferrite material to support high-speed switching frequencies. The compact size and high efficiency is ideal for DC-DC converter applications in space-limited boards.

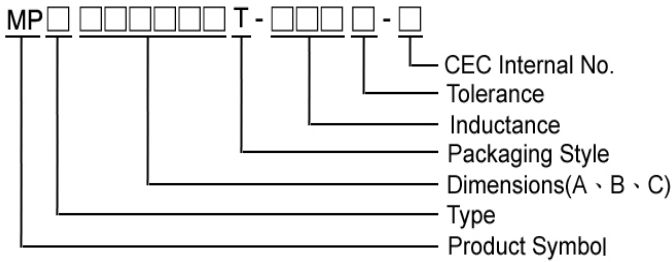
Features

- RoHS, Halogen Free and REACH Compliance
- Small size
- Low profile
- High current
- Magnetically shielded configuration allowing for high density mounting

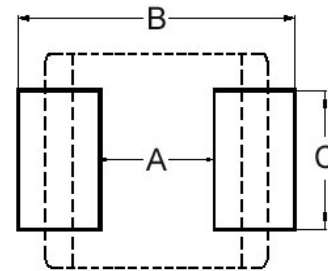
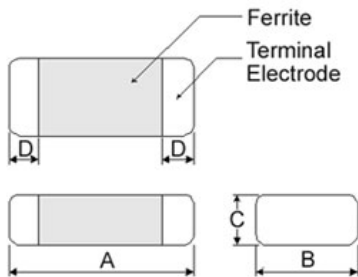
Applications

- DC-DC converters
- Power modules
- Cellular phones
- DSC, PND, DVD
- Wireless card and other electronic devices

Product Identification



- Product Symbol : MPA, MPB, MPE
- Type : A : General , B : Low RDC , E: High Isat
- Packaging : T : Tape and Reel , B : Bulk
- Tolerance : M = $\pm 20\%$, T = $\pm 30\%$



Dimensions in mm

| TYPE | A | B | C | D |
|--------|----------------|-----------------|----------------|---------------|
| 160805 | 1.6 \pm 0.15 | 0.8 \pm 0.15 | 0.5 \pm 0.05 | 0.3 \pm 0.2 |
| 160806 | 1.6 \pm 0.15 | 0.8 \pm 0.15 | 0.6 \pm 0.15 | 0.3 \pm 0.2 |
| 160808 | 1.6 \pm 0.15 | 0.8 \pm 0.15 | 0.8 \pm 0.15 | 0.3 \pm 0.2 |
| 201205 | 2.0 \pm 0.20 | 1.25 \pm 0.20 | 0.55 Max | 0.5 \pm 0.3 |
| 201210 | 2.0 \pm 0.20 | 1.25 \pm 0.20 | 1.0 Max | 0.5 \pm 0.3 |
| 201610 | 2.0 \pm 0.20 | 1.6 \pm 0.20 | 1.0 Max | 0.5 \pm 0.3 |
| 252010 | 2.5 \pm 0.20 | 2.0 \pm 0.20 | 1.0 Max | 0.6 \pm 0.2 |
| 252012 | 2.5 \pm 0.20 | 2.0 \pm 0.20 | 1.2 Max | 0.6 \pm 0.2 |

Dimensions in mm

| TYPE | A | B | C |
|--------|-----------|-----------|-----------|
| 160805 | 0.7 ~ 0.8 | 1.8 ~ 2.0 | 0.6 ~ 0.8 |
| 160806 | 0.7 ~ 0.8 | 1.8 ~ 2.0 | 0.6 ~ 0.8 |
| 160808 | 0.7 ~ 0.8 | 1.8 ~ 2.0 | 0.6 ~ 0.8 |
| 201205 | 0.8 ~ 1.2 | 2.3 ~ 2.9 | 1.0 ~ 1.4 |
| 201210 | 0.8 ~ 1.2 | 2.3 ~ 2.9 | 1.0 ~ 1.4 |
| 201610 | 0.8 ~ 1.2 | 2.1 ~ 2.7 | 1.6 ~ 2.0 |
| 252010 | 1.3 ~ 1.9 | 2.7 ~ 3.5 | 2.0 ~ 2.6 |
| 252012 | 1.3 ~ 1.9 | 2.7 ~ 3.5 | 2.0 ~ 2.6 |

Electrical Characteristics

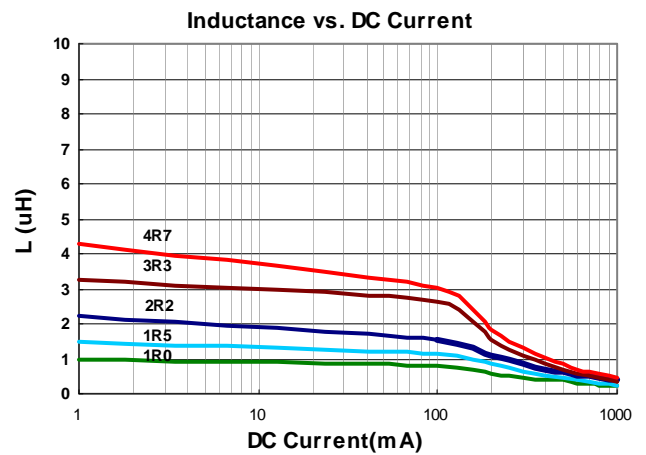
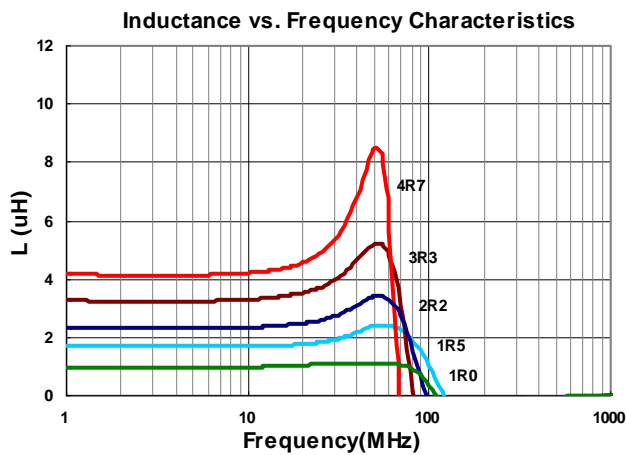
MPA : General Series

| Part Number | Inductance (uH) | Tolerance (±%) | Test Frequency (MHz) | RDC (Ω) ±30% | Rated current (mA) Max |
|-------------------|-----------------|----------------|----------------------|--------------|------------------------|
| MPA201210T-1R0□-N | 1.0 | 20, 30 | 1 | 0.18 | 1100 |
| MPA201210T-1R5□-N | 1.5 | 20, 30 | 1 | 0.19 | 1000 |
| MPA201210T-2R2□-N | 2.2 | 20, 30 | 1 | 0.22 | 900 |
| MPA201210T-3R3□-N | 3.3 | 20, 30 | 1 | 0.25 | 700 |
| MPA201210T-4R7□-N | 4.7 | 20, 30 | 1 | 0.35 | 600 |

Note: When ordering, please specify tolerance code. Tolerance: M=±20% , T=±30%

- Operating temperature range - 55°C ~ 125°C(Including self - temperature rise)
- Rated Current for a 40°C temperature rise from 25°C ambient with current
- Measure Equipment :
 L : Agilent HP4287A+16197A, 1MHz 200mV
 RDC : HP 4338B, or equivalent

Test Instruments : HP4287A Inductance / Material Analyzer



Electrical Characteristics

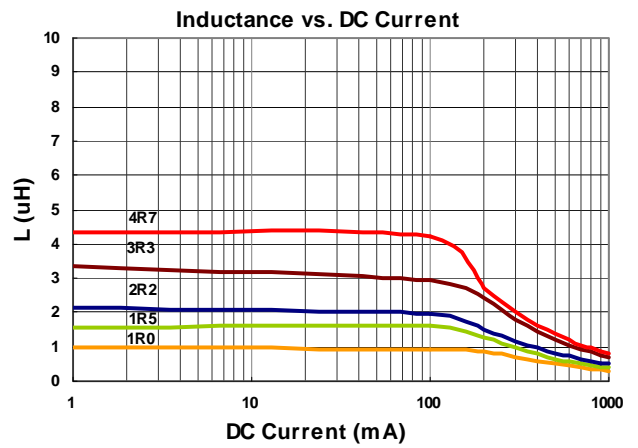
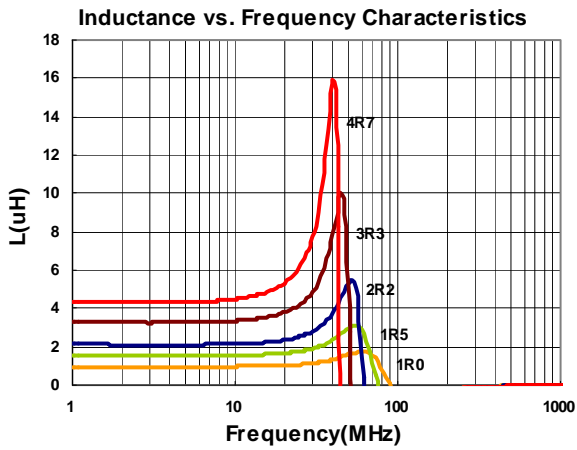
MPA : General Series

| Part Number | Inductance (uH) | Tolerance (±%) | Test Frequency (MHz) | RDC (Ω) ±30% | Rated current (mA) Max |
|-------------------|-----------------|----------------|----------------------|--------------|------------------------|
| MPA252010T-1R0□-N | 1.0 | 20, 30 | 1 | 0.11 | 1200 |
| MPA252010T-1R5□-N | 1.5 | 20, 30 | 1 | 0.13 | 1100 |
| MPA252010T-2R2□-N | 2.2 | 20, 30 | 1 | 0.15 | 1000 |
| MPA252010T-3R3□-N | 3.3 | 20, 30 | 1 | 0.18 | 1000 |
| MPA252010T-4R7□-N | 4.7 | 20, 30 | 1 | 0.25 | 900 |

Note: When ordering, please specify tolerance code. Tolerance: M=±20% , T=±30%

- Operating temperature range - 55°C ~ 125°C(Including self - temperature rise)
- Rated Current for a 40°C temperature rise from 25°C ambient with current
- Measure Equipment :
 L : Agilent HP4287A+16197A, 1MHz 200mV
 RDC : HP 4338B, or equivalent

Test Instruments : HP4287A Inductance / Material Analyzer



Electrical Characteristics

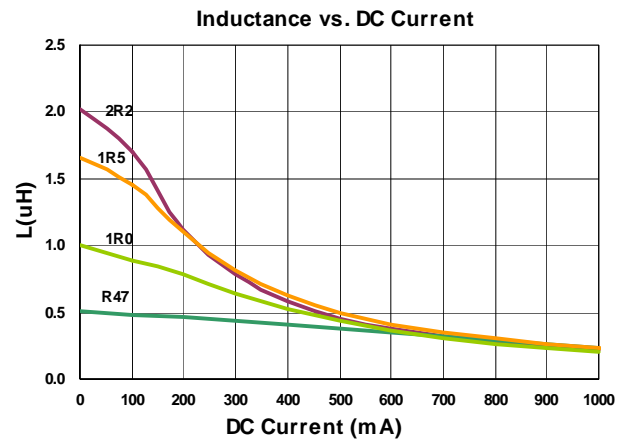
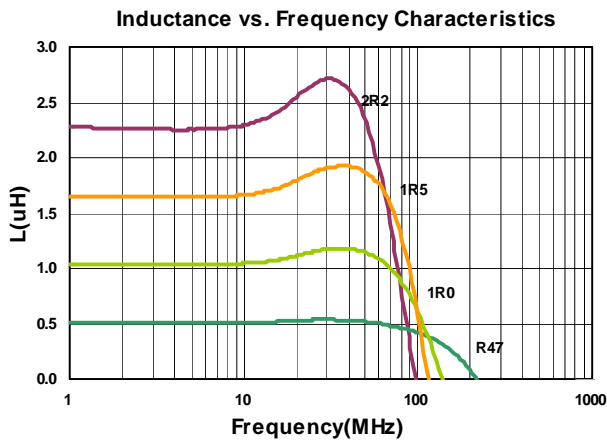
MPB : Low Profile Series

| Part Number | Inductance (uH) | Tolerance (±%) | Test Frequency (MHz) | RDC (Ω) ±25% | Isat (mA) Max | Irms (mA) Max |
|---------------------|-----------------|----------------|----------------------|--------------|---------------|---------------|
| MPB160805T-R47□-NA6 | 0.47 | 20, 30 | 3 | 0.15 | 420 | 1200 |
| MPB160805T-1R0□-NA6 | 1.0 | 20, 30 | 3 | 0.20 | 180 | 1200 |
| MPB160805T-1R5□-NA6 | 1.5 | 20, 30 | 3 | 0.22 | 130 | 1000 |
| MPB160805T-2R2□-NA6 | 2.2 | 20, 30 | 3 | 0.24 | 100 | 1000 |

Note: When ordering, please specify tolerance code. Tolerance: M=±20% , T=±30%

- Operating temperature range - 55°C ~ 125°C(Including self - temperature rise)
- Isat for Inductance drop 30% from its value without current
- I rms for a 40°C temperature rise from 25°C ambient with current
- Measure Equipment :
 L : Agilent HP4287A+16197A, 3MHz 200mV
 RDC : HP 4338B, or equivalent

Test Instruments : HP4287A Inductance / Material Analyzer



Electrical Characteristics

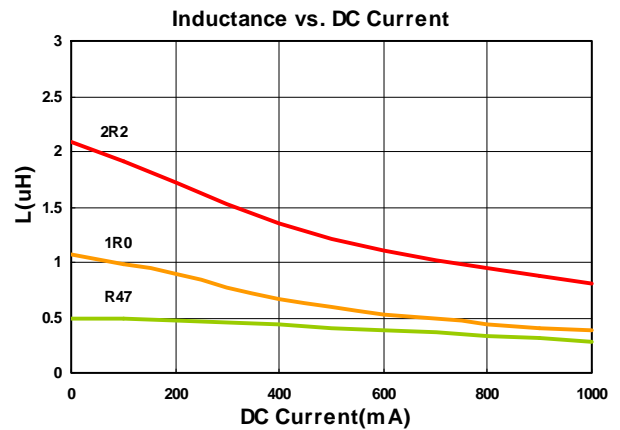
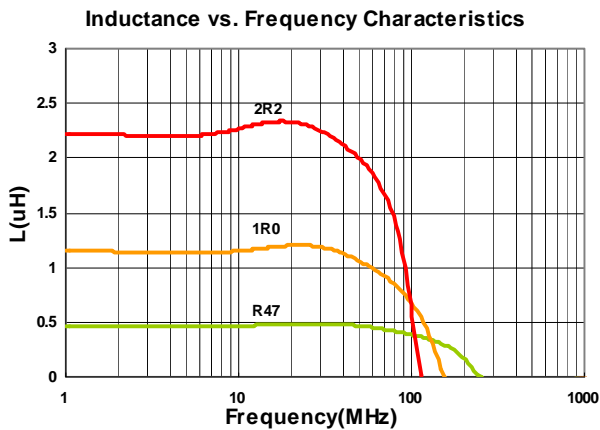
MPB : Low RDC Series

| Part Number | Inductance (uH) | Tolerance (±%) | Test Frequency (MHz) | RDC (Ω) ±30% | Isat (mA) Max | Irms (mA) Max |
|---------------------|-----------------|----------------|----------------------|--------------|---------------|---------------|
| MPB160808T-R47□-NA2 | 0.47 | 20, 30 | 3 | 0.15 | 400 | 1100 |
| MPB160808T-1R0□-NA2 | 1.0 | 20, 30 | 3 | 0.20 | 200 | 950 |
| MPB160808T-2R2□-NA2 | 2.2 | 20, 30 | 3 | 0.30 | 150 | 750 |

Note: When ordering, please specify tolerance code. Tolerance: M=±20% , T=±30%

- Operating temperature range - 55°C ~ 125°C(Including self - temperature rise)
- Isat for Inductance drop 30% from its value without current
- I rms for a 40°C temperature rise from 25°C ambient with current
- Measure Equipment :
 L : Agilent HP4287A+16197A, 3MHz 200mV
 RDC : HP 4338B, or equivalent

Test Instruments : HP4287A Inductance / Material Analyzer



Electrical Characteristics

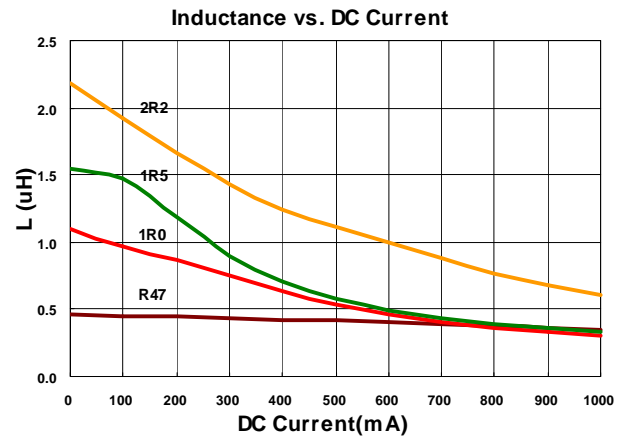
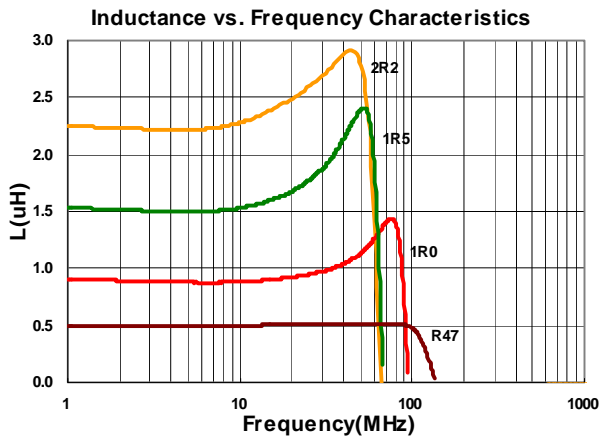
MPB : Low Profile Series

| Part Number | Inductance (uH) | Tolerance (±%) | Test Frequency (MHz) | RDC (Ω) ±30% | Isat (mA) Max | Irms (mA) Max |
|---------------------|-----------------|----------------|----------------------|--------------|---------------|---------------|
| MPB201205T-R47□-NA2 | 0.47 | 20, 30 | 3 | 0.11 | 900 | 1200 |
| MPB201205T-1R0□-NA2 | 1.0 | 20, 30 | 3 | 0.16 | 300 | 900 |
| MPB201205T-1R5□-NA2 | 1.5 | 20, 30 | 3 | 0.18 | 250 | 800 |
| MPB201205T-2R2□-NA2 | 2.2 | 20, 30 | 3 | 0.29 | 200 | 600 |
| MPB201205T-4R7□-NA2 | 4.7 | 20, 30 | 3 | 0.50 | 100 | 700 |

Note: When ordering, please specify tolerance code. Tolerance: M=±20% , T=±30%

- Operating temperature range - 55°C ~ 125°C(Including self - temperature rise)
- Isat for Inductance drop 30% from its value without current
- I rms for a 40°C temperature rise from 25°C ambient with current
- Measure Equipment :
L : Agilent HP4287A+16197A, 3MHz 200mV
RDC : HP 4338B, or equivalent

Test Instruments : HP4287A Inductance / Material Analyzer



Electrical Characteristics

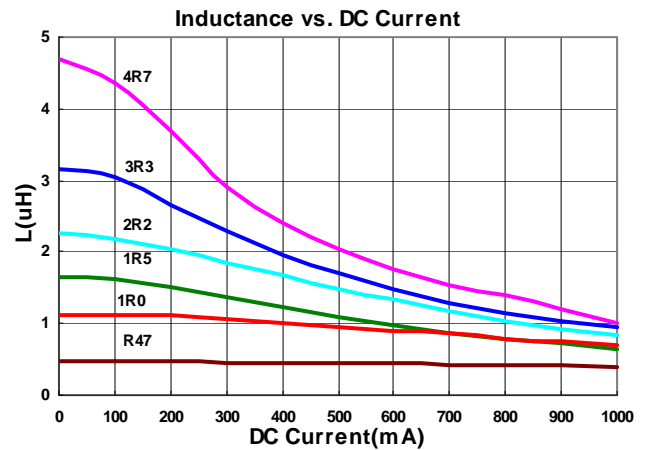
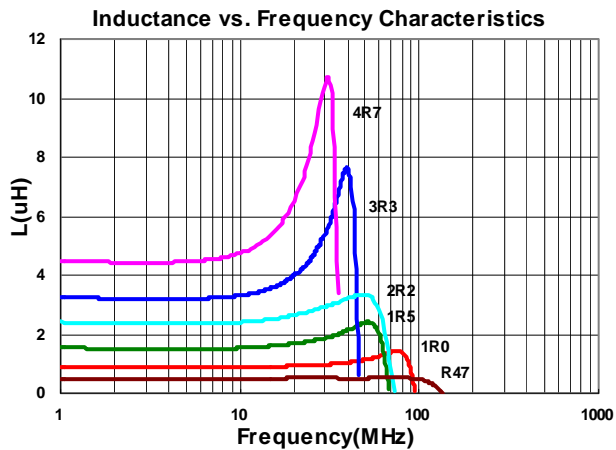
MPB : Low RDC Series

| Part Number | Inductance (uH) | Tolerance (±%) | Test Frequency (MHz) | RDC (Ω) ±30% | Isat (mA) Max | Irms (mA) Max |
|---------------------|-----------------|----------------|----------------------|--------------|---------------|---------------|
| MPB201210T-R47□-NA2 | 0.47 | 20, 30 | 3 | 0.09 | 1100 | 1300 |
| MPB201210T-1R0□-NA2 | 1.0 | 20, 30 | 3 | 0.12 | 650 | 1200 |
| MPB201210T-1R5□-NA2 | 1.5 | 20, 30 | 3 | 0.15 | 450 | 1100 |
| MPB201210T-2R2□-NA2 | 2.2 | 20, 30 | 3 | 0.19 | 400 | 1100 |
| MPB201210T-3R3□-NA2 | 3.3 | 20, 30 | 3 | 0.24 | 300 | 800 |
| MPB201210T-4R7□-NA2 | 4.7 | 20, 30 | 3 | 0.26 | 200 | 700 |

Note: When ordering, please specify tolerance code. Tolerance: M=±20% , T=±30%

- Operating temperature range - 55°C ~ 125°C(Including self - temperature rise)
- Isat for Inductance drop 30% from its value without current
- Irms for a 40°C temperature rise from 25°C ambient with current
- Measure Equipment :
 L : Agilent HP4287A+16197A, 3MHz 200mV
 RDC : HP 4338B, or equivalent

Test Instruments : HP4287A Inductance / Material Analyzer



Electrical Characteristics

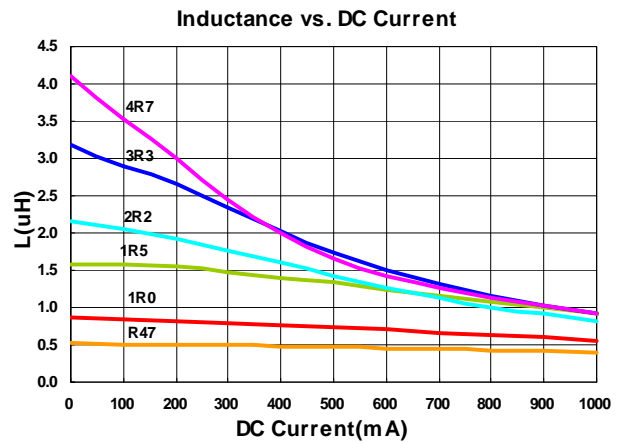
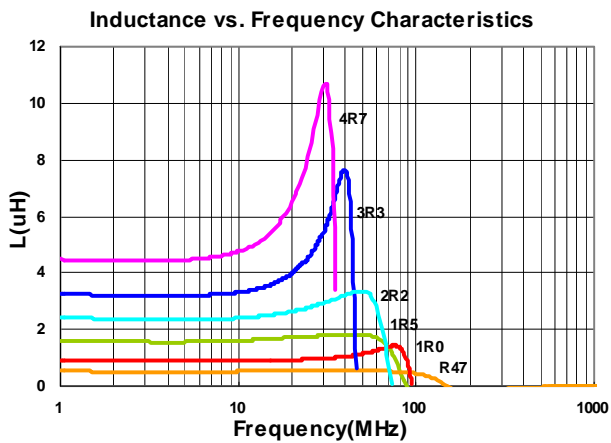
MPB : Low RDC Series

| Part Number | Inductance (uH) | Tolerance (±%) | Test Frequency (MHz) | RDC (Ω) ±25% | Isat (mA) Max | Irms (mA) Max |
|---------------------|-----------------|----------------|----------------------|--------------|---------------|---------------|
| MPB201610T-R47□-NA6 | 0.47 | 20, 30 | 3 | 0.06 | 1200 | 1600 |
| MPB201610T-1R0□-NA6 | 1.0 | 20, 30 | 3 | 0.085 | 850 | 1300 |
| MPB201610T-1R5□-NA6 | 1.5 | 20, 30 | 3 | 0.11 | 600 | 1200 |
| MPB201610T-2R2□-NA6 | 2.2 | 20, 30 | 3 | 0.11 | 400 | 1200 |
| MPB201610T-3R3□-NA6 | 3.3 | 20, 30 | 3 | 0.12 | 350 | 850 |
| MPB201610T-4R7□-NA6 | 4.7 | 20, 30 | 3 | 0.14 | 200 | 1100 |

Note: When ordering, please specify tolerance code. Tolerance: M=±20% , T=±30%

- Operating temperature range - 55°C ~ 125°C(Including self - temperature rise)
- Isat for Inductance drop 30% from its value without current
- Irms for a 40°C temperature rise from 25°C ambient with current
- Measure Equipment :
 L : Agilent HP4287A+16197A, 3MHz 200mV
 RDC : HP 4338B, or equivalent

Test Instruments : HP4287A Inductance / Material Analyzer



Electrical Characteristics

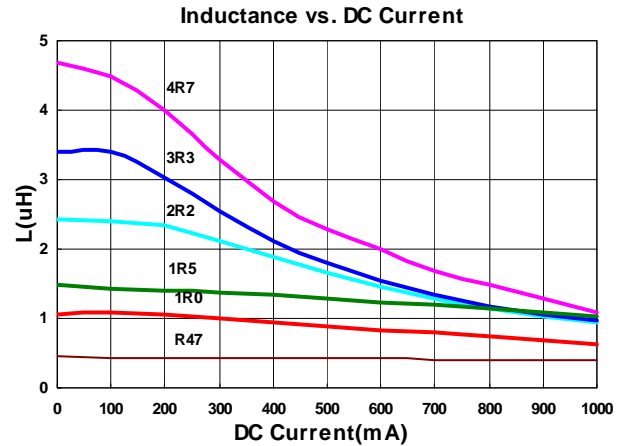
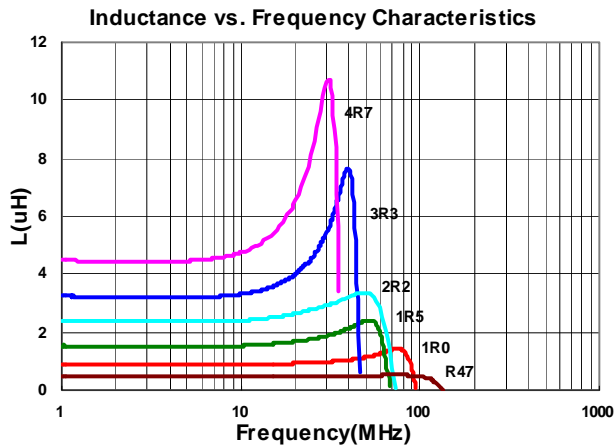
MPB : Low RDC Series

| Part Number | Inductance (uH) | Tolerance (±%) | Test Frequency (MHz) | RDC (Ω) ±25% | Isat (mA) Max | Irms (mA) Max |
|---------------------|-----------------|----------------|----------------------|--------------|---------------|---------------|
| MPB252010T-R47□-NA6 | 0.47 | 20, 30 | 3 | 0.04 | 1500 | 1800 |
| MPB252010T-1R0□-NA6 | 1.0 | 20, 30 | 3 | 0.055 | 900 | 1600 |
| MPB252010T-1R5□-NA2 | 1.5 | 20, 30 | 3 | 0.07±30% | 800 | 1400 |
| MPB252010T-2R2□-NA6 | 2.2 | 20, 30 | 3 | 0.08 | 500 | 1300 |
| MPB252010T-3R3□-NA6 | 3.3 | 20, 30 | 3 | 0.10 | 400 | 1200 |
| MPB252010T-4R7□-NA6 | 4.7 | 20, 30 | 3 | 0.11 | 300 | 1100 |

Note: When ordering, please specify tolerance code. Tolerance: M=±20% , T=±30%

- Operating temperature range - 55°C ~ 125°C(Including self - temperature rise)
- Isat for Inductance drop 30% from its value without current
- Irms for a 40°C temperature rise from 25°C ambient with current
- Measure Equipment :
 L : Agilent HP4287A+16197A, 3MHz 200mV
 RDC : HP 4338B, or equivalent

Test Instruments : HP4287A Inductance / Material Analyzer



Please be sure to request approval specifications that provide further details of the products. Kindly note that the content of these specifications are subject to change or may be discontinued without advance notice. Please contact our sales department before ordering.

Electrical Characteristics

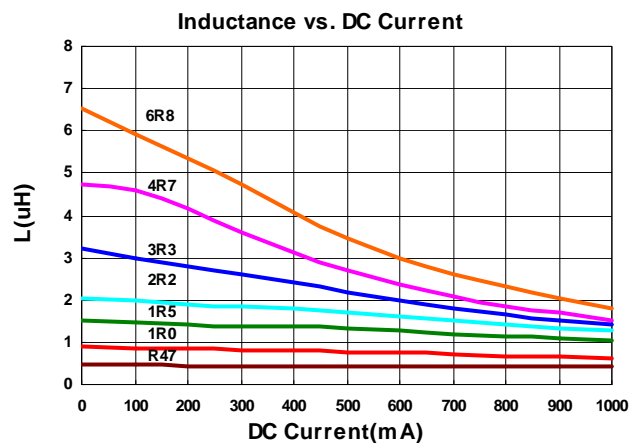
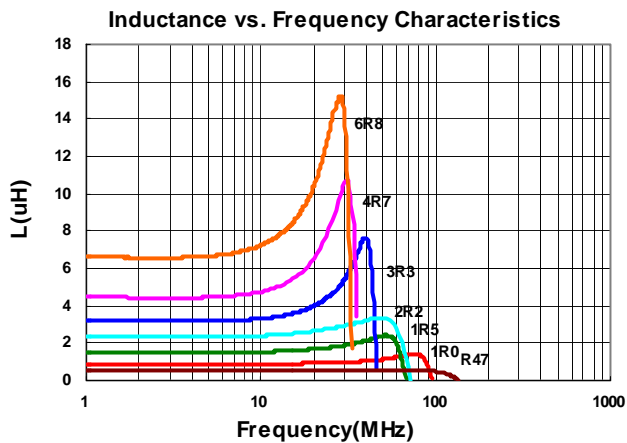
MPB : Low RDC Series

| Part Number | Inductance (uH) | Tolerance (±%) | Test Frequency (MHz) | RDC (Ω) ±30% | Isat (mA) Max | Irms (mA) Max |
|---------------------|-----------------|----------------|----------------------|--------------|---------------|---------------|
| MPB252012T-R47□-NA2 | 0.47 | 20, 30 | 3 | 0.04 | 1500 | 1800 |
| MPB252012T-1R0□-NA2 | 1.0 | 20, 30 | 3 | 0.05 | 950 | 1600 |
| MPB252012T-1R5□-NA2 | 1.5 | 20, 30 | 3 | 0.07 | 900 | 1400 |
| MPB252012T-2R2□-NA2 | 2.2 | 20, 30 | 3 | 0.10 | 700 | 1200 |
| MPB252012T-3R3□-NA2 | 3.3 | 20, 30 | 3 | 0.12 | 500 | 1100 |
| MPB252012T-4R7□-NA2 | 4.7 | 20, 30 | 3 | 0.14 | 350 | 1000 |
| MPB252012T-6R8□-NA2 | 6.8 | 20, 30 | 3 | 0.16 | 250 | 900 |

Note: When ordering, please specify tolerance code. Tolerance: M=±20% , T=±30%

- Operating temperature range - 55°C ~ 125°C(Including self - temperature rise)
- Isat for Inductance drop 30% from its value without current
- Irms for a 40°C temperature rise from 25°C ambient with current
- Measure Equipment :
 - L : Agilent HP4287A+16197A, 3MHz 200mV
 - RDC : HP 4338B, or equivalent

Test Instruments : HP4287A Inductance / Material Analyzer



Please be sure to request approval specifications that provide further details of the products. Kindly note that the content of these specifications are subject to change or may be discontinued without advance notice. Please contact our sales department before ordering.

Electrical Characteristics

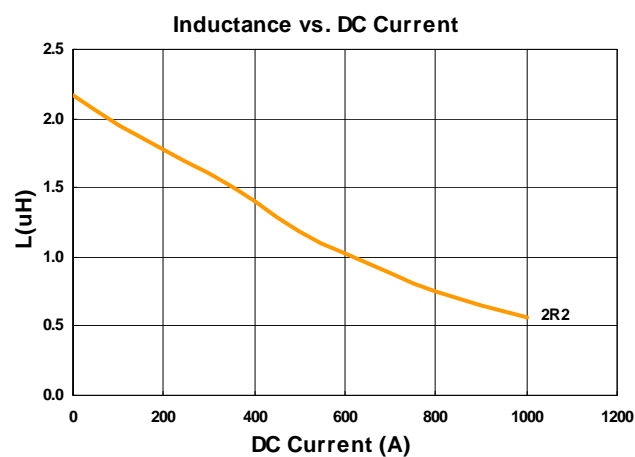
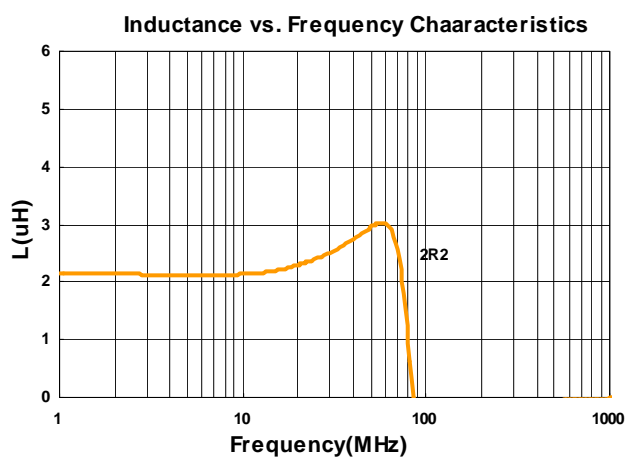
MPE : Low Profile Series

| Part Number | Inductance (uH) | Tolerance (±%) | Test Frequency (MHz) | RDC (Ω) ±25% | Isat(mA) Max(Typ.) | Irms(mA) Max(Typ.) |
|---------------------|-----------------|----------------|----------------------|--------------|--------------------|--------------------|
| MPE160806T-2R2□-NA6 | 2.2 | 20, 30 | 3 | 0.38 | 250(300) | 650(750) |

Note: When ordering, please specify tolerance code. Tolerance: M=±20% , T=±30%

- Operating temperature range - 55°C ~ 125°C(Including self - temperature rise)
- Isat for Inductance drop 30% from its value without current
- I rms for a 40°C temperature rise from 25°C ambient with current
- Measure Equipment :
 L : Agilent HP4287A+16197A, 3MHz 200mV
 RDC : HP 4338B, or equivalent

Test Instruments : HP4287A Inductance / Material Analyzer



Electrical Characteristics

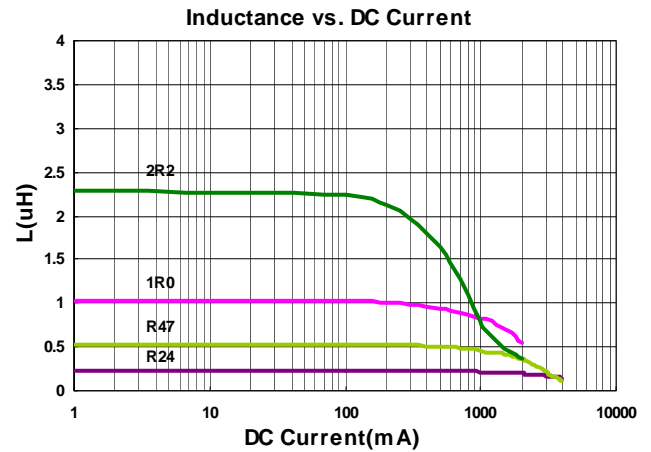
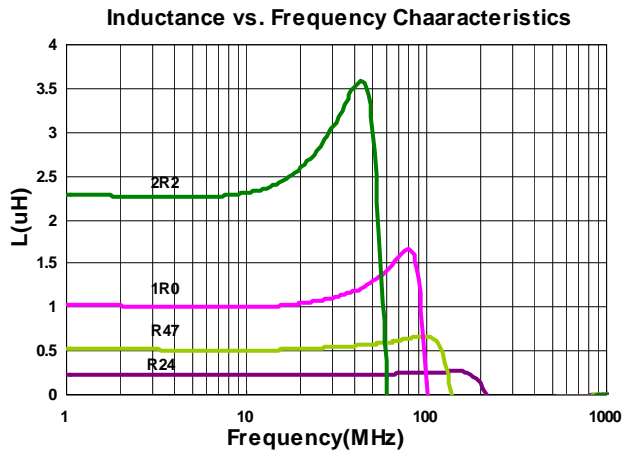
MPE : High Isat Series

| Part Number | Inductance (uH) | Tolerance (±%) | Test Frequency (MHz) | RDC (Ω) ±25% | Isat(mA) Max(Typ.) | Irms(mA) Max(Typ.) |
|---------------------|-----------------|----------------|----------------------|--------------|--------------------|--------------------|
| MPE201210T-R24□-NA2 | 0.24 | 20, 30 | 3 | 0.03 | 2700(3300) | 2400(3200) |
| MPE201210T-R47□-NA2 | 0.47 | 20, 30 | 3 | 0.06 | 1600(2000) | 2200(3000) |
| MPE201210T-1R0□-NA2 | 1.0 | 20, 30 | 3 | 0.10 | 1400(1700) | 1800(2100) |
| MPE201210T-2R2□-NA2 | 2.2 | 20, 30 | 3 | 0.125 | 500(800) | 1600(1900) |

Note: When ordering, please specify tolerance code. Tolerance: M=±20% , T=±30%

- Operating temperature range - 55°C ~ 125°C(Including self - temperature rise)
- Isat for Inductance drop 30% from its value without current
- I rms for a 40°C temperature rise from 25°C ambient with current
- Measure Equipment :
 L : Agilent HP4287A+16197A, 3MHz 200mV
 RDC : HP 4338B, or equivalent

Test Instruments : HP4287A Inductance / Material Analyzer



Electrical Characteristics

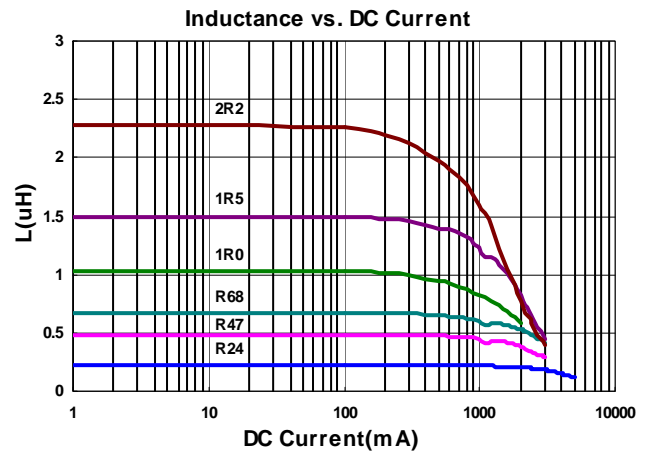
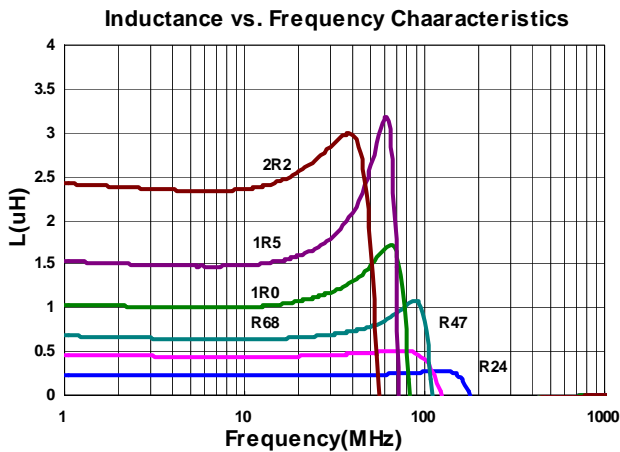
MPE : High Isat Series

| Part Number | Inductance (uH) | Tolerance (±%) | Test Frequency (MHz) | RDC (Ω) ±25% | Isat(mA) Max(Typ.) | Irms(mA) Max(Typ.) |
|---------------------|-----------------|----------------|----------------------|--------------|--------------------|--------------------|
| MPE201610T-R24□-NA2 | 0.24 | 20, 30 | 3 | 0.023 | 3600(4000) | 3500(4200) |
| MPE201610T-R47□-NA2 | 0.47 | 20, 30 | 3 | 0.037 | 2500(2900) | 2600(3100) |
| MPE201610T-R68□-NA2 | 0.68 | 20, 30 | 3 | 0.065 | 2500(2800) | 2400(2800) |
| MPE201610T-1R0□-NA2 | 1.0 | 20, 30 | 3 | 0.068 | 1500(1900) | 2200(2600) |
| MPE201610T-1R5□-NA2 | 1.5 | 20, 30 | 3 | 0.100 | 1500(1800) | 1600(1900) |
| MPE201610T-2R2□-NA2 | 2.2 | 20, 30 | 3 | 0.210 | 1000(1300) | 1500(1800) |

Note: When ordering, please specify tolerance code. Tolerance: M=±20% , T=±30%

- Operating temperature range - 55°C ~ 125°C(Including self - temperature rise)
- Isat for Inductance drop 30% from its value without current
- I rms for a 40°C temperature rise from 25°C ambient with current
- Measure Equipment :
 L : Agilent HP4287A+16197A, 3MHz 200mV
 RDC : HP 4338B, or equivalent

Test Instruments : HP4287A Inductance / Material Analyzer



Please be sure to request approval specifications that provide further details of the products. Kindly note that the content of these specifications are subject to change or may be discontinued without advance notice. Please contact our sales department before ordering.

Electrical Characteristics

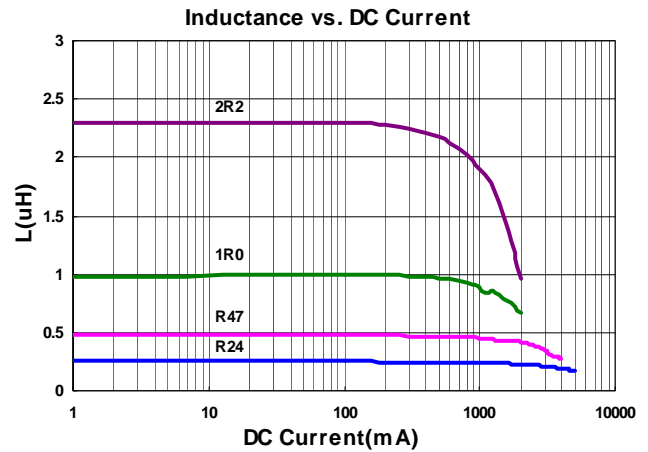
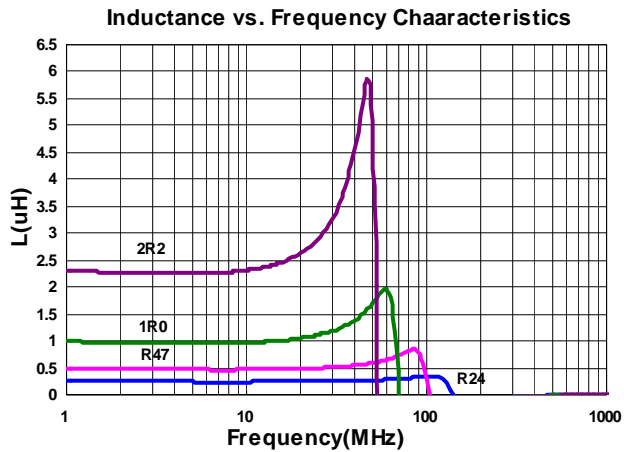
MPE : High Isat Series

| Part Number | Inductance (uH) | Tolerance (±%) | Test Frequency (MHz) | RDC (Ω) ±25% | Isat(mA) Max(Typ.) | Irms(mA) Max(Typ.) |
|---------------------|-----------------|----------------|----------------------|--------------|--------------------|--------------------|
| MPE252010T-R24□-NA2 | 0.24 | 20, 30 | 3 | 0.024 | 4800(5200) | 4100(4900) |
| MPE252010T-R47□-NA2 | 0.47 | 20, 30 | 3 | 0.040 | 3100(3500) | 3000(3600) |
| MPE252010T-1R0□-NA2 | 1.0 | 20, 30 | 3 | 0.050 | 1500(1900) | 2900(3500) |
| MPE252010T-2R2□-NA2 | 2.2 | 20, 30 | 3 | 0.110 | 1400(1700) | 1600(1900) |

Note: When ordering, please specify tolerance code. Tolerance: M=±20% , T=±30%

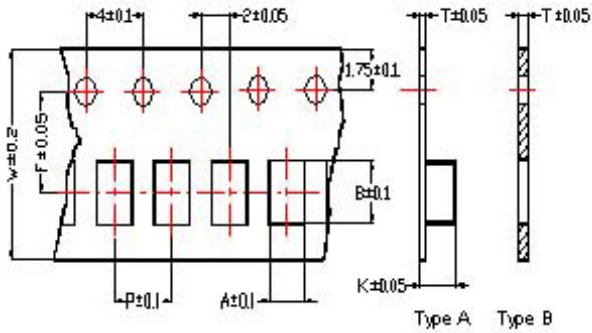
- Operating temperature range - 55°C ~ 125°C(Including self - temperature rise)
- Isat for Inductance drop 30% from its value without current
- I rms for a 40°C temperature rise from 25°C ambient with current
- Measure Equipment :
 L : Agilent HP4287A+16197A, 3MHz 200mV
 RDC : HP 4338B, or equivalent

Test Instruments : HP4287A Inductance / Material Analyzer



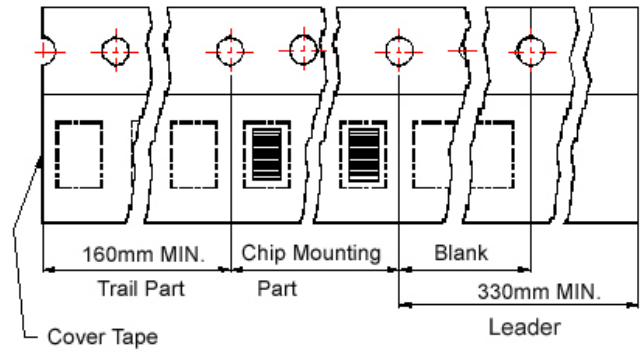
Packaging Specifications

Tape Dimensions

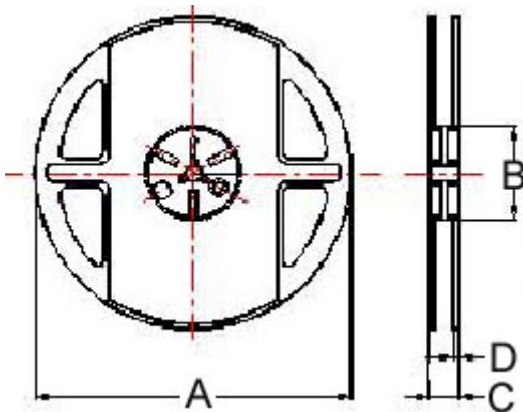


Tape Material

Carrier Tape: Polycarbonate (Tape A)
 Carrier Tape: Paper (Tape B)
 Cover Tape: Polystyrene



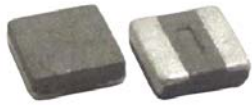
Reel Dimensions



Dimensions in mm

| TYPE | Tape Dimensions | | | | | | | | Reel Dimensions | | | | Quantity PCS / REEL |
|--------|-----------------|------|------|-----|-----|-----|------|-----------|-----------------|----|----|-----|------------------------|
| | A | B | T | W | P | F | K | Tape Type | A | B | C | D | |
| 160805 | 1.05 | 1.85 | 0.60 | 8.0 | 2.0 | 3.5 | - | B | 178 | 60 | 12 | 1.5 | 10000 |
| 160806 | 1.05 | 1.85 | 0.75 | 8.0 | 4.0 | 3.5 | - | B | 178 | 60 | 12 | 1.5 | 4000 |
| 160808 | 1.05 | 1.85 | 0.95 | 8.0 | 4.0 | 3.5 | - | B | 178 | 60 | 12 | 1.5 | 4000 |
| 201205 | 1.42 | 2.25 | 0.22 | 8.0 | 4.0 | 3.5 | 0.80 | A | 178 | 60 | 12 | 1.5 | 4000 |
| 201210 | 1.45 | 2.25 | 0.22 | 8.0 | 4.0 | 3.5 | 1.04 | A | 178 | 60 | 12 | 1.5 | 3000 |
| 201610 | 1.80 | 2.20 | 0.22 | 8.0 | 4.0 | 3.5 | 1.15 | A | 178 | 60 | 12 | 1.5 | 3000 |
| 252010 | 2.25 | 2.8 | 0.25 | 8.0 | 4.0 | 3.5 | 1.35 | A | 178 | 60 | 12 | 1.5 | 3000 |
| 252012 | 2.25 | 2.8 | 0.25 | 8.0 | 4.0 | 3.5 | 1.35 | A | 178 | 60 | 12 | 1.5 | 3000 |

CXFL Series



The HEI Series is designed specifically to enhance both PFM and PWM application performance. Q(Rac) value at light load and the RDC value at heavy load are both exceptional. Furthermore, the saturated current performance is also optimal, helping to reduce the ripple current and enhance the efficiency.

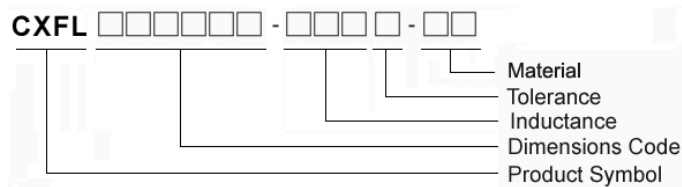
Features

- RoHS, Halogen Free and REACH Compliance
- High Efficiency
- Excellent Q, RDC and saturation current
- Low profile and miniature size down to 1.6*0.8*0.8mm

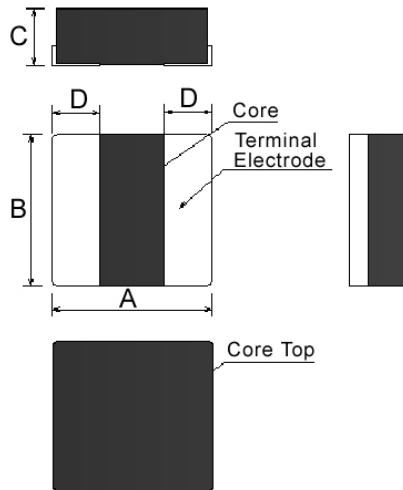
Applications

- Smartphones, tablets and wearable devices
- HDD, SSD and PC peripheral devices
- DSC, camcorders
- PND
- DC/DC converters

Product Identification



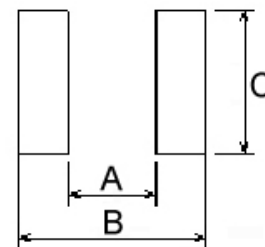
Shape and Dimensions



Dimensions in mm

| TYPE | A | B | C | D |
|--------|---------|---------|--------|---------|
| 303010 | 3.0±0.2 | 3.0±0.2 | 1.0Max | 0.8±0.3 |
| 404010 | 4.0±0.2 | 4.0±0.2 | 1.0Max | 1.3±0.3 |

Recommended Pattern



Dimensions in mm

| TYPE | A | B | C |
|--------|-----|-----|-----|
| 303010 | 1.0 | 3.2 | 3.2 |
| 404010 | 1.2 | 4.2 | 4.2 |

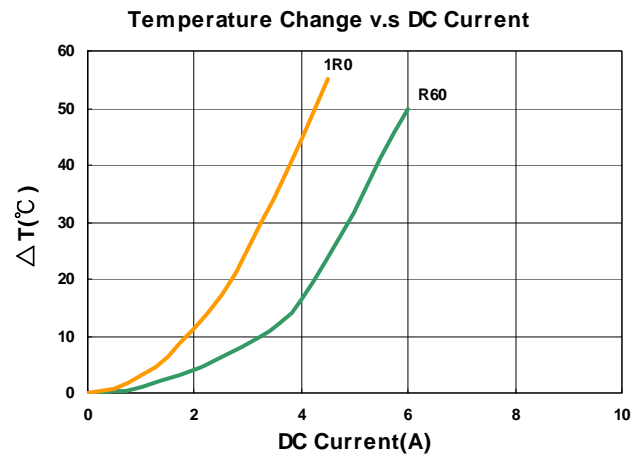
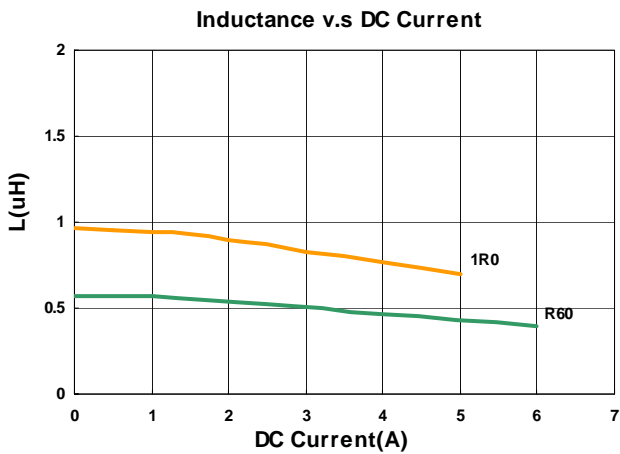
Electrical Characteristics

| Part Number | Inductance (uH) | Tolerance (±%) | Test Frequency (MHz) | RDC(mΩ) Max(Typ.) | Isat(A) Max(Typ.) | Irms(A) Max(Typ.) |
|--------------------|-----------------|----------------|----------------------|-------------------|-------------------|-------------------|
| CXFL303010-R60M-B8 | 0.6 | 20 | 2 | 30(27) | 5.2(5.8) | 4.3(4.8) |
| CXFL303010-1R0M-B8 | 1.0 | 20 | 2 | 49(43) | 4.5(5.0) | 3.4(3.8) |

Note: When ordering, please specify tolerance code. Tolerance: M=±20%

- Operating temperature range - 40°C ~ 125°C(Including self - temperature rise)
- Isat for Inductance drop 30% from its value without current
- I rms for a 40°C temperature rise from 25°C ambient with current
- Absolute maximum voltage 25VDC
- Measure Equipment :
 L : Agilent E4991/HP4286A+16197A (or equivalent), 2MHz 0.2V
 RDC : CHEN HWA502BC/HP4338B (or equivalent)
 Isat : Agilent E4980A+HP42841A (or equivalent)
 I rms : Agilent 6641 SYSTEM DC POWER SUPPLY (or equivalent)

Test Instruments : E4991A Impedance / Material Analyzer



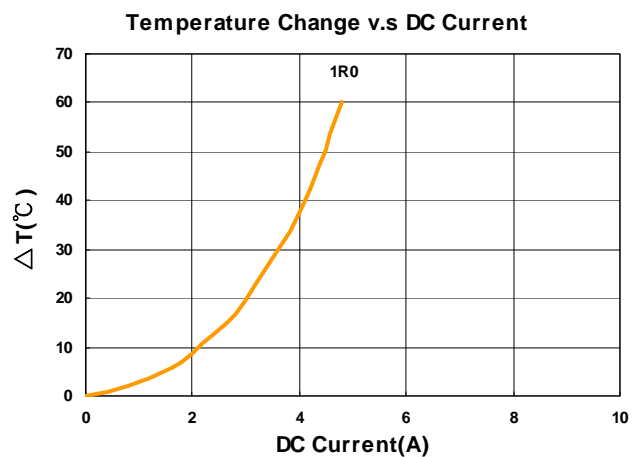
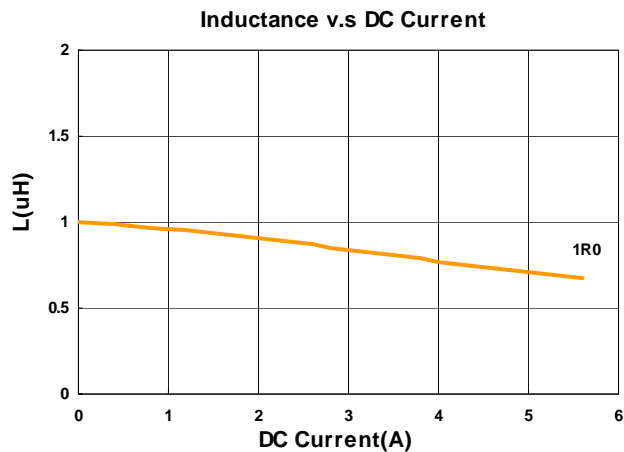
Electrical Characteristics

| Part Number | Inductance (uH) | Tolerance (±%) | Test Frequency (MHz) | RDC(mΩ) Max(Typ.) | Isat(A) Max(Typ.) | Irms(A) Max(Typ.) |
|--------------------|-----------------|----------------|----------------------|-------------------|-------------------|-------------------|
| CXFL404010-1R0M-B8 | 1.0 | 20 | 2 | 35(27) | 4.7(5.2) | 3.8(4.1) |

Note: When ordering, please specify tolerance code. Tolerance: M=±20%

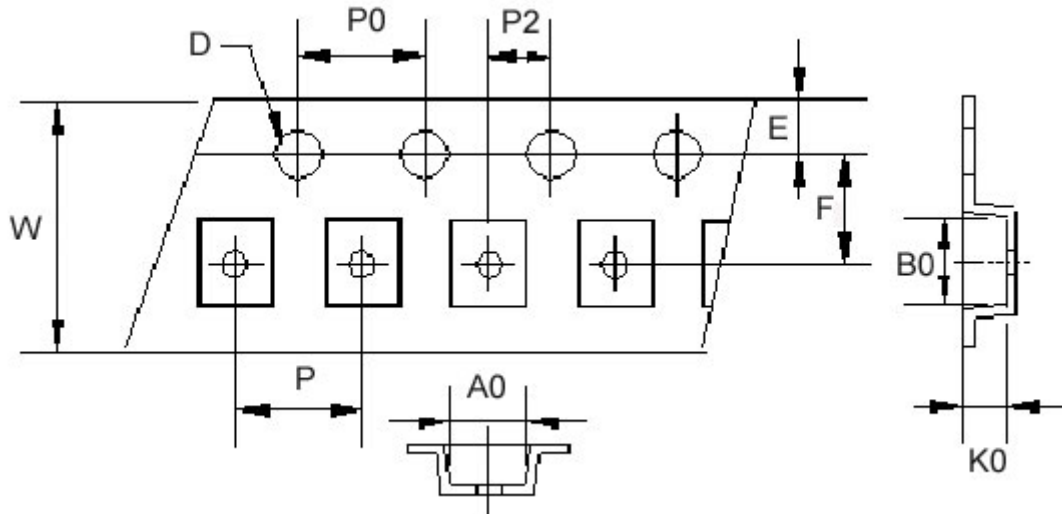
- Operating temperature range - 40°C ~ 125°C(Including self - temperature rise)
- Isat for Inductance drop 30% from its value without current
- I rms for a 40°C temperature rise from 25°C ambient with current
- Absolute maximum voltage 25VDC
- Measure Equipment :
 L : Agilent E4991/HP4286A+16197A (or equivalent), 2MHz 0.2V
 RDC : CHEN HWA502BC/HP4338B (or equivalent)
 Isat : Agilent E4980A+HP42841A (or equivalent)
 I rms : Agilent 6641 SYSTEM DC POWER SUPPLY (or equivalent)

Test Instruments : E4991A Impedance / Material Analyzer

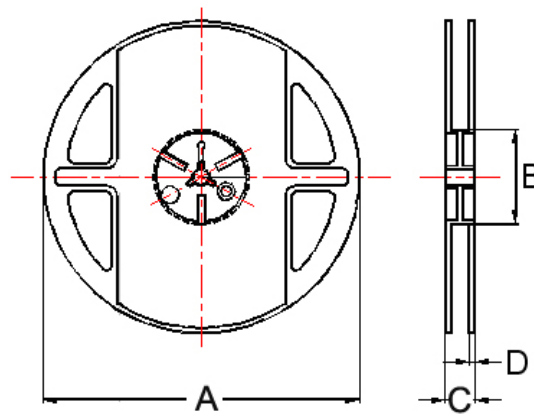


Packaging Specifications

Tape Dimensions



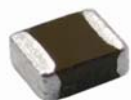
Reel Dimensions



Dimensions in mm

| TYPE | Tape Dimensions | | | | | | | | | | Reel Dimensions | | | | Quantity |
|--------|-----------------|------|-----|------|------|-----|----|---|----|----|-----------------|----|----|-----|------------|
| | A0 | B0 | K0 | D | E | F | W | P | P0 | P2 | A | B | C | D | PCS / REEL |
| 303010 | 3.2 | 3.2 | 1.4 | 1.55 | 1.75 | 3.5 | 8 | 4 | 4 | 2 | 178 | 60 | 12 | 1.5 | 2000 |
| 404010 | 4.25 | 4.25 | 1.3 | 1.55 | 1.75 | 5.5 | 12 | 8 | 4 | 2 | 178 | 60 | 12 | 1.5 | 1000 |

UHEI Series



Through material optimization, UHEI Series is with better electrical characteristics, such as: better efficiency performance, higher Q factor, and higher Irms. Compared to HEI series, the RDC of UHEI series can also be reduced by 10% to 25%.

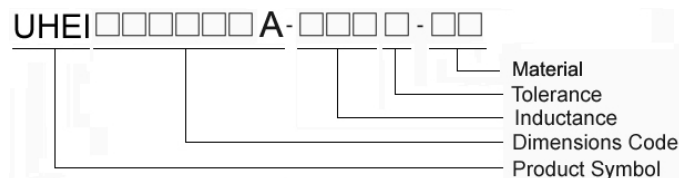
Features

- RoHS, Halogen Free and REACH Compliance
- High Efficiency
- Excellent Q, RDC and Irms
- Low profile and miniature size down to 2.0*1.6*1.0mm

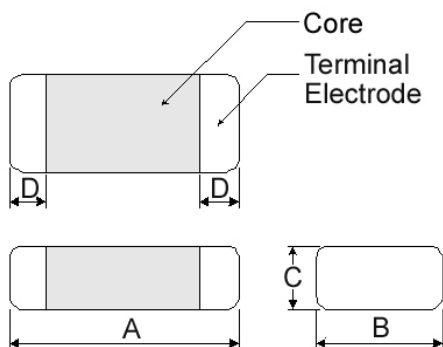
Applications

- Smartphones, tablets and wearable devices
- HDD, SSD and PC peripheral devices
- DSC, camcorders
- PND
- DC/DC converters

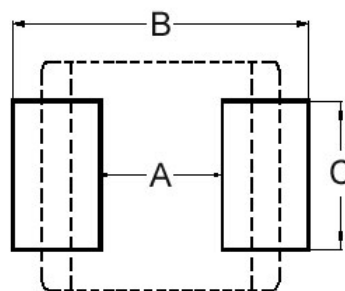
Product Identification



Shape and Dimensions



Recommended Pattern



Dimensions in mm

| TYPE | A | B | C | D |
|---------|---------|----------|--------|---------|
| 201208A | 2.0±0.2 | 1.25±0.2 | 0.8Max | 0.5±0.3 |
| 201610A | 2.0±0.2 | 1.60±0.2 | 1.0Max | 0.5±0.3 |
| 252010A | 2.5±0.3 | 2.00±0.3 | 1.0Max | 0.6±0.3 |
| 252012A | 2.5±0.3 | 2.00±0.3 | 1.2Max | 0.6±0.3 |

Dimensions in mm

| TYPE | A | B | C |
|---------|---------|---------|----------|
| 201208A | 0.8~1.2 | 2.3~2.9 | 1.0~1.45 |
| 201610A | 0.7 | 2.3 | 1.8 |
| 252010A | 1.2 | 2.8 | 2.3 |
| 252012A | 1.2 | 2.8 | 2.3 |

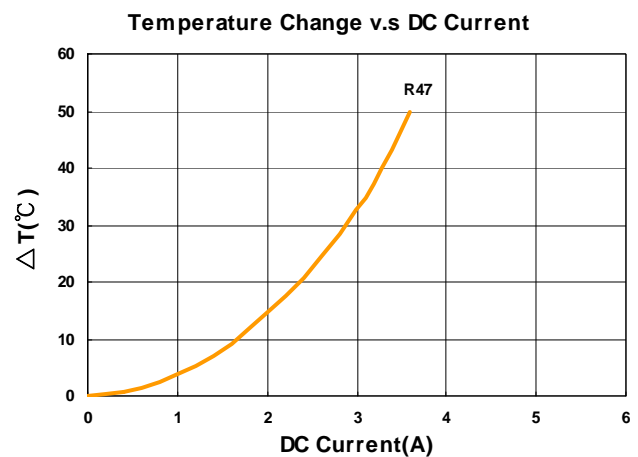
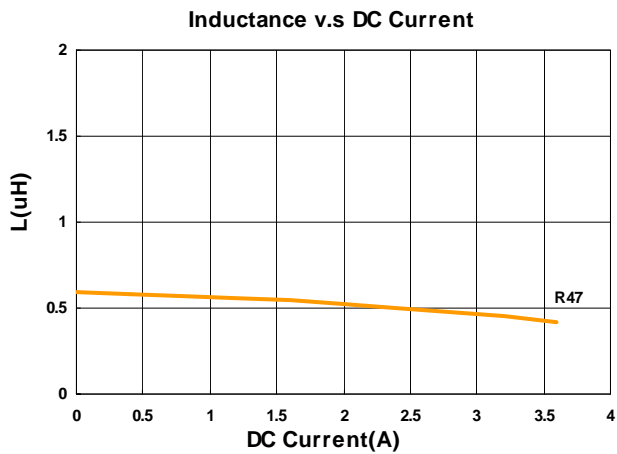
Electrical Characteristics

| Part Number | Inductance (uH) | Tolerance (±%) | Test Frequency (MHz) | RDC(mΩ) Max(Typ.) | Isat(A) Max(Typ.) | Irms(A) Max(Typ.) |
|---------------------|-----------------|----------------|----------------------|-------------------|-------------------|-------------------|
| UHEI201208A-R47M-Q9 | 0.47 | 20 | 2 | 43(37) | 3.5(3.6) | 3.0(3.2) |

Note: When ordering, please specify tolerance code. Tolerance: M=±20%

- Operating temperature range - 40°C ~ 125°C(Including self - temperature rise)
- Isat for Inductance drop 30% from its value without current
- I rms for a 40°C temperature rise from 25°C ambient with current
- Absolute maximum voltage 20VDC
- Measure Equipment :
 L : Agilent E4991/HP4286A+16197A (or equivalent), 2MHz 0.2V
 RDC : CHEN HWA502BC/HP4338B (or equivalent)
 Isat : Agilent E4980A+HP42841A (or equivalent)
 I rms : Agilent 6641 SYSTEM DC POWER SUPPLY (or equivalent)

Test Instruments : E4991A Impedance / Material Analyzer



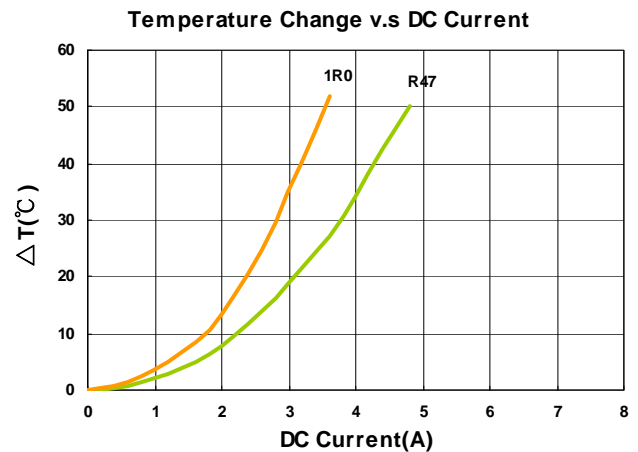
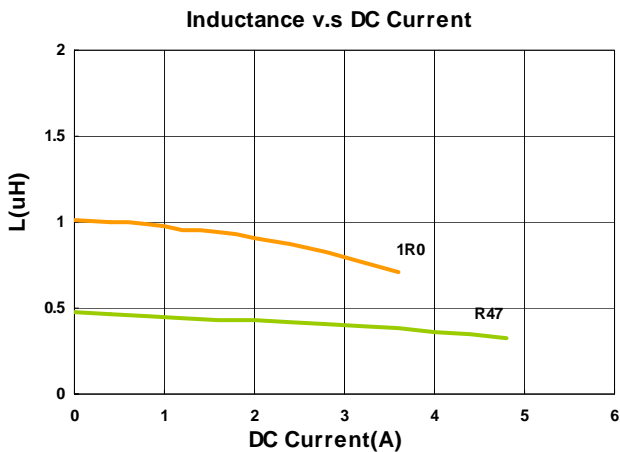
Electrical Characteristics

| Part Number | Inductance (uH) | Tolerance (±%) | Test Frequency (MHz) | RDC(mΩ) Max(Typ.) | Isat(A) Max(Typ.) | Irms(A) Max(Typ.) |
|---------------------|-----------------|----------------|----------------------|-------------------|-------------------|-------------------|
| UHEI201610A-R47M-Q9 | 0.47 | 20 | 2 | 36(30) | 3.5(3.9) | 3.1(3.5) |
| UHEI201610A-1R0M-Q9 | 1.0 | 20 | 2 | 60(50) | 3.0(3.2) | 2.7(3.0) |

Note: When ordering, please specify tolerance code. Tolerance: M=±20%

- Operating temperature range - 40°C ~ 125°C(Including self - temperature rise)
- Isat for Inductance drop 30% from its value without current
- I rms for a 40°C temperature rise from 25°C ambient with current
- Absolute maximum voltage 25VDC
- Measure Equipment :
 L : Agilent E4991/HP4286A+16197A (or equivalent), 2MHz 0.2V
 RDC : CHEN HWA502BC/HP4338B (or equivalent)
 Isat : Agilent E4980A+HP42841A (or equivalent)
 I rms : Agilent 6641 SYSTEM DC POWER SUPPLY (or equivalent)

Test Instruments : E4991A Impedance / Material Analyzer



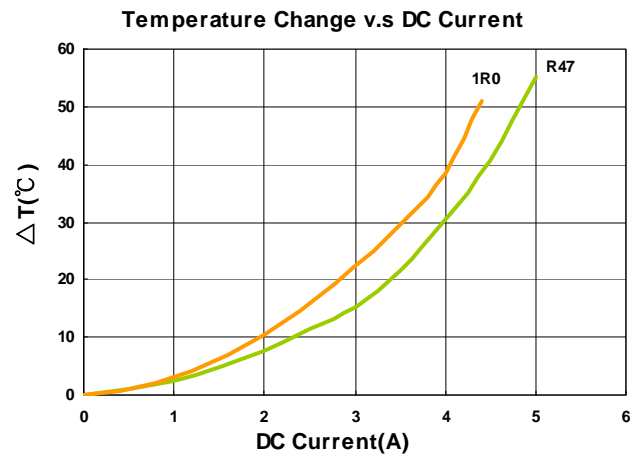
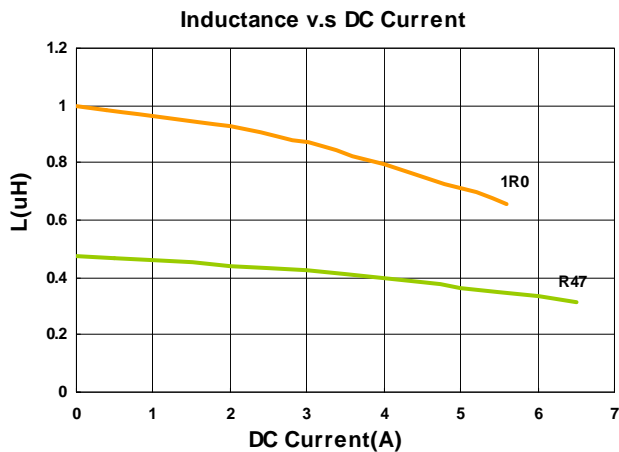
Electrical Characteristics

| Part Number | Inductance (uH) | Tolerance (±%) | Test Frequency (MHz) | RDC(mΩ) Max(Typ.) | Isat(A) Max(Typ.) | Irms(A) Max(Typ.) |
|---------------------|-----------------|----------------|----------------------|-------------------|-------------------|-------------------|
| UHEI252010A-R47M-Q9 | 0.47 | 20 | 2 | 27(21) | 5.5(6.5) | 4.2(4.5) |
| UHEI252010A-1R0M-Q9 | 1.0 | 20 | 2 | 46(39) | 4.7(5.2) | 4.0(4.2) |

Note: When ordering, please specify tolerance code. Tolerance: M=±20%

- Operating temperature range - 40°C ~ 125°C(Including self - temperature rise)
- Isat for Inductance drop 30% from its value without current
- I rms for a 40°C temperature rise from 25°C ambient with current
- Absolute maximum voltage 25VDC
- Measure Equipment :
 L : Agilent E4991/HP4286A+16197A (or equivalent), 2MHz 0.2V
 RDC : CHEN HWA502BC/HP4338B (or equivalent)
 Isat : Agilent E4980A+HP42841A (or equivalent)
 I rms : Agilent 6641 SYSTEM DC POWER SUPPLY (or equivalent)

Test Instruments : E4991A Impedance / Material Analyzer



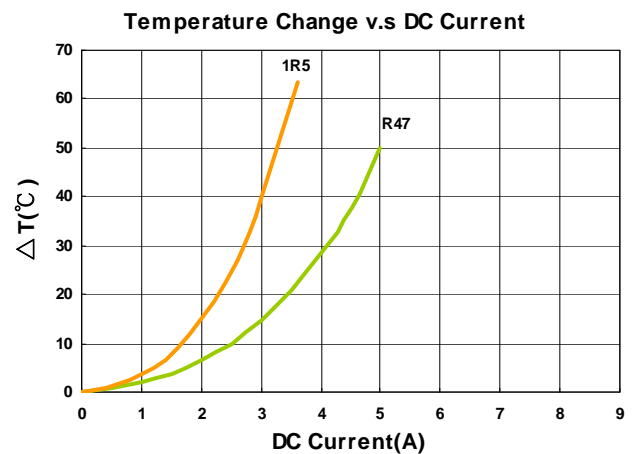
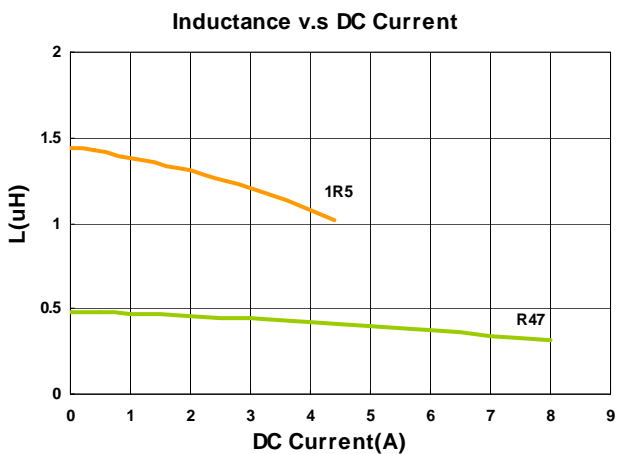
Electrical Characteristics

| Part Number | Inductance (uH) | Tolerance (±%) | Test Frequency (MHz) | RDC(mΩ) Max(Typ.) | Isat(A) Max(Typ.) | Irms(A) Max(Typ.) |
|---------------------|-----------------|----------------|----------------------|-------------------|-------------------|-------------------|
| UHEI252012A-R47M-Q9 | 0.47 | 20 | 2 | 26.5(22.5) | 5.3(7.0) | 4.0(4.5) |
| UHEI252012A-1R5M-Q9 | 1.5 | 20 | 2 | 59(51) | 3.4(4.4) | 2.7(3.0) |

Note: When ordering, please specify tolerance code. Tolerance: M=±20%

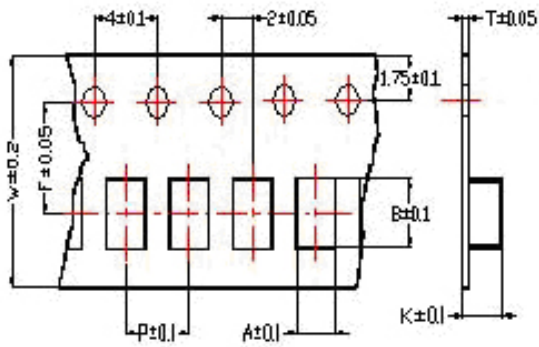
- Operating temperature range - 40°C ~ 125°C(Including self - temperature rise)
- Isat for Inductance drop 30% from its value without current
- I rms for a 40°C temperature rise from 25°C ambient with current
- Absolute maximum voltage 25VDC
- Measure Equipment :
 L : Agilent E4991/HP4286A+16197A (or equivalent), 2MHz 0.2V
 RDC : CHEN HWA502BC/HP4338B (or equivalent)
 Isat : Agilent E4980A+HP42841A (or equivalent)
 I rms : Agilent 6641 SYSTEM DC POWER SUPPLY (or equivalent)

Test Instruments : E4991A Impedance / Material Analyzer

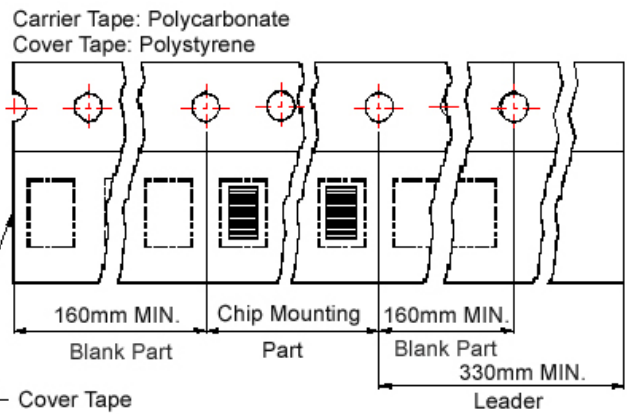


Packaging Specifications

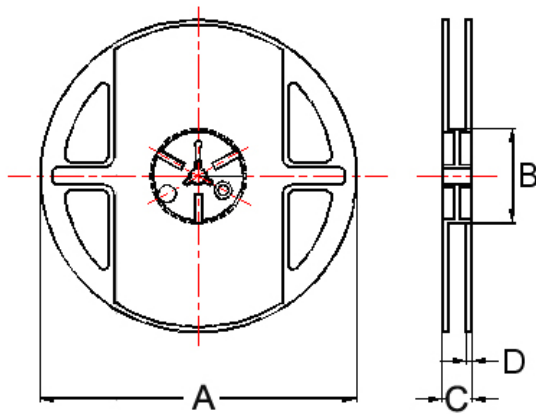
Tape Dimensions



Tape Material



Reel Dimensions



Dimensions in mm

| TYPE | Tape Dimensions | | | | | | | Reel Dimensions | | | | Quantity PCS / REEL |
|---------|-----------------|------|------|---|---|-----|------|-----------------|----|----|-----|------------------------|
| | A | B | T | W | P | F | K | A | B | C | D | |
| 201208A | 1.45 | 2.25 | 0.22 | 8 | 4 | 3.5 | 1.04 | 178 | 60 | 12 | 1.5 | 3000 |
| 201610A | 1.80 | 2.20 | 0.22 | 8 | 4 | 3.5 | 1.15 | 178 | 60 | 12 | 1.5 | 3000 |
| 252010A | 2.25 | 2.80 | 0.22 | 8 | 4 | 3.5 | 1.35 | 178 | 60 | 12 | 1.5 | 3000 |
| 252012A | 2.25 | 2.80 | 0.22 | 8 | 4 | 3.5 | 1.35 | 178 | 60 | 12 | 1.5 | 3000 |

HEI Series



The HEI Series is designed specifically to enhance both PFM and PWM application performance. Q(Rac) value at light load and the RDC value at heavy load are both exceptional. Furthermore, the saturated current performance is also optimal, helping to reduce the ripple current and enhance the efficiency.

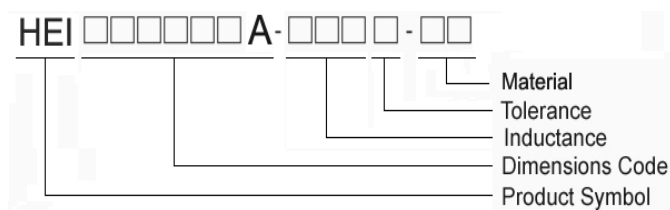
Features

- RoHS, Halogen Free and REACH Compliance
- High Efficiency
- Excellent Q, RDC and saturation current
- Low profile and miniature size down to 1.6*0.8*0.8mm

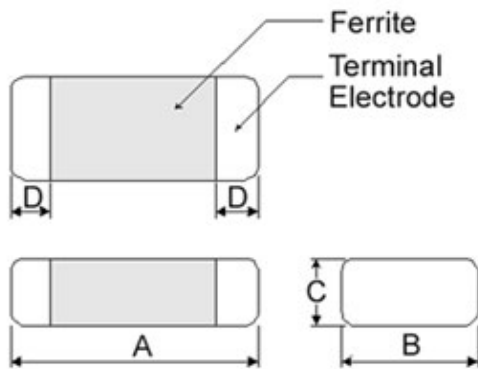
Applications

- Smartphones, tablets and wearable devices
- HDD, SSD and PC peripheral devices
- DSC, camcorders
- PND
- DC/DC converters

Product Identification



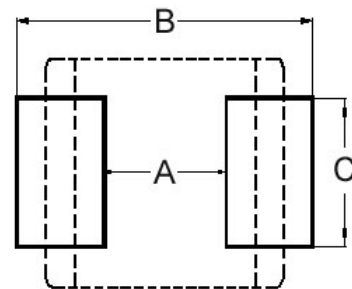
Shape and Dimensions



Dimensions in mm

| TYPE | A | B | C | D |
|---------|---------|----------|----------|---------|
| 160808A | 1.6±0.2 | 0.80±0.2 | 0.8Max | 0.3±0.2 |
| 201208A | 2.0±0.2 | 1.25±0.2 | 0.8Max | 0.5±0.3 |
| 201210A | 2.0±0.2 | 1.25±0.2 | 1.0Max | 0.5±0.3 |
| 201608A | 2.0±0.2 | 1.60±0.2 | 0.8Max | 0.5±0.3 |
| 201610A | 2.0±0.2 | 1.60±0.2 | 1.0Max | 0.5±0.3 |
| 252010A | 2.5±0.3 | 2.00±0.3 | 1.0Max | 0.6±0.3 |
| 252012A | 2.5±0.3 | 2.00±0.3 | 1.2Max | 0.6±0.3 |
| 322510A | 3.2±0.3 | 2.50±0.3 | 1.0Max | 0.5±0.3 |
| 322512A | 3.2±0.3 | 2.50±0.3 | 1.2Max | 0.5±0.3 |
| 322525A | 3.2±0.3 | 2.50±0.3 | 2.50±0.3 | 0.5±0.3 |

Recommended Pattern



Dimensions in mm

| TYPE | A | B | C |
|---------|---------|---------|----------|
| 160808A | 0.7~0.8 | 1.8~2.0 | 0.8~1.1 |
| 201208A | 0.8~1.2 | 2.3~2.9 | 1.0~1.45 |
| 201210A | 0.8~1.2 | 2.3~2.9 | 1.0~1.45 |
| 201608A | 0.7 | 2.3 | 1.8 |
| 201610A | 0.7 | 2.3 | 1.8 |
| 252010A | 1.2 | 2.8 | 2.3 |
| 252012A | 1.2 | 2.8 | 2.3 |
| 322510A | 1.7 | 3.5 | 2.8 |
| 322512A | 1.7 | 3.5 | 2.8 |
| 322525A | 1.7 | 3.5 | 2.8 |

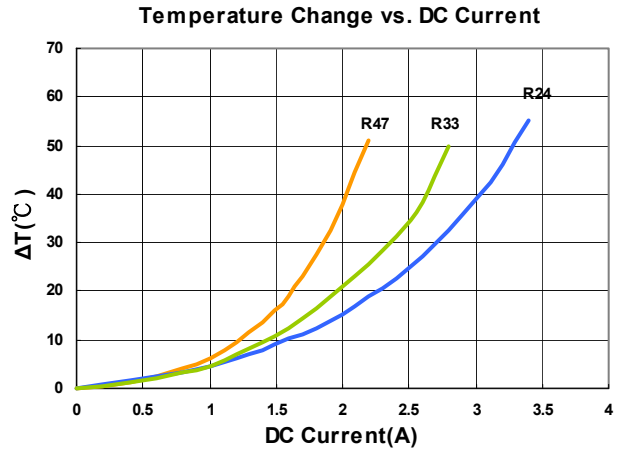
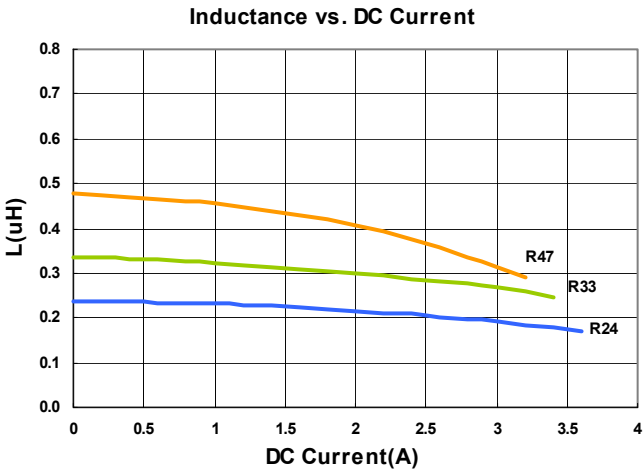
Electrical Characteristics

| Part Number | Inductance (uH) | Tolerance (±%) | Test Frequency (MHz) | RDC(mΩ) Max(Typ.) | Isat(A) Max(Typ.) | Irms(A) Max(Typ.) |
|--------------------|-----------------|----------------|----------------------|-------------------|-------------------|-------------------|
| HEI160808A-R24M-Q8 | 0.24 | 20 | 2 | 54(47) | 3.2(3.6) | 2.6(3.0) |
| HEI160808A-R33M-Q8 | 0.33 | 20 | 2 | 75(62) | 3.0(3.4) | 2.2(2.6) |
| HEI160808A-R47M-Q8 | 0.47 | 20 | 2 | 100(87) | 2.2(2.6) | 1.6(2.0) |

Note: When ordering, please specify tolerance code. Tolerance: M=±20%

- Operating temperature range - 40°C ~ 125°C(Including self - temperature rise)
- Isat for Inductance drop 30% from its value without current
- I rms for a 40°C temperature rise from 25°C ambient with current
- Absolute maximum voltage 20VDC
- Measure Equipment :
 L : Agilent E4991/HP4286A+16197A (or equivalent), 2MHz 0.2V
 RDC : CHEN HWA502BC/HP4338B (or equivalent)
 Isat : Agilent E4980A+HP42841A (or equivalent)
 I rms : Agilent 6641 SYSTEM DC POWER SUPPLY (or equivalent)

Test Instruments : E4991A Impedance / Material Analyzer



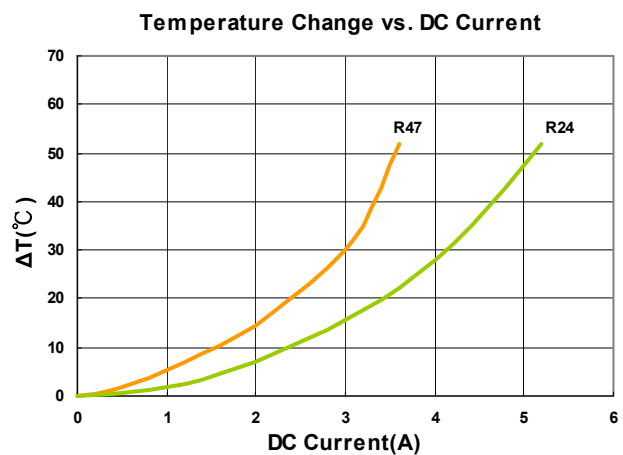
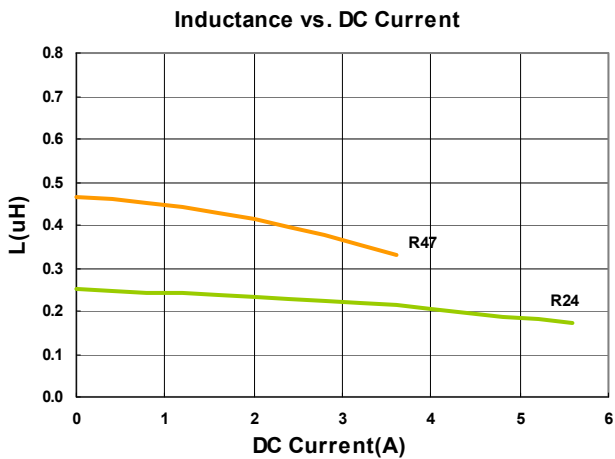
Electrical Characteristics

| Part Number | Inductance (uH) | Tolerance (±%) | Test Frequency (MHz) | RDC(mΩ) Max(Typ.) | Isat(A) Max(Typ.) | Irms(A) Max(Typ.) |
|--------------------|-----------------|----------------|----------------------|-------------------|-------------------|-------------------|
| HEI201208A-R24M-Q8 | 0.24 | 20 | 2 | 25(19) | 4.8(5.4) | 4.2(4.8) |
| HEI201208A-R47M-Q8 | 0.47 | 20 | 2 | 48(40) | 3.2(3.6) | 3.0(3.4) |

Note: When ordering, please specify tolerance code. Tolerance: M=±20%

- Operating temperature range - 40°C ~ 125°C(Including self - temperature rise)
- Isat for Inductance drop 30% from its value without current
- Irms for a 40°C temperature rise from 25°C ambient with current
- Absolute maximum voltage 20VDC
- Measure Equipment :
 L : Agilent E4991/HP4286A+16197A (or equivalent), 2MHz 0.2V
 RDC : CHEN HWA502BC/HP4338B (or equivalent)
 Isat : Agilent E4980A+HP42841A (or equivalent)
 Irms : Agilent 6641 SYSTEM DC POWER SUPPLY (or equivalent)

Test Instruments : E4991A Impedance / Material Analyzer



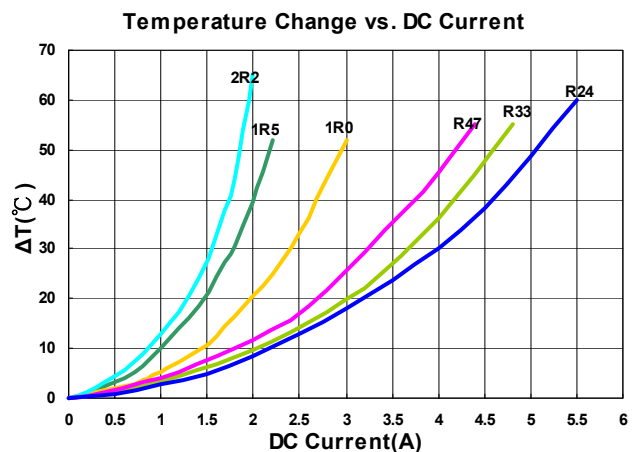
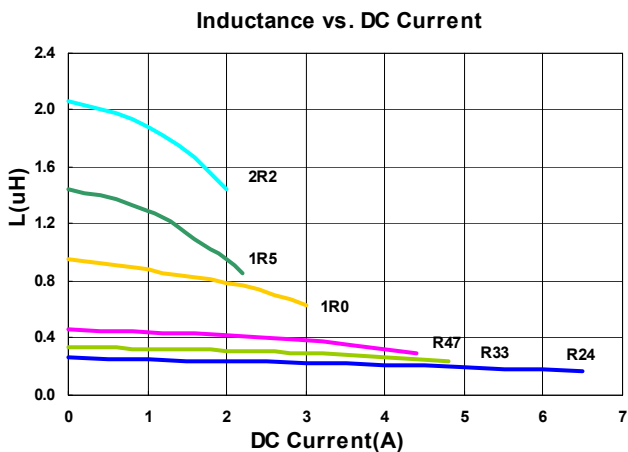
Electrical Characteristics

| Part Number | Inductance (uH) | Tolerance (±%) | Test Frequency (MHz) | RDC(mΩ) Max(Typ.) | Isat(A) Max(Typ.) | Irms(A) Max(Typ.) |
|--------------------|-----------------|----------------|----------------------|-------------------|-------------------|-------------------|
| HEI201210A-R24M-Q8 | 0.24 | 20 | 2 | 28(22) | 4.5(5.7) | 3.7(4.6) |
| HEI201210A-R33M-Q8 | 0.33 | 20 | 2 | 30(25) | 4.5(4.8) | 3.7(4.3) |
| HEI201210A-R47M-Q8 | 0.47 | 20 | 2 | 42(33) | 3.3(4.2) | 3.0(3.7) |
| HEI201210A-1R0M-Q8 | 1.0 | 20 | 2 | 78(69) | 2.3(2.8) | 2.2(2.7) |
| HEI201210A-1R5M-Q8 | 1.5 | 20 | 2 | 126(108) | 1.7(2.2) | 1.6(2.1) |
| HEI201210A-2R2M-Q8 | 2.2 | 20 | 2 | 176(166) | 1.6(1.7) | 1.4(1.5) |

Note: When ordering, please specify tolerance code. Tolerance: M=±20%

- Operating temperature range - 40°C ~ 125°C(Including self - temperature rise)
- Isat for Inductance drop 30% from its value without current
- I rms for a 40°C temperature rise from 25°C ambient with current
- Absolute maximum voltage 20VDC
- Measure Equipment :
 L : Agilent E4991/HP4286A+16197A (or equivalent), 2MHz 0.2V
 RDC : CHEN HWA502BC/HP4338B (or equivalent)
 Isat : Agilent E4980A+HP42841A (or equivalent)
 I rms : Agilent 6641 SYSTEM DC POWER SUPPLY (or equivalent)

Test Instruments : E4991A Impedance / Material Analyzer



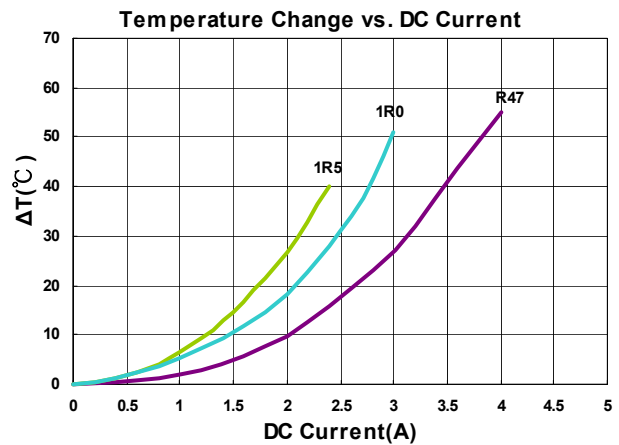
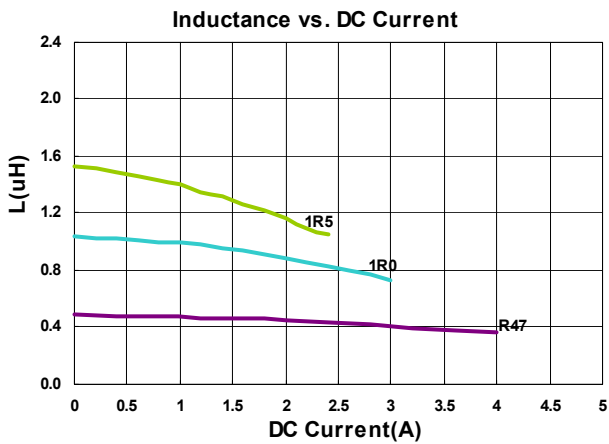
Electrical Characteristics

| Part Number | Inductance (uH) | Tolerance (±%) | Test Frequency (MHz) | RDC(mΩ) Max(Typ.) | Isat(A) Max(Typ.) | Irms(A) Max(Typ.) |
|--------------------|-----------------|----------------|----------------------|----------------------|----------------------|----------------------|
| HEI201608A-R47M-Q8 | 0.47 | 20 | 2 | 51(42) | 3.3(3.6) | 3.1(3.4) |
| HEI201608A-1R0M-Q8 | 1.0 | 20 | 2 | 87(76) | 2.5(2.8) | 2.3(2.7) |
| HEI201608A-1R5M-Q8 | 1.5 | 20 | 2 | 115(102) | 2.0(2.3) | 2.1(2.4) |

Note: When ordering, please specify tolerance code. Tolerance: M=±20%

- Operating temperature range - 40°C ~ 125°C(Including self - temperature rise)
- Isat for Inductance drop 30% from its value without current
- I rms for a 40°C temperature rise from 25°C ambient with current
- Absolute maximum voltage 25VDC
- Measure Equipment :
 L : Agilent E4991/HP4286A+16197A (or equivalent), 2MHz 0.2V
 RDC : CHEN HWA502BC/HP4338B (or equivalent)
 Isat : Agilent E4980A+HP42841A (or equivalent)
 I rms : Agilent 6641 SYSTEM DC POWER SUPPLY (or equivalent)

Test Instruments : E4991A Impedance / Material Analyzer



Electrical Characteristics

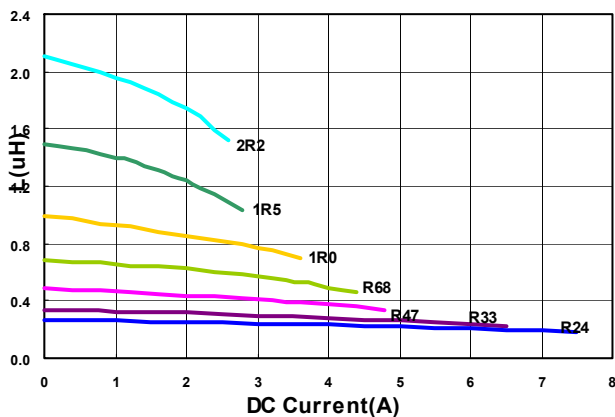
| Part Number | Inductance (uH) | Tolerance (±%) | Test Frequency (MHz) | RDC(mΩ) Max(Typ.) | Isat(A) Max(Typ.) | Irms(A) Max(Typ.) |
|--------------------|-----------------|----------------|----------------------|-------------------|-------------------|-------------------|
| HEI201610A-R24M-Q8 | 0.24 | 20 | 2 | 27(21) | 5.6(7.0) | 3.9(4.8) |
| HEI201610A-R33M-Q8 | 0.33 | 20 | 2 | 23(17.5) | 5.3(6.0) | 4.7(5.1) |
| HEI201610A-R47M-Q8 | 0.47 | 20 | 2 | 42(33) | 3.9(4.8) | 3.5(4.2) |
| HEI201610A-R68M-Q8 | 0.68 | 20 | 2 | 56(43) | 3.2(4.0) | 2.7(3.4) |
| HEI201610A-1R0M-Q8 | 1.0 | 20 | 2 | 65(53) | 2.9(3.6) | 2.5(3.1) |
| HEI201610A-1R5M-Q8 | 1.5 | 20 | 2 | 85(75) | 2.5(2.8) | 2.3(2.7) |
| HEI201610A-2R2M-Q8 | 2.2 | 20 | 2 | 135(112) | 2.4(2.7) | 1.8(2.2) |

Note: When ordering, please specify tolerance code. Tolerance: M=±20%

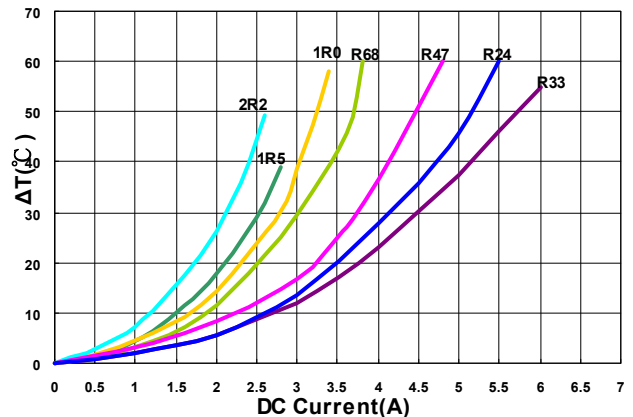
- Operating temperature range - 40°C ~ 125°C(Including self - temperature rise)
- Isat for Inductance drop 30% from its value without current
- I rms for a 40°C temperature rise from 25°C ambient with current
- Absolute maximum voltage 25VDC
- Measure Equipment :
 - L : Agilent E4991/HP4286A+16197A (or equivalent), 2MHz 0.2V
 - RDC : CHEN HWA502BC/HP4338B (or equivalent)
 - Isat : Agilent E4980A+HP42841A (or equivalent)
 - I rms : Agilent 6641 SYSTEM DC POWER SUPPLY (or equivalent)

Test Instruments : E4991A Impedance / Material Analyzer

Inductance vs. DC Current



Temperature Change vs. DC Current



Please be sure to request approval specifications that provide further details of the products. Kindly note that the content of these specifications are subject to change or may be discontinued without advance notice. Please contact our sales department before ordering.

Electrical Characteristics

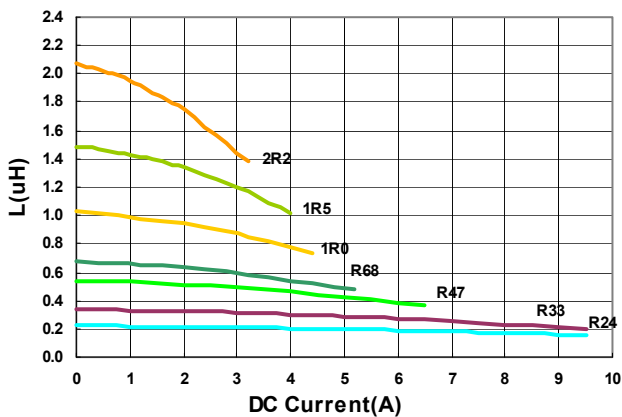
| Part Number | Inductance (uH) | Tolerance (±%) | Test Frequency (MHz) | RDC(mΩ) Max(Typ.) | Isat(A) Max(Typ.) | Irms(A) Max(Typ.) |
|--------------------|-----------------|----------------|----------------------|-------------------|-------------------|-------------------|
| HEI252010A-R24M-Q8 | 0.24 | 20 | 2 | 18(13) | 8.0(9.5) | 5.5(6.5) |
| HEI252010A-R33M-Q8 | 0.33 | 20 | 2 | 24(18) | 6.5(8.0) | 4.8(5.5) |
| HEI252010A-R47M-Q8 | 0.47 | 20 | 2 | 35(27) | 5.0(6.2) | 3.9(4.5) |
| HEI252010A-R68M-Q8 | 0.68 | 20 | 2 | 40(32) | 4.5(5.6) | 3.7(4.2) |
| HEI252010A-1R0M-Q8 | 1.0 | 20 | 2 | 53(45) | 3.7(4.6) | 3.0(3.5) |
| HEI252010A-1R5M-Q8 | 1.5 | 20 | 2 | 75(68) | 3.1(3.8) | 2.4(2.8) |
| HEI252010A-2R2M-Q8 | 2.2 | 20 | 2 | 97(87) | 2.5(3.0) | 2.2(2.5) |

Note: When ordering, please specify tolerance code. Tolerance: M=±20%

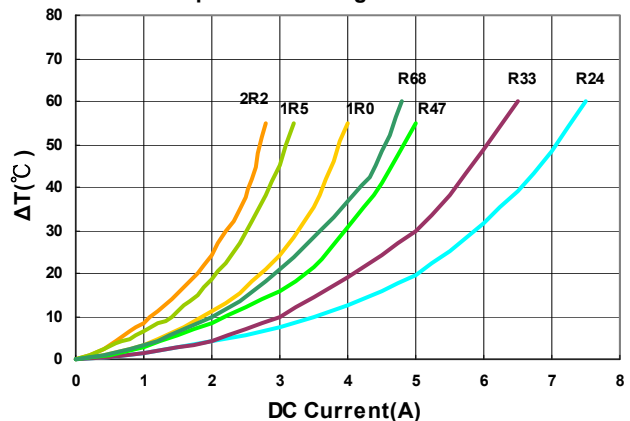
- Operating temperature range - 40°C ~ 125°C(Including self - temperature rise)
- Isat for Inductance drop 30% from its value without current
- I rms for a 40°C temperature rise from 25°C ambient with current
- Absolute maximum voltage 25VDC
- Measure Equipment :
 L : Agilent E4991/HP4286A+16197A (or equivalent), 2MHz 0.2V
 RDC : CHEN HWA502BC/HP4338B (or equivalent)
 Isat : Agilent E4980A+HP42841A (or equivalent)
 I rms : Agilent 6641 SYSTEM DC POWER SUPPLY (or equivalent)

Test Instruments : E4991A Impedance / Material Analyzer

Inductance vs. DC Current



Temperature Change vs. DC Current



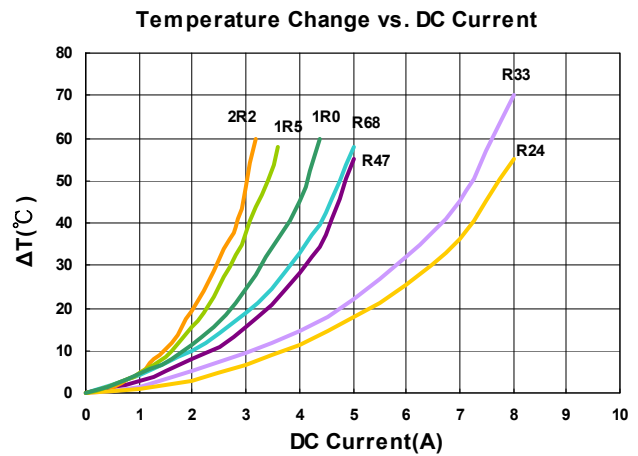
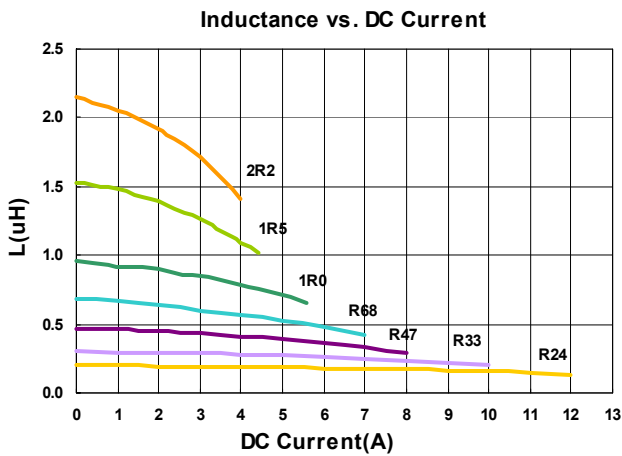
Electrical Characteristics

| Part Number | Inductance (uH) | Tolerance (±%) | Test Frequency (MHz) | RDC(mΩ) Max(Typ.) | Isat(A) Max(Typ.) | Irms(A) Max(Typ.) |
|--------------------|-----------------|----------------|----------------------|-------------------|-------------------|-------------------|
| HEI252012A-R24M-Q8 | 0.24 | 20 | 2 | 15(11.5) | 9.0(10.5) | 6.2(7.3) |
| HEI252012A-R33M-Q8 | 0.33 | 20 | 2 | 18(14.5) | 8.5(10) | 5.8(6.4) |
| HEI252012A-R47M-Q8 | 0.47 | 20 | 2 | 33(28) | 5.6(7.0) | 3.8(4.5) |
| HEI252012A-R68M-Q8 | 0.68 | 20 | 2 | 36(30) | 5.0(6.2) | 3.8(4.4) |
| HEI252012A-1R0M-Q8 | 1.0 | 20 | 2 | 42(35) | 4.4(5.5) | 3.6(4.1) |
| HEI252012A-1R5M-Q8 | 1.5 | 20 | 2 | 65(57) | 3.4(4.2) | 2.7(3.1) |
| HEI252012A-2R2M-Q8 | 2.2 | 20 | 2 | 83(74) | 3.0(3.7) | 2.5(2.9) |

Note: When ordering, please specify tolerance code. Tolerance: M=±20%

- Operating temperature range - 40°C ~ 125°C(Including self - temperature rise)
- Isat for Inductance drop 30% from its value without current
- I rms for a 40°C temperature rise from 25°C ambient with current
- Absolute maximum voltage 25VDC
- Measure Equipment :
 L : Agilent E4991/HP4286A+16197A (or equivalent), 2MHz 0.2V
 RDC : CHEN HWA502BC/HP4338B (or equivalent)
 Isat : Agilent E4980A+HP42841A (or equivalent)
 I rms : Agilent 6641 SYSTEM DC POWER SUPPLY (or equivalent)

Test Instruments : E4991A Impedance / Material Analyzer



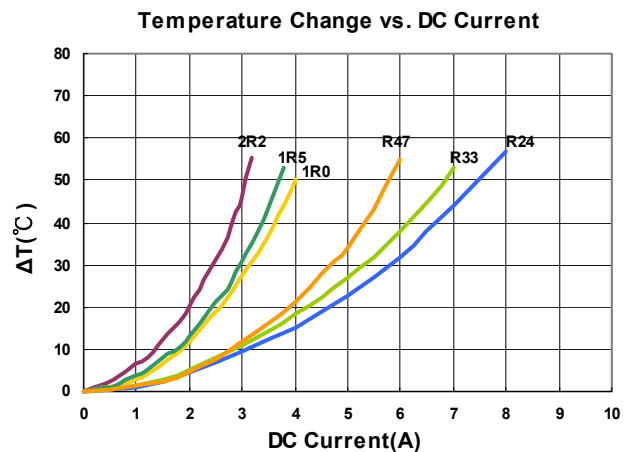
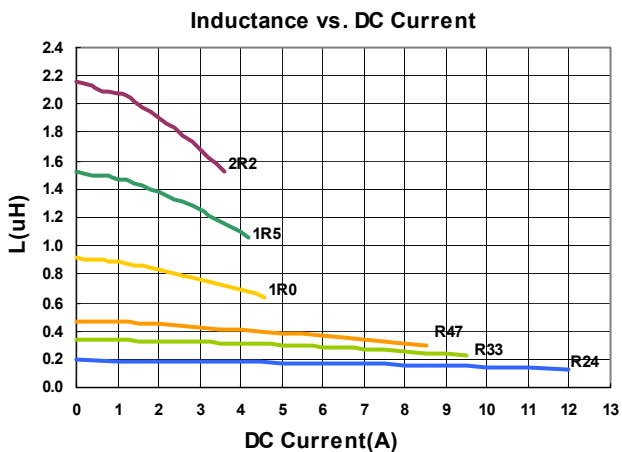
Electrical Characteristics

| Part Number | Inductance (uH) | Tolerance (±%) | Test Frequency (MHz) | RDC(mΩ) Max(Typ.) | Isat(A) Max(Typ.) | Irms(A) Max(Typ.) |
|--------------------|-----------------|----------------|----------------------|-------------------|-------------------|-------------------|
| HEI322510A-R24M-Q8 | 0.24 | 20 | 2 | 16(12) | 9.0(11.5) | 6.0(6.8) |
| HEI322510A-R33M-Q8 | 0.33 | 20 | 2 | 17(12.5) | 8.0(9.5) | 5.8(6.5) |
| HEI322510A-R47M-Q8 | 0.47 | 20 | 2 | 24(19) | 6.0(7.3) | 4.5(5.4) |
| HEI322510A-1R0M-Q8 | 1.0 | 20 | 2 | 46(39) | 4.1(4.7) | 3.3(3.7) |
| HEI322510A-1R5M-Q8 | 1.5 | 20 | 2 | 58(50) | 3.5(4.0) | 3.2(3.5) |
| HEI322510A-2R2M-Q8 | 2.2 | 20 | 2 | 85(73) | 3.0(3.5) | 2.5(2.8) |

Note: When ordering, please specify tolerance code. Tolerance: M=±20%

- Operating temperature range - 40°C ~ 125°C(Including self - temperature rise)
- Isat for Inductance drop 30% from its value without current
- I rms for a 40°C temperature rise from 25°C ambient with current
- Absolute maximum voltage 25VDC
- Measure Equipment :
 - L : Agilent E4991/HP4286A+16197A (or equivalent), 2MHz 0.2V
 - RDC : CHEN HWA502BC/HP4338B (or equivalent)
 - Isat : Agilent E4980A+HP42841A (or equivalent)
 - I rms : Agilent 6641 SYSTEM DC POWER SUPPLY (or equivalent)

Test Instruments : E4991A Impedance / Material Analyzer



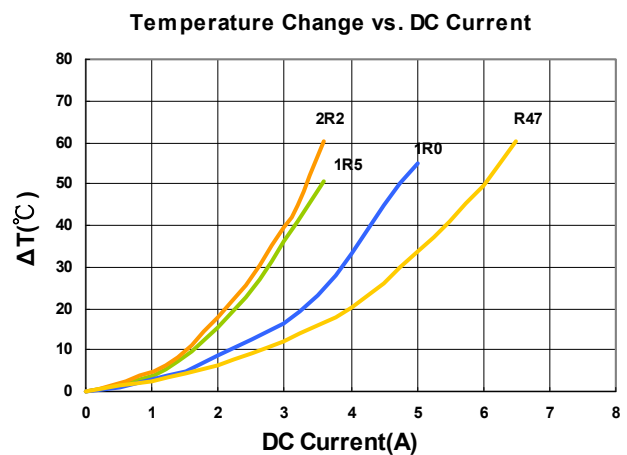
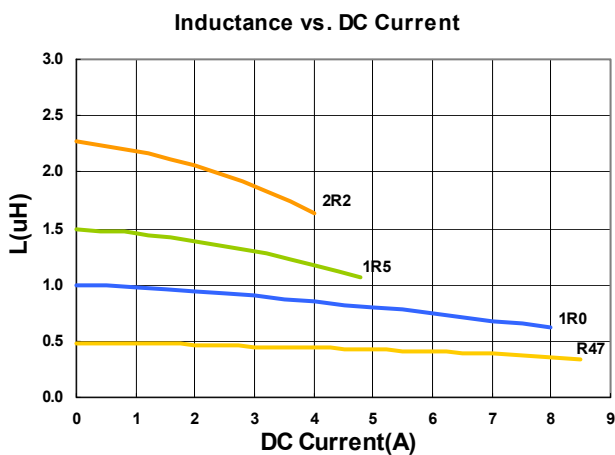
Electrical Characteristics

| Part Number | Inductance (uH) | Tolerance (±%) | Test Frequency (MHz) | RDC(mΩ) Max(Typ.) | Isat(A) Max(Typ.) | Irms(A) Max(Typ.) |
|--------------------|-----------------|----------------|----------------------|----------------------|----------------------|----------------------|
| HEI322512A-R47M-Q8 | 0.47 | 20 | 2 | 25(19) | 7.0(8.2) | 4.6(5.2) |
| HEI322512A-1R0M-Q8 | 1.0 | 20 | 2 | 34(27.5) | 5.7(6.5) | 3.7(4.2) |
| HEI322512A-1R5M-Q8 | 1.5 | 20 | 2 | 59(51) | 4.0(4.6) | 2.8(3.2) |
| HEI322512A-2R2M-Q8 | 2.2 | 20 | 2 | 73(64) | 3.5(4.0) | 2.7(3.0) |

Note: When ordering, please specify tolerance code. Tolerance: M=±20%

- Operating temperature range - 40°C ~ 125°C(Including self - temperature rise)
- Isat for Inductance drop 30% from its value without current
- I rms for a 40°C temperature rise from 25°C ambient with current
- Absolute maximum voltage 25VDC
- Measure Equipment :
 L : Agilent E4991/HP4286A+16197A (or equivalent), 2MHz 0.2V
 RDC : CHEN HWA502BC/HP4338B (or equivalent)
 Isat : Agilent E4980A+HP42841A (or equivalent)
 I rms : Agilent 6641 SYSTEM DC POWER SUPPLY (or equivalent)

Test Instruments : E4991A Impedance / Material Analyzer



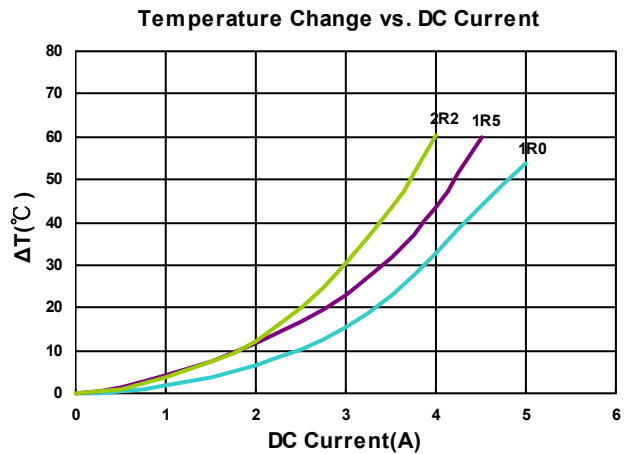
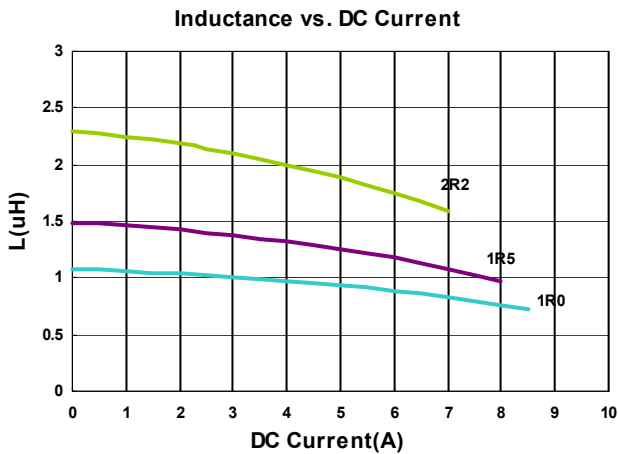
Electrical Characteristics

| Part Number | Inductance (uH) | Tolerance (±%) | Test Frequency (MHz) | RDC(mΩ) Max(Typ.) | Isat(A) Max(Typ.) | Irms(A) Max(Typ.) |
|--------------------|-----------------|----------------|----------------------|-------------------|-------------------|-------------------|
| HEI322525A-1R0M-Q8 | 1.0 | 20 | 2 | 34(28) | 6.0(8.0) | 3.5(4.3) |
| HEI322525A-1R5M-Q8 | 1.5 | 20 | 2 | 45(35) | 5.5(7.5) | 3.2(3.9) |
| HEI322525A-2R2M-Q8 | 2.2 | 20 | 2 | 60(49) | 4.8(6.5) | 3.0(3.3) |

Note: When ordering, please specify tolerance code. Tolerance: M=±20%

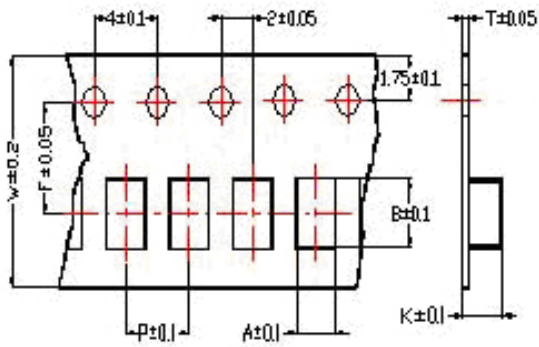
- Operating temperature range - 40°C ~ 125°C(Including self - temperature rise)
- Isat for Inductance drop 30% from its value without current
- I rms for a 40°C temperature rise from 25°C ambient with current
- Absolute maximum voltage 25VDC
- Measure Equipment :
 L : Agilent E4991/HP4286A+16197A (or equivalent), 2MHz 0.2V
 RDC : CHEN HWA502BC/HP4338B (or equivalent)
 Isat : Agilent E4980A+HP42841A (or equivalent)
 I rms : Agilent 6641 SYSTEM DC POWER SUPPLY (or equivalent)

Test Instruments : E4991A Impedance / Material Analyzer



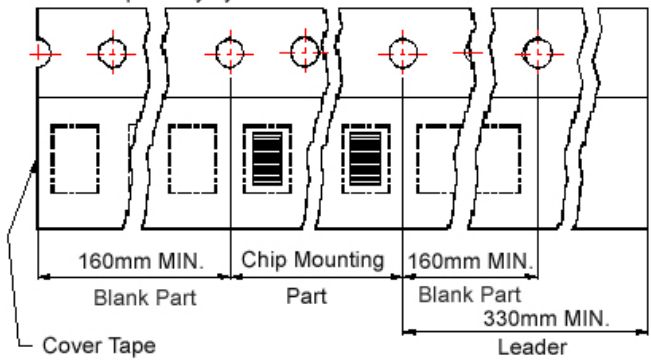
Packaging Specifications

Tape Dimensions

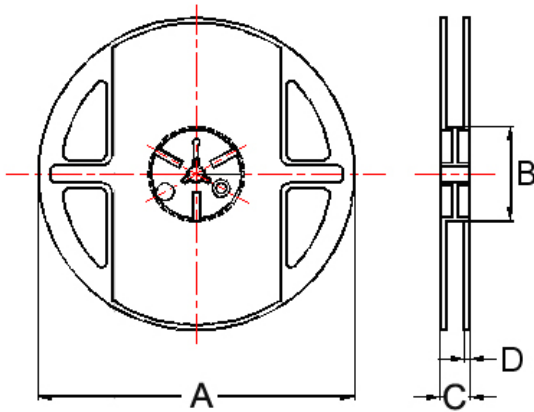


Tape Material

Carrier Tape: Polycarbonate
Cover Tape: Polystyrene



Reel Dimensions



Dimensions in mm

| TYPE | Tape Dimensions | | | | | | | Reel Dimensions | | | | Quantity PCS / REEL |
|---------|-----------------|------|------|---|---|-----|------|-----------------|----|----|-----|------------------------|
| | A | B | T | W | P | F | K | A | B | C | D | |
| 160808A | 1.20 | 1.88 | 0.95 | 8 | 4 | 3.5 | - | 178 | 60 | 12 | 1.5 | 4000 |
| 201208A | 1.45 | 2.25 | 0.22 | 8 | 4 | 3.5 | 1.04 | 178 | 60 | 12 | 1.5 | 3000 |
| 201210A | 1.50 | 2.25 | 0.22 | 8 | 4 | 3.5 | 1.15 | 178 | 60 | 12 | 1.5 | 3000 |
| 201608A | 1.80 | 2.35 | 0.23 | 8 | 4 | 3.5 | 0.85 | 178 | 60 | 12 | 1.5 | 3000 |
| 201610A | 1.80 | 2.20 | 0.22 | 8 | 4 | 3.5 | 1.15 | 178 | 60 | 12 | 1.5 | 3000 |
| 252010A | 2.25 | 2.80 | 0.22 | 8 | 4 | 3.5 | 1.15 | 178 | 60 | 12 | 1.5 | 3000 |
| 252012A | 2.25 | 2.80 | 0.22 | 8 | 4 | 3.5 | 1.35 | 178 | 60 | 12 | 1.5 | 3000 |
| 322510A | 2.80 | 3.55 | 0.23 | 8 | 4 | 3.5 | 1.20 | 178 | 60 | 12 | 1.5 | 3000 |
| 322512A | 2.80 | 3.50 | 0.23 | 8 | 4 | 3.5 | 1.34 | 178 | 60 | 12 | 1.5 | 3000 |
| 322525A | 2.90 | 3.50 | 0.23 | 8 | 4 | 3.5 | 2.90 | 178 | 60 | 12 | 1.5 | 1500 |

HEIL Series



The HEIL Series is designed specifically to enhance both PFM and PWM application performance. Q(Rac) value at light load and the RDC value at heavy load are both exceptional. Furthermore, the saturated current performance is also optimal, helping to reduce the ripple current and enhance the efficiency.

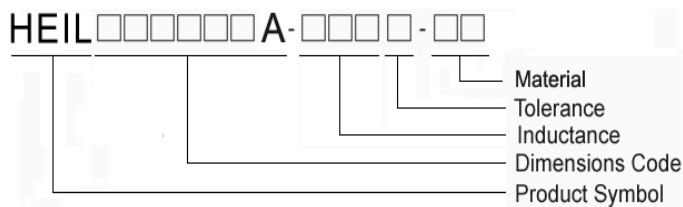
Features

- RoHS, Halogen Free and REACH Compliance
- High Efficiency
- Excellent Q, RDC and saturation current
- Low profile and miniature size down to 2.0*1.6*1.0mm

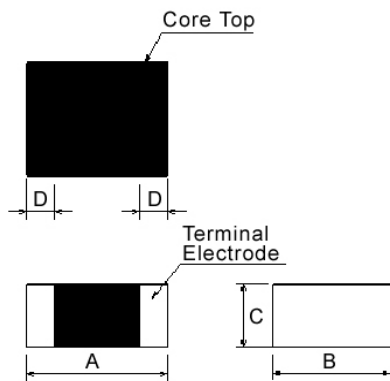
Applications

- Smartphones, tablets and wearable devices
- HDD, SSD and PC peripheral devices
- DSC, camcorders
- PND
- DC/DC converters

Product Identification



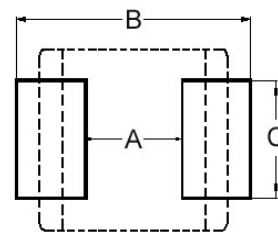
Shape and Dimensions



Dimensions in mm

| TYPE | A | B | C | D |
|---------|---------|----------|--------|---------|
| 201610A | 2.0±0.2 | 1.60±0.2 | 1.0Max | 0.5±0.3 |
| 252010A | 2.5±0.3 | 2.00±0.3 | 1.0Max | 0.6±0.3 |
| 252012A | 2.5±0.3 | 2.00±0.3 | 1.2Max | 0.6±0.3 |

Recommended Pattern



Dimensions in mm

| TYPE | A | B | C |
|---------|-----|-----|-----|
| 201610A | 0.7 | 2.3 | 1.8 |
| 252010A | 1.2 | 2.8 | 2.3 |
| 252012A | 1.2 | 2.8 | 2.3 |

Electrical Characteristics

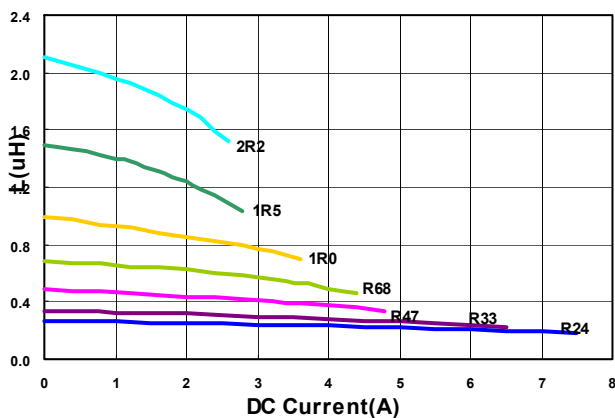
| Part Number | Inductance (uH) | Tolerance (±%) | Test Frequency (MHz) | RDC(mΩ) Max(Typ.) | Isat(A) Max(Typ.) | Irms(A) Max(Typ.) |
|---------------------|-----------------|----------------|----------------------|-------------------|-------------------|-------------------|
| HEIL201610A-R24M-Q8 | 0.24 | 20 | 2 | 27(21) | 5.6(7.0) | 3.9(4.8) |
| HEIL201610A-R33M-Q8 | 0.33 | 20 | 2 | 23(17.5) | 5.3(6.0) | 4.7(5.1) |
| HEIL201610A-R47M-Q8 | 0.47 | 20 | 2 | 42(33) | 3.9(4.8) | 3.5(4.2) |
| HEIL201610A-R68M-Q8 | 0.68 | 20 | 2 | 56(43) | 3.2(4.0) | 2.7(3.4) |
| HEIL201610A-1R0M-Q8 | 1.0 | 20 | 2 | 65(53) | 2.9(3.6) | 2.5(3.1) |
| HEIL201610A-1R5M-Q8 | 1.5 | 20 | 2 | 85(75) | 2.5(2.8) | 2.3(2.7) |
| HEIL201610A-2R2M-Q8 | 2.2 | 20 | 2 | 135(112) | 2.4(2.7) | 1.8(2.2) |

Note: When ordering, please specify tolerance code. Tolerance: M=±20%

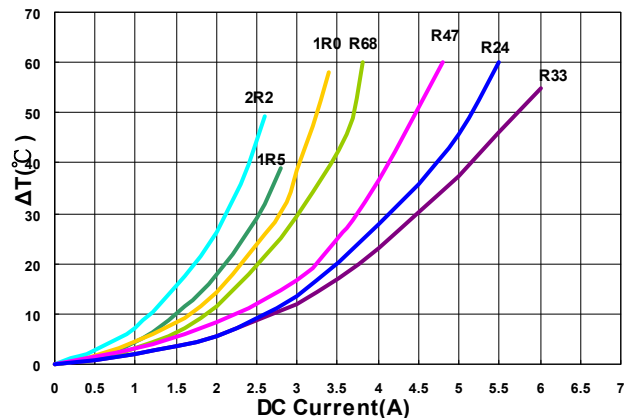
- Operating temperature range - 40°C ~ 125°C(Including self - temperature rise)
- Isat for Inductance drop 30% from its value without current
- I rms for a 40°C temperature rise from 25°C ambient with current
- Absolute maximum voltage 25VDC
- Measure Equipment :
 - L : Agilent E4991/HP4286A+16197A (or equivalent), 2MHz 0.2V
 - RDC : CHEN HWA502BC/HP4338B (or equivalent)
 - Isat : Agilent E4980A+HP42841A (or equivalent)
 - I rms : Agilent 6641 SYSTEM DC POWER SUPPLY (or equivalent)

Test Instruments : E4991A Impedance / Material Analyzer

Inductance vs. DC Current



Temperature Change vs. DC Current



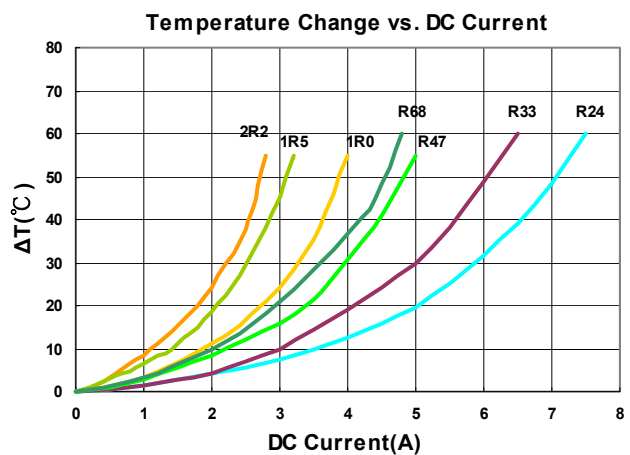
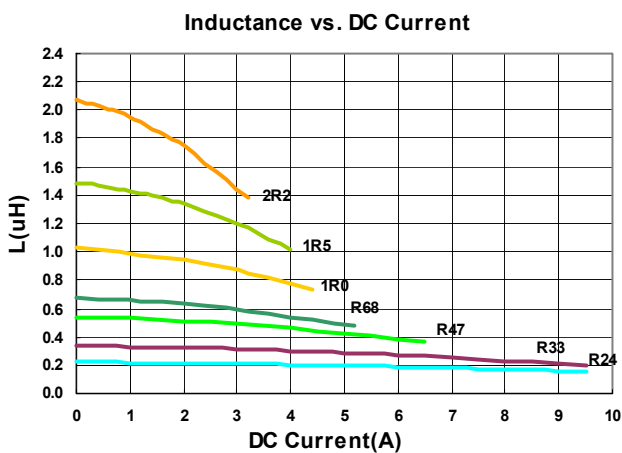
Electrical Characteristics

| Part Number | Inductance (uH) | Tolerance (±%) | Test Frequency (MHz) | RDC(mΩ) Max(Typ.) | Isat(A) Max(Typ.) | Irms(A) Max(Typ.) |
|---------------------|-----------------|----------------|----------------------|-------------------|-------------------|-------------------|
| HEIL252010A-R24M-Q8 | 0.24 | 20 | 2 | 18(13) | 8.0(9.5) | 5.5(6.5) |
| HEIL252010A-R33M-Q8 | 0.33 | 20 | 2 | 24(18) | 6.5(8.0) | 4.8(5.5) |
| HEIL252010A-R47M-Q8 | 0.47 | 20 | 2 | 35(27) | 5.0(6.2) | 3.9(4.5) |
| HEIL252010A-R68M-Q8 | 0.68 | 20 | 2 | 40(32) | 4.5(5.6) | 3.7(4.2) |
| HEIL252010A-1R0M-Q8 | 1.0 | 20 | 2 | 53(45) | 3.7(4.6) | 3.0(3.5) |
| HEIL252010A-1R5M-Q8 | 1.5 | 20 | 2 | 75(68) | 3.1(3.8) | 2.4(2.8) |
| HEIL252010A-2R2M-Q8 | 2.2 | 20 | 2 | 97(87) | 2.5(3.0) | 2.2(2.5) |

Note: When ordering, please specify tolerance code. Tolerance: M=±20%

- Operating temperature range - 40°C ~ 125°C(Including self - temperature rise)
- Isat for Inductance drop 30% from its value without current
- I rms for a 40°C temperature rise from 25°C ambient with current
- Absolute maximum voltage 25VDC
- Measure Equipment :
 - L : Agilent E4991/HP4286A+16197A (or equivalent), 2MHz 0.2V
 - RDC : CHEN HWA502BC/HP4338B (or equivalent)
 - Isat : Agilent E4980A+HP42841A (or equivalent)
 - I rms : Agilent 6641 SYSTEM DC POWER SUPPLY (or equivalent)

Test Instruments : E4991A Impedance / Material Analyzer



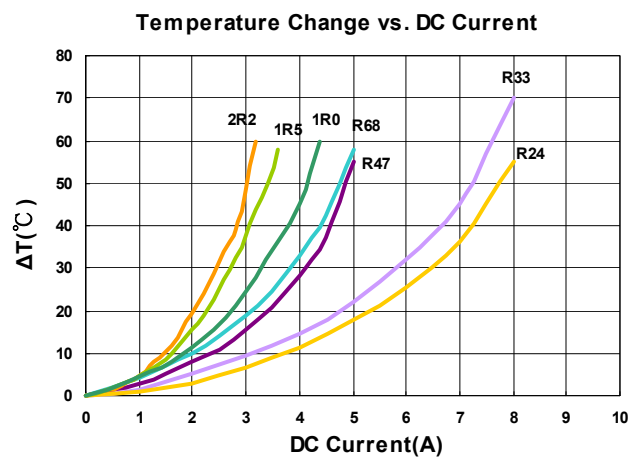
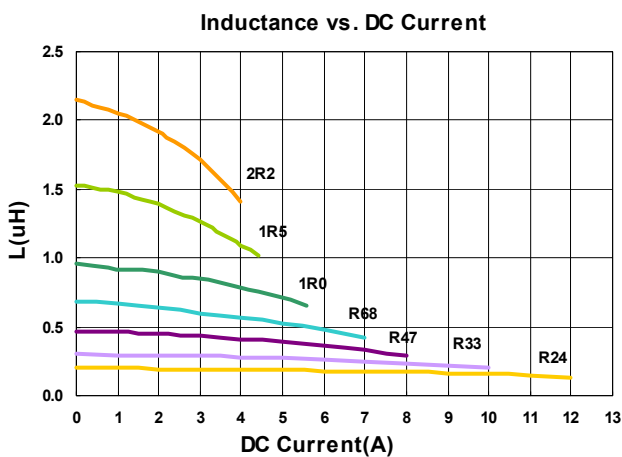
Electrical Characteristics

| Part Number | Inductance (uH) | Tolerance (±%) | Test Frequency (MHz) | RDC(mΩ) Max(Typ.) | Isat(A) Max(Typ.) | Irms(A) Max(Typ.) |
|---------------------|-----------------|----------------|----------------------|-------------------|-------------------|-------------------|
| HEIL252012A-R24M-Q8 | 0.24 | 20 | 2 | 15(11.5) | 9.0(10.5) | 6.2(7.3) |
| HEIL252012A-R33M-Q8 | 0.33 | 20 | 2 | 18(14.5) | 8.5(10) | 5.8(6.4) |
| HEIL252012A-R47M-Q8 | 0.47 | 20 | 2 | 33(28) | 5.6(7.0) | 3.8(4.5) |
| HEIL252012A-R68M-Q8 | 0.68 | 20 | 2 | 36(30) | 5.0(6.2) | 3.8(4.4) |
| HEIL252012A-1R0M-Q8 | 1.0 | 20 | 2 | 42(35) | 4.4(5.5) | 3.6(4.1) |
| HEIL252012A-1R5M-Q8 | 1.5 | 20 | 2 | 65(57) | 3.4(4.2) | 2.7(3.1) |
| HEIL252012A-2R2M-Q8 | 2.2 | 20 | 2 | 83(74) | 3.0(3.7) | 2.5(2.9) |

Note: When ordering, please specify tolerance code. Tolerance: M=±20%

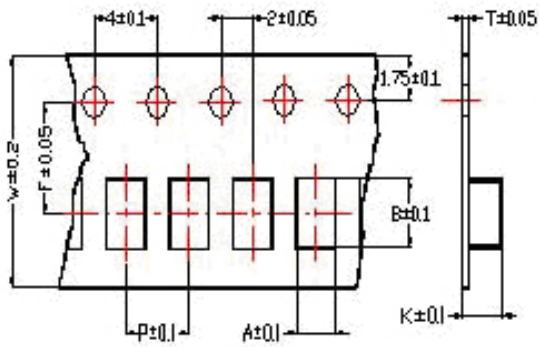
- Operating temperature range - 40°C ~ 125°C(Including self - temperature rise)
- Isat for Inductance drop 30% from its value without current
- I rms for a 40°C temperature rise from 25°C ambient with current
- Absolute maximum voltage 25VDC
- Measure Equipment :
 L : Agilent E4991/HP4286A+16197A (or equivalent), 2MHz 0.2V
 RDC : CHEN HWA502BC/HP4338B (or equivalent)
 Isat : Agilent E4980A+HP42841A (or equivalent)
 I rms : Agilent 6641 SYSTEM DC POWER SUPPLY (or equivalent)

Test Instruments : E4991A Impedance / Material Analyzer

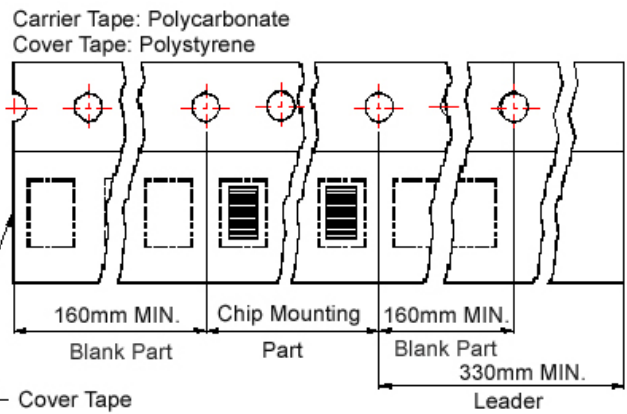


Packaging Specifications

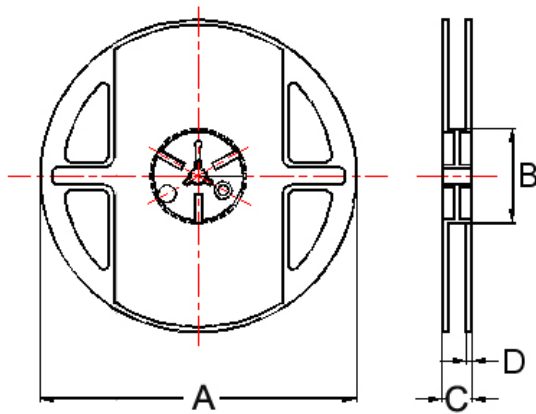
Tape Dimensions



Tape Material



Reel Dimensions



Dimensions in mm

| TYPE | Tape Dimensions | | | | | | | Reel Dimensions | | | | Quantity PCS / REEL |
|---------|-----------------|------|------|---|---|-----|------|-----------------|----|----|-----|------------------------|
| | A | B | T | W | P | F | K | A | B | C | D | |
| 201610A | 1.80 | 2.20 | 0.22 | 8 | 4 | 3.5 | 1.15 | 178 | 60 | 12 | 1.5 | 3000 |
| 252010A | 2.25 | 2.80 | 0.22 | 8 | 4 | 3.5 | 1.15 | 178 | 60 | 12 | 1.5 | 3000 |
| 252012A | 2.25 | 2.80 | 0.22 | 8 | 4 | 3.5 | 1.35 | 178 | 60 | 12 | 1.5 | 3000 |

MHCD Series



MHCD Series provides high current in compact package size with magnetically shielded construction. This power inductor is an excellent power solution for space-limited devices.

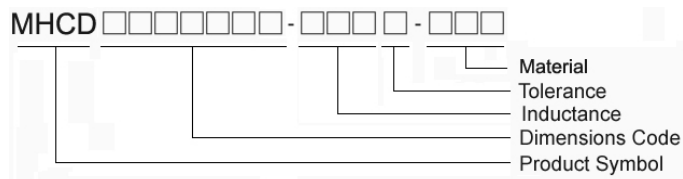
Features

- RoHS, Halogen Free and REACH Compliance
- Monolithic, magnetically shielded
- Capable for large current

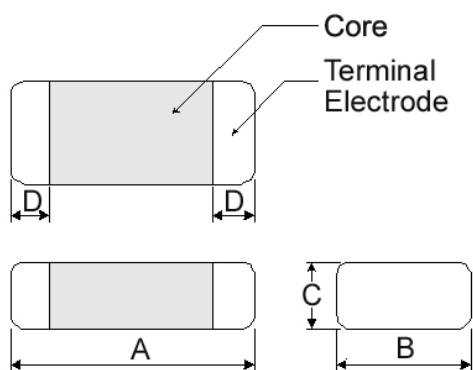
Applications

- Smartphones, tablets and wearable devices
- HDD, SSD and PC peripheral devices
- DSC, camcoders
- PND
- DC/DC converters

Product Identification



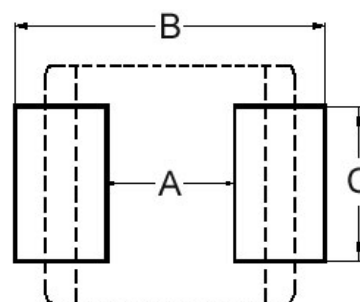
Shape and Dimensions



Dimensions in mm

| TYPE | A | B | C | D |
|--------|---------|---------|--------|---------|
| 201610 | 2.0±0.2 | 1.6±0.2 | 1.0Max | 0.5±0.3 |
| 201612 | 2.0±0.2 | 1.6±0.2 | 1.2Max | 0.5±0.3 |
| 252010 | 2.5±0.2 | 2.0±0.2 | 1.0Max | 0.6±0.3 |
| 252012 | 2.5±0.2 | 2.0±0.2 | 1.2Max | 0.6±0.3 |
| 322510 | 3.2±0.3 | 2.5±0.3 | 1.0Max | 0.5±0.3 |
| 322512 | 3.2±0.3 | 2.5±0.3 | 1.2Max | 0.5±0.3 |

Recommended Pattern



Dimensions in mm

| TYPE | A | B | C |
|--------|-----|-----|-----|
| 201610 | 0.7 | 2.3 | 1.8 |
| 201612 | 0.7 | 2.3 | 1.8 |
| 252010 | 1.2 | 2.8 | 2.3 |
| 252012 | 1.2 | 2.8 | 2.3 |
| 322510 | 1.7 | 3.5 | 2.8 |
| 322512 | 1.7 | 3.5 | 2.8 |

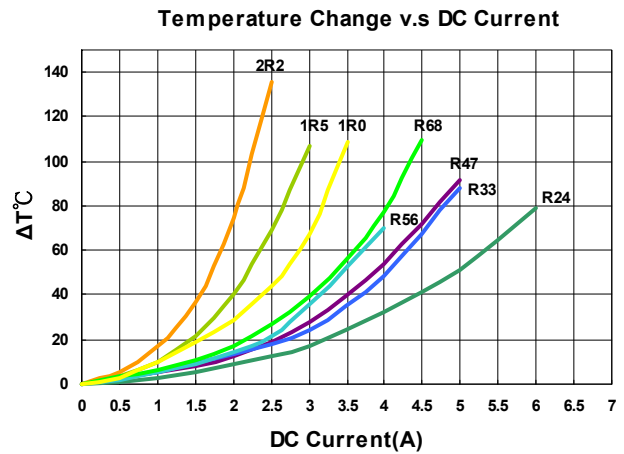
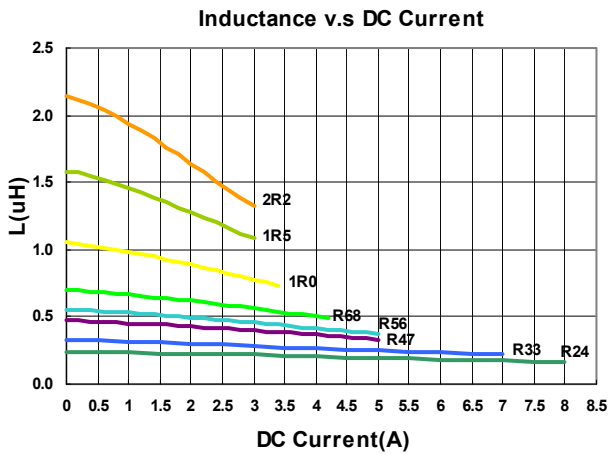
Electrical Characteristics

| Part Number | Inductance (uH) | Tolerance (±%) | Test Frequency (MHz) | RDC(mΩ) Max(Typ.) | Isat(A) Max(Typ.) | Irms(A) Max(Typ.) |
|----------------------|-----------------|----------------|----------------------|-------------------|-------------------|-------------------|
| MHCD201610A-R24M-A8S | 0.24 | 20 | 2 | 40(28) | 4.2(6.0) | 4.0(4.5) |
| MHCD201610A-R33M-A8S | 0.33 | 20 | 2 | 48(40) | 4.0(5.5) | 3.5(3.8) |
| MHCD201610A-R47M-A8S | 0.47 | 20 | 2 | 54(44) | 3.2(5.0) | 3.0(3.6) |
| MHCD201610A-R56M-A8S | 0.56 | 20 | 2 | 59(46) | 2.8(4.6) | 2.8(3.3) |
| MHCD201610A-R68M-A8S | 0.68 | 20 | 2 | 72(55) | 2.7(4.2) | 2.4(3.0) |
| MHCD201610A-1R0M-A8S | 1.0 | 20 | 2 | 96(81) | 2.2(3.4) | 2.0(2.3) |
| MHCD201610A-1R5M-A8S | 1.5 | 20 | 2 | 150(122) | 2.1(2.8) | 1.6(2.0) |
| MHCD201610A-2R2M-A8S | 2.2 | 20 | 2 | 204(170) | 2.0(2.4) | 1.3(1.6) |

Note: When ordering, please specify tolerance code. Tolerance: M=±20%

- Operating temperature range - 40°C ~ 125°C(Including self - temperature rise)
- Isat for Inductance drop 30% from its value without current
- I rms for a 40°C temperature rise from 25°C ambient with current
- Absolute maximum voltage 25VDC
- Measure Equipment :
 L : Agilent E4991/HP4286A+16197A (or equivalent), 2MHz 0.2V
 RDC : CHEN HWA502BC/HP4338B (or equivalent)
 Isat : Agilent E4980A+HP42841A (or equivalent)
 I rms : Agilent 6641 SYSTEM DC POWER SUPPLY (or equivalent)

Test Instruments : E4991A Impedance / Material Analyzer



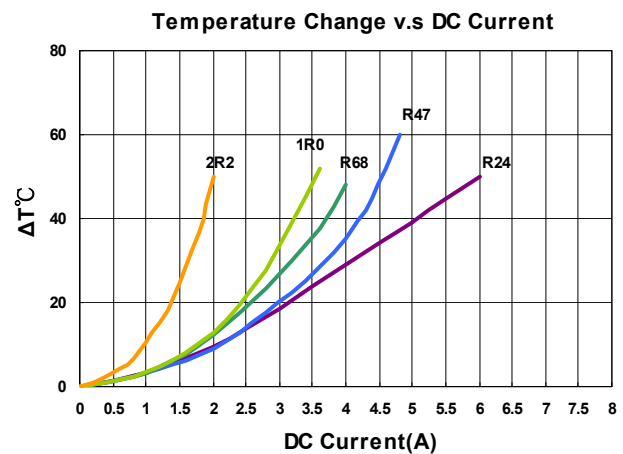
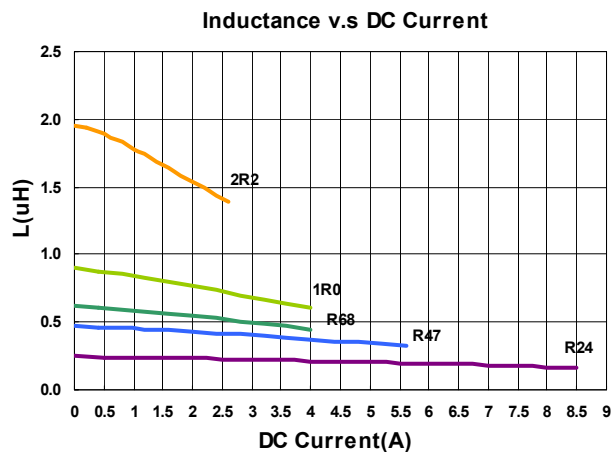
Electrical Characteristics

| Part Number | Inductance (uH) | Tolerance (±%) | Test Frequency (MHz) | RDC(mΩ) Max(Typ.) | Isat(A) Max(Typ.) | Irms(A) Max(Typ.) |
|----------------------|-----------------|----------------|----------------------|-------------------|-------------------|-------------------|
| MHCD201610B-R24M-A8L | 0.24 | 20 | 2 | 30(23) | 5.0(6.0) | 3.8(4.4) |
| MHCD201610B-R47M-A8L | 0.47 | 20 | 2 | 41(34) | 4.0(4.5) | 2.9(3.3) |
| MHCD201610B-R68M-A8L | 0.68 | 20 | 2 | 53(44) | 3.3(3.6) | 2.5(2.9) |
| MHCD201610B-1R0M-A8L | 1.0 | 20 | 2 | 72(60) | 2.8(3.2) | 2.2(2.5) |
| MHCD201610B-2R2M-A8L | 2.2 | 20 | 2 | 170(142) | 1.8(2.1) | 1.5(1.7) |

Note: When ordering, please specify tolerance code. Tolerance: M=±20%

- Operating temperature range - 40°C ~ 125°C(Including self - temperature rise)
- Isat for Inductance drop 30% from its value without current
- I rms for a 40°C temperature rise from 25°C ambient with current
- Absolute maximum voltage 25VDC
- Measure Equipment :
 L : Agilent E4991/HP4286A+16197A (or equivalent), 2MHz 0.2V
 RDC : CHEN HWA502BC/HP4338B (or equivalent)
 Isat : Agilent E4980A+HP42841A (or equivalent)
 I rms : Agilent 6641 SYSTEM DC POWER SUPPLY (or equivalent)

Test Instruments : E4991A Impedance / Material Analyzer



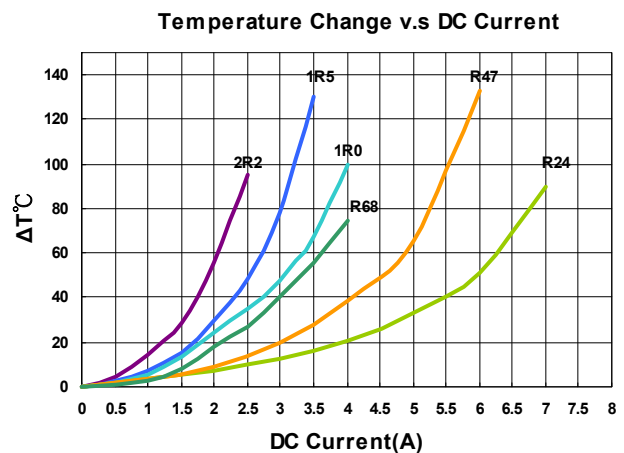
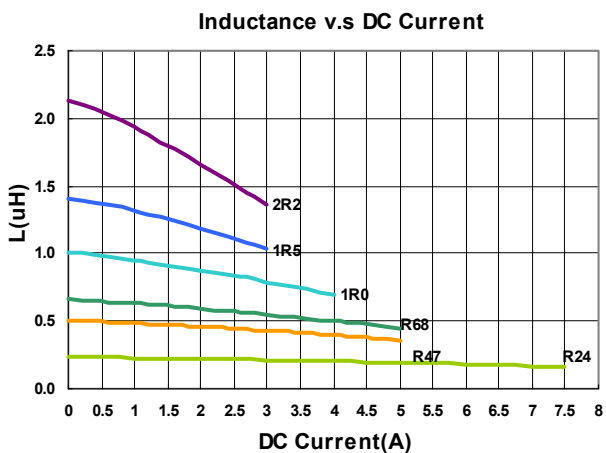
Electrical Characteristics

| Part Number | Inductance (uH) | Tolerance (±%) | Test Frequency (MHz) | RDC(mΩ) Max(Typ.) | Isat(A) Max(Typ.) | Irms(A) Max(Typ.) |
|----------------------|-----------------|----------------|----------------------|-------------------|-------------------|-------------------|
| MHCD201612A-R24M-A8S | 0.24 | 20 | 2 | 35(25) | 5.5(6.5) | 4.2(4.8) |
| MHCD201612A-R47M-A8S | 0.47 | 20 | 2 | 52(40) | 3.8(5.1) | 3.2(3.8) |
| MHCD201612A-R68M-A8S | 0.68 | 20 | 2 | 70(53) | 3.3(4.8) | 2.6(3.2) |
| MHCD201612A-1R0M-A8S | 1.0 | 20 | 2 | 82(67) | 3.1(3.9) | 2.3(2.7) |
| MHCD201612A-1R5M-A8S | 1.5 | 20 | 2 | 120(95) | 2.6(3.2) | 2.2(2.6) |
| MHCD201612A-2R2M-A8S | 2.2 | 20 | 2 | 195(165) | 2.0(2.6) | 1.3(1.7) |

Note: When ordering, please specify tolerance code. Tolerance: M=±20%

- Operating temperature range - 40°C ~ 125°C(Including self - temperature rise)
- Isat for Inductance drop 30% from its value without current
- I rms for a 40°C temperature rise from 25°C ambient with current
- Absolute maximum voltage 25VDC
- Measure Equipment :
 L : Agilent E4991/HP4286A+16197A (or equivalent), 2MHz 0.2V
 RDC : CHEN HWA502BC/HP4338B (or equivalent)
 Isat : Agilent E4980A+HP42841A (or equivalent)
 I rms : Agilent 6641 SYSTEM DC POWER SUPPLY (or equivalent)

Test Instruments : E4991A Impedance / Material Analyzer



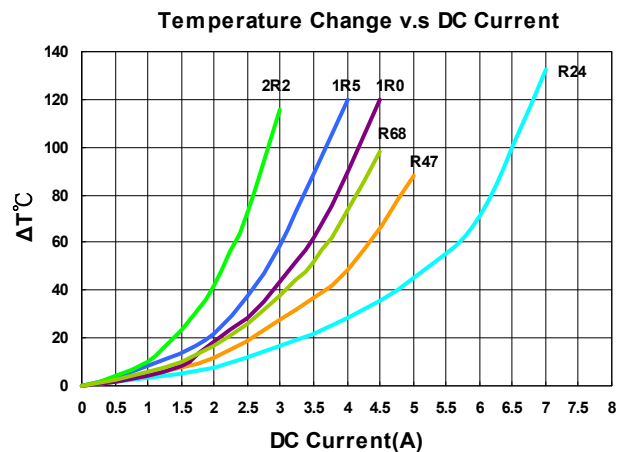
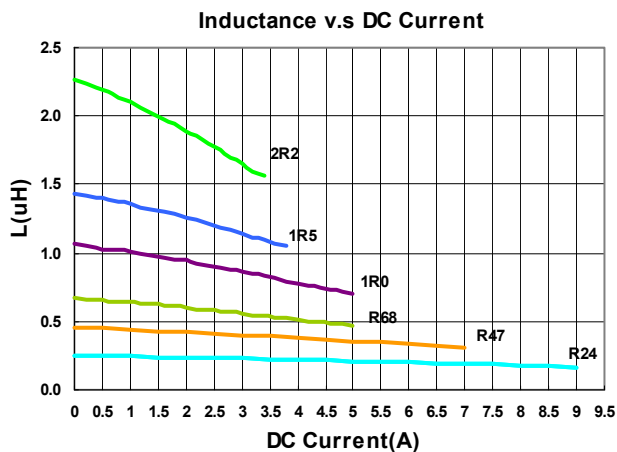
Electrical Characteristics

| Part Number | Inductance (uH) | Tolerance (±%) | Test Frequency (MHz) | RDC(mΩ) Max(Typ.) | Isat(A) Max(Typ.) | Irms(A) Max(Typ.) |
|----------------------|-----------------|----------------|----------------------|-------------------|-------------------|-------------------|
| MHCD252010A-R24M-A8S | 0.24 | 20 | 2 | 40(24) | 7.5(9.5) | 4.5(5.0) |
| MHCD252010A-R47M-A8S | 0.47 | 20 | 2 | 46(36) | 5.2(6.5) | 3.1(3.6) |
| MHCD252010A-R68M-A8S | 0.68 | 20 | 2 | 65(49) | 3.8(5.0) | 2.9(3.3) |
| MHCD252010A-1R0M-A8S | 1.0 | 20 | 2 | 78(60) | 3.4(4.3) | 2.5(3.0) |
| MHCD252010A-1R5M-A8S | 1.5 | 20 | 2 | 105(82) | 3.2(4.0) | 2.2(2.9) |
| MHCD252010A-2R2M-A8S | 2.2 | 20 | 2 | 156(130) | 2.6(3.2) | 1.4(1.8) |

Note: When ordering, please specify tolerance code. Tolerance: M=±20%

- Operating temperature range - 40°C ~ 125°C(Including self - temperature rise)
- Isat for Inductance drop 30% from its value without current
- I rms for a 40°C temperature rise from 25°C ambient with current
- Absolute maximum voltage 25VDC
- Measure Equipment :
 - L : Agilent E4991/HP4286A+16197A (or equivalent), 2MHz 0.2V
 - RDC : CHEN HWA502BC/HP4338B (or equivalent)
 - Isat : Agilent E4980A+HP42841A (or equivalent)
 - I rms : Agilent 6641 SYSTEM DC POWER SUPPLY (or equivalent)

Test Instruments : E4991A Impedance / Material Analyzer



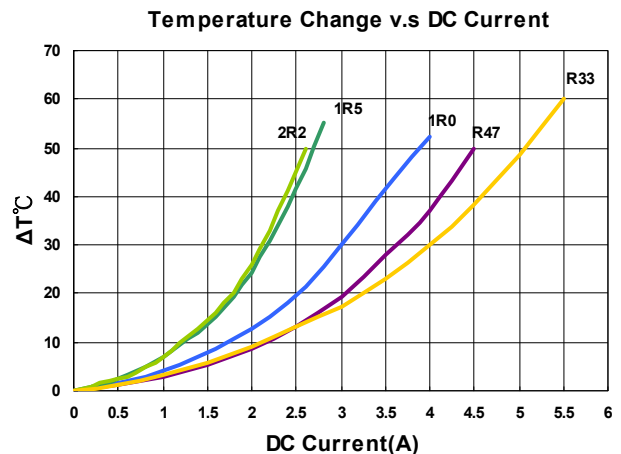
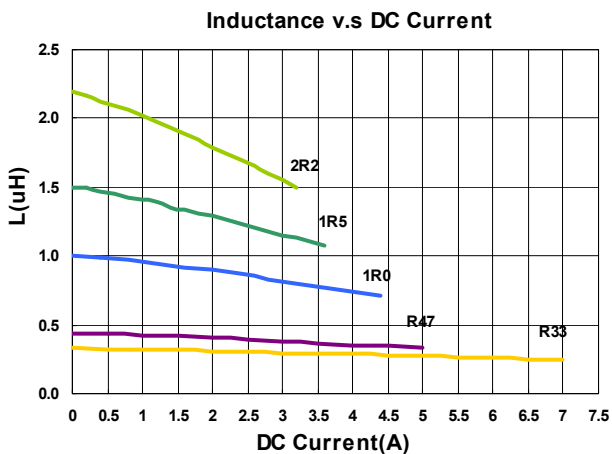
Electrical Characteristics

| Part Number | Inductance (uH) | Tolerance (±%) | Test Frequency (MHz) | RDC(mΩ) Max(Typ.) | Isat(A) Max(Typ.) | Irms(A) Max(Typ.) |
|----------------------|-----------------|----------------|----------------------|-------------------|-------------------|-------------------|
| MHCD252010B-R33M-A8L | 0.33 | 20 | 2 | 31(25) | 5.0(6.0) | 3.8(4.4) |
| MHCD252010B-R47M-A8L | 0.47 | 20 | 2 | 35(29) | 4.2(4.7) | 3.4(3.9) |
| MHCD252010B-R68M-A8L | 0.68 | 20 | 2 | 48(40) | 3.7(4.0) | 3.0(3.5) |
| MHCD252010B-1R0M-A8L | 1.0 | 20 | 2 | 65(54) | 3.2(3.6) | 2.6(3.0) |
| MHCD252010B-1R5M-A8L | 1.5 | 20 | 2 | 94(78) | 2.9(3.3) | 2.1(2.4) |
| MHCD252010B-2R2M-A8L | 2.2 | 20 | 2 | 120(100) | 2.3(2.7) | 1.8(2.1) |

Note: When ordering, please specify tolerance code. Tolerance: M=±20%

- Operating temperature range - 40°C ~ 125°C(Including self - temperature rise)
- Isat for Inductance drop 30% from its value without current
- I rms for a 40°C temperature rise from 25°C ambient with current
- Absolute maximum voltage 25VDC
- Measure Equipment :
 L : Agilent E4991/HP4286A+16197A (or equivalent), 2MHz 0.2V
 RDC : CHEN HWA502BC/HP4338B (or equivalent)
 Isat : Agilent E4980A+HP42841A (or equivalent)
 I rms : Agilent 6641 SYSTEM DC POWER SUPPLY (or equivalent)

Test Instruments : E4991A Impedance / Material Analyzer



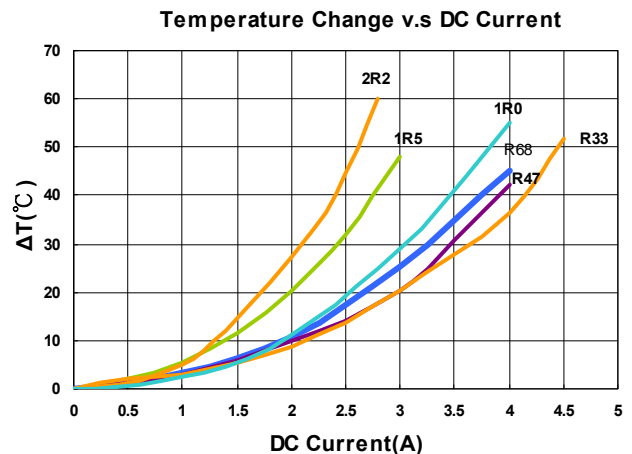
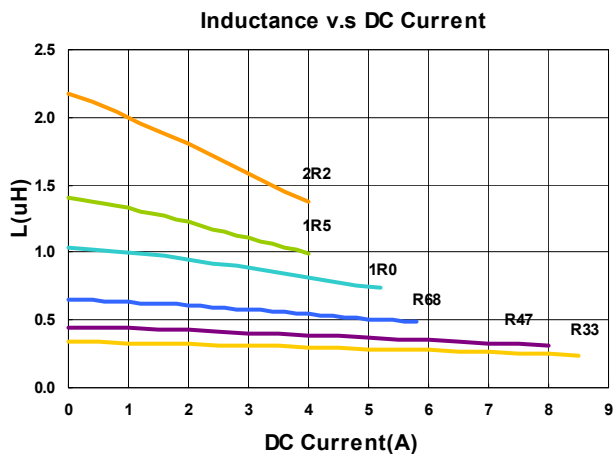
Electrical Characteristics

| Part Number | Inductance (uH) | Tolerance (±%) | Test Frequency (MHz) | RDC(mΩ) Max(Typ.) | Isat(A) Max(Typ.) | Irms(A) Max(Typ.) |
|----------------------|-----------------|----------------|----------------------|-------------------|-------------------|-------------------|
| MHCD252012A-R33M-A8S | 0.33 | 20 | 2 | 35(27) | 6.8(8.5) | 4.0(4.6) |
| MHCD252012A-R47M-A8S | 0.47 | 20 | 2 | 39(29) | 6.2(7.8) | 3.7(4.4) |
| MHCD252012A-R68M-A8S | 0.68 | 20 | 2 | 46(40) | 5.5(6.5) | 3.3(3.7) |
| MHCD252012A-1R0M-A8S | 1.0 | 20 | 2 | 59(45) | 4.0(5.0) | 3.0(3.5) |
| MHCD252012A-1R5M-A8S | 1.5 | 20 | 2 | 70(62) | 3.4(4.0) | 2.5(2.7) |
| MHCD252012A-2R2M-A8S | 2.2 | 20 | 2 | 115(102) | 3.3(3.8) | 2.0(2.3) |

Note: When ordering, please specify tolerance code. Tolerance: M=±20%

- Operating temperature range - 40°C ~ 125°C(Including self - temperature rise)
- Isat for Inductance drop 30% from its value without current
- I rms for a 40°C temperature rise from 25°C ambient with current
- Absolute maximum voltage 25VDC
- Measure Equipment :
 L : Agilent E4991/HP4286A+16197A (or equivalent), 2MHz 0.2V
 RDC : CHEN HWA502BC/HP4338B (or equivalent)
 Isat : Agilent E4980A+HP42841A (or equivalent)
 I rms : Agilent 6641 SYSTEM DC POWER SUPPLY (or equivalent)

Test Instruments : E4991A Impedance / Material Analyzer



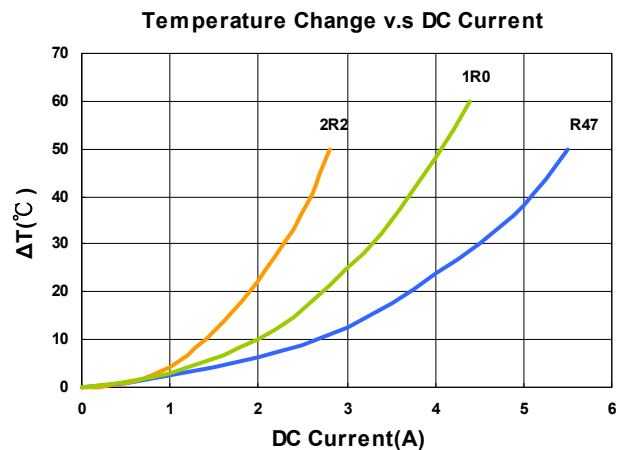
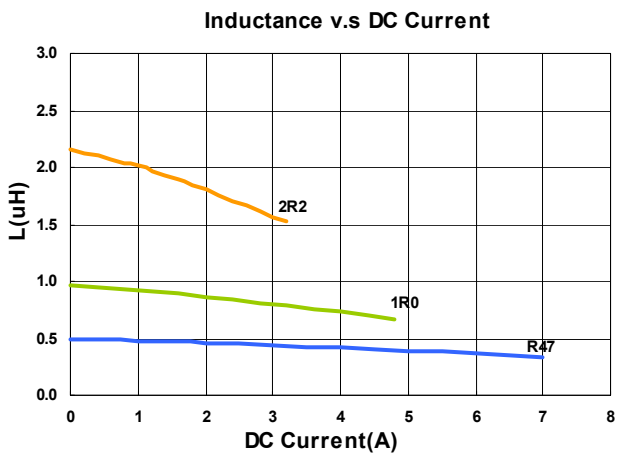
Electrical Characteristics

| Part Number | Inductance (uH) | Tolerance (±%) | Test Frequency (MHz) | RDC(mΩ) Max(Typ.) | Isat(A) Max(Typ.) | Irms(A) Max(Typ.) |
|----------------------|-----------------|----------------|----------------------|-------------------|-------------------|-------------------|
| MHCD252012B-R47M-A8L | 0.47 | 20 | 2 | 34(30) | 5.2(6.0) | 4.1(4.7) |
| MHCD252012B-1R0M-A8L | 1.0 | 20 | 2 | 56(45) | 3.6(4.5) | 3.2(3.7) |
| MHCD252012B-2R2M-A8L | 2.2 | 20 | 2 | 102(80) | 2.5(3.0) | 2.2(2.6) |

Note: When ordering, please specify tolerance code. Tolerance: M=±20%

- Operating temperature range - 40°C ~ 125°C(Including self - temperature rise)
- Isat for Inductance drop 30% from its value without current
- I rms for a 40°C temperature rise from 25°C ambient with current
- Absolute maximum voltage 25VDC
- Measure Equipment :
 L : Agilent E4991/HP4286A+16197A (or equivalent), 2MHz 0.2V
 RDC : CHEN HWA502BC/HP4338B (or equivalent)
 Isat : Agilent E4980A+HP42841A (or equivalent)
 I rms : Agilent 6641 SYSTEM DC POWER SUPPLY (or equivalent)

Test Instruments : E4991A Impedance / Material Analyzer



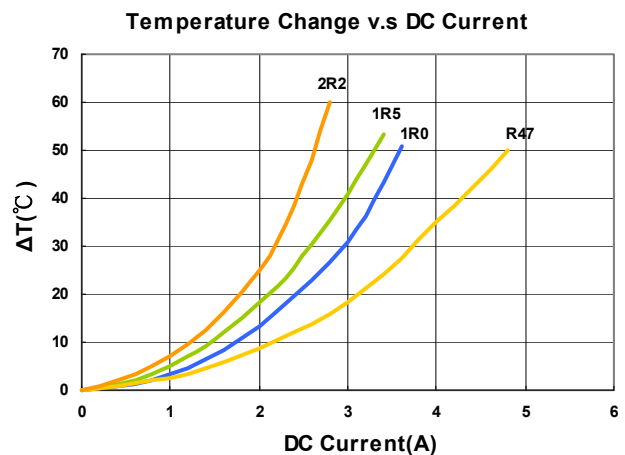
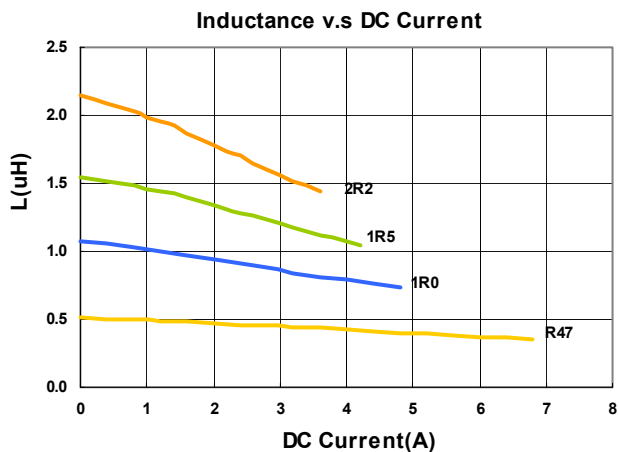
Electrical Characteristics

| Part Number | Inductance (uH) | Tolerance (±%) | Test Frequency (MHz) | RDC(mΩ) Max(Typ.) | Isat(A) Max(Typ.) | Irms(A) Max(Typ.) |
|----------------------|-----------------|----------------|----------------------|-------------------|-------------------|-------------------|
| MHCD322510A-R47M-A8S | 0.47 | 20 | 2 | 37(30) | 5.8(6.6) | 3.6(4.2) |
| MHCD322510A-1R0M-A8S | 1.0 | 20 | 2 | 56(49) | 4.0(4.6) | 3.0(3.3) |
| MHCD322510A-1R5M-A8S | 1.5 | 20 | 2 | 75(66) | 3.4(4.0) | 2.6(3.0) |
| MHCD322510A-2R2M-A8S | 2.2 | 20 | 2 | 108(95) | 2.7(3.2) | 2.2(2.5) |

Note: When ordering, please specify tolerance code. Tolerance: M=±20%

- Operating temperature range - 40°C ~ 125°C(Including self - temperature rise)
- Isat for Inductance drop 30% from its value without current
- I rms for a 40°C temperature rise from 25°C ambient with current
- Absolute maximum voltage 25VDC
- Measure Equipment :
 L : Agilent E4991/HP4286A+16197A (or equivalent), 2MHz 0.2V
 RDC : CHEN HWA502BC/HP4338B (or equivalent)
 Isat : Agilent E4980A+HP42841A (or equivalent)
 I rms : Agilent 6641 SYSTEM DC POWER SUPPLY (or equivalent)

Test Instruments : E4991A Impedance / Material Analyzer



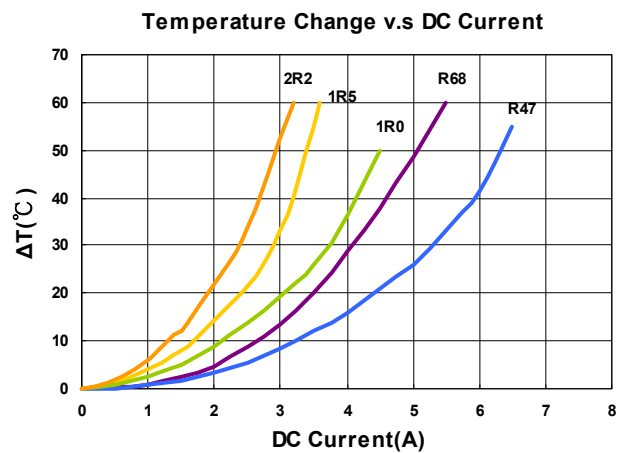
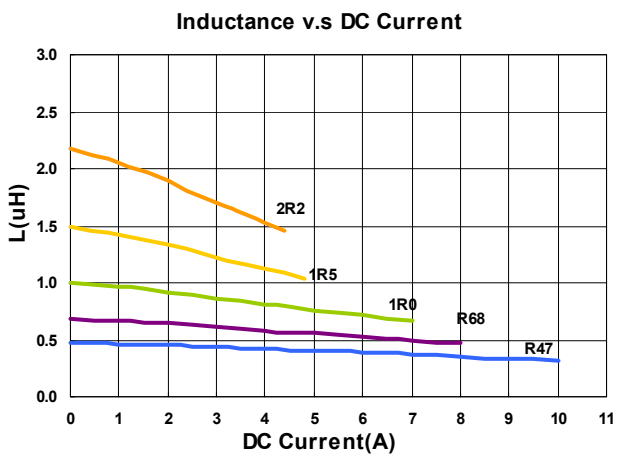
Electrical Characteristics

| Part Number | Inductance (uH) | Tolerance (±%) | Test Frequency (MHz) | RDC(mΩ) Max(Typ.) | Isat(A) Max(Typ.) | Irms(A) Max(Typ.) |
|----------------------|-----------------|----------------|----------------------|-------------------|-------------------|-------------------|
| MHCD322512A-R47M-A8S | 0.47 | 20 | 2 | 27(21) | 8.0(9.0) | 5.0(5.8) |
| MHCD322512A-R68M-A8S | 0.68 | 20 | 2 | 34(26) | 6.3(7.5) | 4.0(4.6) |
| MHCD322512A-1R0M-A8S | 1.0 | 20 | 2 | 42(34) | 5.8(6.3) | 3.8(4.2) |
| MHCD322512A-1R5M-A8S | 1.5 | 20 | 2 | 68(58) | 4.0(4.5) | 2.8(3.2) |
| MHCD322512A-2R2M-A8S | 2.2 | 20 | 2 | 85(75) | 3.6(4.0) | 2.4(2.7) |

Note: When ordering, please specify tolerance code. Tolerance: M=±20%

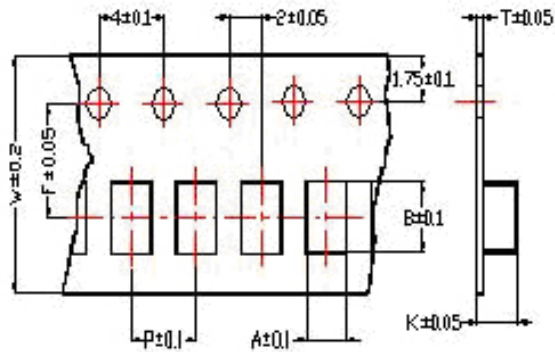
- Operating temperature range - 40°C ~ 125°C(Including self - temperature rise)
- Isat for Inductance drop 30% from its value without current
- I rms for a 40°C temperature rise from 25°C ambient with current
- Absolute maximum voltage 25VDC
- Measure Equipment :
 L : Agilent E4991/HP4286A+16197A (or equivalent), 2MHz 0.2V
 RDC : CHEN HWA502BC/HP4338B (or equivalent)
 Isat : Agilent E4980A+HP42841A (or equivalent)
 I rms : Agilent 6641 SYSTEM DC POWER SUPPLY (or equivalent)

Test Instruments : E4991A Impedance / Material Analyzer

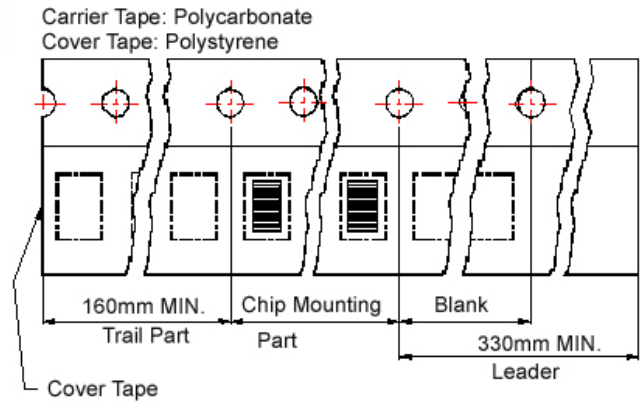


Packaging Specifications

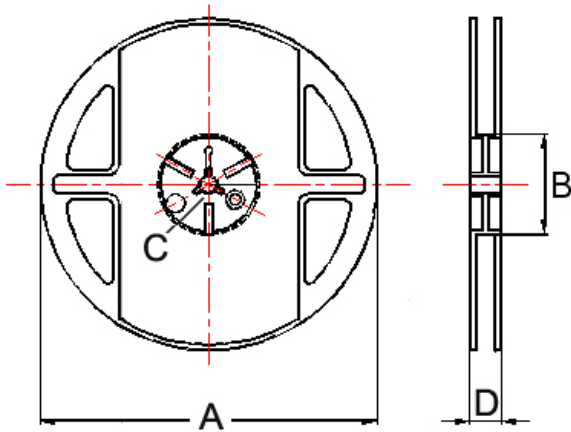
Tape Dimensions



Tape Material



Reel Dimensions



Dimensions in mm

| TYPE | Tape Dimensions | | | | | | | Reel Dimensions | | | | Quantity PCS / REEL |
|--------|-----------------|------|------|---|---|-----|------|-----------------|----|----|-----|------------------------|
| | A | B | T | W | P | F | K | A | B | C | D | |
| 201610 | 1.80 | 2.20 | 0.22 | 8 | 4 | 3.5 | 1.15 | 178 | 60 | 12 | 1.5 | 3000 |
| 201612 | 1.80 | 2.20 | 0.22 | 8 | 4 | 3.5 | 1.15 | 178 | 60 | 12 | 1.5 | 3000 |
| 252010 | 2.25 | 2.80 | 0.22 | 8 | 4 | 3.5 | 1.15 | 178 | 60 | 12 | 1.5 | 3000 |
| 252012 | 2.25 | 2.80 | 0.22 | 8 | 4 | 3.5 | 1.35 | 178 | 60 | 12 | 1.5 | 3000 |
| 322510 | 2.80 | 3.55 | 0.23 | 8 | 4 | 3.5 | 1.20 | 178 | 60 | 12 | 1.5 | 3000 |
| 322512 | 2.80 | 3.50 | 0.23 | 8 | 4 | 3.5 | 1.34 | 178 | 60 | 12 | 1.5 | 3000 |

MHCL Series



MHCL Series provides high current in compact package size with magnetically shielded construction. This power inductor is an excellent power solution for space-limited devices.

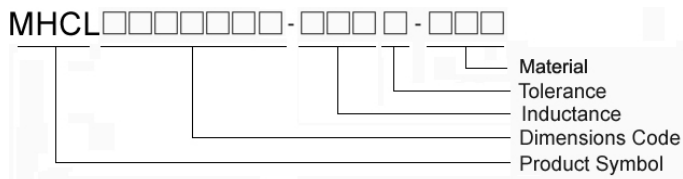
Features

- RoHS, Halogen Free and REACH Compliance
- Monolithic, magnetically shielded
- Capable for large current

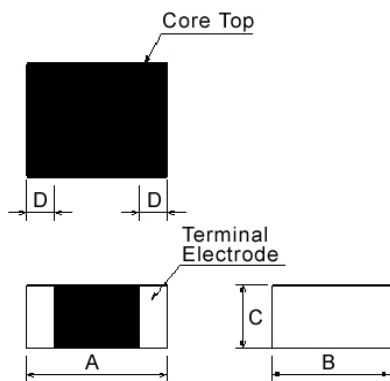
Applications

- Smartphones, tablets and wearable devices
- HDD, SSD and PC peripheral devices
- DSC, camcoders
- PND
- DC/DC converters

Product Identification



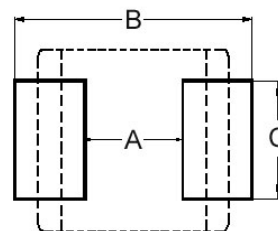
Shape and Dimensions



Dimensions in mm

| TYPE | A | B | C | D |
|--------|---------|---------|--------|---------|
| 201610 | 2.0±0.2 | 1.6±0.2 | 1.0Max | 0.5±0.3 |
| 201612 | 2.0±0.2 | 1.6±0.2 | 1.2Max | 0.5±0.3 |
| 252010 | 2.5±0.2 | 2.0±0.2 | 1.0Max | 0.6±0.3 |
| 252012 | 2.5±0.2 | 2.0±0.2 | 1.2Max | 0.6±0.3 |

Recommended Pattern



Dimensions in mm

| TYPE | A | B | C |
|--------|-----|-----|-----|
| 201610 | 0.7 | 2.3 | 1.8 |
| 201612 | 0.7 | 2.3 | 1.8 |
| 252010 | 1.2 | 2.8 | 2.3 |
| 252012 | 1.2 | 2.8 | 2.3 |

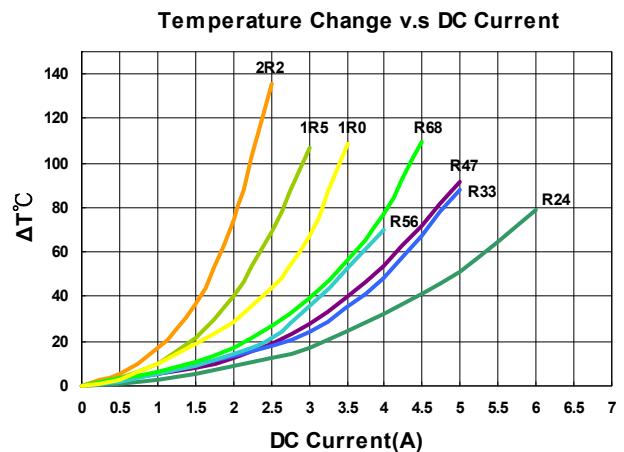
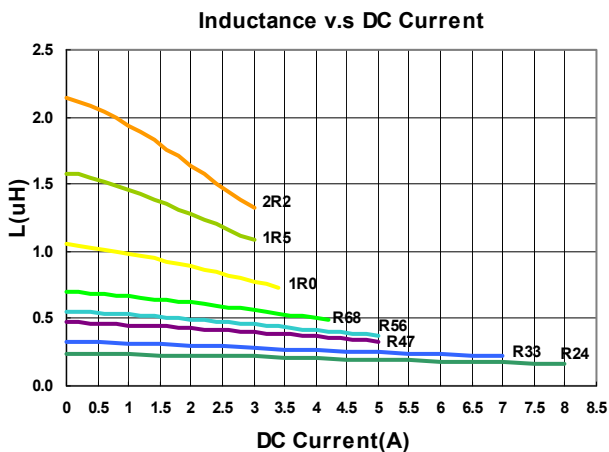
Electrical Characteristics

| Part Number | Inductance (uH) | Tolerance (±%) | Test Frequency (MHz) | RDC(mΩ) Max(Typ.) | Isat(A) Max(Typ.) | Irms(A) Max(Typ.) |
|----------------------|-----------------|----------------|----------------------|-------------------|-------------------|-------------------|
| MHCL201610A-R24M-A8S | 0.24 | 20 | 2 | 40(28) | 4.2(6.0) | 4.0(4.5) |
| MHCL201610A-R33M-A8S | 0.33 | 20 | 2 | 48(40) | 4.0(5.5) | 3.5(3.8) |
| MHCL201610A-R47M-A8S | 0.47 | 20 | 2 | 54(44) | 3.2(5.0) | 3.0(3.6) |
| MHCL201610A-R56M-A8S | 0.56 | 20 | 2 | 59(46) | 2.8(4.6) | 2.8(3.3) |
| MHCL201610A-R68M-A8S | 0.68 | 20 | 2 | 72(55) | 2.7(4.2) | 2.4(3.0) |
| MHCL201610A-1R0M-A8S | 1.0 | 20 | 2 | 96(81) | 2.2(3.4) | 2.0(2.3) |
| MHCL201610A-1R5M-A8S | 1.5 | 20 | 2 | 150(122) | 2.1(2.8) | 1.6(2.0) |
| MHCL201610A-2R2M-A8S | 2.2 | 20 | 2 | 204(170) | 2.0(2.4) | 1.3(1.6) |

Note: When ordering, please specify tolerance code. Tolerance: M=±20%

- Operating temperature range - 40°C ~ 125°C(Including self - temperature rise)
- Isat for Inductance drop 30% from its value without current
- I rms for a 40°C temperature rise from 25°C ambient with current
- Absolute maximum voltage 25VDC
- Measure Equipment :
 L : Agilent E4991/HP4286A+16197A (or equivalent), 2MHz 0.2V
 RDC : CHEN HWA502BC/HP4338B (or equivalent)
 Isat : Agilent E4980A+HP42841A (or equivalent)
 I rms : Agilent 6641 SYSTEM DC POWER SUPPLY (or equivalent)

Test Instruments : E4991A Impedance / Material Analyzer



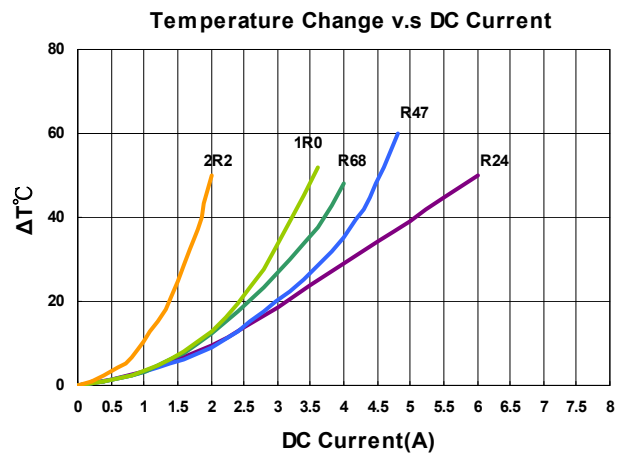
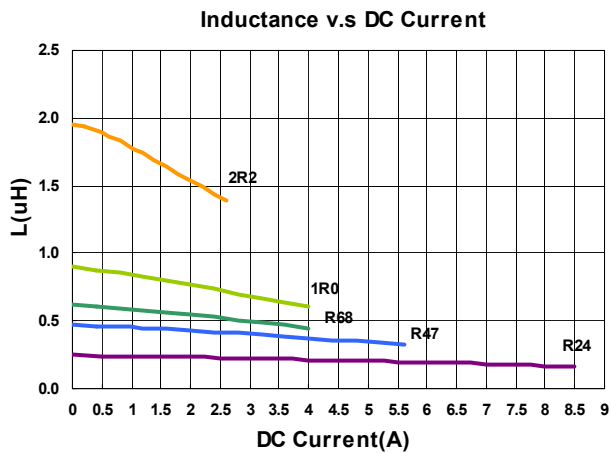
Electrical Characteristics

| Part Number | Inductance (uH) | Tolerance (±%) | Test Frequency (MHz) | RDC(mΩ) Max(Typ.) | Isat(A) Max(Typ.) | Irms(A) Max(Typ.) |
|----------------------|-----------------|----------------|----------------------|-------------------|-------------------|-------------------|
| MHCL201610B-R24M-A8L | 0.24 | 20 | 2 | 30(23) | 5.0(6.0) | 3.8(4.4) |
| MHCL201610B-R47M-A8L | 0.47 | 20 | 2 | 41(34) | 4.0(4.5) | 2.9(3.3) |
| MHCL201610B-R68M-A8L | 0.68 | 20 | 2 | 53(44) | 3.3(3.6) | 2.5(2.9) |
| MHCL201610B-1R0M-A8L | 1.0 | 20 | 2 | 72(60) | 2.8(3.2) | 2.2(2.5) |
| MHCL201610B-2R2M-A8L | 2.2 | 20 | 2 | 170(142) | 1.8(2.1) | 1.5(1.7) |

Note: When ordering, please specify tolerance code. Tolerance: M=±20%

- Operating temperature range - 40°C ~ 125°C(Including self - temperature rise)
- Isat for Inductance drop 30% from its value without current
- I rms for a 40°C temperature rise from 25°C ambient with current
- Absolute maximum voltage 25VDC
- Measure Equipment :
 L : Agilent E4991/HP4286A+16197A (or equivalent), 2MHz 0.2V
 RDC : CHEN HWA502BC/HP4338B (or equivalent)
 Isat : Agilent E4980A+HP42841A (or equivalent)
 I rms : Agilent 6641 SYSTEM DC POWER SUPPLY (or equivalent)

Test Instruments : E4991A Impedance / Material Analyzer



Electrical Characteristics

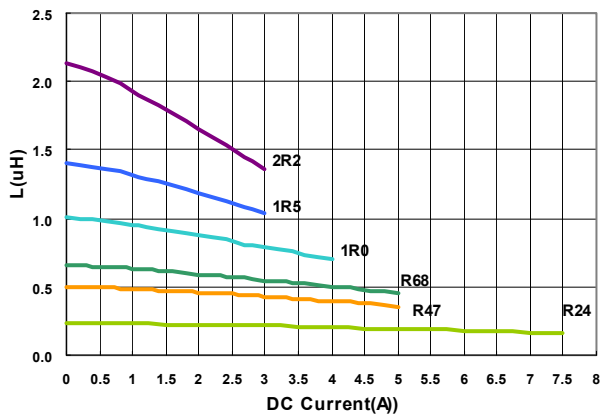
| Part Number | Inductance (uH) | Tolerance (±%) | Test Frequency (MHz) | RDC(mΩ) Max(Typ.) | Isat(A) Max(Typ.) | Irms(A) Max(Typ.) |
|----------------------|-----------------|----------------|----------------------|-------------------|-------------------|-------------------|
| MHCL201612A-R24M-A8S | 0.24 | 20 | 2 | 35(25) | 5.5(6.5) | 4.2(4.8) |
| MHCL201612A-R47M-A8S | 0.47 | 20 | 2 | 52(40) | 3.8(5.1) | 3.2(3.8) |
| MHCL201612A-R68M-A8S | 0.68 | 20 | 2 | 70(53) | 3.3(4.8) | 2.6(3.2) |
| MHCL201612A-1R0M-A8S | 1.0 | 20 | 2 | 82(67) | 3.1(3.9) | 2.3(2.7) |
| MHCL201612A-1R5M-A8S | 1.5 | 20 | 2 | 120(95) | 2.6(3.2) | 2.2(2.6) |
| MHCL201612A-2R2M-A8S | 2.2 | 20 | 2 | 195(165) | 2.0(2.6) | 1.3(1.7) |

Note: When ordering, please specify tolerance code. Tolerance: M=±20%

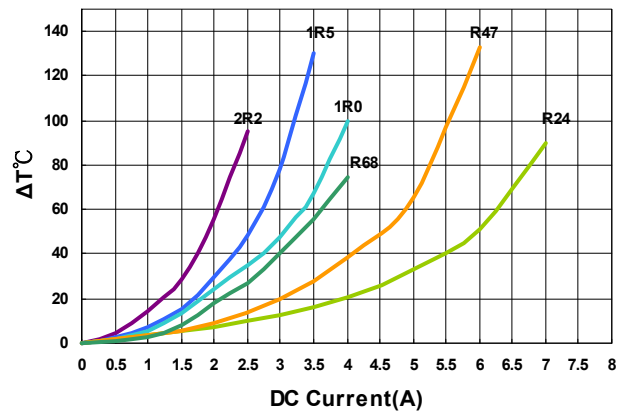
- Operating temperature range - 40°C ~ 125°C(Including self - temperature rise)
- Isat for Inductance drop 30% from its value without current
- I rms for a 40°C temperature rise from 25°C ambient with current
- Absolute maximum voltage 25VDC
- Measure Equipment :
 L : Agilent E4991/HP4286A+16197A (or equivalent), 2MHz 0.2V
 RDC : CHEN HWA502BC/HP4338B (or equivalent)
 Isat : Agilent E4980A+HP42841A (or equivalent)
 I rms : Agilent 6641 SYSTEM DC POWER SUPPLY (or equivalent)

Test Instruments : E4991A Impedance / Material Analyzer

Inductance v.s DC Current



Temperature Change v.s DC Current



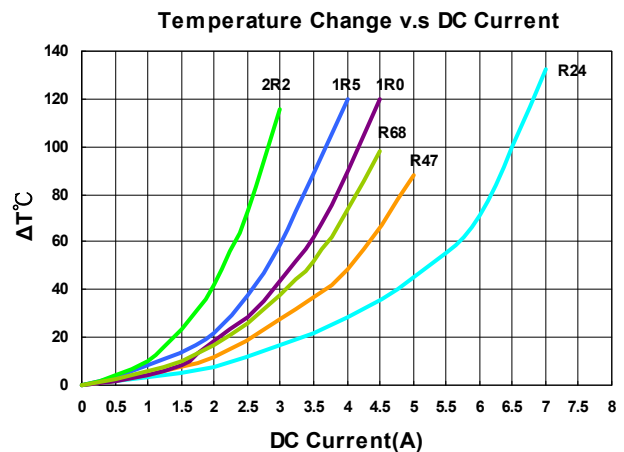
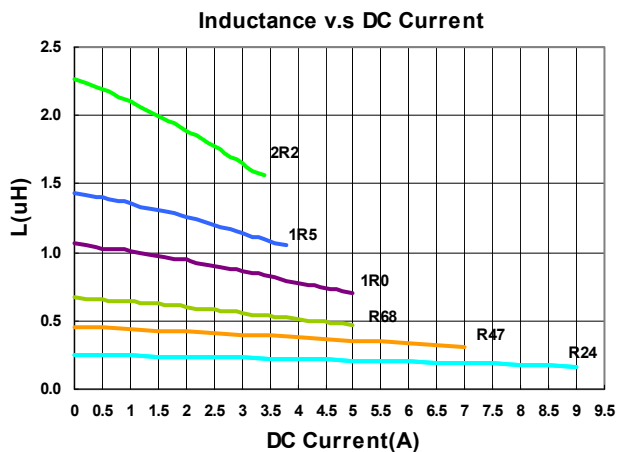
Electrical Characteristics

| Part Number | Inductance (uH) | Tolerance (±%) | Test Frequency (MHz) | RDC(mΩ) Max(Typ.) | Isat(A) Max(Typ.) | Irms(A) Max(Typ.) |
|----------------------|-----------------|----------------|----------------------|-------------------|-------------------|-------------------|
| MHCL252010A-R24M-A8S | 0.24 | 20 | 2 | 40(24) | 7.5(9.5) | 4.5(5.0) |
| MHCL252010A-R47M-A8S | 0.47 | 20 | 2 | 46(36) | 5.2(6.5) | 3.1(3.6) |
| MHCL252010A-R68M-A8S | 0.68 | 20 | 2 | 65(49) | 3.8(5.0) | 2.9(3.3) |
| MHCL252010A-1R0M-A8S | 1.0 | 20 | 2 | 78(60) | 3.4(4.3) | 2.5(3.0) |
| MHCL252010A-1R5M-A8S | 1.5 | 20 | 2 | 105(82) | 3.2(4.0) | 2.2(2.9) |
| MHCL252010A-2R2M-A8S | 2.2 | 20 | 2 | 156(130) | 2.6(3.2) | 1.4(1.8) |

Note: When ordering, please specify tolerance code. Tolerance: M=±20%

- Operating temperature range - 40°C ~ 125°C(Including self - temperature rise)
- Isat for Inductance drop 30% from its value without current
- I rms for a 40°C temperature rise from 25°C ambient with current
- Absolute maximum voltage 25VDC
- Measure Equipment :
 L : Agilent E4991/HP4286A+16197A (or equivalent), 2MHz 0.2V
 RDC : CHEN HWA502BC/HP4338B (or equivalent)
 Isat : Agilent E4980A+HP42841A (or equivalent)
 I rms : Agilent 6641 SYSTEM DC POWER SUPPLY (or equivalent)

Test Instruments : E4991A Impedance / Material Analyzer



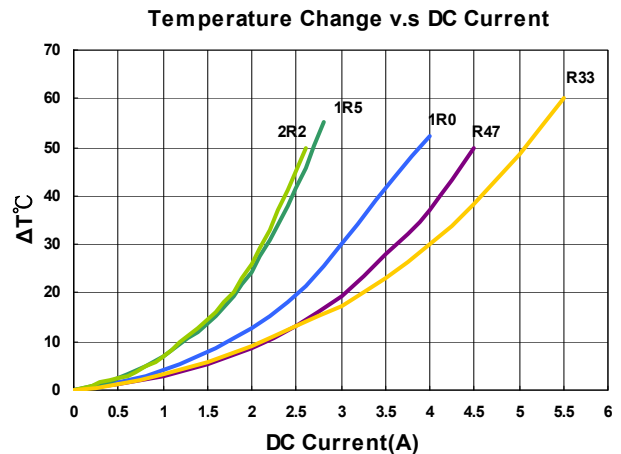
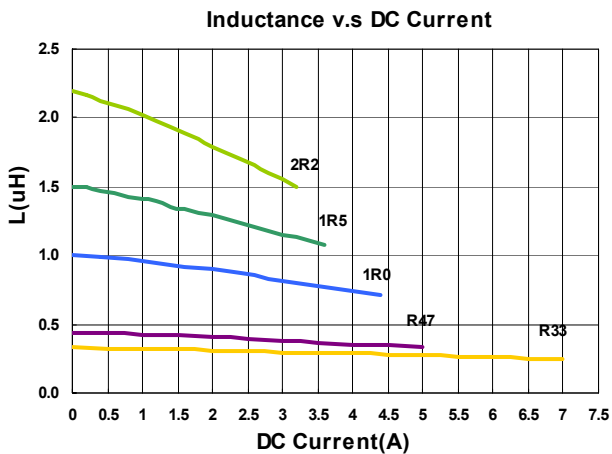
Electrical Characteristics

| Part Number | Inductance (uH) | Tolerance (±%) | Test Frequency (MHz) | RDC(mΩ) Max(Typ.) | Isat(A) Max(Typ.) | Irms(A) Max(Typ.) |
|----------------------|-----------------|----------------|----------------------|-------------------|-------------------|-------------------|
| MHCL252010B-R33M-A8L | 0.33 | 20 | 2 | 31(25) | 5.0(6.0) | 3.8(4.4) |
| MHCL252010B-R47M-A8L | 0.47 | 20 | 2 | 35(29) | 4.2(4.7) | 3.4(3.9) |
| MHCL252010B-R68M-A8L | 0.68 | 20 | 2 | 48(40) | 3.7(4.0) | 3.0(3.5) |
| MHCL252010B-1R0M-A8L | 1.0 | 20 | 2 | 65(54) | 3.2(3.6) | 2.6(3.0) |
| MHCL252010B-1R5M-A8L | 1.5 | 20 | 2 | 94(78) | 2.9(3.3) | 2.1(2.4) |
| MHCL252010B-2R2M-A8L | 2.2 | 20 | 2 | 120(100) | 2.3(2.7) | 1.8(2.1) |

Note: When ordering, please specify tolerance code. Tolerance: M=±20%

- Operating temperature range - 40°C ~ 125°C(Including self - temperature rise)
- Isat for Inductance drop 30% from its value without current
- I rms for a 40°C temperature rise from 25°C ambient with current
- Absolute maximum voltage 25VDC
- Measure Equipment :
 L : Agilent E4991/HP4286A+16197A (or equivalent), 2MHz 0.2V
 RDC : CHEN HWA502BC/HP4338B (or equivalent)
 Isat : Agilent E4980A+HP42841A (or equivalent)
 I rms : Agilent 6641 SYSTEM DC POWER SUPPLY (or equivalent)

Test Instruments : E4991A Impedance / Material Analyzer



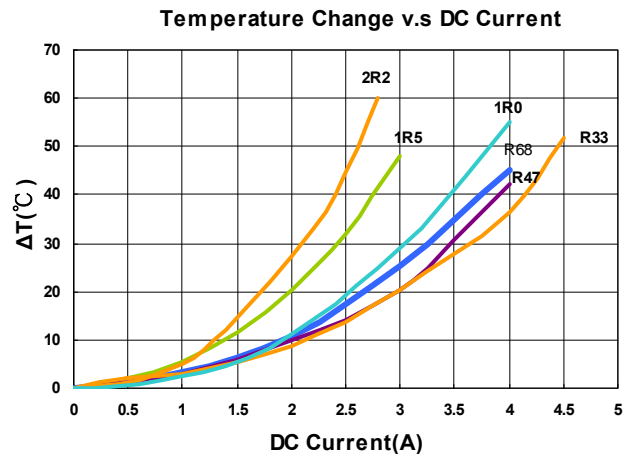
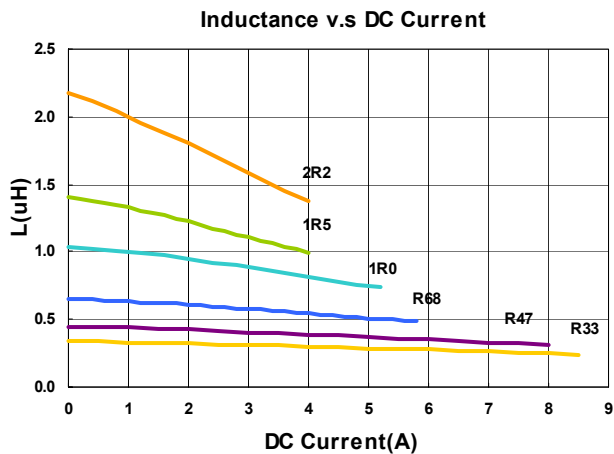
Electrical Characteristics

| Part Number | Inductance (uH) | Tolerance (±%) | Test Frequency (MHz) | RDC(mΩ) Max(Typ.) | Isat(A) Max(Typ.) | Irms(A) Max(Typ.) |
|----------------------|-----------------|----------------|----------------------|-------------------|-------------------|-------------------|
| MHCL252012A-R33M-A8S | 0.33 | 20 | 2 | 35(27) | 6.8(8.5) | 4.0(4.6) |
| MHCL252012A-R47M-A8S | 0.47 | 20 | 2 | 39(29) | 6.2(7.8) | 3.7(4.4) |
| MHCL252012A-R68M-A8S | 0.68 | 20 | 2 | 46(40) | 5.5(6.5) | 3.3(3.7) |
| MHCL252012A-1R0M-A8S | 1.0 | 20 | 2 | 59(45) | 4.0(5.0) | 3.0(3.5) |
| MHCL252012A-1R5M-A8S | 1.5 | 20 | 2 | 70(62) | 3.4(4.0) | 2.5(2.7) |
| MHCL252012A-2R2M-A8S | 2.2 | 20 | 2 | 115(102) | 3.3(3.8) | 2.0(2.3) |

Note: When ordering, please specify tolerance code. Tolerance: M=±20%

- Operating temperature range - 40°C ~ 125°C(Including self - temperature rise)
- Isat for Inductance drop 30% from its value without current
- I rms for a 40°C temperature rise from 25°C ambient with current
- Absolute maximum voltage 25VDC
- Measure Equipment :
 L : Agilent E4991/HP4286A+16197A (or equivalent), 2MHz 0.2V
 RDC : CHEN HWA502BC/HP4338B (or equivalent)
 Isat : Agilent E4980A+HP42841A (or equivalent)
 I rms : Agilent 6641 SYSTEM DC POWER SUPPLY (or equivalent)

Test Instruments : E4991A Impedance / Material Analyzer



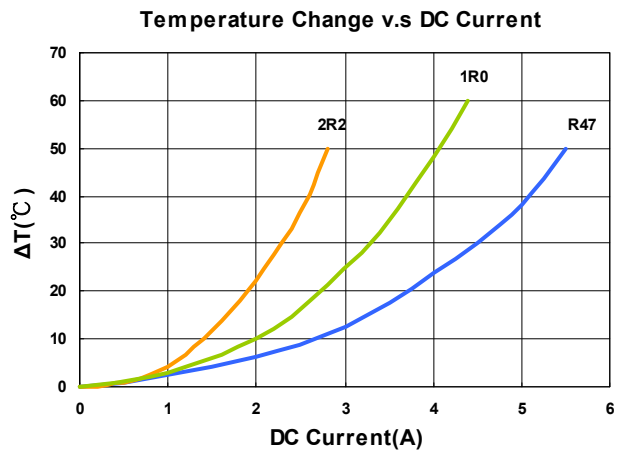
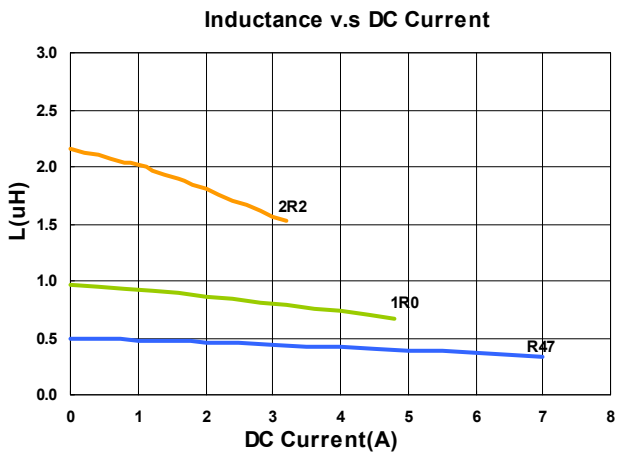
Electrical Characteristics

| Part Number | Inductance (uH) | Tolerance (±%) | Test Frequency (MHz) | RDC(mΩ) Max(Typ.) | Isat(A) Max(Typ.) | Irms(A) Max(Typ.) |
|----------------------|-----------------|----------------|----------------------|-------------------|-------------------|-------------------|
| MHCL252012B-R47M-A8L | 0.47 | 20 | 2 | 34(30) | 5.2(6.0) | 4.1(4.7) |
| MHCL252012B-1R0M-A8L | 1.0 | 20 | 2 | 56(45) | 3.6(4.5) | 3.2(3.7) |
| MHCL252012B-2R2M-A8L | 2.2 | 20 | 2 | 102(80) | 2.5(3.0) | 2.2(2.6) |

Note: When ordering, please specify tolerance code. Tolerance: M=±20%

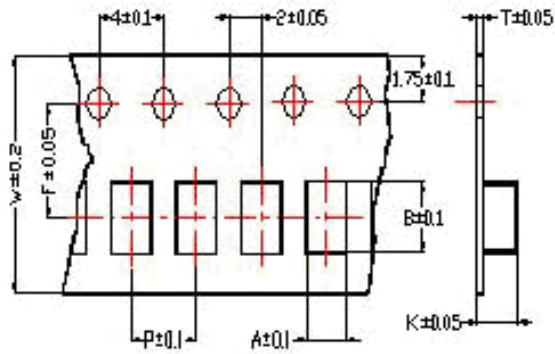
- Operating temperature range - 40°C ~ 125°C(Including self - temperature rise)
- Isat for Inductance drop 30% from its value without current
- I rms for a 40°C temperature rise from 25°C ambient with current
- Absolute maximum voltage 25VDC
- Measure Equipment :
 L : Agilent E4991/HP4286A+16197A (or equivalent), 2MHz 0.2V
 RDC : CHEN HWA502BC/HP4338B (or equivalent)
 Isat : Agilent E4980A+HP42841A (or equivalent)
 I rms : Agilent 6641 SYSTEM DC POWER SUPPLY (or equivalent)

Test Instruments : E4991A Impedance / Material Analyzer

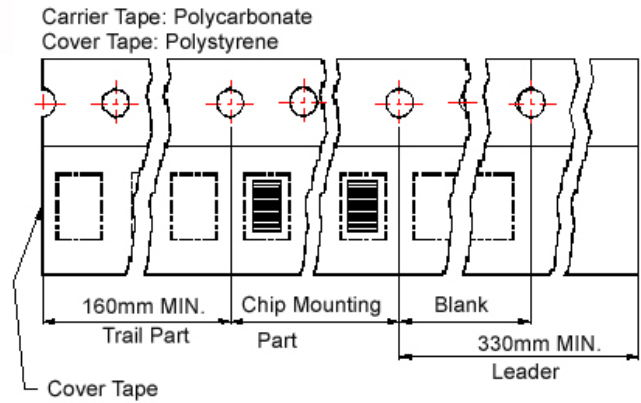


Packaging Specifications

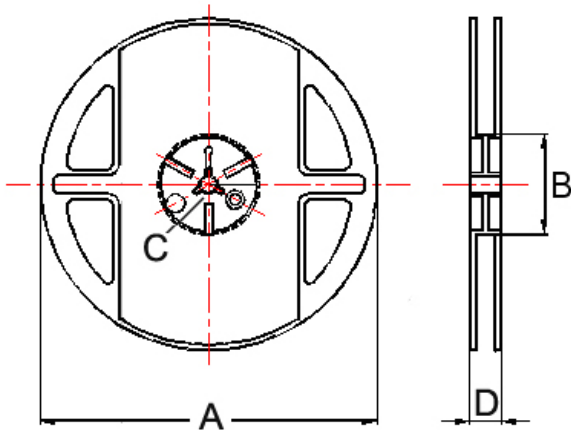
Tape Dimensions



Tape Material



Reel Dimensions



Dimensions in mm

| TYPE | Tape Dimensions | | | | | | | Reel Dimensions | | | | Quantity PCS / REEL |
|--------|-----------------|------|------|---|---|-----|------|-----------------|----|----|-----|------------------------|
| | A | B | T | W | P | F | K | A | B | C | D | |
| 201610 | 1.80 | 2.20 | 0.22 | 8 | 4 | 3.5 | 1.15 | 178 | 60 | 12 | 1.5 | 3000 |
| 201612 | 1.80 | 2.20 | 0.22 | 8 | 4 | 3.5 | 1.15 | 178 | 60 | 12 | 1.5 | 3000 |
| 252010 | 2.25 | 2.80 | 0.22 | 8 | 4 | 3.5 | 1.15 | 178 | 60 | 12 | 1.5 | 3000 |
| 252012 | 2.25 | 2.80 | 0.22 | 8 | 4 | 3.5 | 1.35 | 178 | 60 | 12 | 1.5 | 3000 |

HPPC Series



HPPC series is low profile molding power choke with low RDC and high Q factor, so the efficiency performance is also superior. Its molded magnetic shielded type is suitable for high-density mounting and ultra-low buzz noise. Soldering conditions can be easily confirmed when mounting onto the board. This series also provides customers with embossed carrier type packaging for automatic mounting machine.

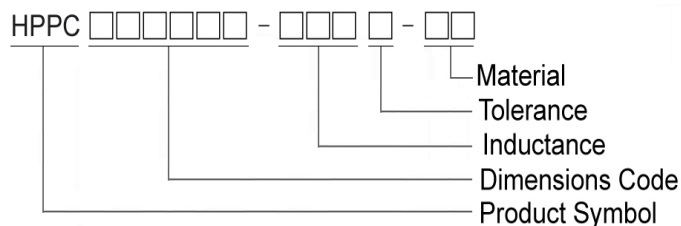
Features

- RoHS, Halogen Free and REACH Compliance
- Low RDC
- High Q
- High Efficiency
- Ultra-low buzz noise

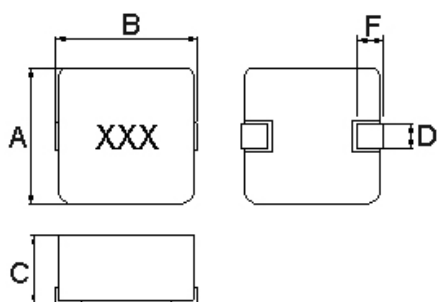
Applications

- Laptops and PCs
- Switches and servers
- Base stations
- DC/DC converters

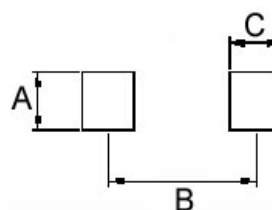
Product Identification



Shape and Dimensions



Recommended Pattern



Dimensions in mm

| TYPE | A | B | C | D | F |
|-------|----------|-----------|---------|----------|----------|
| 04010 | 4.1±0.2 | 4.6±0.2 | 1.0Max | 1.5±0.3 | 1.0±0.3 |
| 04011 | 4.1±0.2 | 4.6±0.2 | 1.1Max | 1.5±0.3 | 1.0±0.3 |
| 04020 | 4.2±0.2 | 4.8±0.2 | 1.8±0.2 | 1.5±0.3 | 1.1±0.3 |
| 05011 | 5.5±0.2 | 5.7±0.2 | 1.1Max | 2.0±0.3 | 1.5±0.3 |
| 05030 | 5.5±0.25 | 5.85±0.25 | 2.8±0.2 | 2.0±0.25 | 1.5±0.25 |
| 06011 | 6.6±0.2 | 6.95±0.35 | 1.1Max | 3.0±0.3 | 1.6±0.3 |
| 06020 | 6.8±0.2 | 6.95±0.35 | 1.8±0.2 | 3.0±0.3 | 1.6±0.3 |
| 06030 | 6.8±0.2 | 7.3±0.2 | 2.8±0.2 | 3.0±0.3 | 1.6±0.3 |
| 10040 | 10.2±0.3 | 11.3±0.3 | 3.8±0.2 | 3.0±0.5 | 2.5±0.5 |

Dimensions in mm

| TYPE | A | B | C |
|-------|-----|------|------|
| 04010 | 2.5 | 3.7 | 1.5 |
| 04011 | 2.5 | 3.7 | 1.5 |
| 04020 | 2.5 | 3.7 | 1.5 |
| 05011 | 2.5 | 4.1 | 1.9 |
| 05030 | 2.5 | 4.6 | 1.9 |
| 06011 | 3.5 | 6.05 | 2.35 |
| 06020 | 3.5 | 6.05 | 2.35 |
| 06030 | 3.5 | 6.05 | 2.35 |
| 10040 | 4.0 | 9.50 | 3.50 |

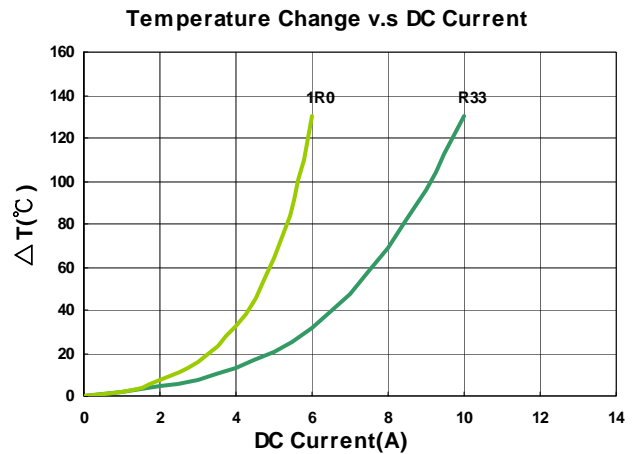
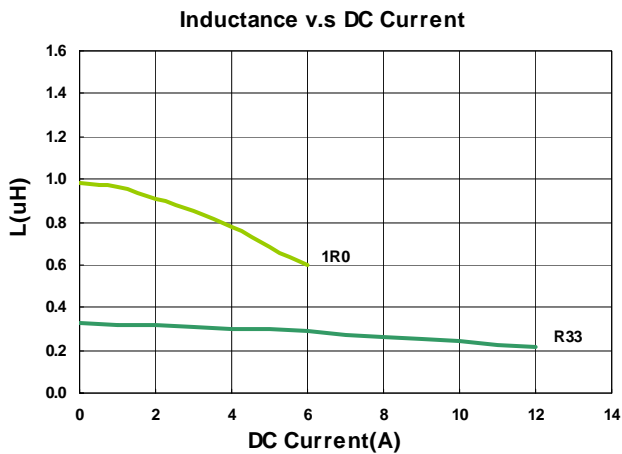
Electrical Characteristics

| Part Number | Inductance (uH) | Tolerance (±%) | Test Frequency (kHz) | RDC(mΩ) Max(Typ.) | Isat(A) Max(Typ.) | Irms(A) Max(Typ.) | Marking |
|-------------------|-----------------|----------------|----------------------|-------------------|-------------------|-------------------|---------|
| HPPC04010-R33M-A8 | 0.33 | 20 | 100 | 14(12) | 9.0(11) | 6.0(7.0) | R33 |
| HPPC04010-1R0M-A8 | 1.0 | 20 | 100 | 43(39) | 4.0(5.0) | 4.0(4.5) | 1R0 |

Note: When ordering, please specify tolerance code. Tolerance: M=±20%

- Operating temperature range - 55°C ~ 125°C(Including self - temperature rise)
- Isat for Inductance drop 30% from its value without current
- I rms for a 40°C temperature rise from 25°C ambient with current
- Absolute maximum voltage 30VDC
- Measure Equipment :
 - L : WK 3260B or WK 6500P, 100kHz 0.5V
 - RDC : CHEN HWA 502 or CHEN HWA 46502B
 - I rms : CHROMA 1810

Test Instruments : WK3260B Impedance / Material Analyzer



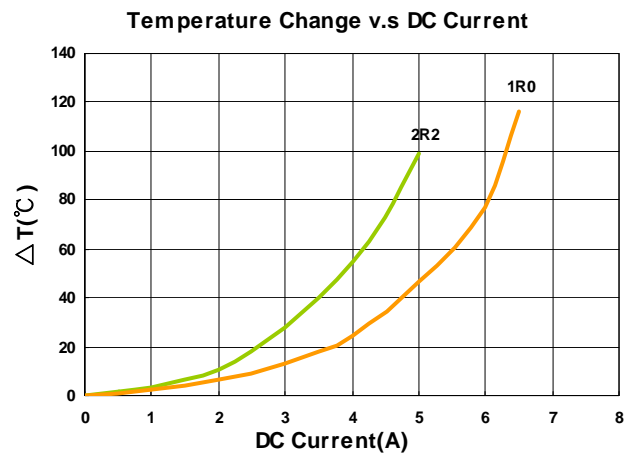
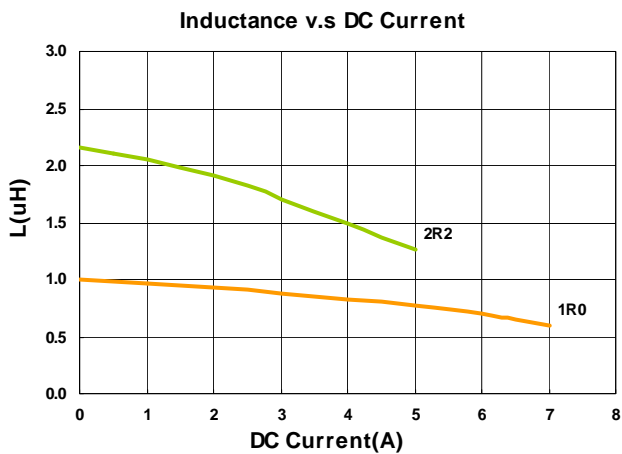
Electrical Characteristics

| Part Number | Inductance (uH) | Tolerance (±%) | Test Frequency (kHz) | RDC(mΩ) Max(Typ.) | Isat(A) Max(Typ.) | Irms(A) Max(Typ.) | Marking |
|-------------------|-----------------|----------------|----------------------|-------------------|-------------------|-------------------|---------|
| HPPC04011-1R0M-A8 | 1.0 | 20 | 100 | 38.5(35) | 5.4(6.0) | 4.3(4.8) | 1R0 |
| HPPC04011-2R2M-A8 | 2.2 | 20 | 100 | 82(75) | 3.5(4.0) | 3.0(3.3) | 2R2 |

Note: When ordering, please specify tolerance code. Tolerance: M=±20%

- Operating temperature range - 55°C ~ 125°C(Including self - temperature rise)
- Isat for Inductance drop 30% from its value without current
- I rms for a 40°C temperature rise from 25°C ambient with current
- Absolute maximum voltage 30VDC
- Measure Equipment :
 L : WK 3260B or WK 6500P, 100kHz 0.5V
 RDC : CHEN HWA 502 or CHEN HWA 46502B
 I rms : CHROMA 1810

Test Instruments : WK3260B Impedance / Material Analyzer



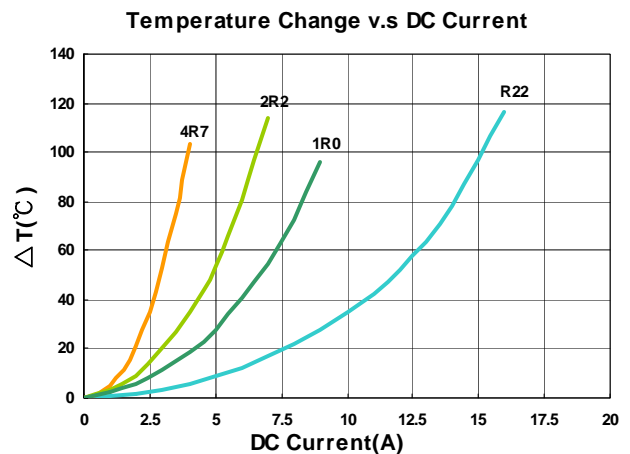
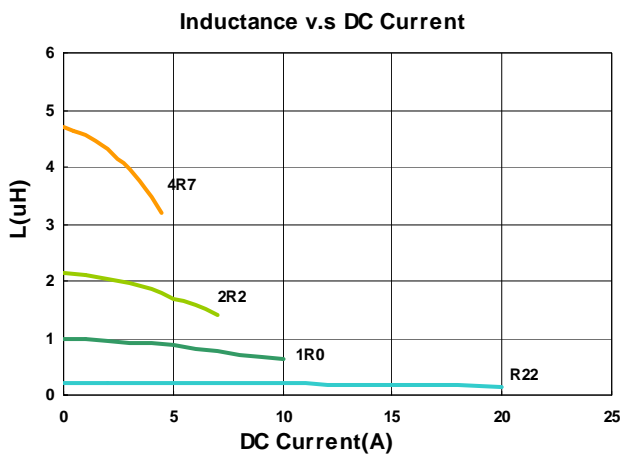
Electrical Characteristics

| Part Number | Inductance (uH) | Tolerance (±%) | Test Frequency (kHz) | RDC(mΩ) Max(Typ.) | Isat(A) Max(Typ.) | Irms(A) Max(Typ.) | Marking |
|-------------------|-----------------|----------------|----------------------|----------------------|----------------------|----------------------|---------|
| HPPC04020-R22M-Q8 | 0.22 | 20 | 100 | 5.5(5.0) | 18(20) | 10(11) | R22 |
| HPPC04020-1R0M-Q8 | 1.0 | 20 | 100 | 17(16) | 8.0(8.5) | 5.5(6.0) | 1R0 |
| HPPC04020-2R2M-Q8 | 2.2 | 20 | 100 | 38.5(35) | 6.0(6.5) | 4.0(4.5) | 2R2 |
| HPPC04020-4R7M-Q8 | 4.7 | 20 | 100 | 85(77) | 4.0(4.5) | 2.5(2.8) | 4R7 |

Note: When ordering, please specify tolerance code. Tolerance: M=±20%

- Operating temperature range - 55°C ~ 125°C(Including self - temperature rise)
- Isat for Inductance drop 30% from its value without current
- I rms for a 40°C temperature rise from 25°C ambient with current
- Absolute maximum voltage 30VDC
- Measure Equipment :
 L : WK 3260B or WK 6500P, 100kHz 0.5V
 RDC : CHEN HWA 502 or CHEN HWA 46502B
 I rms : CHROMA 1810

Test Instruments : WK3260B Impedance / Material Analyzer



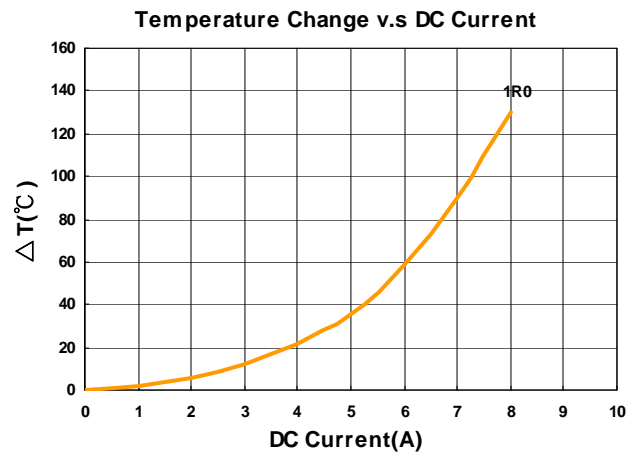
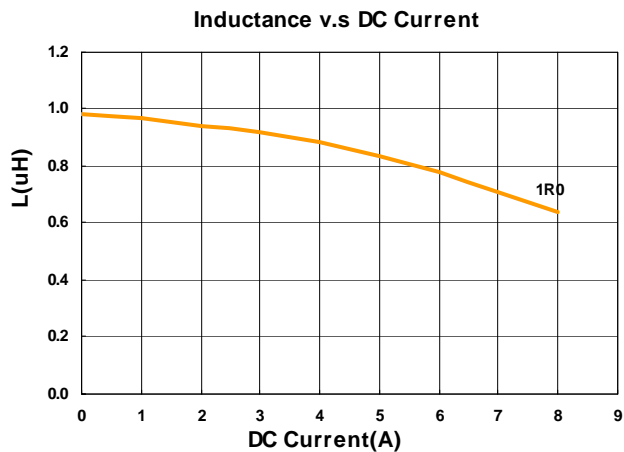
Electrical Characteristics

| Part Number | Inductance (uH) | Tolerance (±%) | Test Frequency (kHz) | RDC(mΩ) Max(Typ.) | Isat(A) Max(Typ.) | Irms(A) Max(Typ.) | Marking |
|-------------------|-----------------|----------------|----------------------|----------------------|----------------------|----------------------|---------|
| HPPC05011-1R0M-A8 | 1.0 | 20 | 100 | 33(30) | 7.0(7.5) | 4.8(5.3) | 1R0 |

Note: When ordering, please specify tolerance code. Tolerance: M=±20%

- Operating temperature range - 55°C ~ 125°C(Including self - temperature rise)
- Isat for Inductance drop 30% from its value without current
- Irms for a 40°C temperature rise from 25°C ambient with current
- Absolute maximum voltage 30VDC
- Measure Equipment :
 L : WK 3260B or WK 6500P, 100kHz 0.5V
 RDC : CHEN HWA 502 or CHEN HWA 46502B
 Irms : CHROMA 1810

Test Instruments : WK3260B Impedance / Material Analyzer



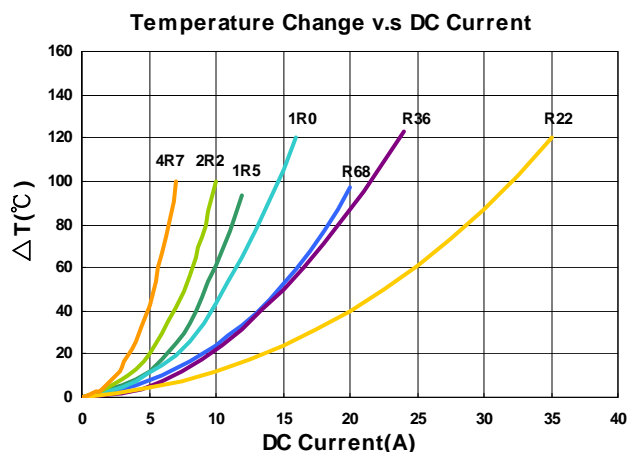
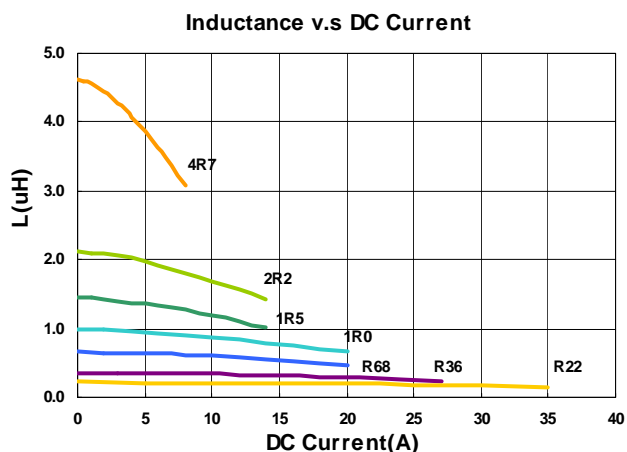
Electrical Characteristics

| Part Number | Inductance (uH) | Tolerance (±%) | Test Frequency (kHz) | RDC(mΩ) Max(Typ.) | Isat(A) Max(Typ.) | Irms(A) Max(Typ.) | Marking |
|-------------------|-----------------|----------------|----------------------|----------------------|----------------------|----------------------|---------|
| HPPC05030-R22M-Q8 | 0.22 | 20 | 100 | 3.90(3.5) | 28(32) | 18.0(20.0) | R22 |
| HPPC05030-R36M-Q8 | 0.36 | 20 | 100 | 4.95(4.5) | 23(25) | 12.5(13.5) | R36 |
| HPPC05030-R68M-Q8 | 0.68 | 20 | 100 | 6.30(5.7) | 17(18) | 11.0(12.0) | R68 |
| HPPC05030-1R0M-Q8 | 1.0 | 20 | 100 | 9.8(8.9) | 16(18) | 9.00(9.50) | 1R0 |
| HPPC05030-1R5M-Q8 | 1.5 | 20 | 100 | 15(13.5) | 12.5(13.5) | 7.50(8.0) | 1R5 |
| HPPC05030-2R2M-Q8 | 2.2 | 20 | 100 | 20(18) | 11.5(12.5) | 6.00(6.5) | 2R2 |
| HPPC05030-4R7M-Q8 | 4.7 | 20 | 100 | 40(37) | 6.5(7.50) | 4.50(5.0) | 4R7 |

Note: When ordering, please specify tolerance code. Tolerance: M=±20%

- Operating temperature range - 55°C ~ 125°C(Including self - temperature rise)
- Isat for Inductance drop 30% from its value without current
- I rms for a 40°C temperature rise from 25°C ambient with current
- Absolute maximum voltage 30VDC
- Measure Equipment :
 L : WK 3260B or WK 6500P, 100kHz 0.5V
 RDC : CHEN HWA 502 or CHEN HWA 46502B
 I rms : CHROMA 1810

Test Instruments : WK3260B Impedance / Material Analyzer



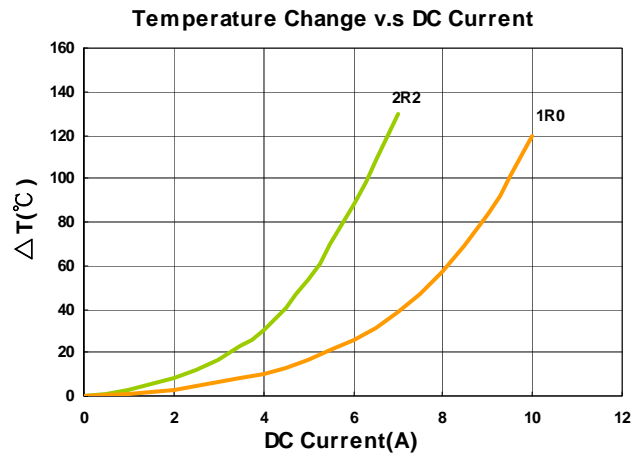
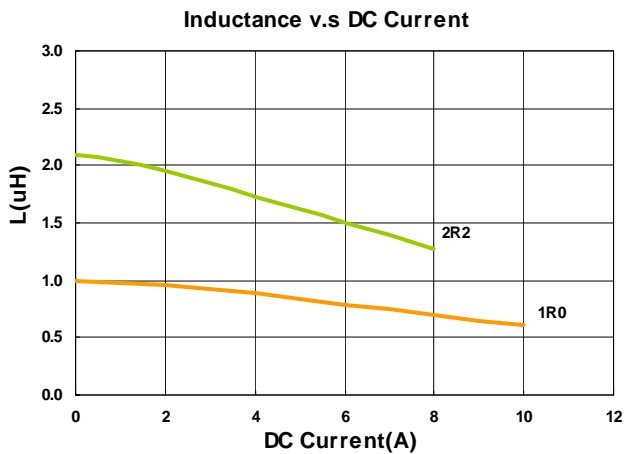
Electrical Characteristics

| Part Number | Inductance (uH) | Tolerance (±%) | Test Frequency (kHz) | RDC(mΩ) Max(Typ.) | Isat(A) Max(Typ.) | Irms(A) Max(Typ.) | Marking |
|-------------------|-----------------|----------------|----------------------|-------------------|-------------------|-------------------|---------|
| HPPC06011-1R0M-A8 | 1.0 | 20 | 100 | 26(24.5) | 7.0(7.8) | 6.8(7.3) | 1R0 |
| HPPC06011-2R2M-A8 | 2.2 | 20 | 100 | 57(52) | 5.0(6.0) | 4.2(4.6) | 2R2 |

Note: When ordering, please specify tolerance code. Tolerance: M=±20%

- Operating temperature range - 55°C ~ 125°C(Including self - temperature rise)
- Isat for Inductance drop 30% from its value without current
- I rms for a 40°C temperature rise from 25°C ambient with current
- Absolute maximum voltage 30VDC
- Measure Equipment :
 L : WK 3260B or WK 6500P, 100kHz 0.5V
 RDC : CHEN HWA 502 or CHEN HWA 46502B
 I rms : CHROMA 1810

Test Instruments : WK3260B Impedance / Material Analyzer



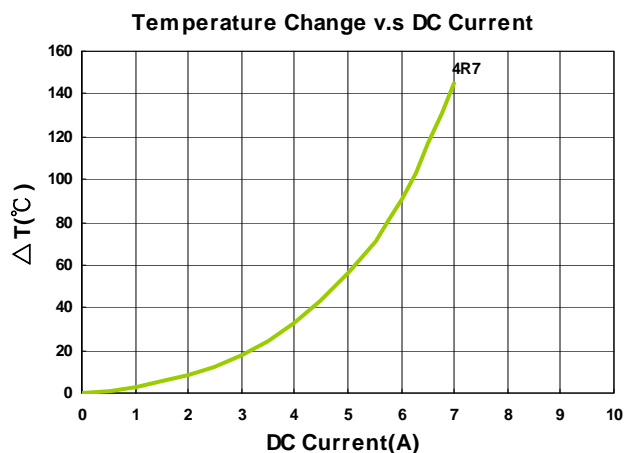
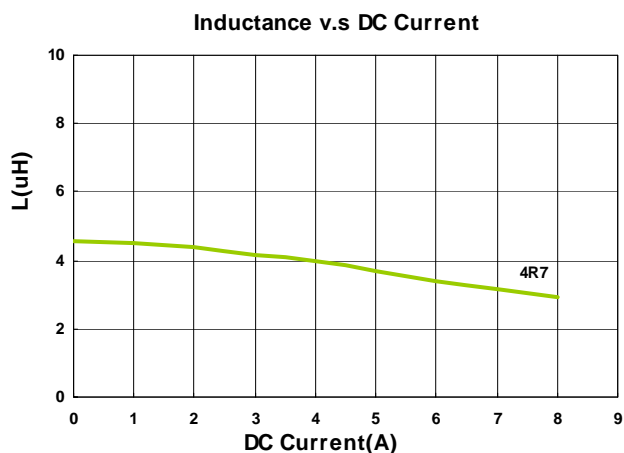
Electrical Characteristics

| Part Number | Inductance (uH) | Tolerance (±%) | Test Frequency (kHz) | RDC(mΩ) Max(Typ.) | Isat(A) Max(Typ.) | Irms(A) Max(Typ.) | Marking |
|-------------------|-----------------|----------------|----------------------|-------------------|-------------------|-------------------|---------|
| HPPC06020-4R7M-Q8 | 4.7 | 20 | 100 | 48(43.7) | 6.0(6.8) | 4.2(4.7) | 4R7 |

Note: When ordering, please specify tolerance code. Tolerance: M=±20%

- Operating temperature range - 55°C ~ 125°C(Including self - temperature rise)
- Isat for Inductance drop 30% from its value without current
- Irms for a 40°C temperature rise from 25°C ambient with current
- Absolute maximum voltage 30VDC
- Measure Equipment :
 L : WK 3260B or WK 6500P, 100kHz 0.5V
 RDC : CHEN HWA 502 or CHEN HWA 46502B
 Irms : CHROMA 1810

Test Instruments : WK3260B Impedance / Material Analyzer



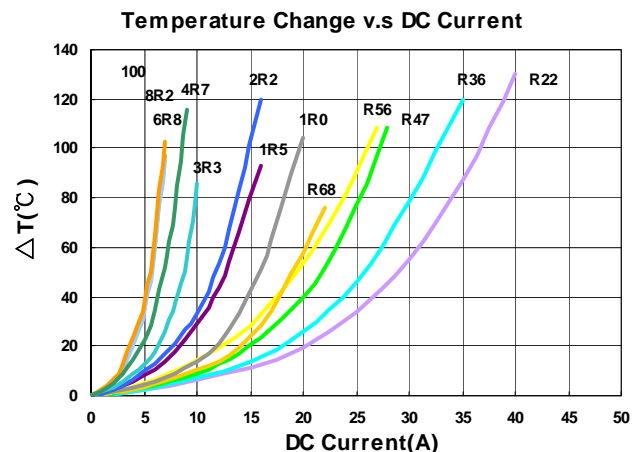
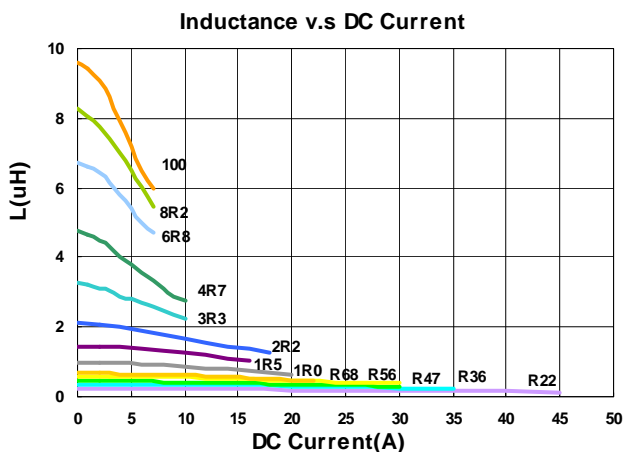
Electrical Characteristics

| Part Number | Inductance (uH) | Tolerance (±%) | Test Frequency (kHz) | RDC(mΩ) Max(Typ.) | Isat(A) Max(Typ.) | Irms(A) Max(Typ.) | Marking |
|-------------------|-----------------|----------------|----------------------|-------------------|-------------------|-------------------|---------|
| HPPC06030-R22M-Q8 | 0.22 | 20 | 100 | 2.0(1.8) | 35(40) | 25(27) | R22 |
| HPPC06030-R36M-Q8 | 0.36 | 20 | 100 | 2.6(2.3) | 27(32) | 23(25) | R36 |
| HPPC06030-R47M-Q8 | 0.47 | 20 | 100 | 3.3(2.9) | 25(27) | 19(20) | R47 |
| HPPC06030-R56M-Q8 | 0.56 | 20 | 100 | 3.9(3.5) | 23(25) | 17(18) | R56 |
| HPPC06030-R68M-Q8 | 0.68 | 20 | 100 | 4.2(3.8) | 18(20) | 16(17) | R68 |
| HPPC06030-1R0M-Q8 | 1.0 | 20 | 100 | 5.3(4.8) | 17(19) | 14(15) | 1R0 |
| HPPC06030-1R5M-Q8 | 1.5 | 20 | 100 | 7.7(7.0) | 15(17) | 11(11.5) | 1R5 |
| HPPC06030-2R2M-Q8 | 2.2 | 20 | 100 | 9.4(8.5) | 12(12.5) | 10.5(11) | 2R2 |
| HPPC06030-3R3M-Q8 | 3.3 | 20 | 100 | 15(13.5) | 9.0(9.5) | 8.0(8.5) | 3R3 |
| HPPC06030-4R7M-Q8 | 4.7 | 20 | 100 | 22.0(20) | 6.5(7.0) | 6.0(6.5) | 4R7 |
| HPPC06030-6R8M-Q8 | 6.8 | 20 | 100 | 38.5(35) | 6.0(6.5) | 5.3(5.8) | 6R8 |
| HPPC06030-8R2M-Q8 | 8.2 | 20 | 100 | 47.0(43) | 5.5(6.0) | 5.0(5.4) | 8R2 |
| HPPC06030-100M-Q8 | 10 | 20 | 100 | 47.0(43) | 5.0(5.5) | 4.8(5.3) | 100 |

Note: When ordering, please specify tolerance code. Tolerance: M=±20%

- Operating temperature range - 55°C ~ 125°C(Including self - temperature rise)
- Isat for Inductance drop 30% from its value without current
- I rms for a 40°C temperature rise from 25°C ambient with current
- Absolute maximum voltage 30VDC
- Measure Equipment :
 L : WK 3260B or WK 6500P, 100kHz 0.5V
 RDC : CHEN HWA 502 or CHEN HWA 46502B
 I rms : CHROMA 1810

Test Instruments : WK3260B Impedance / Material Analyzer



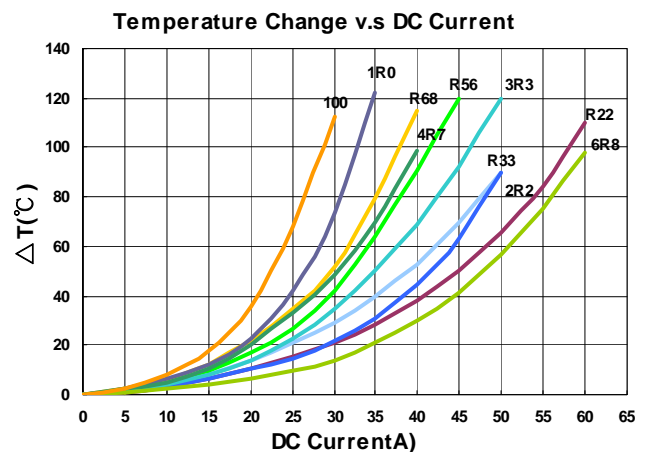
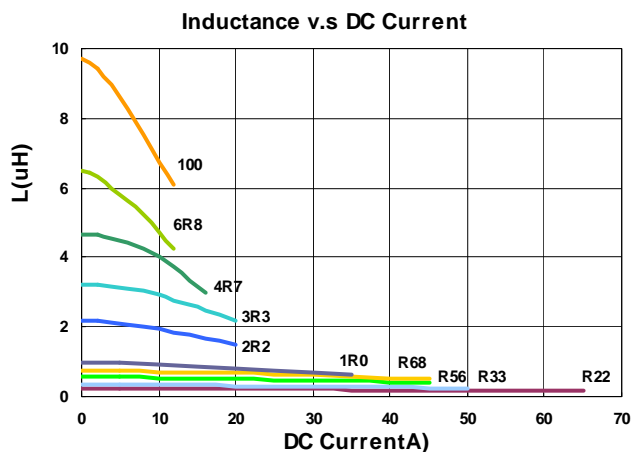
Electrical Characteristics

| Part Number | Inductance (uH) | Tolerance (±%) | Test Frequency (kHz) | RDC(mΩ) Max(Typ.) | Isat(A) Max(Typ.) | Irms(A) Max(Typ.) | Marking |
|-------------------|-----------------|----------------|----------------------|-------------------|-------------------|-------------------|---------|
| HPPC10040-R22M-Q8 | 0.22 | 20 | 100 | 0.54(0.45) | 55(60) | 40(42) | R22 |
| HPPC10040-R33M-Q8 | 0.33 | 20 | 100 | 0.68(0.62) | 45(50) | 32(35) | R33 |
| HPPC10040-R56M-Q8 | 0.56 | 20 | 100 | 1.2(1.0) | 40(45) | 28(30) | R56 |
| HPPC10040-R68M-Q8 | 0.68 | 20 | 100 | 1.5(1.3) | 32(37) | 25(27) | R68 |
| HPPC10040-1R0M-Q8 | 1.0 | 20 | 100 | 2.4(2.2) | 26(30) | 23(25) | 1R0 |
| HPPC10040-2R2M-Q8 | 2.2 | 20 | 100 | 4.7(4.3) | 17(20) | 15(15.6) | 2R2 |
| HPPC10040-3R3M-Q8 | 3.3 | 20 | 100 | 7.9(7.2) | 16(18) | 12(12.5) | 3R3 |
| HPPC10040-4R7M-Q8 | 4.7 | 20 | 100 | 10.5(9.5) | 13(14) | 10.5(11) | 4R7 |
| HPPC10040-6R8M-Q8 | 6.8 | 20 | 100 | 16.5(15) | 9.0(10) | 8.5(9.0) | 6R8 |
| HPPC10040-100M-Q8 | 10 | 20 | 100 | 24(22) | 8.5(9.0) | 8.0(8.5) | 100 |

Note: When ordering, please specify tolerance code. Tolerance: M=±20%

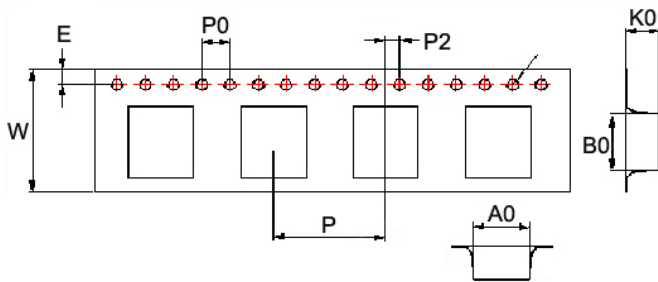
- Operating temperature range - 55°C ~ 125°C(Including self - temperature rise)
- Isat for Inductance drop 30% from its value without current
- I rms for a 40°C temperature rise from 25°C ambient with current
- Absolute maximum voltage 30VDC
- Measure Equipment :
 L : WK 3260B or WK 6500P, 100kHz 0.5V
 RDC : CHEN HWA 502 or CHEN HWA 46502B
 I rms : CHROMA 1810

Test Instruments : WK3260B Impedance / Material Analyzer

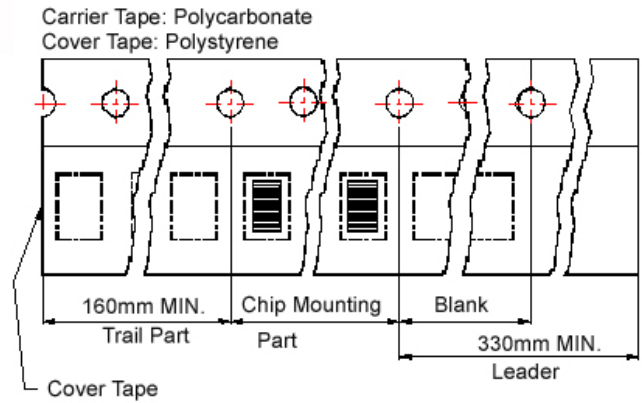


Packaging Specifications

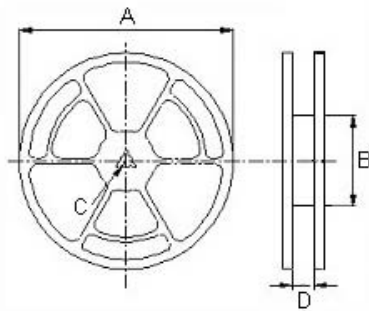
Tape Dimensions



Tape Material



Reel Dimensions



Dimensions in mm

| TYPE | Tape Dimensions | | | | | | | | | Reel Dimensions | | | | Quantity PCS / REEL |
|-------|-----------------|------|------|------|------|----|----|----|----|-----------------|-----|----|------|------------------------|
| | A0 | B0 | K0 | D | E | W | P | P0 | P2 | A | B | C | D | |
| 04010 | 4.4 | 4.9 | 1.4 | 1.55 | 1.75 | 12 | 8 | 4 | 2 | 330 | 100 | 13 | 13.4 | 2000 |
| 04011 | 4.4 | 4.9 | 1.5 | 1.55 | 1.75 | 12 | 8 | 4 | 2 | 330 | 100 | 13 | 13.4 | 2000 |
| 04020 | 4.5 | 5.1 | 2.4 | 1.55 | 1.75 | 12 | 8 | 4 | 2 | 330 | 100 | 13 | 13.4 | 2000 |
| 05011 | 5.9 | 6.2 | 1.5 | 1.55 | 1.75 | 16 | 12 | 4 | 2 | 330 | 100 | 13 | 16 | 2000 |
| 05030 | 5.9 | 6.25 | 3.4 | 1.55 | 1.75 | 16 | 12 | 4 | 2 | 330 | 100 | 13 | 16 | 1000 |
| 06011 | 6.9 | 7.4 | 1.5 | 1.55 | 1.75 | 16 | 12 | 4 | 2 | 330 | 100 | 13 | 16 | 1000 |
| 06020 | 7.05 | 7.6 | 2.4 | 1.55 | 1.75 | 16 | 12 | 4 | 2 | 330 | 100 | 13 | 16 | 1000 |
| 06030 | 7.0 | 7.6 | 3.4 | 1.55 | 1.75 | 16 | 12 | 4 | 2 | 330 | 100 | 13 | 16 | 1000 |
| 10040 | 10.6 | 11.7 | 4.25 | 1.55 | 1.75 | 24 | 16 | 4 | 2 | 330 | 100 | 13 | 24.4 | 500 |

MHCC、MHCI Series



MHCC series is designed for low profile type with low RDC and ultra large current. Its molded magnetic shielded type is suitable for high-density mounting and ultra low buzz noise. Soldering conditions can be easily confirmed when mounting onto the board. This series also provides customers with embossed carrier type packaging for automatic mounting machine.

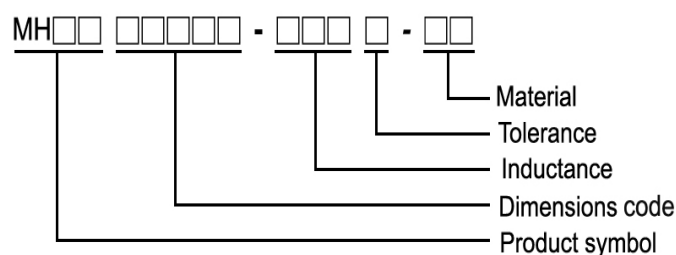
Features

- RoHS, Halogen Free and REACH Compliance
- High rated current
- Ultra low buzz noise

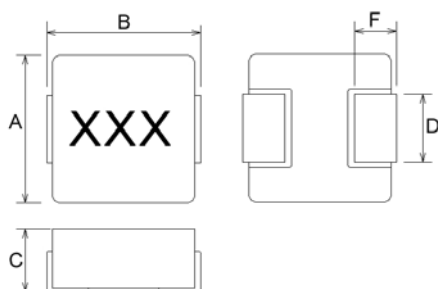
Applications

- Laptops and PCs
- Switches and servers
- Base stations
- DC/DC converters

Product Identification



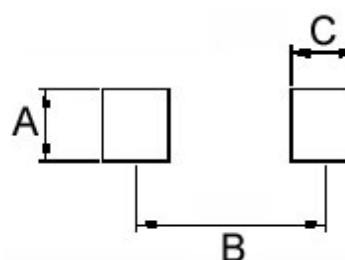
Shape and Dimensions



Dimensions in mm

| TYPE | A | B Max | C Max | D | F |
|-------|----------|---------|---------|---------|---------|
| 04012 | 4.1±0.2 | 4.6±0.2 | 1.2 | 1.5±0.3 | 1.0±0.5 |
| 04015 | 4.1±0.2 | 4.6±0.2 | 1.5 | 1.5±0.3 | 1.0±0.5 |
| 04020 | 4.1±0.2 | 4.6±0.2 | 2.0 | 1.5±0.3 | 1.0±0.5 |
| 05012 | 5.4±0.35 | 5.7±0.2 | 1.2 | 2.0±0.3 | 1.5±0.3 |
| 05015 | 5.4±0.35 | 5.7±0.2 | 1.5 | 2.0±0.3 | 1.5±0.3 |
| 05018 | 5.4±0.35 | 5.7±0.2 | 1.8 | 2.0±0.3 | 1.5±0.3 |
| 05020 | 5.4±0.35 | 5.7±0.2 | 1.8±0.2 | 2.0±0.3 | 1.5±0.3 |
| 05030 | 5.4±0.35 | 5.7±0.2 | 3.0 | 2.0±0.3 | 1.5±0.3 |
| 06012 | 6.6±0.2 | 7.3 | 1.2 | 2.9 | 1.6±0.5 |
| 06015 | 6.6±0.2 | 7.3 | 1.3±0.2 | 2.9 | 1.6±0.5 |
| 06018 | 6.6±0.2 | 7.3 | 1.6±0.2 | 2.9 | 1.6±0.5 |
| 06024 | 6.6±0.2 | 7.3 | 2.4 | 2.9 | 1.6±0.5 |
| 06030 | 6.6±0.2 | 7.3 | 3.0 | 2.9 | 1.6±0.5 |
| 06050 | 6.6±0.2 | 7.3 | 5.0 | 2.9 | 1.6±0.5 |
| 10030 | 10.1±0.3 | 11.6 | 3.0 | 3.0 | 2.5±0.5 |
| 10040 | 10.1±0.3 | 11.6 | 4.0 | 3.0 | 2.5±0.5 |
| 12050 | 12.6±0.2 | 13.8 | 5.0 | 3.7 | 2.7±0.7 |
| 12060 | 12.6±0.2 | 13.8 | 6.0 | 3.7 | 2.7±0.7 |

Recommended Pattern



Dimensions in mm

| TYPE | A | B | C |
|-------|-----|------|------|
| 04012 | 2.5 | 3.7 | 1.5 |
| 04015 | 2.5 | 3.7 | 1.5 |
| 04020 | 2.5 | 3.7 | 1.5 |
| 05012 | 2.5 | 4.1 | 1.9 |
| 05015 | 2.5 | 4.1 | 1.9 |
| 05018 | 2.5 | 4.1 | 1.9 |
| 05020 | 2.5 | 4.1 | 1.9 |
| 05030 | 2.5 | 4.1 | 1.9 |
| 06012 | 3.5 | 6.05 | 2.35 |
| 06015 | 3.5 | 6.05 | 2.35 |
| 06018 | 3.5 | 6.05 | 2.35 |
| 06024 | 3.5 | 6.05 | 2.35 |
| 06030 | 3.5 | 6.05 | 2.35 |
| 06050 | 3.5 | 6.05 | 2.35 |
| 10030 | 4.0 | 9.5 | 3.5 |
| 10040 | 4.0 | 9.5 | 3.5 |
| 12050 | 5.0 | 10.5 | 4.0 |
| 12060 | 5.5 | 10.5 | 4.0 |

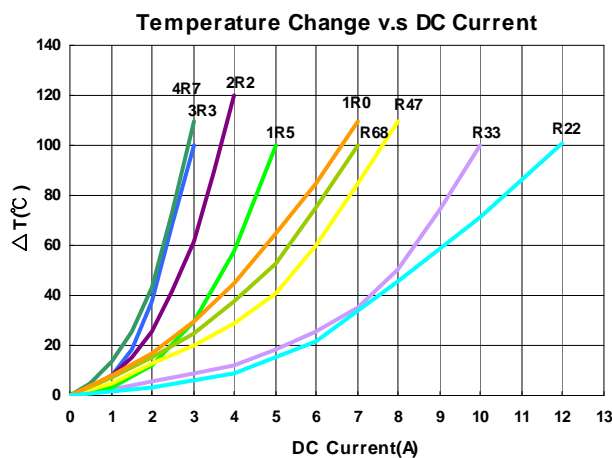
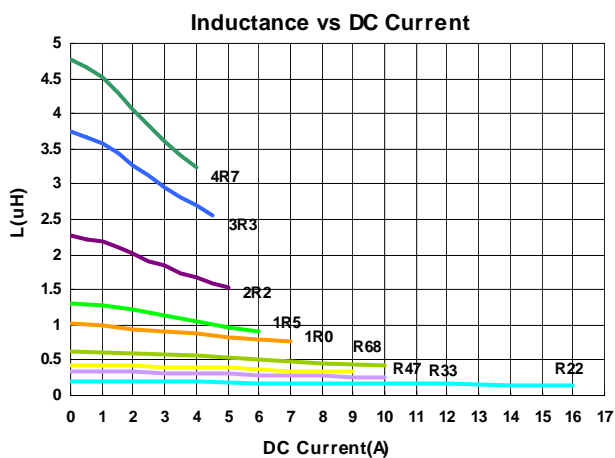
Electrical Characteristics

| Part Number | Inductance (uH) | Tolerance (±%) | Test Frequency (kHz) | RDC (mΩ) Max | Isat (A)Typ. | Irms (A)Typ. |
|-------------------|-----------------|----------------|----------------------|--------------|--------------|--------------|
| MHCI04012-R22M-R8 | 0.22 | 20 | 100 | 12 | 11.5 | 8.5 |
| MHCI04012-R33M-R8 | 0.33 | 20 | 100 | 19 | 8.5 | 6.5 |
| MHCI04012-R47M-R8 | 0.47 | 20 | 100 | 25 | 7.0 | 5.0 |
| MHCI04012-R68M-R8 | 0.68 | 20 | 100 | 36 | 6.0 | 4.5 |
| MHCI04012-1R0M-R8 | 1.0 | 20 | 100 | 47 | 5.2 | 4.2 |
| MHCI04012-1R5M-R8 | 1.5 | 20 | 100 | 75 | 4.0 | 3.25 |
| MHCI04012-2R2M-R8 | 2.2 | 20 | 100 | 83.5 | 3.5 | 2.75 |
| MHCI04012-3R3M-R8 | 3.3 | 20 | 100 | 165 | 3.0 | 2.0 |
| MHCI04012-4R7M-R8 | 4.7 | 20 | 100 | 195 | 2.8 | 1.8 |

Note: When ordering, please specify tolerance code. Tolerance: M=±20%

- Operating temperature range - 55°C ~ 125°C(Including self - temperature rise)
- Isat for Inductance drop 30% from its value without current
- I rms for a 40°C temperature rise from 25°C ambient with current
- Absolute maximum voltage 30VDC
- Measure Equipment :
 - L : WK 3260B or WK 6500P, 100kHz 0.5V
 - RDC : CHEN HWA 502 or CHEN HWA 46502B

Test Instruments : WK3260B Impedance / Material Analyzer



Please be sure to request approval specifications that provide further details of the products. Kindly note that the content of these specifications are subject to change or may be discontinued without advance notice. Please contact our sales department before ordering.

Molding Power Choke – MHCC/MHCI Series

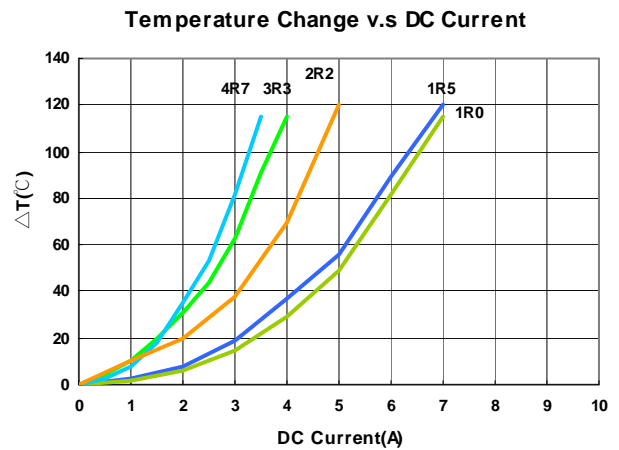
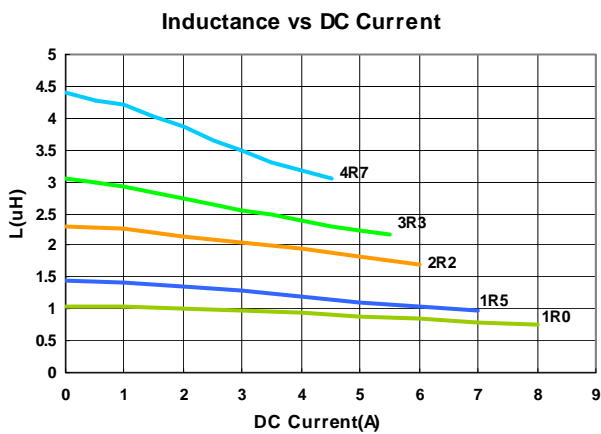
Electrical Characteristics

| Part Number | Inductance (uH) | Tolerance (±%) | Test Frequency (kHz) | RDC (mΩ) Max | Isat (A)Typ. | Irms (A)Typ. |
|-------------------|-----------------|----------------|----------------------|--------------|--------------|--------------|
| MHCI04015-1R0M-R8 | 1.0 | 20 | 100 | 42 | 7 | 4 |
| MHCI04015-1R5M-R8 | 1.5 | 20 | 100 | 50 | 6 | 3.5 |
| MHCI04015-2R2M-R8 | 2.2 | 20 | 100 | 79 | 5 | 3 |
| MHCI04015-3R3M-R8 | 3.3 | 20 | 100 | 132 | 4.5 | 2.3 |
| MHCI04015-4R7M-R8 | 4.7 | 20 | 100 | 146 | 4 | 2 |

Note: When ordering, please specify tolerance code. Tolerance: M=±20%

- Operating temperature range - 55°C ~ 125°C(Including self - temperature rise)
- Isat for Inductance drop 30% from its value without current
- I rms for a 40°C temperature rise from 25°C ambient with current
- Absolute maximum voltage 30VDC
- Measure Equipment :
L : WK 3260B or WK 6500P, 100kHz 0.5V
RDC : CHEN HWA 502 or CHEN HWA 46502B

Test Instruments : WK3260B Impedance / Material Analyzer



Please be sure to request approval specifications that provide further details of the products. Kindly note that the content of these specifications are subject to change or may be discontinued without advance notice. Please contact our sales department before ordering.

Molding Power Choke – MHCC/MHCI Series

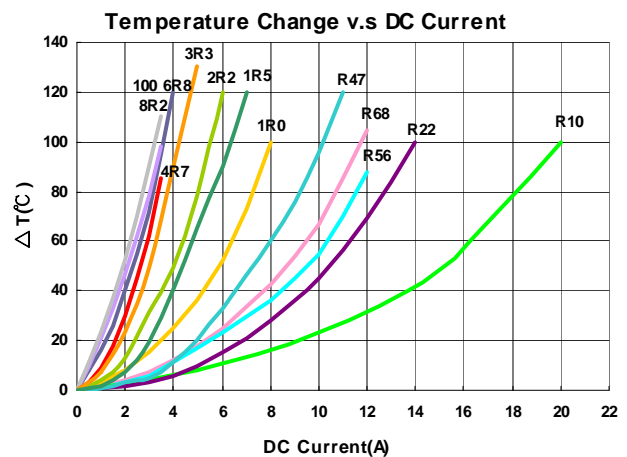
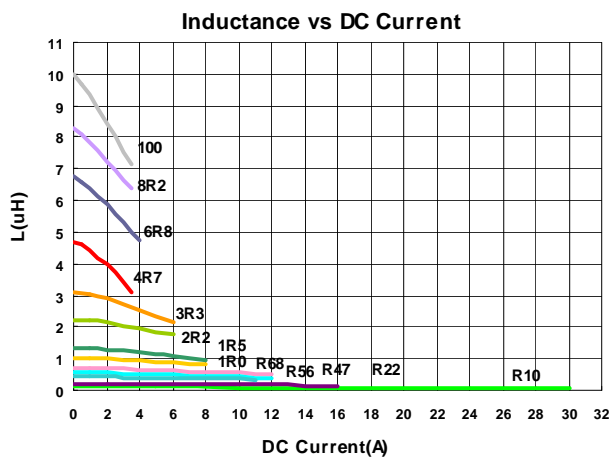
Electrical Characteristics

| Part Number | Inductance (uH) | Tolerance (±%) | Test Frequency (kHz) | RDC (mΩ) Max | Isat (A)Typ. | Irms (A)Typ. |
|-------------------|-----------------|----------------|----------------------|--------------|--------------|--------------|
| MHCI04020-R10M-R8 | 0.10 | 20 | 100 | 4 | 25 | 12.0 |
| MHCI04020-R22M-R8 | 0.22 | 20 | 100 | 6.6 | 12.5 | 9.0 |
| MHCI04020-R47M-R8 | 0.47 | 20 | 100 | 14 | 9.5 | 7.0 |
| MHCI04020-R56M-R8 | 0.56 | 20 | 100 | 16 | 10.0 | 6.5 |
| MHCI04020-R68M-R8 | 0.68 | 20 | 100 | 21 | 8.0 | 5.2 |
| MHCI04020-1R0M-R8 | 1.0 | 20 | 100 | 27 | 7.0 | 4.5 |
| MHCI04020-1R5M-R8 | 1.5 | 20 | 100 | 46 | 6.0 | 4.0 |
| MHCI04020-2R2M-R8 | 2.2 | 20 | 100 | 58 | 5.0 | 3.0 |
| MHCI04020-3R3M-R8 | 3.3 | 20 | 100 | 87 | 4.0 | 2.5 |
| MHCI04020-4R7M-R8 | 4.7 | 20 | 100 | 126 | 3.0 | 2.2 |
| MHCI04020-6R8M-R8 | 6.8 | 20 | 100 | 135 | 2.5 | 2.0 |
| MHCI04020-8R2M-R8 | 8.2 | 20 | 100 | 216 | 2.5 | 2.0 |
| MHCI04020-100M-R8 | 10 | 20 | 100 | 258 | 2.0 | 1.6 |

Note: When ordering, please specify tolerance code. Tolerance: M=±20%

- Operating temperature range - 55°C ~ 125°C(Including self - temperature rise)
- Isat for Inductance drop 30% from its value without current
- Irms for a 40°C temperature rise from 25°C ambient with current
- Absolute maximum voltage 30VDC
- Measure Equipment :
L : WK 3260B or WK 6500P, 100KHz 0.5V
RDC : CHEN HWA 502 or CHEN HWA 46502B

Test Instruments : WK3260B Impedance / Material Analyzer



Please be sure to request approval specifications that provide further details of the products. Kindly note that the content of these specifications are subject to change or may be discontinued without advance notice. Please contact our sales department before ordering.

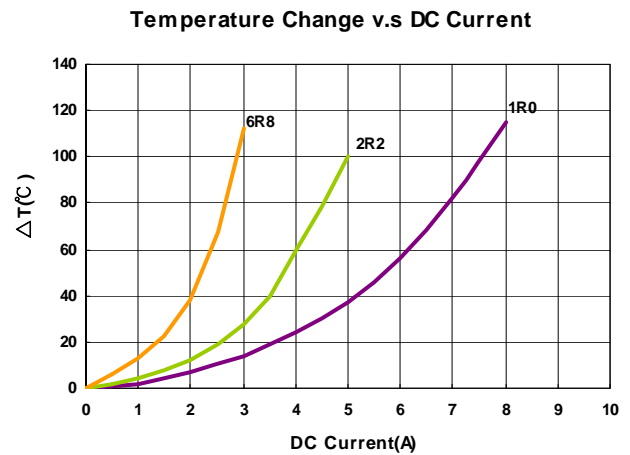
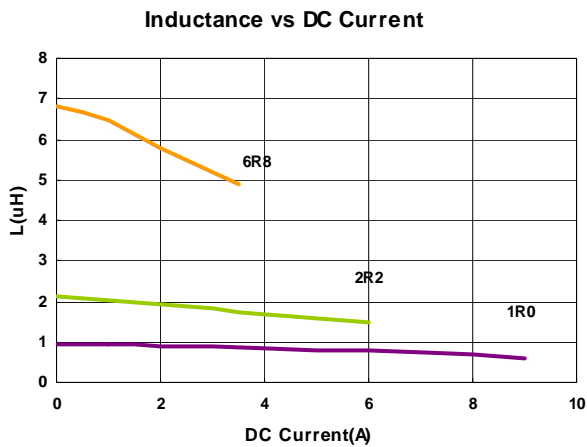
Electrical Characteristics

| Part Number | Inductance (uH) | Tolerance (±%) | Test Frequency (kHz) | RDC (mΩ) Max | Isat (A)Typ. | Irms (A)Typ. |
|--------------------|-----------------|----------------|----------------------|--------------|--------------|--------------|
| MHCI05012-1R0M-R8A | 1.0 | 20 | 100 | 30 | 6.0 | 5.0 |
| MHCI05012-2R2M-R8A | 2.2 | 20 | 100 | 76 | 4.0 | 3.5 |
| MHCI05012-6R8M-R8A | 6.8 | 20 | 100 | 250 | 2.3 | 2.0 |

Note: When ordering, please specify tolerance code. Tolerance: M=±20%

- Operating temperature range - 55°C ~ 125°C(Including self - temperature rise)
- Isat for Inductance drop 30% from its value without current
- Irms for a 40°C temperature rise from 25°C ambient with current
- Absolute maximum voltage 30VDC
- Measure Equipment :
 L : WK 3260B or WK 6500P, 100kHz 0.5V
 RDC : CHEN HWA 502 or CHEN HWA 46502B

Test Instruments : WK3260B Impedance / Material Analyzer



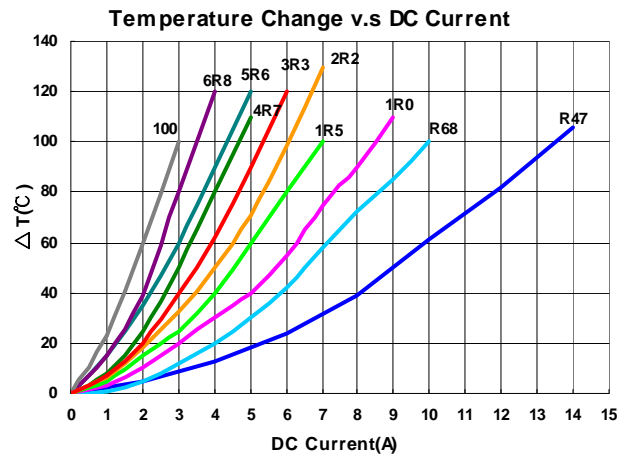
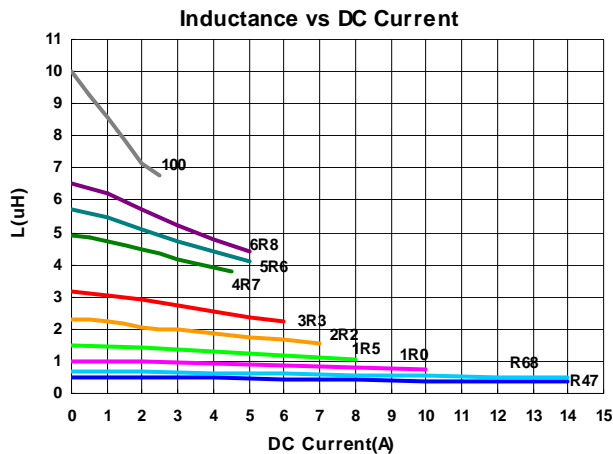
Electrical Characteristics

| Part Number | Inductance (uH) | Tolerance (±%) | Test Frequency (kHz) | RDC (mΩ) Max | Isat (A)Typ. | Irms (A)Typ. |
|-------------------|-----------------|----------------|----------------------|--------------|--------------|--------------|
| MHCI05015-R47M-R8 | 0.47 | 20 | 100 | 16 | 12 | 8.0 |
| MHCI05015-R68M-R8 | 0.68 | 20 | 100 | 23 | 10 | 6.0 |
| MHCI05015-1R0M-R8 | 1.0 | 20 | 100 | 33 | 8.0 | 5.0 |
| MHCI05015-1R5M-R8 | 1.5 | 20 | 100 | 50 | 6.0 | 4.0 |
| MHCI05015-2R2M-R8 | 2.2 | 20 | 100 | 68 | 6.0 | 3.3 |
| MHCI05015-3R3M-R8 | 3.3 | 20 | 100 | 84 | 5.0 | 3.0 |
| MHCI05015-4R7M-R8 | 4.7 | 20 | 100 | 135 | 4.0 | 2.5 |
| MHCI05015-5R6M-R8 | 5.6 | 20 | 100 | 175 | 3.5 | 2.2 |
| MHCI05015-6R8M-R8 | 6.8 | 20 | 100 | 192 | 3.0 | 2.0 |
| MHCI05015-100M-R8 | 10 | 20 | 100 | 195 | 2.0 | 1.5 |

Note: When ordering, please specify tolerance code. Tolerance: M=±20%

- Operating temperature range - 55°C ~ 125°C(Including self - temperature rise)
- Isat for Inductance drop 30% from its value without current
- I rms for a 40°C temperature rise from 25°C ambient with current
- Absolute maximum voltage 30VDC
- Measure Equipment :
L : WK 3260B or WK 6500P, 100kHz 0.5V
RDC : CHEN HWA 502 or CHEN HWA 46502B

Test Instruments : WK3260B Impedance / Material Analyzer



Please be sure to request approval specifications that provide further details of the products. Kindly note that the content of these specifications are subject to change or may be discontinued without advance notice. Please contact our sales department before ordering.

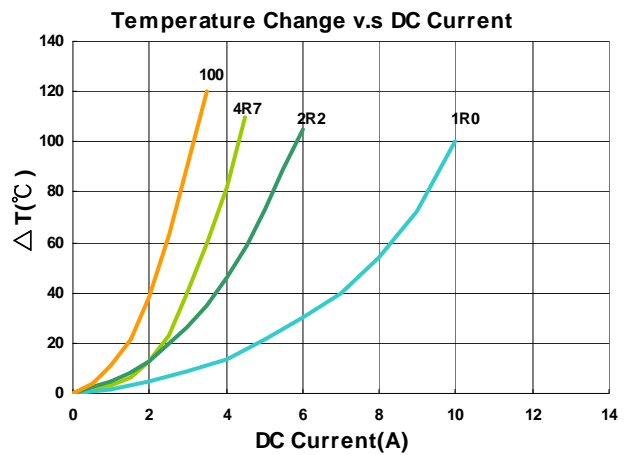
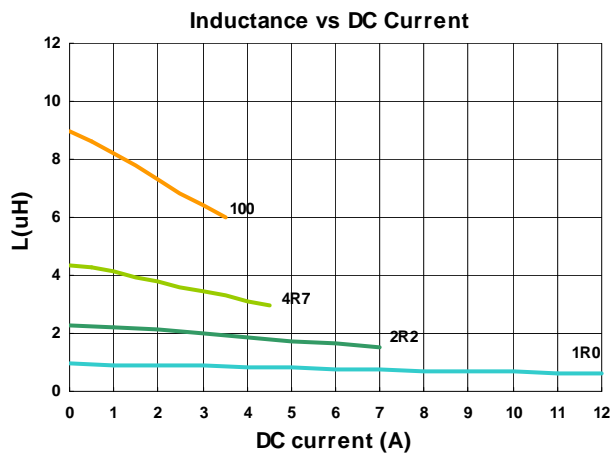
Electrical Characteristics

| Part Number | Inductance (uH) | Tolerance (±%) | Test Frequency (kHz) | RDC (mΩ) Max | Isat (A)Typ. | Irms (A)Typ. |
|--------------------|-----------------|----------------|----------------------|--------------|--------------|--------------|
| MHCI05015-1R0M-R8A | 1.0 | 20 | 100 | 23 | 9 | 6.5 |
| MHCI05015-2R2M-R8A | 2.2 | 20 | 100 | 64 | 6 | 3.3 |
| MHCI05015-4R7M-R8A | 4.7 | 20 | 100 | 106 | 4 | 3.0 |
| MHCI05015-100M-R8A | 10 | 20 | 100 | 170 | 3 | 2.0 |

Note: When ordering, please specify tolerance code. Tolerance: M=±20%

- Operating temperature range - 55°C ~ 125°C(Including self - temperature rise)
- Isat for Inductance drop 30% from its value without current
- I rms for a 40°C temperature rise from 25°C ambient with current
- Absolute maximum voltage 30VDC
- Measure Equipment :
 L : WK 3260B or WK 6500P, 100kHz 0.5V
 RDC : CHEN HWA 502 or CHEN HWA 46502B

Test Instruments : WK3260B Impedance / Material Analyzer



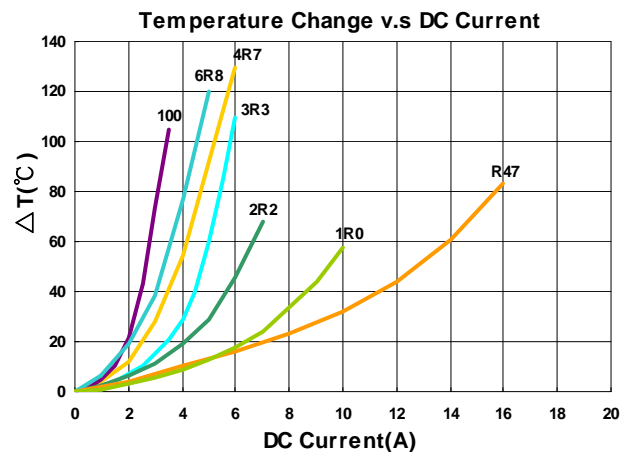
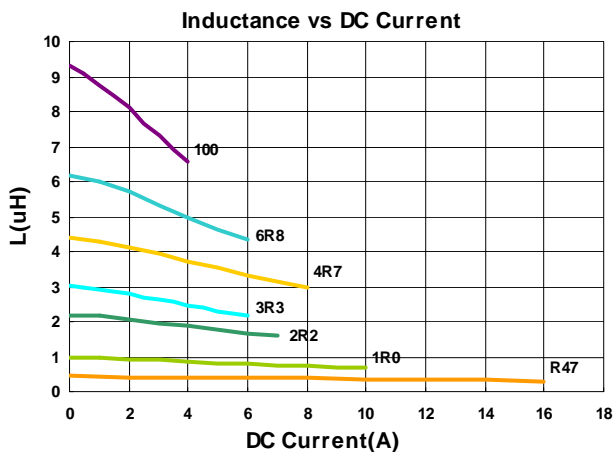
Electrical Characteristics

| Part Number | Inductance (uH) | Tolerance (±%) | Test Frequency (kHz) | RDC (mΩ) Max | Isat (A)Typ. | Irms (A)Typ. |
|--------------------|-----------------|----------------|----------------------|--------------|--------------|--------------|
| MHCI05018-R47M-R8A | 0.47 | 20 | 100 | 9.0 | 15.5 | 10.5 |
| MHCI05018-1R0M-R8A | 1.0 | 20 | 100 | 17 | 9.0 | 8.0 |
| MHCI05018-2R2M-R8A | 2.2 | 20 | 100 | 35 | 6.5 | 5.0 |
| MHCI05018-3R3M-R8A | 3.3 | 20 | 100 | 58 | 5.0 | 4.5 |
| MHCI05018-4R7M-R8A | 4.7 | 20 | 100 | 85 | 4.0 | 3.5 |
| MHCI05018-6R8M-R8A | 6.8 | 20 | 100 | 120 | 3.4 | 2.8 |
| MHCI05018-100M-R8A | 10 | 20 | 100 | 155 | 3.0 | 2.5 |

Note: When ordering, please specify tolerance code. Tolerance: M=±20%

- Operating temperature range - 55°C ~ 125°C(Including self - temperature rise)
- Isat for Inductance drop 30% from its value without current
- I rms for a 40°C temperature rise from 25°C ambient with current
- Absolute maximum voltage 30VDC
- Measure Equipment :
 - L : WK 3260B or WK 6500P, 100kHz 0.5V
 - RDC : CHEN HWA 502 or CHEN HWA 46502B

Test Instruments : WK3260B Impedance / Material Analyzer



Electrical Characteristics

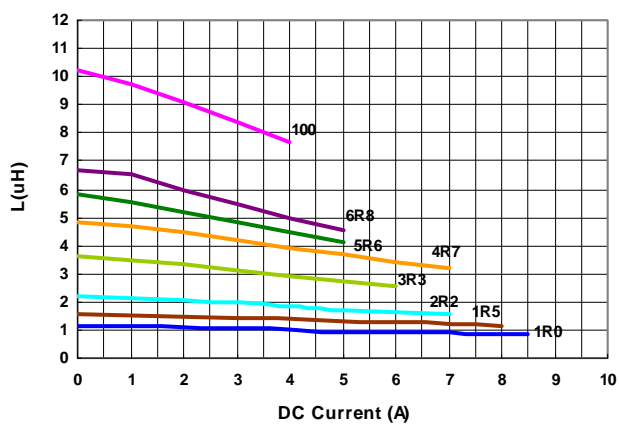
| Part Number | Inductance (uH) | Tolerance (±%) | Test Frequency (kHz) | RDC (mΩ) Max | Isat (A)Typ. | Irms (A)Typ. |
|-------------------|-----------------|----------------|----------------------|--------------|--------------|--------------|
| MHCI05020-R47M-R8 | 0.47 | 20 | 100 | 9 | 15.5 | 10.5 |
| MHCI05020-1R0M-R8 | 1.0 | 20 | 100 | 30 | 7.0 | 6.0 |
| MHCI05020-1R5M-R8 | 1.5 | 20 | 100 | 35 | 6.5 | 5.5 |
| MHCI05020-2R2M-R8 | 2.2 | 20 | 100 | 45 | 6.0 | 4.0 |
| MHCI05020-3R3M-R8 | 3.3 | 20 | 100 | 60 | 5.5 | 3.5 |
| MHCI05020-4R7M-R8 | 4.7 | 20 | 100 | 90 | 5.0 | 3.0 |
| MHCI05020-5R6M-R8 | 5.6 | 20 | 100 | 120 | 4.5 | 2.8 |
| MHCI05020-6R8M-R8 | 6.8 | 20 | 100 | 125 | 4.5 | 2.8 |
| MHCI05020-100M-R8 | 10 | 20 | 100 | 180 | 4.0 | 2.3 |

Note: When ordering, please specify tolerance code. Tolerance: M=±20%

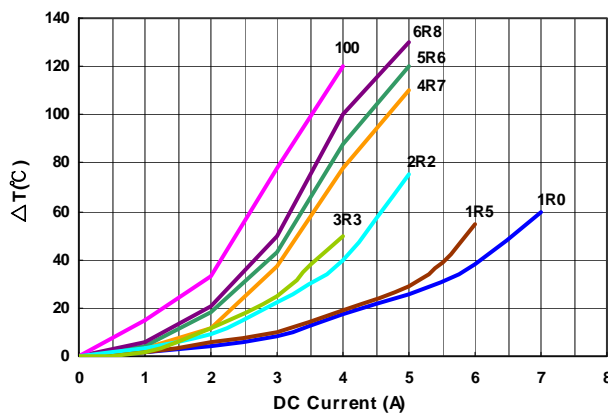
- Operating temperature range - 55°C ~ 125°C(Including self - temperature rise)
- Isat for Inductance drop 30% from its value without current
- I rms for a 40°C temperature rise from 25°C ambient with current
- Absolute maximum voltage 30VDC
- Measure Equipment :
 - L : WK 3260B or WK 6500P, 100kHz 0.5V
 - RDC : CHEN HWA 502 or CHEN HWA 46502B

Test Instruments : WK3260B Impedance / Material Analyzer

Inductance v.s DC Current



Temperature Change v.s DC Current



Please be sure to request approval specifications that provide further details of the products. Kindly note that the content of these specifications are subject to change or may be discontinued without advance notice. Please contact our sales department before ordering.

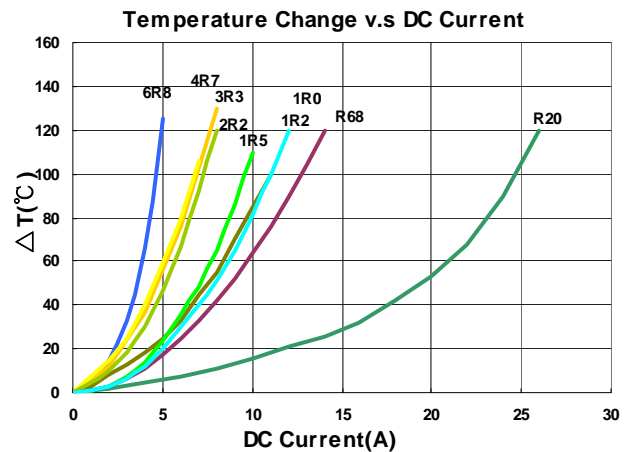
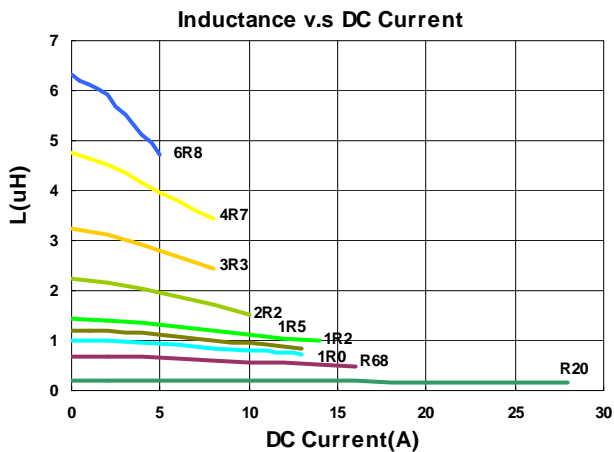
Electrical Characteristics

| Part Number | Inductance (uH) | Tolerance (±%) | Test Frequency (kHz) | RDC (mΩ)Max | Isat (A)Typ. | Irms (A)Typ. |
|-------------------|-----------------|----------------|----------------------|-------------|--------------|--------------|
| MHCI05030-R20M-R8 | 0.20 | 20 | 100 | 3.9 | 14.5 | 17.0 |
| MHCI05030-R47M-R8 | 0.47 | 20 | 100 | 8 | 14 | 10.0 |
| MHCI05030-R68M-R8 | 0.68 | 20 | 100 | 12 | 14 | 8.0 |
| MHCI05030-1R0M-R8 | 1.0 | 20 | 100 | 15 | 11 | 7.0 |
| MHCI05030-1R2M-R8 | 1.2 | 20 | 100 | 15 | 11 | 6.5 |
| MHCI05030-1R5M-R8 | 1.5 | 20 | 100 | 25 | 10 | 6.0 |
| MHCI05030-2R2M-R8 | 2.2 | 20 | 100 | 35 | 8 | 5.0 |
| MHCI05030-3R3M-R8 | 3.3 | 20 | 100 | 46 | 7 | 4.5 |
| MHCI05030-4R7M-R8 | 4.7 | 20 | 100 | 60 | 6 | 4.0 |
| MHCI05030-6R8M-R8 | 6.8 | 20 | 100 | 110 | 5 | 3.0 |
| MHCI05030-100M-R8 | 10 | 20 | 100 | 126 | 4.5 | 1.5 |

Note: When ordering, please specify tolerance code. Tolerance: M=±20%

- Operating temperature range - 55°C ~ 125°C(Including self - temperature rise)
- Isat for Inductance drop 30% from its value without current
- I rms for a 40°C temperature rise from 25°C ambient with current
- Absolute maximum voltage 30VDC
- Measure Equipment :
 L : WK 3260B or WK 6500P, 100kHz 0.5V
 RDC : CHEN HWA 502 or CHEN HWA 46502B

Test Instruments : WK3260B Impedance / Material Analyzer



Electrical Characteristics

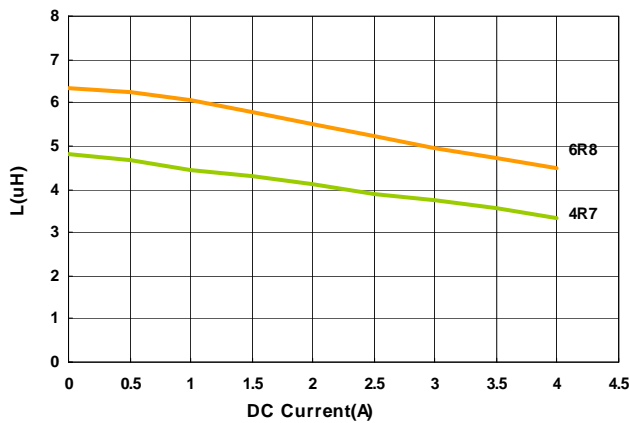
| Part Number | Inductance (uH) | Tolerance (±%) | Test Frequency (kHz) | RDC (mΩ) Max | Isat (A)Typ. | Irms (A)Typ. |
|--------------------|-----------------|----------------|----------------------|--------------|--------------|--------------|
| MHCI06012-4R7M-R8A | 4.7 | 20 | 100 | 122 | 3.5 | 2.5 |
| MHCI06012-6R8M-R8A | 6.8 | 20 | 100 | 210 | 2.8 | 2.2 |

Note: When ordering, please specify tolerance code. Tolerance: M=±20%

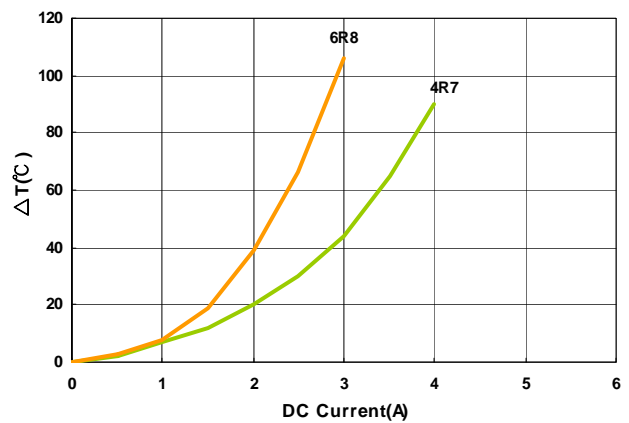
- Operating temperature range - 55°C ~ 125°C(Including self - temperature rise)
- Isat for Inductance drop 30% from its value without current
- I rms for a 40°C temperature rise from 25°C ambient with current
- Absolute maximum voltage 30VDC
- Measure Equipment :
 L : WK 3260B or WK 6500P, 100kHz 0.5V
 RDC : CHEN HWA 502 or CHEN HWA 46502B

Test Instruments : WK3260B Impedance / Material Analyzer

Inductance vs DC Current



Temperature Change v.s DC Current



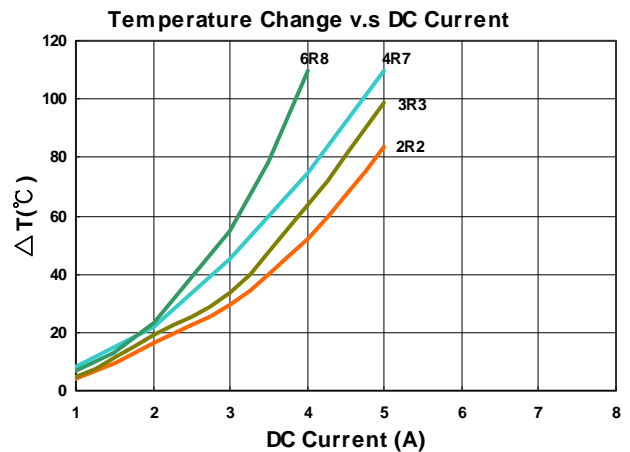
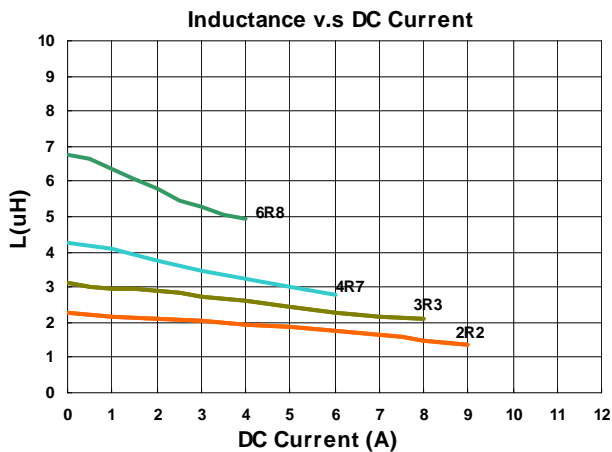
Electrical Characteristics

| Part Number | Inductance (uH) | Tolerance (±%) | Test Frequency (kHz) | RDC (mΩ)Max | Isat (A)Typ. | Irms (A)Typ. |
|-------------------|-----------------|----------------|----------------------|-------------|--------------|--------------|
| MHCI06015-2R2M-R8 | 2.2 | 20 | 100 | 54 | 6.0 | 3.5 |
| MHCI06015-3R3M-R8 | 3.3 | 20 | 100 | 63 | 5.5 | 3.3 |
| MHCI06015-4R7M-R8 | 4.7 | 20 | 100 | 105 | 4.5 | 3.2 |
| MHCI06015-6R8M-R8 | 6.8 | 20 | 100 | 140 | 4.0 | 2.5 |

Note: When ordering, please specify tolerance code. Tolerance: M=±20%

- Operating temperature range - 55°C ~ 125°C(Including self - temperature rise)
- Isat for Inductance drop 30% from its value without current
- I rms for a 40°C temperature rise from 25°C ambient with current
- Absolute maximum voltage 30VDC
- Measure Equipment :
 L : WK 3260B or WK 6500P, 100kHz 0.5V
 RDC : CHEN HWA 502 or CHEN HWA 46502B

Test Instruments : WK3260B Impedance / Material Analyzer



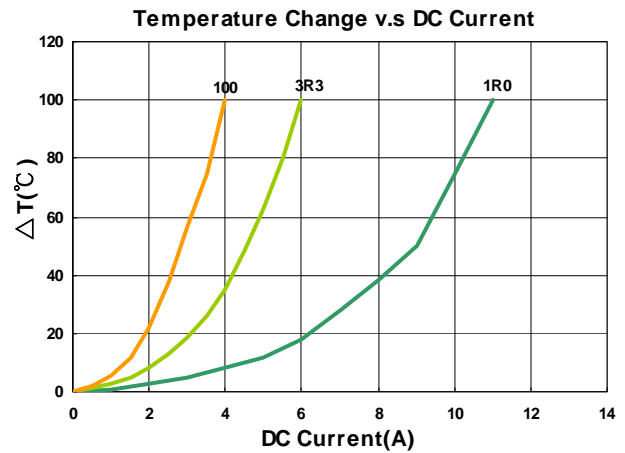
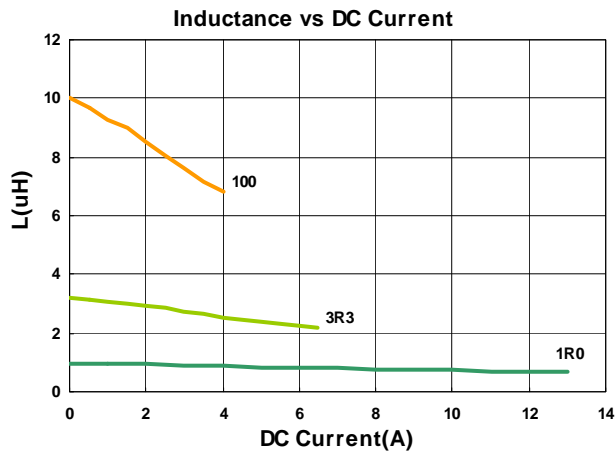
Electrical Characteristics

| Part Number | Inductance (uH) | Tolerance (±%) | Test Frequency (kHz) | RDC (mΩ)Max | Isat (A)Typ. | Irms (A)Typ. |
|--------------------|-----------------|----------------|----------------------|-------------|--------------|--------------|
| MHCI06015-1R0M-R8A | 1.0 | 20 | 100 | 21 | 9.0 | 5.5 |
| MHCI06015-3R3M-R8A | 3.3 | 20 | 100 | 63 | 5.5 | 3.3 |
| MHCI06015-100M-R8A | 10 | 20 | 100 | 175 | 3.0 | 2.0 |

Note: When ordering, please specify tolerance code. Tolerance: M=±20%

- Operating temperature range - 55°C ~ 125°C(Including self - temperature rise)
- Isat for Inductance drop 30% from its value without current
- I rms for a 40°C temperature rise from 25°C ambient with current
- Absolute maximum voltage 30VDC
- Measure Equipment :
 L : WK 3260B or WK 6500P, 100kHz 0.5V
 RDC : CHEN HWA 502 or CHEN HWA 46502B

Test Instruments : WK3260B Impedance / Material Analyzer



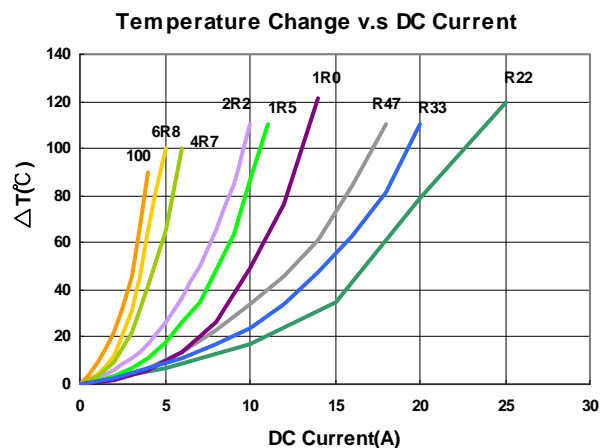
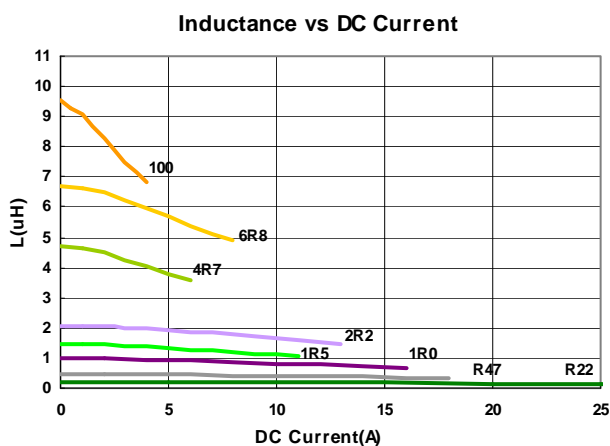
Electrical Characteristics

| Part Number | Inductance (uH) | Tolerance (±%) | Test Frequency (kHz) | RDC (mΩ)Max | Isat (A)Typ. | Irms (A)Typ. |
|--------------------|-----------------|----------------|----------------------|-------------|--------------|--------------|
| MHCI06018-R22M-R8A | 0.22 | 20 | 100 | 5.2 | 29 | 14 |
| MHCI06018-R33M-R8A | 0.33 | 20 | 100 | 6.8 | 22 | 12 |
| MHCI06018-R47M-R8A | 0.47 | 20 | 100 | 8.4 | 18 | 11 |
| MHCI06018-R68M-R8A | 0.68 | 20 | 100 | 12.7 | 17 | 9 |
| MHCI06018-1R0M-R8A | 1.0 | 20 | 100 | 17 | 14 | 7 |
| MHCI06018-1R5M-R8A | 1.5 | 20 | 100 | 26 | 12 | 6.5 |
| MHCI06018-2R2M-R8A | 2.2 | 20 | 100 | 35 | 10 | 6.0 |
| MHCI06018-4R7M-R8A | 4.7 | 20 | 100 | 70 | 5 | 3.5 |
| MHCI06018-6R8M-R8A | 6.8 | 20 | 100 | 110 | 3.5 | 2.8 |
| MHCI06018-100M-R8A | 10 | 20 | 100 | 155 | 2.5 | 2.3 |

Note: When ordering, please specify tolerance code. Tolerance: M=±20%

- Operating temperature range - 55°C ~ 125°C(Including self - temperature rise)
- Isat for Inductance drop 30% from its value without current
- I rms for a 40°C temperature rise from 25°C ambient with current
- Absolute maximum voltage 30VDC
- Measure Equipment :
 L : WK 3260B or WK 6500P, 100kHz 0.5V
 RDC : CHEN HWA 502 or CHEN HWA 46502B

Test Instruments : WK3260B Impedance / Material Analyzer



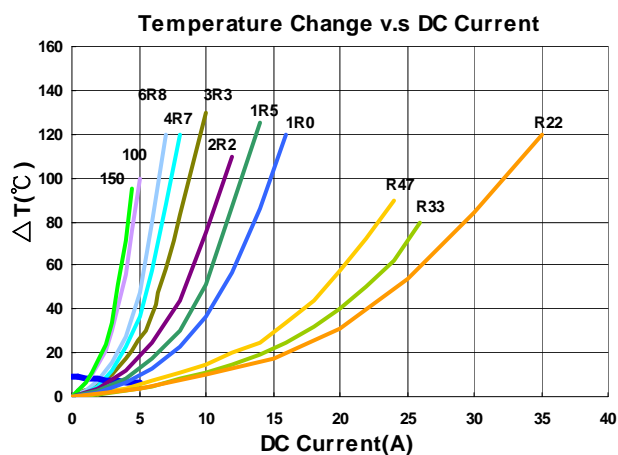
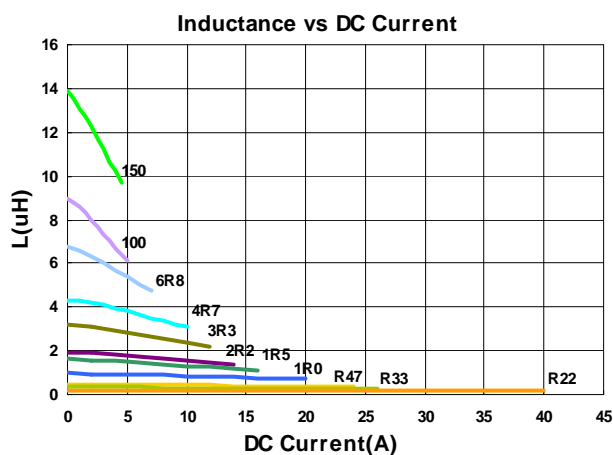
Electrical Characteristics

| Part Number | Inductance (uH) | Tolerance (±%) | Test Frequency (kHz) | RDC (mΩ)Max | Isat (A)Typ. | Irms (A)Typ. |
|--------------------|-----------------|----------------|----------------------|-------------|--------------|--------------|
| MHCI06024-R22M-R8A | 0.22 | 20 | 100 | 3.2 | 34 | 21 |
| MHCI06024-R33M-R8A | 0.33 | 20 | 100 | 4.1 | 24.5 | 18 |
| MHCI06024-R47M-R8A | 0.47 | 20 | 100 | 5.1 | 22 | 15 |
| MHCI06024-1R0M-R8A | 1.0 | 20 | 100 | 13.5 | 16 | 9 |
| MHCI06024-1R5M-R8A | 1.5 | 20 | 100 | 20 | 15 | 9 |
| MHCI06024-2R2M-R8A | 2.2 | 20 | 100 | 28 | 14 | 7 |
| MHCI06024-3R3M-R8A | 3.3 | 20 | 100 | 39 | 10 | 5.5 |
| MHCI06024-4R7M-R8A | 4.7 | 20 | 100 | 50 | 10 | 5.0 |
| MHCI06024-6R8M-R8A | 6.8 | 20 | 100 | 70 | 6.0 | 4.0 |
| MHCI06024-100M-R8A | 10 | 20 | 100 | 101 | 4.0 | 3.1 |
| MHCI06024-150M-R8A | 15 | 20 | 100 | 160 | 3.3 | 2.5 |

Note: When ordering, please specify tolerance code. Tolerance: M=±20%

- Operating temperature range - 55°C ~ 125°C(Including self - temperature rise)
- Isat for Inductance drop 30% from its value without current
- I rms for a 40°C temperature rise from 25°C ambient with current
- Absolute maximum voltage 30VDC
- Measure Equipment :
 L : WK 3260B or WK 6500P, 100kHz 0.5V
 RDC : CHEN HWA 502 or CHEN HWA 46502B

Test Instruments : WK3260B Impedance / Material Analyzer



Please be sure to request approval specifications that provide further details of the products. Kindly note that the content of these specifications are subject to change or may be discontinued without advance notice. Please contact our sales department before ordering.

Electrical Characteristics

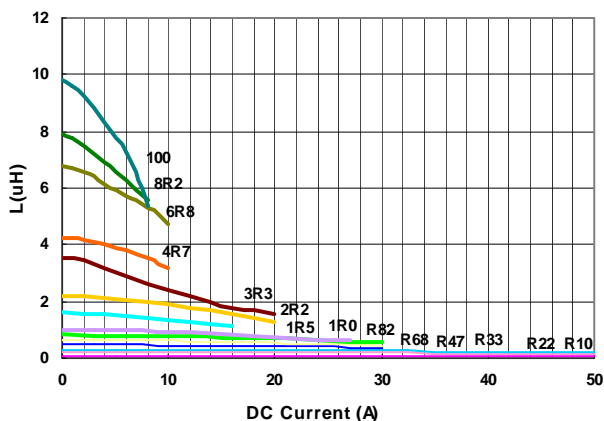
| Part Number | Inductance (uH) | Tolerance (±%) | Test Frequency (kHz) | RDC (mΩ) Max | Isat (A)Typ. | Irms (A)Typ. |
|-------------------|-----------------|----------------|----------------------|--------------|--------------|--------------|
| MHCI06030-R10M-R8 | 0.10 | 20 | 100 | 1.5 | 45 | 37 |
| MHCI06030-R22M-R8 | 0.22 | 20 | 100 | 2.8 | 40 | 23 |
| MHCI06030-R33M-R8 | 0.33 | 20 | 100 | 4.2 | 33 | 20 |
| MHCI06030-R47M-R8 | 0.47 | 20 | 100 | 5.5 | 27 | 16.5 |
| MHCI06030-R56M-R8 | 0.56 | 20 | 100 | 5.5 | 27 | 16.5 |
| MHCI06030-R68M-R8 | 0.68 | 20 | 100 | 6.3 | 24 | 15 |
| MHCI06030-R82M-R8 | 0.82 | 20 | 100 | 8.0 | 23 | 13 |
| MHCI06030-1R0M-R8 | 1.0 | 20 | 100 | 10 | 22 | 12 |
| MHCI06030-1R5M-R8 | 1.5 | 20 | 100 | 15 | 18 | 9.5 |
| MHCI06030-1R8M-R8 | 1.8 | 20 | 100 | 15 | 14 | 9.5 |
| MHCI06030-2R2M-R8 | 2.2 | 20 | 100 | 20 | 14 | 8.5 |
| MHCI06030-3R3M-R8 | 3.3 | 20 | 100 | 35 | 12 | 6.0 |
| MHCI06030-4R7M-R8 | 4.7 | 20 | 100 | 40 | 9 | 5.5 |
| MHCI06030-5R6M-R8 | 5.6 | 20 | 100 | 40 | 8 | 5.5 |
| MHCI06030-6R8M-R8 | 6.8 | 20 | 100 | 60 | 8 | 4.5 |
| MHCC06030-8R2M-R7 | 8.2 | 20 | 100 | 60 | 6 | 4.5 |
| MHCC06030-100M-R7 | 10 | 20 | 100 | 68 | 5.5 | 4.0 |
| MHCI06030-150M-R8 | 15 | 20 | 100 | 122 | 5.0 | 3.0 |
| MHCI06030-220M-R8 | 22 | 20 | 100 | 145 | 3.2 | 3.0 |
| MHCI06030-330M-R8 | 33 | 20 | 100 | 270 | 3.0 | 2.0 |

Note: When ordering, please specify tolerance code. Tolerance: M=±20%

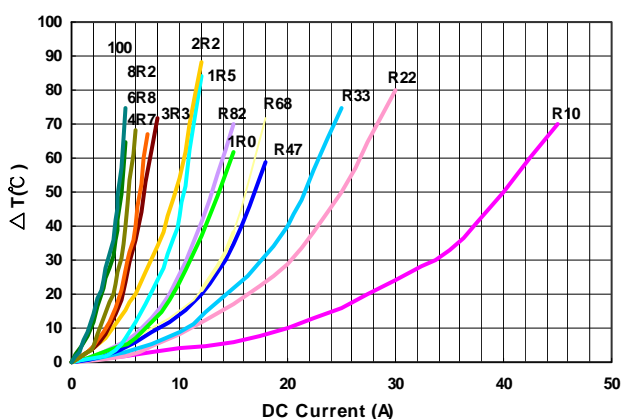
- Operating temperature range - 55°C ~ 125°C(Including self - temperature rise)
- Isat for Inductance drop 30% from its value without current
- I rms for a 40°C temperature rise from 25°C ambient with current
- Absolute maximum voltage 30VDC
- Measure Equipment :
 L : WK 3260B or WK 6500P, 100kHz 0.5V
 RDC : CHEN HWA 502 or CHEN HWA 46502B

Test Instruments : WK3260B Impedance / Material Analyzer

Inductance v.s DC Current



Temperature Change v.s DC Current



Please be sure to request approval specifications that provide further details of the products. Kindly note that the content of these specifications are subject to change or may be discontinued without advance notice. Please contact our sales department before ordering.

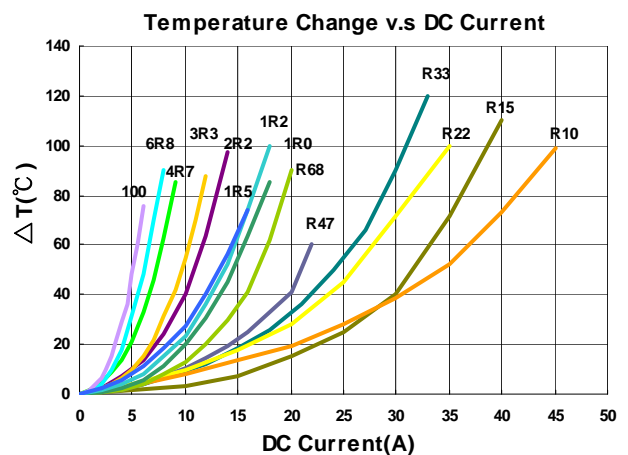
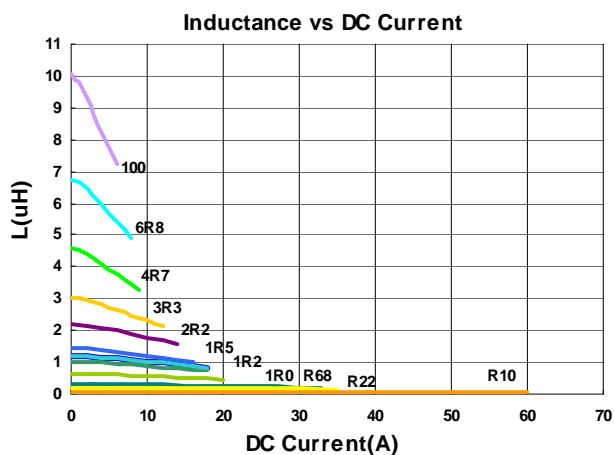
Electrical Characteristics

| Part Number | Inductance (uH) | Tolerance (±%) | Test Frequency (kHz) | RDC (mΩ)Max | Isat (A)Typ. | Irms (A)Typ. |
|--------------------|-----------------|----------------|----------------------|-------------|--------------|--------------|
| MHCI06030-R10M-R8A | 0.10 | 20 | 100 | 1.7 | 60 | 32.5 |
| MHCI06030-R15M-R8A | 0.15 | 20 | 100 | 2.5 | 60 | 30 |
| MHCI06030-R22M-R8A | 0.22 | 20 | 100 | 3.0 | 34 | 23 |
| MHCI06030-R33M-R8A | 0.33 | 20 | 100 | 3.5 | 25 | 21 |
| MHCI06030-R36M-R8A | 0.36 | 20 | 100 | 3.9 | 24 | 20 |
| MHCI06030-R47M-R8A | 0.47 | 20 | 100 | 4.1 | 20 | 18 |
| MHCI06030-R56M-R8A | 0.56 | 20 | 100 | 4.5 | 18 | 16.5 |
| MHCI06030-R68M-R8A | 0.68 | 20 | 100 | 5.3 | 17 | 16 |
| MHCI06030-R82M-R8A | 0.82 | 20 | 100 | 6.0 | 16 | 14 |
| MHCI06030-1R0M-R8A | 1.0 | 20 | 100 | 7.4 | 15 | 12 |
| MHCI06030-1R2M-R8A | 1.2 | 20 | 100 | 10 | 14 | 10 |
| MHCI06030-1R5M-R8A | 1.5 | 20 | 100 | 12.1 | 14 | 10 |
| MHCI06030-2R2M-R8A | 2.2 | 20 | 100 | 15 | 10 | 8 |
| MHCI06030-3R3M-R8A | 3.3 | 20 | 100 | 22 | 9.5 | 6.5 |
| MHCI06030-4R7M-R8A | 4.7 | 20 | 100 | 33 | 6.5 | 5.5 |
| MHCI06030-6R8M-R8A | 6.8 | 20 | 100 | 50 | 6 | 4.5 |
| MHCI06030-100M-R8A | 10 | 20 | 100 | 68 | 5.5 | 4 |

Note: When ordering, please specify tolerance code. Tolerance: M=±20%

- Operating temperature range - 55°C ~ 125°C(Including self - temperature rise)
- Isat for Inductance drop 30% from its value without current
- Irms for a 40°C temperature rise from 25°C ambient with current
- Absolute maximum voltage 30VDC
- Measure Equipment :
 L : WK 3260B or WK 6500P, 100kHz 0.5V
 RDC : CHEN HWA 502 or CHEN HWA 46502B

Test Instruments : WK3260B Impedance / Material Analyzer



Please be sure to request approval specifications that provide further details of the products. Kindly note that the content of these specifications are subject to change or may be discontinued without advance notice. Please contact our sales department before ordering.

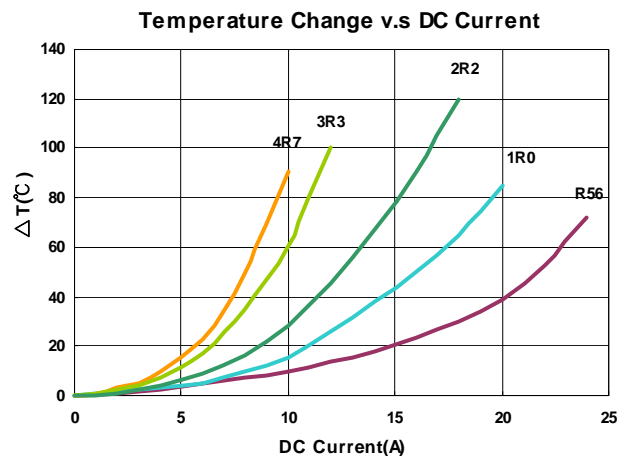
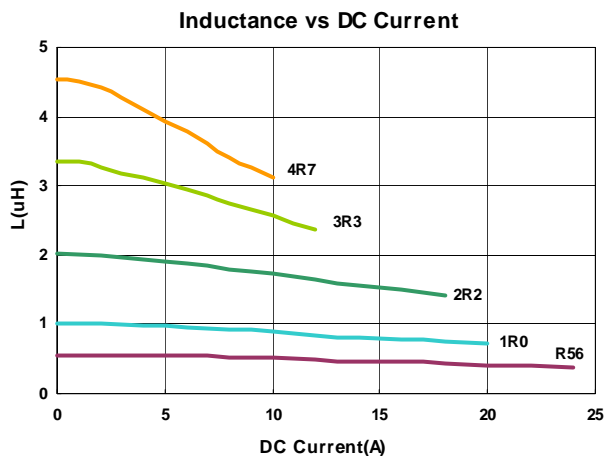
Electrical Characteristics

| Part Number | Inductance (uH) | Tolerance (±%) | Test Frequency (kHz) | RDC (mΩ) Max | Isat (A)Typ. | Irms (A)Typ. |
|--------------------|-----------------|----------------|----------------------|--------------|--------------|--------------|
| MHCI06050-R56M-R8A | 0.56 | 20 | 100 | 3.3 | 20 | 20 |
| MHCI06050-1R0M-R8A | 1.0 | 20 | 100 | 6.5 | 15 | 13 |
| MHCI06050-2R2M-R8A | 2.2 | 20 | 100 | 12.5 | 12 | 8 |
| MHCI06050-3R3M-R8A | 3.3 | 20 | 100 | 20.9 | 9 | 7 |
| MHCI06050-4R7M-R8A | 4.7 | 20 | 100 | 25.0 | 7 | 6.5 |

Note: When ordering, please specify tolerance code. Tolerance: M=±20%

- Operating temperature range - 55°C ~ 125°C(Including self - temperature rise)
- Isat for Inductance drop 30% from its value without current
- I rms for a 40°C temperature rise from 25°C ambient with current
- Absolute maximum voltage 30VDC
- Measure Equipment :
L : WK 3260B or WK 6500P, 100kHz 0.5V
RDC : CHEN HWA 502 or CHEN HWA 46502B

Test Instruments : WK3260B Impedance / Material Analyzer



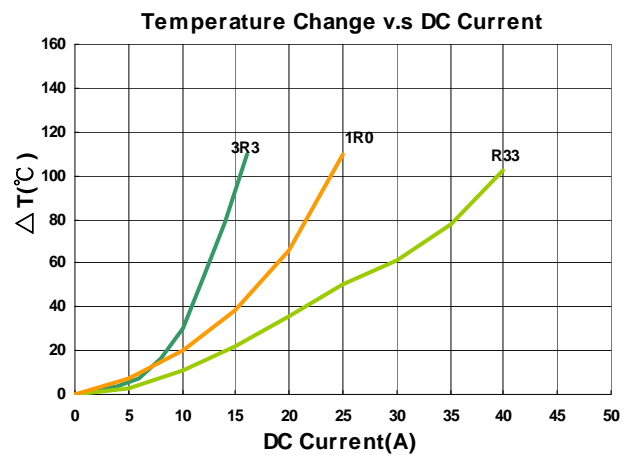
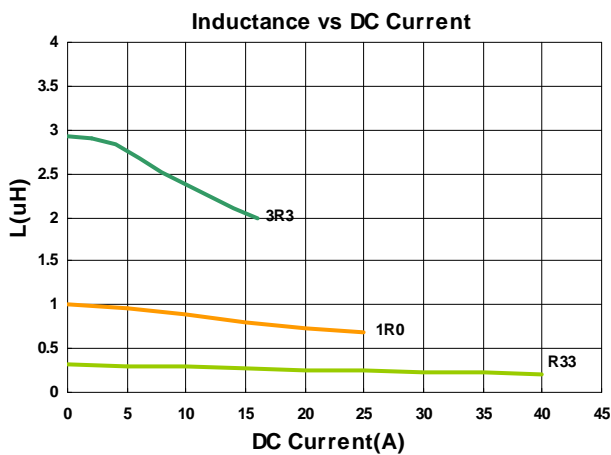
Electrical Characteristics

| Part Number | Inductance (uH) | Tolerance (±%) | Test Frequency (kHz) | RDC (mΩ) Max | Isat (A)Typ. | Irms (A)Typ. |
|--------------------|-----------------|----------------|----------------------|--------------|--------------|--------------|
| MHCC10030-R33M-R7A | 0.33 | 20 | 100 | 1.6 | 32 | 23 |
| MHCC10030-1R0M-R7A | 1.0 | 20 | 100 | 6.0 | 21 | 15 |
| MHCC10030-3R3M-R7A | 3.3 | 20 | 100 | 16.0 | 14 | 9 |

Note: When ordering, please specify tolerance code. Tolerance: M=±20%

- Operating temperature range - 55°C ~ 125°C(Including self - temperature rise)
- Isat for Inductance drop 30% from its value without current
- I rms for a 40°C temperature rise from 25°C ambient with current
- Absolute maximum voltage 30VDC
- Measure Equipment :
 L : WK 3260B or WK 6500P, 100kHz 0.5V
 RDC : CHEN HWA 502 or CHEN HWA 46502B

Test Instruments : WK3260B Impedance / Material Analyzer



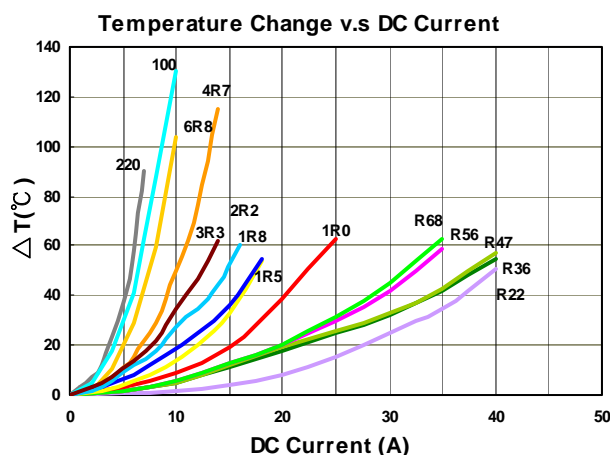
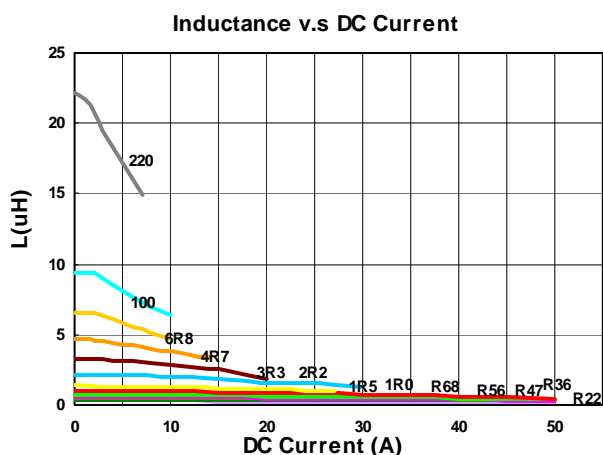
Electrical Characteristics

| Part Number | Inductance (uH) | Tolerance (±%) | Test Frequency (kHz) | RDC (mΩ) Max | Isat (A)Typ. | Irms (A)Typ. |
|-------------------|-----------------|----------------|----------------------|--------------|--------------|--------------|
| MHCC10040-R22M-R7 | 0.22 | 20 | 100 | 0.6 | 45 | 35 |
| MHCC10040-R36M-R7 | 0.36 | 20 | 100 | 1.2 | 42 | 34 |
| MHCC10040-R45M-R7 | 0.45 | 20 | 100 | 1.2 | 38 | 33 |
| MHCC10040-R47M-R7 | 0.47 | 20 | 100 | 1.2 | 38 | 33 |
| MHCC10040-R56M-R7 | 0.56 | 20 | 100 | 1.55 | 32 | 27 |
| MHCC10040-R68M-R7 | 0.68 | 20 | 100 | 1.55 | 30 | 27 |
| MHCC10040-1R0M-R7 | 1.0 | 20 | 100 | 3.1 | 26 | 20 |
| MHCC10040-1R5M-R7 | 1.5 | 20 | 100 | 4.2 | 22 | 16 |
| MHCC10040-1R8M-R7 | 1.8 | 20 | 100 | 5 | 16 | 15.3 |
| MHCC10040-2R2M-R7 | 2.2 | 20 | 100 | 7 | 16 | 14 |
| MHCC10040-3R3M-R7 | 3.3 | 20 | 100 | 13.2 | 12 | 11 |
| MHCC10040-4R7M-R7 | 4.7 | 20 | 100 | 16.5 | 12 | 9 |
| MHCC10040-6R8M-R7 | 6.8 | 20 | 100 | 25 | 10 | 6 |
| MHCC10040-8R2M-R7 | 8.2 | 20 | 100 | 30 | 9 | 6 |
| MHCC10040-100M-R7 | 10 | 20 | 100 | 30 | 7 | 6.5 |
| MHCC10040-150M-R7 | 15 | 20 | 100 | 45 | 6 | 6.25 |
| MHCC10040-220M-R7 | 22 | 20 | 100 | 72 | 5.5 | 5 |

Note: When ordering, please specify tolerance code. Tolerance: M=±20%

- Operating temperature range - 55°C ~ 125°C(Including self - temperature rise)
- Isat for Inductance drop 30% from its value without current
- I rms for a 40°C temperature rise from 25°C ambient with current
- Absolute maximum voltage 30VDC
- Measure Equipment :
 L : WK 3260B or WK 6500P, 100kHz 0.5V
 RDC : CHEN HWA 502 or CHEN HWA 46502B

Test Instruments : WK3260B Impedance / Material Analyzer



Please be sure to request approval specifications that provide further details of the products. Kindly note that the content of these specifications are subject to change or may be discontinued without advance notice. Please contact our sales department before ordering.

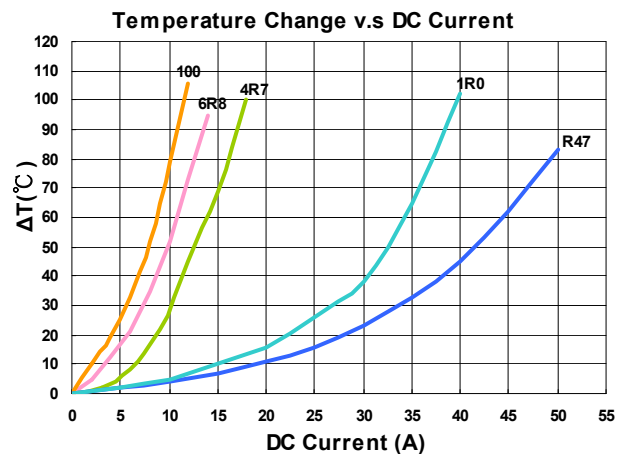
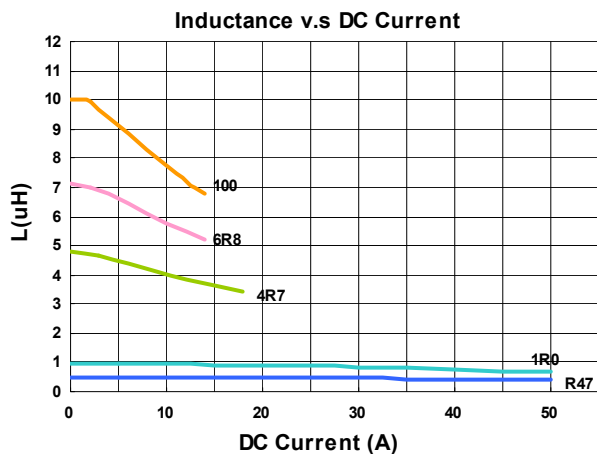
Electrical Characteristics

| Part Number | Inductance (uH) | Tolerance (±%) | Test Frequency (kHz) | RDC (mΩ) Max | Isat (A)Typ. | Irms (A)Typ. |
|-------------------|-----------------|----------------|----------------------|--------------|--------------|--------------|
| MHCC12050-R47M-R7 | 0.47 | 20 | 100 | 1.2 | 46 | 37 |
| MHCC12050-1R0M-R7 | 1.0 | 20 | 100 | 2.5 | 37 | 29 |
| MHCC12050-1R5M-R7 | 1.5 | 20 | 100 | 3.0 | 28 | 28 |
| MHCC12050-4R7M-R7 | 4.7 | 20 | 100 | 11.5 | 16 | 11 |
| MHCC12050-6R8M-R7 | 6.8 | 20 | 100 | 22 | 14 | 9 |
| MHCC12050-100M-R7 | 10 | 20 | 100 | 35 | 13 | 7 |

Note: When ordering, please specify tolerance code. Tolerance: M=±20%

- Operating temperature range - 55°C ~ 125°C(Including self - temperature rise)
- Isat for Inductance drop 30% from its value without current
- I rms for a 40°C temperature rise from 25°C ambient with current
- Absolute maximum voltage 30VDC
- Measure Equipment :
 L : WK 3260B or WK 6500P, 100kHz 0.5V
 RDC : CHEN HWA 502 or CHEN HWA 46502B

Test Instruments : WK3260B Impedance / Material Analyzer



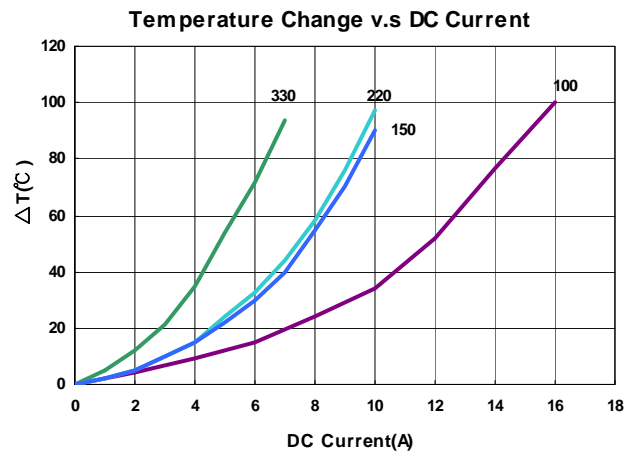
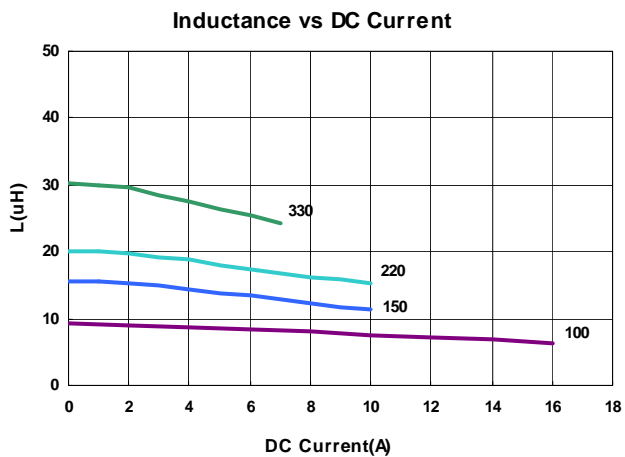
Electrical Characteristics

| Part Number | Inductance (uH) | Tolerance (±%) | Test Frequency (kHz) | RDC (mΩ) Max | Isat (A)Typ. | Irms (A)Typ. |
|--------------------|-----------------|----------------|----------------------|--------------|--------------|--------------|
| MHCC12060-100M-R7A | 10 | 20 | 100 | 20.7 | 12.5 | 10 |
| MHCC12060-150M-R7A | 15 | 20 | 100 | 29.0 | 9.0 | 6.0 |
| MHCC12060-220M-R7A | 22 | 20 | 100 | 39.5 | 7.5 | 5.0 |
| MHCC12060-330M-R7A | 33 | 20 | 100 | 75 | 6.0 | 4.0 |

Note: When ordering, please specify tolerance code. Tolerance: M=±20%

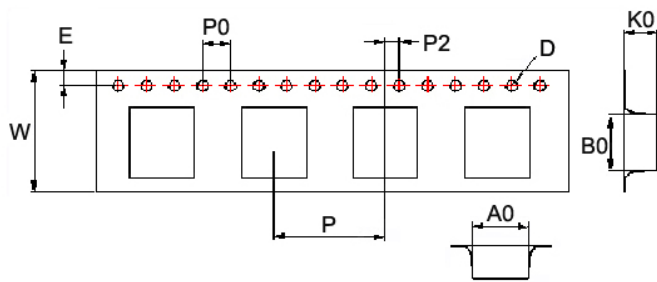
- Operating temperature range - 55°C ~ 125°C(Including self - temperature rise)
- Isat for Inductance drop 30% from its value without current
- I rms for a 40°C temperature rise from 25°C ambient with current
- Absolute maximum voltage 30VDC
- Measure Equipment :
 L : WK 3260B or WK 6500P, 100kHz 0.5V
 RDC : CHEN HWA 502 or CHEN HWA 46502B

Test Instruments : WK3260B Impedance / Material Analyzer

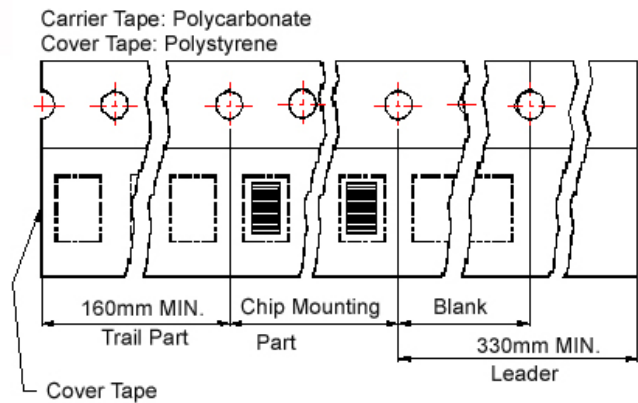


Packaging Specifications

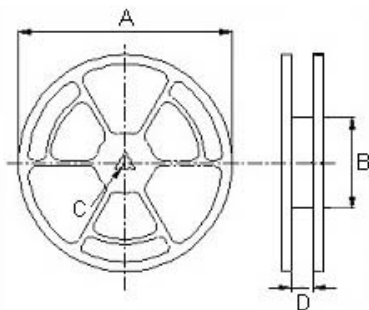
Tape Dimensions



Tape Material



Reel Dimensions



Dimensions in mm

| TYPE | Tape Dimensions | | | | | | | | | Reel Dimensions | | | | Quantity PCS / REEL |
|-------|-----------------|------|------|------|------|----|----|----|----|-----------------|-----|----|------|------------------------|
| | A0 | B0 | K0 | D | E | W | P | P0 | P2 | A | B | C | D | |
| 04012 | 4.6 | 5.0 | 1.5 | 1.55 | 1.75 | 12 | 8 | 4 | 2 | 330 | 100 | 13 | 13.4 | 2000 |
| 04015 | 4.4 | 4.9 | 1.8 | 1.55 | 1.75 | 12 | 8 | 4 | 2 | 330 | 100 | 13 | 13.4 | 2000 |
| 04020 | 4.3 | 4.9 | 2.4 | 1.55 | 1.75 | 12 | 8 | 4 | 2 | 330 | 100 | 13 | 13.4 | 2000 |
| 05012 | 5.9 | 6.2 | 1.5 | 1.55 | 1.75 | 16 | 12 | 4 | 2 | 330 | 100 | 13 | 16.0 | 1000 |
| 05015 | 5.7 | 6.1 | 1.9 | 1.55 | 1.75 | 16 | 12 | 4 | 2 | 330 | 100 | 13 | 16.0 | 1000 |
| 05018 | 5.9 | 6.2 | 2.2 | 1.55 | 1.75 | 16 | 12 | 4 | 2 | 330 | 100 | 13 | 16.0 | 1000 |
| 05020 | 5.7 | 5.9 | 2.4 | 1.55 | 1.75 | 16 | 12 | 4 | 2 | 330 | 100 | 13 | 16.0 | 1000 |
| 05030 | 5.9 | 6.2 | 3.4 | 1.55 | 1.75 | 16 | 12 | 4 | 2 | 330 | 100 | 13 | 16.0 | 1000 |
| 06012 | 6.9 | 7.6 | 1.6 | 1.55 | 1.75 | 16 | 12 | 4 | 2 | 330 | 100 | 13 | 16.0 | 1000 |
| 06015 | 6.9 | 7.6 | 1.9 | 1.55 | 1.75 | 16 | 12 | 4 | 2 | 330 | 100 | 13 | 16.0 | 1000 |
| 06018 | 6.9 | 7.6 | 2.2 | 1.55 | 1.75 | 16 | 12 | 4 | 2 | 330 | 100 | 13 | 16.0 | 1000 |
| 06024 | 6.9 | 7.6 | 2.9 | 1.55 | 1.75 | 16 | 12 | 4 | 2 | 330 | 100 | 13 | 16.0 | 1000 |
| 06030 | 6.9 | 7.6 | 3.4 | 1.55 | 1.75 | 16 | 12 | 4 | 2 | 330 | 100 | 13 | 16.0 | 1000 |
| 06050 | 6.9 | 7.6 | 5.4 | 1.55 | 1.75 | 16 | 12 | 4 | 2 | 330 | 100 | 13 | 16.0 | 1000 |
| 10030 | 10.6 | 11.7 | 3.25 | 1.55 | 1.75 | 24 | 16 | 4 | 2 | 330 | 100 | 13 | 24.4 | 500 |
| 10040 | 10.6 | 11.7 | 4.25 | 1.55 | 1.75 | 24 | 16 | 4 | 2 | 330 | 100 | 13 | 24.4 | 500 |
| 12050 | 13 | 14 | 5.25 | 1.55 | 1.75 | 24 | 16 | 4 | 2 | 330 | 100 | 13 | 24.4 | 500 |
| 12060 | 13 | 14 | 6.25 | 1.55 | 1.75 | 24 | 16 | 4 | 2 | 330 | 100 | 13 | 24.4 | 500 |

MHCB Series



MHCB series is designed for low profile type with low RDC and ultra large current. Its molded magnetic shielded type is suitable for high-density mounting and ultra low buzz noise. Soldering conditions can be easily confirmed when mounting onto the board. This series also provides customers with embossed carrier type packaging for automatic mounting machine.

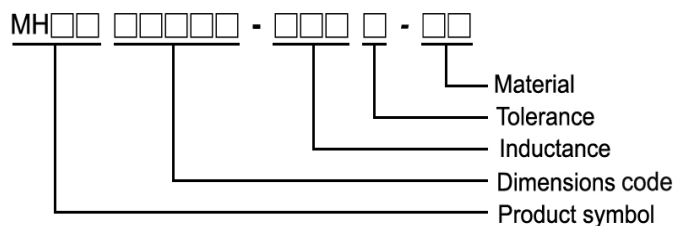
Features

- RoHS, Halogen Free and REACH Compliance
- High rated current
- Ultra low buzz noise

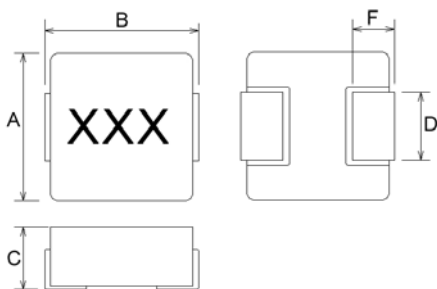
Applications

- Laptops and PCs
- Switches and servers
- Base stations
- DC/DC converters

Product Identification



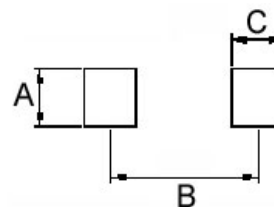
Shape and Dimensions



Dimensions in mm

| TYPE | A | B | C | D | F |
|-------|---------|-----------|---------|---------|---------|
| 06030 | 6.6±0.2 | 6.95±0.35 | 2.8±0.2 | 3.0±0.3 | 1.6±0.5 |

Recommended Pattern



Dimensions in mm

| TYPE | A | B | C |
|-------|-----|------|------|
| 06030 | 3.5 | 6.05 | 2.35 |

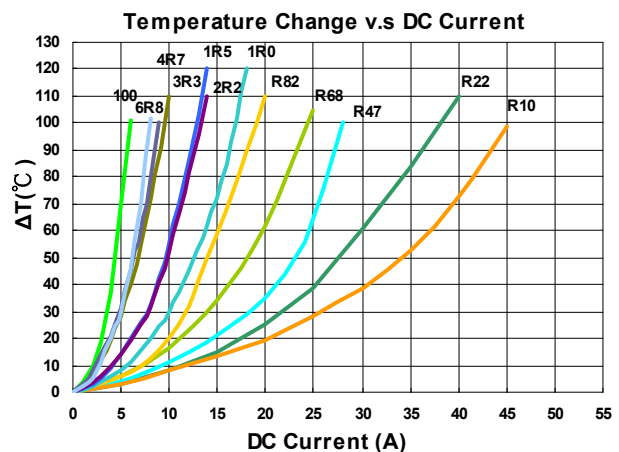
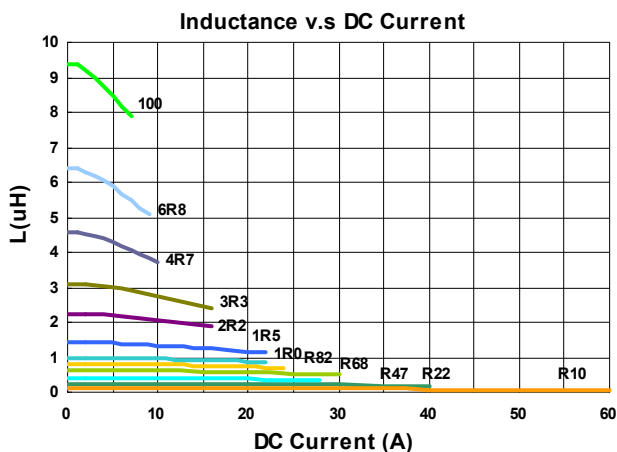
Electrical Characteristics

| Part Number | Inductance (uH) | Tolerance (±%) | Test Frequency (kHz) | RDC (mΩ) Max | Isat (A)Typ. | Irms (A)Typ. |
|-------------------|-----------------|----------------|----------------------|--------------|--------------|--------------|
| MHCB06030-R10M-C1 | 0.10 | 20 | 100 | 1.7 | 60 | 32.5 |
| MHCB06030-R22M-C1 | 0.22 | 20 | 100 | 2.8 | 40 | 23.0 |
| MHCB06030-R33M-C1 | 0.33 | 20 | 100 | 3.9 | 30 | 20.0 |
| MHCB06030-R47M-C1 | 0.47 | 20 | 100 | 4.2 | 26 | 17.5 |
| MHCB06030-R68M-C1 | 0.68 | 20 | 100 | 5.5 | 25 | 15.5 |
| MHCB06030-R82M-C1 | 0.82 | 20 | 100 | 8.0 | 24 | 13.0 |
| MHCB06030-1R0M-C1 | 1.0 | 20 | 100 | 10 | 22 | 11.0 |
| MHCB06030-1R5M-C1 | 1.5 | 20 | 100 | 15 | 18 | 9.0 |
| MHCB06030-2R2M-C1 | 2.2 | 20 | 100 | 20 | 14 | 8.0 |
| MHCB06030-3R3M-C1 | 3.3 | 20 | 100 | 30 | 13.5 | 6.0 |
| MHCB06030-4R7M-C1 | 4.7 | 20 | 100 | 40 | 10.0 | 5.5 |
| MHCB06030-6R8M-C1 | 6.8 | 20 | 100 | 60 | 8.0 | 4.5 |
| MHCB06030-100M-C1 | 10 | 20 | 100 | 102 | 7.0 | 3.0 |

Note: When ordering, please specify tolerance code. Tolerance: M=±20%

- Operating temperature range - 55°C ~ 125°C(Including self - temperature rise)
- Isat for Inductance drop 20% from its value without current
- I rms for a 40°C temperature rise from 25°C ambient with current
- Absolute maximum voltage 30VDC
- Measure Equipment :
 L : WK 3260B or WK 6500P, 100KHz 0.5V
 RDC : CHEN HWA 502 or CHEN HWA 46502B
 I rms : CHROMA 1810

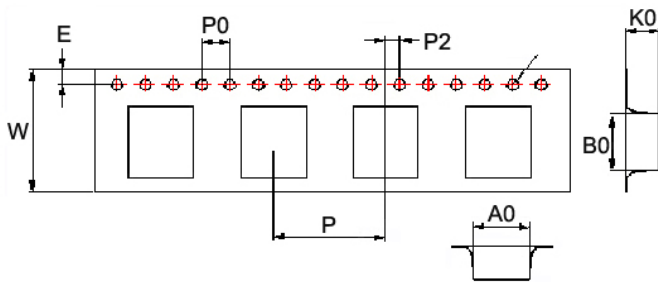
Test Instruments : WK3260B Impedance / Material Analyzer



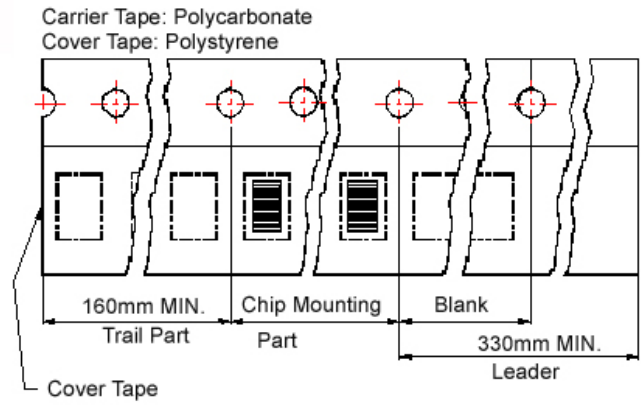
Please be sure to request approval specifications that provide further details of the products. Kindly note that the content of these specifications are subject to change or may be discontinued without advance notice. Please contact our sales department before ordering.

Packaging Specifications

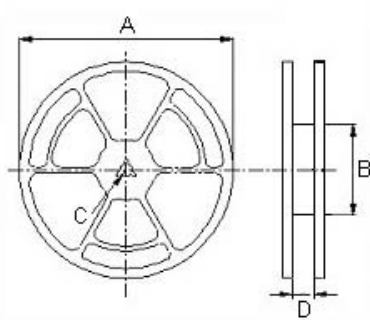
Tape Dimensions



Tape Material



Reel Dimensions



Dimensions in mm

| TYPE | Tape Dimensions | | | | | | | | | Reel Dimensions | | | | Quantity PCS / REEL |
|-------|-----------------|-----|-----|------|------|----|----|----|----|-----------------|-----|----|------|------------------------|
| | A0 | B0 | K0 | D | E | W | P | P0 | P2 | A | B | C | D | |
| 06030 | 6.9 | 7.6 | 3.4 | 1.55 | 1.75 | 16 | 12 | 4 | 2 | 330 | 100 | 13 | 16.0 | 1000 |

MRSC Series



MRSC series, metal alloy wire wound power inductor, its rated current could be increased up to 35% compare to ferrite base power inductor.

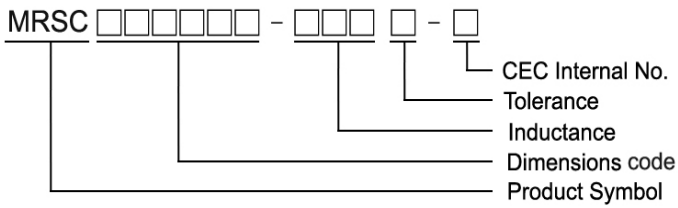
Features

- RoHS, Halogen Free and REACH Compliance
- Constructure Low RDC and high rated current.
- Wide inductance range
- Shielded and miniature package design

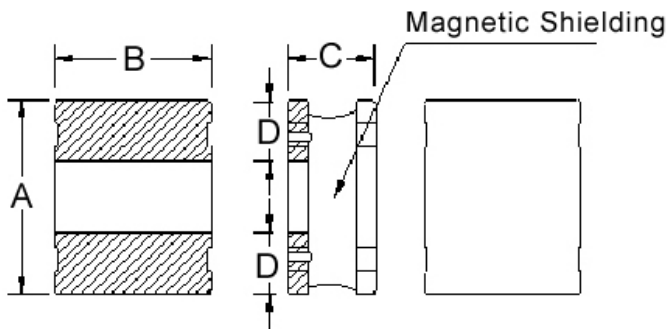
Applications

- Smartphones, tablets and wearable devices
- DSC, camcorders
- DC/DC converters

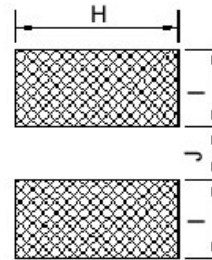
Product Identification



Shape and Dimensions



Recommended Pattern



Dimensions in mm

| TYPE | A | B | C | D | H | I | J |
|------------|---------|---------|---------|------|-----|-----|-----|
| MRSC201B10 | 2.0±0.2 | 1.6±0.2 | 1.0 Max | 0.65 | 1.7 | 0.7 | 0.7 |
| MRSC201B12 | 2.0±0.2 | 1.6±0.2 | 1.2 Max | 0.50 | 1.7 | 0.6 | 0.9 |
| MRSC252A10 | 2.5±0.2 | 2.0±0.2 | 1.0 Max | 0.85 | 2.1 | 0.9 | 0.8 |
| MRSC252A12 | 2.5±0.2 | 2.0±0.2 | 1.2 Max | 0.85 | 2.1 | 0.9 | 0.8 |

Electrical Characteristics

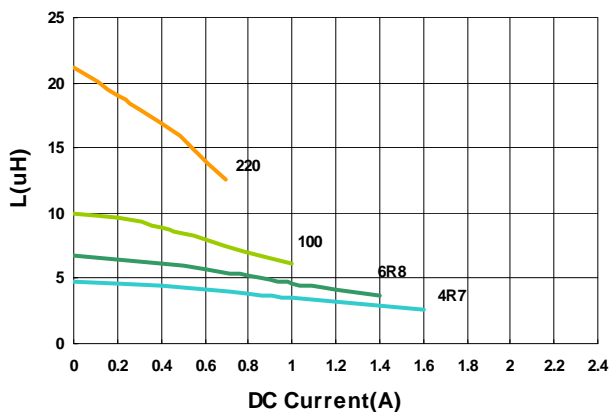
| Part Number | Inductance (uH) | Test Frequency (MHz) | Tolerance (±%) | SRF (MHz) Min | RDC(mΩ) (Max) Typ | Isat (A) (Max) Typ | Irms (A) (Max) Typ |
|-------------------|-----------------|----------------------|----------------|---------------|-------------------|--------------------|--------------------|
| MRSC201B10-4R7□-N | 4.7 | 1 | 20, 30 | 25 | 370(308) | 1.00(1.20) | 0.86(0.96) |
| MRSC201B10-6R8□-N | 6.8 | 1 | 20, 30 | 19 | 526(438) | 0.86(0.96) | 0.73(0.82) |
| MRSC201B10-100□-N | 10 | 1 | 20, 30 | 15 | 768(640) | 0.70(0.78) | 0.64(0.72) |
| MRSC201B10-220□-N | 22 | 1 | 20, 30 | 9 | 1560(1300) | 0.49(0.55) | 0.40(0.45) |

Note: When ordering, please specify tolerance code. Tolerance: M=±20% , T =±30%

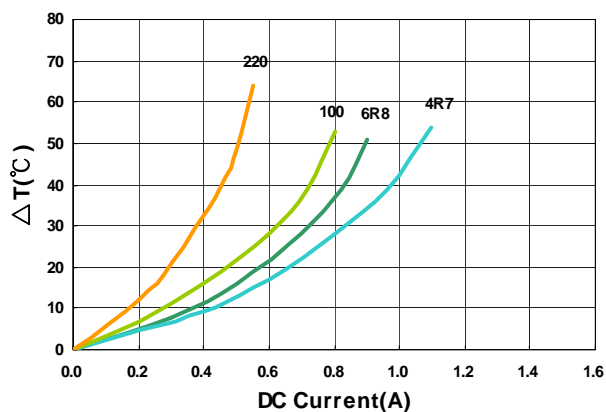
- Operating temperature range - 40°C ~ 125°C(Including self - temperature rise)
- Isat for Inductance drop 30% from its value without current
- I rms for a 40°C temperature rise from 25°C ambient with current
- Measure Equipment :
- L : Agilent 4285A+Agilent 42841A, or equivalent,1MHz 200mV
- RDC : DIGITAL MILLINHM METER CHROMA 16502, or equivalent
- Isat & I rms : Agilent/HP4285A+Agilent 42841A
- SRF : HP4294A+16092A

Test Instruments : HP4285A Material/Impedance Analyzer

Inductance vs. DC Current



Temperature Change vs. DC Current



Please be sure to request approval specifications that provide further details of the products. Kindly note that the content of these specifications are subject to change or may be discontinued without advance notice. Please contact our sales department before ordering.

Electrical Characteristics

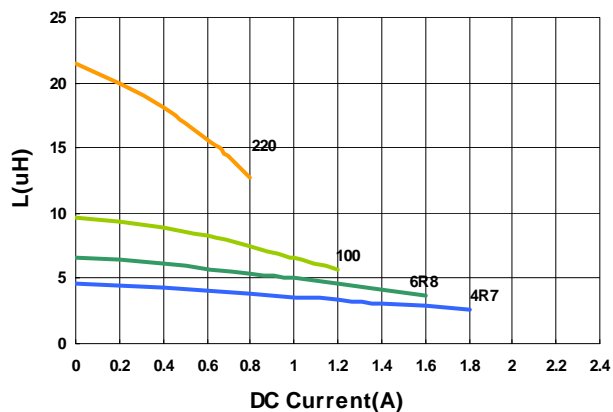
| Part Number | Inductance (uH) | Test Frequency (MHz) | Tolerance (±%) | SRF (MHz) Min | RDC(mΩ) (Max) Typ | Isat (A) (Max) Typ | Irms (A) (Max) Typ |
|-------------------|-----------------|----------------------|----------------|---------------|-------------------|--------------------|--------------------|
| MRSC201B12-4R7□-N | 4.7 | 1 | 20, 30 | 26 | 324(270) | 1.20(1.40) | 1.00(1.20) |
| MRSC201B12-6R8□-N | 6.8 | 1 | 20, 30 | 20 | 456(380) | 1.00(1.20) | 0.78(0.92) |
| MRSC201B12-100□-N | 10 | 1 | 20, 30 | 16 | 720(600) | 0.85(0.95) | 0.65(0.73) |
| MRSC201B12-220□-N | 22 | 1 | 20, 30 | 10 | 1500(1250) | 0.57(0.64) | 0.41(0.46) |

Note: When ordering, please specify tolerance code. Tolerance: M=±20% , T =±30%

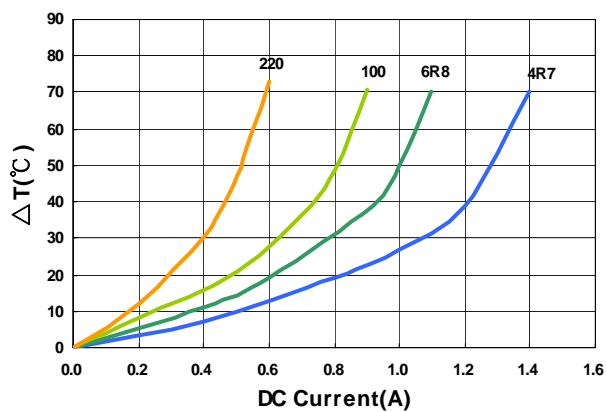
- Operating temperature range - 40°C ~ 125°C(Including self - temperature rise)
- Isat for Inductance drop 30% from its value without current
- I rms for a 40°C temperature rise from 25°C ambient with current
- Measure Equipment :
- L : Agilent 4285A+Agilent 42841A, or equivalent,1MHz 200mV
- RDC : DIGITAL MILLINHM METER CHROMA 16502, or equivalent
- Isat & I rms : Agilent/HP4285A+Agilent 42841A
- SRF : HP4294A+16092A

Test Instruments : HP4285A Material/Impedance Analyzer

Inductance vs. DC Current



Temperature Change vs. DC Current



Please be sure to request approval specifications that provide further details of the products. Kindly note that the content of these specifications are subject to change or may be discontinued without advance notice. Please contact our sales department before ordering.

Electrical Characteristics

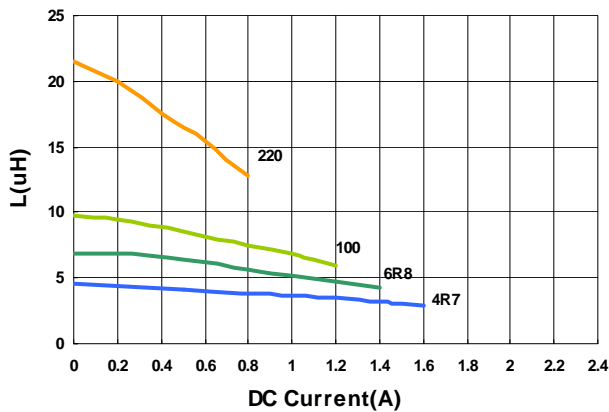
| Part Number | Inductance (uH) | Test Frequency (MHz) | Tolerance (±%) | SRF (MHz) Min | RDC(mΩ) (Max) Typ | Isat (A) (Max) Typ | Irms (A) (Max) Typ |
|-------------------|-----------------|----------------------|----------------|---------------|-------------------|--------------------|--------------------|
| MRSC252A10-4R7□-N | 4.7 | 1 | 20, 30 | 19 | 264(220) | 1.30(1.40) | 1.10(1.20) |
| MRSC252A10-6R8□-N | 6.8 | 1 | 20, 30 | 15 | 396(330) | 1.00(1.10) | 0.90(1.00) |
| MRSC252A10-100□-N | 10 | 1 | 20, 30 | 12 | 500(435) | 0.90(1.00) | 0.80(0.90) |
| MRSC252A10-220□-N | 22 | 1 | 20, 30 | 8 | 1260(1050) | 0.56(0.63) | 0.45(0.50) |

Note: When ordering, please specify tolerance code. Tolerance: M=±20% , T =±30%

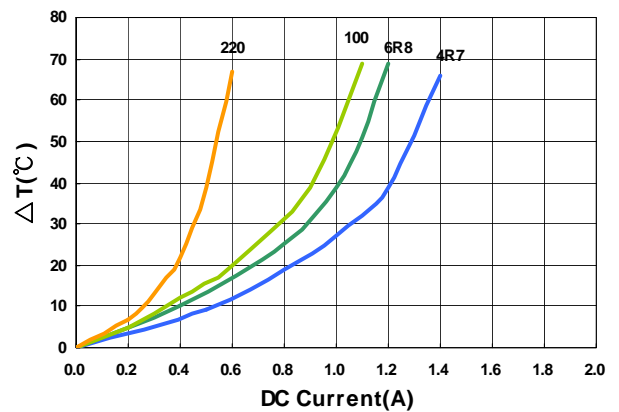
- Operating temperature range - 40°C ~ 125°C(Including self - temperature rise)
- Isat for Inductance drop 30% from its value without current
- I rms for a 40°C temperature rise from 25°C ambient with current
- Measure Equipment :
- L : Agilent 4285A+Agilent 42841A, or equivalent,1MHz 200mV
- RDC : DIGITAL MILLINHM METER CHROMA 16502, or equivalent
- Isat & I rms : Agilent/HP4285A+Agilent 42841A
- SRF : HP4294A+16092A

Test Instruments : HP4285A Material/Impedance Analyzer

Inductance vs. DC Current



Temperature Change vs. DC Current



Electrical Characteristics

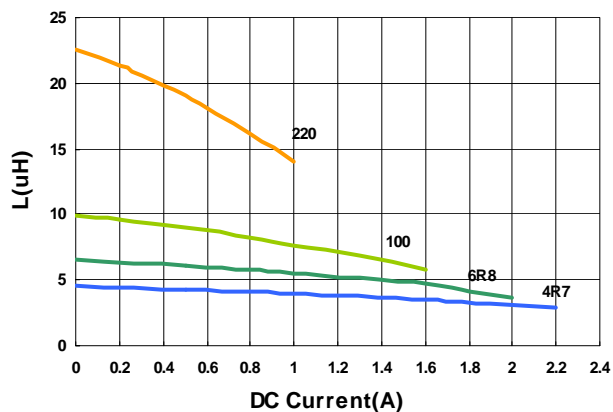
| Part Number | Inductance (uH) | Test Frequency (MHz) | Tolerance (±%) | SRF (MHz) Min | RDC(mΩ) (Max) Typ | Isat (A) (Max) Typ | Irms (A) (Max) Typ |
|-------------------|-----------------|----------------------|----------------|---------------|-------------------|--------------------|--------------------|
| MRSC252A12-4R7□-N | 4.7 | 1 | 20, 30 | 23 | 240(200) | 1.70(1.90) | 1.30(1.50) |
| MRSC252A12-6R8□-N | 6.8 | 1 | 20, 30 | 16 | 345(285) | 1.30(1.60) | 1.00(1.20) |
| MRSC252A12-100□-N | 10 | 1 | 20, 30 | 14 | 480(400) | 1.00(1.30) | 0.85(1.00) |
| MRSC252A12-220□-N | 22 | 1 | 20, 30 | 8 | 1090(910) | 0.74(0.83) | 0.54(0.60) |

Note: When ordering, please specify tolerance code. Tolerance: M=±20% , T =±30%

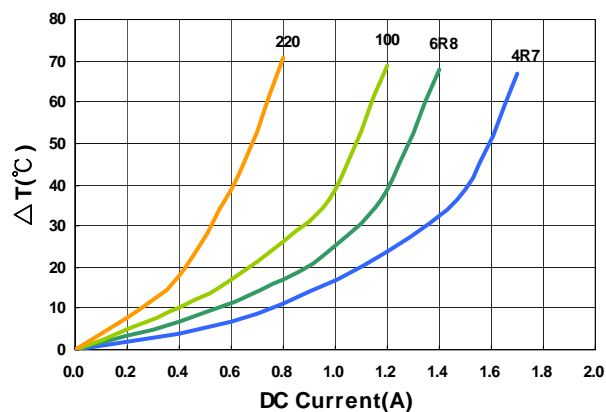
- Operating temperature range - 40°C ~ 125°C(Including self - temperature rise)
- Isat for Inductance drop 30% from its value without current
- I rms for a 40°C temperature rise from 25°C ambient with current
- Measure Equipment :
- L : Agilent 4285A+Agilent 42841A, or equivalent,1MHz 200mV
- RDC : DIGITAL MILLINHM METER CHROMA 16502, or equivalent
- Isat & I rms : Agilent/HP4285A+Agilent 42841A
- SRF : HP4294A+16092A

Test Instruments : HP4285A Material/Impedance Analyzer

Inductance vs. DC Current

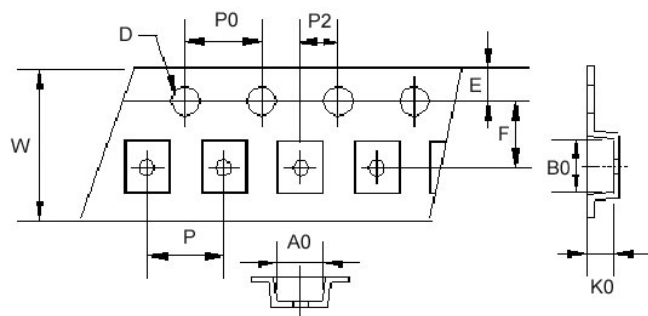


Temperature Change vs. DC Current

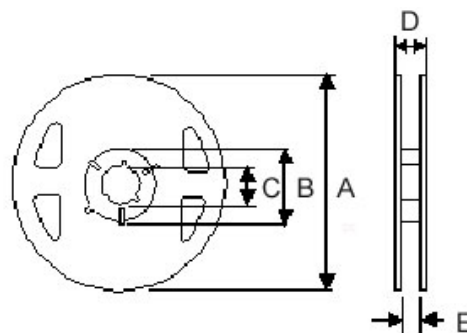


Packaging Specifications

Tape Dimensions



Reel Dimensions



Dimensions in mm

| TYPE | Tape Dimensions | | | | | | | | | | Reel Dimensions | | | | | Quantity PCS / Reel |
|------------|-----------------|------|------|------|------|-----|---|---|----|----|-----------------|----|----|------|-----|------------------------|
| | A0 | B0 | K0 | D | E | F | W | P | P0 | P2 | A | B | C | D | E | |
| MRSC201B10 | 1.90 | 2.20 | 1.15 | 1.55 | 1.75 | 3.5 | 8 | 4 | 4 | 2 | 180 | 60 | 13 | 14.4 | 8.4 | 2000 |
| MRSC201B12 | 1.95 | 2.20 | 1.35 | 1.55 | 1.75 | 3.5 | 8 | 4 | 4 | 2 | 180 | 60 | 13 | 14.4 | 8.4 | 2000 |
| MRSC252A10 | 2.35 | 2.80 | 1.15 | 1.55 | 1.75 | 3.5 | 8 | 4 | 4 | 2 | 180 | 60 | 13 | 14.4 | 8.4 | 2000 |
| MRSC252A12 | 2.35 | 2.80 | 1.35 | 1.55 | 1.75 | 3.5 | 8 | 4 | 4 | 2 | 180 | 60 | 13 | 14.4 | 8.4 | 2000 |

LVS Series



LVS series, an automatic assembly constructed power inductor, is shielded with magnetic resin and suitable for the portable DC-DC converter applications.

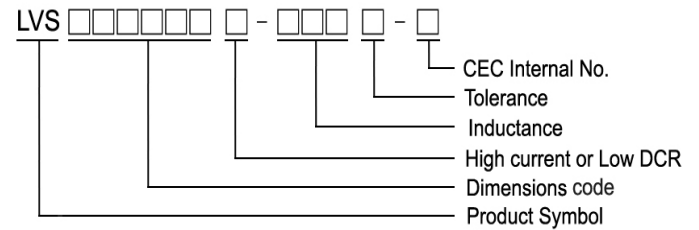
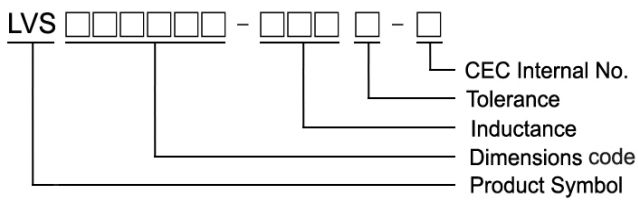
Features

- RoHS, Halogen Free and REACH Compliance
- Shielded with magnetic resin
- Various package size and wide inductance range
- Optimize electrical characteristics by using different ferrite core figures

Applications

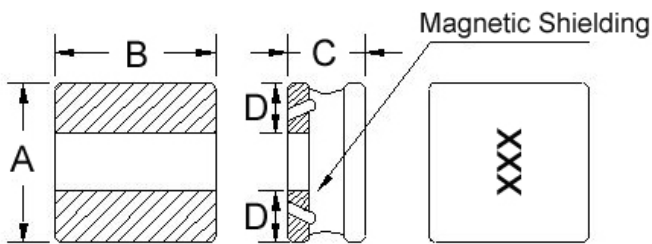
- AP Routers
- STBs
- LCD TVs, monitors and panels
- Game consoles
- DC/DC converters

Product Identification

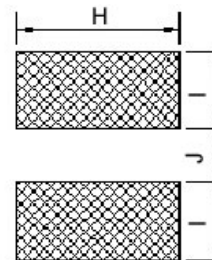


Shape and Dimensions

Figure 1



Recommended Pattern



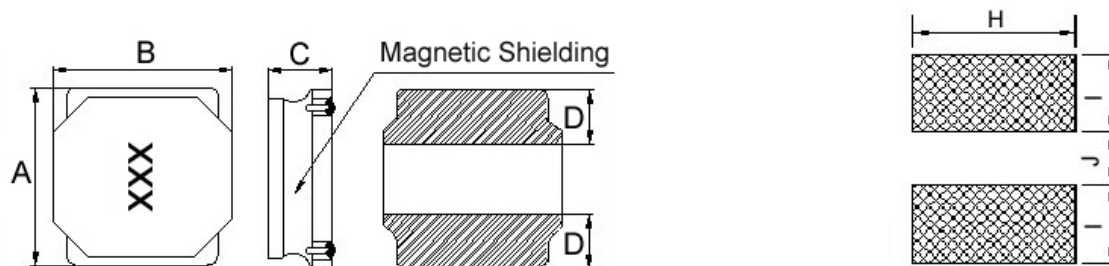
Dimensions in mm

| TYPE | FIG | A | B | C | D | H | I | J |
|-----------|-----|---------|---------|----------|-----|-----|-----|-----|
| LVS404012 | 1 | 4.0±0.2 | 4.0±0.2 | 1.20±0.1 | 1.5 | 4.2 | 1.5 | 1.2 |

Shape and Dimensions

Recommended Pattern

Figure 2



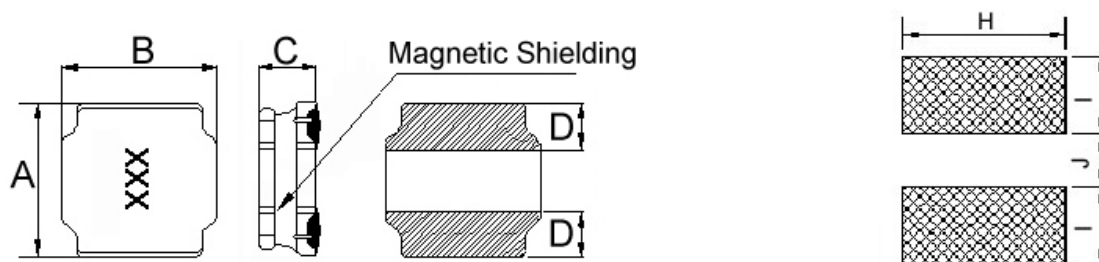
Dimensions in mm

| TYPE | FIG | A | B | C | D | H | I | J |
|-----------|-----|---------|---------|--------------------------------------|---------|-----|-----|-----|
| LVS404018 | 2 | 4.0±0.2 | 4.0±0.2 | 1.8 ^{+0.2} _{-0.30} | 1.3±0.3 | 3.7 | 1.2 | 1.6 |
| LVS404026 | 2 | 4.0±0.2 | 4.0±0.2 | 2.6±0.2 | 1.4 | 3.7 | 1.2 | 1.6 |

Shape and Dimensions

Recommended Pattern

Figure 3



Dimensions in mm

| TYPE | FIG | A | B | C | D | H | I | J |
|------------|-----|---------|---------|--------------------------------------|---------|-----|-----|-----|
| LVS505020 | 3 | 5.0±0.2 | 5.0±0.2 | 2.0 ^{+0.2} _{-0.30} | 1.8±0.3 | 4.0 | 1.5 | 2.1 |
| LVS505040 | 3 | 5.0±0.2 | 5.0±0.2 | 4.0 ^{+0.2} _{-0.30} | 1.6±0.3 | 4.0 | 1.5 | 2.1 |
| LVS606020 | 3 | 6.0±0.2 | 6.0±0.2 | 2.0 ^{+0.2} _{-0.30} | 1.7±0.3 | 5.7 | 1.6 | 2.9 |
| LVS606028 | 3 | 6.0±0.2 | 6.0±0.2 | 2.8 ^{+0.2} _{-0.30} | 1.9±0.3 | 5.7 | 1.6 | 2.9 |
| LVS606045 | 3 | 6.0±0.2 | 6.0±0.2 | 4.5 ^{+0.2} _{-0.30} | 1.8±0.3 | 5.7 | 2.0 | 2.4 |
| LVS606045L | 3 | 6.0±0.2 | 6.0±0.2 | 4.5 ^{+0.2} _{-0.30} | 1.8±0.3 | 5.7 | 2.0 | 2.4 |
| LVS808040 | 3 | 8.0±0.2 | 8.0±0.2 | 4.0 ^{+0.2} _{-0.30} | 2.3±0.3 | 7.5 | 2.5 | 3.4 |
| LVS808040L | 3 | 8.0±0.2 | 8.0±0.2 | 4.0 ^{+0.2} _{-0.30} | 2.3±0.3 | 7.5 | 2.5 | 3.4 |

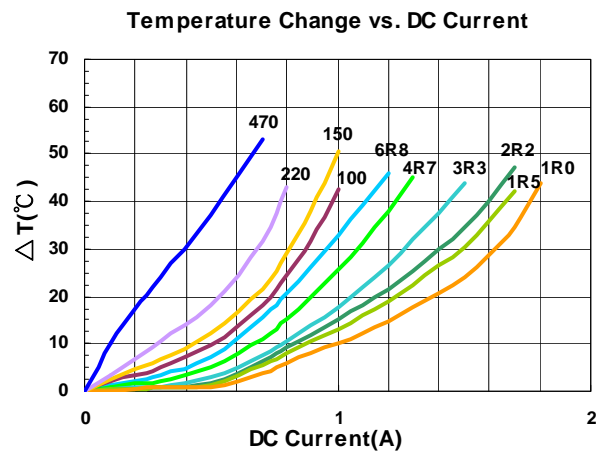
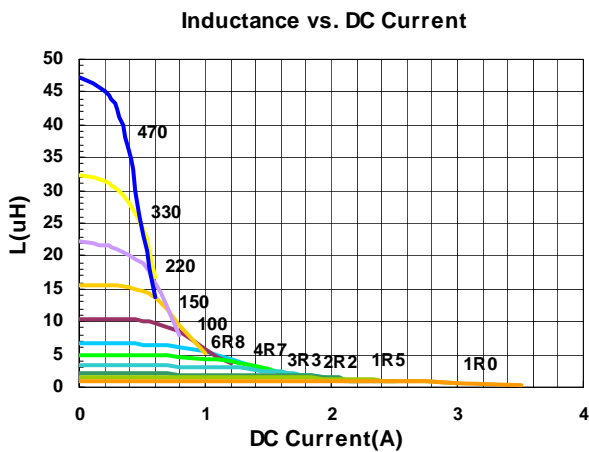
Electrical Characteristics

| Part Number | Inductance (uH) | Tolerance (±%) | Test Frequency (kHz) | RDC (mΩ) ±30% | Isat (A) Typ. (Max) | Irms (A) Typ. (Max) | Marking |
|------------------|-----------------|----------------|----------------------|---------------|---------------------|---------------------|---------|
| LVS404012-1R0□-N | 1.0 | 20, 30 | 100 | 48 | 2.50(2.25) | 1.70(1.53) | 1R0 |
| LVS404012-1R5□-N | 1.5 | 20, 30 | 100 | 58 | 2.10(1.89) | 1.60(1.44) | 1R5 |
| LVS404012-2R2□-N | 2.2 | 20, 30 | 100 | 65 | 1.70(1.53) | 1.50(1.35) | 2R2 |
| LVS404012-3R3□-N | 3.3 | 20, 30 | 100 | 90 | 1.30(1.17) | 1.40(1.26) | 3R3 |
| LVS404012-4R7□-N | 4.7 | 20, 30 | 100 | 110 | 1.10(0.99) | 1.20(1.08) | 4R7 |
| LVS404012-6R8□-N | 6.8 | 20, 30 | 100 | 135 | 0.90(0.81) | 1.05(0.94) | 6R8 |
| LVS404012-100□-N | 10 | 20, 30 | 100 | 190 | 0.78(0.70) | 0.90(0.81) | 100 |
| LVS404012-150□-N | 15 | 20, 30 | 100 | 250 | 0.65(0.58) | 0.85(0.76) | 150 |
| LVS404012-220□-N | 22 | 20, 30 | 100 | 400 | 0.52(0.46) | 0.75(0.67) | 220 |
| LVS404012-330□-N | 33 | 20, 30 | 100 | 600 | 0.44(0.39) | 0.70(0.63) | 330 |
| LVS404012-470□-N | 47 | 20, 30 | 100 | 930 | 0.35(0.31) | 0.50(0.45) | 470 |

Note: When ordering, please specify tolerance code. Tolerance: M=±20% , T =±30%

- Operating temperature range - 55°C ~ 125°C(Including self - temperature rise)
- Isat for Inductance drop 30% from its value without current
- I rms for a 40°C temperature rise from 25°C ambient with current
- Measure Equipment :
 L : Agilent HP4284A+Agilent HP42841A, 100kHz 1V
 RDC : DIGITAL MILLINHM METER CHROMA 16502, or equivalent
 Isat & I rms : Agilent HP4284A

Test Instruments : HP4284A Material/Impedance Analyzer



Please be sure to request approval specifications that provide further details of the products. Kindly note that the content of these specifications are subject to change or may be discontinued without advance notice. Please contact our sales department before ordering.

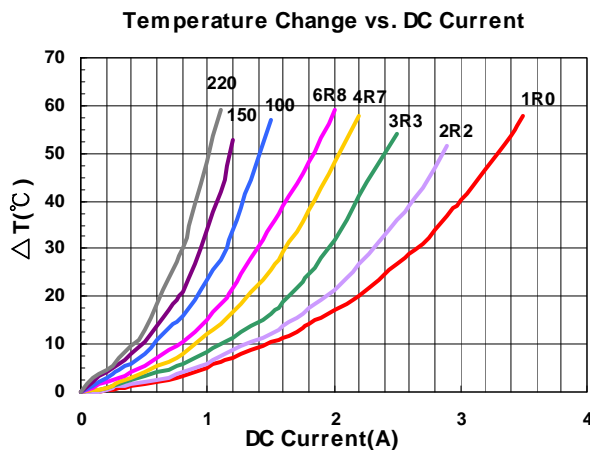
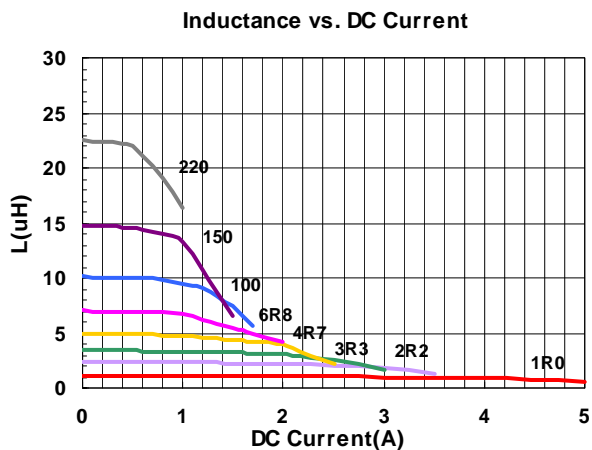
Electrical Characteristics

| Part Number | Inductance (uH) | Tolerance (±%) | Test Frequency (kHz) | RDC (mΩ) ±20% | Isat (A) Typ. (Max) | Irms (A) Typ. (Max) | Marking |
|------------------|-----------------|----------------|----------------------|---------------|---------------------|---------------------|---------|
| LVS404018-1R0□-N | 1.0 | 20, 30 | 100 | 32 | 4.10(3.69) | 2.80(2.52) | 1R0 |
| LVS404018-1R5□-N | 1.5 | 20, 30 | 100 | 40 | 3.30(2.97) | 2.60(2.34) | 1R5 |
| LVS404018-1R8□-N | 1.8 | 20, 30 | 100 | 55 | 2.80(2.50) | 2.50(2.20) | 1R8 |
| LVS404018-2R2□-N | 2.2 | 20, 30 | 100 | 60 | 2.80(2.52) | 2.50(2.25) | 2R2 |
| LVS404018-3R3□-N | 3.3 | 20, 30 | 100 | 70 | 2.20(1.98) | 2.10(1.89) | 3R3 |
| LVS404018-3R6□-N | 3.6 | 20, 30 | 100 | 75 | 2.10(1.89) | 1.90(1.71) | 3R6 |
| LVS404018-3R9□-N | 3.9 | 20, 30 | 100 | 75 | 2.10(1.89) | 1.90(1.71) | 3R9 |
| LVS404018-4R7□-N | 4.7 | 20, 30 | 100 | 90 | 2.00(1.80) | 1.70(1.53) | 4R7 |
| LVS404018-6R8□-N | 6.8 | 20, 30 | 100 | 110 | 1.60(1.44) | 1.50(1.35) | 6R8 |
| LVS404018-8R2□-N | 8.2 | 20, 30 | 100 | 155 | 1.50(1.30) | 1.30(1.10) | 8R2 |
| LVS404018-100□-N | 10 | 20, 30 | 100 | 170 | 1.40(1.26) | 1.20(1.08) | 100 |
| LVS404018-150□-N | 15 | 20, 30 | 100 | 250 | 1.00(0.90) | 1.00(0.90) | 150 |
| LVS404018-220□-N | 22 | 20, 30 | 100 | 350 | 0.90(0.81) | 0.85(0.76) | 220 |
| LVS404018-330□-N | 33 | 20, 30 | 100 | 530 | 0.80(0.72) | 0.70(0.63) | 330 |
| LVS404018-470□-N | 47 | 20, 30 | 100 | 720 | 0.70(0.63) | 0.56(0.50) | 470 |
| LVS404018-680□-N | 68 | 20, 30 | 100 | 1000 | 0.56(0.50) | 0.45(0.40) | 680 |
| LVS404018-101□-N | 100 | 20, 30 | 100 | 1500 | 0.46(0.41) | 0.38(0.34) | 101 |
| LVS404018-151□-N | 150 | 20, 30 | 100 | 2500 | 0.35(0.31) | 0.30(0.27) | 151 |
| LVS404018-221□-N | 220 | 20, 30 | 100 | 4000 | 0.28(0.25) | 0.23(0.20) | 221 |

Note: When ordering, please specify tolerance code. Tolerance: M=±20%, T=±30%

- Operating temperature range - 55°C ~ 125°C(Including self - temperature rise)
- Isat for Inductance drop 30% from its value without current
- Irms for a 40°C temperature rise from 25°C ambient with current
- Measure Equipment :
 L : Agilent HP4284A+Agilent HP42841A, 100kHz 1V
 RDC : DIGITAL MILLINHM METER CHROMA 16502, or equivalent
 Isat & Irms : Agilent HP4284A

Test Instruments : HP4284A Material/Impedance Analyzer



Please be sure to request approval specifications that provide further details of the products. Kindly note that the content of these specifications are subject to change or may be discontinued without advance notice. Please contact our sales department before ordering.

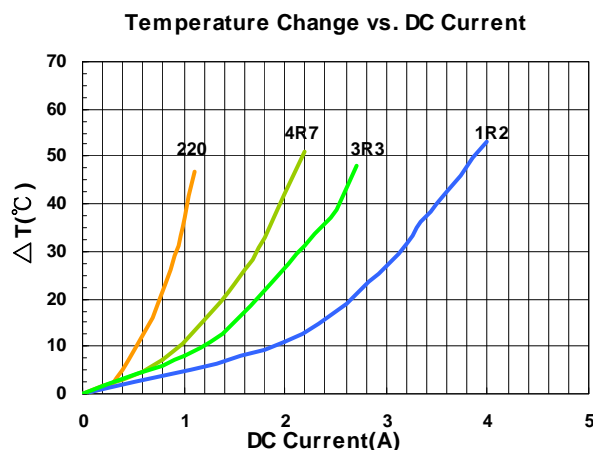
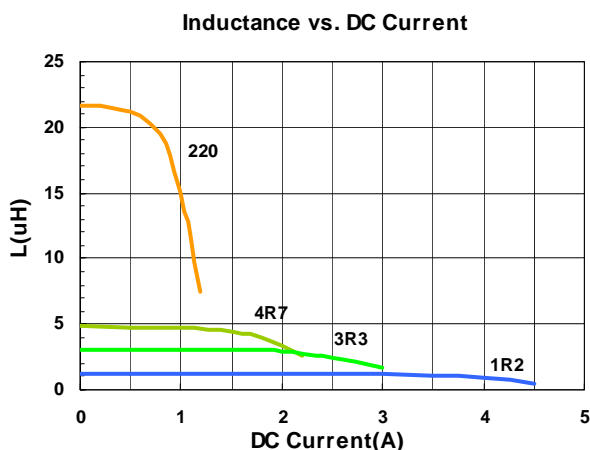
Electrical Characteristics

| Part Number | Inductance (uH) | Tolerance (±%) | Test Frequency (kHz) | RDC (mΩ) ±30% | Isat (A) Typ. (Max) | Irms (A) Typ. (Max) | Marking |
|------------------|-----------------|----------------|----------------------|---------------|---------------------|---------------------|---------|
| LVS404026-1R2□-N | 1.2 | 20, 30 | 100 | 30 | 3.50(3.15) | 3.30(2.97) | 1R2 |
| LVS404026-3R3□-N | 3.3 | 20, 30 | 100 | 45 | 2.50(2.25) | 2.50(2.25) | 3R3 |
| LVS404026-4R7□-N | 4.7 | 20, 30 | 100 | 60 | 1.80(1.62) | 1.80(1.62) | 4R7 |
| LVS404026-220□-N | 22 | 20, 30 | 100 | 230 | 0.86(0.77) | 1.00(0.90) | 220 |

Note: When ordering, please specify tolerance code. Tolerance: M=±20% , T =±30%

- Operating temperature range - 55°C ~ 125°C(Including self - temperature rise)
- Isat for Inductance drop 30% from its value without current
- I rms for a 40°C temperature rise from 25°C ambient with current
- Measure Equipment :
 L : Agilent HP4284A+Agilent HP42841A, 100kHz 1V
 RDC : DIGITAL MILLINHM METER CHROMA 16502, or equivalent
 Isat & I rms : Agilent HP4284A

Test Instruments : HP4284A Material/Impedance Analyzer



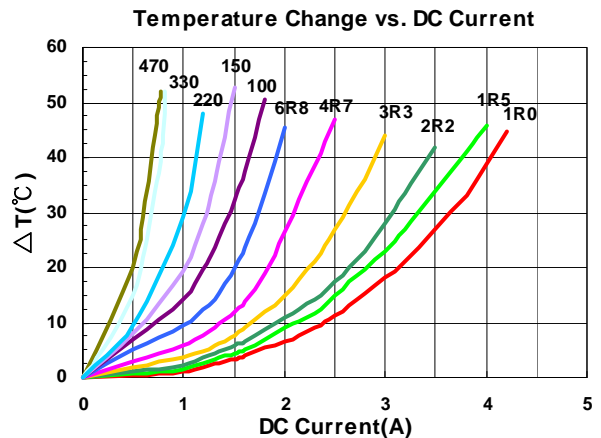
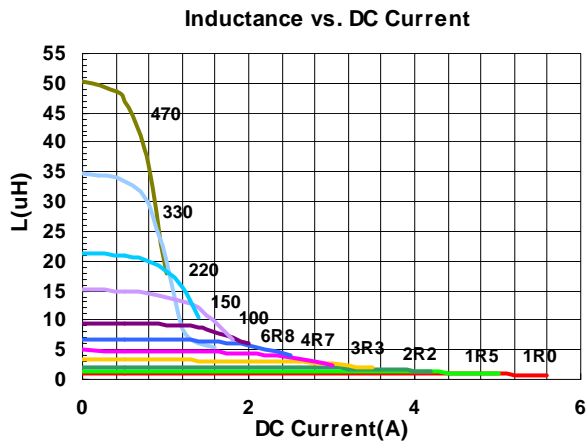
Electrical Characteristics

| Part Number | Inductance (uH) | Tolerance (±%) | Test Frequency (kHz) | RDC (mΩ) ±20% | Isat (A) Typ. (Max) | Irms (A) Typ. (Max) | Marking |
|------------------|-----------------|----------------|----------------------|---------------|---------------------|---------------------|---------|
| LVS505020-1R0□-N | 1.0 | 20, 30 | 100 | 21 | 5.1(4.59) | 4.0(3.60) | 1R0 |
| LVS505020-1R2□-N | 1.2 | 30 | 100 | 21 | 4.8(4.32) | 3.8(3.42) | 1R2 |
| LVS505020-1R5□-N | 1.5 | 20, 30 | 100 | 26 | 4.2(3.78) | 3.5(3.15) | 1R5 |
| LVS505020-2R2□-N | 2.2 | 20, 30 | 100 | 35 | 3.4(3.06) | 3.2(2.88) | 2R2 |
| LVS505020-2R7□-N | 2.7 | 20, 30 | 100 | 38 | 3.05(2.7) | 2.9(2.60) | 2R7 |
| LVS505020-3R3□-N | 3.3 | 20, 30 | 100 | 48 | 3.0(2.70) | 2.8(2.52) | 3R3 |
| LVS505020-4R7□-N | 4.7 | 20, 30 | 100 | 60 | 2.2(1.98) | 2.2(1.98) | 4R7 |
| LVS505020-5R6□-N | 5.6 | 20, 30 | 100 | 82 | 2.05(1.84) | 2.0(1.80) | 5R6 |
| LVS505020-6R8□-N | 6.8 | 20, 30 | 100 | 90 | 2.0(1.80) | 1.8(1.62) | 6R8 |
| LVS505020-100□-N | 10 | 20, 30 | 100 | 120 | 1.6(1.44) | 1.6(1.44) | 100 |
| LVS505020-150□-N | 15 | 20, 30 | 100 | 190 | 1.3(1.17) | 1.2(1.08) | 150 |
| LVS505020-220□-N | 22 | 20, 30 | 100 | 260 | 1.0(0.90) | 1.0(0.90) | 220 |
| LVS505020-330□-N | 33 | 20, 30 | 100 | 460 | 0.8(0.72) | 0.75(0.67) | 330 |
| LVS505020-470□-N | 47 | 20, 30 | 100 | 580 | 0.65(0.58) | 0.65(0.58) | 470 |

Note: When ordering, please specify tolerance code. Tolerance: M=±20% , T =±30%

- Operating temperature range - 55°C ~ 125°C(Including self - temperature rise)
- Isat for Inductance drop 30% from its value without current
- I rms for a 40°C temperature rise from 25°C ambient with current
- Measure Equipment :
 L : Agilent HP4284A+Agilent HP42841A, 100kHz 1V
 RDC : DIGITAL MILLINHM METER CHROMA 16502, or equivalent
 Isat & I rms : Agilent HP4284A

Test Instruments : HP4284A Material/Impedance Analyzer



Please be sure to request approval specifications that provide further details of the products. Kindly note that the content of these specifications are subject to change or may be discontinued without advance notice. Please contact our sales department before ordering.

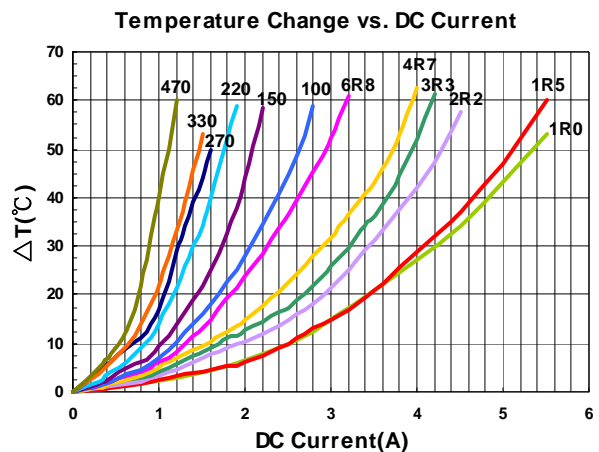
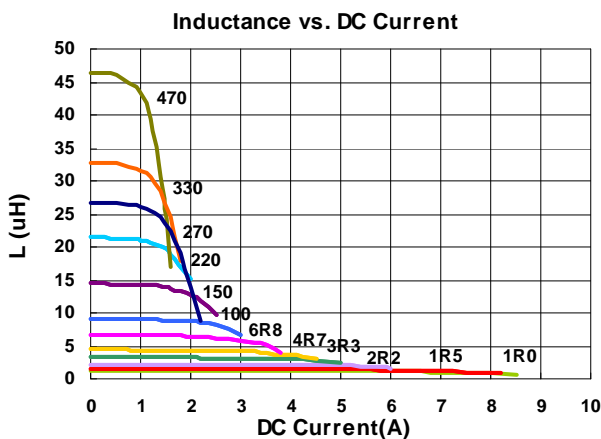
Electrical Characteristics

| Part Number | Inductance (uH) | Tolerance (±%) | Test Frequency (kHz) | RDC (mΩ) ±30% | Isat (A) Typ. (Max) | Irms (A) Typ. (Max) | Marking |
|------------------|-----------------|----------------|----------------------|---------------|---------------------|---------------------|---------|
| LVS505040-1R0□-N | 1.0 | 30 | 100 | 14 | 7.5(6.75) | 4.6(4.14) | 1R0 |
| LVS505040-1R2□-N | 1.2 | 20, 30 | 100 | 15 | 7.4(6.66) | 4.5(4.05) | 1R2 |
| LVS505040-1R5□-N | 1.5 | 20, 30 | 100 | 16 | 7.1(6.39) | 4.4(3.96) | 1R5 |
| LVS505040-2R2□-N | 2.2 | 20, 30 | 100 | 21 | 5.7(5.13) | 3.7(3.33) | 2R2 |
| LVS505040-3R0□-N | 2.2 | 20, 30 | 100 | 26 | 4.8(4.32) | 3.5(3.15) | 3R0 |
| LVS505040-3R3□-N | 3.3 | 20, 30 | 100 | 26 | 4.8(4.32) | 3.5(3.15) | 3R3 |
| LVS505040-3R6□-N | 3.6 | 20, 30 | 100 | 31 | 4.2(3.70) | 3.3(2.90) | 3R6 |
| LVS505040-4R7□-N | 4.7 | 20, 30 | 100 | 32 | 4.2(3.78) | 3.2(2.88) | 4R7 |
| LVS505040-6R8□-N | 6.8 | 20, 30 | 100 | 50 | 3.3(2.97) | 2.4(2.16) | 6R8 |
| LVS505040-100□-N | 10 | 20, 30 | 100 | 60 | 2.8(2.52) | 2.2(1.98) | 100 |
| LVS505040-150□-N | 15 | 20, 30 | 100 | 90 | 2.3(2.07) | 1.8(1.62) | 150 |
| LVS505040-220□-N | 22 | 20, 30 | 100 | 135 | 1.8(1.62) | 1.4(1.26) | 220 |
| LVS505040-270□-N | 27 | 20, 30 | 100 | 180 | 1.6(1.44) | 1.2(1.08) | 270 |
| LVS505040-330□-N | 33 | 20, 30 | 100 | 190 | 1.5(1.35) | 1.1(0.99) | 330 |
| LVS505040-470□-N | 47 | 20, 30 | 100 | 310 | 1.2(1.08) | 0.9(0.81) | 470 |
| LVS505040-680□-N | 68 | 20, 30 | 100 | 540 | 1.0(0.90) | 0.78(0.7) | 680 |
| LVS505040-101□-N | 100 | 20, 30 | 100 | 800 | 0.7(0.60) | 0.6(0.50) | 101 |

Note: When ordering, please specify tolerance code. Tolerance: M=±20% , T =±30%

- Operating temperature range - 55°C ~ 125°C(Including self - temperature rise)
- Isat for Inductance drop 30% from its value without current
- Irms for a 40°C temperature rise from 25°C ambient with current
- Measure Equipment :
 L : Agilent HP4284A+Agilent HP42841A, 100kHz 1V
 RDC : DIGITAL MILLINHM METER CHROMA 16502, or equivalent
 Isat & Irms : Agilent HP4284A

Test Instruments : HP4284A Material/Impedance Analyzer



Please be sure to request approval specifications that provide further details of the products. Kindly note that the content of these specifications are subject to change or may be discontinued without advance notice. Please contact our sales department before ordering.

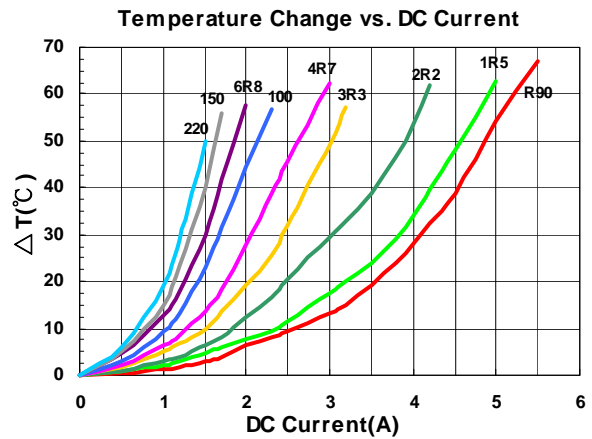
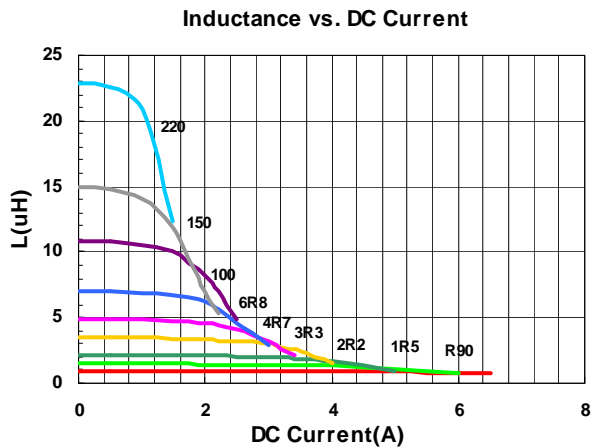
Electrical Characteristics

| Part Number | Inductance (uH) | Tolerance (±%) | Test Frequency (kHz) | RDC (mΩ) ±30% | Isat (A) Typ. (Max) | Irms (A) Typ. (Max) | Marking |
|------------------|-----------------|----------------|----------------------|---------------|---------------------|---------------------|---------|
| LVS606020-R50□-N | 0.5 | 30 | 100 | 13 | 8.0(7.20) | 5.3(4.77) | R50 |
| LVS606020-R90□-N | 0.9 | 30 | 100 | 18 | 6.3(5.67) | 4.2(3.78) | R90 |
| LVS606020-1R0□-N | 1.0 | 30 | 100 | 19 | 6.2(5.58) | 4.1(3.69) | 1R0 |
| LVS606020-1R5□-N | 1.5 | 20, 30 | 100 | 26 | 5.0(4.50) | 3.6(3.24) | 1R5 |
| LVS606020-2R2□-N | 2.2 | 20, 30 | 100 | 34 | 4.2(3.78) | 3.2(2.88) | 2R2 |
| LVS606020-3R3□-N | 3.3 | 20, 30 | 100 | 40 | 3.2(2.88) | 2.7(2.43) | 3R3 |
| LVS606020-4R7□-N | 4.7 | 20, 30 | 100 | 58 | 2.5(2.25) | 2.2(1.98) | 4R7 |
| LVS606020-6R8□-N | 6.8 | 20, 30 | 100 | 85 | 2.2(1.98) | 1.8(1.62) | 6R8 |
| LVS606020-100□-N | 10 | 20, 30 | 100 | 125 | 2.0(1.80) | 1.6(1.44) | 100 |
| LVS606020-150□-N | 15 | 20, 30 | 100 | 190 | 1.3(1.17) | 1.3(1.17) | 150 |
| LVS606020-220□-N | 22 | 20, 30 | 100 | 260 | 1.1(0.99) | 1.1(0.99) | 220 |

Note: When ordering, please specify tolerance code. Tolerance: M=±20% , T =±30%

- Operating temperature range - 55°C ~ 125°C(Including self - temperature rise)
- Isat for Inductance drop 30% from its value without current
- Irms for a 40°C temperature rise from 25°C ambient with current
- Measure Equipment :
 L : Agilent HP4284A+Agilent HP42841A, 100kHz 1V
 RDC : DIGITAL MILLINHM METER CHROMA 16502, or equivalent
 Isat & Irms : Agilent HP4284A

Test Instruments : HP4284A Material/Impedance Analyzer



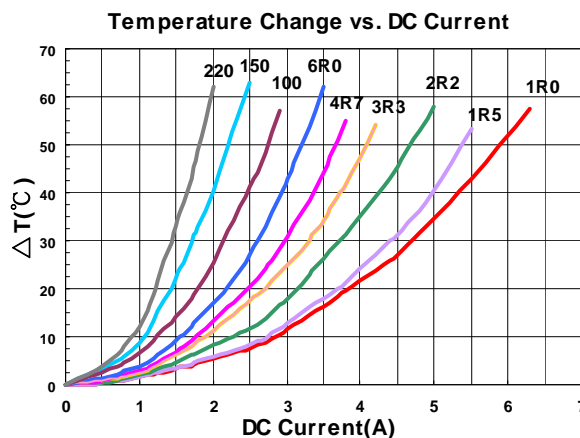
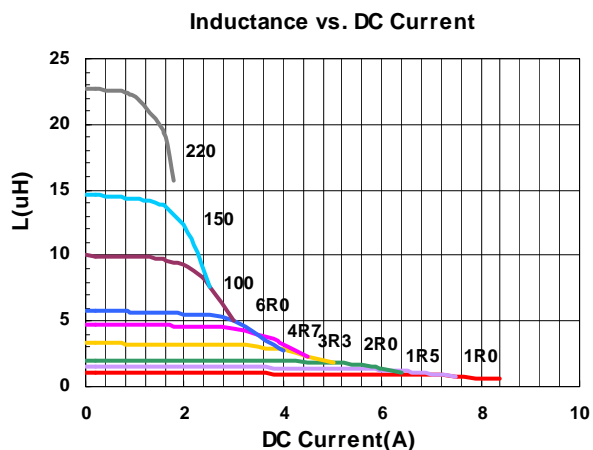
Electrical Characteristics

| Part Number | Inductance (uH) | Tolerance (±%) | Test Frequency (kHz) | RDC (mΩ) ±30% | Isat (A) Typ. (Max) | Irms (A) Typ. (Max) | Marking |
|------------------|-----------------|----------------|----------------------|---------------|---------------------|---------------------|---------|
| LVS606028-1R0□-N | 1.0 | 20, 30 | 100 | 13 | 7.6(6.84) | 5.2(4.68) | 1R0 |
| LVS606028-1R5□-N | 1.5 | 30 | 100 | 16 | 6.3(5.67) | 4.8(4.32) | 1R5 |
| LVS606028-2R2□-N | 2.2 | 20, 30 | 100 | 20 | 5.4(4.86) | 4.0(3.60) | 2R2 |
| LVS606028-2R7□-N | 2.7 | 20, 30 | 100 | 26 | 4.9(4.41) | 3.7(3.33) | 2R7 |
| LVS606028-3R3□-N | 3.3 | 20, 30 | 100 | 28 | 4.3(3.87) | 3.5(3.15) | 3R3 |
| LVS606028-4R7□-N | 4.7 | 20, 30 | 100 | 38 | 3.7(3.33) | 3.2(2.88) | 4R7 |
| LVS606028-6R0□-N | 6.0 | 20, 30 | 100 | 45 | 3.3(2.97) | 2.8(2.52) | 6R0 |
| LVS606028-6R8□-N | 6.8 | 20, 30 | 100 | 50 | 3.1(2.79) | 2.7(2.43) | 6R8 |
| LVS606028-100□-N | 10 | 20, 30 | 100 | 65 | 2.5(2.25) | 2.3(2.07) | 100 |
| LVS606028-150□-N | 15 | 20, 30 | 100 | 95 | 2.0(1.80) | 1.8(1.62) | 150 |
| LVS606028-220□-N | 22 | 20, 30 | 100 | 135 | 1.6(1.44) | 1.5(1.35) | 220 |
| LVS606028-330□-N | 33 | 20, 30 | 100 | 220 | 1.3(1.17) | 1.4(1.26) | 330 |
| LVS606028-470□-N | 47 | 20, 30 | 100 | 320 | 1.1(0.99) | 1.0(0.90) | 470 |
| LVS606028-680□-N | 68 | 20, 30 | 100 | 420 | 0.98(0.88) | 0.9(0.81) | 680 |
| LVS606028-101□-N | 100 | 20, 30 | 100 | 600 | 0.82(0.73) | 0.8(0.72) | 101 |

Note: When ordering, please specify tolerance code. Tolerance: M=±20% , T =±30%

- Operating temperature range - 55°C ~ 125°C(Including self - temperature rise)
- Isat for Inductance drop 30% from its value without current
- Irms for a 40°C temperature rise from 25°C ambient with current
- Measure Equipment :
 L : Agilent HP4284A+Agilent HP42841A, 100kHz 1V
 RDC : DIGITAL MILLINHM METER CHROMA 16502, or equivalent
 Isat & Irms : Agilent HP4284A

Test Instruments : HP4284A Material/Impedance Analyzer



Please be sure to request approval specifications that provide further details of the products. Kindly note that the content of these specifications are subject to change or may be discontinued without advance notice. Please contact our sales department before ordering.

Electrical Characteristics

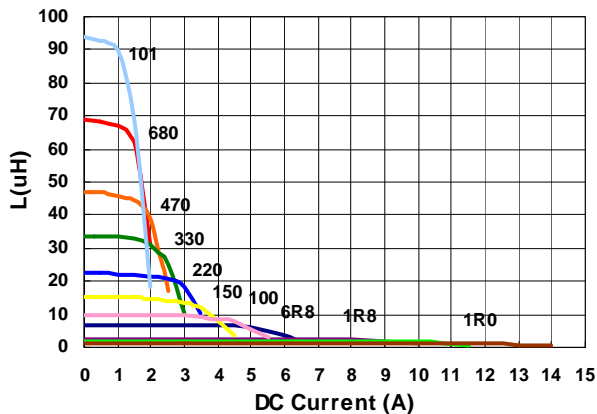
| Part Number | Inductance (uH) | Tolerance (±%) | Test Frequency (kHz) | RDC (mΩ) ±30% | Isat (A) Typ. (Max) | Irms (A) Typ. (Max) | Marking |
|------------------|-----------------|----------------|----------------------|---------------|---------------------|---------------------|---------|
| LVS606045-1R0□-N | 1.0 | 20, 30 | 100 | 12 | 12.2(10.98) | 6.5(5.85) | 1R0 |
| LVS606045-1R2□-N | 1.2 | 20, 30 | 100 | 13 | 10.6(9.50) | 5.9(5.30) | 1R2 |
| LVS606045-1R5□-N | 1.5 | 20, 30 | 100 | 15 | 10.4(9.36) | 5.9(5.31) | 1R5 |
| LVS606045-1R8□-N | 1.8 | 20, 30 | 100 | 17 | 9.6(8.64) | 5.6(5.04) | 1R8 |
| LVS606045-2R2□-N | 2.2 | 20, 30 | 100 | 18.4 | 8.8(7.92) | 5.1(4.59) | 2R2 |
| LVS606045-2R3□-N | 2.3 | 20, 30 | 100 | 19 | 8.8(7.92) | 5.0(4.50) | 2R3 |
| LVS606045-3R0□-N | 3.0 | 20, 30 | 100 | 22 | 7.8(7.02) | 4.4(3.96) | 3R0 |
| LVS606045-3R3□-N | 3.3 | 20, 30 | 100 | 24 | 7.5(6.75) | 4.3(3.87) | 3R3 |
| LVS606045-3R6□-N | 3.6 | 20, 30 | 100 | 24 | 7.5(6.75) | 4.3(3.87) | 3R6 |
| LVS606045-3R9□-N | 3.9 | 20, 30 | 100 | 26 | 7.0(6.30) | 4.0(3.60) | 3R9 |
| LVS606045-4R5□-N | 4.5 | 20, 30 | 100 | 31 | 6.7(6.03) | 3.9(3.51) | 4R5 |
| LVS606045-4R7□-N | 4.7 | 20, 30 | 100 | 31 | 6.7(6.03) | 3.9(3.51) | 4R7 |
| LVS606045-5R1□-N | 5.1 | 20, 30 | 100 | 33 | 6.0(5.40) | 3.5(3.15) | 5R1 |
| LVS606045-5R6□-N | 5.6 | 20, 30 | 100 | 40 | 5.5(4.95) | 3.3(2.97) | 5R6 |
| LVS606045-6R3□-N | 6.3 | 20, 30 | 100 | 40 | 5.5(4.95) | 3.3(2.97) | 6R3 |
| LVS606045-6R8□-N | 6.8 | 20, 30 | 100 | 43 | 5.3(4.77) | 3.2(2.88) | 6R8 |
| LVS606045-8R2□-N | 8.2 | 20, 30 | 100 | 53 | 4.6(4.10) | 2.9(2.60) | 8R2 |
| LVS606045-100□-N | 10 | 20, 30 | 100 | 57 | 4.5(4.05) | 2.7(2.43) | 100 |
| LVS606045-150□-N | 15 | 20, 30 | 100 | 80 | 3.4(3.06) | 2.2(1.98) | 150 |
| LVS606045-180□-N | 18 | 20, 30 | 100 | 100 | 3.1(2.79) | 1.8(1.62) | 180 |
| LVS606045-220□-N | 22 | 20, 30 | 100 | 125 | 3.0(2.70) | 1.9(1.71) | 220 |
| LVS606045-270□-N | 27 | 20, 30 | 100 | 160 | 2.5(2.25) | 1.3(1.17) | 270 |
| LVS606045-330□-N | 33 | 20, 30 | 100 | 165 | 2.3(2.07) | 1.4(1.26) | 330 |
| LVS606045-470□-N | 47 | 20, 30 | 100 | 245 | 1.9(1.71) | 1.2(1.08) | 470 |
| LVS606045-560□-N | 56 | 20, 30 | 100 | 310 | 1.7(1.50) | 1.1(0.99) | 560 |
| LVS606045-680□-N | 68 | 20, 30 | 100 | 330 | 1.6(1.44) | 1.0(0.90) | 680 |
| LVS606045-101□-N | 100 | 20, 30 | 100 | 500 | 1.3(1.17) | 0.8(0.72) | 101 |
| LVS606045-221□-N | 220 | 20, 30 | 100 | 1300 | 0.82(0.73) | 0.38(0.34) | 221 |
| LVS606045-331□-N | 330 | 20, 30 | 100 | 1800 | 0.7(0.63) | 0.35(0.31) | 331 |
| LVS606045-102□-N | 1000 | 20, 30 | 100 | 6000 | 0.4(0.36) | 0.22(0.19) | 102 |

Note: When ordering, please specify tolerance code. Tolerance: M=±20% , T =±30%

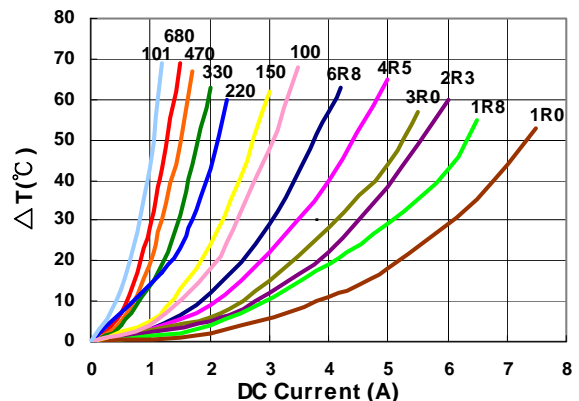
- Operating temperature range - 55°C ~ 125°C(Including self - temperature rise)
- Isat for Inductance drop 30% from its value without current
- I rms for a 40°C temperature rise from 25°C ambient with current
- Measure Equipment :
 L : Agilent HP4284A+Agilent HP42841A, 100kHz 1V
 RDC : DIGITAL MILLINHM METER CHROMA 16502, or equivalent
 Isat & I rms : Agilent HP4284A

Test Instruments : HP4284A Material/Impedance Analyzer

Inductance vs. DC Current



Temperature Change vs. DC Current



Please be sure to request approval specifications that provide further details of the products. Kindly note that the content of these specifications are subject to change or may be discontinued without advance notice. Please contact our sales department before ordering.

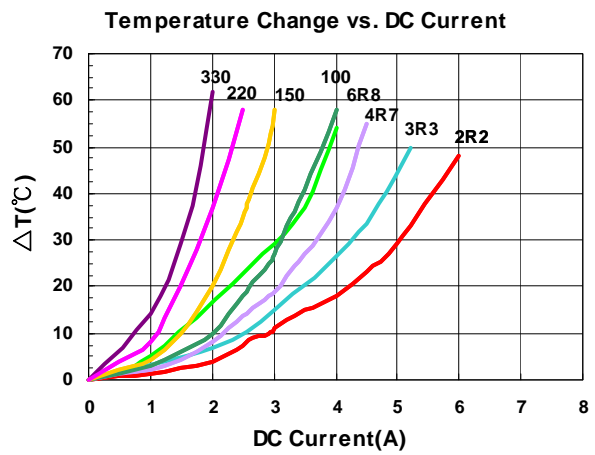
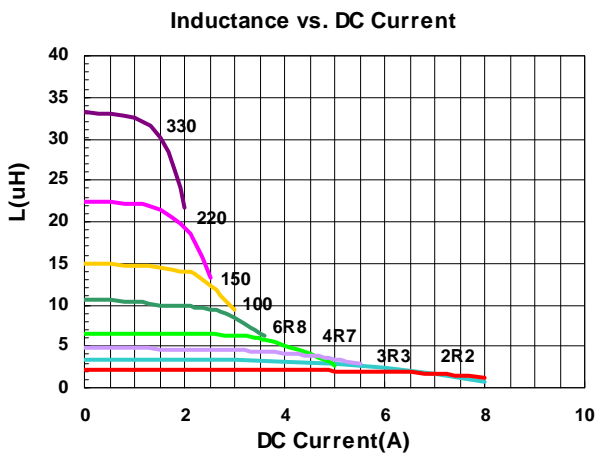
Electrical Characteristics

| Part Number | Inductance (uH) | Tolerance (±%) | Test Frequency (kHz) | RDC (mΩ) Max | Isat (A) Typ. (Max) | Irms (A) Typ. (Max) | Marking |
|-------------------|-----------------|----------------|----------------------|--------------|---------------------|---------------------|---------|
| LVS606045L-R50□-N | 0.5 | 30 | 100 | 9 | 11(9.90) | 8.0(7.20) | R50 |
| LVS606045L-2R2□-N | 2.2 | 20, 30 | 100 | 17 | 6.8(6.12) | 5.5(4.95) | 2R2 |
| LVS606045L-3R3□-N | 3.3 | 20, 30 | 100 | 24 | 5.5(4.95) | 4.7(4.23) | 3R3 |
| LVS606045L-4R7□-N | 4.7 | 20, 30 | 100 | 30 | 4.6(4.14) | 4.0(3.60) | 4R7 |
| LVS606045L-6R8□-N | 6.8 | 20, 30 | 100 | 40 | 4.0(3.60) | 3.5(3.15) | 6R8 |
| LVS606045L-100□-N | 10 | 20, 30 | 100 | 50 | 3.2(2.88) | 3.2(2.88) | 100 |
| LVS606045L-150□-N | 15 | 20, 30 | 100 | 80 | 2.6(2.34) | 2.5(2.25) | 150 |
| LVS606045L-220□-N | 22 | 20, 30 | 100 | 120 | 2.1(1.89) | 2.0(1.80) | 220 |
| LVS606045L-330□-N | 33 | 20, 30 | 100 | 170 | 1.7(1.53) | 1.6(1.44) | 330 |
| LVS606045L-101□-N | 100 | 20, 30 | 100 | 595 | 0.95(0.85) | 0.92(0.82) | 101 |

Note: When ordering, please specify tolerance code. Tolerance: M=±20% , T =±30%

- Operating temperature range - 55°C ~ 125°C(Including self - temperature rise)
- Isat for Inductance drop 30% from its value without current
- Iirms for a 40°C temperature rise from 25°C ambient with current
- Measure Equipment :
 L : Agilent HP4284A+Agilent HP42841A, 100kHz 1V
 RDC : DIGITAL MILLINHM METER CHROMA 16502, or equivalent
 Isat & Iirms : Agilent HP4284A

Test Instruments : HP4284A Material/Impedance Analyzer



Please be sure to request approval specifications that provide further details of the products. Kindly note that the content of these specifications are subject to change or may be discontinued without advance notice. Please contact our sales department before ordering.

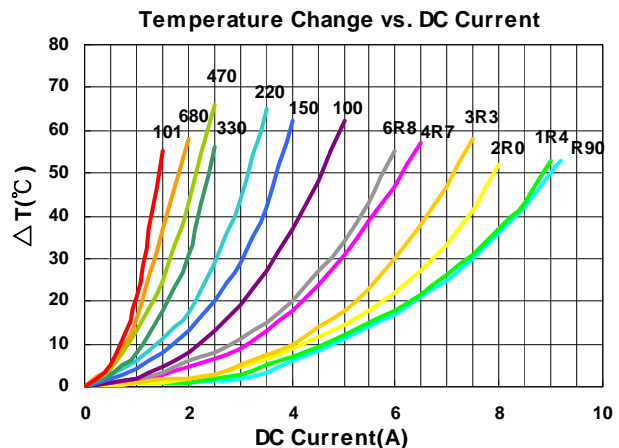
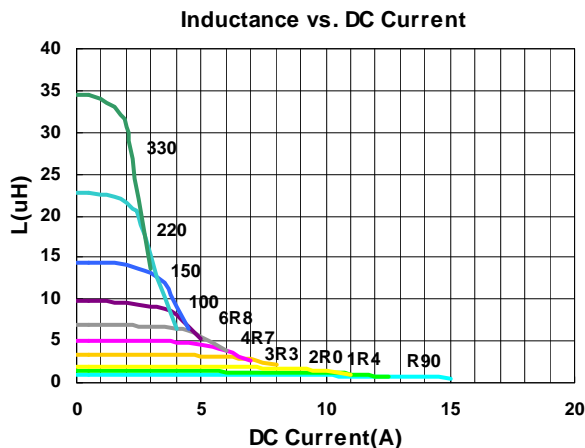
Electrical Characteristics

| Part Number | Inductance (uH) | Tolerance (±%) | Test Frequency (kHz) | RDC (mΩ) ±30% | Isat (A) Typ. (Max) | Irms (A) Typ. (Max) | Marking |
|------------------|-----------------|----------------|----------------------|---------------|---------------------|---------------------|---------|
| LVS808040-R90□-N | 0.9 | 30 | 100 | 7 | 13.8(12.42) | 8.05(7.24) | R90 |
| LVS808040-1R0□-N | 1.0 | 30 | 100 | 7.5 | 13.0(11.70) | 7.95(7.15) | 1R0 |
| LVS808040-1R4□-N | 1.4 | 30 | 100 | 9 | 10.8(9.72) | 7.8(7.02) | 1R4 |
| LVS808040-1R5□-N | 1.5 | 30 | 100 | 9.5 | 10.0(9.00) | 7.7(6.93) | 1R5 |
| LVS808040-2R0□-N | 2.0 | 20, 30 | 100 | 11 | 9.6(8.64) | 7.4(6.66) | 2R0 |
| LVS808040-2R2□-N | 2.2 | 20, 30 | 100 | 11.5 | 9.2(8.28) | 7.2(6.48) | 2R2 |
| LVS808040-2R5□-N | 2.5 | 20, 30 | 100 | 13 | 8.2(7.38) | 6.3(5.67) | 2R5 |
| LVS808040-3R3□-N | 3.3 | 20, 30 | 100 | 15 | 7.5(6.75) | 6.0(5.40) | 3R3 |
| LVS808040-3R9□-N | 3.9 | 20, 30 | 100 | 18 | 6.1(5.40) | 5.5(4.90) | 3R9 |
| LVS808040-4R7□-N | 4.7 | 20, 30 | 100 | 18 | 6.0(5.40) | 5.5(4.95) | 4R7 |
| LVS808040-5R6□-N | 5.6 | 20, 30 | 100 | 23 | 5.7(5.13) | 5.2(4.68) | 5R6 |
| LVS808040-6R8□-N | 6.8 | 20, 30 | 100 | 25 | 5.4(4.86) | 5.1(4.59) | 6R8 |
| LVS808040-100□-N | 10 | 20, 30 | 100 | 38 | 4.3(3.87) | 3.8(3.42) | 100 |
| LVS808040-120□-N | 12 | 20, 30 | 100 | 45 | 3.8(3.42) | 3.5(3.15) | 120 |
| LVS808040-150□-N | 15 | 20, 30 | 100 | 50 | 3.6(3.24) | 3.2(2.88) | 150 |
| LVS808040-180□-N | 18 | 20, 30 | 100 | 68 | 3.1(2.79) | 2.7(2.43) | 180 |
| LVS808040-220□-N | 22 | 20, 30 | 100 | 80 | 2.8(2.52) | 2.6(2.34) | 220 |
| LVS808040-330□-N | 33 | 20, 30 | 100 | 110 | 2.3(2.07) | 2.0(1.80) | 330 |
| LVS808040-470□-N | 47 | 20, 30 | 100 | 160 | 1.9(1.71) | 1.75(1.57) | 470 |
| LVS808040-680□-N | 68 | 20, 30 | 100 | 240 | 1.7(1.53) | 1.45(1.30) | 680 |
| LVS808040-101□-N | 100 | 20, 30 | 100 | 340 | 1.4(1.26) | 1.10(0.99) | 101 |
| LVS808040-121□-N | 120 | 20, 30 | 100 | 425 | 1.1(0.99) | 1.0(0.90) | 121 |
| LVS808040-151□-N | 150 | 20, 30 | 100 | 480 | 1.0(0.90) | 0.9(0.81) | 151 |
| LVS808040-181□-N | 180 | 20, 30 | 100 | 650 | 0.98(0.88) | 0.7(0.63) | 181 |
| LVS808040-221□-N | 220 | 20, 30 | 100 | 670 | 0.94(0.84) | 0.60(0.54) | 221 |
| LVS808040-271□-N | 270 | 20, 30 | 100 | 900 | 0.83(0.74) | 0.55(0.49) | 271 |
| LVS808040-821□-N | 820 | 20, 30 | 100 | 2800 | 0.40(0.36) | 0.38(0.34) | 821 |

Note: When ordering, please specify tolerance code. Tolerance: M=±20% , T =±30%

- Operating temperature range - 55°C ~ 125°C(Including self - temperature rise)
- Isat for Inductance drop 30% from its value without current
- Irms for a 40°C temperature rise from 25°C ambient with current
- Measure Equipment :
 L : Agilent HP4284A+Agilent HP42841A, 100kHz 1V
 RDC : DIGITAL MILLINHM METER CHROMA 16502, or equivalent
 Isat & Irms : Agilent HP4284A

Test Instruments : HP4284A Material/Impedance Analyzer



Please be sure to request approval specifications that provide further details of the products. Kindly note that the content of these specifications are subject to change or may be discontinued without advance notice. Please contact our sales department before ordering.

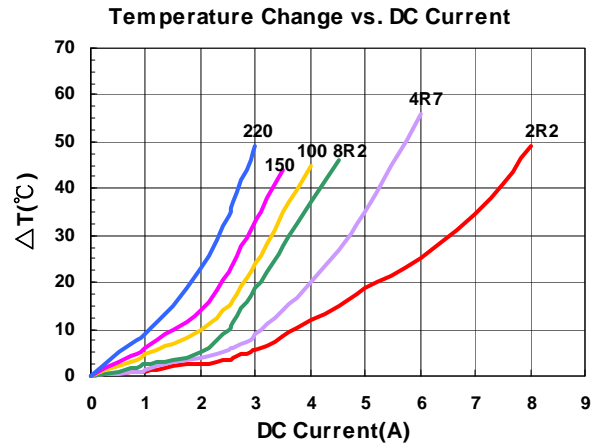
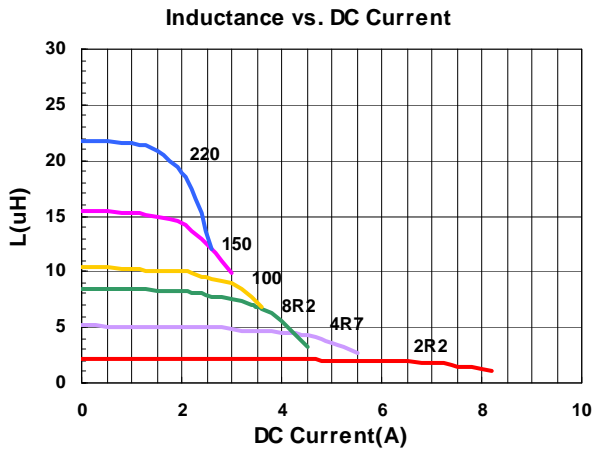
Electrical Characteristics

| Part Number | Inductance (uH) | Tolerance (±%) | Test Frequency (kHz) | RDC (mΩ) Max | Isat (A) Typ. (Max) | Irms (A) Typ. (Max) | Marking |
|-------------------|-----------------|----------------|----------------------|--------------|---------------------|---------------------|---------|
| LVS808040L-1R0□-N | 1.0 | 30 | 100 | 10 | 9.5(8.55) | 8.5(7.65) | 1R0 |
| LVS808040L-2R2□-N | 2.2 | 20,30 | 100 | 12 | 7.2(6.48) | 7.3(6.57) | 2R2 |
| LVS808040L-3R3□-N | 3.3 | 20,30 | 100 | 19 | 5.6(5.04) | 6.0(5.40) | 3R3 |
| LVS808040L-4R7□-N | 4.7 | 20,30 | 100 | 22 | 4.4(3.96) | 5.0(4.50) | 4R7 |
| LVS808040L-8R2□-N | 8.2 | 20,30 | 100 | 37 | 3.6(3.24) | 3.8(3.42) | 8R2 |
| LVS808040L-100□-N | 10 | 20,30 | 100 | 42 | 3.1(2.79) | 3.5(3.15) | 100 |
| LVS808040L-150□-N | 15 | 20,30 | 100 | 58 | 2.5(2.25) | 3.0(2.70) | 150 |
| LVS808040L-220□-N | 22 | 20,30 | 100 | 85 | 2.0(1.80) | 2.5(2.25) | 220 |

Note: When ordering, please specify tolerance code. Tolerance: M=±20% , T =±30%

- Operating temperature range - 55°C ~ 125°C(Including self - temperature rise)
- Isat for Inductance drop 30% from its value without current
- I rms for a 40°C temperature rise from 25°C ambient with current
- Measure Equipment :
 - L : Agilent HP4284A+Agilent HP42841A, 100kHz 1V
 - RDC : DIGITAL MILLINHM METER CHROMA 16502, or equivalent
 - Isat & I rms : Agilent HP4284A

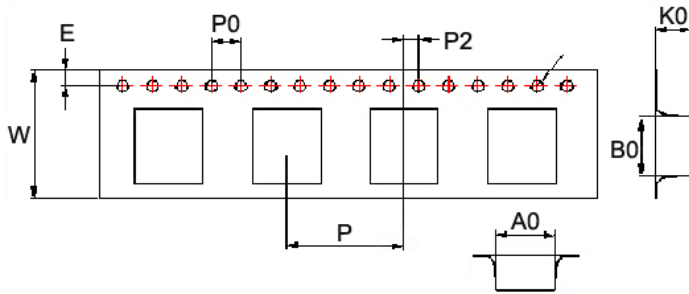
Test Instruments : HP4284A Material/Impedance Analyzer



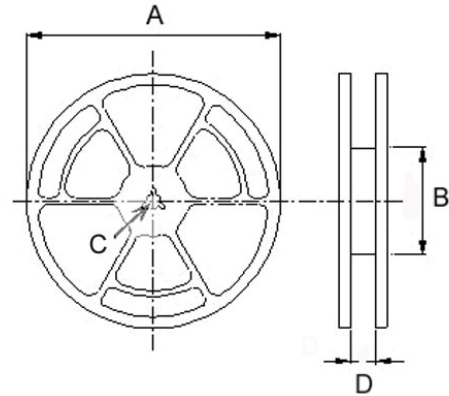
Please be sure to request approval specifications that provide further details of the products. Kindly note that the content of these specifications are subject to change or may be discontinued without advance notice. Please contact our sales department before ordering.

Packaging Specifications

Tape Dimensions



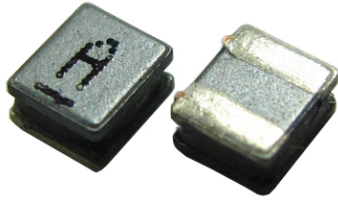
Reel Dimensions



Dimensions in mm

| TYPE | Tape Dimensions | | | | | | | | | | Reel Dimensions | | | | Quantity PCS / Reel |
|-----------|-----------------|------|------|------|------|-----|----|-----|----|----|-----------------|-----|----|------|------------------------|
| | A0 | B0 | K0 | D | E | F | W | P | P0 | P2 | A | B | C | D | |
| LVS404012 | 4.25 | 4.25 | 1.30 | 1.55 | 1.75 | 5.5 | 12 | 8.1 | 4 | 2 | 180 | 60 | 13 | 13.2 | 1000 |
| LVS404018 | 4.25 | 4.25 | 2.10 | 1.55 | 1.75 | 5.5 | 12 | 8.1 | 4 | 2 | 180 | 60 | 13 | 13.2 | 800 |
| LVS404026 | 4.25 | 4.25 | 3.00 | 1.55 | 1.75 | 5.5 | 12 | 8.1 | 4 | 2 | 180 | 60 | 13 | 13.2 | 500 |
| LVS505020 | 5.25 | 5.25 | 2.20 | 1.55 | 1.75 | 5.5 | 12 | 8.1 | 4 | 2 | 330 | 100 | 13 | 13.4 | 2000 |
| LVS505040 | 5.20 | 5.20 | 4.20 | 1.55 | 1.75 | 5.5 | 12 | 8.1 | 4 | 2 | 330 | 100 | 13 | 13.4 | 1500 |
| LVS606020 | 6.25 | 6.25 | 2.20 | 1.55 | 1.75 | 7.5 | 16 | 12 | 4 | 2 | 330 | 100 | 13 | 16.0 | 2000 |
| LVS606028 | 6.25 | 6.25 | 3.00 | 1.55 | 1.75 | 7.5 | 16 | 12 | 4 | 2 | 330 | 100 | 13 | 16.0 | 1500 |
| LVS606045 | 6.25 | 6.25 | 4.65 | 1.55 | 1.75 | 7.5 | 16 | 12 | 4 | 2 | 330 | 100 | 13 | 16.0 | 1000 |
| LVS808040 | 8.25 | 8.25 | 4.15 | 1.55 | 1.75 | 7.5 | 16 | 12 | 4 | 2 | 330 | 100 | 13 | 16.0 | 1000 |

LVF Series



LVF series, an automatic assembly constructed power inductor, is shielded with magnetic resin and suitable for portable DC-DC converter applications.

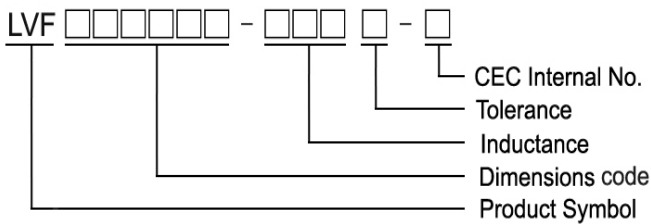
Features

- RoHS, Halogen Free and REACH Compliance
- Shielded with magnetic resin
- Various package size and wide inductance range
- Optimize electrical characteristics by using different ferrite core figures

Applications

- Smartphones, tablets and wearable devices
- DSC, camcorders
- AP Routers
- STBs
- LCD TVs, monitors and panels
- Game consoles
- DC/DC converters

Product Identification



Shape and Dimensions

Figure 1

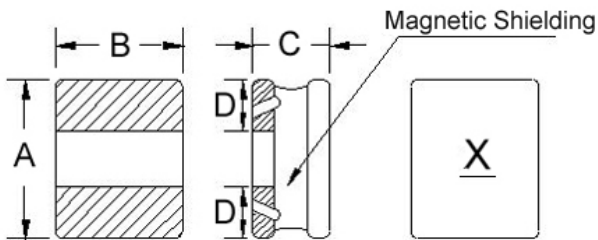
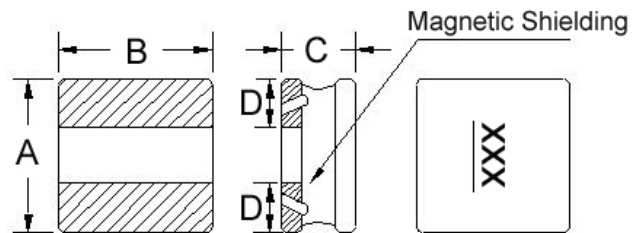


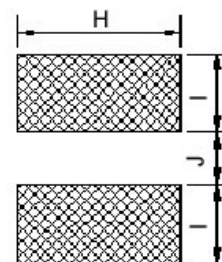
Figure 2



Dimensions in mm

| TYPE | FIG | A | B | C | D | H | I | J |
|-----------|-----|----------|----------|----------|-----|-----|------|-----|
| LVF201B12 | 1 | 2.0±0.25 | 1.6±0.25 | 1.2±0.05 | 0.6 | 1.8 | 0.8 | 0.8 |
| LVF252A10 | 1 | 2.5±0.25 | 2.0±0.25 | 1.02 Max | 0.8 | 2.2 | 0.85 | 0.8 |
| LVF252A12 | 1 | 2.5±0.25 | 2.0±0.25 | 1.2±0.05 | 0.8 | 2.2 | 0.85 | 0.8 |
| LVF303010 | 2 | 3.0±0.20 | 3.0±0.20 | 1.02 Max | 1.0 | 3.2 | 1.1 | 1.0 |
| LVF303012 | 2 | 3.0±0.20 | 3.0±0.20 | 1.2 Max | 1.0 | 3.2 | 1.1 | 1.0 |
| LVF303015 | 2 | 3.0±0.20 | 3.0±0.20 | 1.5 Max | 1.0 | 3.2 | 1.1 | 1.0 |
| LVF404012 | 2 | 4.0±0.20 | 4.0±0.20 | 1.2±0.1 | 1.5 | 4.2 | 1.5 | 1.2 |

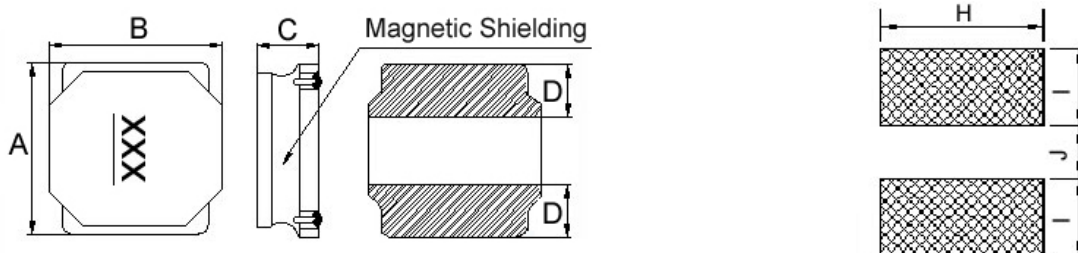
Recommended Pattern



Shape and Dimensions

Recommended Pattern

Figure 3



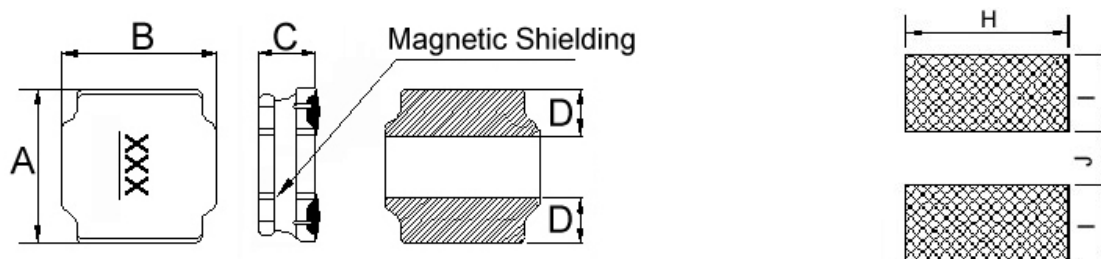
Dimensions in mm

| TYPE | FIG | A | B | C | D | H | I | J |
|-----------|-----|----------|----------|---------|-----|-----|-----|-----|
| LVF404015 | 3 | 4.0±0.25 | 4.0±0.25 | 1.5±0.2 | 1.3 | 3.7 | 1.5 | 1.2 |
| LVF404018 | 3 | 4.0±0.20 | 4.0±0.20 | 1.9 Max | 1.3 | 3.7 | 1.5 | 1.2 |
| LVF404026 | 3 | 4.0±0.20 | 4.0±0.25 | 2.6±0.2 | 1.4 | 3.7 | 1.6 | 1.2 |

Shapes and Dimensions

Recommended Pattern

Figure 4



Dimensions in mm

| TYPE | FIG | A | B | C | D | H | I | J |
|-----------|-----|----------|----------|--------------------------------------|---------|-----|-----|-----|
| LVF505020 | 4 | 5.0±0.20 | 5.0±0.20 | 2.0±0.2 | 1.8±0.3 | 4.2 | 1.6 | 2.0 |
| LVF606020 | 4 | 6.0±0.20 | 6.0±0.20 | 2.0±0.2 | 1.7±0.3 | 5.7 | 1.7 | 2.8 |
| LVF606028 | 4 | 6.0±0.20 | 6.0±0.20 | 2.8±0.2 | 1.9±0.3 | 5.7 | 1.8 | 2.6 |
| LVF808040 | 4 | 8.0±0.20 | 8.0±0.20 | 4.0 ^{+0.2} _{-0.30} | 2.3±0.3 | 7.5 | 2.5 | 3.4 |

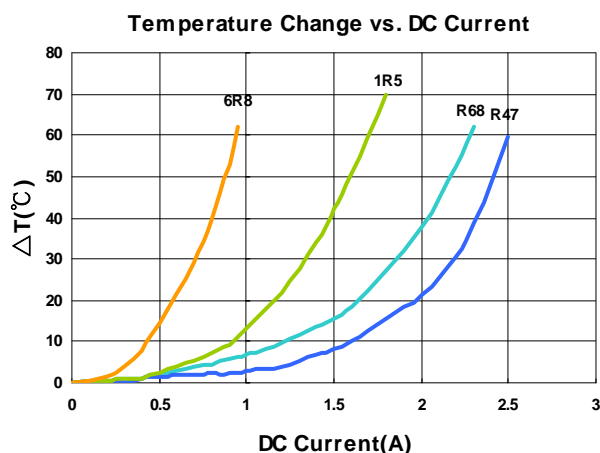
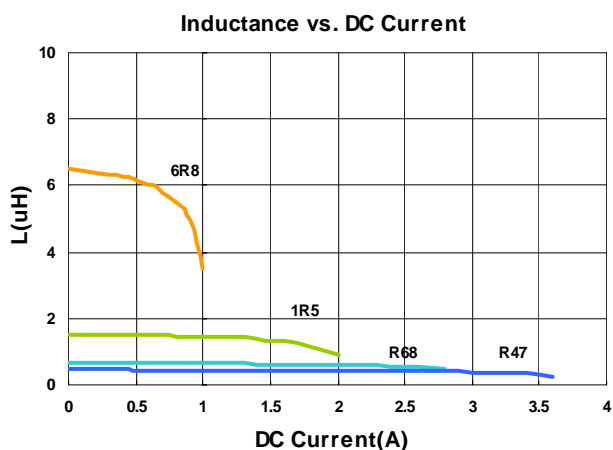
Electrical Characteristics

| Part Number | Inductance (uH) | Tolerance (±%) | Test Frequency (MHz) | RDC (Ω) ±30% | Isat (A) Typ. (Max) | Irms (A) Typ. (Max) | Marking |
|------------------|-----------------|----------------|----------------------|--------------|---------------------|---------------------|---------|
| LVF201B12-R47□-N | 0.47 | 20, 30 | 1 | 0.051 | 2.70(2.43) | 2.30(2.07) | A |
| LVF201B12-R68□-N | 0.68 | 20, 30 | 1 | 0.074 | 2.20(1.98) | 2.00(1.80) | L |
| LVF201B12-1R5□-N | 1.5 | 20, 30 | 1 | 0.130 | 1.60(1.44) | 1.45(1.30) | D |
| LVF201B12-6R8□-N | 6.8 | 20, 30 | 1 | 0.465 | 0.82(0.73) | 0.78(0.70) | H |

Note: When ordering, please specify tolerance code. Tolerance: M=±20% , T =±30%

- Operating temperature range - 55°C ~ 125°C(Including self - temperature rise)
- Isat for Inductance drop 30% from its value without current
- Irms for a 40°C temperature rise from 25°C ambient with current
- Measure Equipment :
 L : Agilent HP4287A+Agilent HP16197A, 1MHz 200mV
 RDC : DIGITAL MILLINHM METER CHROMA 16502, or equivalent
 Isat & Irms : Agilent HP4284A

Test Instruments : HP4284A Material/Impedance Analyzer



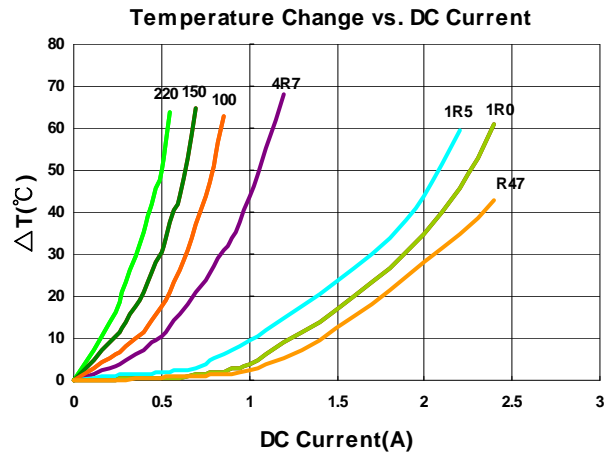
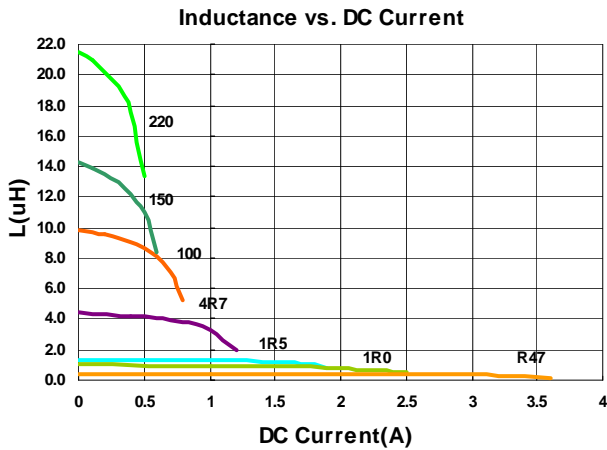
Electrical Characteristics

| Part Number | Inductance (uH) | Tolerance (±%) | Test Frequency (MHz) | RDC (Ω) ±30% | Isat (A) Typ. (Max) | Irms (A) Typ. (Max) | Marking |
|------------------|-----------------|----------------|----------------------|--------------|---------------------|---------------------|---------|
| LVF252A10-R47□-N | 0.47 | 20, 30 | 1 | 0.045 | 2.80(2.52) | 2.30(2.07) | A |
| LVF252A10-1R0□-N | 1.0 | 20, 30 | 1 | 0.066 | 1.98(1.78) | 2.05(1.84) | B |
| LVF252A10-1R5□-N | 1.5 | 20, 30 | 1 | 0.095 | 1.70(1.53) | 1.85(1.66) | C |
| LVF252A10-4R7□-N | 4.7 | 20, 30 | 1 | 0.285 | 0.92(0.82) | 0.95(0.85) | F |
| LVF252A10-100□-N | 10 | 20, 30 | 1 | 0.535 | 0.60(0.54) | 0.70(0.63) | H |
| LVF252A10-150□-N | 15 | 20, 30 | 1 | 0.810 | 0.50(0.45) | 0.55(0.49) | I |
| LVF252A10-220□-N | 22 | 20, 30 | 1 | 1.200 | 0.40(0.36) | 0.44(0.39) | J |

Note: When ordering, please specify tolerance code. Tolerance: M=±20% , T =±30%

- Operating temperature range - 55°C ~ 125°C(Including self - temperature rise)
- Isat for Inductance drop 30% from its value without current
- I rms for a 40°C temperature rise from 25°C ambient with current
- Measure Equipment :
 L : Agilent HP4287A+Agilent HP16197A, 1MHz 200mV
 RDC : DIGITAL MILLINHM METER CHROMA 16502, or equivalent
 Isat & I rms : Agilent HP4284A

Test Instruments : HP4284A Material/Impedance Analyzer



Please be sure to request approval specifications that provide further details of the products. Kindly note that the content of these specifications are subject to change or may be discontinued without advance notice. Please contact our sales department before ordering.

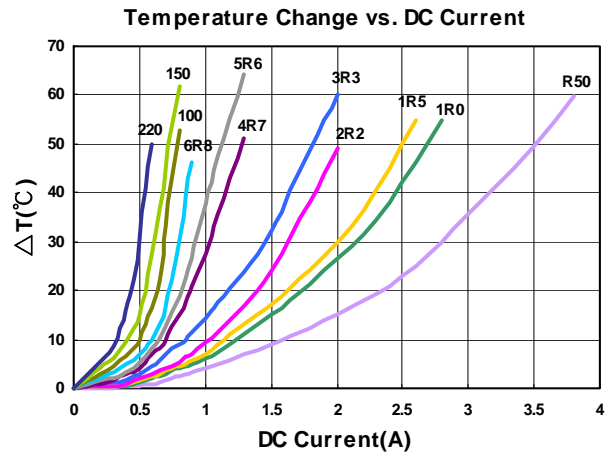
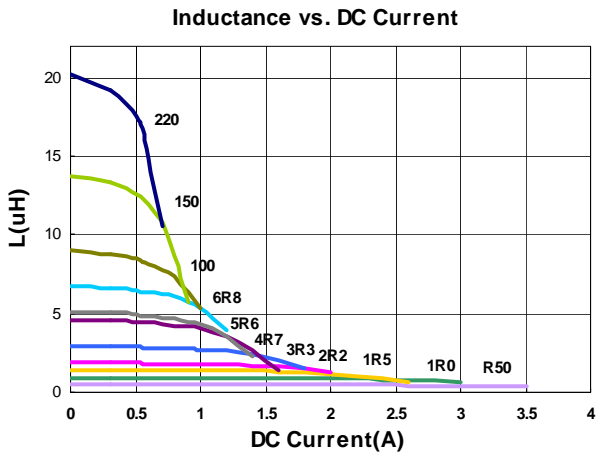
Electrical Characteristics

| Part Number | Inductance (uH) | Tolerance (±%) | Test Frequency (MHz) | RDC (Ω) ±30% | Isat (A) Typ. (Max) | Irms (A) Typ. (Max) | Marking |
|------------------|-----------------|----------------|----------------------|--------------|---------------------|---------------------|---------|
| LVF252A12-R50□-N | 0.50 | 20, 30 | 1 | 0.028 | 3.50(3.15) | 3.00(2.70) | B |
| LVF252A12-1R0□-N | 1.0 | 20, 30 | 1 | 0.050 | 2.50(2.25) | 2.40(2.16) | C |
| LVF252A12-1R2□-N | 1.2 | 20, 30 | 1 | 0.053 | 2.10(1.89) | 2.35(2.11) | D |
| LVF252A12-1R5□-N | 1.5 | 20, 30 | 1 | 0.068 | 1.95(1.75) | 2.30(2.07) | E |
| LVF252A12-2R2□-N | 2.2 | 20, 30 | 1 | 0.080 | 1.80(1.62) | 1.80(1.62) | F |
| LVF252A12-3R3□-N | 3.3 | 20, 30 | 1 | 0.130 | 1.45(1.30) | 1.50(1.35) | G |
| LVF252A12-4R7□-N | 4.7 | 20, 30 | 1 | 0.190 | 1.10(0.99) | 1.10(0.99) | H |
| LVF252A12-5R6□-N | 5.6 | 20, 30 | 1 | 0.210 | 1.05(0.94) | 1.00(0.90) | I |
| LVF252A12-6R8□-N | 6.8 | 20, 30 | 1 | 0.300 | 0.95(0.85) | 0.80(0.72) | J |
| LVF252A12-100□-N | 10 | 20, 30 | 1 | 0.385 | 0.88(0.79) | 0.70(0.63) | K |
| LVF252A12-150□-N | 15 | 20, 30 | 1 | 0.570 | 0.68(0.61) | 0.62(0.55) | L |
| LVF252A12-220□-N | 22 | 20, 30 | 1 | 0.810 | 0.55(0.49) | 0.53(0.47) | M |

Note: When ordering, please specify tolerance code. Tolerance: M=±20% , T =±30%

- Operating temperature range - 55°C ~ 125°C(Including self - temperature rise)
- Isat for Inductance drop 30% from its value without current
- I rms for a 40°C temperature rise from 25°C ambient with current
- Measure Equipment :
 L : Agilent HP4287A+Agilent HP16197A, 1MHz 200mV
 RDC : DIGITAL MILLINHM METER CHROMA 16502, or equivalent
 Isat & I rms : Agilent HP4284A

Test Instruments : HP4284A Material/Impedance Analyzer



Please be sure to request approval specifications that provide further details of the products. Kindly note that the content of these specifications are subject to change or may be discontinued without advance notice. Please contact our sales department before ordering.

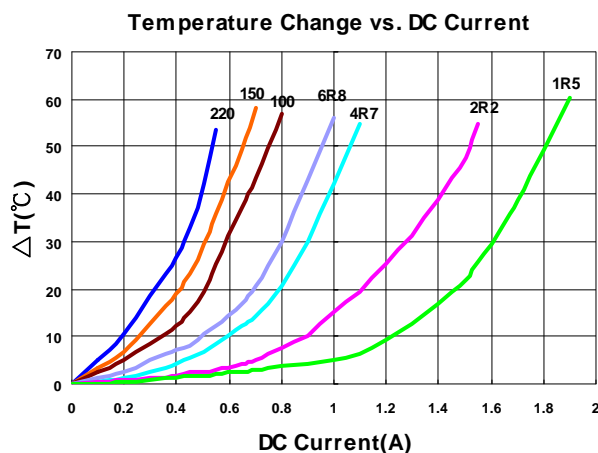
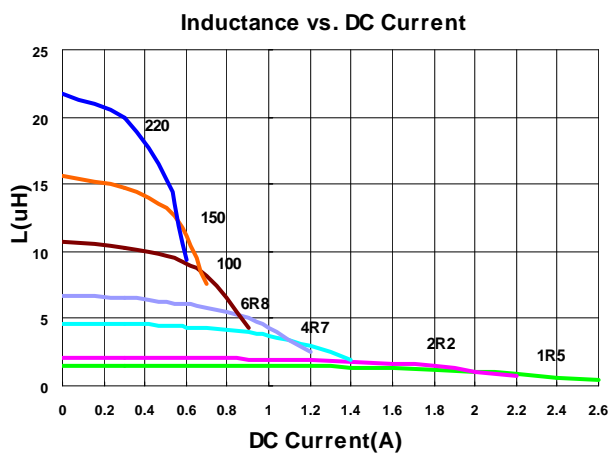
Electrical Characteristics

| Part Number | Inductance (uH) | Tolerance (±%) | Test Frequency (MHz) | RDC (Ω) ±30% | Isat (A) Typ. (Max) | Irms (A) Typ. (Max) | Marking |
|------------------|-----------------|----------------|----------------------|--------------|---------------------|---------------------|---------|
| LVF303010-1R5□-N | 1.5 | 20, 30 | 1 | 0.085 | 1.80(1.62) | 1.70(1.53) | 1R5 |
| LVF303010-2R2□-N | 2.2 | 20, 30 | 1 | 0.100 | 1.50(1.35) | 1.40(1.26) | 2R2 |
| LVF303010-4R7□-N | 4.7 | 20, 30 | 1 | 0.205 | 1.00(0.90) | 0.95(0.85) | 4R7 |
| LVF303010-6R8□-N | 6.8 | 20, 30 | 1 | 0.310 | 0.87(0.78) | 0.85(0.76) | 6R8 |
| LVF303010-100□-N | 10 | 20, 30 | 1 | 0.430 | 0.64(0.57) | 0.63(0.56) | 100 |
| LVF303010-150□-N | 15 | 20, 30 | 1 | 0.625 | 0.56(0.50) | 0.55(0.49) | 150 |
| LVF303010-220□-N | 22 | 20, 30 | 1 | 0.870 | 0.47(0.42) | 0.46(0.41) | 220 |
| LVF303010-470□-N | 47 | 20, 30 | 1 | 1.750 | 0.29(0.26) | 0.28(0.25) | 470 |

Note: When ordering, please specify tolerance code. Tolerance: M=±20% , T =±30%

- Operating temperature range - 55°C ~ 125°C(Including self - temperature rise)
- Isat for Inductance drop 30% from its value without current
- Irms for a 40°C temperature rise from 25°C ambient with current
- Measure Equipment :
 L : Agilent HP4287A+Agilent HP16197A, 1MHz 200mV
 RDC : DIGITAL MILLINHM METER CHROMA 16502, or equivalent
 Isat & Irms : Agilent HP4284A

Test Instruments : HP4284A Material/Impedance Analyzer



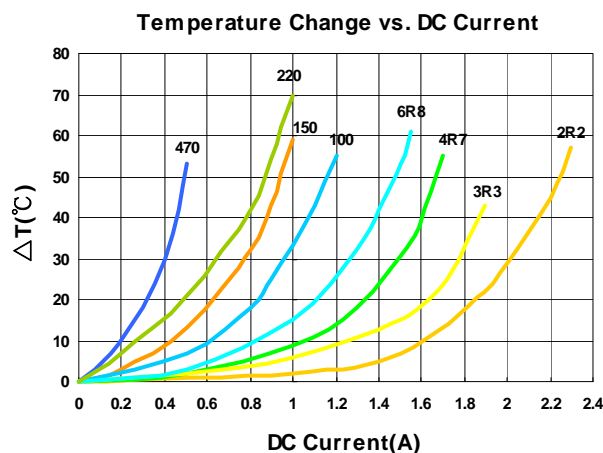
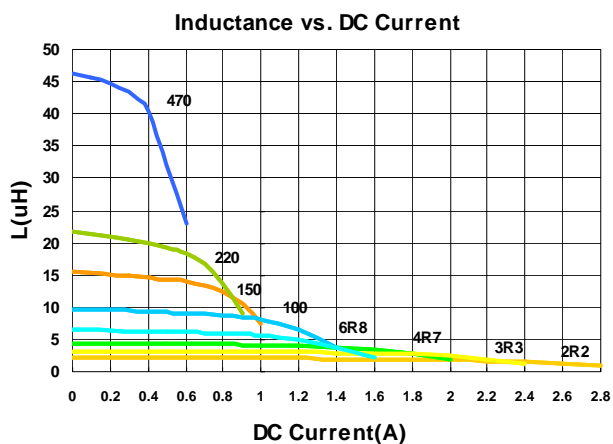
Electrical Characteristics

| Part Number | Inductance (uH) | Tolerance (±%) | Test Frequency (MHz) | RDC (Ω) ±30% | Isat (A) Typ. (Max) | Irms (A) Typ. (Max) | Marking |
|------------------|-----------------|----------------|----------------------|--------------|---------------------|---------------------|---------|
| LVF303012-2R2□-N | 2.2 | 20, 30 | 1 | 0.092 | 2.10(1.89) | 2.00(1.80) | 2R2 |
| LVF303012-3R3□-N | 3.3 | 20, 30 | 1 | 0.13 | 1.84(1.65) | 1.80(1.62) | 3R3 |
| LVF303012-4R7□-N | 4.7 | 20, 30 | 1 | 0.18 | 1.56(1.40) | 1.52(1.36) | 4R7 |
| LVF303012-6R8□-N | 6.8 | 20, 30 | 1 | 0.25 | 1.32(1.18) | 1.30(1.17) | 6R8 |
| LVF303012-100□-N | 10 | 20, 30 | 1 | 0.42 | 1.06(0.95) | 1.00(0.90) | 100 |
| LVF303012-150□-N | 15 | 20, 30 | 1 | 0.56 | 0.82(0.73) | 0.80(0.72) | 150 |
| LVF303012-220□-N | 22 | 20, 30 | 1 | 0.86 | 0.64(0.57) | 0.62(0.55) | 220 |
| LVF303012-470□-N | 47 | 20, 30 | 1 | 1.82 | 0.49(0.44) | 0.43(0.38) | 470 |

Note: When ordering, please specify tolerance code. Tolerance: M=±20% , T =±30%

- Operating temperature range - 55°C ~ 125°C(Including self - temperature rise)
- Isat for Inductance drop 30% from its value without current
- I rms for a 40°C temperature rise from 25°C ambient with current
- Measure Equipment :
 L : Agilent HP4287A+Agilent HP16197A, 1MHz 200mV
 RDC : DIGITAL MILLINHM METER CHROMA 16502, or equivalent
 Isat & I rms : Agilent HP4284A

Test Instruments : HP4284A Material/Impedance Analyzer



Please be sure to request approval specifications that provide further details of the products. Kindly note that the content of these specifications are subject to change or may be discontinued without advance notice. Please contact our sales department before ordering.

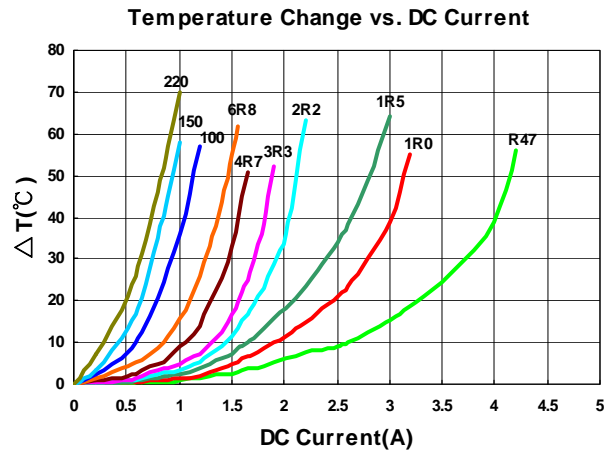
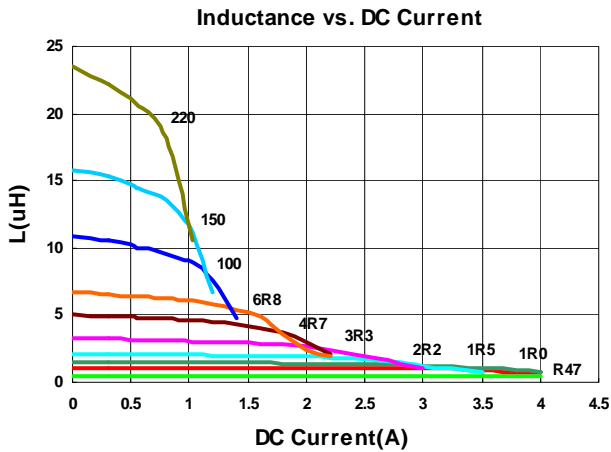
Electrical Characteristics

| Part Number | Inductance (uH) | Tolerance (±%) | Test Frequency (MHz) | RDC (Ω) ±30% | Isat (A) Typ. (Max) | Irms (A) Typ. (Max) | Marking |
|------------------|-----------------|----------------|----------------------|--------------|---------------------|---------------------|---------|
| LVF303015-R47□-N | 0.47 | 20, 30 | 1 | 0.036 | 4.7(4.23) | 4.0(3.60) | R47 |
| LVF303015-1R0□-N | 1.0 | 20, 30 | 1 | 0.054 | 3.4(3.06) | 3.0(2.70) | 1R0 |
| LVF303015-1R5□-N | 1.5 | 20, 30 | 1 | 0.063 | 3.0(2.70) | 2.6(2.34) | 1R5 |
| LVF303015-2R2□-N | 2.2 | 20, 30 | 1 | 0.090 | 2.3(2.07) | 2.0(1.80) | 2R2 |
| LVF303015-3R3□-N | 3.3 | 20, 30 | 1 | 0.125 | 1.9(1.71) | 1.80(1.62) | 3R3 |
| LVF303015-4R7□-N | 4.7 | 20, 30 | 1 | 0.170 | 1.58(1.42) | 1.52(1.36) | 4R7 |
| LVF303015-6R8□-N | 6.8 | 20, 30 | 1 | 0.235 | 1.34(1.20) | 1.30(1.17) | 6R8 |
| LVF303015-100□-N | 10 | 20, 30 | 1 | 0.360 | 1.06(0.95) | 1.00(0.90) | 100 |
| LVF303015-150□-N | 15 | 20, 30 | 1 | 0.550 | 0.90(0.81) | 0.80(0.72) | 150 |
| LVF303015-220□-N | 22 | 20, 30 | 1 | 0.770 | 0.76(0.68) | 0.65(0.58) | 220 |
| LVF303015-330□-N | 33 | 20, 30 | 1 | 0.930 | 0.65(0.58) | 0.60(0.54) | 330 |
| LVF303015-470□-N | 47 | 20, 30 | 1 | 1.500 | 0.52(0.46) | 0.42(0.37) | 470 |
| LVF303015-101□-N | 100 | 20, 30 | 1 | 2.700 | 0.36(0.32) | 0.3(0.27) | 101 |

Note: When ordering, please specify tolerance code. Tolerance: M=±20% , T =±30%

- Operating temperature range - 55°C ~ 125°C(Including self - temperature rise)
- Isat for Inductance drop 30% from its value without current
- Irms for a 40°C temperature rise from 25°C ambient with current
- Measure Equipment :
 L : Agilent HP4287A+Agilent HP16197A, 1MHz 200mV
 RDC : DIGITAL MILLINHM METER CHROMA 16502, or equivalent
 Isat & Irms : Agilent HP4284A

Test Instruments : HP4284A Material/Impedance Analyzer



Please be sure to request approval specifications that provide further details of the products. Kindly note that the content of these specifications are subject to change or may be discontinued without advance notice. Please contact our sales department before ordering.

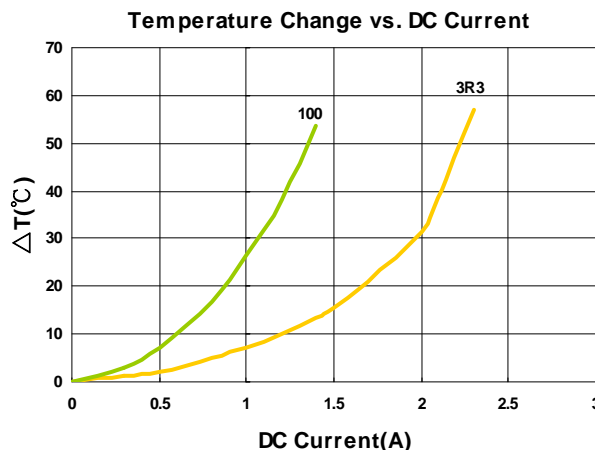
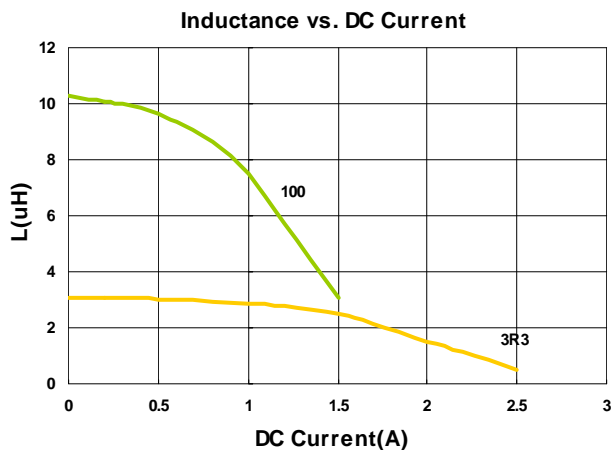
Electrical Characteristics

| Part Number | Inductance (uH) | Tolerance (±%) | Test Frequency (MHz) | RDC (Ω) ±30% | Isat (A) Typ. (Max) | Irms (A) Typ. (Max) | Marking |
|------------------|-----------------|----------------|----------------------|--------------|---------------------|---------------------|---------|
| LVF404012-3R3□-N | 3.3 | 20, 30 | 1 | 0.072 | 1.52(1.36) | 2.10(1.89) | 3R3 |
| LVF404012-100□-N | 10 | 20, 30 | 1 | 0.190 | 0.90(0.81) | 1.20(1.08) | 100 |

Note: When ordering, please specify tolerance code. Tolerance: M=±20% , T =±30%

- Operating temperature range - 55°C ~ 125°C(Including self - temperature rise)
- Isat for Inductance drop 30% from its value without current
- I rms for a 40°C temperature rise from 25°C ambient with current
- Measure Equipment :
 - L : Agilent HP4284A+Agilent HP42841A.1MHz 200mV
 - RDC : DIGITAL MILLINHM METER CHROMA 16502, or equivalent
 - Isat & I rms : Agilent HP4284A

Test Instruments : HP4284A Material/Impedance Analyzer



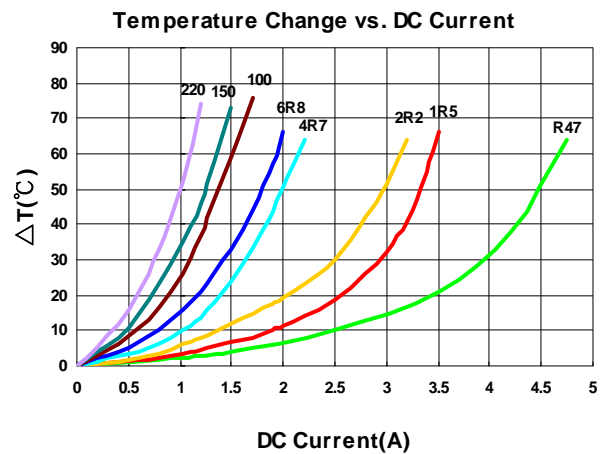
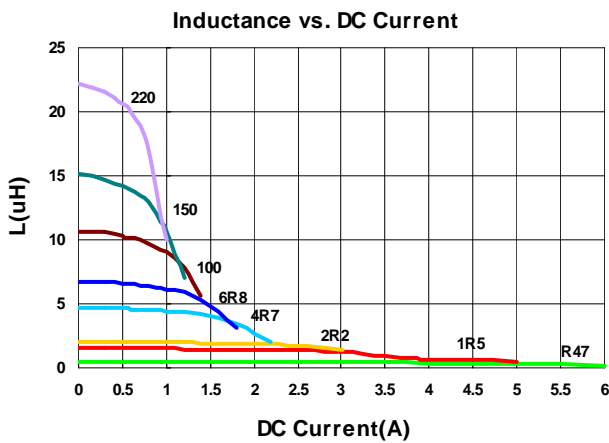
Electrical Characteristics

| Part Number | Inductance (uH) | Tolerance (±%) | Test Frequency (MHz) | RDC (Ω) ±30% | Isat (A) Typ. (Max) | Irms (A) Typ. (Max) | Marking |
|------------------|-----------------|----------------|----------------------|--------------|---------------------|---------------------|---------|
| LVF404015-R47□-N | 0.47 | 20, 30 | 1 | 0.019 | 4.00(3.60) | 4.20(3.78) | R47 |
| LVF404015-1R5□-N | 1.5 | 20, 30 | 1 | 0.041 | 3.00(2.70) | 3.2(2.88) | 1R5 |
| LVF404015-2R2□-N | 2.2 | 20, 30 | 1 | 0.054 | 2.30(2.07) | 2.60(2.34) | 2R2 |
| LVF404015-4R7□-N | 4.7 | 20, 30 | 1 | 0.100 | 1.60(1.44) | 1.80(1.62) | 4R7 |
| LVF404015-6R8□-N | 6.8 | 20, 30 | 1 | 0.138 | 1.40(1.26) | 1.60(1.44) | 6R8 |
| LVF404015-100□-N | 10 | 20, 30 | 1 | 0.200 | 1.00(0.90) | 1.20(1.08) | 100 |
| LVF404015-150□-N | 15 | 20, 30 | 1 | 0.300 | 0.92(0.82) | 1.05(0.94) | 150 |
| LVF404015-220□-N | 22 | 20, 30 | 1 | 0.400 | 0.72(0.64) | 0.85(0.76) | 220 |

Note: When ordering, please specify tolerance code. Tolerance: M=±20% , T =±30%

- Operating temperature range - 55°C ~ 125°C(Including self - temperature rise)
- Isat for Inductance drop 30% from its value without current
- I rms for a 40°C temperature rise from 25°C ambient with current
- Measure Equipment :
 L : Agilent HP4284A+Agilent HP42841A.1MHz 200mV
 RDC : DIGITAL MILLINHM METER CHROMA 16502, or equivalent
 Isat & I rms : Agilent HP4284A

Test Instruments : HP4284A Material/Impedance Analyzer



Please be sure to request approval specifications that provide further details of the products. Kindly note that the content of these specifications are subject to change or may be discontinued without advance notice. Please contact our sales department before ordering.

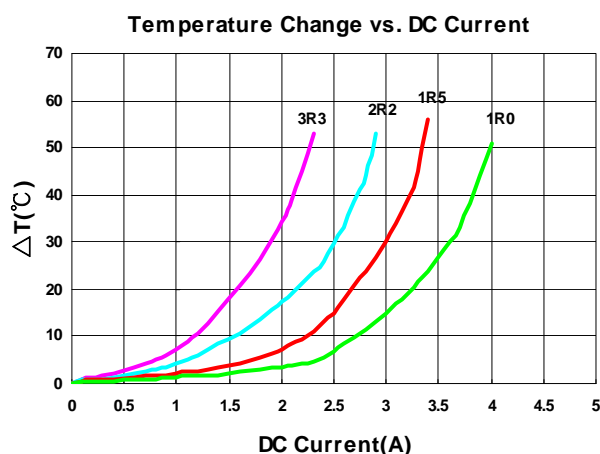
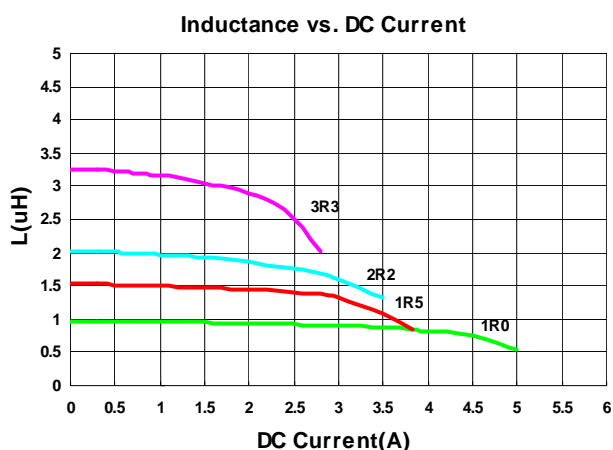
Electrical Characteristics

| Part Number | Inductance (uH) | Tolerance (±%) | Test Frequency (kHz) | RDC (Ω) ±30% | Isat (A) Typ. (Max) | Irms (A) Typ. (Max) | Marking |
|------------------|-----------------|----------------|----------------------|--------------|---------------------|---------------------|---------|
| LVF404018-1R0□-N | 1.0 | 20, 30 | 100 | 0.0265 | 4.2(3.78) | 3.8(3.42) | 1R0 |
| LVF404018-1R5□-N | 1.5 | 20, 30 | 100 | 0.0370 | 3.5(3.15) | 3.2(2.88) | 1R5 |
| LVF404018-2R2□-N | 2.2 | 20, 30 | 100 | 0.0470 | 3.0(2.70) | 2.7(2.43) | 2R2 |
| LVF404018-3R3□-N | 3.3 | 20, 30 | 100 | 0.0625 | 2.3(2.07) | 2.1(1.89) | 3R3 |

Note: When ordering, please specify tolerance code. Tolerance: M=±20%, T=±30%

- Operating temperature range - 55°C ~ 125°C(Including self - temperature rise)
- Isat for Inductance drop 30% from its value without current
- Irms for a 40°C temperature rise from 25°C ambient with current
- Measure Equipment :
 L : Agilent HP4284A+Agilent HP42841A, 100kHz 1V
 RDC : DIGITAL MILLINHM METER CHROMA 16502, or equivalent
 Isat & Irms : Agilent HP4284A

Test Instruments : HP4284A Material/Impedance Analyzer



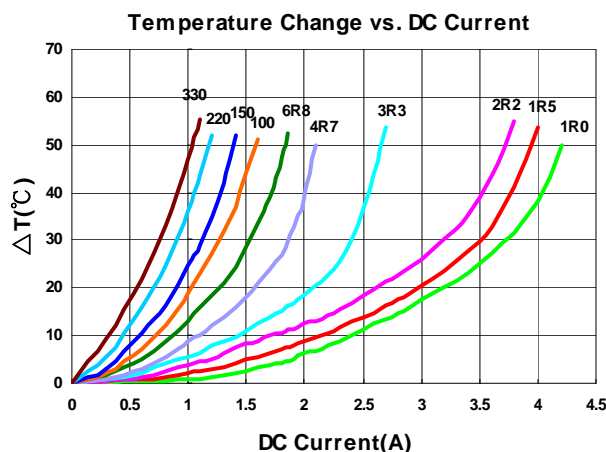
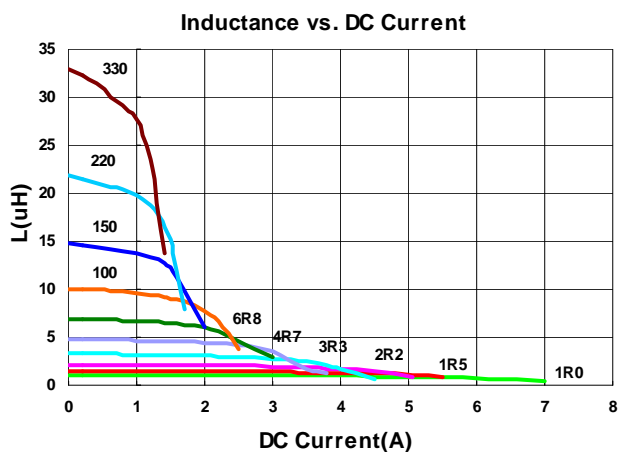
Electrical Characteristics

| Part Number | Inductance (uH) | Tolerance (±%) | Test Frequency (kHz) | RDC (Ω) ±30% | Isat (A) Typ. (Max) | Irms (A) Typ. (Max) | Marking |
|------------------|-----------------|----------------|----------------------|--------------|---------------------|---------------------|---------|
| LVF404026-1R0□-N | 1.0 | 20, 30 | 100 | 0.030 | 5.00(4.50) | 4.00(3.60) | 1R0 |
| LVF404026-1R5□-N | 1.5 | 20, 30 | 100 | 0.035 | 4.20(3.78) | 3.70(3.33) | 1R5 |
| LVF404026-2R2□-N | 2.2 | 20, 30 | 100 | 0.045 | 3.80(3.42) | 3.50(3.15) | 2R2 |
| LVF404026-3R3□-N | 3.3 | 20, 30 | 100 | 0.067 | 3.00(2.70) | 2.50(2.25) | 3R3 |
| LVF404026-4R7□-N | 4.7 | 20, 30 | 100 | 0.092 | 2.60(2.34) | 2.00(1.80) | 4R7 |
| LVF404026-5R6□-N | 5.6 | 20, 30 | 100 | 0.110 | 2.30(2.07) | 1.90(1.71) | 5R6 |
| LVF404026-6R8□-N | 6.8 | 20, 30 | 100 | 0.130 | 2.00(1.80) | 1.70(1.53) | 6R8 |
| LVF404026-100□-N | 10 | 20, 30 | 100 | 0.188 | 1.90(1.71) | 1.40(1.26) | 100 |
| LVF404026-150□-N | 15 | 20, 30 | 100 | 0.240 | 1.45(1.30) | 1.20(1.08) | 150 |
| LVF404026-220□-N | 22 | 20, 30 | 100 | 0.330 | 1.22(1.09) | 1.00(0.90) | 220 |
| LVF404026-330□-N | 33 | 20, 30 | 100 | 0.480 | 1.00(0.90) | 0.82(0.73) | 330 |
| LVF404026-101□-N | 100 | 20, 30 | 100 | 1.380 | 0.58(0.52) | 0.50(0.45) | 101 |
| LVF404026-331□-N | 330 | 20, 30 | 100 | 4.600 | 0.31(0.27) | 0.25(0.22) | 331 |

Note: When ordering, please specify tolerance code. Tolerance: M=±20% , T =±30%

- Operating temperature range - 55°C ~ 125°C(Including self - temperature rise)
- Isat for Inductance drop 30% from its value without current
- Irms for a 40°C temperature rise from 25°C ambient with current
- Measure Equipment :
- L : Agilent HP4284A+Agilent HP42841A, 100kHz 1V
RDC : DIGITAL MILLINHM METER CHROMA 16502, or equivalent
Isat & Irms : Agilent HP4284A

Test Instruments : HP4284A Material/Impedance Analyzer



Please be sure to request approval specifications that provide further details of the products. Kindly note that the content of these specifications are subject to change or may be discontinued without advance notice. Please contact our sales department before ordering.

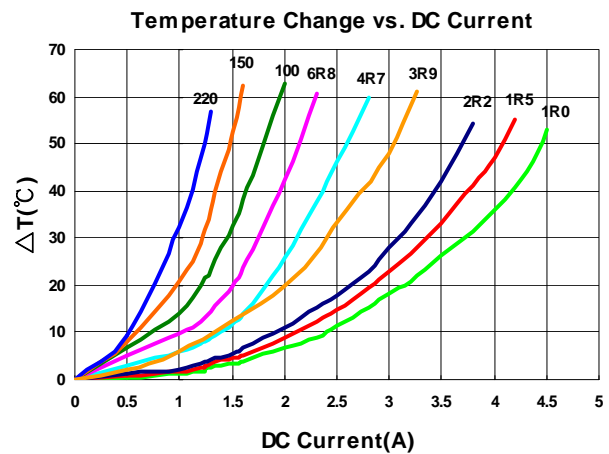
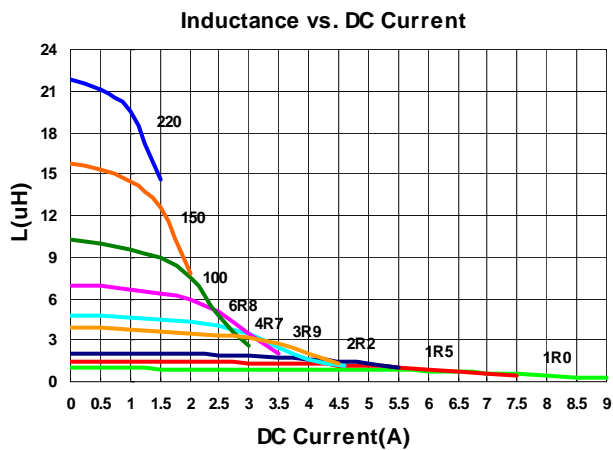
Electrical Characteristics

| Part Number | Inductance (uH) | Tolerance (±%) | Test Frequency (kHz) | RDC (Ω) ±30% | Isat (A) Typ. (Max) | Irms (A) Typ. (Max) | Marking |
|------------------|-----------------|----------------|----------------------|--------------|---------------------|---------------------|---------|
| LVF505020-1R0□-N | 1.0 | 20, 30 | 100 | 0.018 | 6.0(5.40) | 4.1(3.69) | 1R0 |
| LVF505020-1R5□-N | 1.5 | 20, 30 | 100 | 0.023 | 4.9(4.41) | 3.5(3.15) | 1R5 |
| LVF505020-1R8□-N | 1.8 | 20, 30 | 100 | 0.026 | 4.1(3.60) | 3.4(3.00) | 1R8 |
| LVF505020-2R2□-N | 2.2 | 20, 30 | 100 | 0.030 | 4.0(3.60) | 3.3(2.97) | 2R2 |
| LVF505020-3R6□-N | 3.6 | 20, 30 | 100 | 0.050 | 3.1(2.70) | 2.7(2.40) | 3R6 |
| LVF505020-3R9□-N | 3.9 | 20, 30 | 100 | 0.053 | 2.9(2.61) | 2.6(2.34) | 3R9 |
| LVF505020-4R7□-N | 4.7 | 20, 30 | 100 | 0.060 | 2.7(2.43) | 2.2(1.98) | 4R7 |
| LVF505020-6R8□-N | 6.8 | 20, 30 | 100 | 0.093 | 2.2(1.98) | 1.8(1.62) | 6R8 |
| LVF505020-100□-N | 10 | 20, 30 | 100 | 0.125 | 1.8(1.62) | 1.6(1.44) | 100 |
| LVF505020-150□-N | 15 | 20, 30 | 100 | 0.195 | 1.4(1.26) | 1.2(1.08) | 150 |
| LVF505020-220□-N | 22 | 20, 30 | 100 | 0.265 | 1.2(1.08) | 1.0(0.90) | 220 |

Note: When ordering, please specify tolerance code. Tolerance: M=±20% , T =±30%

- Operating temperature range - 55°C ~ 125°C(Including self - temperature rise)
- Isat for Inductance drop 30% from its value without current
- I rms for a 40°C temperature rise from 25°C ambient with current
- Measure Equipment :
- L : Agilent HP4284A+Agilent HP42841A, 100kHz 1V
- RDC : DIGITAL MILLINHM METER CHROMA 16502, or equivalent
- Isat & I rms : Agilent HP4284A

Test Instruments : HP4284A Material/Impedance Analyzer



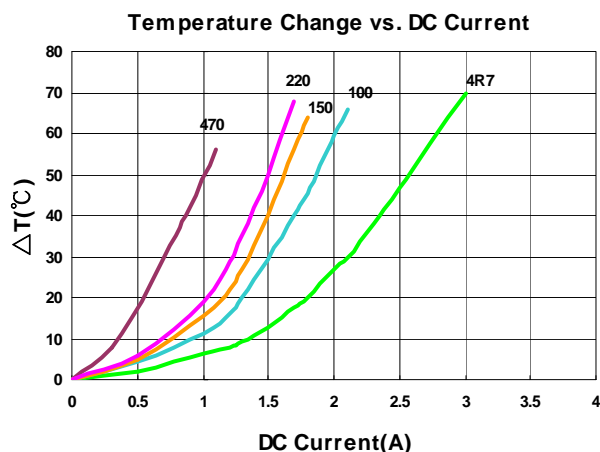
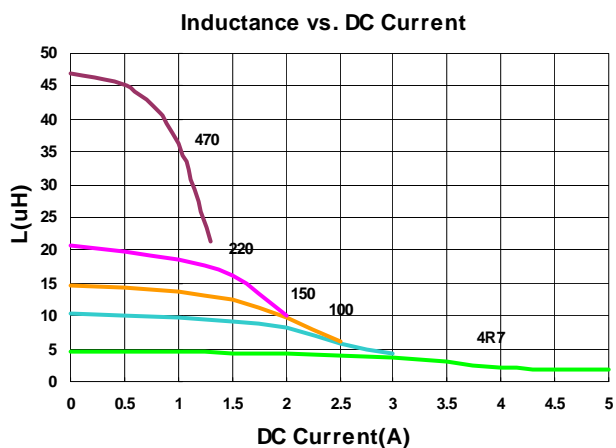
Electrical Characteristics

| Part Number | Inductance (uH) | Tolerance (±%) | Test Frequency (kHz) | RDC (Ω) ±30% | Isat (A) Typ. (Max) | Irms (A) Typ. (Max) | Marking |
|------------------|-----------------|----------------|----------------------|--------------|---------------------|---------------------|---------|
| LVF606020-4R7□-N | 4.7 | 20, 30 | 100 | 0.058 | 3.0(2.70) | 2.3(2.07) | 4R7 |
| LVF606020-100□-N | 10 | 20, 30 | 100 | 0.130 | 2.1(1.89) | 1.6(1.44) | 100 |
| LVF606020-150□-N | 15 | 20, 30 | 100 | 0.195 | 1.6(1.44) | 1.3(1.17) | 150 |
| LVF606020-220□-N | 22 | 20, 30 | 100 | 0.260 | 1.3(1.17) | 1.1(0.99) | 220 |
| LVF606020-470□-N | 47 | 20, 30 | 100 | 0.510 | 0.9(0.80) | 0.8(0.72) | 470 |

Note: When ordering, please specify tolerance code. Tolerance: M=±20% , T =±30%

- Operating temperature range - 55°C ~ 125°C(Including self - temperature rise)
- Isat for Inductance drop 30% from its value without current
- I rms for a 40°C temperature rise from 25°C ambient with current
- Measure Equipment :
- L : Agilent HP4284A+Agilent HP42841A, 100kHz 1V
RDC : DIGITAL MILLINHM METER CHROMA 16502, or equivalent
Isat & I rms : Agilent HP4284A

Test Instruments : HP4284A Material/Impedance Analyzer



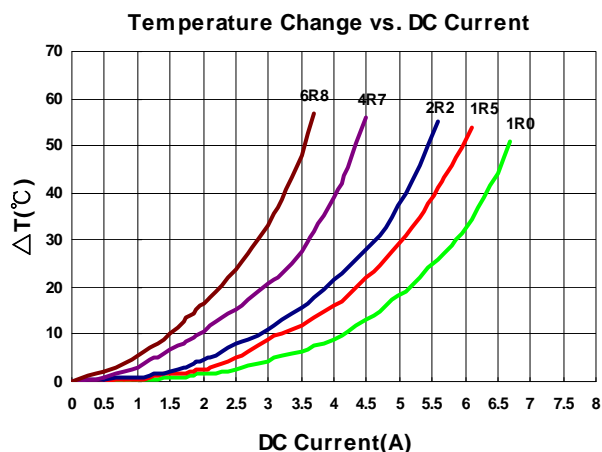
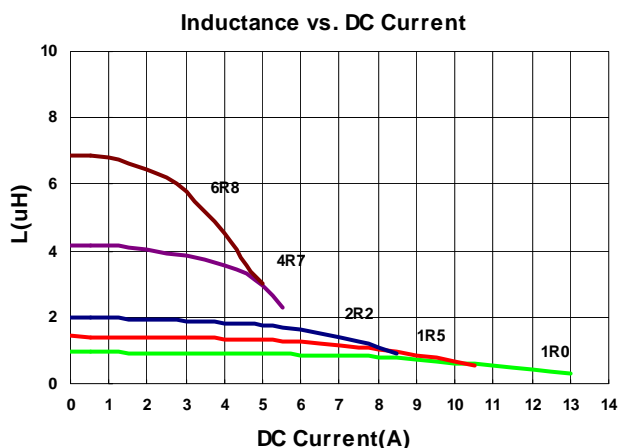
Electrical Characteristics

| Part Number | Inductance (uH) | Tolerance (±%) | Test Frequency (kHz) | RDC (Ω) ±30% | Isat (A) Typ. (Max) | Irms (A) Typ. (Max) | Marking |
|------------------|-----------------|----------------|----------------------|--------------|---------------------|---------------------|---------|
| LVF606028-1R0□-N | 1.0 | 20, 30 | 100 | 0.012 | 7.9(7.11) | 6.3(5.67) | 1R0 |
| LVF606028-1R5□-N | 1.5 | 20, 30 | 100 | 0.015 | 7.0(6.30) | 5.5(4.95) | 1R5 |
| LVF606028-2R2□-N | 2.2 | 20, 30 | 100 | 0.020 | 6.0(5.40) | 5.0(4.50) | 2R2 |
| LVF606028-4R7□-N | 4.7 | 20, 30 | 100 | 0.036 | 4.0(3.60) | 3.4(3.06) | 4R7 |
| LVF606028-6R8□-N | 6.8 | 20, 30 | 100 | 0.048 | 3.2(2.88) | 3.0(2.70) | 6R8 |

Note: When ordering, please specify tolerance code. Tolerance: M=±20% , T =±30%

- Operating temperature range - 55°C ~ 125°C(Including self - temperature rise)
- Isat for Inductance drop 30% from its value without current
- I rms for a 40°C temperature rise from 25°C ambient with current
- Measure Equipment :
- L : Agilent HP4284A+Agilent HP42841A, 100kHz 1V
RDC : DIGITAL MILLINHM METER CHROMA 16502, or equivalent
Isat & I rms : Agilent HP4284A

Test Instruments : HP4284A Material/Impedance Analyzer



Please be sure to request approval specifications that provide further details of the products. Kindly note that the content of these specifications are subject to change or may be discontinued without advance notice. Please contact our sales department before ordering.

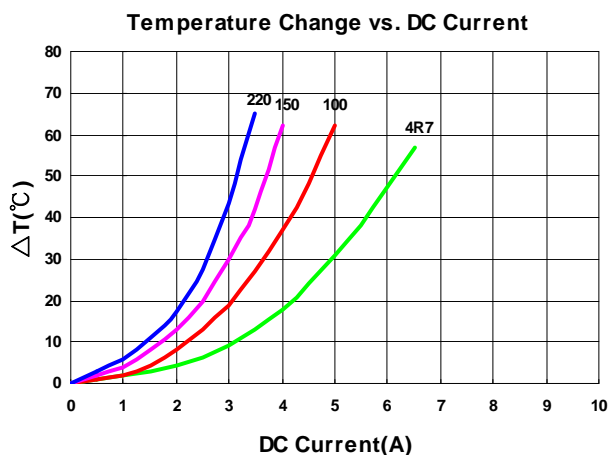
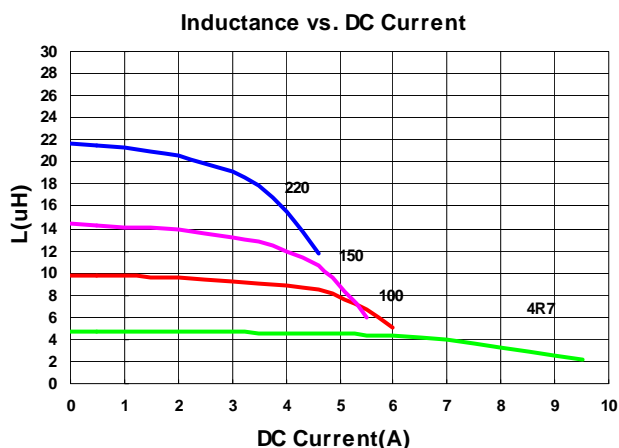
Electrical Characteristics

| Part Number | Inductance (uH) | Tolerance (±%) | Test Frequency (kHz) | RDC (Ω) ±30% | Isat (A) Typ. (Max) | Irms (A) Typ. (Max) | Marking |
|------------------|-----------------|----------------|----------------------|--------------|---------------------|---------------------|---------|
| LVF808040-4R7□-N | 4.7 | 20, 30 | 100 | 0.020 | 6.8(6.12) | 5.5(4.95) | 4R7 |
| LVF808040-100□-N | 10 | 20, 30 | 100 | 0.038 | 5.0(4.50) | 3.8(3.42) | 100 |
| LVF808040-150□-N | 15 | 20, 30 | 100 | 0.057 | 4.0(3.60) | 3.2(2.88) | 150 |
| LVF808040-220□-N | 22 | 20, 30 | 100 | 0.082 | 3.4(3.06) | 2.7(2.43) | 220 |

Note: When ordering, please specify tolerance code. Tolerance: M=±20%, T=±30%

- Operating temperature range - 55°C ~ 125°C(Including self - temperature rise)
- Isat for Inductance drop 30% from its value without current
- Irms for a 40°C temperature rise from 25°C ambient with current
- Measure Equipment :
- L : Agilent HP4284A+Agilent HP42841A, 100kHz 1V
- RDC : DIGITAL MILLINHM METER CHROMA 16502, or equivalent
- Isat & Irms : Agilent HP4284A

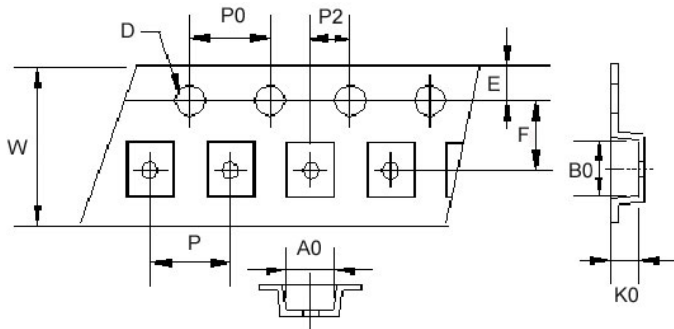
Test Instruments : HP4284A Material/Impedance Analyzer



Packaging Specifications

Tape Dimensions

Figure 1



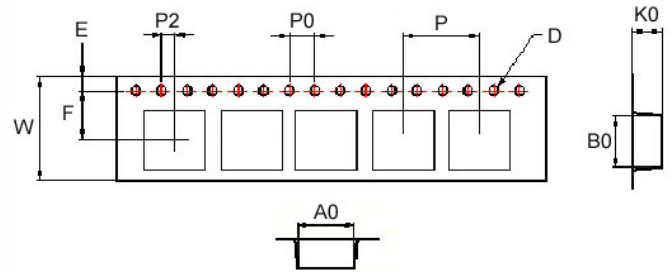
Reel Dimensions

Figure 1



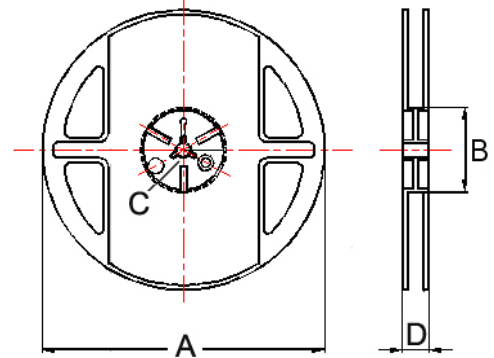
Tape Dimensions

Figure 2



Reel Dimensions

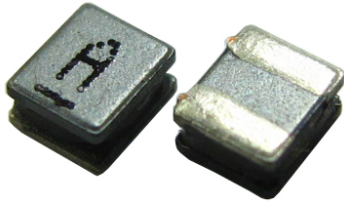
Figure 2



Dimensions in mm

| TYPE | Fig | Tape Dimensions | | | | | | | | | | Reel Dimensions | | | | | Quantity PCS / Reel |
|-----------|-----|-----------------|------|------|------|------|-----|-----|----|----|----|-----------------|-----|----|------|-----|------------------------|
| | | A0 | B0 | K0 | D | E | F | W | P | P0 | P2 | A | B | C | D | E | |
| LVF201B12 | 1 | 1.90 | 2.20 | 1.30 | 1.55 | 1.75 | 3.5 | 8.1 | 4 | 4 | 2 | 180 | 60 | 13 | 14.4 | 8.4 | 2000 |
| LVF252A10 | 1 | 2.40 | 2.70 | 1.15 | 1.55 | 1.75 | 3.5 | 8.1 | 4 | 4 | 2 | 180 | 60 | 13 | 14.4 | 8.4 | 2000 |
| LVF252A12 | 1 | 2.40 | 2.70 | 1.35 | 1.55 | 1.75 | 3.5 | 8.1 | 4 | 4 | 2 | 180 | 60 | 13 | 14.4 | 8.4 | 2000 |
| LVF303010 | 1 | 3.20 | 3.20 | 1.40 | 1.55 | 1.75 | 3.5 | 8.1 | 4 | 4 | 2 | 180 | 60 | 13 | 14.4 | 8.4 | 2000 |
| LVF303012 | 1 | 3.20 | 3.20 | 1.40 | 1.55 | 1.75 | 3.5 | 8.1 | 4 | 4 | 2 | 180 | 60 | 13 | 14.4 | 8.4 | 2000 |
| LVF303015 | 1 | 3.15 | 3.15 | 1.60 | 1.55 | 1.75 | 3.5 | 8.1 | 4 | 4 | 2 | 180 | 60 | 13 | 14.4 | 8.4 | 2000 |
| LVF404012 | 2 | 4.25 | 4.25 | 1.30 | 1.55 | 1.75 | 5.5 | 12 | 8 | 4 | 2 | 178 | 60 | 13 | 13.2 | - | 1000 |
| LVF404015 | 2 | 4.25 | 4.25 | 1.70 | 1.55 | 1.75 | 5.5 | 12 | 8 | 4 | 2 | 178 | 60 | 13 | 13.2 | - | 1000 |
| LVF404018 | 2 | 4.25 | 4.25 | 2.10 | 1.55 | 1.75 | 5.5 | 12 | 8 | 4 | 2 | 178 | 60 | 13 | 13.2 | - | 800 |
| LVF404026 | 2 | 4.25 | 4.25 | 3.00 | 1.55 | 1.75 | 5.5 | 12 | 8 | 4 | 2 | 178 | 60 | 13 | 13.2 | - | 500 |
| LVF505020 | 2 | 5.25 | 5.25 | 2.20 | 1.55 | 1.75 | 5.5 | 12 | 8 | 4 | 2 | 330 | 100 | 13 | 13.4 | - | 2000 |
| LVF606020 | 2 | 6.25 | 6.25 | 2.20 | 1.55 | 1.75 | 7.5 | 16 | 12 | 4 | 2 | 330 | 100 | 13 | 16.0 | - | 2000 |
| LVF606028 | 2 | 6.25 | 6.25 | 3.00 | 1.55 | 1.75 | 7.5 | 16 | 12 | 4 | 2 | 330 | 100 | 13 | 16.0 | - | 1500 |
| LVF808040 | 2 | 8.25 | 8.25 | 4.15 | 1.55 | 1.75 | 7.5 | 16 | 12 | 4 | 2 | 330 | 100 | 13 | 16.0 | - | 1000 |

LVT Series



LVT series, an automatic assembly constructed power inductor, is shielded with magnetic resin and suitable for portable DC-DC converter applications.

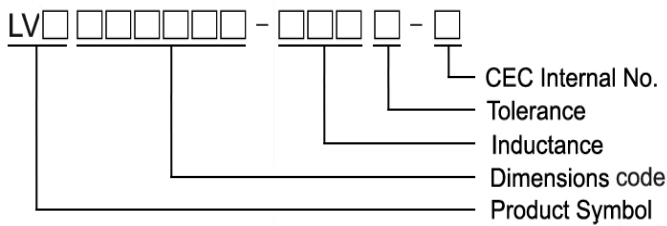
Features

- RoHS, Halogen Free and REACH Compliance
- Shielded with magnetic resin
- Various package size and wide inductance range
- Optimize electrical characteristics by using different ferrite core figures

Applications

- Smartphones, tablets and wearable devices
- DSC, camcorders
- AP Routers
- STBs
- LCD TVs, monitors and panels
- Game consoles
- DC/DC converters

Product Identification



Shape and Dimensions

Figure 1

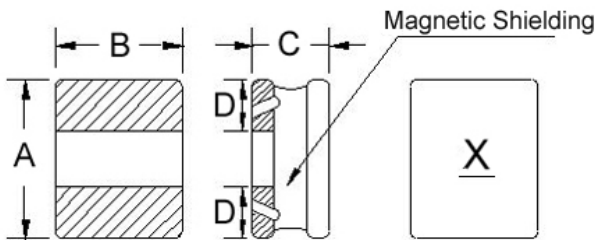
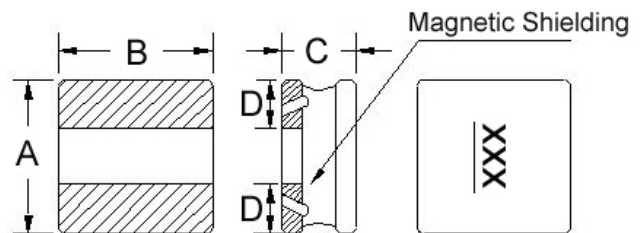


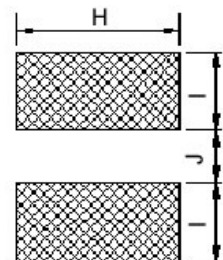
Figure 2



Recommended Pattern

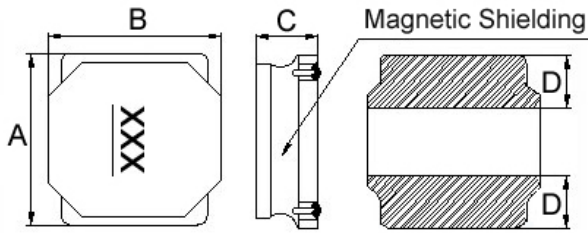
Dimensions in mm

| TYPE | FIG | A | B | C | D | H | I | J |
|-----------|-----|----------|----------|----------|-----|-----|------|-----|
| LVT201B10 | 1 | 2.0±0.25 | 1.6±0.25 | 1.02 Max | 0.6 | 1.8 | 0.80 | 0.8 |
| LVT252A10 | 1 | 2.5±0.25 | 2.0±0.25 | 1.02 Max | 0.8 | 2.2 | 0.85 | 0.8 |
| LVT252A12 | 1 | 2.5±0.25 | 2.0±0.25 | 1.2±0.05 | 0.8 | 2.2 | 0.85 | 0.8 |
| LVT303010 | 2 | 3.0±0.20 | 3.0±0.20 | 1.02 Max | 1.0 | 3.2 | 1.1 | 1.0 |
| LVT303012 | 2 | 3.0±0.20 | 3.0±0.20 | 1.20 Max | 1.0 | 3.2 | 1.1 | 1.0 |
| LVT404012 | 2 | 4.0±0.20 | 4.0±0.20 | 1.2±0.1 | 1.5 | 4.2 | 1.5 | 1.2 |



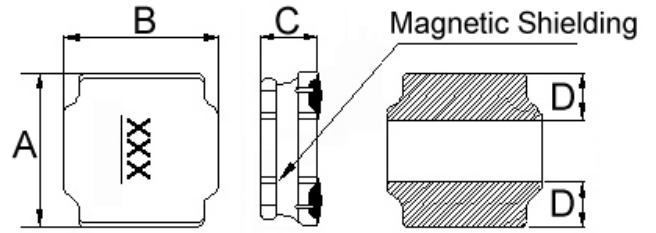
Shape and Dimensions

Figure 3



Recommended Pattern

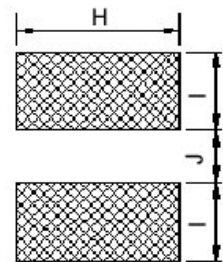
Figure 4



Dimensions in mm

| TYPE | FIG | A | B | C | D | H | I | J |
|-----------|-----|----------|----------|--------------------------------------|---------|-----|-----|-----|
| LVT404015 | 3 | 4.0±0.25 | 4.0±0.25 | 1.5±0.2 | 1.3 | 3.7 | 1.5 | 1.2 |
| LVT404026 | 3 | 4.0±0.20 | 4.0±0.25 | 2.6±0.2 | 1.4 | 3.7 | 1.2 | 1.6 |
| LVT505020 | 4 | 5.0±0.2 | 5.0±0.2 | 2.0±0.2 | 1.8±0.3 | 4.2 | 1.6 | 2.0 |
| LVT606020 | 4 | 6.0±0.2 | 6.0±0.2 | 2.0±0.2 | 1.7±0.3 | 5.7 | 1.7 | 2.8 |
| LVT808040 | 4 | 8.0±0.2 | 8.0±0.2 | 4.0 ^{+0.2} _{-0.30} | 2.3±0.3 | 7.5 | 2.5 | 3.4 |

Recommended Pattern



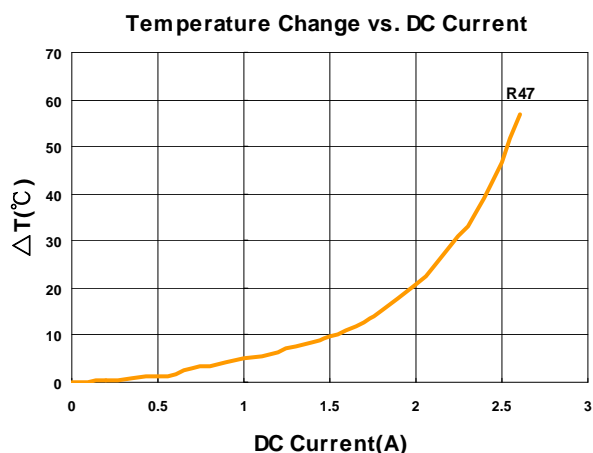
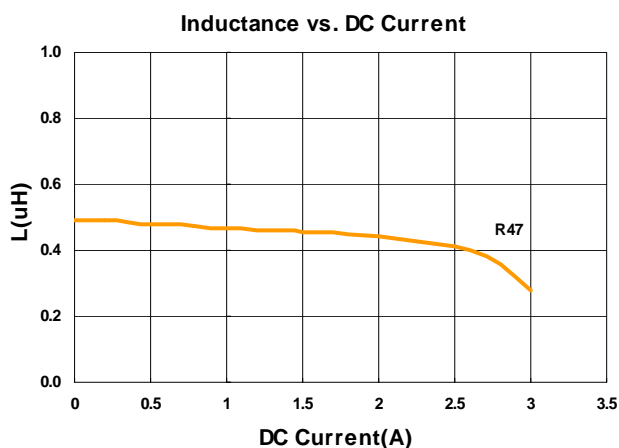
Electrical Characteristics

| Part Number | Inductance (uH) | Tolerance (±%) | Test Frequency (MHz) | RDC (mΩ) ±30% | Isat (A) Typ. (Max) | Irms (A) Typ. (Max) | Marking |
|------------------|-----------------|----------------|----------------------|---------------|---------------------|---------------------|---------|
| LVT201B10-R47□-N | 0.47 | 20, 30 | 1 | 72 | 2.4(2.16) | 2.4(2.16) | A |

Note: When ordering, please specify tolerance code. Tolerance: M=±20% , T =±30%

- Operating temperature range - 55°C ~ 125°C(Including self - temperature rise)
- Isat for Inductance drop 30% from its value without current
- I rms for a 40°C temperature rise from 25°C ambient with current
- Measure Equipment :
- L : Agilent HP4287A+Agilent HP16197A, 1MHz 200mV
- RDC : DIGITAL MILLINHM METER CHROMA 16502, or equivalent
- Isat & I rms : Agilent HP4284A

Test Instruments : HP4284A Material/Impedance Analyzer



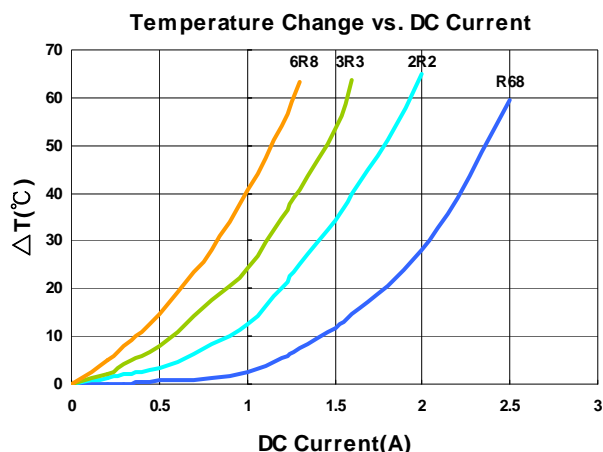
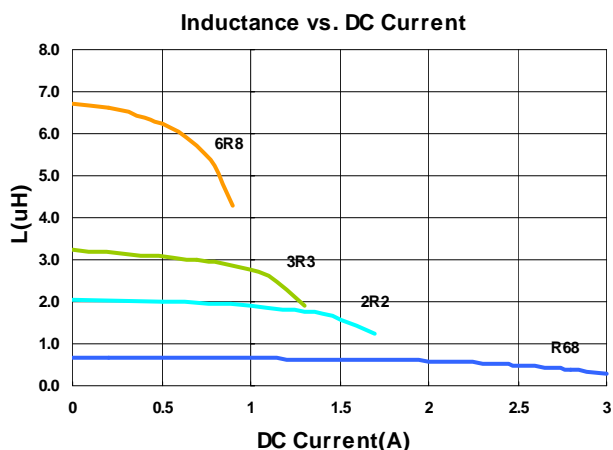
Electrical Characteristics

| Part Number | Inductance (uH) | Tolerance (±%) | Test Frequency (MHz) | RDC (Ω) ±30% | Isat (A) Typ. (Max) | Irms (A) Typ. (Max) | Marking |
|------------------|-----------------|----------------|----------------------|--------------|---------------------|---------------------|---------|
| LVT252A10-R68□-N | 0.68 | 20, 30 | 1 | 0.050 | 2.40(2.160) | 2.20(1.980) | K |
| LVT252A10-2R2□-N | 2.2 | 20, 30 | 1 | 0.135 | 1.42(1.270) | 1.55(1.390) | D |
| LVT252A10-3R3□-N | 3.3 | 20, 30 | 1 | 0.220 | 1.12(1.000) | 1.20(1.080) | E |
| LVT252A10-6R8□-N | 6.8 | 20, 30 | 1 | 0.435 | 0.78(0.700) | 0.84(0.750) | G |

Note: When ordering, please specify tolerance code. Tolerance: M=±20% , T =±30%

- Operating temperature range - 55°C ~ 125°C(Including self - temperature rise)
- Isat for Inductance drop 30% from its value without current
- Irms for a 40°C temperature rise from 25°C ambient with current
- Measure Equipment :
- L : Agilent HP4287A+Agilent HP16197A, 1MHz 200mV
- RDC : DIGITAL MILLINHM METER CHROMA 16502, or equivalent
- Isat & Irms : Agilent HP4284A

Test Instruments : HP4284A Material/Impedance Analyzer



Please be sure to request approval specifications that provide further details of the products. Kindly note that the content of these specifications are subject to change or may be discontinued without advance notice. Please contact our sales department before ordering.

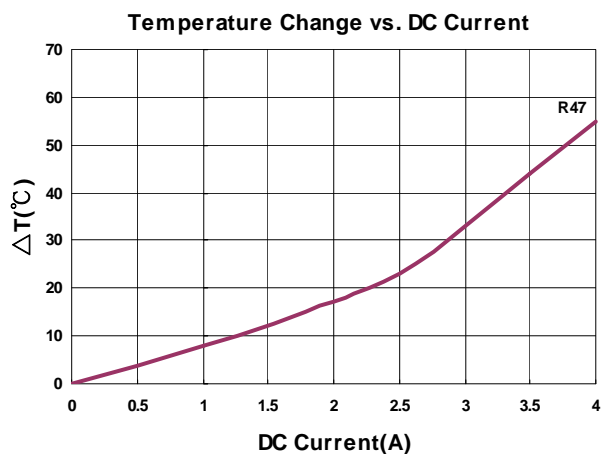
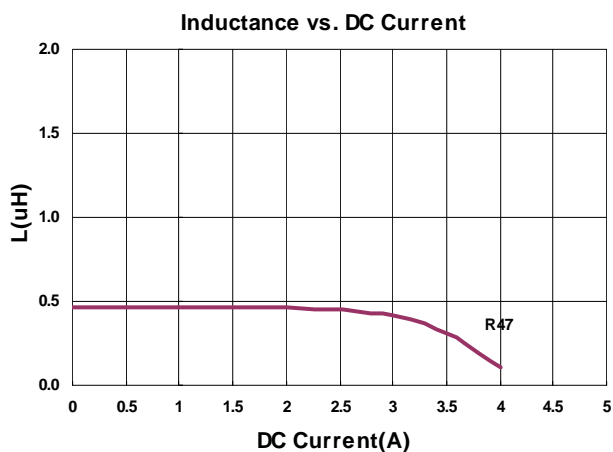
Electrical Characteristics

| Part Number | Inductance (uH) | Tolerance (±%) | Test Frequency (MHz) | RDC (Ω) ±30% | Isat (A) Typ. (Max) | Irms (A) Typ. (Max) | Marking |
|------------------|-----------------|----------------|----------------------|--------------|---------------------|---------------------|---------|
| LVT252A12-R47□-N | 0.47 | 20, 30 | 1 | 0.027 | 3.70(3.330) | 3.10(2.790) | A |

Note: When ordering, please specify tolerance code. Tolerance: M=±20% , T =±30%

- Operating temperature range - 55°C ~ 125°C(Including self - temperature rise)
- Isat for Inductance drop 30% from its value without current
- Irms for a 40°C temperature rise from 25°C ambient with current
- Measure Equipment :
- L : Agilent HP4287A+Agilent HP16197A, 1MHz 200mV
 RDC : DIGITAL MILLINHM METER CHROMA 16502, or equivalent
 Isat & Irms : Agilent HP4284A

Test Instruments : HP4284A Material/Impedance Analyzer



Please be sure to request approval specifications that provide further details of the products. Kindly note that the content of these specifications are subject to change or may be discontinued without advance notice. Please contact our sales department before ordering.

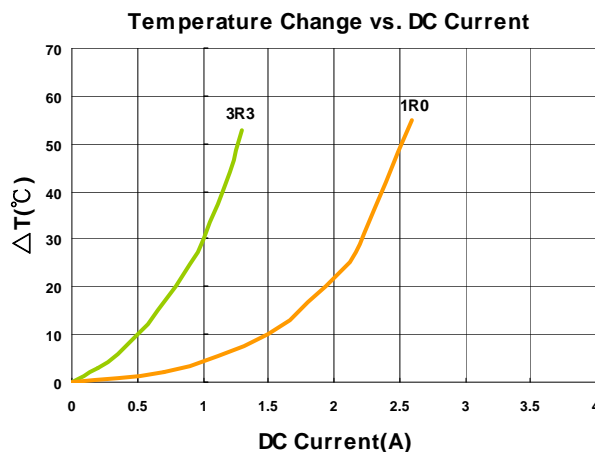
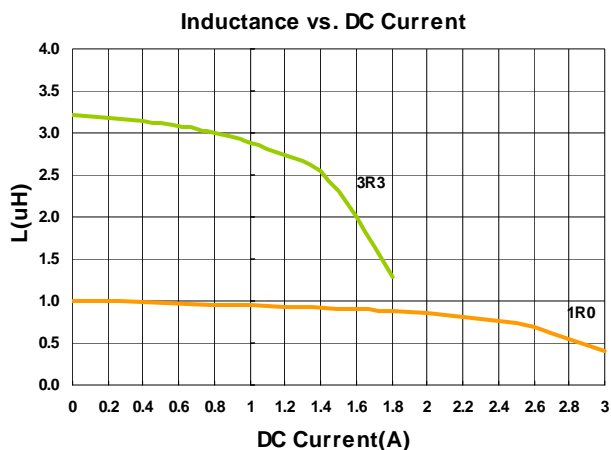
Electrical Characteristics

| Part Number | Inductance (uH) | Tolerance (±%) | Test Frequency (MHz) | RDC (Ω) ±30% | Isat (A) Typ. (Max) | Irms (A) Typ. (Max) | Marking |
|------------------|-----------------|----------------|----------------------|--------------|---------------------|---------------------|---------|
| LVT303010-1R0□-N | 1.0 | 20, 30 | 1 | 0.063 | 2.4(2.16) | 2.3(2.07) | 1R0 |
| LVT303010-3R3□-N | 3.3 | 20, 30 | 1 | 0.165 | 1.2(1.08) | 1.1(0.99) | 3R3 |

Note: When ordering, please specify tolerance code. Tolerance: M=±20% , T =±30%

- Operating temperature range - 55°C ~ 125°C(Including self - temperature rise)
- Isat for Inductance drop 30% from its value without current
- I rms for a 40°C temperature rise from 25°C ambient with current
- Measure Equipment :
- L : Agilent HP4287A+Agilent/HP16197A, 1MHz 200mV
- RDC : DIGITAL MILLINHM METER CHROMA 16502, or equivalent
- Isat & I rms : Agilent HP4284A

Test Instruments : HP4284A Material/Impedance Analyzer



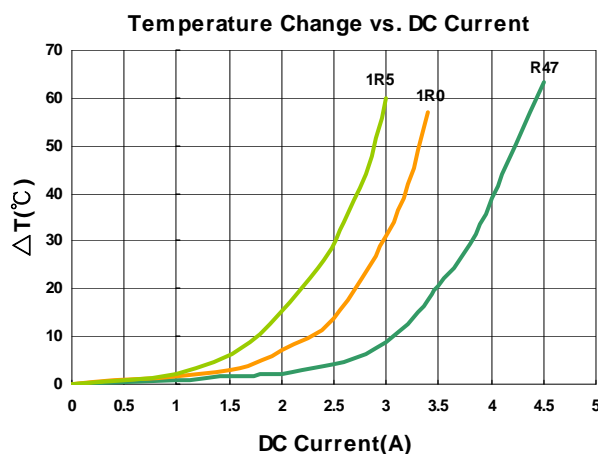
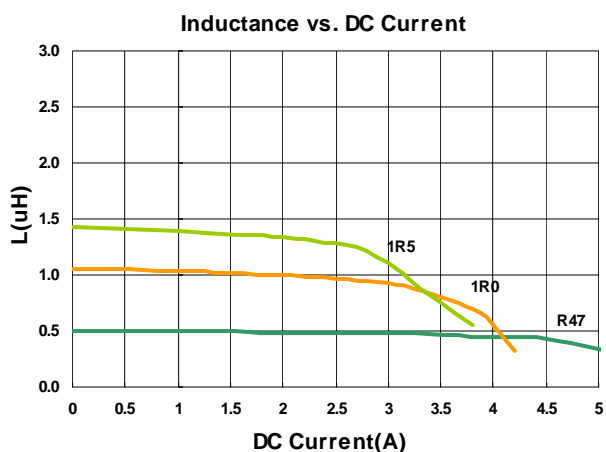
Electrical Characteristics

| Part Number | Inductance (uH) | Tolerance (±%) | Test Frequency (MHz) | RDC (Ω) ±30% | Isat (A) Typ. (Max) | Irms (A) Typ. (Max) | Marking |
|------------------|-----------------|----------------|----------------------|--------------|---------------------|---------------------|---------|
| LVT303012-R47□-N | 0.47 | 20, 30 | 1 | 0.032 | 4.3(3.87) | 4.0(3.60) | R47 |
| LVT303012-1R0□-N | 1.0 | 20, 30 | 1 | 0.060 | 3.1(2.79) | 3.0(2.70) | 1R0 |
| LVT303012-1R5□-N | 1.5 | 20, 30 | 1 | 0.072 | 2.7(2.43) | 2.6(2.34) | 1R5 |

Note: When ordering, please specify tolerance code. Tolerance: M=±20% , T =±30%

- Operating temperature range - 55°C ~ 125°C(Including self - temperature rise)
- Isat for Inductance drop 30% from its value without current
- Irms for a 40°C temperature rise from 25°C ambient with current
- Measure Equipment :
- L : Agilent HP4287A+Agilent HP16197A, 1MHz 200mV
- RDC : DIGITAL MILLINHM METER CHROMA 16502, or equivalent
- Isat & Irms : Agilent HP4284A

Test Instruments : HP4284A Material/Impedance Analyzer



Please be sure to request approval specifications that provide further details of the products. Kindly note that the content of these specifications are subject to change or may be discontinued without advance notice. Please contact our sales department before ordering.

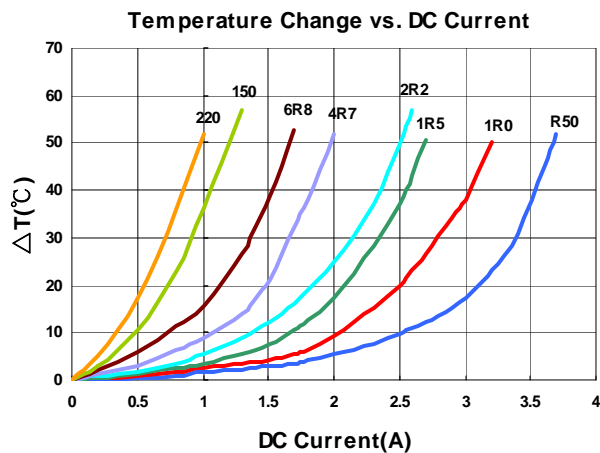
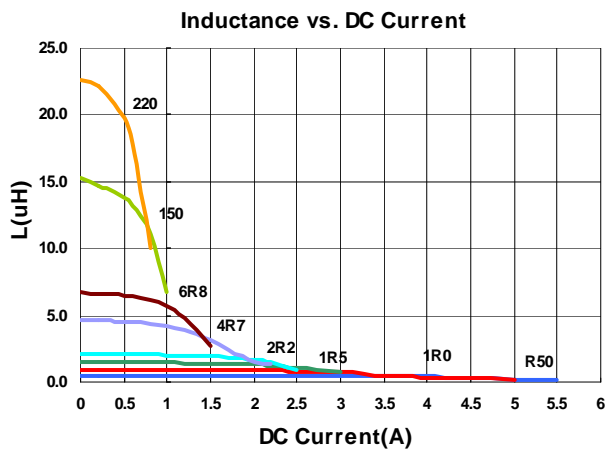
Electrical Characteristics

| Part Number | Inductance (uH) | Tolerance (±%) | Test Frequency (MHz) | RDC (Ω) ±30% | Isat (A) Typ. (Max) | Irms (A) Typ. (Max) | Marking |
|------------------|-----------------|----------------|----------------------|--------------|---------------------|---------------------|---------|
| LVT404012-R50□-N | 0.5 | 20, 30 | 1 | 0.030 | 3.90(3.51) | 3.50(3.15) | R50 |
| LVT404012-1R0□-N | 1.0 | 20, 30 | 1 | 0.040 | 2.90(2.60) | 3.00(2.70) | 1R0 |
| LVT404012-1R5□-N | 1.5 | 20, 30 | 1 | 0.051 | 2.30(2.07) | 2.50(2.25) | 1R5 |
| LVT404012-2R2□-N | 2.2 | 20, 30 | 1 | 0.060 | 1.90(1.71) | 2.30(2.07) | 2R2 |
| LVT404012-4R7□-N | 4.7 | 20, 30 | 1 | 0.094 | 1.32(1.18) | 1.80(1.62) | 4R7 |
| LVT404012-6R8□-N | 6.8 | 20, 30 | 1 | 0.135 | 1.08(0.97) | 1.50(1.35) | 6R8 |
| LVT404012-150□-N | 15 | 20, 30 | 1 | 0.260 | 0.78(0.70) | 1.00(0.90) | 150 |
| LVT404012-220□-N | 22 | 20, 30 | 1 | 0.390 | 0.62(0.55) | 0.80(0.72) | 220 |

Note: When ordering, please specify tolerance code. Tolerance: M=±20% , T =±30%

- Operating temperature range - 55°C ~ 125°C(Including self - temperature rise)
- Isat for Inductance drop 30% from its value without current
- I rms for a 40°C temperature rise from 25°C ambient with current
- Measure Equipment :
- L : Agilent HP4284A+Agilent HP42841A, 100kHz 1V
RDC : DIGITAL MILLINHM METER CHROMA 16502, or equivalent
Isat & I rms : Agilent HP4284A

Test Instruments : HP4284A Material/Impedance Analyzer



Please be sure to request approval specifications that provide further details of the products. Kindly note that the content of these specifications are subject to change or may be discontinued without advance notice. Please contact our sales department before ordering.

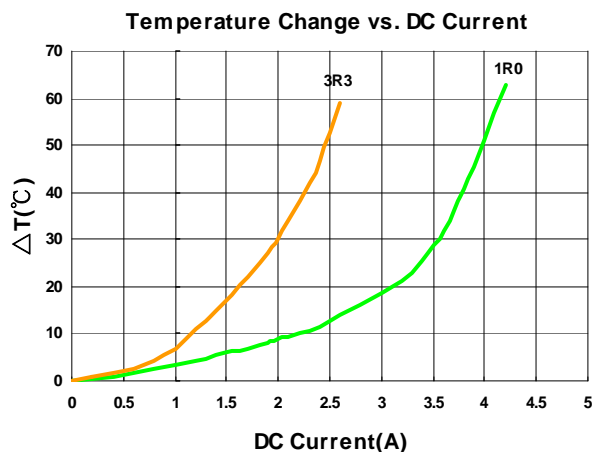
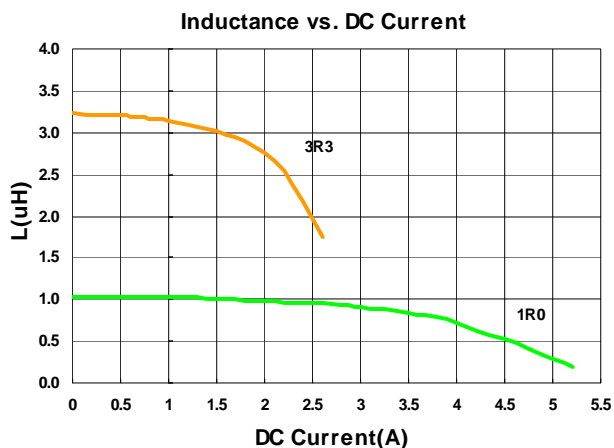
Electrical Characteristics

| Part Number | Inductance (uH) | Tolerance (±%) | Test Frequency (MHz) | RDC (Ω) ±30% | Isat (A) Typ. (Max) | Irms (A) Typ. (Max) | Marking |
|------------------|-----------------|----------------|----------------------|--------------|---------------------|---------------------|---------|
| LVT404015-1R0□-N | 1.0 | 20, 30 | 1 | 0.034 | 3.60(3.24) | 3.70(3.33) | 1R0 |
| LVT404015-3R3□-N | 3.3 | 20, 30 | 1 | 0.080 | 2.00(1.80) | 2.20(1.98) | 3R3 |

Note: When ordering, please specify tolerance code. Tolerance: M=±20% , T =±30%

- Operating temperature range - 55°C ~ 125°C(Including self - temperature rise)
- Isat for Inductance drop 30% from its value without current
- I rms for a 40°C temperature rise from 25°C ambient with current
- Measure Equipment :
- L : Agilent HP4284A+Agilent HP42841A, 100kHz 1V
- RDC : DIGITAL MILLINHM METER CHROMA 16502, or equivalent
- Isat & I rms : Agilent HP4284A

Test Instruments : HP4284A Material/Impedance Analyzer



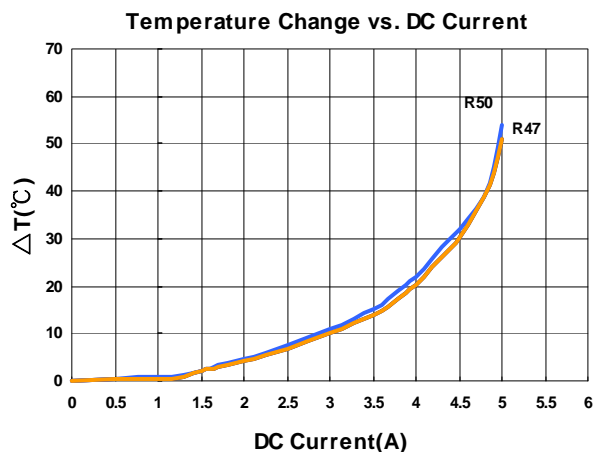
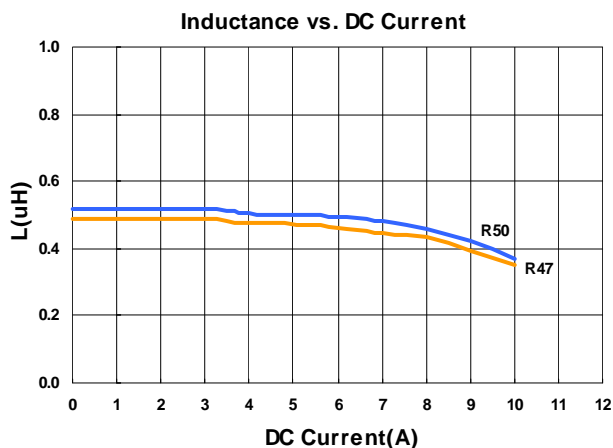
Electrical Characteristics

| Part Number | Inductance (uH) | Tolerance (±%) | Test Frequency (kHz) | RDC (Ω) ±30% | Isat (A) Typ. (Max) | Irms (A) Typ. (Max) | Marking |
|------------------|-----------------|----------------|----------------------|--------------|---------------------|---------------------|---------|
| LVT404026-R47□-N | 0.47 | 20, 30 | 100 | 0.024 | 7.20(6.48) | 4.80(4.32) | R47 |
| LVT404026-R50□-N | 0.50 | 20, 30 | 100 | 0.024 | 7.20(6.48) | 4.80(4.32) | R50 |

Note: When ordering, please specify tolerance code. Tolerance: M=±20% , T =±30%

- Operating temperature range - 55°C ~ 125°C(Including self - temperature rise)
- Isat for Inductance drop 30% from its value without current
- Irms for a 40°C temperature rise from 25°C ambient with current
- Measure Equipment :
- L : Agilent HP4284A+Agilent HP42841A, 100kHz 1V
- RDC : DIGITAL MILLINHM METER CHROMA 16502, or equivalent
- Isat & Irms : Agilent HP4284A

Test Instruments : HP4284A Material/Impedance Analyzer



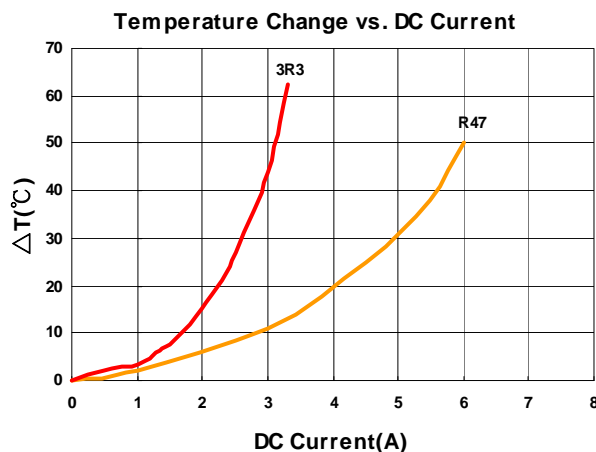
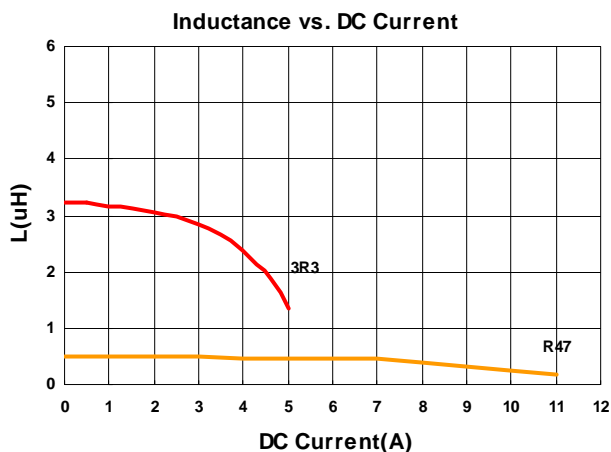
Electrical Characteristics

| Part Number | Inductance (uH) | Tolerance (±%) | Test Frequency (kHz) | RDC (Ω) ±30% | Isat (A) Typ. (Max) | Irms (A) Typ. (Max) | Marking |
|------------------|-----------------|----------------|----------------------|--------------|---------------------|---------------------|---------|
| LVT505020-R47□-N | 0.47 | 20, 30 | 100 | 0.0135 | 8.0(7.2) | 5.5(5.0) | R47 |
| LVT505020-3R3□-N | 3.3 | 20, 30 | 100 | 0.050 | 3.4(3.06) | 2.7(2.43) | 3R3 |

Note: When ordering, please specify tolerance code. Tolerance: M=±20% , T =±30%

- Operating temperature range - 55°C ~ 125°C(Including self - temperature rise)
- Isat for Inductance drop 30% from its value without current
- I rms for a 40°C temperature rise from 25°C ambient with current
- Measure Equipment :
- L : Agilent HP4284A+Agilent HP42841A, 100kHz 1V
- RDC : DIGITAL MILLINHM METER CHROMA 16502, or equivalent
- Isat & I rms : Agilent HP4284A

Test Instruments : HP4284A Material/Impedance Analyzer



Please be sure to request approval specifications that provide further details of the products. Kindly note that the content of these specifications are subject to change or may be discontinued without advance notice. Please contact our sales department before ordering.

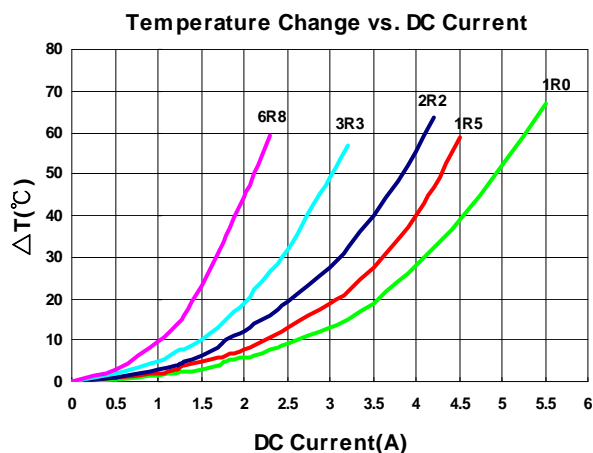
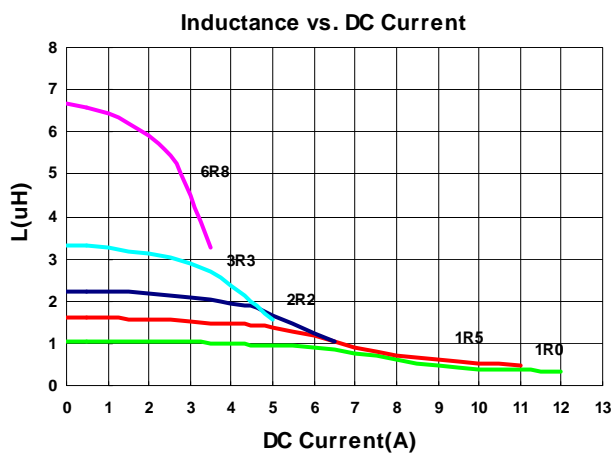
Electrical Characteristics

| Part Number | Inductance (uH) | Tolerance (±%) | Test Frequency (kHz) | RDC (Ω) ±30% | Isat (A) Typ. (Max) | Irms (A) Typ. (Max) | Marking |
|------------------|-----------------|----------------|----------------------|--------------|---------------------|---------------------|---------|
| LVT606020-1R0□-N | 1.0 | 20, 30 | 100 | 0.019 | 6.4(5.76) | 4.2(3.78) | 1R0 |
| LVT606020-1R5□-N | 1.5 | 20, 30 | 100 | 0.026 | 5.4(4.86) | 3.7(3.33) | 1R5 |
| LVT606020-2R2□-N | 2.2 | 20, 30 | 100 | 0.034 | 4.5(4.05) | 3.3(2.97) | 2R2 |
| LVT606020-3R3□-N | 3.3 | 20, 30 | 100 | 0.045 | 3.6(3.24) | 2.8(2.52) | 3R3 |
| LVT606020-6R8□-N | 6.8 | 20, 30 | 100 | 0.085 | 2.6(2.34) | 1.9(1.71) | 6R8 |

Note: When ordering, please specify tolerance code. Tolerance: M=±20% , T =±30%

- Operating temperature range - 55°C ~ 125°C(Including self - temperature rise)
- Isat for Inductance drop 30% from its value without current
- Irms for a 40°C temperature rise from 25°C ambient with current
- Measure Equipment :
- L : Agilent HP4284A+Agilent HP42841A, 100kHz 1V
- RDC : DIGITAL MILLINHM METER CHROMA 16502, or equivalent
- Isat & Irms : Agilent HP4284A

Test Instruments : HP4284A Material/Impedance Analyzer



Please be sure to request approval specifications that provide further details of the products. Kindly note that the content of these specifications are subject to change or may be discontinued without advance notice. Please contact our sales department before ordering.

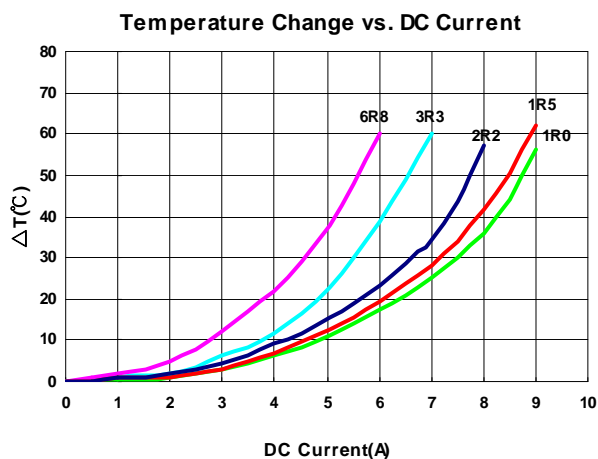
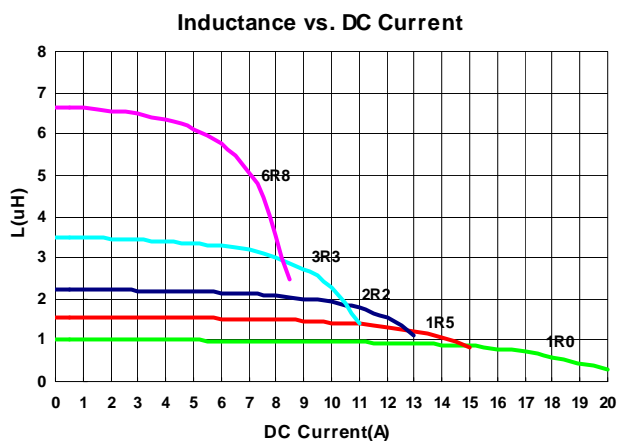
Electrical Characteristics

| Part Number | Inductance (uH) | Tolerance (±%) | Test Frequency (kHz) | RDC (Ω) ±30% | Isat (A) Typ. (Max) | Irms (A) Typ. (Max) | Marking |
|------------------|-----------------|----------------|----------------------|--------------|---------------------|---------------------|---------|
| LVT808040-1R0□-N | 1.0 | 20, 30 | 100 | 0.0075 | 13.5(12.15) | 8.1(7.29) | 1R0 |
| LVT808040-1R5□-N | 1.5 | 20, 30 | 100 | 0.0097 | 10.5(9.45) | 7.7(6.93) | 1R5 |
| LVT808040-2R2□-N | 2.2 | 20, 30 | 100 | 0.012 | 9.7(8.73) | 7.2(6.48) | 2R2 |
| LVT808040-3R3□-N | 3.3 | 20, 30 | 100 | 0.047 | 8.0(7.20) | 5.9(5.31) | 3R3 |
| LVT808040-6R8□-N | 6.8 | 20, 30 | 100 | 0.029 | 5.8(5.22) | 4.9(4.41) | 6R8 |

Note: When ordering, please specify tolerance code. Tolerance: M=±20% , T =±30%

- Operating temperature range - 55°C ~ 125°C(Including self - temperature rise)
- Isat for Inductance drop 30% from its value without current
- Irms for a 40°C temperature rise from 25°C ambient with current
- Measure Equipment :
- L : Agilent HP4284A+Agilent HP42841A, 100kHz 1V
- RDC : DIGITAL MILLINHM METER CHROMA 16502, or equivalent
- Isat & Irms : Agilent HP4284A

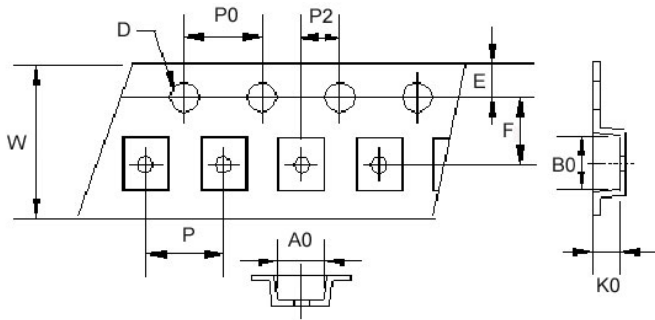
Test Instruments : HP4284A Material/Impedance Analyzer



Packaging Specifications

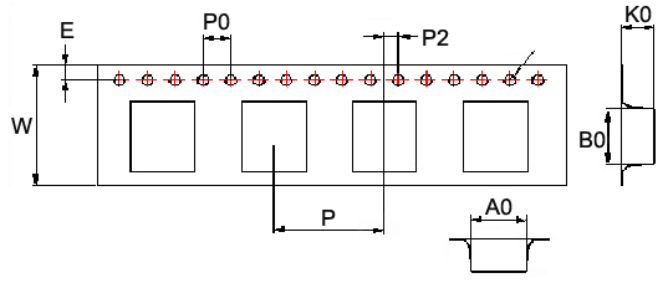
Tape Dimensions

Figure 1



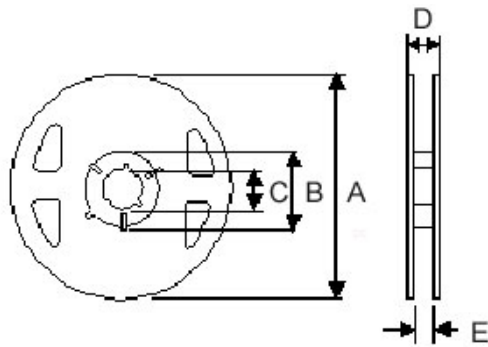
Tape Dimensions

Figure 2



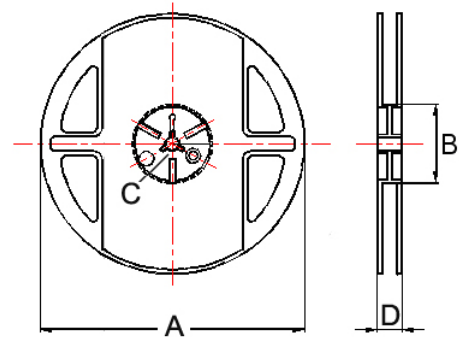
Reel Dimensions

Figure 1



Reel Dimensions

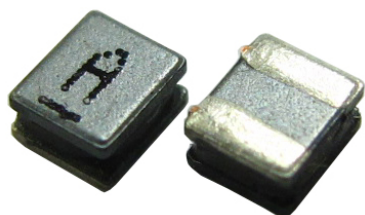
Figure 2



Dimensions in mm

| TYPE | Fig | Tape Dimensions | | | | | | | | | | Reel Dimensions | | | | | Quantity PCS / Reel |
|-----------|-----|-----------------|------|------|------|------|-----|-----|----|----|----|-----------------|-----|----|------|-----|------------------------|
| | | A0 | B0 | K0 | D | E | F | W | P | P0 | P2 | A | B | C | D | E | |
| LVT201B10 | 1 | 1.90 | 2.20 | 1.15 | 1.55 | 1.75 | 3.5 | 8.1 | 4 | 4 | 2 | 180 | 60 | 13 | 14.4 | 8.4 | 2000 |
| LVT252A10 | 1 | 2.40 | 2.70 | 1.15 | 1.55 | 1.75 | 3.5 | 8.1 | 4 | 4 | 2 | 180 | 60 | 13 | 14.4 | 8.4 | 2000 |
| LVT252A12 | 1 | 2.40 | 2.70 | 1.35 | 1.55 | 1.75 | 3.5 | 8.1 | 4 | 4 | 2 | 180 | 60 | 13 | 14.4 | 8.4 | 2000 |
| LVT303010 | 1 | 3.20 | 3.20 | 1.40 | 1.55 | 1.75 | 3.5 | 8.1 | 4 | 4 | 2 | 180 | 60 | 13 | 14.4 | 8.4 | 2000 |
| LVT303012 | 1 | 3.20 | 3.20 | 1.40 | 1.55 | 1.75 | 3.5 | 8.1 | 4 | 4 | 2 | 180 | 60 | 13 | 14.4 | 8.4 | 2000 |
| LVT404012 | 2 | 4.25 | 4.25 | 1.30 | 1.55 | 1.75 | 5.5 | 12 | 8 | 4 | 2 | 178 | 60 | 13 | 13.2 | - | 1000 |
| LVT404015 | 2 | 4.25 | 4.25 | 1.70 | 1.55 | 1.75 | 5.5 | 12 | 8 | 4 | 2 | 178 | 60 | 13 | 13.2 | - | 1000 |
| LVT404026 | 2 | 4.25 | 4.25 | 3.00 | 1.55 | 1.75 | 5.5 | 12 | 8 | 4 | 2 | 178 | 60 | 13 | 13.2 | - | 500 |
| LVT505020 | 2 | 5.25 | 5.25 | 2.20 | 1.55 | 1.75 | 5.5 | 12 | 8 | 4 | 2 | 330 | 100 | 13 | 13.4 | - | 2000 |
| LVT606020 | 2 | 6.25 | 6.25 | 2.20 | 1.55 | 1.75 | 7.5 | 16 | 12 | 4 | 2 | 330 | 100 | 13 | 16.0 | - | 2000 |
| LVT808040 | 2 | 8.25 | 8.25 | 4.15 | 1.55 | 1.75 | 7.5 | 16 | 12 | 4 | 2 | 330 | 100 | 13 | 16.0 | - | 1000 |

LVC Series



LVC series, an automatic assembly constructed power inductor, is shielded with magnetic resin and suitable for portable DC-DC converter application.

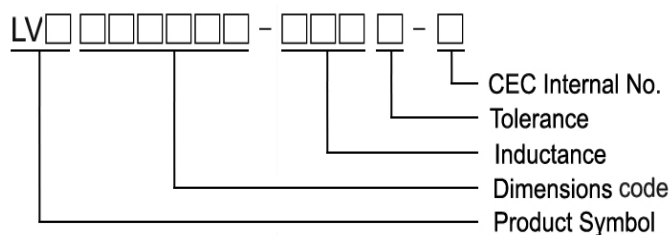
Features

- RoHS, Halogen Free and REACH Compliance
- Shielded with magnetic resin
- Various package size and wide inductance range
- Optimize electrical characteristics by using different ferrite core figures

Applications

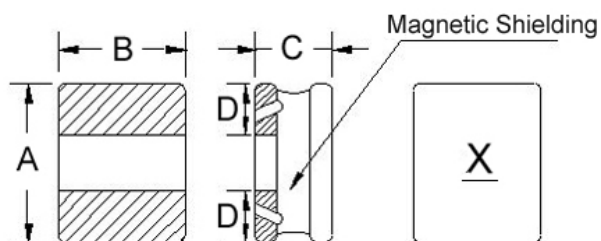
- Smartphones, tablets and wearable devices
- DSC, camcorders
- AP Routers
- STBs
- LCD TVs, monitors and panels
- Game consoles
- DC/DC converters

Product Identification

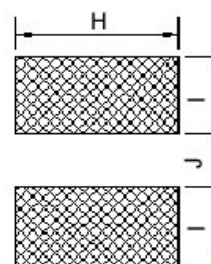


Shape and Dimensions

Figure 1



Recommended Pattern



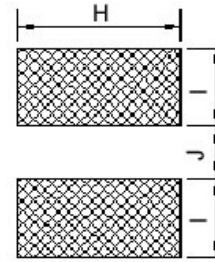
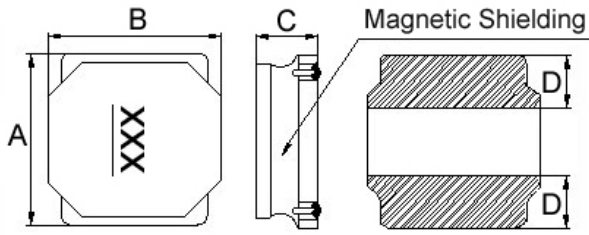
Dimensions in mm

| TYPE | FIG | A | B | C | D | H | I | J |
|-----------|-----|----------|----------|----------|-----|-----|------|-----|
| LVC201B10 | 1 | 2.0±0.25 | 1.6±0.25 | 1.00 Max | 0.6 | 1.8 | 0.80 | 0.8 |
| LVC201B12 | 1 | 2.0±0.25 | 1.6±0.25 | 1.2±0.05 | 0.6 | 1.8 | 0.80 | 0.8 |
| LVC252A12 | 1 | 2.5±0.25 | 2.0±0.25 | 1.2±0.05 | 0.8 | 2.2 | 0.85 | 0.8 |

Shape and Dimensions

Recommended Pattern

Figure 2



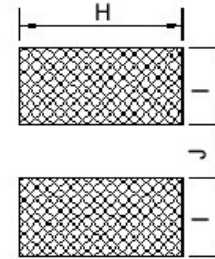
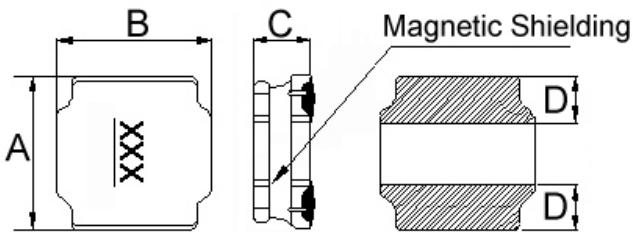
Dimensions in mm

| TYPE | FIG | A | B | C | D | H | I | J |
|-----------|-----|----------|----------|---------|-----|-----|-----|-----|
| LVC404018 | 2 | 4.0±0.20 | 4.0±0.20 | 1.9 Max | 1.3 | 3.7 | 1.5 | 1.2 |

Shape and Dimensions

Recommended Pattern

Figure 3



Dimensions in mm

| TYPE | FIG | A | B | C | D | H | I | J |
|-----------|-----|----------|----------|--------------------------------------|---------|-----|-----|-----|
| LVC505040 | 3 | 5.0±0.20 | 5.0±0.20 | 4.0±0.2 | 1.5 | 4.2 | 1.6 | 2.0 |
| LVC606028 | 3 | 6.0±0.20 | 6.0±0.20 | 2.8±0.2 | 1.9±0.3 | 5.7 | 1.8 | 2.6 |
| LVC606045 | 3 | 6.0±0.20 | 6.0±0.20 | 4.5 ^{+0.2} _{-0.30} | 1.8±0.3 | 5.7 | 2.0 | 2.4 |

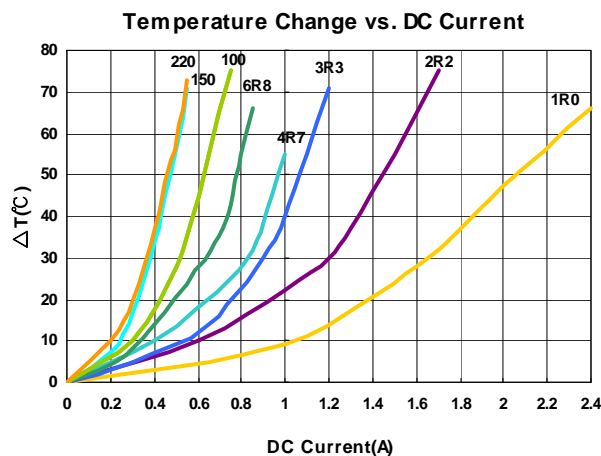
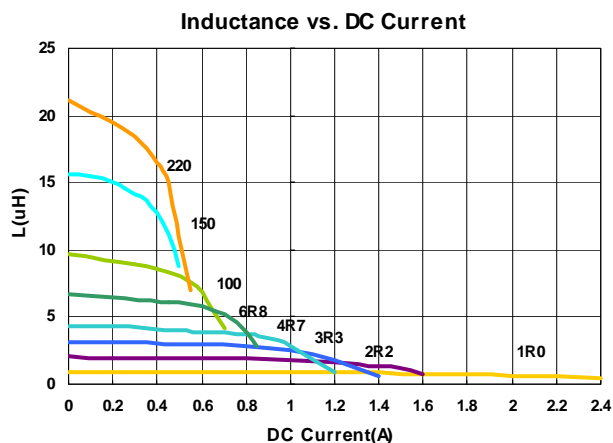
Electrical Characteristics

| Part Number | Inductance (uH) | Tolerance (±%) | Test Frequency (MHz) | RDC (Ω) ±30% | Isat (A) Typ. (Max) | Irms (A) Typ. (Max) | Marking |
|------------------|-----------------|----------------|----------------------|--------------|---------------------|---------------------|---------|
| LVC201B10-R24□-N | 0.24 | 20, 30 | 1 | 0.026 | 3.20(2.80) | 3.00(2.70) | M |
| LVC201B10-1R0□-N | 1.0 | 20, 30 | 1 | 0.095 | 1.86(1.67) | 1.86(1.67) | B |
| LVC201B10-1R5□-N | 1.5 | 20, 30 | 1 | 0.140 | 1.64(1.47) | 1.65(1.48) | C |
| LVC201B10-2R2□-N | 2.2 | 20, 30 | 1 | 0.190 | 1.30(1.17) | 1.30(1.17) | D |
| LVC201B10-3R3□-N | 3.3 | 20, 30 | 1 | 0.295 | 0.96(0.86) | 0.98(0.88) | E |
| LVC201B10-4R7□-N | 4.7 | 20, 30 | 1 | 0.360 | 0.84(0.75) | 0.90(0.81) | F |
| LVC201B10-6R8□-N | 6.8 | 20, 30 | 1 | 0.640 | 0.66(0.59) | 0.70(0.63) | G |
| LVC201B10-100□-N | 10 | 20, 30 | 1 | 1.000 | 0.54(0.48) | 0.56(0.50) | H |
| LVC201B10-150□-N | 15 | 20, 30 | 1 | 1.500 | 0.39(0.35) | 0.42(0.37) | K |
| LVC201B10-180□-N | 18 | 20, 30 | 1 | 1.600 | 0.39(0.35) | 0.41(0.36) | J |
| LVC201B10-220□-N | 22 | 20, 30 | 1 | 1.700 | 0.38(0.34) | 0.40(0.36) | I |

Note: When ordering, please specify tolerance code. Tolerance: M=±20% , T =±30%

- Operating temperature range - 55°C ~ 125°C(Including self - temperature rise)
- Isat for Inductance drop 30% from its value without current
- Irms for a 40°C temperature rise from 25°C ambient with current
- Measure Equipment :
- L : Agilent HP4287A+Agilent HP16197A, 1MHz 200mV
- RDC : DIGITAL MILLINHM METER CHROMA 16502, or equivalent
- Isat & Irms : Agilent HP4284A

Test Instruments : HP4284A Material/Impedance Analyzer



Please be sure to request approval specifications that provide further details of the products. Kindly note that the content of these specifications are subject to change or may be discontinued without advance notice. Please contact our sales department before ordering.

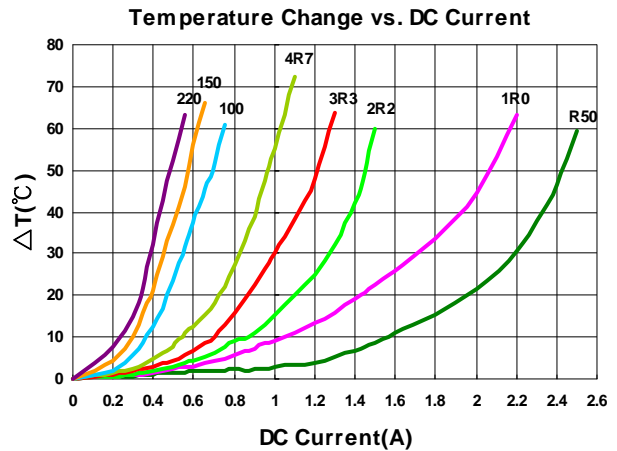
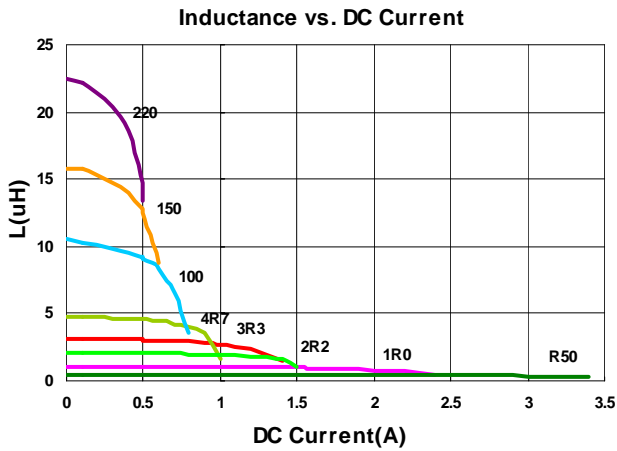
Electrical Characteristics

| Part Number | Inductance (uH) | Tolerance (±%) | Test Frequency (MHz) | RDC (Ω) ±30% | Isat (A) Typ. (Max) | Irms (A) Typ. (Max) | Marking |
|------------------|-----------------|----------------|----------------------|--------------|---------------------|---------------------|---------|
| LVC201B12-R50□-N | 0.5 | 20, 30 | 1 | 0.051 | 2.60(2.34) | 2.30(2.07) | B |
| LVC201B12-1R0□-N | 1.0 | 20, 30 | 1 | 0.083 | 1.90(1.71) | 1.80(1.62) | C |
| LVC201B12-2R2□-N | 2.2 | 20, 30 | 1 | 0.159 | 1.36(1.22) | 1.34(1.20) | E |
| LVC201B12-3R3□-N | 3.3 | 20, 30 | 1 | 0.220 | 1.10(0.99) | 1.06(0.95) | F |
| LVC201B12-4R7□-N | 4.7 | 20, 30 | 1 | 0.330 | 0.92(0.82) | 0.90(0.81) | G |
| LVC201B12-100□-N | 10 | 20, 30 | 1 | 0.580 | 0.62(0.55) | 0.58(0.52) | I |
| LVC201B12-150□-N | 15 | 20, 30 | 1 | 0.900 | 0.48(0.43) | 0.45(0.40) | J |
| LVC201B12-220□-N | 22 | 20, 30 | 1 | 1.400 | 0.40(0.36) | 0.40(0.36) | K |

Note: When ordering, please specify tolerance code. Tolerance: M=±20% , T =±30%

- Operating temperature range - 55°C ~ 125°C(Including self - temperature rise)
- Isat for Inductance drop 30% from its value without current
- I rms for a 40°C temperature rise from 25°C ambient with current
- Measure Equipment :
- L : Agilent HP4287A+Agilent HP16197A, 1MHz 200mV
- RDC : DIGITAL MILLINHM METER CHROMA 16502, or equivalent
- Isat & I rms : Agilent HP4284A

Test Instruments : HP4284A Material/Impedance Analyzer



Please be sure to request approval specifications that provide further details of the products. Kindly note that the content of these specifications are subject to change or may be discontinued without advance notice. Please contact our sales department before ordering.

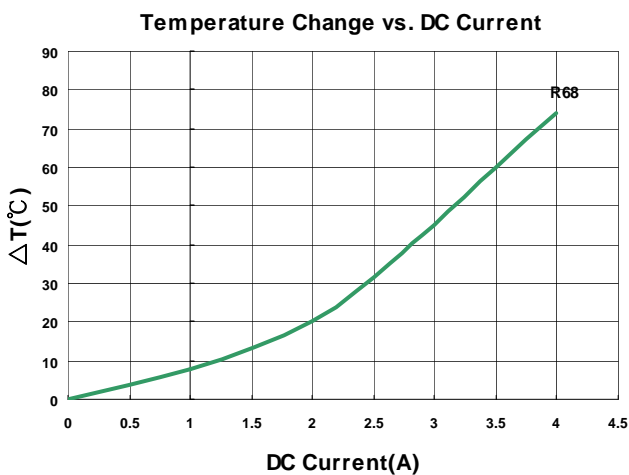
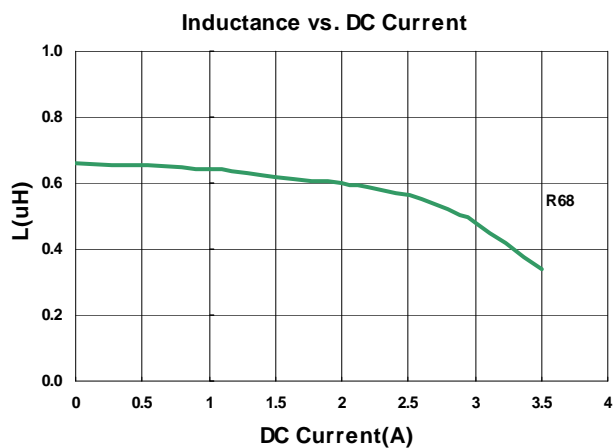
Electrical Characteristics

| Part Number | Inductance (uH) | Tolerance (±%) | Test Frequency (MHz) | RDC (Ω) ±30% | Isat (A) Typ. (Max) | Irms (A) Typ. (Max) | Marking |
|------------------|-----------------|----------------|----------------------|--------------|---------------------|---------------------|---------|
| LVC252A12-R68□-N | 0.68 | 20, 30 | 1 | 0.035 | 2.80(2.52) | 2.60(2.34) | N |

Note: When ordering, please specify tolerance code. Tolerance: M=±20%, T =±30%

- Operating temperature range - 55°C ~ 125°C(Including self - temperature rise)
- Isat for Inductance drop 30% from its value without current
- Irms for a 40°C temperature rise from 25°C ambient with current
- Measure Equipment :
- L : Agilent HP4287A+Agilent HP16197A, 1MHz 200mV
- RDC : DIGITAL MILLINHM METER CHROMA 16502, or equivalent
- Isat & Irms : Agilent HP4284A

Test Instruments : HP4284A Material/Impedance Analyzer



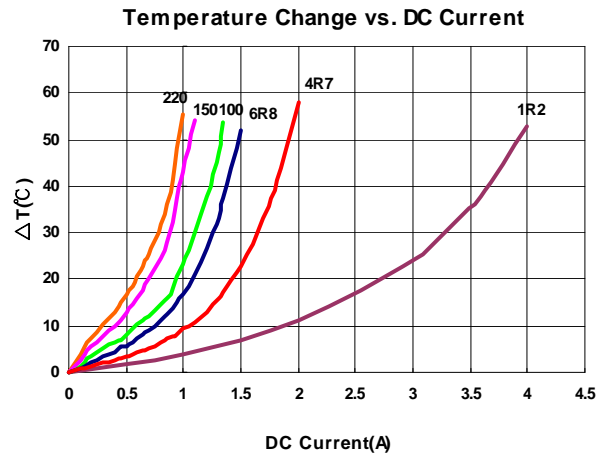
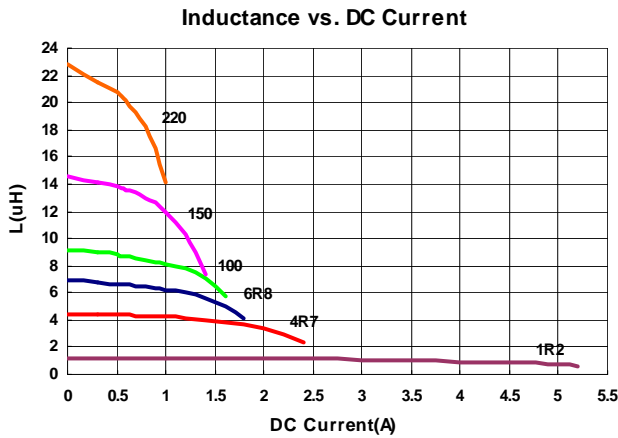
Electrical Characteristics

| Part Number | Inductance (uH) | Tolerance (±%) | Test Frequency (kHz) | RDC (Ω) ±30% | Isat (A) Typ. (Max) | Irms (A) Typ. (Max) | Marking |
|------------------|-----------------|----------------|----------------------|--------------|---------------------|---------------------|---------|
| LVC404018-1R2□-N | 1.2 | 20, 30 | 100 | 0.027 | 3.70(3.30) | 3.60(3.20) | 1R2 |
| LVC404018-4R7□-N | 4.7 | 20, 30 | 100 | 0.077 | 2.00(1.80) | 1.80(1.62) | 4R7 |
| LVC404018-6R8□-N | 6.8 | 20, 30 | 100 | 0.105 | 1.50(1.35) | 1.35(1.21) | 6R8 |
| LVC404018-100□-N | 10 | 20, 30 | 100 | 0.160 | 1.40(1.26) | 1.20(1.08) | 100 |
| LVC404018-150□-N | 15 | 20, 30 | 100 | 0.245 | 1.05(0.94) | 0.95(0.85) | 150 |
| LVC404018-220□-N | 22 | 20, 30 | 100 | 0.335 | 0.90(0.81) | 0.88(0.79) | 220 |

Note: When ordering, please specify tolerance code. Tolerance: M=±20% , T =±30%

- Operating temperature range - 55°C ~ 125°C(Including self - temperature rise)
- Isat for Inductance drop 30% from its value without current
- Irms for a 40°C temperature rise from 25°C ambient with current
- Measure Equipment :
- L : Agilent HP 4284A+Agilent HP 42841A, 100kHz 1V
RDC : DIGITAL MILLINHM METER CHROMA 16502, or equivalent
Isat & Irms : Agilent HP4284A

Test Instruments : HP4284A Material/Impedance Analyzer



Please be sure to request approval specifications that provide further details of the products. Kindly note that the content of these specifications are subject to change or may be discontinued without advance notice. Please contact our sales department before ordering.

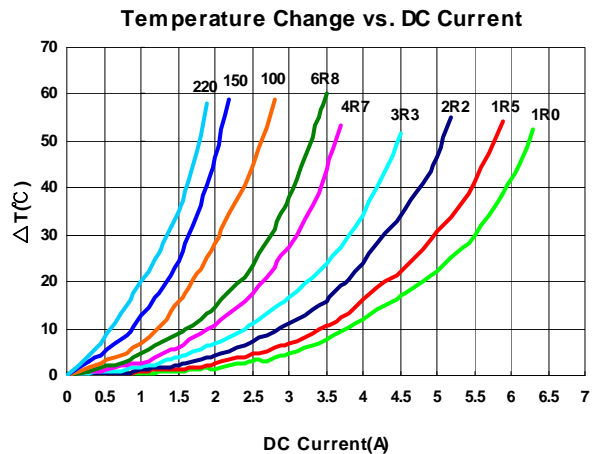
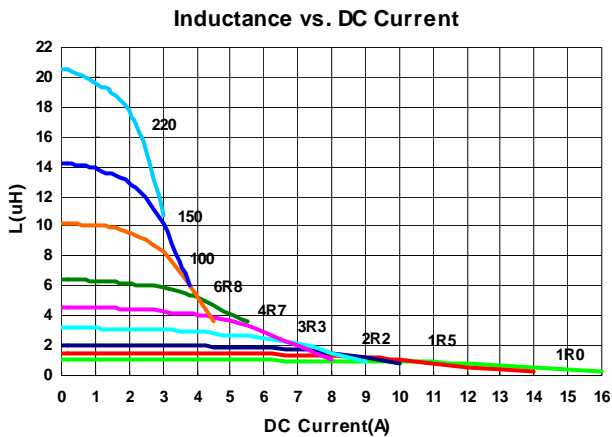
Electrical Characteristics

| Part Number | Inductance (uH) | Tolerance (±%) | Test Frequency (kHz) | RDC (Ω) ±30% | Isat (A) Typ. (Max) | Irms (A) Typ. (Max) | Marking |
|------------------|-----------------|----------------|----------------------|--------------|---------------------|---------------------|---------|
| LVC505040-1R0□-N | 1.0 | 20, 30 | 100 | 0.012 | 8.8(7.92) | 5.9(5.31) | 1R0 |
| LVC505040-1R5□-N | 1.5 | 20,30 | 100 | 0.014 | 7.9(7.11) | 5.4(4.86) | 1R5 |
| LVC505040-2R2□-N | 2.2 | 20, 30 | 100 | 0.020 | 6.8(6.12) | 4.5(4.05) | 2R2 |
| LVC505040-2R7□-N | 2.7 | 20, 30 | 100 | 0.026 | 6.0(5.40) | 4.2(3.70) | 2R7 |
| LVC505040-3R3□-N | 3.3 | 20, 30 | 100 | 0.026 | 5.3(4.77) | 4.2(3.78) | 3R3 |
| LVC505040-4R7□-N | 4.7 | 20, 30 | 100 | 0.032 | 4.4(3.96) | 3.2(2.88) | 4R7 |
| LVC505040-6R8□-N | 6.8 | 20, 30 | 100 | 0.050 | 3.8(3.42) | 3.0(2.70) | 6R8 |
| LVC505040-100□-N | 10 | 20, 30 | 100 | 0.070 | 3.0(2.70) | 2.3(2.07) | 100 |
| LVC505040-150□-N | 15 | 20, 30 | 100 | 0.115 | 2.4(2.16) | 1.8(1.62) | 150 |
| LVC505040-220□-N | 22 | 20, 30 | 100 | 0.160 | 2.0(1.80) | 1.6(1.44) | 220 |
| LVC505040-151□-N | 150 | 20, 30 | 100 | 1.180 | 0.74(0.66) | 0.58(0.52) | 151 |
| LVC505040-181□-N | 180 | 20, 30 | 100 | 1.250 | 0.67(0.60) | 0.54(0.48) | 181 |
| LVC505040-221□-N | 220 | 20, 30 | 100 | 1.450 | 0.65(0.58) | 0.50(0.45) | 221 |

Note: When ordering, please specify tolerance code. Tolerance: M=±20% , T =±30%

- Operating temperature range - 55°C ~ 125°C(Including self - temperature rise)
- Isat for Inductance drop 30% from its value without current
- Irms for a 40°C temperature rise from 25°C ambient with current
- Measure Equipment :
- L : Agilent HP 4284A+Agilent HP 42841A, 100kHz 1V
- RDC : DIGITAL MILLINHM METER CHROMA 16502, or equivalent
- Isat & Irms : Agilent HP4284A

Test Instruments : HP4284A Material/Impedance Analyzer



Please be sure to request approval specifications that provide further details of the products. Kindly note that the content of these specifications are subject to change or may be discontinued without advance notice. Please contact our sales department before ordering.

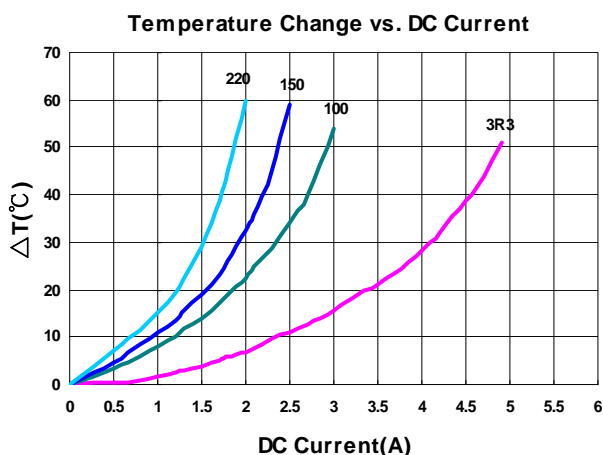
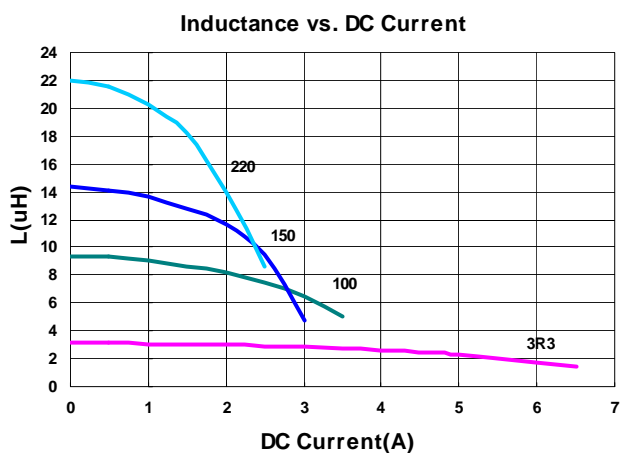
Electrical Characteristics

| Part Number | Inductance (uH) | Tolerance (±%) | Test Frequency (kHz) | RDC (Ω) ±30% | Isat (A) Typ. (Max) | Irms (A) Typ. (Max) | Marking |
|------------------|-----------------|----------------|----------------------|--------------|---------------------|---------------------|---------|
| LVC606028-3R3□-N | 3.3 | 20, 30 | 100 | 0.027 | 4.5(4.05) | 4.0(3.60) | 3R3 |
| LVC606028-100□-N | 10 | 20, 30 | 100 | 0.065 | 2.6(2.34) | 2.5(2.25) | 100 |
| LVC606028-150□-N | 15 | 20, 30 | 100 | 0.093 | 2.1(1.89) | 2.0(1.80) | 150 |
| LVC606028-220□-N | 22 | 20, 30 | 100 | 0.135 | 1.7(1.53) | 1.65(1.48) | 220 |

Note: When ordering, please specify tolerance code. Tolerance: M=±20% , T=±30%

- Operating temperature range - 55°C ~ 125°C(Including self - temperature rise)
- Isat for Inductance drop 30% from its value without current
- Irms for a 40°C temperature rise from 25°C ambient with current
- Measure Equipment :
- L : Agilent HP 4284A+Agilent HP 42841A, 100kHz 1V
- RDC : DIGITAL MILLINHM METER CHROMA 16502, or equivalent
- Isat & Irms : Agilent HP4284A

Test Instruments : HP4284A Material/Impedance Analyzer



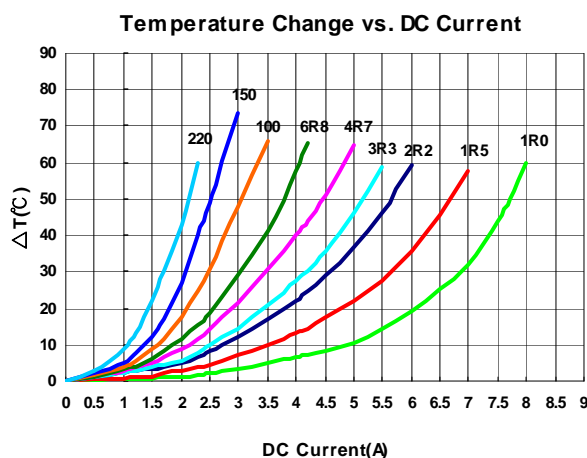
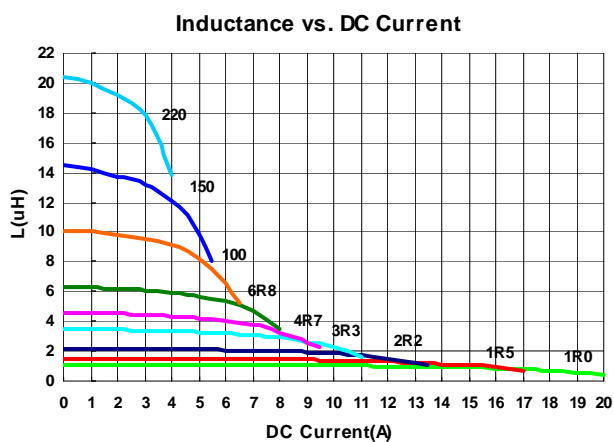
Electrical Characteristics

| Part Number | Inductance (uH) | Tolerance (±%) | Test Frequency (kHz) | RDC (Ω) ±30% | Isat (A) Typ. (Max) | Irms (A) Typ. (Max) | Marking |
|------------------|-----------------|----------------|----------------------|--------------|---------------------|---------------------|---------|
| LVC606045-1R0□-N | 1.0 | 20,30 | 100 | 0.010 | 13(11.7) | 7.3(6.57) | 1R0 |
| LVC606045-1R5□-N | 1.5 | 20,30 | 100 | 0.012 | 12(10.8) | 6.6(5.94) | 1R5 |
| LVC606045-2R2□-N | 2.2 | 20, 30 | 100 | 0.018 | 9.5(8.55) | 5.2(4.68) | 2R2 |
| LVC606045-3R3□-N | 3.3 | 20, 30 | 100 | 0.022 | 7.8(7.02) | 4.4(3.96) | 3R3 |
| LVC606045-4R7□-N | 4.7 | 20, 30 | 100 | 0.030 | 6.8(6.12) | 4.0(3.60) | 4R7 |
| LVC606045-6R8□-N | 6.8 | 20, 30 | 100 | 0.042 | 5.7(5.13) | 3.3(2.97) | 6R8 |
| LVC606045-100□-N | 10 | 20, 30 | 100 | 0.060 | 4.6(4.14) | 2.6(2.34) | 100 |
| LVC606045-150□-N | 15 | 20, 30 | 100 | 0.090 | 3.8(3.42) | 2.2(1.98) | 150 |
| LVC606045-220□-N | 22 | 20, 30 | 100 | 0.130 | 3.3(2.97) | 1.9(1.71) | 220 |

Note: When ordering, please specify tolerance code. Tolerance: M=±20% , T =±30%

- Operating temperature range - 55°C ~ 125°C(Including self - temperature rise)
- Isat for Inductance drop 30% from its value without current
- Irms for a 40°C temperature rise from 25°C ambient with current
- Measure Equipment :
- L : Agilent HP 4284A+Agilent HP 42841A, 100kHz 1V
RDC : DIGITAL MILLINHM METER CHROMA 16502, or equivalent
Isat & Irms : Agilent HP4284A

Test Instruments : HP4284A Material/Impedance Analyzer



Please be sure to request approval specifications that provide further details of the products. Kindly note that the content of these specifications are subject to change or may be discontinued without advance notice. Please contact our sales department before ordering.

Packaging Specifications

Tape Dimensions

Figure 1

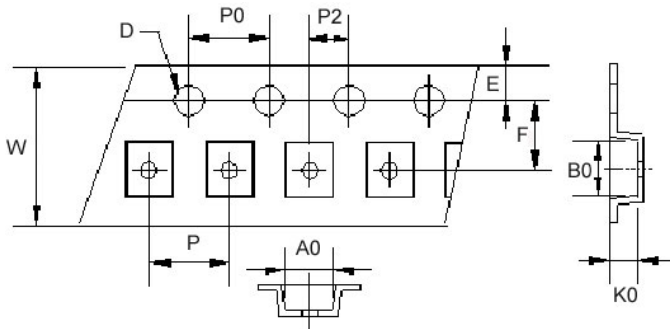
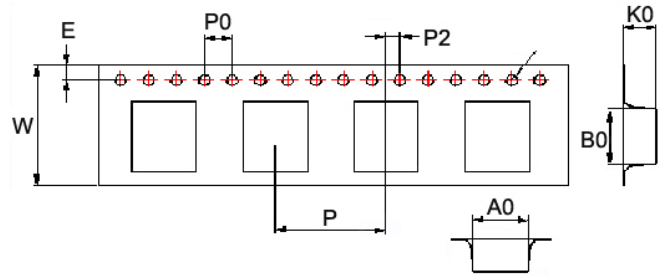
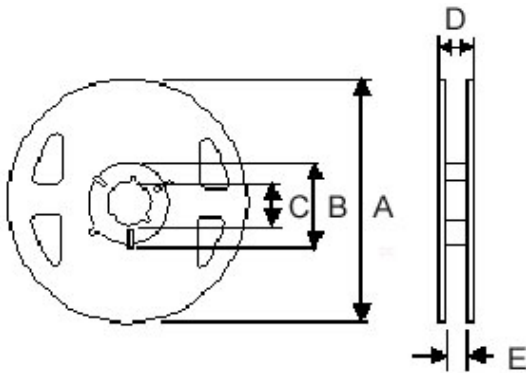


Figure 2



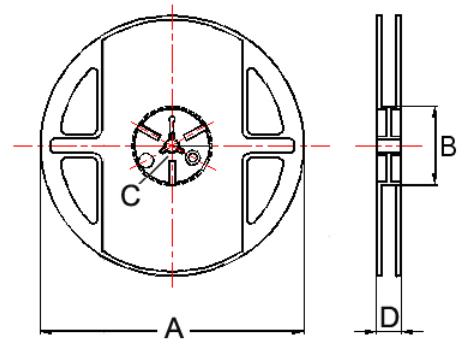
Reel Dimensions

Figure 1



Reel Dimensions

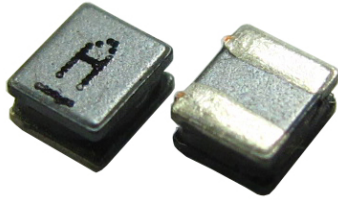
Figure 2



Dimensions in mm

| TYPE | Fig | Tape Dimensions | | | | | | | | | | Reel Dimensions | | | | | Quantity PCS / Reel |
|-----------|-----|-----------------|------|------|------|------|-----|-----|----|----|----|-----------------|-----|----|------|-----|------------------------|
| | | A0 | B0 | K0 | D | E | F | W | P | P0 | P2 | A | B | C | D | E | |
| LVC201B10 | 1 | 1.90 | 2.20 | 1.15 | 1.55 | 1.75 | 3.5 | 8.1 | 4 | 4 | 2 | 180 | 60 | 13 | 14.4 | 8.4 | 2000 |
| LVC201B12 | 1 | 1.90 | 2.20 | 1.30 | 1.55 | 1.75 | 3.5 | 8.1 | 4 | 4 | 2 | 180 | 60 | 13 | 14.4 | 8.4 | 2000 |
| LVC252A12 | 1 | 2.40 | 2.70 | 1.35 | 1.55 | 1.75 | 3.5 | 8.1 | 4 | 4 | 2 | 180 | 60 | 13 | 14.4 | 8.4 | 2000 |
| LVC404018 | 2 | 4.25 | 4.25 | 2.10 | 1.55 | 1.75 | 5.5 | 12 | 8 | 4 | 2 | 178 | 60 | 13 | 13.2 | - | 800 |
| LVC505040 | 2 | 5.30 | 5.30 | 4.40 | 1.55 | 1.75 | 5.5 | 12 | 8 | 4 | 2 | 330 | 100 | 13 | 13.4 | - | 1500 |
| LVC606028 | 2 | 6.25 | 6.25 | 3.00 | 1.55 | 1.75 | 7.5 | 16 | 12 | 4 | 2 | 330 | 100 | 13 | 16.0 | - | 1500 |
| LVC606045 | 2 | 6.25 | 6.25 | 4.65 | 1.55 | 1.75 | 7.5 | 16 | 12 | 4 | 2 | 330 | 100 | 13 | 16.0 | - | 1000 |

LVH Series



LVH series, an automatic assembly constructed power inductor, is shielded with magnetic resin and suitable for portable DC-DC converter applications.

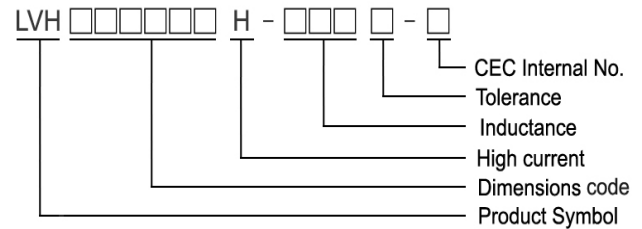
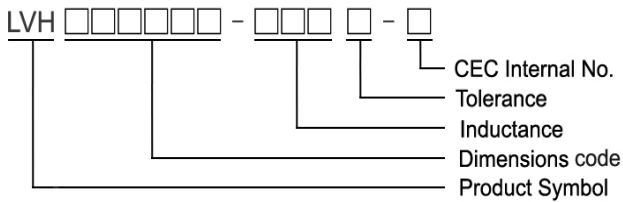
Features

- RoHS, Halogen Free and REACH Compliance
- Shielded with magnetic resin
- Low profile, miniature package size and wide inductance range.
- Low DCR and high rated current.

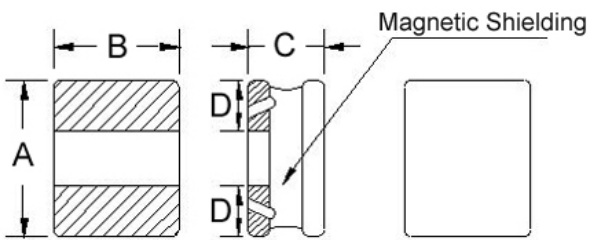
Applications

- Smart phone
- DSC
- Tablet PC and other portable devices
- DC/DC converters

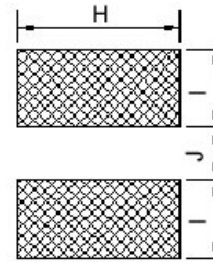
Product Identification



Shape and Dimensions



Recommended Pattern



Dimensions in mm

| TYPE | A | B | C | D | H | I | J |
|------------|----------|----------|----------|-----|-----|------|-----|
| LVH201B10H | 2.0±0.25 | 1.6±0.25 | 1.02 Max | 0.6 | 1.8 | 0.8 | 0.8 |
| LVH252A10H | 2.5±0.25 | 2.0±0.25 | 1.00 Max | 0.8 | 2.2 | 0.85 | 0.8 |
| LVH252A12 | 2.5±0.25 | 2.0±0.25 | 1.2±0.05 | 0.8 | 2.2 | 0.85 | 0.8 |
| LVH252A12H | 2.5±0.25 | 2.0±0.25 | 1.2±0.05 | 0.8 | 2.2 | 0.85 | 0.8 |

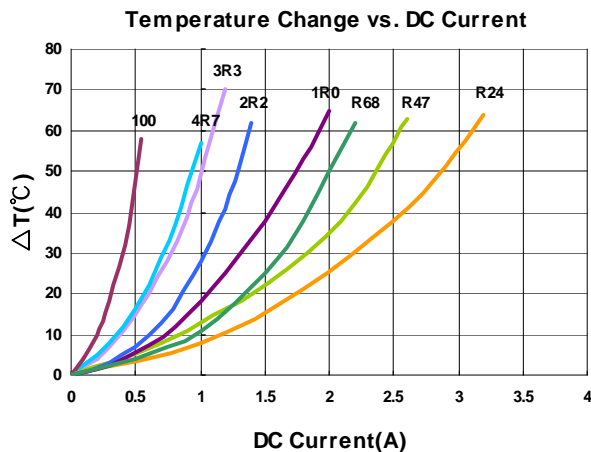
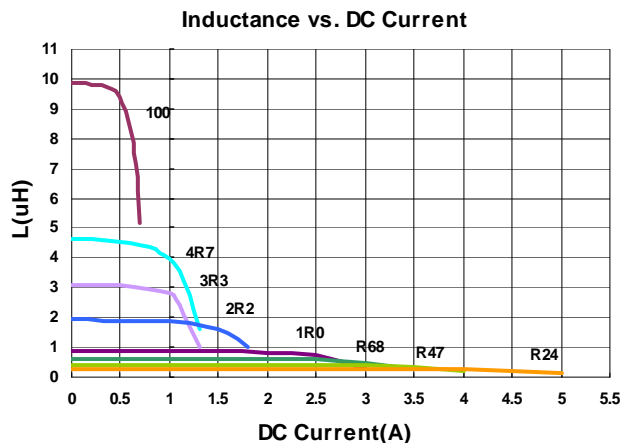
Electrical Characteristics

| Part Number | Inductance (uH) | Tolerance (±%) | Test Frequency (MHz) | RDC (Ω) ±30% | Isat (mA) Typ. (Max) | Irms (mA) Typ. (Max) |
|-------------------|-----------------|----------------|----------------------|--------------|----------------------|----------------------|
| LVH201B10H-R24□-N | 0.24 | 20, 30 | 1 | 0.048 | 3700(3300) | 2500(2100) |
| LVH201B10H-R33□-N | 0.33 | 20, 30 | 1 | 0.048 | 3400(3000) | 2500(2100) |
| LVH201B10H-R47□-N | 0.47 | 20, 30 | 1 | 0.072 | 2900(2600) | 2100(1800) |
| LVH201B10H-R56□-N | 0.56 | 20, 30 | 1 | 0.072 | 2700(2400) | 2100(1800) |
| LVH201B10H-R68□-N | 0.68 | 20, 30 | 1 | 0.092 | 2500(2200) | 1800(1500) |
| LVH201B10H-1R0□-N | 1.0 | 20, 30 | 1 | 0.110 | 2200(2000) | 1500(1200) |
| LVH201B10H-2R2□-N | 2.2 | 20, 30 | 1 | 0.205 | 1400(1200) | 1150(970) |
| LVH201B10H-3R3□-N | 3.3 | 20, 30 | 1 | 0.380 | 1050(940) | 900(800) |
| LVH201B10H-4R7□-N | 4.7 | 20, 30 | 1 | 0.520 | 900(800) | 800(680) |
| LVH201B10H-100□-N | 10 | 20, 30 | 1 | 1.100 | 620(550) | 450(380) |

Note: When ordering, please specify tolerance code. Tolerance: M=±20% , T =±30%

- Operating temperature range - 55°C ~ 125°C(Including self - temperature rise)
- Isat for Inductance drop 30% from its value without current
- Irms for a 40°C temperature rise from 25°C ambient with current
- Measure Equipment :
- L : Agilent HP4287A+Agilent HP16197A, 1MHz 200mV
- RDC : DIGITAL MILLINHM METER CHROMA 16502, or equivalent
- Isat & Irms : Agilent HP4284A

Test Instruments : HP4284A Material/Impedance Analyzer



Please be sure to request approval specifications that provide further details of the products. Kindly note that the content of these specifications are subject to change or may be discontinued without advance notice. Please contact our sales department before ordering.

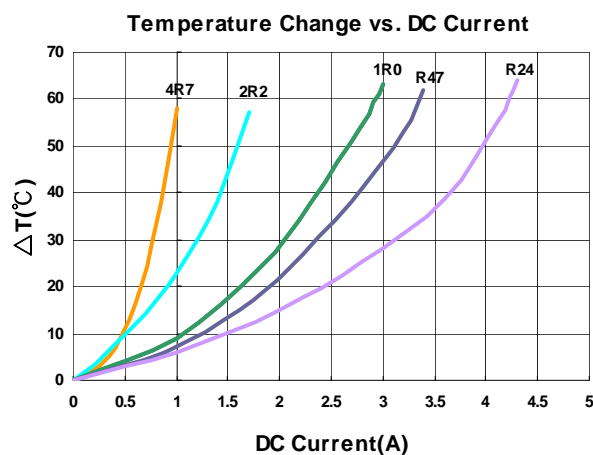
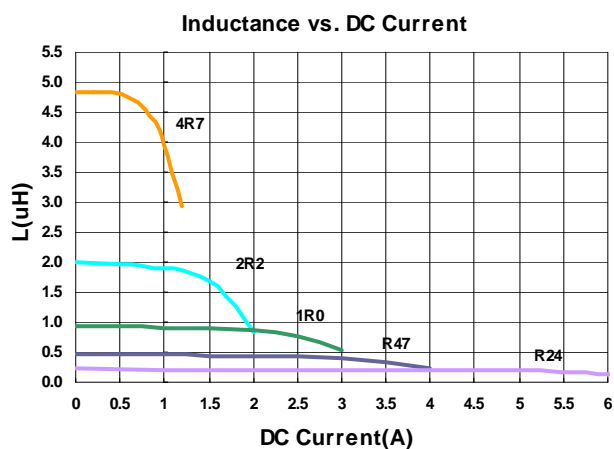
Electrical Characteristics

| Part Number | Inductance (uH) | Tolerance (±%) | Test Frequency (MHz) | RDC (Ω) ±30% | Isat (mA) Typ. (Max) | Irms (mA) Typ. (Max) |
|-------------------|-----------------|----------------|----------------------|--------------|----------------------|----------------------|
| LVH252A10H-R24□-N | 0.24 | 20, 30 | 1 | 0.030 | 4700(4200) | 3600(3000) |
| LVH252A10H-R47□-N | 0.47 | 20, 30 | 1 | 0.043 | 3300(3000) | 2700(2300) |
| LVH252A10H-R68□-N | 0.68 | 20, 30 | 1 | 0.062 | 2800(2500) | 2300(1900) |
| LVH252A10H-1R0□-N | 1.0 | 20, 30 | 1 | 0.080 | 2300(2100) | 1900(1600) |
| LVH252A10H-2R2□-N | 2.2 | 20, 30 | 1 | 0.135 | 1600(1400) | 1400(1100) |
| LVH252A10H-4R7□-N | 4.7 | 20, 30 | 1 | 0.330 | 1000(900) | 850(720) |
| LVH252A10H-100□-N | 10 | 20, 30 | 1 | 0.670 | 720(640) | 580(490) |

Note: When ordering, please specify tolerance code. Tolerance: M=±20% , T =±30%

- Operating temperature range - 55°C ~ 125°C(Including self - temperature rise)
- Isat for Inductance drop 30% from its value without current
- Irms for a 40°C temperature rise from 25°C ambient with current
- Measure Equipment :
- L : Agilent HP4287A+Agilent HP16197A, 1MHz 200mV
- RDC : DIGITAL MILLINHM METER CHROMA 16502, or equivalent
- Isat & Irms : Agilent HP4284A

Test Instruments : HP4284A Material/Impedance Analyzer



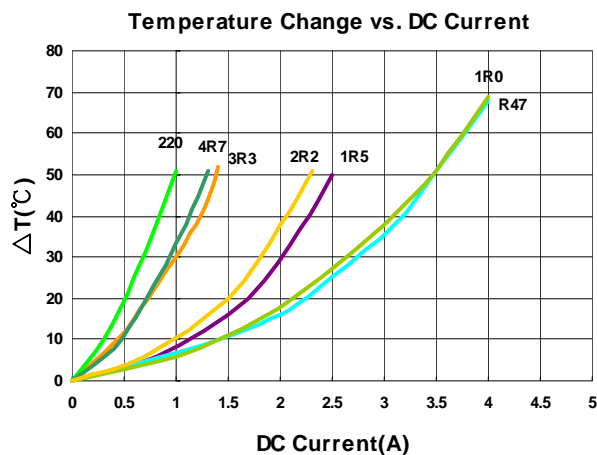
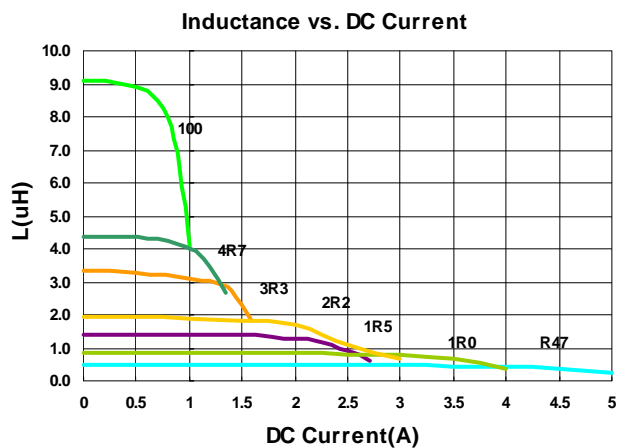
Electrical Characteristics

| Part Number | Inductance (uH) | Tolerance (±%) | Test Frequency (MHz) | RDC (Ω) ±30% | Isat (mA) Typ. (Max) | Irms (mA) Typ. (Max) |
|-------------------|-----------------|----------------|----------------------|--------------|----------------------|----------------------|
| LVH252A12H-R47□-N | 0.47 | 20, 30 | 1 | 0.031 | 4100(3700) | 3100(2600) |
| LVH252A12H-R68□-N | 0.68 | 20, 30 | 1 | 0.031 | 3100(2900) | 3100(2600) |
| LVH252A12H-1R0□-N | 1.0 | 20, 30 | 1 | 0.049 | 3200(3000) | 3000(2500) |
| LVH252A12H-1R5□-N | 1.5 | 20, 30 | 1 | 0.088 | 2300(2100) | 2200(1800) |
| LVH252A12H-2R2□-N | 2.2 | 20, 30 | 1 | 0.099 | 2200(2000) | 2000(1700) |
| LVH252A12H-3R3□-N | 3.3 | 20, 30 | 1 | 0.190 | 1400(1200) | 1200(1000) |
| LVH252A12H-4R7□-N | 4.7 | 20, 30 | 1 | 0.235 | 1300(1100) | 1100(930) |
| LVH252A12H-100□-N | 10 | 20, 30 | 1 | 0.510 | 920(820) | 800(680) |

Note: When ordering, please specify tolerance code. Tolerance: M=±20% , T =±30%

- Operating temperature range - 55°C ~ 125°C(Including self - temperature rise)
- Isat for Inductance drop 30% from its value without current
- Irms for a 40°C temperature rise from 25°C ambient with current
- Measure Equipment :
- L : Agilent HP4287A+Agilent HP16197A, 1MHz 200mV
RDC : DIGITAL MILLINHM METER CHROMA 16502, or equivalent
Isat & Irms : Agilent HP4284A

Test Instruments : HP4284A Material/Impedance Analyzer



Please be sure to request approval specifications that provide further details of the products. Kindly note that the content of these specifications are subject to change or may be discontinued without advance notice. Please contact our sales department before ordering.

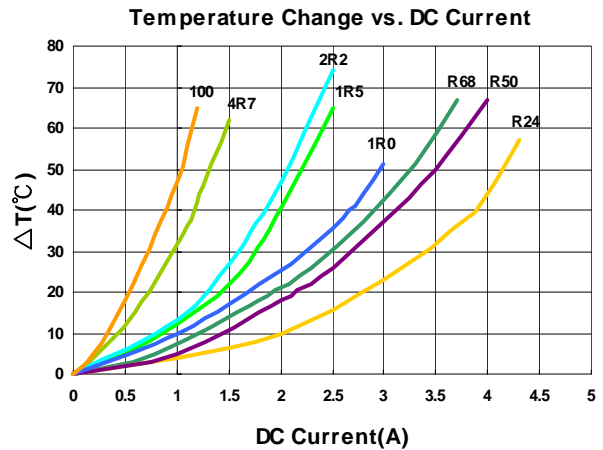
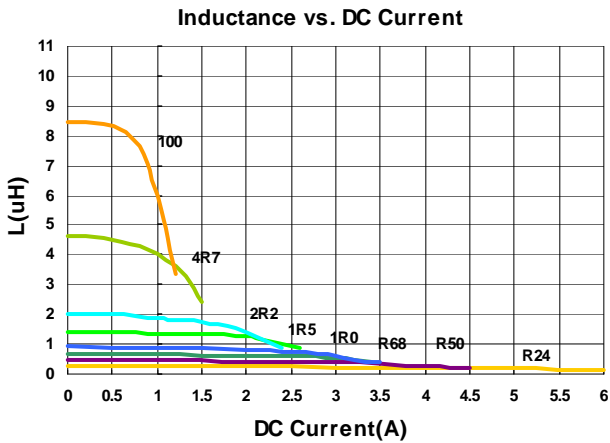
Electrical Characteristics

| Part Number | Inductance (uH) | Tolerance (±%) | Test Frequency (MHz) | RDC (Ω) ±30% | Isat (mA) Typ. (Max) | Irms (mA) Typ. (Max) | Marking |
|------------------|-----------------|----------------|----------------------|--------------|----------------------|----------------------|---------|
| LVH252A12-R24□-N | 0.24 | 20, 30 | 1 | 0.021 | 4700(4200) | 3800(3200) | E |
| LVH252A12-R33□-N | 0.33 | 20, 30 | 1 | 0.027 | 4200(3700) | 3000(2500) | G |
| LVH252A12-R47□-N | 0.47 | 20, 30 | 1 | 0.027 | 3600(3400) | 3000(2500) | J |
| LVH252A12-R50□-N | 0.50 | 20, 30 | 1 | 0.027 | 3600(3400) | 3000(2500) | D |
| LVH252A12-R68□-N | 0.68 | 20, 30 | 1 | 0.036 | 2900(2600) | 2800(2300) | H |
| LVH252A12-1R0□-N | 1.0 | 20, 30 | 1 | 0.037 | 2700(2450) | 2600(2200) | A |
| LVH252A12-1R5□-N | 1.5 | 20, 30 | 1 | 0.075 | 2200(1900) | 1900(1600) | I |
| LVH252A12-2R2□-N | 2.2 | 20, 30 | 1 | 0.080 | 1900(1800) | 1800(1500) | B |
| LVH252A12-4R7□-N | 4.7 | 20, 30 | 1 | 0.195 | 1200(1000) | 1100(930) | C |
| LVH252A12-100□-N | 10 | 20, 30 | 1 | 0.400 | 900(800) | 800(680) | F |

Note: When ordering, please specify tolerance code. Tolerance: M=±20% , T =±30%

- Operating temperature range - 55°C ~ 125°C(Including self - temperature rise)
- Isat for Inductance drop 30% from its value without current
- I rms for a 40°C temperature rise from 25°C ambient with current
- Measure Equipment :
- L : Agilent HP4287A+Agilent HP16197A, 1MHz 200mV
- RDC : DIGITAL MILLINHM METER CHROMA 16502, or equivalent
- Isat & I rms : Agilent HP4284A

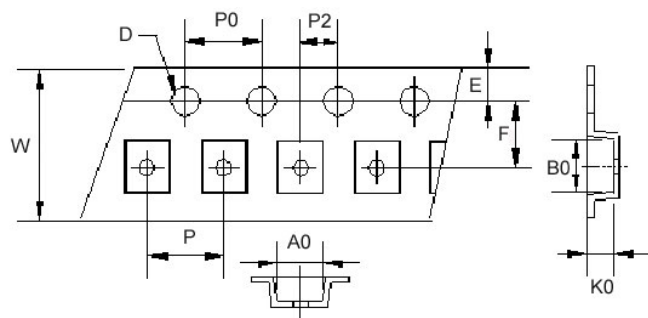
Test Instruments : HP4284A Material/Impedance Analyzer



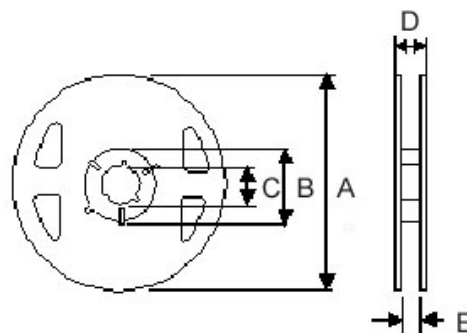
Please be sure to request approval specifications that provide further details of the products. Kindly note that the content of these specifications are subject to change or may be discontinued without advance notice. Please contact our sales department before ordering.

Packaging Specifications

Tape Dimensions



Reel Dimensions



Dimensions in mm

| TYPE | Tape Dimensions | | | | | | | | | | Reel Dimensions | | | | | Quantity PCS / Reel |
|------------|-----------------|------|------|------|------|-----|-----|---|----|----|-----------------|----|----|------|-----|------------------------|
| | A0 | B0 | K0 | D | E | F | W | P | P0 | P2 | A | B | C | D | E | |
| LVH201B10H | 1.90 | 2.20 | 1.15 | 1.55 | 1.75 | 3.5 | 8.1 | 4 | 4 | 2 | 180 | 60 | 13 | 14.4 | 8.4 | 2000 |
| LVH252A10H | 2.40 | 2.70 | 1.15 | 1.55 | 1.75 | 3.5 | 8.1 | 4 | 4 | 2 | 180 | 60 | 13 | 14.4 | 8.4 | 2000 |
| LVH252A12H | 2.40 | 2.70 | 1.35 | 1.55 | 1.75 | 3.5 | 8.1 | 4 | 4 | 2 | 180 | 60 | 13 | 14.4 | 8.4 | 2000 |
| LVH252A12 | 2.40 | 2.70 | 1.35 | 1.55 | 1.75 | 3.5 | 8.1 | 4 | 4 | 2 | 180 | 60 | 13 | 14.4 | 8.4 | 2000 |

SF Series

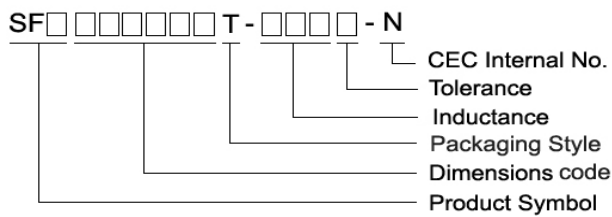
Features

- RoHS, Halogen Free and REACH Compliance
- Surface mount inductors designed for high speed, high current switch mode applications requiring lower inductance
- Gapped ferrite cores for maximum efficiency
- Customized specifications are available

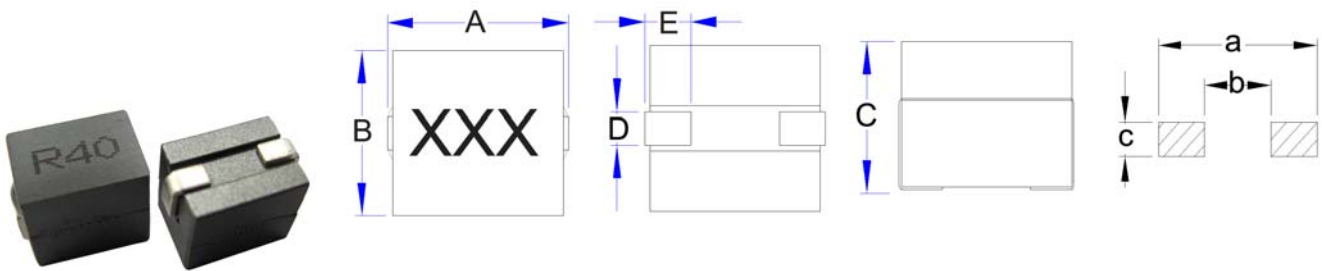
Applications

- Voltage regulator modules (VRMs) for servers, microprocessors
- High frequency, high current switching power supplies

Product Identification



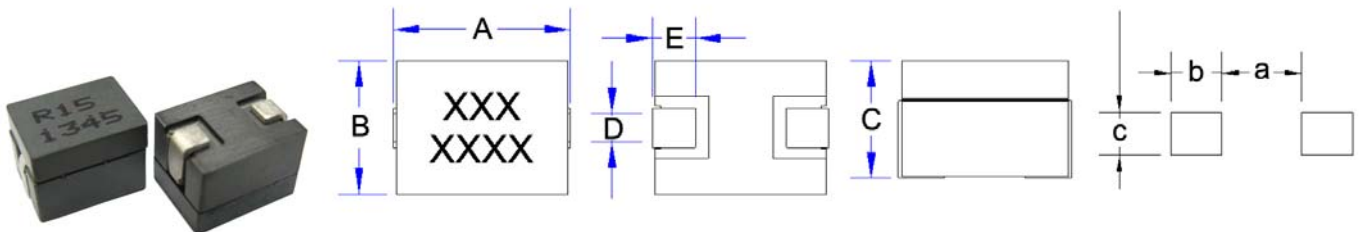
Shape and Dimensions



Dimensions in mm

| TYPE | A | B | C | D | E | a | b | c |
|-----------|----------|---------|---------|---------|---------|------|-----|---|
| SFD100707 | 11.0 Max | 7.5 Max | 7.0 Max | 1.6±0.2 | 2.6±0.3 | 11.0 | 4.3 | 2 |

Shape and Dimensions



Dimensions in mm

| TYPE | A | B | C | D | E | a | b | c |
|-----------|----------|---------|---------|---------|----------|-----|-----|-----|
| SFS100875 | 10.2±0.2 | 8.0 Max | 7.3±0.2 | 2.2±0.2 | 2.54±0.5 | 4.7 | 3.0 | 2.5 |

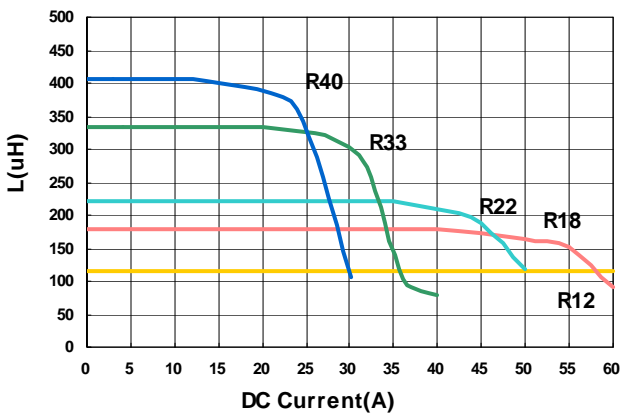
Electrical Characteristics

| Part Number | Inductance (uH) | Tolerance (±%) | Test Frequency (kHz) | RDC (mΩ) ±7% | Isat (A) Max | Irms (A) Max |
|-------------------|-----------------|----------------|----------------------|--------------|--------------|--------------|
| SFD100707T-R12L-N | 0.12 | 15 | 100 | 0.37 | 85 | 37 |
| SFD100707T-R15L-N | 0.15 | 15 | 100 | 0.37 | 75 | 37 |
| SFD100707T-R18L-N | 0.18 | 15 | 100 | 0.37 | 50 | 37 |
| SFD100707T-R22L-N | 0.22 | 15 | 100 | 0.37 | 40 | 37 |
| SFD100707T-R33L-N | 0.33 | 15 | 100 | 0.37 | 28 | 37 |
| SFD100707T-R40L-N | 0.40 | 15 | 100 | 0.37 | 21 | 37 |

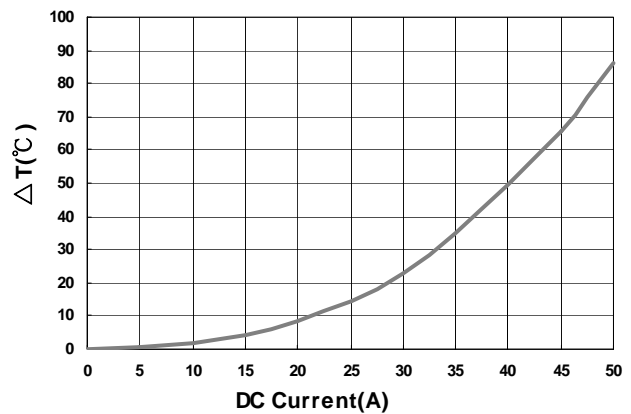
Note: When ordering, please specify tolerance code. Tolerance: L=±15%

- Customized Specifications are available
- Operating temperature range - 40°C ~ 125°C(Including self - temperature rise)
- OCL (Open Circuit Inductance) Test parameters: 100kHz, 0.25Vrms, 0Adc & Isat @20°C
- DC current for an approximate ΔT of 40°C without core loss. Derating is necessary for AC currents. PCB layout, trace thickness and width, airflow, and proximity of other heat generating components will affect the temperature rise. It is recommended that the temperature of the part not exceed 155°C under worst case operating conditions verified in the end application.
- Measure Equipment :
 L : WK4237METER
 RDC : CHEN HWA 502
 Isat : WK3260B+WK3265B

Inductance vs. DC Current



Temperature Change vs. DC Current



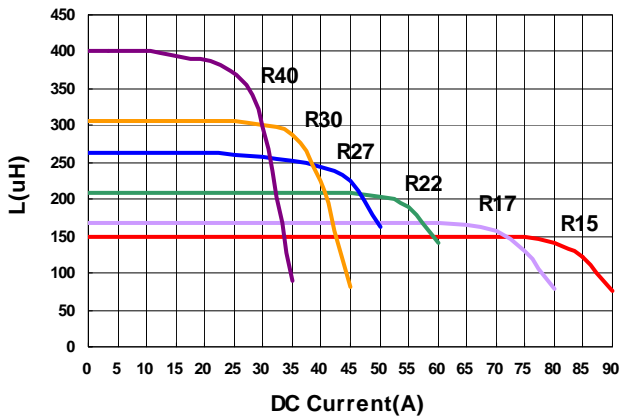
Electrical Characteristics

| Part Number | Inductance (uH) | Tolerance (±%) | Test Frequency (kHz) | RDC (mΩ) ±6% | Isat (A) Max | Irms (A) Max |
|-------------------|-----------------|----------------|----------------------|--------------|--------------|--------------|
| SFS100875T-R15K-N | 0.15 | 10 | 100 | 0.29 | 76 | 56 |
| SFS100875T-R17K-N | 0.17 | 10 | 100 | 0.29 | 66 | 56 |
| SFS100875T-R22K-N | 0.215 | 10 | 100 | 0.29 | 50 | 56 |
| SFS100875T-R27K-N | 0.27 | 10 | 100 | 0.29 | 40 | 56 |
| SFS100875T-R30K-N | 0.30 | 10 | 100 | 0.29 | 35 | 56 |
| SFS100875T-R40L-N | 0.40 | 15 | 100 | 0.29 | 25 | 56 |

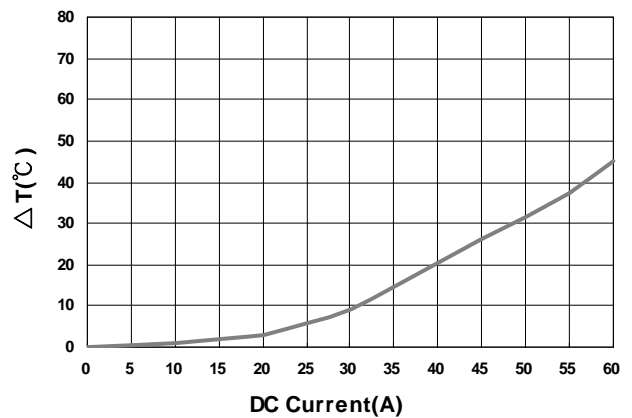
Note: When ordering, please specify tolerance code. Tolerance: K=±10% , L=±15%

- Customized Specifications are available
- Operating temperature range - 40°C ~ 125°C(Including self - temperature rise)
- OCL (Open Circuit Inductance) Test parameters: 100kHz, 0.25Vrms, 0Adc & Isat @20°C
- DC current for an approximate ΔT of 40°C without core loss. Derating is necessary for AC currents. PCB layout, trace thickness and width, airflow, and proximity of other heat generating components will affect the temperature rise. It is recommended that the temperature of the part not exceed 155°C under worst case operating conditions verified in the end application.
- Measure Equipment :
 L : WK4237METER
 RDC : CHEN HWA 502
 Isat : WK3260B+WK3265B

Inductance vs. DC Current



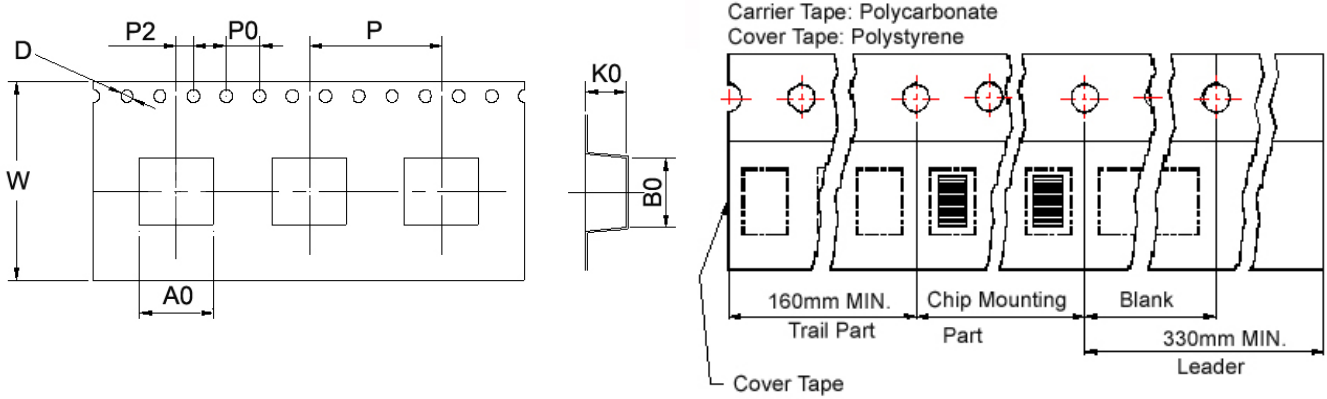
Temperature Change vs. DC Current



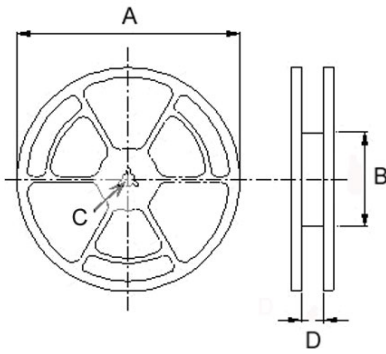
Please be sure to request approval specifications that provide further details of the products. Kindly note that the content of these specifications are subject to change or may be discontinued without advance notice. Please contact our sales department before ordering.

Packaging Specifications

Tape Dimensions



Reel Dimensions



Dimensions in mm

| TYPE | Tape Dimensions | | | | | | | | Reel Dimensions | | | | Quantity |
|-----------|-----------------|------|-----|-----|----|----|----|----|-----------------|-----|------|----|------------|
| | A0 | B0 | K0 | D | W | P | P0 | P2 | A | B | C | D | PCS / REEL |
| SFD100707 | 7.4 | 10.6 | 7.6 | 1.5 | 24 | 12 | 4 | 2 | 330 | 100 | 13.5 | 24 | 640 |
| SFS100875 | 8.0 | 10.3 | 7.7 | 1.5 | 24 | 12 | 4 | 2 | 330 | 100 | 13.5 | 24 | 700 |

CPUS Series



CPUS Series is designed for low RDC and ultra large current application. Its assembly model and magnetic shielding is suitable for high-density mounting. This series also provides customers with embossed carrier type packaging for automatic mounting machine.

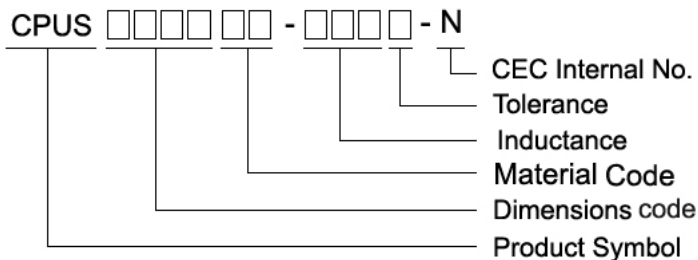
Features

- RoHS, Halogen Free and REACH Compliance
- Magnetic shielded
- Handle high transient current spikes without saturation
- Customized specifications are available

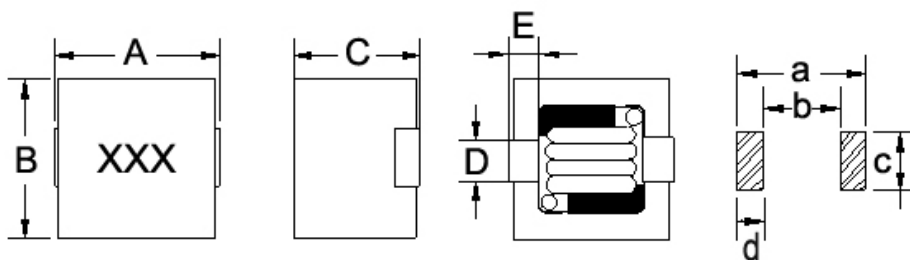
Applications

- Graphic card, PCs and servers

Product Identification



Shape and Dimensions



Dimensions in mm

| TYPE | A | B | C | D | E | a | b | c | d |
|------------|--------------------|--------------------|--------------------|---------|---------|------|-----|-----|-----|
| CPUS0807MN | 8.8 ⁺⁰ | 8.4 ⁺⁰ | 7.5 ⁺⁰ | 2.3±0.2 | 1.5±0.2 | 9.2 | 4.4 | 3.0 | 2.3 |
| CPUS1009MN | 11.3 ⁺⁰ | 10.4 ⁺⁰ | 9.7 ⁺⁰ | 3.0±0.2 | 1.6±0.2 | 11.3 | 6.9 | 3.6 | 2.2 |
| CPUS1210MN | 12.3 ⁺⁰ | 11.7 ⁺⁰ | 10.0 ⁺⁰ | 3.5±0.2 | 2.0±0.2 | 12.8 | 7.0 | 5.4 | 2.9 |

Electrical Characteristics

| Part Number | Inductance (μ H) | Tolerance (\pm %) | Test Frequency (KHz) | RDC (m Ω) Max | Isat (A) Max | Irms (A) Max | Marking |
|-------------------|--------------------------|-------------------------|----------------------------|--------------------------|-----------------|-----------------|---------|
| CPUS0807MN-R30M-N | 0.30 | 20 | 100 | 2.7 | 27 | 16 | R30 |
| CPUS0807MN-R47M-N | 0.47 | 20 | 100 | 3.1 | 25 | 15 | R47 |
| CPUS0807MN-R56M-N | 0.56 | 20 | 100 | 3.1 | 20 | 15 | R56 |
| CPUS0807MN-R68M-N | 0.68 | 20 | 100 | 3.1 | 17 | 15 | R68 |
| CPUS0807MN-1R0M-N | 1.0 | 20 | 100 | 4.3 | 15 | 13 | 1R0 |
| CPUS0807MN-1R5M-N | 1.5 | 20 | 100 | 6.2 | 11 | 10 | 1R5 |
| CPUS0807MN-2R2M-N | 2.2 | 20 | 100 | 6.2 | 8 | 10 | 2R2 |
| CPUS0807MN-3R3M-N | 3.3 | 20 | 100 | 9.0 | 5 | 8 | 3R3 |
| CPUS1009MN-R22M-N | 0.22 | 20 | 100 | 1.60 | 55 | 22 | R22 |
| CPUS1009MN-R33M-N | 0.33 | 20 | 100 | 1.60 | 42 | 22 | R33 |
| CPUS1009MN-R47M-N | 0.47 | 20 | 100 | 1.85 | 36 | 20 | R47 |
| CPUS1009MN-R56M-N | 0.56 | 20 | 100 | 1.85 | 32 | 20 | R56 |
| CPUS1009MN-R68M-N | 0.68 | 20 | 100 | 2.65 | 28 | 17 | R68 |
| CPUS1009MN-R82M-N | 0.82 | 20 | 100 | 2.65 | 24 | 17 | R82 |
| CPUS1009MN-1R0M-N | 1.0 | 20 | 100 | 2.65 | 21 | 17 | 1R0 |
| CPUS1009MN-1R5M-N | 1.5 | 20 | 100 | 4.00 | 17 | 13.5 | 1R5 |
| CPUS1009MN-2R2M-N | 2.2 | 20 | 100 | 5.30 | 14 | 12 | 2R2 |
| CPUS1009MN-3R3M-N | 3.3 | 20 | 100 | 7.70 | 10 | 11 | 3R3 |
| CPUS1009MN-4R7M-N | 4.7 | 20 | 100 | 10.8 | 8.5 | 10 | 4R7 |
| CPUS1009MN-6R8M-N | 6.8 | 20 | 100 | 16.9 | 7.0 | 9 | 6R8 |
| CPUS1009MN-8R2M-N | 8.2 | 20 | 100 | 16.9 | 6.0 | 9 | 8R2 |
| CPUS1009MN-100M-N | 10 | 20 | 100 | 26.0 | 5.0 | 7 | 100 |
| CPUS1210MN-R22M-N | 0.22 | 20 | 100 | 1.5 | 55 | 37 | R22 |
| CPUS1210MN-R33M-N | 0.33 | 20 | 100 | 1.5 | 45 | 37 | R33 |
| CPUS1210MN-R47M-N | 0.47 | 20 | 100 | 1.8 | 45 | 35 | R47 |
| CPUS1210MN-R56M-N | 0.56 | 20 | 100 | 1.8 | 35 | 35 | R56 |
| CPUS1210MN-R68M-N | 0.68 | 20 | 100 | 1.8 | 33 | 35 | R68 |
| CPUS1210MN-R82M-N | 0.82 | 20 | 100 | 2.4 | 31 | 30 | R82 |
| CPUS1210MN-1R0M-N | 1.0 | 20 | 100 | 2.4 | 28 | 30 | 1R0 |
| CPUS1210MN-1R5M-N | 1.5 | 20 | 100 | 3.5 | 24 | 25 | 1R5 |
| CPUS1210MN-2R2M-N | 2.2 | 20 | 100 | 4.7 | 18 | 21 | 2R2 |
| CPUS1210MN-3R3M-N | 3.3 | 20 | 100 | 6.3 | 14 | 15 | 3R3 |
| CPUS1210MN-4R7M-N | 4.7 | 20 | 100 | 8.8 | 11 | 12 | 4R7 |
| CPUS1210MN-6R8M-N | 6.8 | 20 | 100 | 12.5 | 9 | 10 | 6R8 |
| CPUS1210MN-8R2M-N | 8.2 | 20 | 100 | 13.0 | 7 | 9 | 8R2 |
| CPUS1210MN-100M-N | 10 | 20 | 100 | 18.7 | 6 | 8 | 100 |

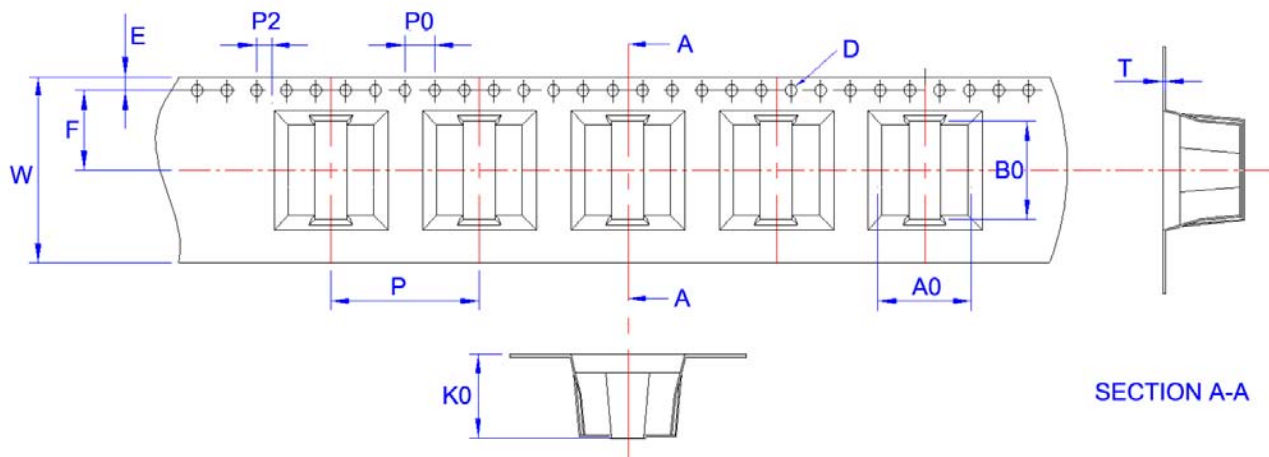
Note: When ordering, please specify tolerance code. Tolerance: M= \pm 20%

- Operating temperature range - 40°C ~ 125°C(Including self - temperature rise)
- Isat for Inductance drop 20% from its value without current
- Irms for a 40°C temperature rise from 25°C ambient with current
- Measure Equipment :
L : WK4237METER
RDC : HK502BC METER
Isat & Irms : WK3260B/ 3265B METER

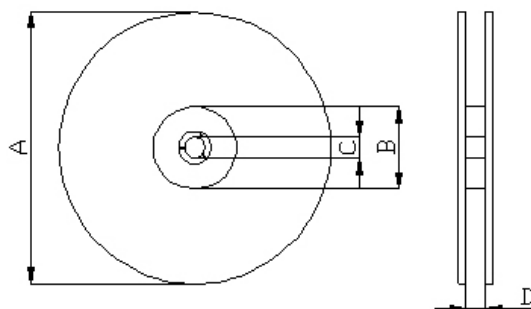
Please be sure to request approval specifications that provide further details of the products. Kindly note that the content of these specifications are subject to change or may be discontinued without advance notice. Please contact our sales department before ordering.

Packaging Specifications

Tape Dimensions



Reel Dimensions



Dimensions in mm

| TYPE | Tape Dimensions | | | | | | | | | | Reel Dimensions | | | | Quantity |
|------------|-----------------|------|-------|-----|------|----|-----|----|----|----|-----------------|----|------|----|------------|
| | A0 | B0 | K0 | D | E | W | T | P | P0 | P2 | A | B | C | D | PCS / REEL |
| CPUS0807MN | 8.25 | 9.0 | 7.4 | 1.5 | 1.75 | 24 | 0.4 | 16 | 4 | 2 | 330 | 75 | 13.5 | 24 | 500 |
| CPUS1009MN | 10.4 | 11.3 | 9.8 | 1.5 | 1.75 | 24 | 0.4 | 16 | 4 | 2 | 330 | 75 | 13.5 | 24 | 400 |
| CPUS1210MN | 11.8 | 12.6 | 10.55 | 1.5 | 1.75 | 24 | 0.5 | 20 | 4 | 2 | 330 | 75 | 13.5 | 24 | 300 |

SFP Series



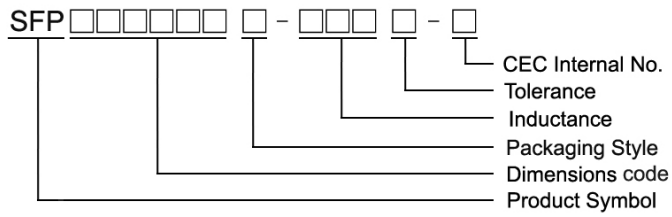
Features

- High current carrying capacity
- Flat wire windings provide exceptionally low DCR

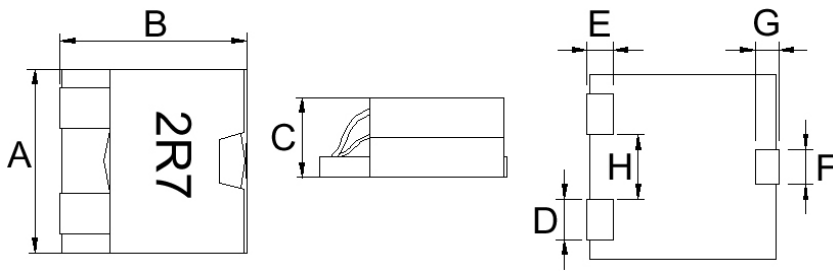
Applications

- High current, low voltage power supply applications
- Audio boost circuit

Product Identification



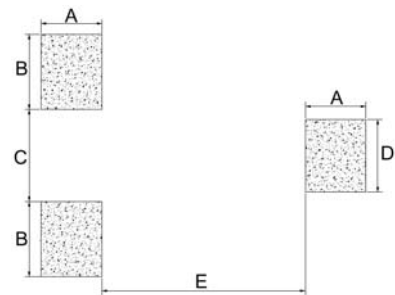
Shape and Dimensions



Dimensions in mm

| TYPE | A | B | C | D | E | F | G | H |
|-----------|----------|----------|-----------|---------|---------|---------|---------|---------|
| SFP131306 | 12.6±0.3 | 12.7±0.3 | 5.45±0.35 | 2.6±0.2 | 2.0±0.2 | 2.5±0.2 | 1.6±0.2 | 4.3±0.2 |

Recommended Pattern



Dimensions in mm

| TYPE | A | B | C | D | E |
|-----------|-----|-----|-----|-----|-----|
| SFP131306 | 2.5 | 3.1 | 3.8 | 3.0 | 8.4 |

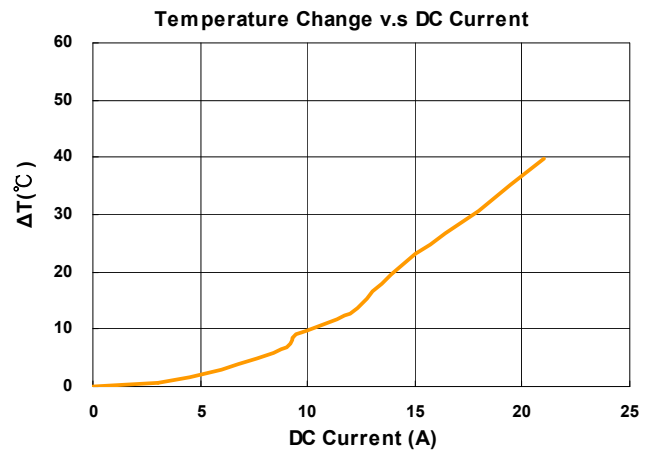
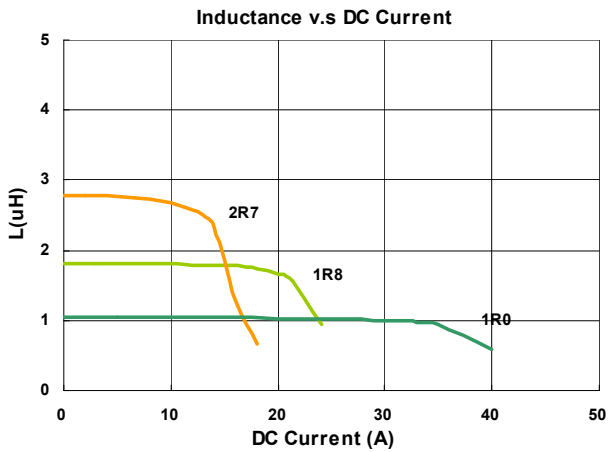
Electrical Characteristics

| Part Number | Inductance (μH) | Tolerance ($\pm\%$) | Frequency (kHz) | SRF | RDC | Isat 1 | Isat 2 | Isat 3 | Irms 1 (A) | Irms 2 (A) | Marking |
|-------------------|---------------------------------|--------------------------|--------------------|---------------|----------------------|-----------------|-----------------|-----------------|---------------|---------------|---------|
| | | | | (MHz) Typ. | (m Ω) Max | (A) Max(Typ) | (A) Max(Typ) | (A) Max(Typ) | | | |
| SFP131306T-1R0K-N | 1.0 | 10 | 100 | 75 | 2.6 | 25(32) | 26(33) | 27(33.5) | 9.5 | 13 | 1R0 |
| SFP131306T-1R8K-N | 1.8 | 10 | 100 | 50 | 2.6 | 14(17) | 16(19) | 16.5(20) | 9.5 | 13 | 1R8 |
| SFP131306T-2R7K-N | 2.7 | 10 | 100 | 42 | 2.6 | 9(12) | 10(13) | 11(14) | 10 | 13.5 | 2R7 |

Note: When ordering, please specify tolerance code. Tolerance: M= $\pm 20\%$

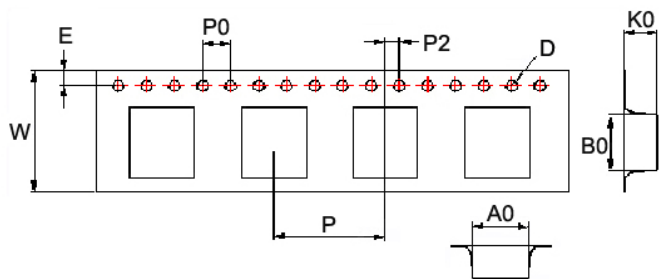
- Operating temperature range - 40°C ~ 125°C(Including self - temperature rise)
- Isat 1 for Inductance drop 10%
- Isat 2 for Inductance drop 20%
- Isat 3 for Inductance drop 30%
- Irms 1 for a 20°C temperature rise from 25°C ambient with current
- Irms 2 for a 40°C temperature rise from 25°C ambient with current
- Measure Equipment :
 L : E4980 or HP4284A , 100kHz/ 0.1V
 RDC : Chroma 16502
 Isat : HP4284A+HP42841A or WK3260B+WK3265B

Test Instruments : HP4294A Impedance / Material Analyzer

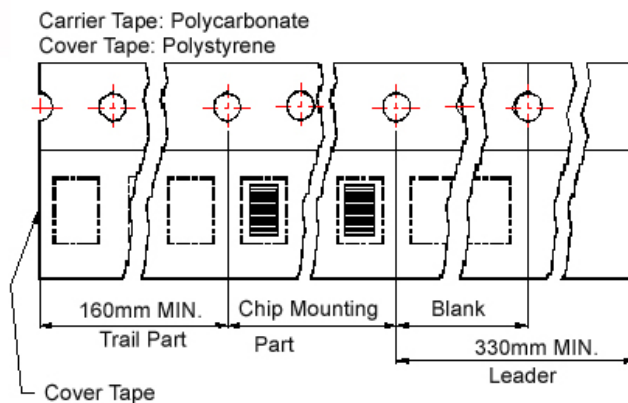


Packaging Specifications

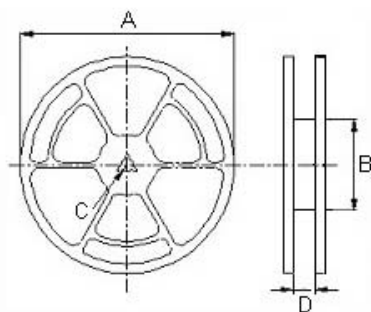
Tape Dimensions



Tape Material



Reel Dimensions



Dimensions in mm

| TYPE | Tape Dimensions | | | | | | | | | Reel Dimensions | | | | Quantity |
|-----------|-----------------|------|-----|------|------|----|----|----|----|-----------------|-----|----|------|------------|
| | A0 | B0 | K0 | D | E | W | P | P0 | P2 | A | B | C | D | PCS / REEL |
| SFP131306 | 13.1 | 13.2 | 6.4 | 1.55 | 1.75 | 24 | 16 | 4 | 2 | 330 | 100 | 13 | 24.4 | 500 |

SCDS Series

Features

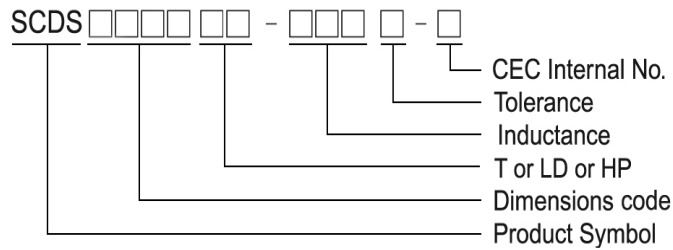
- RoHS, Halogen Free and REACH Compliance
- Magnetic shielded
- Various package size and wide inductance range

Applications

- AP Routers
- STBs
- LCD TVs and monitors
- Game consoles
- LED lightings
- DC/DC converters

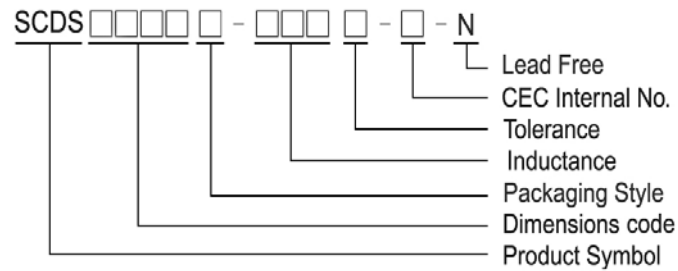
Product Identification

SCDS



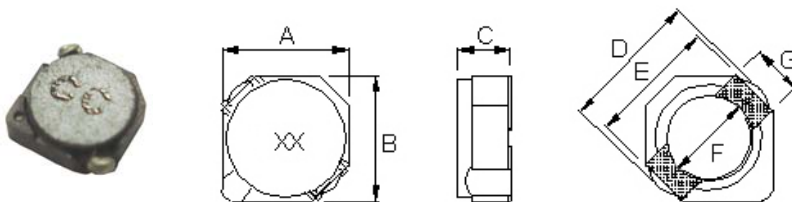
- T : Packaging: Tape and Reel
- HP : High Power
- LD : Low DCR
- CEC Internal No.: S: Base type terminals

SCDS3D16



SCDS2D11/2D14/2D18LD/ 2D18HP

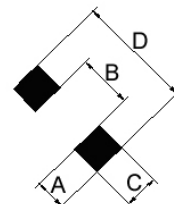
Shape and Dimensions



Dimension in mm

| TYPE | A | B | C | D | E | F | G |
|------------|-------------------|-------------------|--------------------|-------------------|-----|-----|-----|
| SCDS2D11 | 3.2 ⁺⁰ | 3.2 ⁺⁰ | 1.2 ⁺⁰ | 4.5 ⁺⁰ | 3.3 | 2.1 | 1.0 |
| SCDS2D14 | 3.2 ⁺⁰ | 3.2 ⁺⁰ | 1.55 ⁺⁰ | 4.5 ⁺⁰ | 3.3 | 2.1 | 1.0 |
| SCDS2D18LD | 3.2 ⁺⁰ | 3.2 ⁺⁰ | 2.0 ⁺⁰ | 4.5 ⁺⁰ | 3.3 | 2.1 | 1.0 |
| SCDS2D18HP | 3.2 ⁺⁰ | 3.2 ⁺⁰ | 2.0 ⁺⁰ | 4.5 ⁺⁰ | 3.3 | 2.1 | 1.0 |

Recommended Pattern



Dimensions in mm

| TYPE | A | B | C | D |
|------------|-----|-----|-----|-----|
| SCDS2D11 | 1.3 | 1.7 | 1.3 | 4.3 |
| SCDS2D14 | 1.3 | 1.7 | 1.3 | 4.3 |
| SCDS2D18LD | 1.3 | 1.7 | 1.3 | 4.3 |
| SCDS2D18HP | 1.3 | 1.7 | 1.3 | 4.3 |

Standard Specifications

| Stamp | Inductance (μH) | RDC (mΩ) Max | | | | | | | | |
|-------|-----------------|--------------|-----------|-------------|-------------|-----------|-------------|-----------|-----------|-------------|
| | | SCDS 2D11 | SCDS 2D14 | SCDS 2D18LD | SCDS 2D18HP | SCDS 3D11 | SCDS 3D11HP | SCDS 3D16 | SCDS 3D28 | SCDS 3D28LD |
| R47 | 0.47 | | 40 | | | | | | | |
| R60 | 0.6 | | | | | | 59 | | | |
| 1R0 | 1.0 | | | | | | | 40 | 45 | |
| 1R2 | 1.2 | | | | | | 82 | | | |
| 1R5 | 1.5 | 68 | 63 | | 44 | | 104 | 52 | | |
| 1R7 | 1.7 | | | | 44 | | | | | |
| 1R8 | 1.8 | | 75 | | | | | | | |
| 2R2 | 2.2 | 98 | 94 | 41 | 60 | | 143 | 72 | | |
| 2R7 | 2.7 | | 106 | | | 78 | | | | |
| 3R3 | 3.3 | 123 | 125 | 54 | 86 | | 182 | 85 | 72.1 | |
| 3R9 | 3.9 | 160 | 138 | | | | | | | |
| 4R1 | 4.1 | | 169 | | | | | | | |
| 4R7 | 4.7 | 170 | 169 | 78 | 140 | 123 | 234 | 105 | 88.3 | |
| 5R6 | 5.6 | | 188 | | | | | 135 | | |
| 6R3 | 6.3 | | | | 160 | | | | | |
| 6R8 | 6.8 | 260 | 213 | 106 | 195 | 180 | 377 | 170 | 119 | |
| 8R2 | 8.2 | | 281 | | | 204 | | 210 | | |
| 100 | 10 | 400 | 294 | 180 | 245 | 240 | 413 | 210 | 145 | 95 |
| 120 | 12 | | 394 | | | 276 | 585 | | | 100 |
| 150 | 15 | 600 | | 220 | 345 | 372 | 653 | 295 | 213 | 115 |
| 180 | 18 | | | | | 468 | 888 | | | 125 |
| 220 | 22 | 950 | | 320 | 650 | 540 | 1010 | 430 | 335 | 145 |
| 270 | 27 | | | | | 726 | | | | 175 |
| 330 | 33 | | | 460 | | 822 | | 675 | 481 | 215 |
| 390 | 39 | | | 600 | | 942 | | | | 225 |
| 470 | 47 | | | 660 | | | | | 599 | 305 |
| 560 | 56 | | | | | | | | | 325 |
| 680 | 68 | | | | | | | | | 470 |
| 820 | 82 | | | | | | | | | 540 |
| 101 | 100 | | | | | | | 2750 | | 610 |
| 121 | 120 | | | | | | | | | 755 |
| 151 | 150 | | | | | | | | | 880 |
| 181 | 180 | | | | | | | | | 1130 |
| 221 | 220 | | | | | | | | | 1270 |

Note: When ordering, please specify tolerance code. Tolerance: M=±20% , T=±30% , N = ⁺⁴⁰/₋₂₀%

- Operating temperature range - 30°C ~ 100°C(Including self - temperature rise)
- Rated Current : DC current that will cause L drop approximately 35% over its nominal value or DC current cause the temperature rising approximately Δt=40°C, whichever is lower
- Irms for a 40°C temperature rise from 25°C ambient with current
- Measure Equipment :
 Test Freq L : SCDS 2D11/ 2D14/ 2D18LP/2D18HP/3D11/3D11HP/3D28/3D28LD (100kHz/ 1V), SCDS 3D16 (100kHz/ 0.1V)
 L : Agilent/ E4980 or HP4284A
 RDC : Chroma 16502
 Rated Current : HP4284+42841A or WK3260B+WK3265B

Please be sure to request approval specifications that provide further details of the products. Kindly note that the content of these specifications are subject to change or may be discontinued without advance notice. Please contact our sales department before ordering.

Standard Specifications

| Stamp | Inductance (μH) | Rated Current (A) | | | | | | | | |
|-------|-----------------|-------------------|-----------|-------------|-------------|-----------|-------------|-----------|-----------|-------------|
| | | SCDS 2D11 | SCDS 2D14 | SCDS 2D18LD | SCDS 2D18HP | SCDS 3D11 | SCDS 3D11HP | SCDS 3D16 | SCDS 3D28 | SCDS 3D28LD |
| R47 | 0.47 | | 2.00 | | | | | | | |
| R60 | 0.6 | | | | | | 2.90 | | | |
| 1R0 | 1.0 | | | | | | | 1.60 | 2.80 | |
| 1R2 | 1.2 | | | | | | 2.00 | | | |
| 1R5 | 1.5 | 0.90 | 1.80 | | 1.90 | | 1.85 | 1.55 | | |
| 1R7 | 1.7 | | | | 1.85 | | | | | |
| 1R8 | 1.8 | | 1.65 | | | | | | | |
| 2R2 | 2.2 | 0.78 | 1.50 | 0.85 | 1.60 | | 1.60 | 1.20 | | |
| 2R7 | 2.7 | | 1.35 | | | 0.53 | | | | |
| 3R3 | 3.3 | 0.60 | 1.20 | 0.75 | 1.45 | | 1.25 | 1.10 | 2.00 | |
| 3R9 | 3.9 | 0.60 | 1.10 | | | | | | | |
| 4R1 | 4.1 | | 1.00 | | | | | | | |
| 4R7 | 4.7 | 0.50 | 1.00 | 0.63 | 1.20 | 0.40 | 1.00 | 0.90 | 1.65 | |
| 5R6 | 5.6 | | 0.95 | | | | | 0.80 | | |
| 6R3 | 6.3 | | | | 1.05 | | | | | |
| 6R8 | 6.8 | 0.44 | 0.85 | 0.52 | 1.00 | 0.34 | 0.85 | 0.73 | 1.24 | |
| 8R2 | 8.2 | | 0.80 | | | 0.32 | | 0.55 | | |
| 100 | 10 | 0.35 | 0.70 | 0.43 | 0.85 | 0.28 | 0.80 | 0.55 | 1.05 | 0.50 |
| 120 | 12 | | 0.62 | | | 0.25 | 0.64 | | | 0.45 |
| 150 | 15 | 0.25 | | 0.35 | 0.70 | 0.23 | 0.58 | 0.45 | 0.90 | 0.40 |
| 180 | 18 | | | | | 0.21 | 0.52 | | | 0.35 |
| 220 | 22 | 0.16 | | 0.30 | 0.50 | 0.19 | 0.45 | 0.40 | 0.76 | 0.33 |
| 270 | 27 | | | | | 0.17 | | | | 0.29 |
| 330 | 33 | | | 0.24 | | 0.15 | | 0.32 | 0.58 | 0.28 |
| 390 | 39 | | | 0.22 | | 0.14 | | | | 0.25 |
| 470 | 47 | | | 0.20 | | | | | 0.48 | 0.23 |
| 560 | 56 | | | | | | | | | 0.20 |
| 680 | 68 | | | | | | | | | 0.185 |
| 820 | 82 | | | | | | | | | 0.172 |
| 101 | 100 | | | | | | | 0.13 | | 0.160 |
| 121 | 120 | | | | | | | | | 0.136 |
| 151 | 150 | | | | | | | | | 0.124 |
| 181 | 180 | | | | | | | | | 0.119 |
| 221 | 220 | | | | | | | | | 0.116 |

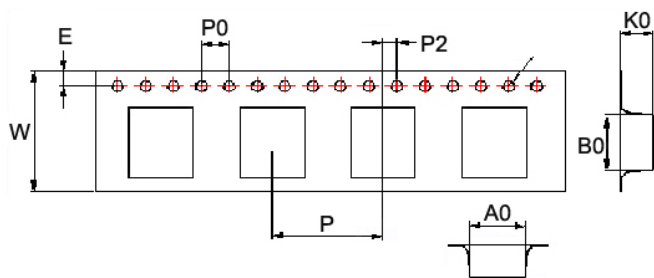
Tolerance Of Inductors

- SCDS 2D11 1.5 ~ 22μH ± 30%
- SCDS 2D14 0.47 ~ 12μH ± 30%
- SCDS 2D18LD 2.2 ~ 47μH ± 30%
- SCDS 2D18HP 1.5 ~ 22μH ± 30%
- Tolerance : M = ±20% , T = ±30% , N = ⁺⁴⁰₋20%
- SCDS3D11 2.7 ~ 39 uH ± 30%
- SCDS3D11HP 0.6 ~ 22 uH ± 30%
- SCDS3D16 1.0 ~ 100 uH ± 30%
- SCDS3D28 1.0 ~ 47 uH ± 30%
- SCDS3D28LD 10 ~ 220 uH ± 30%

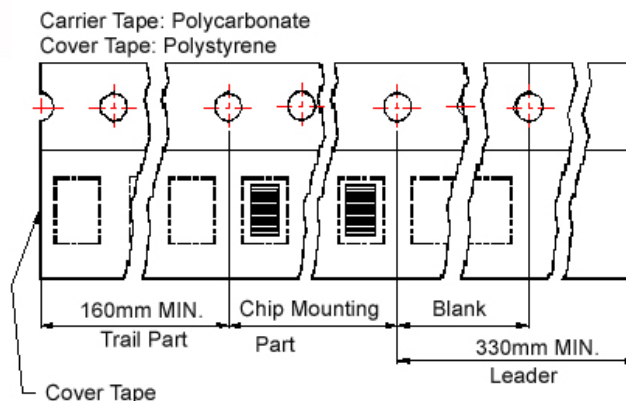
Please be sure to request approval specifications that provide further details of the products. Kindly note that the content of these specifications are subject to change or may be discontinued without advance notice. Please contact our sales department before ordering.

Packaging Specifications

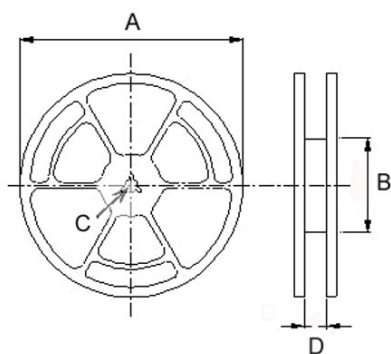
Tape Dimensions



Tape Material



Reel Dimensions



Dimensions in mm

| TYPE | Tape Dimensions | | | | | | | | | Reel Dimensions | | | | Quantity |
|-----------|-----------------|------|-----|------|------|----|---|----|----|-----------------|----|----|------|------------|
| | A0 | B0 | K0 | D | E | W | P | P0 | P2 | A | B | C | D | PCS / REEL |
| SCDS 2D11 | 3.35 | 3.35 | 1.4 | 1.55 | 1.75 | 12 | 8 | 4 | 2 | 178 | 60 | 13 | 13.2 | 1000 |
| SCDS 2D14 | 3.35 | 3.35 | 1.7 | 1.55 | 1.75 | 12 | 8 | 4 | 2 | 178 | 60 | 13 | 13.2 | 1000 |
| SCDS 2D18 | 3.5 | 3.5 | 2.1 | 1.55 | 1.75 | 12 | 8 | 4 | 2 | 178 | 60 | 13 | 13.2 | 1000 |
| SCDS 3D11 | 4.2 | 4.2 | 1.5 | 1.55 | 1.75 | 12 | 8 | 4 | 2 | 178 | 60 | 13 | 13.2 | 1000 |
| SCDS 3D16 | 4.1 | 4.1 | 2.0 | 1.5 | 1.75 | 12 | 8 | 4 | 2 | 178 | 60 | 13 | 13.2 | 1000 |
| SCDS 3D28 | 4.2 | 4.2 | 3.2 | 1.55 | 1.75 | 12 | 8 | 4 | 2 | 178 | 60 | 13 | 13.2 | 500 |

SCDS Series

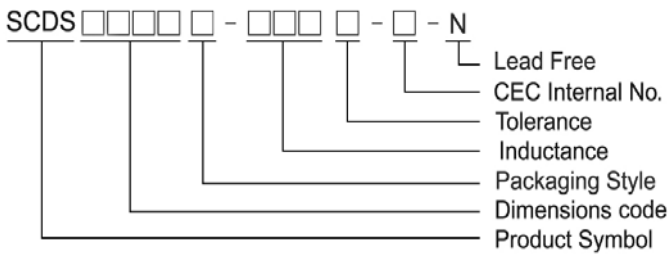
Features

- RoHS, Halogen Free and REACH Compliance
- Magnetic shielded
- Various package size and wide inductance range

Applications

- AP Routers
- STBs
- LCD TVs and monitors
- Game consoles
- LED lightings
- DC/DC converters

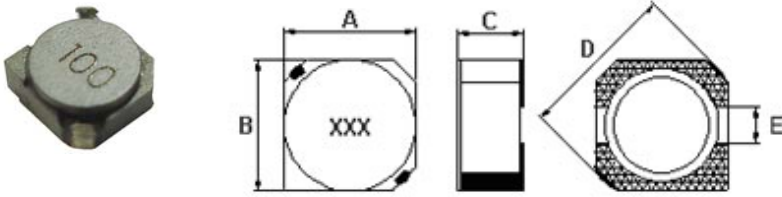
Product Identification



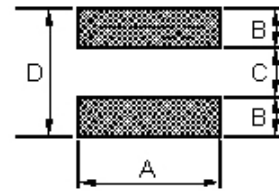
- T : Packaging: Tape and Reel
- CEC Internal No.: S: Base type terminals

SCDS 3D16T-XXXX-S-N

Shape and Dimensions



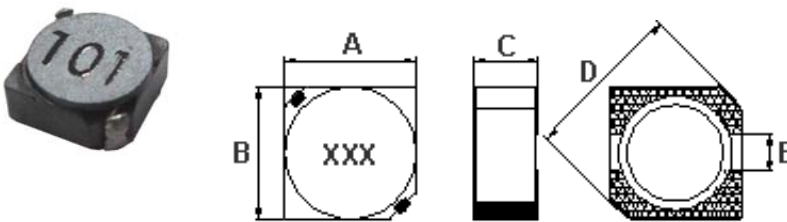
Recommended Pattern



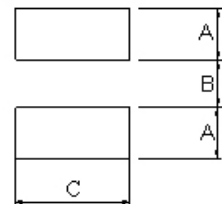
| Dimensions in mm | | | | | | Dimension in mm | | | | |
|------------------|-----------------|-----------------|-------------------|-------------------|-----|-----------------|-----|-----|-----|-----|
| TYPE | A | B | C | D | E | TYPE | A | B | C | D |
| SCDS3D16 | 4 ⁺⁰ | 4 ⁺⁰ | 1.8 ⁺⁰ | 5.2 ⁺⁰ | 1.0 | SCDS3D16 | 4.6 | 1.6 | 1.4 | 4.6 |

SCDS 4D18 ~ 6D38

Shape and Dimensions



Recommended Pattern



| Dimension in mm | | | | | | Dimension in mm | | | |
|-----------------|-----------------|-----------------|-------------------|-------------------|-----|-----------------|------|-----|-----|
| TYPE | A | B | C | D | E | TYPE | A | B | C |
| SCDS4D18 | 4.7 ± 0.3 | 4.7 ± 0.3 | 2.0 ⁺⁰ | 6.9 ⁺⁰ | 1.5 | SCDS4D18 | 1.9 | 1.5 | 5.3 |
| SCDS4D28 | 4.7 ± 0.3 | 4.7 ± 0.3 | 3.0 ⁺⁰ | 6.9 ⁺⁰ | 1.5 | SCDS4D28 | 1.9 | 1.5 | 5.3 |
| SCDS4D40 | 4.7 ± 0.3 | 4.7 ± 0.3 | 4 ⁺⁰ | 6.9 ⁺⁰ | 1.5 | SCDS4D40 | 1.9 | 1.5 | 5.3 |
| SCDS5D18 | 5.7 ± 0.3 | 5.7 ± 0.3 | 2.0 ⁺⁰ | 8.2 ⁺⁰ | 2.0 | SCDS5D18 | 2.15 | 2.0 | 6.3 |
| SCDS5D28 | 5.7 ± 0.3 | 5.7 ± 0.3 | 3.0 ⁺⁰ | 8.2 ⁺⁰ | 2.0 | SCDS5D28 | 2.15 | 2.0 | 6.3 |
| SCDS6D28 | 6.7 ± 0.3 | 6.7 ± 0.3 | 3.0 ⁺⁰ | 9.5 ⁺⁰ | 2.0 | SCDS6D28 | 2.65 | 2.0 | 7.3 |
| SCDS6D38 | 7 ⁺⁰ | 7 ⁺⁰ | 4 ⁺⁰ | 9.5 ⁺⁰ | 2.0 | SCDS6D38 | 2.65 | 2.0 | 7.3 |

Standard Specifications

| Stamp | Inductance (μ H) | RDC (m Ω) Max | | | | | | | | Rated Current (A) | | | | | | | |
|-------|--------------------------|-----------------------|------|-------|------|------|------|------|------|-------------------|------|------|------|------|--------|------|------|
| | | SCDS | SCDS | SCDS | SCDS | SCDS | SCDS | SCDS | SCDS | SCDS | SCDS | SCDS | SCDS | SCDS | SCDS | SCDS | SCDS |
| | | 3D16 | 4D18 | 4D28 | 4D40 | 5D18 | 5D28 | 6D28 | 6D38 | 3D16 | 4D18 | 4D28 | 4D40 | 5D18 | 5D28 | 6D28 | 6D38 |
| 1R0 | 1.0 | | 45 | | | 38 | 15 | 24 | | | 1.72 | | | 2.80 | 3.50 | 3.50 | |
| 1R2 | 1.2 | | | 23.6 | | | | | | | | 2.56 | | | | | |
| 1R5 | 1.5 | 52 | 60 | | | 38 | 15 | 19.5 | | 1.55 | 1.50 | | | 2.50 | 3.00 | 3.40 | |
| 1R8 | 1.8 | | 70 | 27.5 | | | | | | | 1.35 | 2.20 | | | | | |
| 2R0 | 2.0 | | | 29.0 | | 45 | | | | | | 2.10 | | 2.50 | | | |
| 2R2 | 2.2 | 72 | 75 | 31.3 | 22 | 48 | 18 | 35 | 18 | 1.20 | 1.32 | 2.04 | 4.6 | 1.90 | 2.60 | 3.00 | 3.80 |
| 2R5 | 2.5 | | | | | | 18 | | | | | | | | 2.60 | | |
| 2R6 | 2.6 | | | | | | 22 | | | | | | | | 2.40 | | |
| 2R7 | 2.7 | | 105 | 43.3 | | | | | 20 | | 1.28 | 1.60 | | | | | 3.60 |
| 3R0 | 3.0 | | | | | | 24 | 24 | | | | | | | 2.40 | 3.00 | |
| 3R3 | 3.3 | 85 | 110 | 49.2 | 33 | 56 | 27 | 25 | 20 | 1.10 | 1.04 | 1.57 | 3.4 | 1.90 | 2.10 | 3.00 | 3.50 |
| 3R6 | 3.6 | 90 | | | | | | | | 0.95 | | | | | | | |
| 3R9 | 3.9 | | 155 | 64.8 | | | | | 27 | | 0.88 | 1.44 | | | | 2.60 | |
| 4R1 | 4.1 | | | | | 57 | | | | | | | | 1.95 | | | |
| 4R2 | 4.2 | | | | | | 31 | | | | | | | | 2.20 | | |
| 4R3 | 4.3 | | | | | | 41 | | | | | | | | 2.5Typ | | |
| 4R7 | 4.7 | 105 | 162 | 72.0 | 44 | 76 | 38 | 31 | 22 | 0.90 | 0.84 | 1.32 | 2.8 | 1.60 | 1.90 | 2.40 | 3.10 |
| 5R0 | 5.0 | | | | | | 38 | 31 | 24 | | | | | | 1.90 | 2.40 | 2.90 |
| 5R3 | 5.3 | | | | | | 38 | | | | | | | | 1.90 | | |
| 5R4 | 5.4 | | | | | 76 | | | | | | | | 1.60 | | | |
| 5R6 | 5.6 | | 170 | 100.9 | | | | | 27 | | 0.80 | 1.17 | | | | | 2.50 |
| 6R0 | 6.0 | | | | | | | 35 | | | | | | | | 2.25 | |
| 6R2 | 6.2 | | | | | 96 | 45 | 51 | 27 | | | | | 1.40 | 1.80 | 2.40 | 2.50 |
| 6R3 | 6.3 | | 180 | | | | | | | | 0.78 | | | | | | |
| 6R8 | 6.8 | 170 | 200 | 108.9 | 46 | 100 | 50 | 50 | 31 | 0.73 | 0.76 | 1.12 | 2.6 | 1.35 | 1.65 | 2.15 | 2.30 |
| 7R3 | 7.3 | | | | | | | 54 | | | | | | | | 2.10 | |
| 7R4 | 7.4 | | | | | | | | 31 | | | | | | | | 2.30 |
| 8R2 | 8.2 | | 245 | 117.5 | | | 53 | | | | 0.68 | 1.04 | | | 1.60 | | |
| 8R6 | 8.6 | | | | | | | 58 | | | | | | | | 1.85 | |
| 8R7 | 8.7 | | | | | | | | 34 | | | | | | | | 2.20 |
| 8R9 | 8.9 | | | | | 116 | | | | | | | | 1.25 | | | |
| 100 | 10 | 210 | 280 | 128.3 | 150 | 124 | 65 | 65 | 38 | 0.55 | 0.61 | 1.00 | 1.8 | 1.20 | 1.30 | 1.70 | 2.00 |
| 120 | 12 | | 320 | 131.6 | | 153 | 76 | 70 | 53 | | 0.56 | 0.84 | | 1.10 | 1.20 | 1.55 | 1.70 |
| 150 | 15 | 295 | 360 | 149.0 | 210 | 196 | 103 | 84 | 57 | 0.45 | 0.50 | 0.76 | 1.6 | 0.97 | 1.10 | 1.40 | 1.60 |
| 180 | 18 | | 400 | 166.0 | | 210 | 110 | 95 | 92 | | 0.48 | 0.72 | | 0.85 | 1.00 | 1.32 | 1.50 |
| 220 | 22 | 430 | 480 | 235.0 | 270 | 290 | 122 | 128 | 96 | 0.40 | 0.41 | 0.70 | 1.4 | 0.80 | 0.90 | 1.20 | 1.30 |
| 270 | 27 | 620 | 570 | 261.0 | | 330 | 175 | 142 | 109 | 0.35 | 0.35 | 0.58 | | 0.75 | 0.85 | 1.05 | 1.20 |
| 330 | 33 | 675 | 694 | 331.3 | | 386 | 189 | 165 | 124 | 0.32 | 0.32 | 0.56 | | 0.65 | 0.75 | 0.97 | 1.10 |
| 390 | 39 | | 800 | 383.7 | | 520 | 212 | 210 | 138 | | 0.30 | 0.50 | | 0.57 | 0.70 | 0.86 | 1.00 |
| 470 | 47 | | 950 | 587.0 | | 595 | 250 | 238 | 150 | | 0.28 | 0.48 | | 0.54 | 0.62 | 0.80 | 0.95 |
| 560 | 56 | | 1080 | 624.5 | | 665 | 305 | 277 | 202 | | 0.26 | 0.41 | | 0.50 | 0.58 | 0.73 | 0.85 |
| 680 | 68 | 1700 | 1300 | 699.0 | | 840 | 355 | 304 | 234 | 0.18 | 0.24 | 0.35 | | 0.43 | 0.52 | 0.65 | 0.75 |
| 820 | 82 | | | 914.8 | | 978 | 463 | 390 | 324 | | | 0.32 | | 0.41 | 0.46 | 0.60 | 0.70 |
| 101 | 100 | | 2000 | 1020 | | 1200 | 520 | 535 | 358 | | 0.20 | 0.29 | | 0.36 | 0.42 | 0.54 | 0.65 |
| 121 | 120 | | | 1270 | | | | | | | | 0.27 | | | | | |
| 151 | 150 | | 2840 | 1350 | | | | | | | 0.15 | 0.24 | | | | | |
| 181 | 180 | | | 1540 | | | 1050 | | | | | 0.22 | | | | 0.29 | |
| 221 | 220 | 5500 | | 2000 | | | 1200 | | | 0.08 | | 0.20 | | | | 0.28 | |
| 331 | 330 | | | 3400 | | | 1700 | | | | | 0.19 | | | 0.19 | | |
| 391 | 390 | | | 3560 | | | 1800 | | | | | 0.18 | | | 0.18 | | |
| 471 | 470 | | | | | | 2500 | | | | | | | | 0.15 | | |
| 561 | 560 | | | | | | 3200 | | 1800 | | | | | | 0.12 | | 0.22 |
| 681 | 680 | | | 5200 | | | | | | | | 0.10 | | | | | |

Please be sure to request approval specifications that provide further details of the products. Kindly note that the content of these specifications are subject to change or may be discontinued without advance notice. Please contact our sales department before ordering.



SMD Shielded Power Inductors - SCDS Series

Note: When ordering, please specify tolerance code. Tolerance: M=±20% , T=±30% , N = ⁺⁴⁰/₋₂₀%

- Operating temperature range - 30°C ~ 100°C(Including self - temperature rise)
- Rated Current : DC current that will cause L drop approximately 35% over its nominal value or DC current cause the temperature rising approximately $\Delta t=40^{\circ}\text{C}$, whichever is lower
- Measure Equipment :
Test Freq L : SCDS 3D16(100kHz/ 0.1V) , 4D28/ 4D40 (100kHz/ 1V) , SCDS 5D18/ 5D28/ 6D28/ 6D38 (10kHz/ 1V)
SCDS 4D18: 1.0~8.2 μH (7.96MHz/ 1V), 10~150 μH (100kHz/ 1V)

L : Agilent/ E4980 or HP4284A

RDC : Chroma 16502

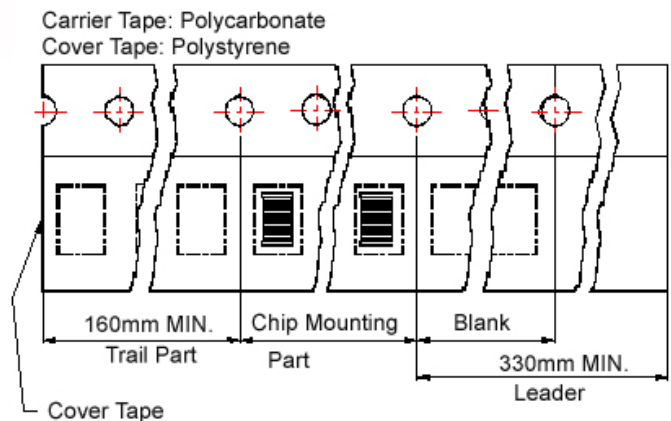
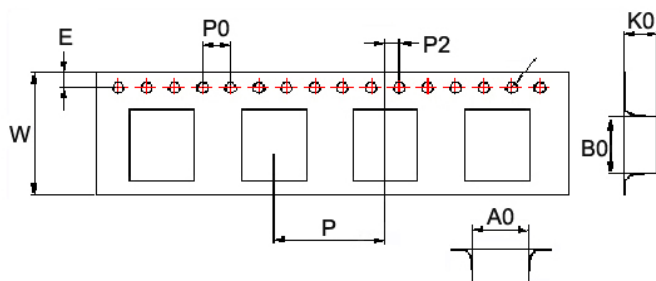
Rated Current : HP4284+42841A or WK3260B+WK3265B

Tolerance Of Inductors

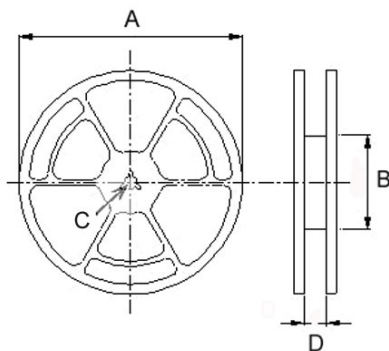
- SCDS 3D16 1.5 ~ 220 μH ± 30%
- SCDS 4D18 1.0 ~ 150 μH ± 30%
- SCDS 4D28 1.2 ~ 680 μH ± 30%
- SCDS 4D40 2.2 ~ 22 μH ± 30%
- SCDS 5D18 1.0 ~ 100 μH ± 30%
- SCDS 5D28 1.0 ~ 560 μH ± 30%
- SCDS 6D28 1.0 ~ 100 μH ± 30%
- SCDS 6D38 2.2 ~ 560 μH ± 30%
- Tolerance : M = ±20% , T = ±30% , N = ⁺⁴⁰/₋₂₀%

Packaging Specifications

Tape Dimensions



Reel Dimensions



Dimensions in mm

| TYPE | Tape Dimensions | | | | | | | | | Reel Dimensions | | | | Quantity |
|-----------|-----------------|------|------|------|------|----|----|----|----|-----------------|-----|----|------|------------|
| | A0 | B0 | K0 | D | E | W | P | P0 | P2 | A | B | C | D | PCS / REEL |
| SCDS 3D16 | 4.1 | 4.1 | 2.0 | 1.5 | 1.75 | 12 | 8 | 4 | 2 | 178 | 60 | 13 | 13.2 | 1000 |
| SCDS 4D18 | 5.3 | 5.3 | 2.4 | 1.5 | 1.75 | 12 | 8 | 4 | 2 | 330 | 100 | 13 | 13.4 | 2000 |
| SCDS 4D28 | 5.3 | 5.3 | 3.4 | 1.5 | 1.75 | 12 | 8 | 4 | 2 | 330 | 100 | 13 | 13.4 | 2000 |
| SCDS 4D40 | 5.35 | 5.35 | 4.1 | 1.55 | 1.75 | 12 | 8 | 4 | 2 | 330 | 100 | 13 | 13.4 | 1000 |
| SCDS 5D18 | 6.2 | 6.2 | 2.2 | 1.5 | 1.75 | 12 | 8 | 4 | 2 | 330 | 100 | 13 | 13.4 | 2000 |
| SCDS 5D28 | 6.2 | 6.2 | 3.2 | 1.5 | 1.75 | 12 | 8 | 4 | 2 | 330 | 100 | 13 | 13.4 | 2000 |
| SCDS 6D28 | 7.25 | 7.25 | 3.35 | 1.55 | 1.75 | 16 | 12 | 4 | 2 | 330 | 100 | 13 | 16.0 | 1500 |
| SCDS 6D38 | 7.1 | 7.1 | 4.1 | 1.55 | 1.75 | 16 | 12 | 4 | 2 | 330 | 100 | 13 | 16.0 | 1000 |

Please be sure to request approval specifications that provide further details of the products. Kindly note that the content of these specifications are subject to change or may be discontinued without advance notice. Please contact our sales department before ordering.



CHILISIN ELECTRONICS CORP.

SCDS Series

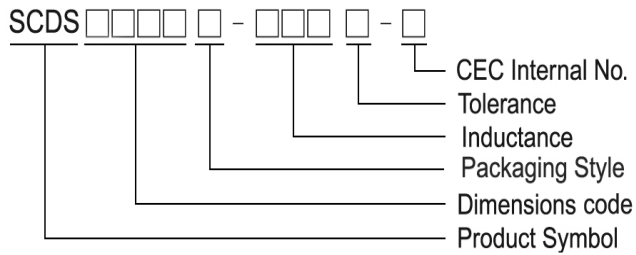
Features

- RoHS, Halogen Free and REACH Compliance
- Magnetic shielded
- Various package size and wide inductance range

Applications

- AP Routers
- STBs
- LCD TVs and monitors
- Game consoles
- LED lightings
- DC/DC converters

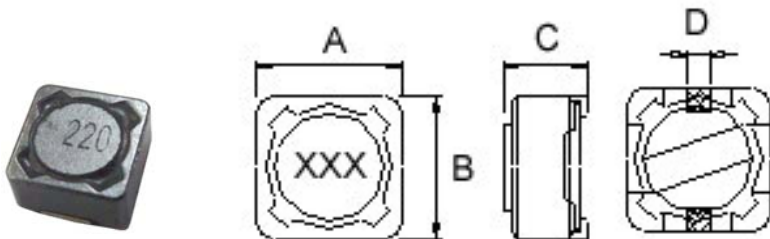
Product Identification



- T : Packaging: Tape and Reel

SCDS 73/ 74

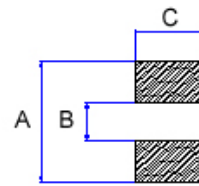
Shape and Dimensions



Dimension in mm

| TYPE | A | B | C | D |
|--------|---------|---------|-------------------|-----|
| SCDS73 | 7.3±0.2 | 7.3±0.2 | 3.4 ⁺⁰ | 1.8 |
| SCDS74 | 7.3±0.2 | 7.3±0.2 | 4.5 ⁺⁰ | 1.8 |

Recommended Pattern

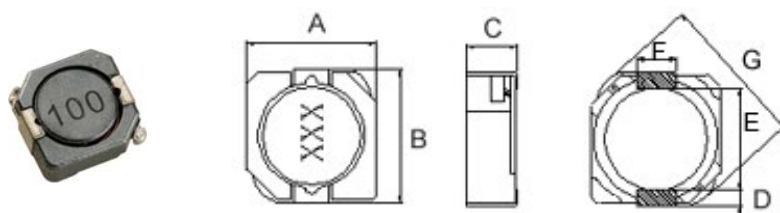


Dimension in mm

| TYPE | A | B | C |
|--------|-----|-----|-----|
| SCDS73 | 8.4 | 4.4 | 2.2 |
| SCDS74 | 8.4 | 4.4 | 2.2 |

SCDS 103R/ 104R/ 105R

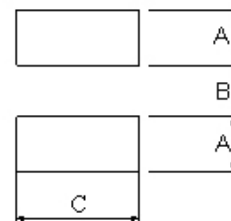
Shape and Dimensions



Dimensions in mm

| TYPE | A | B | C | D | E | F | G |
|----------|--------------------|--------------------|-------------------|-----|-----|-----|--------------------|
| SCDS103R | 10.3 ⁺⁰ | 10.5 ⁺⁰ | 3.1 ⁺⁰ | 1.2 | 7.7 | 3.0 | 13.5 ⁺⁰ |
| SCDS104R | 10.3 ⁺⁰ | 10.5 ⁺⁰ | 4 ⁺⁰ | 1.2 | 7.7 | 3.0 | 13.5 ⁺⁰ |
| SCDS105R | 10.3 ⁺⁰ | 10.5 ⁺⁰ | 5.1 ⁺⁰ | 1.2 | 7.7 | 3.0 | 13.5 ⁺⁰ |

Recommended Pattern



Dimension in mm

| TYPE | A | B | C |
|----------|-----|-----|-----|
| SCDS103R | 1.6 | 7.3 | 3.2 |
| SCDS104R | 1.6 | 7.3 | 3.2 |
| SCDS105R | 1.6 | 7.3 | 3.2 |

Standard Specifications

| Stamp | Inductance (μH) | RDC (mΩ) Max | | | | | | | |
|-------|-----------------|--------------|---------|-----------|-----------|-----------|----------|----------|----------|
| | | SCDS 73 | SCDS 74 | SCDS 103R | SCDS 104R | SCDS 105R | SCDS 124 | SCDS 125 | SCDS 127 |
| R80 | 0.8 | | | | | 4.3 | | | |
| 1R0 | 1.0 | | | | 7.5 | | | | |
| 1R2 | 1.2 | | | | | | | | 7.0 |
| 1R5 | 1.5 | 30 | 20 | | 8.1 | 5.8 | | | 8.0 |
| 1R8 | 1.8 | | 25 | | 9.5 | | | | |
| 2R2 | 2.2 | 30 | 25 | | 10.5 | 11 | | | 11.5 |
| 2R4 | 2.4 | | | | | | | | 11.5 |
| 2R5 | 2.5 | | | | 10.5 | | | | |
| 2R7 | 2.7 | | 30 | | | | | | |
| 3R3 | 3.3 | 40 | 35 | | 13 | 10.4 | 15 | 15 | 13.5 |
| 3R5 | 3.5 | | | | | | | | 13.5 |
| 3R8 | 3.8 | | | | 13 | | | | |
| 3R9 | 3.9 | | | | | | 15 | | |
| 4R7 | 4.7 | | 35 | 30 | 18 | 12.3 | 18 | 18 | 15.8 |
| 5R2 | 5.2 | | | | 22 | | | | |
| 5R6 | 5.6 | | | | 27 | | | | |
| 6R1 | 6.1 | | | | | | | | 17.6 |
| 6R4 | 6.4 | | | | | | | 18 | |
| 6R8 | 6.8 | 60 | 45 | 35 | 27 | 18 | 23 | | 20.0 |
| 7R0 | 7.0 | | | | 27 | | | | |
| 7R6 | 7.6 | | | | | | | | 20.0 |
| 8R2 | 8.2 | | | | 33 | 20 | | 25 | |
| 100 | 10 | 72 | 49 | 59 | 35 | 26 | 28 | 25 | 21.6 |
| 120 | 12 | 98 | 58 | | | 33 | 38 | 27 | 24.3 |
| 150 | 15 | 130 | 81 | 91 | 50 | 41 | 50 | 30 | 27.0 |
| 180 | 18 | 140 | 91 | | 70 | 46 | 57 | 34 | 39.2 |
| 220 | 22 | 190 | 110 | | 73 | 61 | 66 | 36 | 43.2 |
| 270 | 27 | 210 | 150 | | 90 | 69 | 80 | 51 | 45.9 |
| 330 | 33 | 240 | 170 | 202 | 93 | 84 | 97 | 57 | 64.8 |
| 390 | 39 | 320 | 230 | | 128 | 106 | 132 | 68 | 72.9 |
| 470 | 47 | 360 | 260 | 299 | 128 | 130 | 150 | 75 | 100 |
| 560 | 56 | 470 | 350 | | 213 | 149 | 190 | 110 | 110 |
| 680 | 68 | 520 | 380 | | 213 | 201 | 220 | 120 | 140 |
| 820 | 82 | 690 | 430 | | 280 | 227 | 260 | 140 | 160 |
| 101 | 100 | 790 | 610 | | 304 | 253 | 308 | 160 | 220 |
| 121 | 120 | 890 | 660 | | | 303 | 380 | 170 | 250 |
| 151 | 150 | 1270 | 880 | | 506 | 370 | 530 | 230 | 280 |
| 181 | 180 | 1450 | 980 | | | 419 | 620 | 290 | 350 |
| 201 | 200 | | | | 756 | | | | |
| 221 | 220 | 1650 | 1170 | | 756 | 500 | 700 | 400 | 390 |
| 271 | 270 | 2310 | 1640 | | | 672 | 876 | 460 | 560 |
| 331 | 330 | 2620 | 1860 | | 1090 | 812 | 990 | 510 | 640 |
| 391 | 390 | 2940 | 2850 | | | 953 | | 690 | 700 |
| 471 | 470 | 4180 | 3010 | | 1600 | 1289 | | 770 | 980 |
| 561 | 560 | 4670 | 3620 | | | 1430 | | 860 | 1070 |
| 681 | 680 | 5730 | 4630 | | | 1599 | | 1200 | 1460 |
| 821 | 820 | 6540 | 5200 | | | 1768 | | 1340 | 1640 |
| 102 | 1000 | 9440 | 6000 | | | 1989 | | 1530 | 1820 |

Note: When ordering, please specify tolerance code. Tolerance: M=±20%, T=±30%, N = ⁺⁴⁰/₋₂₀%

- Operating temperature range - 40°C ~ 105°C(Including self - temperature rise)
- Isat for Inductance drop 35% from its value without current
- Measure Equipment :
 L : Agilent/ E4980 or HP4284A (under 1MHz), HP4285A (over 1MHz)
 RDC : Chroma 16502
 Rated Current : HP4284+42841A or WK3260B+WK3265B

Please be sure to request approval specifications that provide further details of the products. Kindly note that the content of these specifications are subject to change or may be discontinued without advance notice. Please contact our sales department before ordering.

Standard Specifications

| Stamp | Inductance (μH) | Isat (A) | | | | | | | |
|-------|-----------------|----------|---------|-----------|-----------|-----------|----------|----------|----------|
| | | SCDS 73 | SCDS 74 | SCDS 103R | SCDS 104R | SCDS 105R | SCDS 124 | SCDS 125 | SCDS 127 |
| R80 | 0.8 | | | | | 13.5 | | | |
| 1R0 | 1.0 | | | | 11 | | | | |
| 1R2 | 1.2 | | | | | | | | 9.80 |
| 1R5 | 1.5 | 4.00 | 5.00 | | 10. | 10.5 | | | 9.50 |
| 1R8 | 1.8 | | 4.00 | | 8.5 | | | | |
| 2R2 | 2.2 | 4.00 | 3.50 | | 7.5 | 9.25 | | | 8.00 |
| 2R4 | 2.4 | | | | | | | | 8.00 |
| 2R5 | 2.5 | | | | 7.5 | | | | |
| 2R7 | 2.7 | | 3.50 | | | | | | |
| 3R3 | 3.3 | 3.70 | 3.50 | | 6.0 | 7.8 | 6.50 | 8.00 | 7.50 |
| 3R5 | 3.5 | | | | | | | | 7.50 |
| 3R8 | 3.8 | | | | 6.0 | | | | |
| 3R9 | 3.9 | | | | | | 6.50 | | |
| 4R7 | 4.7 | | 3.00 | 4.65 | 5.7 | 6.40 | 5.70 | 7.60 | 6.80 |
| 5R2 | 5.2 | | | | 5.5 | | | | |
| 5R6 | 5.6 | | | | 5.0 | | | | |
| 6R1 | 6.1 | | | | | | | | 6.60 |
| 6R4 | 6.4 | | | | | | | 5.8 | |
| 6R8 | 6.8 | 2.00 | 2.50 | 3.84 | 5.0 | 5.40 | 4.90 | | 6.20 |
| 7R0 | 7.0 | | | | 4.8 | | | | |
| 7R6 | 7.6 | | | | | | | | 5.90 |
| 8R2 | 8.2 | | | | 4.5 | 4.85 | | 5.00 | |
| 100 | 10 | 1.68 | 1.84 | 3.18 | 4.4 | 4.45 | 4.50 | 4.00 | 5.40 |
| 120 | 12 | 1.52 | 1.71 | | | 4.00 | 4.00 | 3.50 | 4.90 |
| 150 | 15 | 1.33 | 1.47 | 2.60 | 3.6 | 3.60 | 3.20 | 3.30 | 4.50 |
| 180 | 18 | 1.20 | 1.31 | | 3.5 | 3.20 | 3.10 | 3.00 | 3.90 |
| 220 | 22 | 1.07 | 1.23 | | 2.9 | 2.95 | 2.90 | 2.80 | 3.60 |
| 270 | 27 | 0.96 | 1.12 | | 2.5 | 2.70 | 2.80 | 2.30 | 3.40 |
| 330 | 33 | 0.91 | 0.96 | 1.74 | 2.3 | 2.50 | 2.70 | 2.10 | 3.00 |
| 390 | 39 | 0.77 | 0.91 | | 2.1 | 2.30 | 2.10 | 2.00 | 2.75 |
| 470 | 47 | 0.76 | 0.88 | 1.43 | 2.1 | 2.00 | 1.90 | 1.80 | 2.50 |
| 560 | 56 | 0.68 | 0.75 | | 1.6 | 1.90 | 1.80 | 1.70 | 2.35 |
| 680 | 68 | 0.61 | 0.69 | | 1.5 | 1.65 | 1.50 | 1.50 | 2.10 |
| 820 | 82 | 0.57 | 0.61 | | 1.35 | 1.50 | 1.30 | 1.40 | 1.95 |
| 101 | 100 | 0.50 | 0.60 | | 1.35 | 1.35 | 1.20 | 1.30 | 1.70 |
| 121 | 120 | 0.49 | 0.52 | | | 1.28 | 1.10 | 1.10 | 1.60 |
| 151 | 150 | 0.43 | 0.46 | | 1.15 | 1.12 | 0.95 | 1.00 | 1.42 |
| 181 | 180 | 0.39 | 0.42 | | | 1.04 | 0.85 | 0.90 | 1.30 |
| 201 | 200 | | | | 0.92 | | | | |
| 221 | 220 | 0.35 | 0.36 | | 0.92 | 0.94 | 0.80 | 0.80 | 1.16 |
| 271 | 270 | 0.32 | 0.34 | | | 0.84 | 0.60 | 0.75 | 1.06 |
| 331 | 330 | 0.28 | 0.32 | | 0.70 | 0.75 | 0.50 | 0.68 | 0.95 |
| 391 | 390 | 0.26 | 0.29 | | | 0.70 | | 0.65 | 0.88 |
| 471 | 470 | 0.24 | 0.26 | | 0.50 | 0.60 | | 0.58 | 0.79 |
| 561 | 560 | 0.22 | 0.23 | | | 0.54 | | 0.54 | 0.73 |
| 681 | 680 | 0.19 | 0.22 | | | 0.52 | | 0.48 | 0.67 |
| 821 | 820 | 0.18 | 0.20 | | | 0.50 | | 0.43 | 0.60 |
| 102 | 1000 | 0.16 | 0.18 | | | 0.48 | | 0.40 | 0.55 |

Tolerance Of Inductors

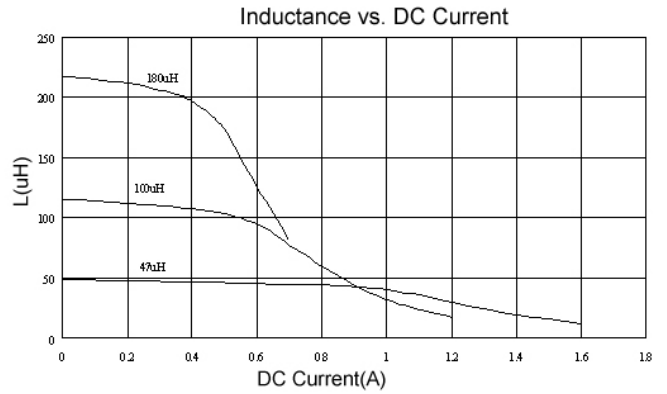
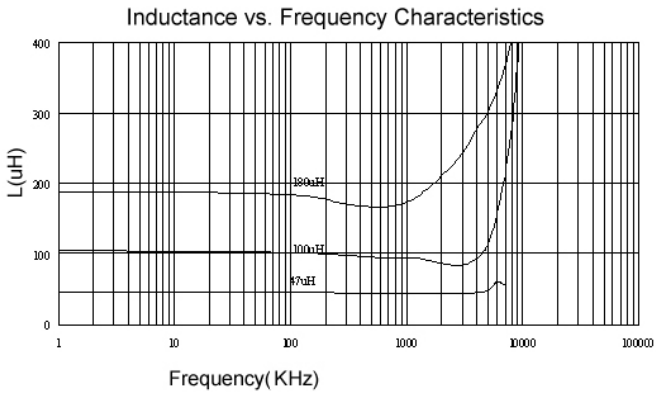
- SCDS 73 1.5 ~ 1000uH ± 20%
- SCDS 74 1.5 ~ 1000uH ± 20%
- SCDS 103R 4.7~47uH ± 30%
- SCDS 104R 1.0 ~ 470uH ± 30%
- SCDS 105R 0.8 ~ 1000uH ± 30%
- Tolerance : M = ±20% , T = ±30% , N = ⁺⁴⁰/₋₂₀%
- SCDS 124 3.3 ~ 330uH ±20%
- SCDS 125 3.3 ~ 1000uH ± 20%
- SCDS 127 1.2 ~ 7.6uH ⁺⁴⁰/₋₂₀%
- SCDS 127 10 ~ 1000uH ± 20%

Please be sure to request approval specifications that provide further details of the products. Kindly note that the content of these specifications are subject to change or may be discontinued without advance notice. Please contact our sales department before ordering.

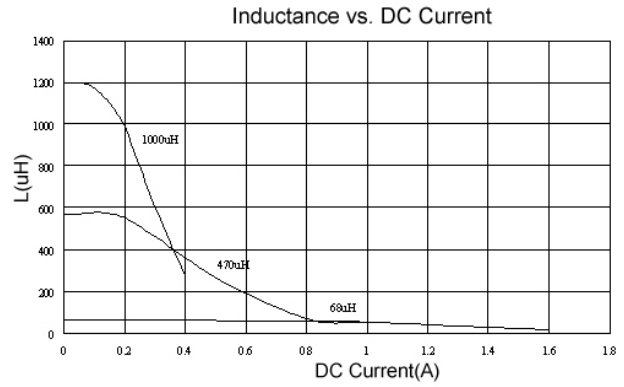
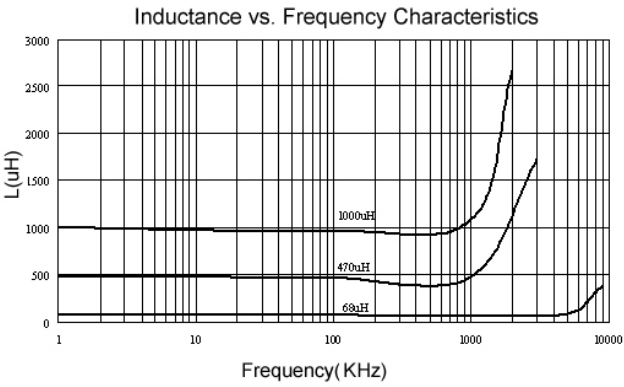
Curves of SCDS Series

Test Instruments : HP4294 Impedance / Material Analyzer

SCDS73

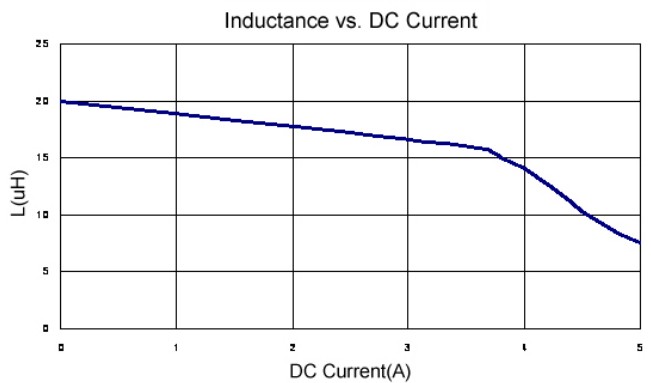
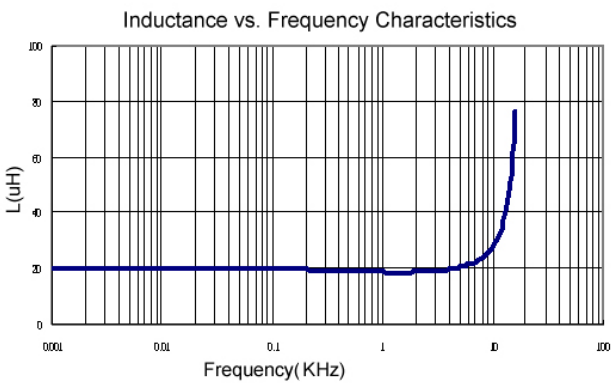


SCDS74

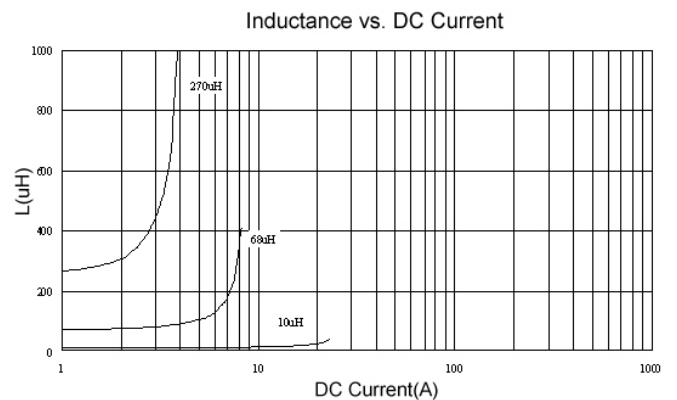
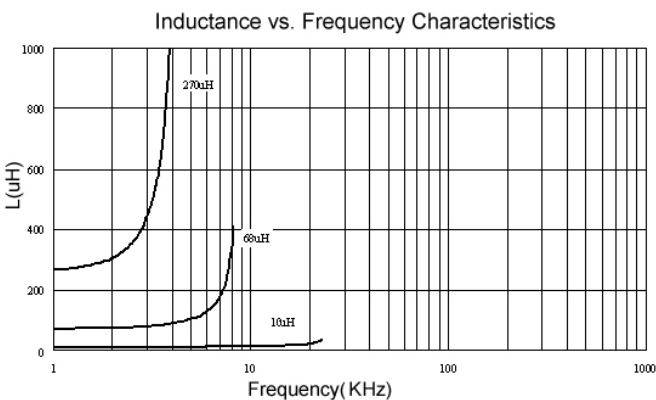


Test Instruments : HP4294 Impedance / Material Analyzer

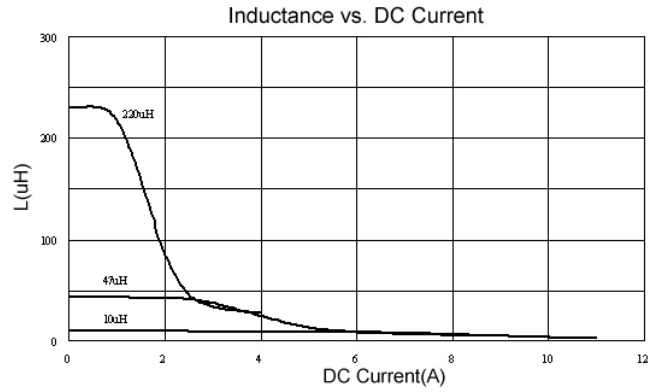
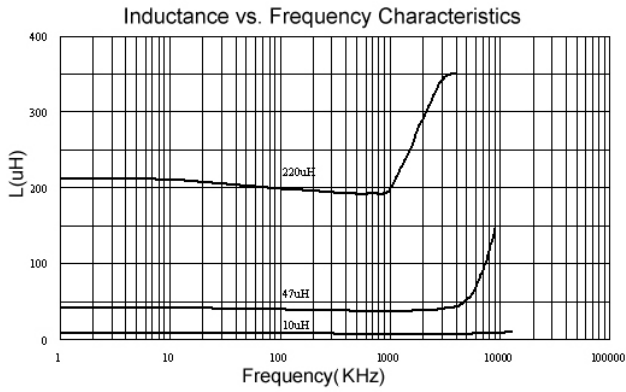
SCDS104R



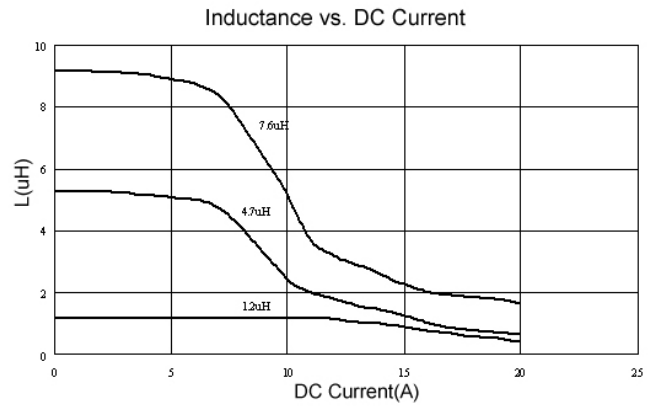
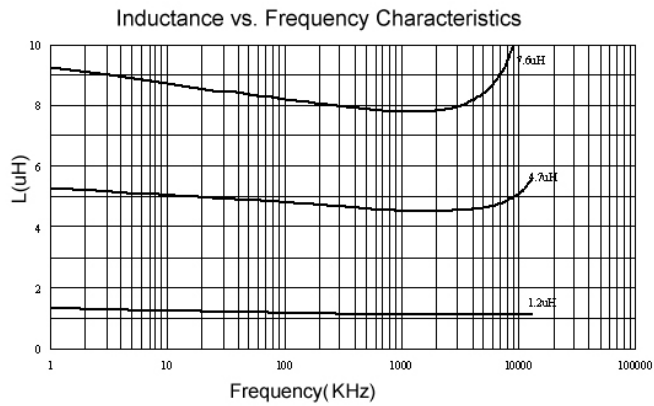
SCDS124



SCDS125

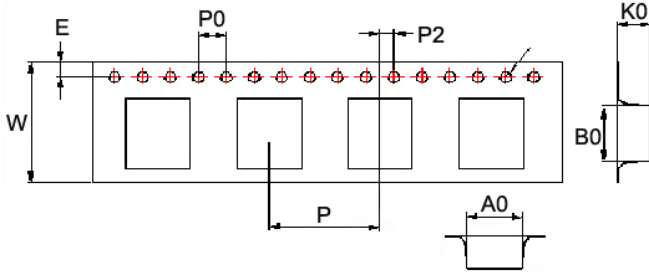


SCDS127

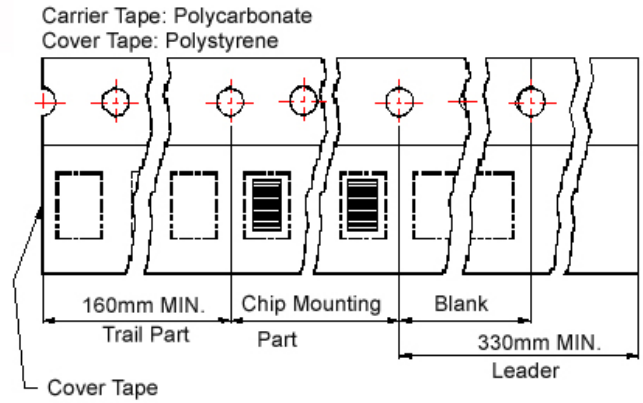


Packaging Specifications

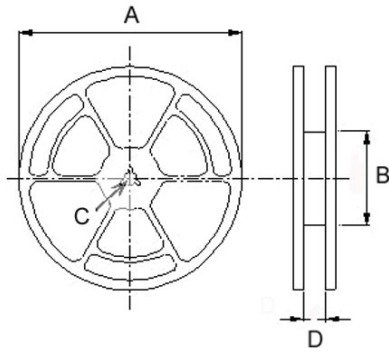
Tape Dimensions



Tape Material



Reel Dimensions



Dimensions in mm

| TYPE | Tape Dimensions | | | | | | | | | Reel Dimensions | | | | Quantity |
|-----------|-----------------|-------|-----|------|------|----|----|----|----|-----------------|-----|----|------|------------|
| | A0 | B0 | K0 | D | E | W | P | P0 | P2 | A | B | C | D | PCS / REEL |
| SCDS 73 | 7.6 | 7.6 | 3.6 | 1.55 | 1.75 | 16 | 12 | 4 | 2 | 330 | 100 | 13 | 16.0 | 1600 |
| SCDS 74 | 7.6 | 7.6 | 5.0 | 1.55 | 1.75 | 16 | 12 | 4 | 2 | 330 | 100 | 13 | 16.0 | 1000 |
| SCDS 103R | 10.6 | 10.75 | 4.2 | 1.55 | 1.75 | 24 | 16 | 4 | 2 | 300 | 100 | 13 | 24.4 | 1000 |
| SCDS 104R | 10.6 | 10.75 | 4.2 | 1.5 | 1.75 | 24 | 16 | 4 | 2 | 330 | 100 | 13 | 24.4 | 1000 |
| SCDS 105R | 10.6 | 10.6 | 5.0 | 1.5 | 1.75 | 24 | 16 | 4 | 2 | 330 | 100 | 13 | 24.4 | 500 |
| SCDS 124 | 13.0 | 12.8 | 5.1 | 1.55 | 1.75 | 24 | 16 | 4 | 2 | 330 | 100 | 13 | 24.4 | 500 |
| SCDS 125 | 12.6 | 12.6 | 6.7 | 1.55 | 1.75 | 24 | 16 | 4 | 2 | 330 | 100 | 13 | 24.4 | 600 |
| SCDS 127 | 12.6 | 12.6 | 8.7 | 1.55 | 1.75 | 24 | 16 | 4 | 2 | 330 | 100 | 13 | 24.4 | 500 |

SCDS Series



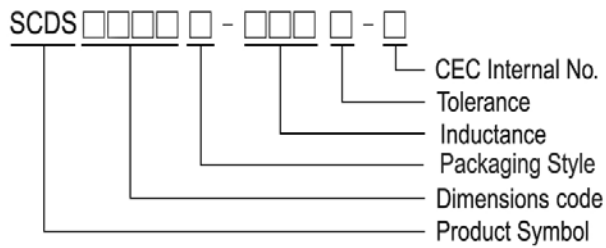
Features

- RoHS, Halogen Free and REACH Compliance
- Magnetic shielded
- Various package size and wide inductance range

Applications

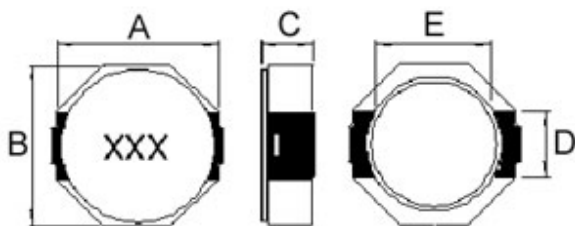
- AP Routers
- STBs
- LCD TVs and monitors
- Game consoles
- LED lightings
- DC/DC converters

Product Identification

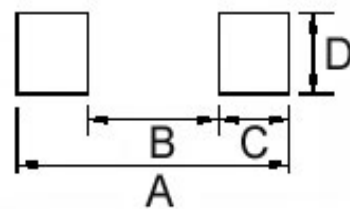


- T : Packaging: Tape and Reel

Shapes and Dimensions



Recommended Pattern



Dimension in mm

| TYPE | A | B | C | D | E |
|----------|-------------------|-------------------|-------------------|-----|-----|
| SCDS8D43 | 8.3 ⁺⁰ | 8.3 ⁺⁰ | 4.5 ⁺⁰ | 2.5 | 6.3 |

Dimension in mm

| TYPE | A | B | C | D |
|----------|------|-----|-----|-----|
| SCDS8D43 | 10.1 | 6.1 | 2.0 | 2.8 |

Electrical Characteristics

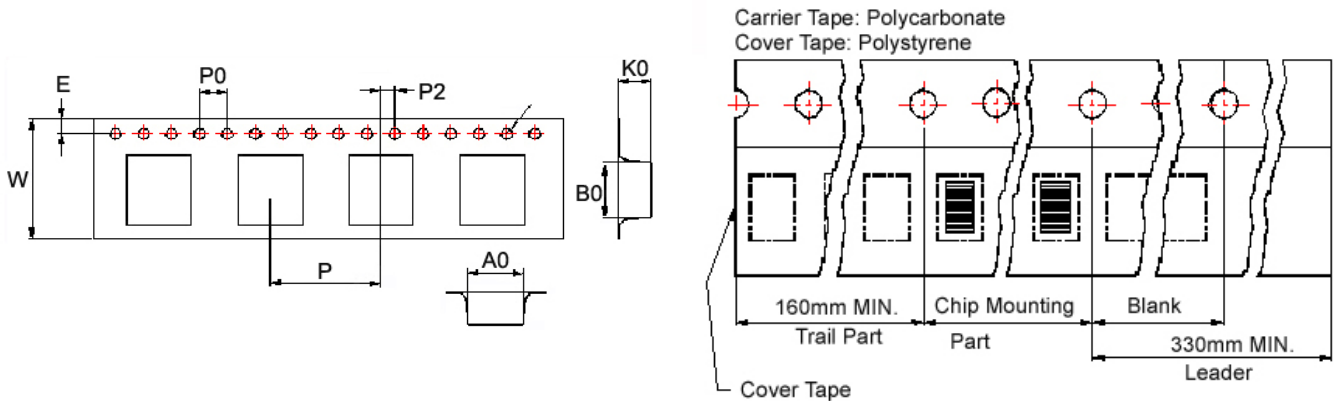
| Part Number | Inductance (μH) | Test Frequency (kHz) | Tolerance ($\pm\%$) | RDC ($\text{m}\Omega$) Max | Rated Current (A) |
|------------------|---------------------------------|-------------------------|--------------------------|---------------------------------|----------------------|
| SCDS8D43T-3R3□-N | 3.3 | 100 | 30 | 19 | 5.7 |
| SCDS8D43T-4R7□-N | 4.7 | 100 | 30 | 22 | 5.6 |
| SCDS8D43T-6R8□-N | 6.8 | 100 | 30 | 25 | 4.4 |
| SCDS8D43T-100□-N | 10 | 100 | 30 | 36 | 4.0 |
| SCDS8D43T-150□-N | 15 | 100 | 30 | 53 | 2.9 |
| SCDS8D43T-220□-N | 22 | 100 | 30 | 75 | 2.4 |
| SCDS8D43T-470□-N | 47 | 100 | 30 | 150 | 1.8 |
| SCDS8D43T-680□-N | 68 | 100 | 30 | 240 | 1.5 |
| SCDS8D43T-101□-N | 100 | 100 | 30 | 353 | 1.1 |

Note: When ordering, please specify tolerance code. Tolerance: T= \pm 30%

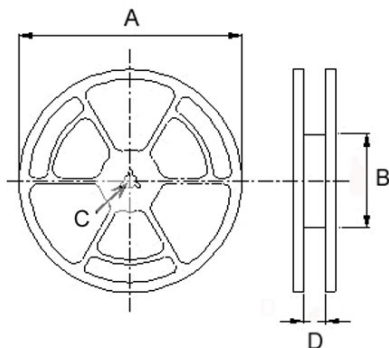
- Operating temperature range - 30°C ~ 100°C(Including self - temperature rise)
- Rated current for Inductance drop 35% from its value with current
- Measure Equipment :
 L : HP4284A 100kHz/ 1V
 RDC : Chroma 16502
 Rated current : HP4284+42841A

Packaging Specifications

Tape Dimensions



Reel Dimensions

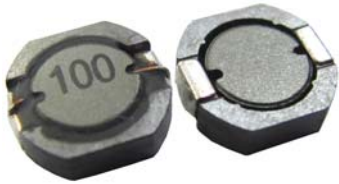


Dimensions in mm

| TYPE | Tape Dimensions | | | | | | | | | Reel Dimensions | | | | Quantity PCS / REEL |
|-----------|-----------------|-----|-----|------|------|----|----|----|----|-----------------|-----|----|------|------------------------|
| | A0 | B0 | K0 | D | E | W | P | P0 | P2 | A | B | C | D | |
| SCDS 8D43 | 8.4 | 9.9 | 4.8 | 1.55 | 1.75 | 24 | 12 | 4 | 2 | 330 | 100 | 13 | 24.4 | 1000 |

Please be sure to request approval specifications that provide further details of the products. Kindly note that the content of these specifications are subject to change or may be discontinued without advance notice. Please contact our sales department before ordering.

SCPS Series



The SCPS Series is designed for low profile type with low RDC and large current. The magnetic shielding supports high – density mounting. This series also provides working – frequency up to 1MHz.

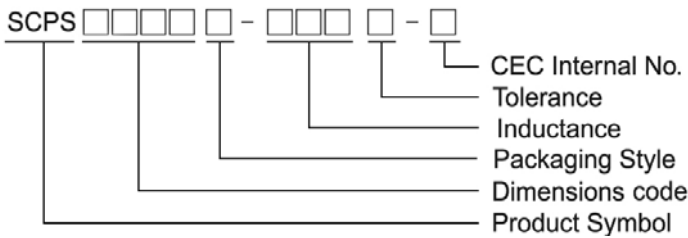
Features

- RoHS compliant
- Low Rdc and high saturation current for portable DC to DC converter line
- High magnetic shielding construction provides high resolution for EMC protection
- Support lead-free soldering

Applications

- Notebook PC
- Set top box
- LCD TV
- LCD displays
- Portable communication device
- DC/DC converters

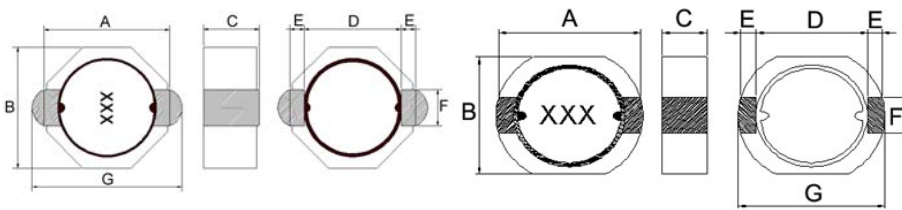
Product Identification



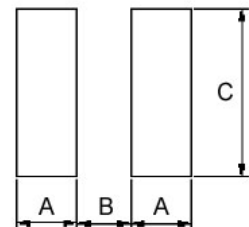
Shape and Dimensions

FIG 1

FIG 2



Recommended Pattern



Dimensions in mm

| TYPE | FIG | A | B | C | D | E | F | G |
|----------|-----|---------|---------|--------|-----|-----|-----|--------|
| SCPS0522 | 1 | 5.2±0.3 | 5.0±0.3 | 2.2Max | 4.0 | 0.6 | 1.5 | 6.2Max |
| SCPS0725 | 2 | 7.5±0.3 | 7.4±0.3 | 2.5Max | 5.6 | 1.2 | 2.5 | 8.7Max |
| SCPS0740 | 2 | 7.5±0.3 | 7.4±0.3 | 4.0Max | 5.6 | 1.2 | 2.5 | 9.2Max |

Dimensions in mm

| TYPE | A | B | C |
|----------|-----|-----|-----|
| SCPS0522 | 1.5 | 3.2 | 1.5 |
| SCPS0725 | 1.5 | 5.4 | 2.8 |
| SCPS0740 | 1.5 | 5.4 | 2.8 |

Standard Specifications

| Part Number | Inductance (uH) | Tolerance (±%) | Test Frequency (kHz) | RDC (mΩ) Max | Isat (A) | Irms (A) |
|------------------|-----------------|----------------|----------------------|--------------|----------|----------|
| SCPS0522T-1R2□-N | 1.2 | 30 | 100 | 25 | 4.3 | 3.43 |
| SCPS0522T-1R8□-N | 1.8 | 30 | 100 | 32 | 3.6 | 3.12 |
| SCPS0522T-3R3□-N | 3.3 | 30 | 100 | 54 | 2.5 | 2.68 |
| SCPS0522T-4R7□-N | 4.7 | 30 | 100 | 81 | 2.0 | 2.18 |
| SCPS0522T-100□-N | 10 | 20,30 | 100 | 160 | 1.4 | 1.51 |
| SCPS0522T-220□-N | 22 | 20,30 | 100 | 320 | 0.9 | 1.02 |
| SCPS0522T-330□-N | 33 | 20,30 | 100 | 490 | 0.77 | 0.80 |

Note: When ordering, please specify tolerance code. Tolerance: M=±20%, T=±30%

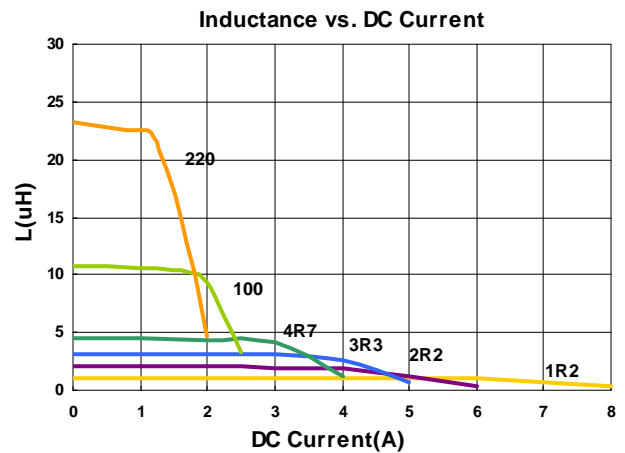
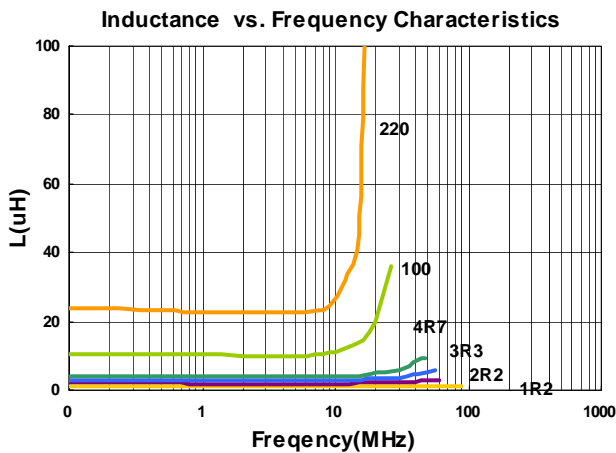
- Operating temperature range - 40°C ~ 105°C(Including self - temperature rise)
- Isat for Inductance drop 30% from its value without current
- I rms for a 40°C temperature rise from 25°C ambient with current
- Measure Equipment :

L : HP4284A.+Aglient 16334A , 100kHz/ 1V

RDC : Chroma 16502

Isat : HP4284A+HP42841A or WK3260B+WK3265B

I rms : Agilent 6641 SYSTEM DC POWER SUPPLY



Please be sure to request approval specifications that provide further details of the products. Kindly note that the content of these specifications are subject to change or may be discontinued without advance notice. Please contact our sales department before ordering.

Standard Specifications

| Part Number | Inductance (uH) | Tolerance (±%) | Test Frequency (kHz) | RDC (mΩ) Max | Isat (A) | Irms (A) |
|------------------|-----------------|----------------|----------------------|--------------|----------|----------|
| SCPS0725T-1R0□-N | 1.0 | 30 | 100 | 14.28 | 8.3 | 6.22 |
| SCPS0725T-1R5□-N | 1.5 | 30 | 100 | 19.70 | 7.2 | 5.00 |
| SCPS0725T-2R2□-N | 2.2 | 30 | 100 | 24.09 | 5.4 | 4.40 |
| SCPS0725T-3R3□-N | 3.3 | 30 | 100 | 41.20 | 4.4 | 3.70 |
| SCPS0725T-4R7□-N | 4.7 | 30 | 100 | 49.70 | 4.0 | 3.20 |
| SCPS0725T-5R6□-N | 5.6 | 20,30 | 100 | 58.90 | 3.9 | 2.90 |
| SCPS0725T-6R8□-N | 6.8 | 20,30 | 100 | 66.30 | 3.5 | 2.70 |
| SCPS0725T-100□-N | 10 | 20,30 | 100 | 92.40 | 2.8 | 1.90 |
| SCPS0725T-150□-N | 15 | 20,30 | 100 | 170.0 | 2.3 | 1.70 |
| SCPS0725T-220□-N | 22 | 20,30 | 100 | 210.0 | 1.5 | 1.52 |
| SCPS0725T-330□-N | 33 | 20,30 | 100 | 320.0 | 1.4 | 1.10 |
| SCPS0725T-470□-N | 47 | 20,30 | 100 | 490.0 | 1.2 | 0.95 |

Note: When ordering, please specify tolerance code. Tolerance: M=±20%, T=±30%

- Operating temperature range - 40°C ~ 105°C(Including self - temperature rise)
- Isat for Inductance drop 30% from its value without current
- Irms for a 40°C temperature rise from 25°C ambient with current
- Measure Equipment :

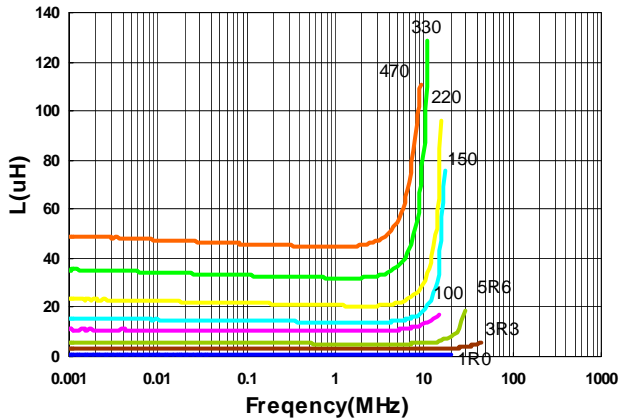
L : HP4284A.+Aglient 16334A , 100kHz/ 1V

RDC : Chroma 16502

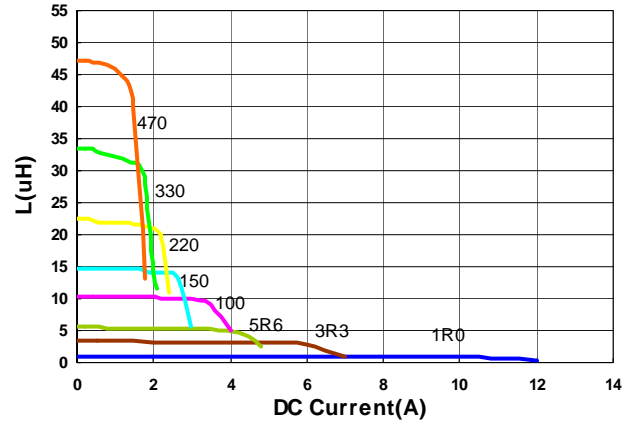
Isat : HP4284A+HP42841A or WK3260B+WK3265B

Irms : Agilent 6641 SYSTEM DC POWER SUPPLY

Inductance vs. Frequency Characteristics



Inductance vs. DC Current



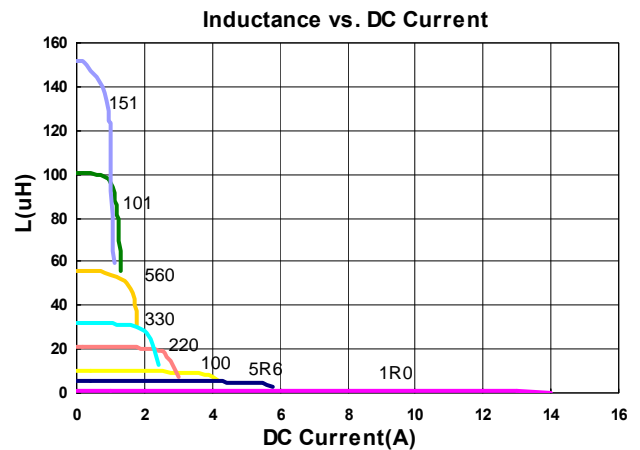
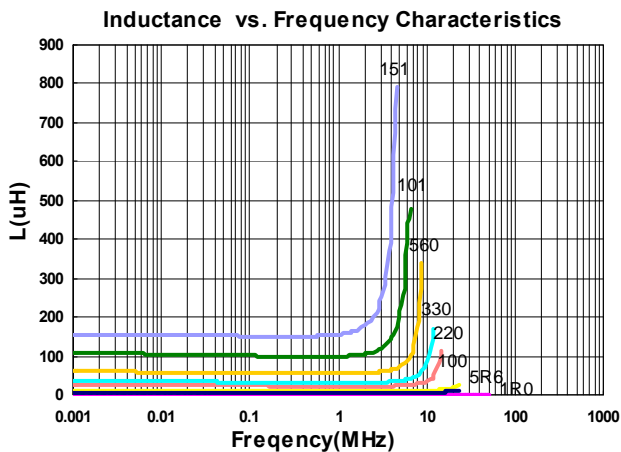
Please be sure to request approval specifications that provide further details of the products. Kindly note that the content of these specifications are subject to change or may be discontinued without advance notice. Please contact our sales department before ordering.

Standard Specifications

| Part Number | Inductance (uH) | Tolerance (±%) | Test Frequency (kHz) | RDC (mΩ) Max | Isat (A) | Irms (A) |
|------------------|-----------------|----------------|----------------------|--------------|----------|----------|
| SCPS0740T-1R0□-N | 1.0 | 30 | 100 | 6.38 | 12.0 | 9.00 |
| SCPS0740T-1R5□-N | 1.5 | 30 | 100 | 8.64 | 10.0 | 8.00 |
| SCPS0740T-1R8□-N | 1.8 | 30 | 100 | 9.60 | 8.60 | 7.92 |
| SCPS0740T-2R5□-N | 2.5 | 30 | 100 | 13.6 | 7.20 | 7.40 |
| SCPS0740T-3R3□-N | 3.3 | 30 | 100 | 17.8 | 6.80 | 6.70 |
| SCPS0740T-4R7□-N | 4.7 | 20,30 | 100 | 26.6 | 4.60 | 4.90 |
| SCPS0740T-5R6□-N | 5.6 | 20,30 | 100 | 29.0 | 4.10 | 4.60 |
| SCPS0740T-6R8□-N | 6.8 | 20,30 | 100 | 34.0 | 3.90 | 3.90 |
| SCPS0740T-100□-N | 10 | 20,30 | 100 | 55.6 | 3.40 | 3.25 |
| SCPS0740T-150□-N | 15 | 20,30 | 100 | 74.4 | 3.00 | 2.70 |
| SCPS0740T-220□-N | 22 | 20,30 | 100 | 98.1 | 2.40 | 2.40 |
| SCPS0740T-330□-N | 33 | 20,30 | 100 | 140 | 2.00 | 1.90 |
| SCPS0740T-470□-N | 47 | 20,30 | 100 | 217 | 1.70 | 1.48 |
| SCPS0740T-560□-N | 56 | 20,30 | 100 | 260 | 1.50 | 1.33 |
| SCPS0740T-680□-N | 68 | 20,30 | 100 | 310 | 1.36 | 1.20 |
| SCPS0740T-820□-N | 82 | 20,30 | 100 | 360 | 1.20 | 1.12 |
| SCPS0740T-101□-N | 100 | 20,30 | 100 | 480 | 1.12 | 0.95 |
| SCPS0740T-121□-N | 120 | 20,30 | 100 | 560 | 1.00 | 0.89 |
| SCPS0740T-151□-N | 150 | 20,30 | 100 | 710 | 0.92 | 0.82 |

Note: When ordering, please specify tolerance code. Tolerance: M=±20% , T=±30%

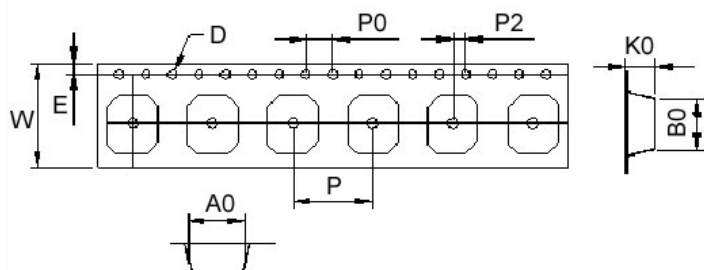
- Operating temperature range - 40°C ~ 105°C(Including self - temperature rise)
- Isat for Inductance drop 30% from its value without current
- I rms for a 40°C temperature rise from 25°C ambient with current
- Measure Equipment :
 L : HP4284A.+Agilent 16334A , 100kHz/ 1V
 RDC : Chroma 16502
 Isat : HP4284A+HP42841A or WK3260B+WK3265B
 I rms : Agilent 6641 SYSTEM DC POWER SUPPLY



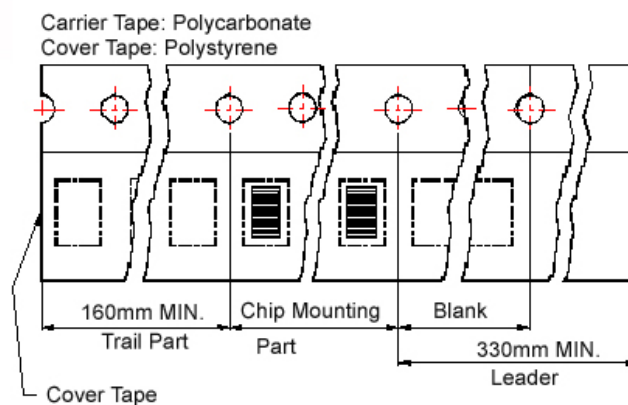
Please be sure to request approval specifications that provide further details of the products. Kindly note that the content of these specifications are subject to change or may be discontinued without advance notice. Please contact our sales department before ordering.

Packaging Specifications

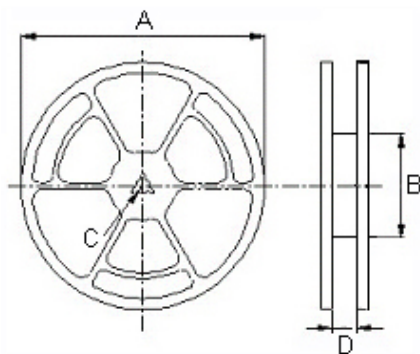
Tape Dimensions



Tape Material



Reel Dimensions



Dimensions in mm

| TYPE | Tape Dimensions | | | | | | | | | Reel Dimensions | | | | Quantity |
|----------|-----------------|------|-----|------|------|----|----|----|----|-----------------|-----|----|----|------------|
| | A0 | B0 | K0 | D | E | W | P | P0 | P2 | A | B | C | D | PCS / REEL |
| SCPS0522 | 5.35 | 6.20 | 2.4 | 1.55 | 1.75 | 16 | 8 | 4 | 2 | 330 | 100 | 13 | 16 | 2000 |
| SCPS0725 | 7.6 | 8.65 | 2.8 | 1.55 | 1.75 | 16 | 12 | 4 | 2 | 330 | 100 | 13 | 16 | 1500 |
| SCPS0740 | 7.6 | 9.0 | 4.3 | 1.55 | 1.75 | 16 | 12 | 4 | 2 | 330 | 100 | 13 | 16 | 1000 |

SDS Series



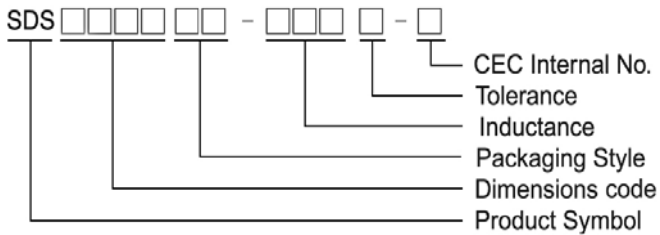
Features

- RoHS, Halogen Free and REACH Compliance
- Magnetic shielded
- Good Q factor, good energy storage and low resistance

Applications

- Flash memory programmers
- Electric motors
- DC/DC converters

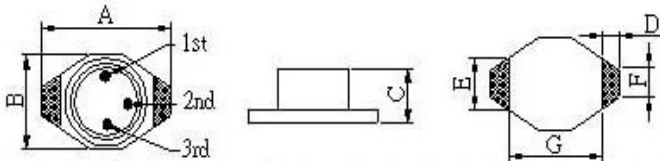
Product Identification



- Packaging: T: Tape and Reel

Shape and Dimensions

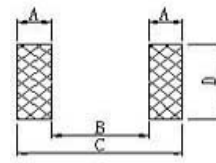
SDS0402



Dimensions in mm

| TYPE | A | B | C | D | E | F | G |
|---------|--------------------|--------------------|--------------------|------|------|------|------|
| SDS0402 | 6.60 ⁺⁰ | 4.45 ⁺⁰ | 2.92 ⁺⁰ | 1.02 | 3.05 | 1.27 | 4.32 |

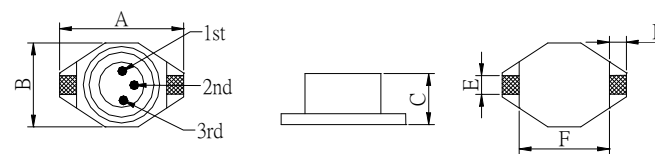
Recommended Pattern



Dimensions in mm

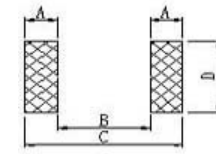
| TYPE | A | B | C | D |
|---------|-----|------|------|------|
| SDS0402 | 1.4 | 4.06 | 6.86 | 3.56 |

SDS0804



Dimensions in mm

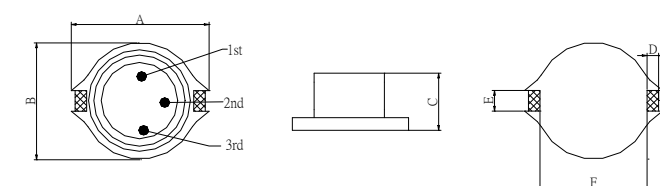
| TYPE | A | B | C | D | E | F |
|---------|---------------------|--------------------|--------------------|------|------|------|
| SDS0804 | 12.95 ⁺⁰ | 9.40 ⁺⁰ | 5.08 ⁺⁰ | 2.54 | 2.54 | 7.62 |



Dimensions in mm

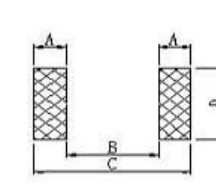
| TYPE | A | B | C | D |
|---------|------|------|-------|------|
| SDS0804 | 2.92 | 7.37 | 13.21 | 2.79 |

SDS1306



Dimensions in mm

| TYPE | A | B | C | D | E | F |
|---------|---------------------|---------------------|--------------------|------|------|------|
| SDS1306 | 18.54 ⁺⁰ | 15.24 ⁺⁰ | 7.62 ⁺⁰ | 2.54 | 2.54 | 12.7 |



Dimensions in mm

| TYPE | A | B | C | D |
|---------|------|-------|-------|------|
| SDS1306 | 2.92 | 12.45 | 18.29 | 2.79 |

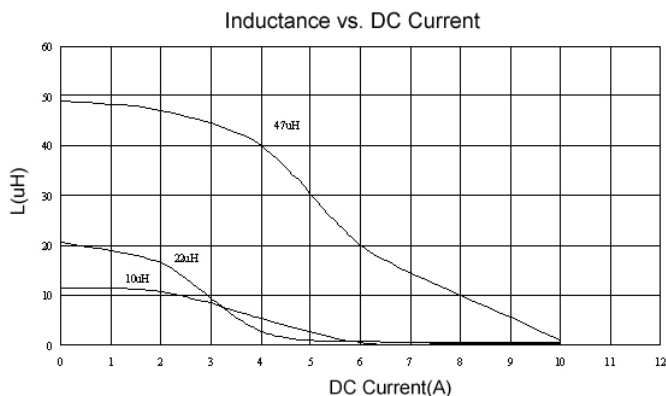
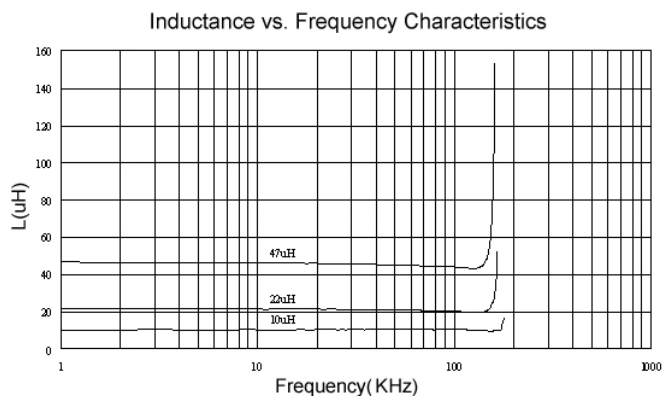
Electrical Characteristics

| Part Number | Inductance (μH) | Tolerance (±%) | Q Min | Q Frequency (kHz) | DC Resistance (Ω) Max | SRF (MHz) Typ. | I _{rms} (A) |
|-----------------|-----------------|----------------|-------|-------------------|-----------------------|----------------|----------------------|
| SDS0402T-1R0M-N | 1.0 | 20 | 30 | 200 | 0.040 | 200 | 3.0 |
| SDS0402T-1R5M-N | 1.5 | 20 | 30 | 200 | 0.045 | 100 | 2.8 |
| SDS0402T-2R2M-N | 2.2 | 20 | 40 | 200 | 0.050 | 90 | 1.8 |
| SDS0402T-3R3M-N | 3.3 | 20 | 40 | 200 | 0.060 | 90 | 1.6 |
| SDS0402T-4R7M-N | 4.7 | 20 | 40 | 200 | 0.065 | 80 | 1.4 |
| SDS0402T-6R8M-N | 6.8 | 20 | 40 | 200 | 0.070 | 40 | 1.2 |
| SDS0402T-100M-N | 10 | 20 | 40 | 200 | 0.075 | 30 | 1.0 |
| SDS0402T-150M-N | 15 | 20 | 40 | 100 | 0.090 | 25 | 0.80 |
| SDS0402T-220M-N | 22 | 20 | 40 | 100 | 0.110 | 20 | 0.70 |
| SDS0402T-330M-N | 33 | 20 | 40 | 100 | 0.190 | 15 | 0.60 |
| SDS0402T-470M-N | 47 | 20 | 40 | 100 | 0.230 | 15 | 0.50 |
| SDS0402T-680M-N | 68 | 20 | 40 | 100 | 0.290 | 10 | 0.40 |
| SDS0402T-101M-N | 100 | 20 | 40 | 100 | 0.480 | 8 | 0.30 |
| SDS0402T-151M-N | 150 | 20 | 40 | 100 | 0.590 | 7 | 0.26 |
| SDS0402T-221M-N | 220 | 20 | 40 | 100 | 0.770 | 4 | 0.22 |
| SDS0402T-331M-N | 330 | 20 | 40 | 100 | 1.4 | 4 | 0.20 |
| SDS0402T-471M-N | 470 | 20 | 40 | 100 | 1.8 | 3 | 0.19 |
| SDS0402T-681M-N | 680 | 20 | 40 | 100 | 2.2 | 2 | 0.18 |
| SDS0402T-102M-N | 1000 | 20 | 40 | 100 | 3.4 | 1 | 0.15 |

Note: When ordering, please specify tolerance code. Tolerance: M=±20%

- Operating temperature range - 40°C ~ 125°C(Including self - temperature rise)
- Isat for Inductance drop 30% from its value without current
- I_{rms} for a 30°C temperature rise from 25°C ambient with current
- Measure Equipment :
 - L : E4980 or HP4284A , 100kHz/ 0.1V
 - RDC : Chroma 16502
 - Isat : HP4284A+HP42841A or WK3260B+WK3265B

Test Instruments : HP4294A Impedance / Material Analyzer



Please be sure to request approval specifications that provide further details of the products. Kindly note that the content of these specifications are subject to change or may be discontinued without advance notice. Please contact our sales department before ordering.

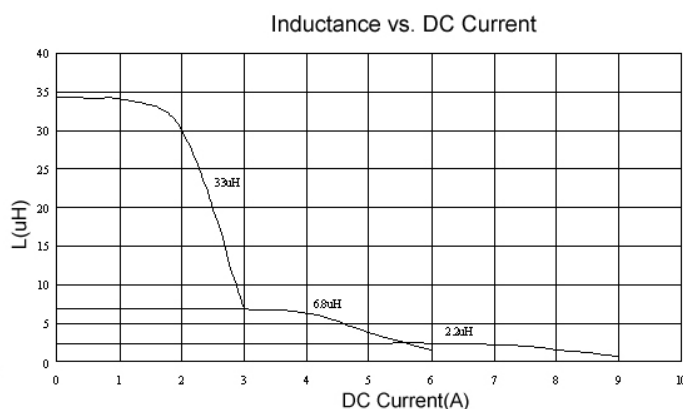
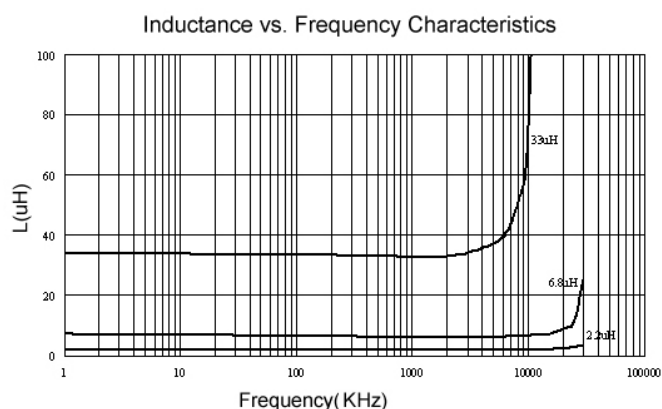
Electrical Characteristics

| Part Number | Inductance (μH) | Tolerance (±%) | Q Min | Q Frequency (kHz) | DC Resistance (Ω) Max | SRF (MHz) Typ. | Isat (A) | Irms (A) |
|-----------------|-----------------|----------------|-------|-------------------|-----------------------|----------------|----------|----------|
| SDS0804T-1R0M-N | 1.0 | 20 | 3 | 100 | 0.021 | 110 | 5.6 | 5.0 |
| SDS0804T-1R5M-N | 1.5 | 20 | 5 | 100 | 0.022 | 90 | 5.2 | 4.5 |
| SDS0804T-2R2M-N | 2.2 | 20 | 5 | 100 | 0.032 | 60 | 5.0 | 3.8 |
| SDS0804T-3R3M-N | 3.3 | 20 | 5 | 100 | 0.039 | 55 | 3.9 | 3.3 |
| SDS0804T-4R7M-N | 4.7 | 20 | 10 | 100 | 0.054 | 30 | 3.2 | 2.7 |
| SDS0804T-6R8M-N | 6.8 | 20 | 10 | 100 | 0.075 | 30 | 2.8 | 2.2 |
| SDS0804T-100M-N | 10 | 20 | 10 | 100 | 0.101 | 28 | 2.4 | 2.0 |
| SDS0804T-150M-N | 15 | 20 | 15 | 100 | 0.15 | 20 | 2.0 | 1.5 |
| SDS0804T-220M-N | 22 | 20 | 20 | 100 | 0.207 | 15 | 1.6 | 1.3 |
| SDS0804T-330M-N | 33 | 20 | 20 | 100 | 0.334 | 12 | 1.4 | 1.1 |
| SDS0804T-470M-N | 47 | 20 | 20 | 100 | 0.472 | 10 | 1.0 | 0.8 |
| SDS0804T-680M-N | 68 | 20 | | | 0.660 | 10 | 0.9 | 0.7 |
| SDS0804T-101M-N | 100 | 20 | | | 1.110 | 7 | 0.8 | 0.6 |
| SDS0804T-151M-N | 150 | 20 | | | 1.550 | 6 | 0.6 | 0.5 |
| SDS0804T-221M-N | 220 | 20 | | | 2.000 | 5 | 0.5 | 0.37 |
| SDS0804T-102M-N | 1000 | 20 | | | 8.300 | 2 | 0.32 | 0.17 |

Note: When ordering, please specify tolerance code. Tolerance: M=±20%

- Operating temperature range - 40°C ~ 125°C(Including self - temperature rise)
- Isat for Inductance drop 10% from its value without current
- I rms for a 40°C temperature rise from 25°C ambient with current
- Measure Equipment :
 - L : E4980 or HP4284A , 100kHz/ 0.1V
 - RDC : Chroma 16502
 - Isat : HP4284A+HP42841A or WK3260B+WK3265B

Test Instruments : HP4294A Impedance / Material Analyzer



Please be sure to request approval specifications that provide further details of the products. Kindly note that the content of these specifications are subject to change or may be discontinued without advance notice. Please contact our sales department before ordering.

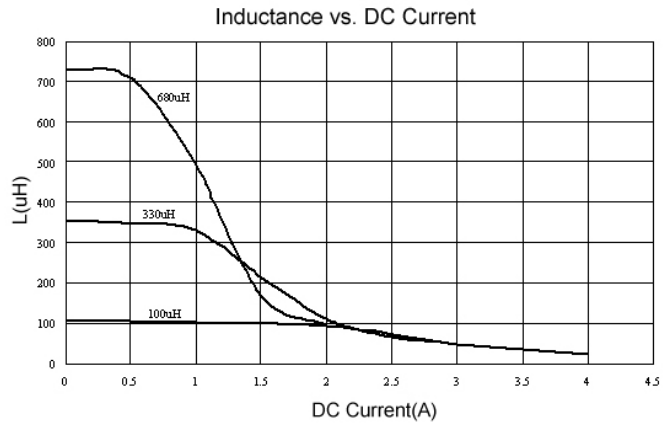
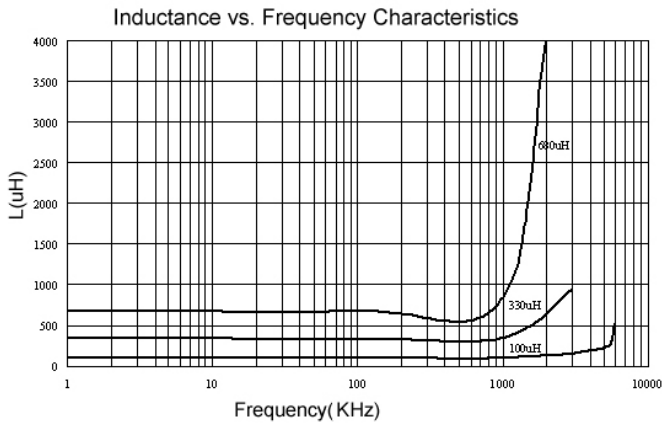
Electrical Characteristics

| Part Number | Inductance (μH) | Tolerance (±%) | Q Min | Q Frequency (kHz) | DC Resistance (Ω) Max | Isat (A) | Irms (A) | SRF (MHz) Typ. |
|-----------------|-----------------|----------------|-------|-------------------|-----------------------|----------|----------|----------------|
| SDS1306T-100M-N | 10 | 20 | 40 | 100 | 0.040 | 5.5 | 3.9 | 24 |
| SDS1306T-150M-N | 15 | 20 | 40 | 100 | 0.048 | 4.5 | 3.4 | 16 |
| SDS1306T-220M-N | 22 | 20 | 30 | 100 | 0.059 | 3.5 | 3.1 | 14 |
| SDS1306T-330M-N | 33 | 20 | 40 | 100 | 0.075 | 3.3 | 2.8 | 11 |
| SDS1306T-470M-N | 47 | 20 | 40 | 100 | 0.097 | 2.7 | 2.4 | 8.0 |
| SDS1306T-680M-N | 68 | 20 | 40 | 100 | 0.140 | 2.2 | 2.0 | 7.0 |
| SDS1306T-101M-N | 100 | 20 | 40 | 100 | 0.210 | 1.7 | 1.7 | 5.5 |
| SDS1306T-151M-N | 150 | 20 | 50 | 100 | 0.300 | 1.3 | 1.3 | 4.8 |
| SDS1306T-221M-N | 220 | 20 | 50 | 100 | 0.470 | 1.1 | 1.1 | 4.0 |
| SDS1306T-331M-N | 330 | 20 | 50 | 100 | 0.780 | 0.86 | 0.86 | 3.0 |
| SDS1306T-471M-N | 470 | 20 | 50 | 100 | 1.08 | 0.73 | 0.73 | 2.4 |
| SDS1306T-681M-N | 680 | 20 | 60 | 100 | 1.40 | 0.64 | 0.64 | 2.0 |
| SDS1306T-102M-N | 1000 | 20 | 60 | 100 | 2.01 | 0.53 | 0.53 | 1.0 |

Note: When ordering, please specify tolerance code. Tolerance: M=±20%

- Operating temperature range - 40°C ~ 125°C(Including self - temperature rise)
- Isat for Inductance drop 10% from its value without current
- I rms for a 40°C temperature rise from 25°C ambient with current
- Measure Equipment :
 L : E4980 or HP4284A , 100kHz/ 0.1V
 RDC : Chroma 16502
 Isat : HP4284A+HP42841A or WK3260B+WK3265B

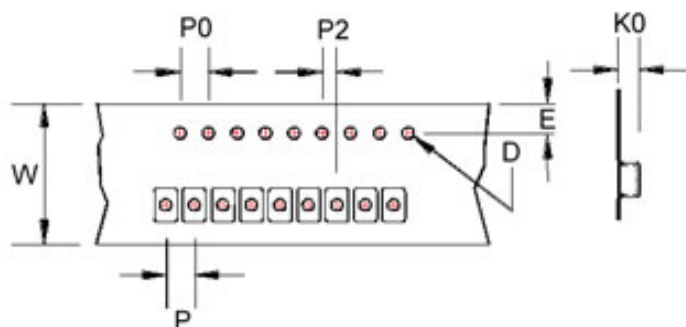
Test Instruments : HP4294A Impedance / Material Analyzer



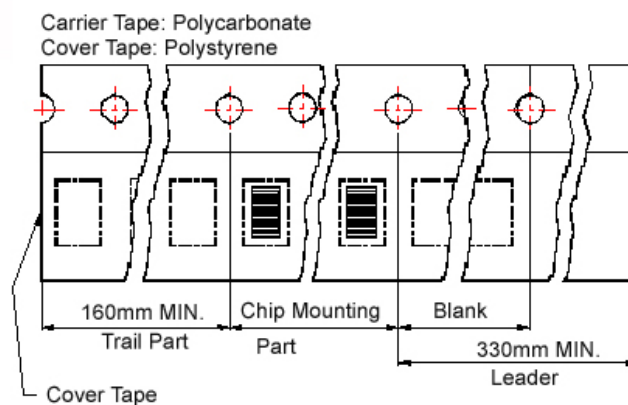
Please be sure to request approval specifications that provide further details of the products. Kindly note that the content of these specifications are subject to change or may be discontinued without advance notice. Please contact our sales department before ordering.

Packaging Specifications

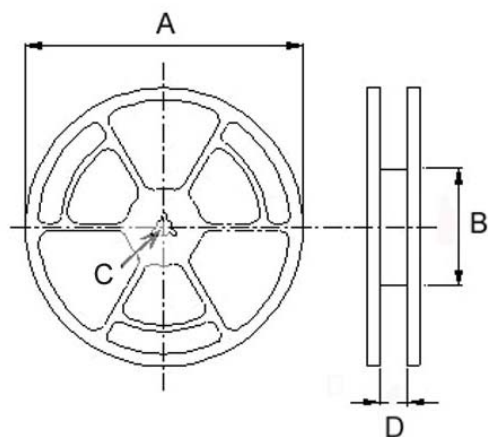
Tape Dimensions



Tape Material



Reel Dimensions



Dimensions

| TYPE | Tape Dimensions | | | | | | | Reel Dimensions | | | | Quantity (PCS / | |
|----------|-----------------|------|------|----|----|----|----|-----------------|-----|----|------|------------------|-------|
| | K0 | D | E | W | P | P0 | P2 | A | B | C | D | 178mm | 330mm |
| SDS 0402 | 3.2 | 1.55 | 1.75 | 12 | 8 | 4 | 2 | 330 | 100 | 13 | 13.4 | - | 2500 |
| | | | | | | | | 178 | 60 | | 13.2 | 750 | - |
| SDS 0804 | 5.4 | 1.55 | 1.75 | 24 | 12 | 4 | 2 | 330 | 100 | 13 | 24.4 | - | 1000 |
| SDS 1306 | 7.5 | 1.55 | 1.75 | 32 | 20 | 4 | 2 | 330 | 100 | 13 | 33.4 | - | 250 |

SLF Series



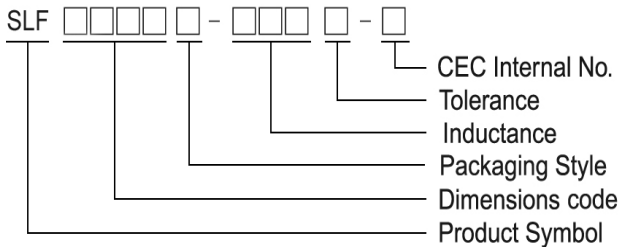
Features

- RoHS, Halogen Free and REACH Compliance
- Magnetic shielded
- Various package size and wide inductance range

Applications

- AP Routers
- STBs
- LCD TVs and monitors
- Game consoles
- LED lightings
- DC/DC converters

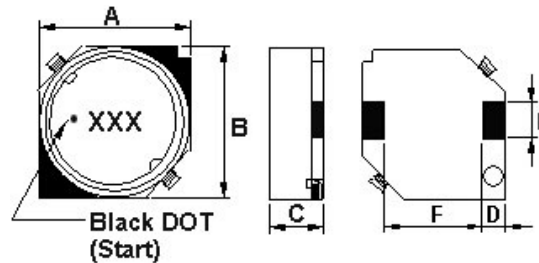
Products Identification



- Packaging: T : Tape and Reel

Shape and Dimensions

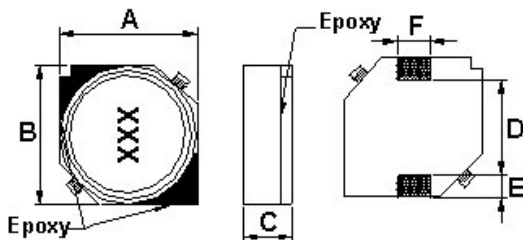
SLF 0628



Dimension in mm

| TYPE | A | B | C | D | E | F |
|----------|---------|---------|-----------|---------|---------|---------|
| SLF 0628 | 6 ± 0.2 | 6 ± 0.2 | 2.8 ± 0.2 | 1.5 TYP | 2 ± 0.1 | 3.0 TYP |

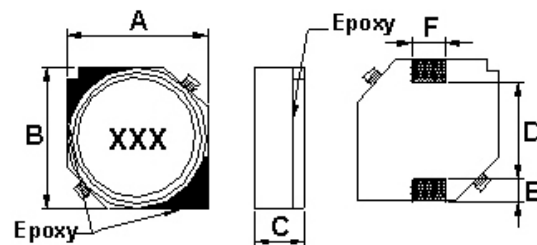
SLF 0728/ 0730/ 0732/ 0745



Dimension in mm

| TYPE | A | B | C | D | E | F |
|----------|---------|---------|-----------|---------|--------|---------|
| SLF 0728 | 7 ± 0.2 | 7 ± 0.2 | 2.8 ± 0.2 | 4.9 TYP | 0.9TYP | 2.0 TYP |
| SLF 0730 | 7 ± 0.2 | 7 ± 0.2 | 3.0 ± 0.2 | 4.9 TYP | 0.9TYP | 2.0 TYP |
| SLF 0732 | 7 ± 0.2 | 7 ± 0.2 | 3.2 ± 0.2 | 4.9 TYP | 0.9TYP | 2.0 TYP |
| SLF 0745 | 7 ± 0.2 | 7 ± 0.2 | 4.5 ± 0.3 | 4.9 TYP | 0.9TYP | 2.0 TYP |

SLF 0755

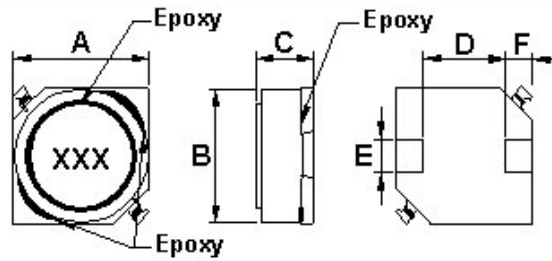


Dimension in mm

| TYPE | A | B | C | D | E | F |
|----------|-----------|-----------|-----------|---------|---------|---------|
| SLF 0755 | 7.0 ± 0.2 | 7.0 ± 0.2 | 5.5 ± 0.3 | 4.9 TYP | 0.9 TYP | 2.0 TYP |

Shape and Dimensions

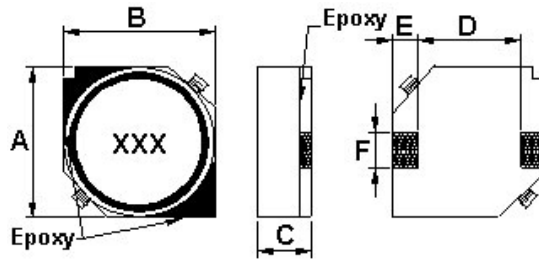
SLF 1045/ 1055



Dimension in mm

| TYPE | A | B | C | D | E | F |
|----------|------------|------------|-----------|---------|---------|-------|
| SLF 1045 | 10.1 ± 0.3 | 10.1 ± 0.3 | 4.5 ± 0.3 | 6.0 TYP | 3.0 TYP | 2 TYP |
| SLF 1055 | 10.1 ± 0.3 | 10.1 ± 0.3 | 5.5 ± 0.3 | 6.0 TYP | 3.0 TYP | 2 TYP |

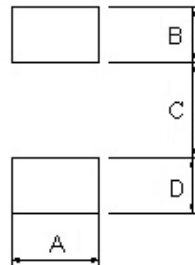
SLF 1255/ 1265/ 1275



Dimension in mm

| TYPE | A | B | C | D | E | F |
|----------|------------|------------|------------|---------|---------|---------|
| SLF 1255 | 12.5 ± 0.3 | 12.5 ± 0.3 | 5.5 ± 0.3 | 8.6 TYP | 2.0 TYP | 3.0 TYP |
| SLF 1265 | 12.5 ± 0.3 | 12.5 ± 0.3 | 6.5 ± 0.35 | 8.6 TYP | 2.0 TYP | 3.0 TYP |
| SLF 1275 | 12.5 ± 0.3 | 12.5 ± 0.3 | 7.5 ± 0.35 | 8.6 TYP | 2.0 TYP | 3.0 TYP |

Recommended Pattern



Dimension in mm

| TYPE | A | B | C | D |
|----------|-----|-----|-----|-----|
| SLF 0628 | 2.2 | 1.5 | 4.0 | 1.5 |
| SLF 0728 | 2.2 | 1.5 | 4.9 | 1.5 |
| SLF 0730 | 2.2 | 1.5 | 4.9 | 1.5 |
| SLF 0732 | 2.2 | 1.5 | 4.9 | 1.5 |
| SLF 0745 | 2.2 | 1.5 | 4.9 | 1.5 |
| SLF 0755 | 2.2 | 1.5 | 4.9 | 1.5 |
| SLF 1045 | 3.2 | 2.5 | 5.6 | 2.5 |
| SLF 1045 | 3.2 | 2.5 | 5.6 | 2.5 |
| SLF 1105 | 3.2 | 2.5 | 5.6 | 2.5 |
| SLF 1255 | 3.2 | 2.5 | 8.6 | 2.5 |
| SLF 1265 | 3.2 | 2.5 | 8.6 | 2.5 |
| SLF 1275 | 3.2 | 2.5 | 8.6 | 2.5 |

Electrical Characteristics

| Part Number | Inductance (μH) | Tolerance ($\pm\%$) | Test Frequency (kHz) | RDC ($\Omega\pm 20\%$) | Isat (A) | Irms (A) Max |
|-----------------|---------------------------------|--------------------------|-------------------------|-----------------------------|-------------|-----------------|
| SLF0628T-4R7M-N | 4.7 | 20 | 1 | 0.0284 | 1.6 | 2.5 |
| SLF0628T-6R8M-N | 6.8 | 20 | 1 | 0.0354 | 1.5 | 2.2 |
| SLF0628T-100M-N | 10 | 20 | 1 | 0.0532 | 1.3 | 1.8 |
| SLF0628T-150M-N | 15 | 20 | 1 | 0.0745 | 1.0 | 1.4 |
| SLF0628T-220M-N | 22 | 20 | 1 | 0.104 | 0.77 | 1.3 |
| SLF0628T-330M-N | 33 | 20 | 1 | 0.148 | 0.69 | 1.1 |
| SLF0628T-470M-N | 47 | 20 | 1 | 0.21 | 0.59 | 0.92 |
| SLF0628T-680M-N | 68 | 20 | 1 | 0.29 | 0.50 | 0.78 |
| SLF0628T-101M-N | 100 | 20 | 1 | 0.43 | 0.42 | 0.64 |

Note: When ordering, please specify tolerance code. Tolerance: M= $\pm 20\%$

- Operating temperature range - 40°C ~ 125°C(Including self - temperature rise)
- Isat for Inductance drop 30% from its value without current
- I rms for a 25°C temperature rise from 25°C ambient with current
- Measure Equipment :
L : E4980 or HP4284A , 1kHz 0.5V
RDC : Chroma 16502
Isat : HP4284A+HP42841A or WK3260B+WK3265B

Electrical Characteristics

| Part Number | Inductance (μH) | Tolerance ($\pm\%$) | Test Frequency (kHz) | RDC ($\Omega\pm 20\%$) | Isat (A) |
|-----------------|---------------------------------|--------------------------|-------------------------|-----------------------------|-------------|
| SLF0728T-2R2M-N | 2.2 | 20 | 1 | 0.032 | 1.8 |
| SLF0728T-3R3M-N | 3.3 | 20 | 1 | 0.037 | 1.6 |
| SLF0728T-4R7M-N | 4.7 | 20 | 1 | 0.045 | 1.5 |
| SLF0728T-5R0M-N | 5.0 | 20 | 1 | 0.045 | 2.4 |
| SLF0728T-6R8M-N | 6.8 | 20 | 1 | 0.059 | 1.3 |
| SLF0728T-8R2M-N | 8.2 | 20 | 1 | 0.065 | 1.1 |
| SLF0728T-100M-N | 10 | 20 | 1 | 0.083 | 1.1 |
| SLF0728T-150M-N | 15 | 20 | 1 | 0.13 | 0.88 |
| SLF0728T-220M-N | 22 | 20 | 1 | 0.18 | 0.75 |
| SLF0728T-330M-N | 33 | 20 | 1 | 0.24 | 0.65 |
| SLF0728T-470M-N | 47 | 20 | 1 | 0.34 | 0.54 |

Note: When ordering, please specify tolerance code. Tolerance: M= $\pm 20\%$

- Operating temperature range - 40°C ~ 125°C(Including self - temperature rise)
- Isat for Inductance drop 10% from its value without current
- Measure Equipment :
L : E4980 or HP4284A , 1kHz 0.5V
RDC : Chroma 16502
Isat : HP4284A+HP42841A or WK3260B+WK3265B

Electrical Characteristics

| Part Number | Inductance (μ H) | Tolerance (\pm %) | Test Frequency (kHz) | RDC ($\Omega \pm 20\%$) | Isat (A) |
|-----------------|--------------------------|-------------------------|-------------------------|------------------------------|-------------|
| SLF0730T-3R3M-N | 3.3 | 20 | 1 | 0.023 | 1.8 |
| SLF0730T-4R7M-N | 4.7 | 20 | 1 | 0.036 | 1.6 |
| SLF0730T-6R8M-N | 6.8 | 20 | 1 | 0.041 | 1.5 |
| SLF0730T-100M-N | 10 | 20 | 1 | 0.060 | 1.3 |
| SLF0730T-150M-N | 15 | 20 | 1 | 0.084 | 1 |
| SLF0730T-220M-N | 22 | 20 | 1 | 0.15 | 0.86 |
| SLF0730T-330M-N | 33 | 20 | 1 | 0.16 | 0.65 |
| SLF0730T-470M-N | 47 | 20 | 1 | 0.24 | 0.57 |
| SLF0730T-680M-N | 68 | 20 | 1 | 0.31 | 0.49 |
| SLF0730T-101M-N | 100 | 20 | 1 | 0.45 | 0.35 |

Note: When ordering, please specify tolerance code. Tolerance: M= $\pm 20\%$

- Operating temperature range - 40°C ~ 125°C(Including self - temperature rise)
- Isat for Inductance drop 10% from its value without current
- Measure Equipment :
L : E4980 or HP4284A , 1kHz 0.5V
RDC : Chroma 16502
Isat : HP4284A+HP42841A or WK3260B+WK3265B

Electrical Characteristics

| Part Number | Inductance (μ H) | Tolerance (\pm %) | Test Frequency (kHz) | RDC ($\Omega \pm 20\%$) | Isat (A) |
|-----------------|--------------------------|-------------------------|-------------------------|------------------------------|-------------|
| SLF0732T-2R2M-N | 2.2 | 20 | 1 | 0.018 | 2.1 |
| SLF0732T-3R3M-N | 3.3 | 20 | 1 | 0.023 | 1.9 |
| SLF0732T-4R7M-N | 4.7 | 20 | 1 | 0.036 | 1.7 |
| SLF0732T-6R8M-N | 6.8 | 20 | 1 | 0.041 | 1.6 |
| SLF0732T-100M-N | 10 | 20 | 1 | 0.053 | 1.4 |
| SLF0732T-150M-N | 15 | 20 | 1 | 0.075 | 1.1 |
| SLF0732T-220M-N | 22 | 20 | 1 | 0.11 | 0.96 |
| SLF0732T-330M-N | 33 | 20 | 1 | 0.16 | 0.75 |
| SLF0732T-470M-N | 47 | 20 | 1 | 0.24 | 0.67 |
| SLF0732T-680M-N | 68 | 20 | 1 | 0.31 | 0.59 |
| SLF0732T-101M-N | 100 | 20 | 1 | 0.45 | 0.45 |
| SLF0732T-151M-N | 150 | 20 | 1 | 0.65 | 0.37 |
| SLF0732T-221M-N | 220 | 20 | 1 | 1.05 | 0.29 |
| SLF0732T-331M-N | 330 | 20 | 1 | 1.67 | 0.22 |
| SLF0732T-471M-N | 470 | 20 | 1 | 2.05 | 0.2 |
| SLF0732T-681M-N | 680 | 20 | 1 | 3.15 | 0.16 |
| SLF0732T-102M-N | 1000 | 20 | 1 | 4.78 | 0.13 |

Note: When ordering, please specify tolerance code. Tolerance: M= $\pm 20\%$

- Operating temperature range - 40°C ~ 125°C(Including self - temperature rise)
- Isat for Inductance drop 10% from its value without current
- Measure Equipment :
L : E4980 or HP4284A , 1kHz 0.5V
RDC : Chroma 16502
Isat : HP4284A+HP42841A or WK3260B+WK3265B

Electrical Characteristics

| Part Number | Inductance (μ H) | Tolerance (\pm %) | Test Frequency (kHz) | RDC ($\Omega \pm 20\%$) | Isat (A) | Irms (A) Max |
|-----------------|--------------------------|-------------------------|-------------------------|------------------------------|-------------|-----------------|
| SLF0745T-3R3M-N | 3.3 | 20 | 1 | 0.02 | 2.5 | 2.3 |
| SLF0745T-4R7M-N | 4.7 | 20 | 1 | 0.03 | 2 | 2.1 |
| SLF0745T-6R8M-N | 6.8 | 20 | 1 | 0.039 | 1.7 | 1.74 |
| SLF0745T-100M-N | 10 | 20 | 1 | 0.036 | 1.3 | 1.78 |
| SLF0745T-150M-N | 15 | 20 | 1 | 0.052 | 1.1 | 1.53 |
| SLF0745T-220M-N | 22 | 20 | 1 | 0.061 | 0.9 | 1.34 |
| SLF0745T-330M-N | 33 | 20 | 1 | 0.096 | 0.82 | 1.09 |
| SLF0745T-470M-N | 47 | 20 | 1 | 0.125 | 0.75 | 0.92 |
| SLF0745T-680M-N | 68 | 20 | 1 | 0.175 | 0.6 | 0.77 |
| SLF0745T-101M-N | 100 | 20 | 1 | 0.25 | 0.5 | 0.65 |
| SLF0745T-151M-N | 150 | 20 | 1 | 0.34 | 0.4 | 0.55 |
| SLF0745T-221M-N | 220 | 20 | 1 | 0.52 | 0.33 | 0.45 |
| SLF0745T-331M-N | 330 | 20 | 1 | 0.74 | 0.25 | 0.37 |
| SLF0745T-471M-N | 470 | 20 | 1 | 1.05 | 0.22 | 0.31 |
| SLF0745T-681M-N | 680 | 20 | 1 | 1.48 | 0.2 | 0.27 |
| SLF0745T-102M-N | 1000 | 20 | 1 | 2.28 | 0.14 | 0.25 |

Note: When ordering, please specify tolerance code. Tolerance: M=±20%

- Operating temperature range - 40°C ~ 125°C(Including self - temperature rise)
- Isat for Inductance drop 10% from its value without current
- Irms for a 20°C temperature rise from 25°C ambient with current
- Measure Equipment :
 L : E4980 or HP4284A , 1kHz 0.5V
 RDC : Chroma 16502
 Isat : HP4284A+HP42841A or WK3260B+WK3265B

Electrical Characteristics

| Part Number | Inductance (μ H) | Tolerance (\pm %) | Test Frequency (kHz) | RDC (Ω) | Isat (A) | Irms (A) Max |
|-----------------|--------------------------|-------------------------|-------------------------|---------------------|-------------|-----------------|
| SLF0755T-1R5T-N | 1.5 | 30 | 100 | 0.0174±30% | 6.2 | 4.0 |
| SLF0755T-2R2T-N | 2.2 | 30 | 100 | 0.0217±30% | 5.3 | 3.5 |
| SLF0755T-3R3T-N | 3.3 | 30 | 100 | 0.0240±30% | 4.3 | 3.3 |
| SLF0755T-4R7T-N | 4.7 | 30 | 100 | 0.0280±30% | 3.6 | 3.1 |
| SLF0755T-6R8T-N | 6.8 | 30 | 100 | 0.0340±30% | 3.0 | 2.8 |
| SLF0755T-100M-N | 10 | 20 | 100 | 0.0391±20% | 2.6 | 2.5 |
| SLF0755T-150M-N | 15 | 20 | 100 | 0.0508±20% | 2.1 | 2.2 |
| SLF0755T-220M-N | 22 | 20 | 100 | 0.0643±20% | 1.7 | 2.0 |
| SLF0755T-470M-N | 47 | 20 | 100 | 0.1550±20% | 0.8 | 1.0 |

Note: When ordering, please specify tolerance code. Tolerance: M=±20% , T=±30%

- Operating temperature range - 40°C ~ 125°C(Including self - temperature rise)
- Isat for Inductance drop 10% from its value without current
- Irms for a 30°C temperature rise from 25°C ambient with current
- Measure Equipment :
 L : E4980 or HP4284A , 100kHz 1V
 RDC : Chroma 16502
 Isat : HP4284A+HP42841A or WK3260B+WK3265B

Electrical Characteristics

| Part Number | Inductance (μ H) | Tolerance (\pm %) | Test Frequency (kHz) | RDC ($\Omega \pm 20\%$) | Isat (A) | Irms (A) Max |
|-----------------|--------------------------|-------------------------|-------------------------|------------------------------|-------------|-----------------|
| SLF1045T-4R7T-N | 4.7 | 20 | 1 | 0.0200 | 4.5 | |
| SLF1045T-100M-N | 10 | 20 | 1 | 0.0364 | 3.0 | 2.5 |
| SLF1045T-150M-N | 15 | 20 | 1 | 0.0472 | 2.4 | 2.2 |
| SLF1045T-220M-N | 22 | 20 | 1 | 0.0591 | 2.1 | 1.9 |
| SLF1045T-330M-N | 33 | 20 | 1 | 0.0815 | 1.6 | 1.7 |
| SLF1045T-470M-N | 47 | 20 | 1 | 0.1 | 1.4 | 1.5 |
| SLF1045T-680M-N | 68 | 20 | 1 | 0.14 | 1.2 | 1.3 |
| SLF1045T-101M-N | 100 | 20 | 1 | 0.2 | 1.0 | 1.1 |
| SLF1045T-151M-N | 150 | 20 | 1 | 0.35 | 0.79 | 0.81 |
| SLF1045T-221M-N | 220 | 20 | 1 | 0.47 | 0.65 | 0.70 |
| SLF1045T-271M-N | 270 | 20 | 1 | 0.58 | 0.58 | 0.60 |
| SLF1045T-331M-N | 330 | 20 | 1 | 0.68 | 0.54 | 0.58 |
| SLF1045T-471M-N | 470 | 20 | 1 | 1.03 | 0.47 | 0.47 |
| SLF1045T-681M-N | 680 | 20 | 1 | 1.6 | 0.38 | 0.38 |
| SLF1045T-102M-N | 1000 | 20 | 1 | 2.8 | 0.32 | 0.29 |
| SLF1045T-152M-N | 1500 | 20 | 1 | 3.4 | 0.22 | 0.26 |

Note: When ordering, please specify tolerance code. Tolerance: M= $\pm 20\%$, T= $\pm 30\%$

- Operating temperature range - 40°C ~ 125°C(Including self - temperature rise)
- Isat for Inductance drop 10% from its value without current
- Irms for a 30°C temperature rise from 25°C ambient with current
- Measure Equipment :
 L : E4980 or HP4284A , 1kHz 0.5V
 RDC : Chroma 16502
 Isat : HP4284A+HP42841A or WK3260B+WK3265B
 Isat : HP4284A+HP42841A or WK3260B+WK3265B

Electrical Characteristics

| Part Number | Inductance (μ H) | Tolerance (\pm %) | Test Frequency (kHz) | RDC (Ω) Max | Isat (A) |
|-----------------|--------------------------|-------------------------|-------------------------|-------------------------|-------------|
| SLF1055T-4R7M-N | 4.7 | 20 | 1 | 0.035 | 4.0 |
| SLF1055T-100M-N | 10 | 20 | 1 | 0.040 | 3.0 |
| SLF1055T-220M-N | 22 | 20 | 1 | 0.0456 | 2.5 |
| SLF1055T-330M-N | 33 | 20 | 1 | 0.085 | 2.1 |

Note: When ordering, please specify tolerance code. Tolerance: M= $\pm 20\%$

- Operating temperature range - 40°C ~ 125°C(Including self - temperature rise)
- Isat for Inductance drop 15% from its value without current
- Measure Equipment :
 L : E4980 or HP4284A , 1kHz 0.5V
 RDC : Chroma 16502
 Isat : HP4284A+HP42841A or WK3260B+WK3265B

Electrical Characteristics

| Part Number | Inductance (μ H) | Tolerance (\pm %) | Test Frequency (kHz) | RDC ($\Omega \pm 20\%$) | Isat (A) | Irms (A) Max |
|-----------------|--------------------------|-------------------------|-------------------------|------------------------------|-------------|-----------------|
| SLF1255T-6R0M-N | 6 | 20 | 1 | 0.0164 | 3.6 | 4.9 |
| SLF1255T-100M-N | 10 | 20 | 1 | 0.0215 | 3.4 | 4.3 |
| SLF1255T-150M-N | 15 | 20 | 1 | 0.0259 | 2.8 | 3.9 |
| SLF1255T-220M-N | 22 | 20 | 1 | 0.0338 | 2.3 | 3.4 |
| SLF1255T-330M-N | 33 | 20 | 1 | 0.0415 | 1.9 | 3.1 |
| SLF1255T-470M-N | 47 | 20 | 1 | 0.0618 | 1.6 | 2.5 |
| SLF1255T-680M-N | 68 | 20 | 1 | 0.0832 | 1.3 | 2.2 |
| SLF1255T-101M-N | 100 | 20 | 1 | 0.117 | 1.1 | 1.8 |
| SLF1255T-151M-N | 150 | 20 | 1 | 0.19 | 0.88 | 1.4 |
| SLF1255T-221M-N | 220 | 20 | 1 | 0.27 | 0.72 | 1.2 |
| SLF1255T-331M-N | 330 | 20 | 1 | 0.41 | 0.59 | 1 |
| SLF1255T-471M-N | 470 | 20 | 1 | 0.52 | 0.49 | 0.88 |
| SLF1255T-681M-N | 680 | 20 | 1 | 0.76 | 0.43 | 0.73 |
| SLF1255T-102M-N | 1000 | 20 | 1 | 1.12 | 0.34 | 0.6 |
| SLF1255T-152M-N | 1500 | 20 | 1 | 1.73 | 0.29 | 0.48 |

Note: When ordering, please specify tolerance code. Tolerance: M= $\pm 20\%$

- Operating temperature range - 40°C ~ 125°C(Including self - temperature rise)
- Isat for Inductance drop 10% from its value without current
- Irms for a 30°C temperature rise from 25°C ambient with current
- Measure Equipment :
L : E4980 or HP4284A , 1kHz 0.5V
RDC : Chroma 16502
Isat : HP4284A+HP42841A or WK3260B+WK3265B

Electrical Characteristics

| Part Number | Inductance (μ H) | Tolerance (\pm %) | Test Frequency (kHz) | RDC ($\Omega \pm 20\%$) | Isat (A) | Irms (A) Max |
|-----------------|--------------------------|-------------------------|-------------------------|------------------------------|-------------|-----------------|
| SLF1265T-2R0T-N | 2 | 30 | 1 | 0.0117 | 10 | 6.2 |
| SLF1265T-4R2T-N | 4.2 | 30 | 1 | 0.015 | 7.3 | 5.5 |
| SLF1265T-7R0T-N | 7 | 30 | 1 | 0.0177 | 5.7 | 5.0 |
| SLF1265T-100M-N | 10 | 20 | 1 | 0.0202 | 5.0 | 4.8 |
| SLF1265T-150M-N | 15 | 20 | 1 | 0.0237 | 4.2 | 4.4 |
| SLF1265T-220M-N | 22 | 20 | 1 | 0.0316 | 3.5 | 3.8 |
| SLF1265T-330M-N | 33 | 20 | 1 | 0.0490 | 2.8 | 3.4 |
| SLF1265T-470M-N | 47 | 20 | 1 | 0.0578 | 2.4 | 2.8 |
| SLF1265T-680M-N | 68 | 20 | 1 | 0.0787 | 2.0 | 2.4 |
| SLF1265T-101M-N | 100 | 20 | 1 | 0.123 | 1.6 | 1.9 |
| SLF1265T-151M-N | 150 | 20 | 1 | 0.210 | 1.2 | 1.5 |
| SLF1265T-221M-N | 220 | 20 | 1 | 0.273 | 1.0 | 1.2 |

Note: When ordering, please specify tolerance code. Tolerance: M= $\pm 20\%$, T= $\pm 30\%$

- Operating temperature range - 40°C ~ 125°C(Including self - temperature rise)
- Isat for Inductance drop 10% from its value without current
- Irms for a 40°C temperature rise from 25°C ambient with current
- Measure Equipment :
L : E4980 or HP4284A , 1kHz 0.5V
RDC : Chroma 16502
Isat : HP4284A+HP42841A or WK3260B+WK3265B

Please be sure to request approval specifications that provide further details of the products. Kindly note that the content of these specifications are subject to change or may be discontinued without advance notice. Please contact our sales department before ordering.

Electrical Characteristics

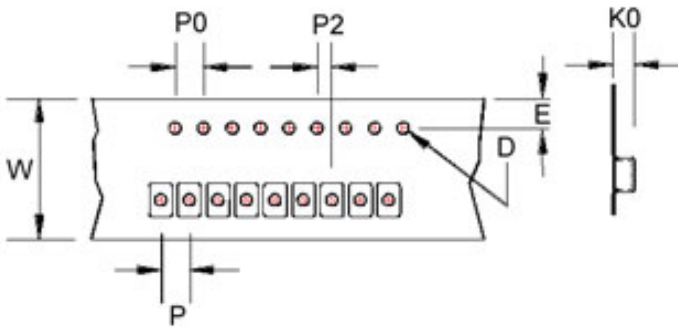
| Part Number | Inductance (μH) | Tolerance ($\pm\%$) | Test Frequency (kHz) | RDC ($\Omega\pm 20\%$) | Isat (A) | Irms (A) Max |
|-----------------|---------------------------------|--------------------------|-------------------------|-----------------------------|-------------|-----------------|
| SLF1275T-1R2T-N | 1.2 | 30 | 1 | 0.0069 | 13 | 8.2 |
| SLF1275T-2R7T-N | 2.7 | 30 | 1 | 0.0094 | 10 | 7.0 |
| SLF1275T-3R9T-N | 3.9 | 30 | 1 | 0.0104 | 9 | 6.7 |
| SLF1275T-4R7T-N | 4.7 | 30 | 1 | 0.0110 | 7.8 | 6.3 |
| SLF1275T-5R6T-N | 5.6 | 30 | 1 | 0.0116 | 7.8 | 6.3 |
| SLF1275T-6R8T-N | 6.8 | 30 | 1 | 0.0131 | 7.2 | 5.9 |
| SLF1275T-100M-N | 10 | 20 | 1 | 0.0156 | 5.5 | 5.4 |
| SLF1275T-150M-N | 15 | 20 | 1 | 0.0184 | 4.7 | 5.0 |
| SLF1275T-220M-N | 22 | 20 | 1 | 0.0263 | 4.0 | 4.0 |
| SLF1275T-330M-N | 33 | 20 | 1 | 0.0395 | 3.2 | 3.4 |
| SLF1275T-470M-N | 47 | 20 | 1 | 0.0528 | 2.7 | 3.0 |
| SLF1275T-680M-N | 68 | 20 | 1 | 0.0778 | 2.0 | 2.4 |
| SLF1275T-101M-N | 100 | 20 | 1 | 0.1250 | 1.9 | 1.9 |
| SLF1275T-151M-N | 150 | 20 | 1 | 0.1750 | 1.5 | 1.6 |
| SLF1275T-221M-N | 220 | 20 | 1 | 0.2580 | 1.3 | 1.3 |
| SLF1275T-331M-N | 330 | 20 | 1 | 0.340 | 0.9 | |

Note: When ordering, please specify tolerance code. Tolerance: M= $\pm 20\%$, T= $\pm 30\%$

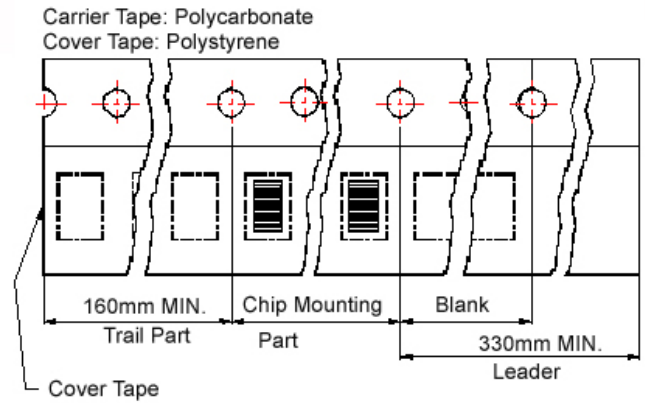
- Operating temperature range - 40°C ~ 125°C(Including self - temperature rise)
- Isat for Inductance drop 10% from its value without current
- Irms for a 40°C temperature rise from 25°C ambient with current
- Measure Equipment :
 L : E4980 or HP4284A , 1kHz 0.5V
 RDC : Chroma 16502
 Isat : HP4284A+HP42841A or WK3260B+WK3265B

Packaging Specifications

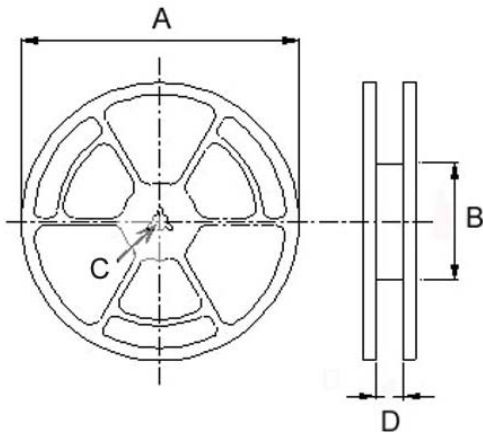
Tape Dimensions



Tape Material



Reel Dimensions



Dimensions in mm

| TYPE | Tape Dimensions | | | | | | | Reel Dimensions | | | | Quantity PCS / REEL |
|----------|-----------------|------|------|----|----|----|----|-----------------|-----|----|------|------------------------|
| | K0 | D | E | W | P | P0 | P2 | A | B | C | D | |
| SLF 0628 | 3.4 | 1.55 | 1.75 | 16 | 12 | 4 | 2 | 330 | 100 | 13 | 16.0 | 1000 |
| SLF 0728 | 3.2 | 1.55 | 1.75 | 16 | 12 | 4 | 2 | 330 | 100 | 13 | 16.0 | 1000 |
| SLF 0730 | 3.5 | 1.55 | 1.75 | 16 | 12 | 4 | 2 | 330 | 100 | 13 | 16.0 | 1000 |
| SLF 0732 | 3.5 | 1.55 | 1.75 | 16 | 12 | 4 | 2 | 330 | 100 | 13 | 16.0 | 1000 |
| SLF 0745 | 4.8 | 1.55 | 1.75 | 16 | 12 | 4 | 2 | 330 | 100 | 13 | 16.0 | 1000 |
| SLF 0755 | 5.7 | 1.55 | 1.75 | 16 | 12 | 4 | 2 | 330 | 100 | 13 | 16.0 | 900 |
| SLF 1045 | 5.0 | 1.55 | 1.75 | 24 | 16 | 4 | 2 | 330 | 100 | 13 | 24.4 | 500 |
| SLF 1055 | 5.0 | 1.55 | 1.75 | 24 | 16 | 4 | 2 | 330 | 100 | 13 | 24.4 | 500 |
| SLF 1255 | 6.0 | 1.55 | 1.75 | 24 | 16 | 4 | 2 | 330 | 100 | 13 | 24.4 | 500 |
| SLF 1265 | 7.0 | 1.55 | 1.75 | 24 | 16 | 4 | 2 | 330 | 100 | 13 | 24.4 | 500 |
| SLF 1275 | 8.2 | 1.55 | 1.75 | 24 | 16 | 4 | 2 | 330 | 100 | 13 | 24.4 | 350 |

SLFA Series

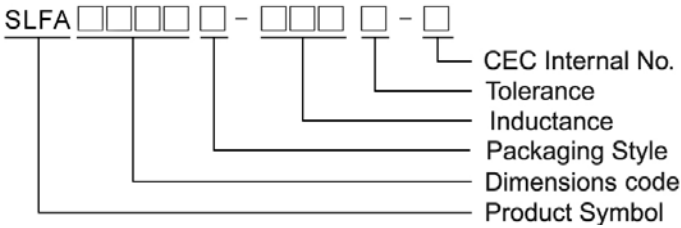
Features

- RoHS, Halogen Free and REACH Compliance
- Magnetically shielded type
- Cost effective
- Low DCR

Applications

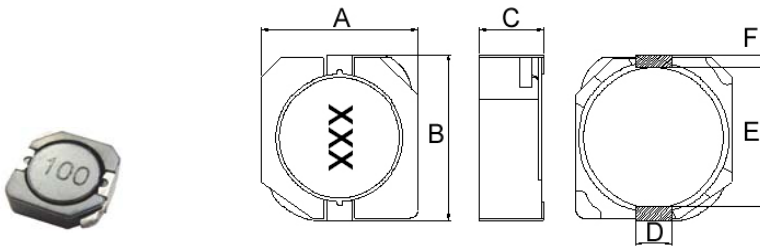
- TV
- Laptop
- Mainboard
- Automotive devices
- Commercial devices

Product Identification



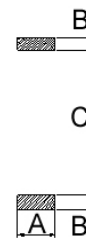
SLFA 5D28

Shape and Dimensions



| Dimensions in mm | | | | | | |
|------------------|-------------------|-------------------|-------------------|-----|-----|-----|
| TYPE | A | B | C | D | E | F |
| SLFA5D28 | 6.3 ⁺⁰ | 6.3 ⁺⁰ | 3.0 ⁺⁰ | 2.0 | 4.0 | 0.9 |

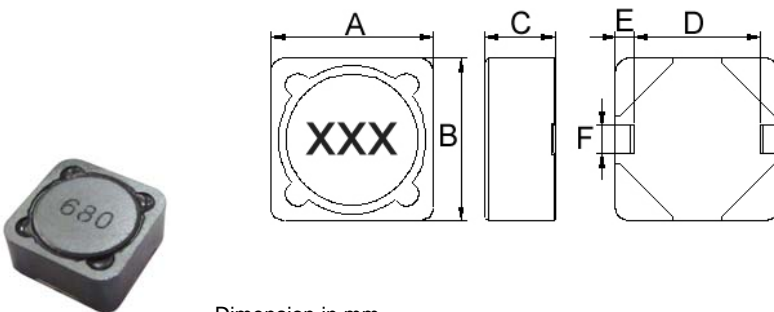
Recommended Pattern



| Dimension in mm | | | |
|-----------------|-----|-----|-----|
| TYPE | A | B | C |
| SLFA5D28 | 2.2 | 1.5 | 4.0 |

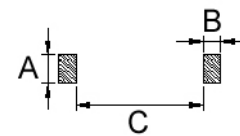
SLFA 0745~1255

Shape and Dimensions



| Dimension in mm | | | | | | |
|-----------------|--------------------|--------------------|-------------------|-----|-----|-----|
| TYPE | A | B | C | D | E | F |
| SLFA0745 | 7.3±0.2 | 7.3±0.2 | 4.8 ⁺⁰ | 5.5 | 0.9 | 2.0 |
| SLFA0755 | 7.3±0.2 | 7.3±0.2 | 5.8 ⁺⁰ | 5.5 | 0.9 | 2.0 |
| SLFA1255 | 12.5 ⁺⁰ | 12.5 ⁺⁰ | 5.8 ⁺⁰ | 8.0 | 2.0 | 2.7 |

Recommended Pattern



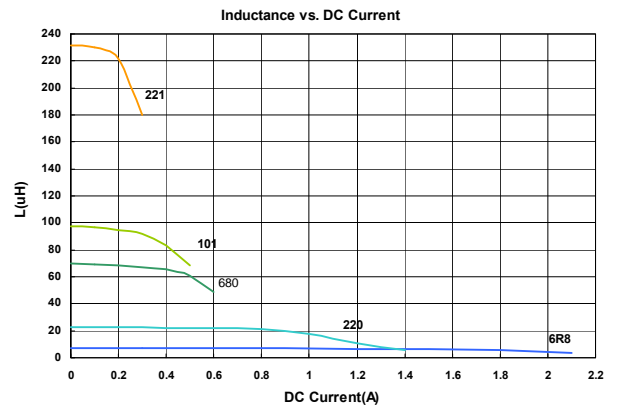
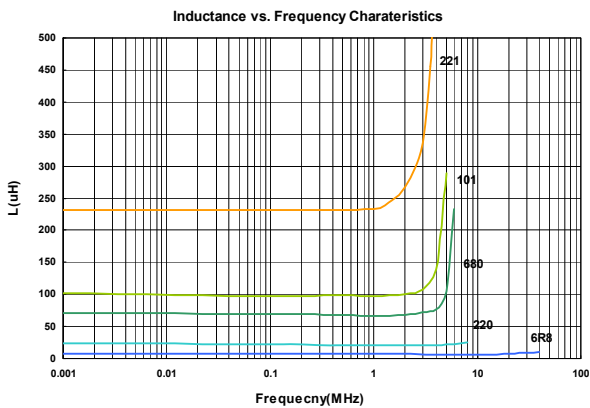
| Dimension in mm | | | |
|-----------------|-----|-----|-----|
| TYPE | A | B | C |
| SLFA0745 | 2.2 | 1.5 | 4.8 |
| SLFA0755 | 2.2 | 1.5 | 4.8 |
| SLFA1255 | 3.2 | 2.6 | 7.5 |

Standard Specifications

| Part Number | Inductance (uH) | Tolerance (±%) | Test Frequency (kHz) | SRF (MHz) Min | RDC (mΩ) Max | Isat (A) | Irms (A) | Marking |
|------------------|-----------------|----------------|----------------------|---------------|--------------|----------|----------|---------|
| SLFA5D28T-6R8T-N | 6.8 | 30 | 100 | 35 | 42 | 1.50 | 2.20 | 6R8 |
| SLFA5D28T-100M-N | 10 | 20 | 100 | 20 | 63.8 | 1.30 | 1.80 | 100 |
| SLFA5D28T-150M-N | 15 | 20 | 100 | 15 | 89.4 | 1.00 | 1.40 | 150 |
| SLFA5D28T-220M-N | 22 | 20 | 100 | 10 | 124 | 0.77 | 1.30 | 220 |
| SLFA5D28T-330M-N | 33 | 20 | 100 | 7 | 177 | 0.69 | 1.10 | 330 |
| SLFA5D28T-470M-N | 47 | 20 | 100 | 5 | 252 | 0.59 | 0.92 | 470 |
| SLFA5D28T-680M-N | 68 | 20 | 100 | 4 | 348 | 0.50 | 0.78 | 680 |
| SLFA5D28T-101M-N | 100 | 20 | 100 | 4 | 516 | 0.42 | 0.64 | 101 |
| SLFA5D28T-151M-N | 150 | 30 | 100 | 4 | 780 | 0.34 | 0.50 | 151 |
| SLFA5D28T-221M-N | 220 | 20 | 100 | 3.2 | 1170 | 0.26 | 0.38 | 221 |

Note: When ordering, please specify tolerance code. Tolerance: M=±20% , T=±30%

- Operating temperature range - 40°C ~ 125°C(Including self - temperature rise)
- Isat for Inductance drop 30% from its value without current
- Irms for a 25°C temprature rise from 25°C ambient
- Measure Equipment :
 L : L: WK6500B+WK6565, 100kHz/ 1V
 RDC : Chroma 16502
 Isat : WK3260B+WK3265B

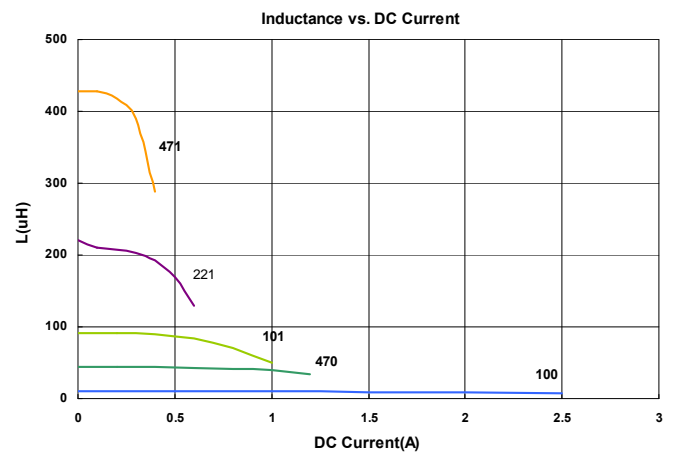
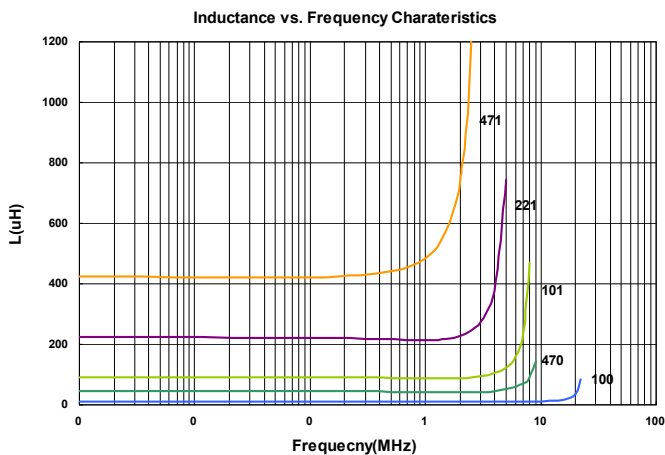


Standard Specifications

| Part Number | Inductance (uH) | Tolerance (±%) | Test Frequency (kHz) | SRF (MHz) Min | RDC (mΩ) Max | Isat (A) | Irms (A) | Marking |
|------------------|-----------------|----------------|----------------------|---------------|--------------|----------|----------|---------|
| SLFA0745T-3R3M-N | 3.3 | 20 | 100 | 90 | 24 | 2.50 | 2.30 | 3R3 |
| SLFA0745T-4R7M-N | 4.7 | 20 | 100 | 65 | 36 | 2.00 | 2.10 | 4R7 |
| SLFA0745T-6R8M-N | 6.8 | 20 | 100 | 24 | 40 | 1.70 | 1.74 | 6R8 |
| SLFA0745T-100M-N | 10 | 20 | 100 | 17 | 43.2 | 1.30 | 1.78 | 100 |
| SLFA0745T-150M-N | 15 | 20 | 100 | 14 | 62.4 | 1.10 | 1.53 | 150 |
| SLFA0745T-220M-N | 22 | 20 | 100 | 10.5 | 73.2 | 0.90 | 1.34 | 220 |
| SLFA0745T-330M-N | 33 | 20 | 100 | 10.0 | 115 | 0.82 | 1.09 | 330 |
| SLFA0745T-470M-N | 47 | 20 | 100 | 8.0 | 150 | 0.75 | 0.92 | 470 |
| SLFA0745T-680M-N | 68 | 20 | 100 | 7.0 | 210 | 0.60 | 0.77 | 680 |
| SLFA0745T-101M-N | 100 | 20 | 100 | 6.0 | 300 | 0.50 | 0.65 | 101 |
| SLFA0745T-151M-N | 150 | 20 | 100 | 4.0 | 408 | 0.40 | 0.55 | 151 |
| SLFA0745T-221M-N | 220 | 20 | 100 | 3.5 | 624 | 0.33 | 0.45 | 221 |
| SLFA0745T-331M-N | 330 | 20 | 100 | 3.0 | 880 | 0.25 | 0.37 | 331 |
| SLFA0745T-471M-N | 470 | 20 | 100 | 2.5 | 1260 | 0.22 | 0.31 | 471 |
| SLFA0745T-681M-N | 680 | 20 | 100 | 2.1 | 1770 | 0.20 | 0.27 | 681 |
| SLFA0745T-102M-N | 1000 | 20 | 100 | 1.1 | 2730 | 0.14 | 0.25 | 102 |

Note: When ordering, please specify tolerance code. Tolerance: M=±20%

- Operating temperature range - 40°C ~ 125°C(Including self - temperature rise)
- Isat for Inductance drop 10% from its value without current
- Irms for a 20°C temprature rise from 25°C ambient
- Measure Equipment :
 L : L: WK6500B+WK6565, 100kHz/ 1V
 RDC : Chroma 16502
 Isat : WK3260B+WK3265B



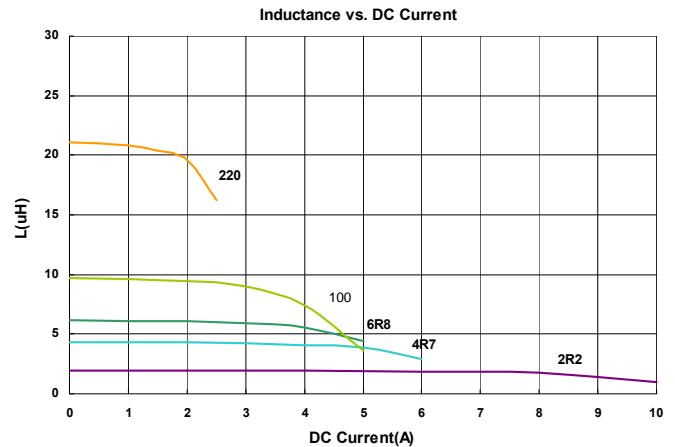
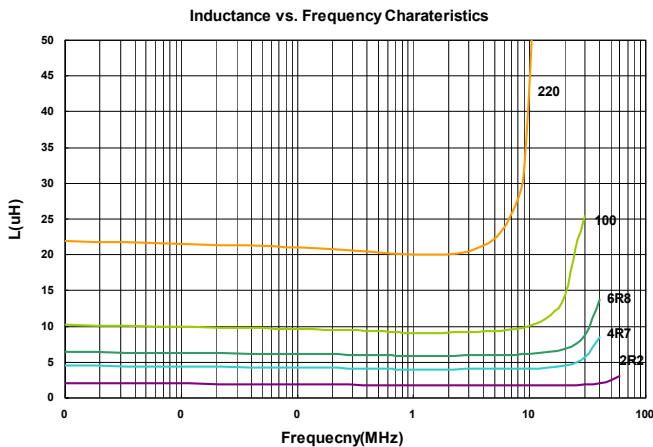
Please be sure to request approval specifications that provide further details of the products. Kindly note that the content of these specifications are subject to change or may be discontinued without advance notice. Please contact our sales department before ordering.

Standard Specifications

| Part Number | Inductance (uH) | Tolerance (±%) | Test Frequency (kHz) | SRF (MHz) Min | RDC (mΩ) Max | Isat (A) | Irms (A) | Marking |
|------------------|-----------------|----------------|----------------------|---------------|--------------|----------|----------|---------|
| SLFA0755T-1R5T-N | 1.5 | 30 | 100 | 75 | 20 | 6.2 | 4.0 | 1R5 |
| SLFA0755T-2R2T-N | 2.2 | 30 | 100 | 55 | 23 | 5.3 | 3.5 | 2R2 |
| SLFA0755T-3R3T-N | 3.3 | 30 | 100 | 48 | 31 | 4.3 | 3.3 | 3R3 |
| SLFA0755T-4R7T-N | 4.7 | 30 | 100 | 38 | 36 | 3.6 | 3.1 | 4R7 |
| SLFA0755T-6R8T-N | 6.8 | 30 | 100 | 35 | 44 | 3.0 | 2.8 | 6R8 |
| SLFA0755T-100M-N | 10 | 20 | 100 | 22 | 46 | 2.6 | 2.5 | 100 |
| SLFA0755T-150M-N | 15 | 20 | 100 | 14 | 60.9 | 2.1 | 2.2 | 150 |
| SLFA0755T-220M-N | 22 | 20 | 100 | 8 | 77 | 1.7 | 2.0 | 220 |

Note: When ordering, please specify tolerance code. Tolerance: M=±20% , T=±30%

- Operating temperature range - 40°C ~ 125°C(Including self - temperature rise)
- Isat for Inductance drop 10% from its value without current
- Irms for a 30°C temprature rise from 25°C ambient.
- Measure Equipment :
 L : L: WK6500B+WK6565, 100kHz/ 1V
 RDC : Chroma 16502
 Isat : WK3260B+WK3265B

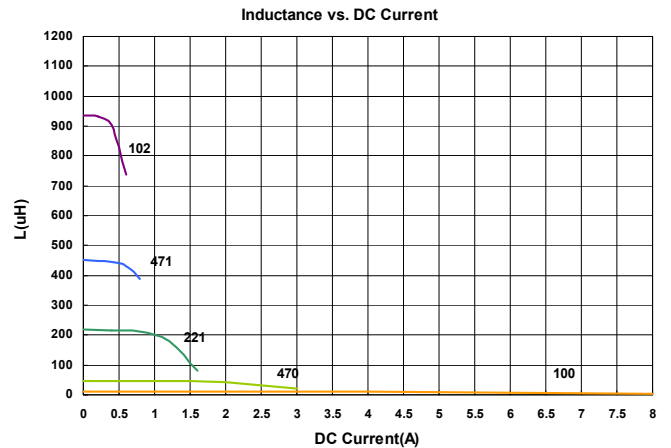
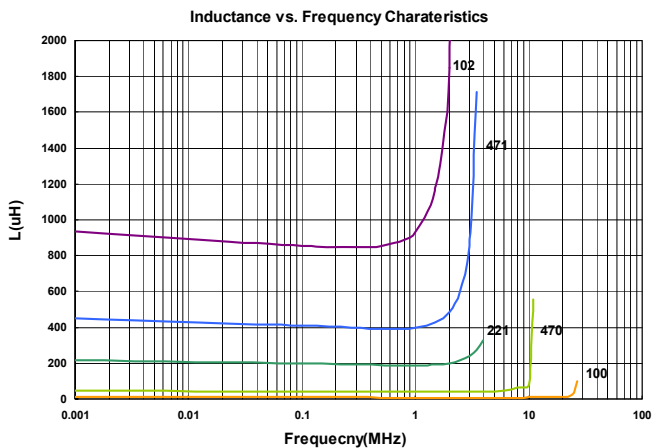


Standard Specifications

| Part Number | Inductance (uH) | Tolerance (±%) | Test Frequency (kHz) | SRF (MHz) Min | RDC (mΩ) Max | Isat (A) | Irms (A) | Marking |
|------------------|-----------------|----------------|----------------------|---------------|--------------|----------|----------|---------|
| SLFA1255T-6R0T-N | 6 | 30 | 1 | 26 | 19.7 | 3.6 | 4.9 | 6R0 |
| SLFA1255T-100M-N | 10 | 20 | 1 | 17 | 25.8 | 3.4 | 4.3 | 100 |
| SLFA1255T-150M-N | 15 | 20 | 1 | 15 | 31.0 | 2.8 | 3.9 | 150 |
| SLFA1255T-220M-N | 22 | 20 | 1 | 11 | 40.6 | 2.3 | 3.4 | 220 |
| SLFA1255T-330M-N | 33 | 20 | 1 | 10 | 49.8 | 1.9 | 3.1 | 330 |
| SLFA1255T-470M-N | 47 | 20 | 1 | 8 | 74.2 | 1.6 | 2.5 | 470 |
| SLFA1255T-680M-N | 68 | 20 | 1 | 7 | 99.8 | 1.3 | 2.2 | 680 |
| SLFA1255T-101M-N | 100 | 20 | 1 | 5.5 | 140 | 1.1 | 1.8 | 101 |
| SLFA1255T-151M-N | 150 | 30 | 1 | 4.5 | 228 | 0.88 | 1.4 | 151 |
| SLFA1255T-221M-N | 220 | 20 | 1 | 3.0 | 324 | 0.72 | 1.2 | 221 |
| SLFA1255T-331M-N | 330 | 20 | 1 | 3.0 | 492 | 0.59 | 1.0 | 331 |
| SLFA1255T-471M-N | 470 | 20 | 1 | 2.5 | 624 | 0.49 | 0.88 | 471 |
| SLFA1255T-681M-N | 680 | 20 | 1 | 2.0 | 912 | 0.43 | 0.73 | 681 |
| SLFA1255T-102M-N | 1000 | 20 | 1 | 1.7 | 1344 | 0.34 | 0.60 | 102 |
| SLFA1255T-152M-N | 1500 | 20 | 1 | 1.4 | 2076 | 0.29 | 0.48 | 152 |

Note: When ordering, please specify tolerance code. Tolerance: M=±20% , T=±30%

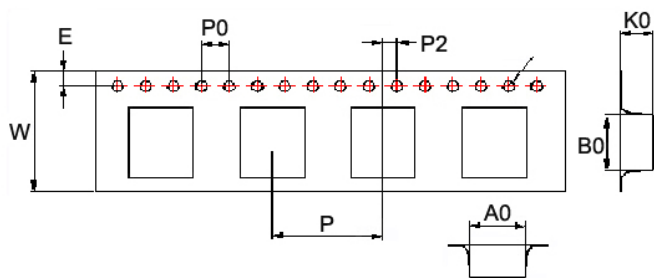
- Operating temperature range - 40°C ~ 125°C(Including self - temperature rise)
- Isat for Inductance drop 10% from its value without current
- Irms for a 30°C temprature rise from 25°C ambient.
- Measure Equipment :
 L : L: WK6500B+WK6565, 1kHz/ 1V
 RDC : Chroma 16502
 Isat : WK3260B+WK3265B



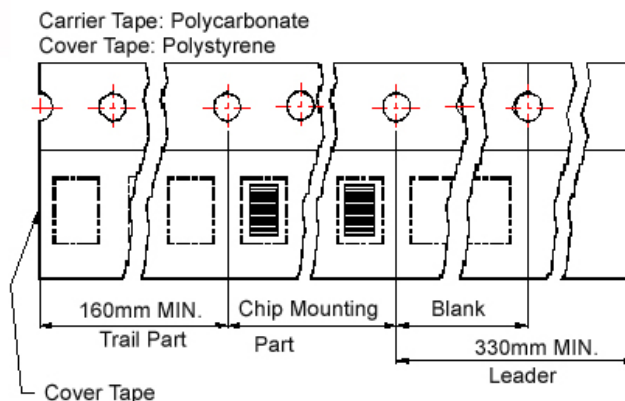
Please be sure to request approval specifications that provide further details of the products. Kindly note that the content of these specifications are subject to change or may be discontinued without advance notice. Please contact our sales department before ordering.

Packaging Specifications

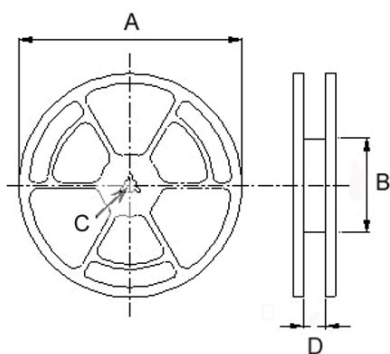
Tape Dimensions



Tape Material



Reel Dimensions



Dimensions in mm

| TYPE | Tape Dimensions | | | | | | | | | Reel Dimensions | | | | Quantity |
|-----------|-----------------|------|-----|------|------|----|----|----|----|-----------------|-----|----|------|------------|
| | A0 | B0 | K0 | D | E | W | P | P0 | P2 | A | B | C | D | PCS / REEL |
| SLFA 5D28 | 6.3 | 6.55 | 3.3 | 1.55 | 1.75 | 16 | 12 | 4 | 2 | 330 | 100 | 13 | 16.0 | 1000 |
| SLFA 0745 | 7.6 | 7.6 | 5.2 | 1.55 | 1.75 | 16 | 12 | 4 | 2 | 330 | 100 | 13 | 16.0 | 1000 |
| SLFA 0755 | 7.8 | 7.8 | 6.0 | 1.55 | 1.75 | 16 | 12 | 4 | 2 | 330 | 100 | 13 | 16.0 | 900 |
| SLFA 1255 | 12.6 | 12.6 | 6.7 | 1.55 | 1.75 | 24 | 16 | 4 | 2 | 330 | 100 | 13 | 24.2 | 600 |

SDT Series



Its feature of "swinging" inductance vs. current characteristics, the SSL0402 Series supports used as ultra high inductance at zero or low current.

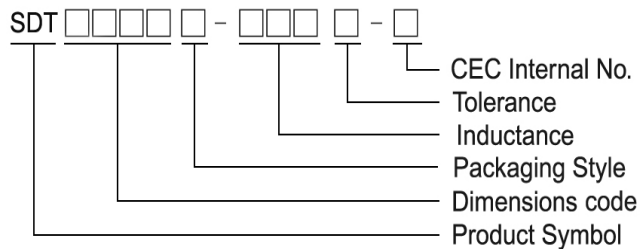
Features

- RoHS, Halogen Free and REACH Compliance
- Magnetic shielded
- Functions equally well in filter and smoothing circuit applications

Applications

- Electric motors
- DC/DC converters

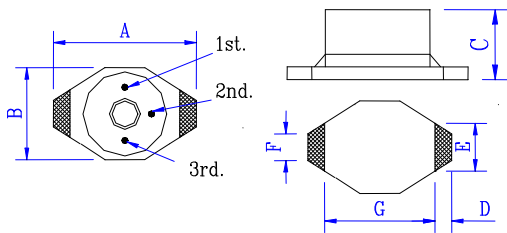
Product Identification



- Packaging: T : Tape and Reel

Shape and Dimensions

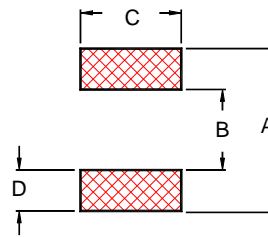
SDT 0402



Dimensions in mm

| A | B | C | D | E | F | G |
|--------------------|--------------------|--------------------|------|------|------|------|
| 6.60 ⁺⁰ | 4.54 ⁺⁰ | 2.92 ⁺⁰ | 1.02 | 3.05 | 1.27 | 4.32 |

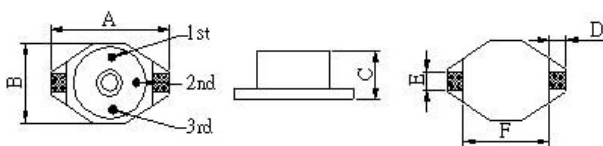
Recommended Pattern



Dimensions in mm

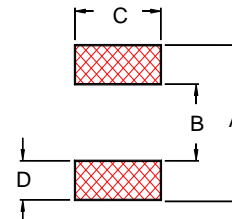
| A | B | C | D |
|------|------|------|------|
| 6.86 | 4.06 | 3.56 | 1.40 |

SDT 0804



Dimensions in mm

| A | B | C | D | E | F |
|---------------------|-------------------|--------------------|------|------|------|
| 12.95 ⁺⁰ | 9.4 ⁺⁰ | 5.08 ⁺⁰ | 2.54 | 2.54 | 7.62 |



Dimensions in mm

| A | B | C | D |
|-------|------|------|------|
| 13.21 | 7.37 | 2.79 | 2.92 |

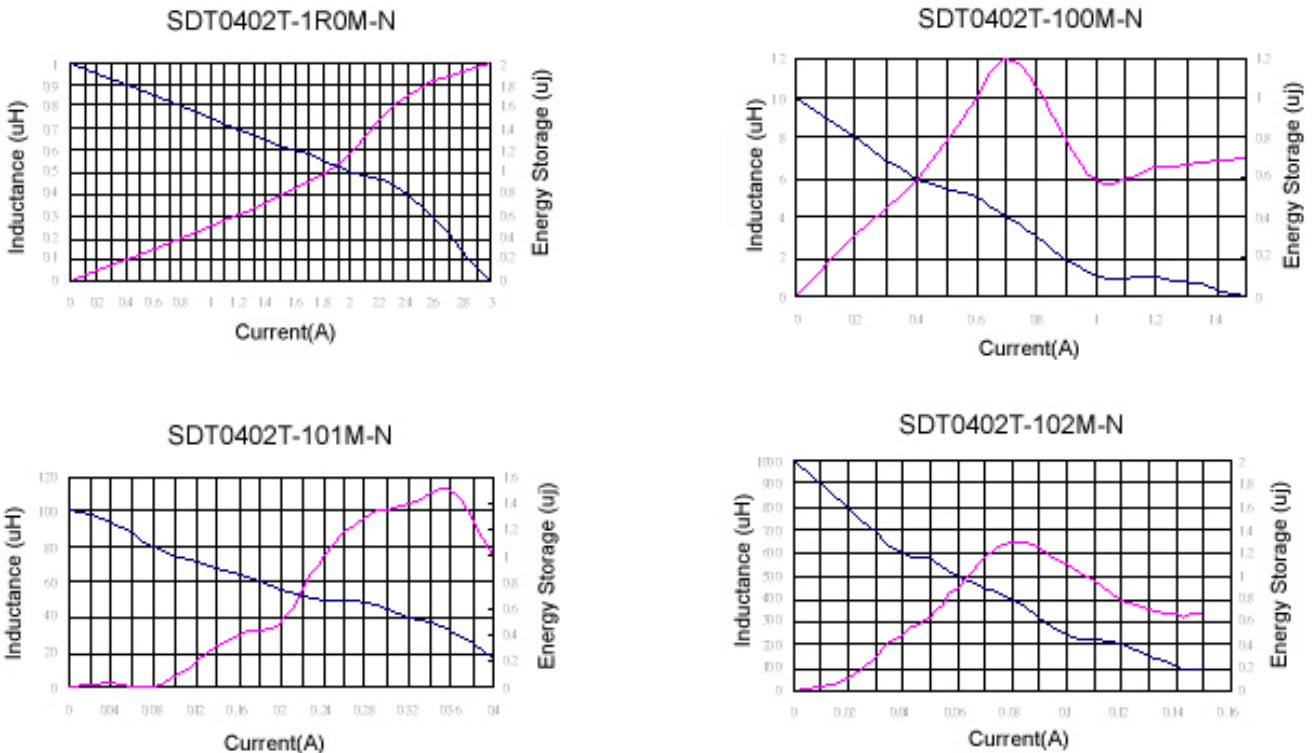
Electrical Characteristics

| Specifications | | | | Operating Parameters | | | | |
|-----------------|-----------------|----------------|-----------------------|------------------------------------|------------------------|--------------------|-------------------------------|-------------------------|
| Part Number | Inductance (μH) | Tolerance (±%) | DC Resistance (Ω) Max | Self Resonant Frequency (MHz) Typ. | Inductance Rating (μH) | Current Rating (A) | Energy Storage (μ Joules) Max | Switching Frequency Max |
| SDT0402T-1R0M-N | 1.0 | 20 | 0.045 | 157 | 0.60 | 2.0 | 1.8 | 1 MHz |
| SDT0402T-1R5M-N | 1.5 | 20 | 0.050 | 108 | 0.80 | 1.9 | 1.8 | 1 MHz |
| SDT0402T-2R2M-N | 2.2 | 20 | 0.060 | 92 | 0.90 | 1.5 | 1.8 | 1 MHz |
| SDT0402T-3R3M-N | 3.3 | 20 | 0.070 | 69 | 1.5 | 1.2 | 1.4 | 1 MHz |
| SDT0402T-4R7M-N | 4.7 | 20 | 0.080 | 59 | 2.0 | 1.2 | 1.6 | 1 MHz |
| SDT0402T-6R8M-N | 6.8 | 20 | 0.085 | 51 | 3.0 | 1.0 | 1.9 | 1 MHz |
| SDT0402T-100M-N | 10 | 20 | 0.095 | 33 | 5.0 | 0.7 | 1.2 | 1 MHz |
| SDT0402T-150M-N | 15 | 20 | 0.135 | 26 | 6.0 | 0.6 | 1.1 | 1 MHz |
| SDT0402T-220M-N | 22 | 20 | 0.160 | 20 | 10 | 0.5 | 1.2 | 1 MHz |
| SDT0402T-330M-N | 33 | 20 | 0.275 | 17 | 12 | 0.45 | 1.5 | 1 MHz |
| SDT0402T-470M-N | 47 | 20 | 0.340 | 12 | 20 | 0.34 | 1.3 | 1 MHz |
| SDT0402T-680M-N | 68 | 20 | 0.575 | 11 | 30 | 0.29 | 1.4 | 1 MHz |
| SDT0402T-101M-N | 100 | 20 | 1.100 | 9.4 | 40 | 0.24 | 1.5 | 1 MHz |
| SDT0402T-151M-N | 150 | 20 | 1.400 | 6.7 | 60 | 0.20 | 1.4 | 500 kHz |
| SDT0402T-221M-N | 220 | 20 | 2.250 | 6.1 | 90 | 0.17 | 1.6 | 500 kHz |
| SDT0402T-331M-N | 330 | 20 | 2.900 | 4.7 | 100 | 0.16 | 1.4 | 500 kHz |
| SDT0402T-471M-N | 470 | 20 | 3.600 | 3.85 | 150 | 0.14 | 1.5 | 500 kHz |
| SDT0402T-681M-N | 680 | 20 | 4.550 | 3.1 | 200 | 0.12 | 1.4 | 500 kHz |
| SDT0402T-102M-N | 1000 | 20 | 8.100 | 2.3 | 400 | 0.08 | 1.4 | 500 kHz |

Note: When ordering, please specify tolerance code. Tolerance: M=±20%

- Operating temperature range - 40°C ~ 125°C(Including self - temperature rise)
- Measured at the rated current. Refer to curves below for more detail.
- Average maximum allowable current. SDT Series inductors are designed for current spikes as high as 2X the current rating
- Measure Equipment :
 - L : E4980 or HP4284A, 100kHz 0.1V
 - RDC : Chroma 16502
 - SRF : HP4291A or HP4192A
 - Rated Current : HP4284A+HP42841A or WK3260B+WK3265B

Typical Inductance Energy Storage VS. Current



Please be sure to request approval specifications that provide further details of the products. Kindly note that the content of these specifications are subject to change or may be discontinued without advance notice. Please contact our sales department before ordering.

Electrical Characteristics

| Specifications | | | | Operating Parameters | | | | |
|-----------------|-----------------|----------------|-----------------------|------------------------------------|------------------------|--------------------|-------------------------------|-------------------------|
| Part Number | Inductance (μH) | Tolerance (±%) | DC Resistance (Ω) Max | Self Resonant Frequency (MHz) Typ. | Inductance Rating (μH) | Current Rating (A) | Energy Storage (μ Joules) Max | Switching Frequency Max |
| SDT0804T-1R0M-N | 1.0 | 20 | 0.025 | 60 | 0.50 | 5.0 | 9 | 1 MHz |
| SDT0804T-1R5M-N | 1.5 | 20 | 0.030 | 55 | 0.70 | 5.0 | 12 | 1 MHz |
| SDT0804T-2R2M-N | 2.2 | 20 | 0.035 | 55 | 1.00 | 5.0 | 15 | 1 MHz |
| SDT0804T-3R3M-N | 3.3 | 20 | 0.040 | 50 | 1.50 | 5.0 | 16 | 1 MHz |
| SDT0804T-4R7M-N | 4.7 | 20 | 0.045 | 45 | 2.00 | 3.0 | 10 | 1 MHz |
| SDT0804T-6R8M-N | 6.8 | 20 | 0.050 | 40 | 4.00 | 2.5 | 14 | 1 MHz |
| SDT0804T-100M-N | 10 | 20 | 0.055 | 35 | 5.00 | 2.0 | 11 | 1 MHz |
| SDT0804T-150M-N | 15 | 20 | 0.060 | 25 | 6.00 | 1.8 | 12 | 1 MHz |
| SDT0804T-220M-N | 22 | 20 | 0.084 | 22 | 10 | 1.5 | 11 | 1 MHz |
| SDT0804T-330M-N | 33 | 20 | 0.090 | 18 | 12 | 1.3 | 13 | 1 MHz |
| SDT0804T-470M-N | 47 | 20 | 0.11 | 16 | 27 | 1.0 | 13 | 1 MHz |
| SDT0804T-680M-N | 68 | 20 | 0.15 | 12 | 40 | 0.90 | 17 | 1 MHz |
| SDT0804T-101M-N | 100 | 20 | 0.29 | 9 | 50 | 0.80 | 15 | 1 MHz |
| SDT0804T-151M-N | 150 | 20 | 0.36 | 8 | 80 | 0.60 | 15 | 500 kHz |
| SDT0804T-221M-N | 220 | 20 | 0.39 | 6 | 90 | 0.50 | 10 | 500 kHz |
| SDT0804T-331M-N | 330 | 20 | 0.73 | 5 | 150 | 0.40 | 13 | 500 kHz |
| SDT0804T-471M-N | 470 | 20 | 0.88 | 4 | 200 | 0.35 | 13 | 500 kHz |
| SDT0804T-681M-N | 680 | 20 | 1.15 | 3 | 300 | 0.30 | 13 | 500 kHz |
| SDT0804T-102M-N | 1000 | 20 | 1.45 | 2.5 | 420 | 0.25 | 13 | 500 kHz |

Note: When ordering, please specify tolerance code. Tolerance: M=±20%

- Operating temperature range - 40°C ~ 125°C(Including self - temperature rise)
- Measured at the rated current. Refer to curves below for more detail.
- Average maximum allowable current. SDT Series inductors are designed for current spikes as high as 2X the current rating
- Measure Equipment :

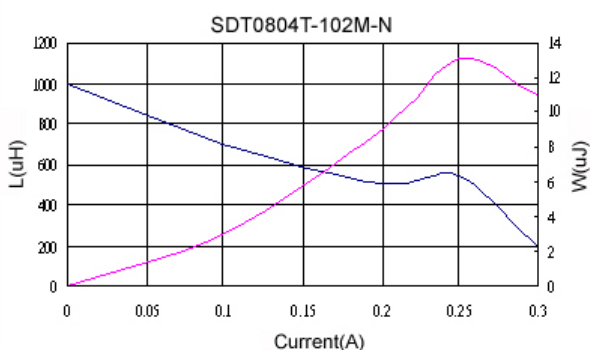
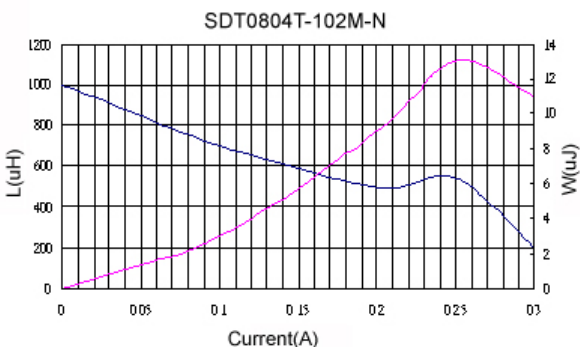
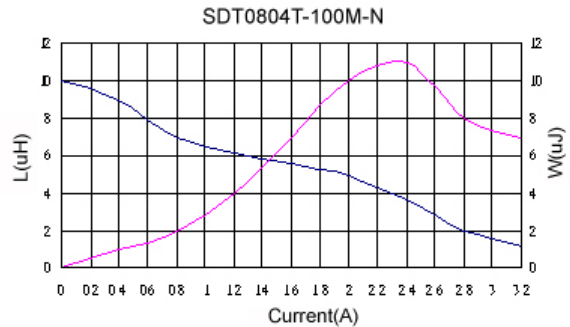
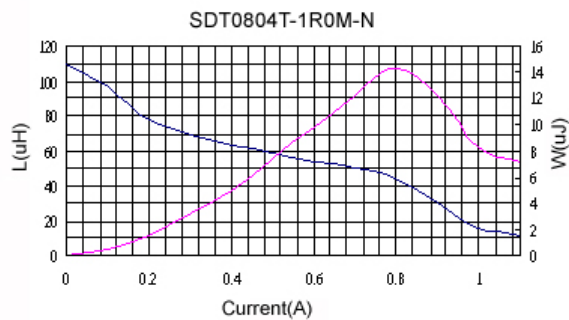
L : E4980 or HP4284A, 100kHz 0.1V

RDC : Chroma 16502

SRF : HP4291A or HP4192A

Rated Current : HP4284A+HP42841A or WK3260B+WK3265B

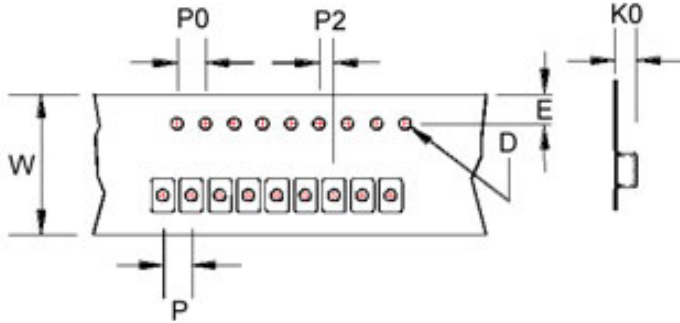
Typical Inductance Energy Storage VS. Current



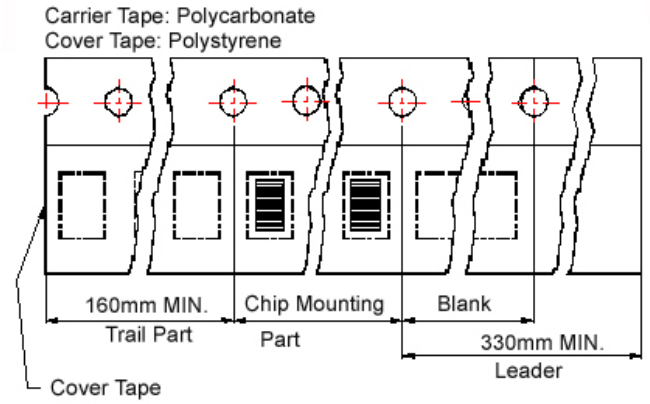
Please be sure to request approval specifications that provide further details of the products. Kindly note that the content of these specifications are subject to change or may be discontinued without advance notice. Please contact our sales department before ordering.

Packaging Specifications

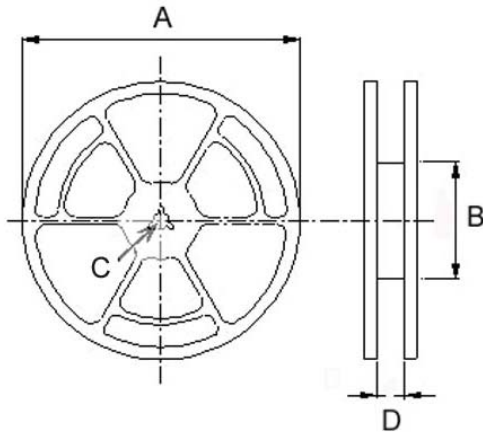
Tape Dimensions



Tape Material



Reel Dimensions



Dimensions in mm

| TYPE | Tape Dimensions | | | | | | | Reel Dimensions | | | | Quantity (PCS / REEL) | |
|----------|-----------------|------|------|----|----|----|----|-----------------|-----|----|------|-----------------------|-------|
| | K0 | D | E | W | P | P0 | P2 | A | B | C | D | 178mm | 330mm |
| SDT 0402 | 3.2 | 1.55 | 1.75 | 12 | 8 | 4 | 2 | 330 | 100 | 13 | 13.4 | - | 2500 |
| | | | | | | | | 178 | 60 | | 13.2 | 750 | - |
| SDT 0804 | 5.4 | 1.55 | 1.75 | 24 | 16 | 4 | 2 | 330 | 100 | 13 | 24.4 | - | 750 |

SCD Series



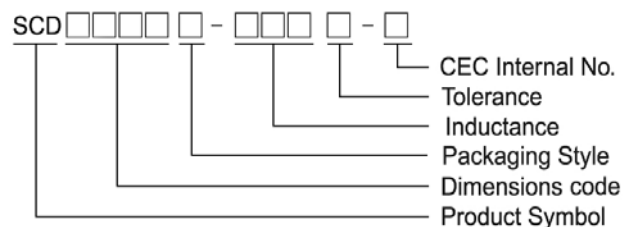
Features

- RoHS, Halogen Free and REACH Compliance
- Unshielded power inductor
- Various package size and wide inductance range

Applications

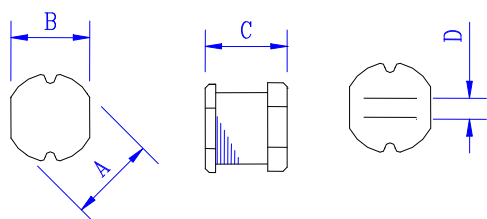
- Graphic cards
- DC/DC converters

Product Identification



- Packaging: T : Tape and Reel

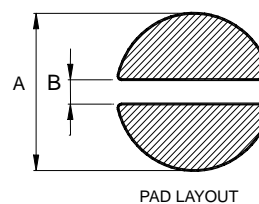
Shape and Dimensions



Dimensions in mm

| TYPE | A | B | C | D |
|-----------|------------|-----------|-----------|----------|
| SCD 03015 | 3.3 ± 0.3 | 3.0 ± 0.3 | 1.5 ± 0.3 | 1.0 Typ. |
| SCD 03021 | 3.3 ± 0.3 | 3.0 ± 0.3 | 2.1 ± 0.3 | 1.0 Typ. |
| SCD 0403 | 4.5 ± 0.3 | 4.0 ± 0.3 | 3.2 ± 0.3 | 1.2 |
| SCD 0502 | 5.8 ± 0.3 | 5.2 ± 0.3 | 2.5 ± 0.3 | 2.0 Typ. |
| SCD 0503 | 5.8 ± 0.3 | 5.2 ± 0.3 | 3 ± 0.3 | 2.0 Typ. |
| SCD 0504 | 5.8 ± 0.3 | 5.2 ± 0.3 | 4.5 ± 0.4 | 1.3 |
| SCD 0703 | 7.8 ± 0.3 | 7.0 ± 0.3 | 3.5 ± 0.3 | 2.1 |
| SCD 0705 | 7.8 ± 0.3 | 7.0 ± 0.3 | 5.0 ± 0.3 | 2.1 |
| SCD 1004 | 10.0 ± 0.3 | 9.0 ± 0.3 | 4.0 ± 0.5 | 2.1 |
| SCD 1005 | 10.0 ± 0.4 | 9.0 ± 0.4 | 5.4 ± 0.4 | 2.1 |
| SCD 1006 | 10.0 ± 0.4 | 9.0 ± 0.4 | 6.5 ± 0.4 | 2.1 |

Recommended Pattern



Dimensions in mm

| Dim | A | B |
|----------|-----|-----|
| SCD 3015 | 4.5 | 1.0 |
| SCD 3021 | 4.5 | 1.0 |
| SCD 0403 | 5.5 | 1.2 |
| SCD 0502 | 6.8 | 2.0 |
| SCD 0503 | 6.8 | 2.0 |
| SCD 0504 | 6.8 | 1.3 |
| SCD 0703 | 8.8 | 2.1 |
| SCD 0705 | 8.8 | 2.1 |
| SCD 1004 | 11 | 2.1 |
| SCD 1005 | 11 | 2.1 |
| SCD 1006 | 11 | 2.1 |

Standard Specifications

| Stamp | Inductance (μH) | RDC (Ω) Max | | | | | | | | | | |
|-------|-----------------|-------------|-----------|----------|----------|----------|----------|----------|----------|----------|----------|----------|
| | | SCD 03015 | SCD 03021 | SCD 0403 | SCD 0502 | SCD 0503 | SCD 0504 | SCD 0703 | SCD 0705 | SCD 1004 | SCD 1005 | SCD 1006 |
| R15 | 0.15 | | | 0.0085 | | | | | | | | |
| R82 | 0.82 | | 0.06 | | | | | | | | | |
| 1R0 | 1.0 | | 0.07 | 0.033 | 0.03 | 0.03 | | | | | | |
| 1R2 | 1.2 | | | 0.035 | | 0.03 | | | | | | |
| 1R4 | 1.4 | | 0.09 | 0.038 | 0.04 | | | | 0.02 | | | |
| 1R5 | 1.5 | | 0.11 | | | 0.03 | | | 0.02 | | | |
| 1R8 | 1.8 | | 0.11 | 0.042 | 0.05 | 0.03 | 0.020 | | 0.02 | | | |
| 2R2 | 2.2 | 0.10±30% | 0.13 | 0.047 | 0.06 | 0.03 | 0.023 | 0.03 | 0.02 | | | |
| 2R7 | 2.7 | | 0.14 | 0.052 | 0.07 | 0.04 | | | 0.02 | | | |
| 3R0 | 3.0 | | | | | | | | 0.025 | | | |
| 3R3 | 3.3 | 0.11±30% | 0.17 | 0.058 | 0.08 | 0.05 | 0.0314 | | 0.03 | 0.022 | 0.038 | |
| 3R5 | 3.5 | | | | | | 0.030 | | | | | |
| 3R8 | 3.8 | | | | | | | | | 0.022 | | |
| 3R9 | 3.9 | | 0.19 | 0.076 | 0.09 | 0.06 | | | 0.03 | | | |
| 4R7 | 4.7 | 0.15±30% | 0.21 | 0.094 | 0.14 | 0.07 | 0.0372 | 0.04 | 0.04 | | 0.040 | |
| 5R6 | 5.6 | 0.15±30% | 0.22 | 0.101 | 0.15 | 0.08 | | | 0.04 | | 0.037 | |
| 6R2 | 6.2 | | | 0.110 | | | | | | | | |
| 6R8 | 6.8 | 0.20±30% | 0.25 | 0.117 | 0.16 | 0.09 | 0.057 | | 0.04 | 0.04 | 0.037 | |
| 7R0 | 7.0 | | 0.28 | | | | | | | | | |
| 8R2 | 8.2 | | 0.28 | 0.132 | 0.17 | 0.10 | | | 0.05 | | 0.050 | |
| 100 | 10 | 0.30±30% | 0.32 | 0.182 | 0.18 | 0.12 | 0.10 | 0.08 | 0.07 | 0.05 | 0.060 | |
| 120 | 12 | | 0.35 | 0.210 | 0.20 | 0.13 | 0.12 | 0.09 | 0.08 | 0.06 | 0.070 | |
| 150 | 15 | 0.58±30% | 0.40 | 0.235 | 0.22 | 0.15 | 0.14 | 0.10 | 0.09 | 0.07 | 0.080 | |
| 180 | 18 | | 0.48 | 0.338 | 0.25 | 0.22 | 0.15 | 0.11 | 0.10 | 0.08 | 0.090 | |
| 220 | 22 | 0.71±30% | 0.58 | 0.378 | 0.35 | 0.22 | 0.18 | 0.13 | 0.11 | 0.09 | 0.100 | 0.08 |
| 270 | 27 | | 0.65 | 0.522 | 0.45 | 0.26 | 0.20 | 0.15 | 0.12 | 0.10 | 0.110 | |
| 330 | 33 | 1.10±30% | 0.80 | 0.540 | 0.56 | 0.33 | 0.23 | 0.17 | 0.13 | 0.12 | 0.120 | |
| 390 | 39 | 1.30±30% | 0.90 | 0.587 | 0.69 | 0.42 | 0.32 | 0.22 | 0.16 | 0.15 | 0.140 | |
| 470 | 47 | 1.30±30% | 1.19 | 0.844 | 0.72 | 0.50 | 0.37 | 0.25 | 0.18 | 0.17 | 0.170 | |
| 500 | 50 | | 1.22 | | | | | | | | | |
| 560 | 56 | | 1.27 | 0.937 | 0.84 | 0.55 | 0.42 | 0.28 | 0.24 | 0.20 | 0.190 | |
| 680 | 68 | 2.20±30% | 1.73 | 1.117 | 0.90 | 0.65 | 0.46 | 0.33 | 0.28 | 0.22 | 0.220 | |
| 750 | 75 | | 1.90 | | | | | | | | | |
| 820 | 82 | | 1.99 | | 1.20 | 0.80 | 0.60 | 0.41 | 0.37 | 0.30 | 0.25 | |
| 101 | 100 | 3.50±30% | 2.52 | 2.000 | 1.30 | 0.90 | 0.70 | 0.48 | 0.43 | 0.34 | 0.35 | |
| 121 | 120 | | 2.90 | 1.800 | 1.38 | 1.00 | 0.93 | 0.54 | 0.47 | 0.40 | 0.40 | |
| 151 | 150 | | 3.36 | 2.800 | 1.81 | 1.30 | 1.10 | 0.75 | 0.64 | 0.54 | 0.47 | |
| 181 | 180 | | 5.10 | 3.200 | 1.95 | 1.50 | 1.38 | 1.02 | 0.71 | 0.62 | 0.63 | |
| 221 | 220 | 10.92 | 5.80 | 4.000 | 3.00 | 2.00 | 1.57 | 1.20 | 0.96 | 0.72 | 0.73 | |
| 271 | 270 | | 7.80 | | 3.20 | 2.50 | 1.85 | 1.31 | 1.11 | 0.95 | 0.97 | |
| 331 | 330 | | | 5.850 | 3.82 | 3.20 | 2.00 | 1.50 | 1.26 | 1.10 | 1.15 | |
| 391 | 390 | | | | 4.68 | 3.50 | 2.60 | | 1.77 | 1.24 | 1.30 | |
| 471 | 470 | | | | 5.10 | 4.20 | 3.00 | | 1.96 | 1.53 | 1.48 | 1.421 |
| 561 | 560 | | | | 8.50 | 4.50 | 4.19 | 2.50 | 2.41 | 1.90 | 1.90 | |
| 681 | 680 | | | | 10.0 | 6.50 | 4.44 | | 2.50 | | 2.25 | |
| 821 | 820 | | | | 12.0 | 7.50 | 5.12 | | | | 2.55 | |
| 102 | 1000 | | | | 18.0 | 8.00 | 10.00 | | 2.80 | | 3.10 | 2.9 |
| 122 | 1200 | | | | | | | | | | | 3.5 |
| 152 | 1500 | | | | | | | | | | | 3.8 |
| 202 | 2000 | | | | | | | | | | | 6.6 |
| 222 | 2200 | | | | | | | | | | | 8.0 |
| 602 | 6000 | | | | | | | | | | | 14 |
| 822 | 8200 | | | | | | | | | | | 50 |

Note: When ordering, please specify tolerance code. Tolerance: K=±10% , M=±20%

- Operating temperature range - 40°C ~ 105°C(Including self – temperature rise)
- Isat for Inductance drop 10% from its value without current
- Measure Equipment :
 Test Freq L : SCD03015: (1MHz/1V), SCD1005/1006: 1.0 ~ 8.2μH(7.96MHz/1V), 10 ~ 82μH (2.52MHz/1V), 100 ~ 1000μH (1kHz/1V)
 SCD03021/0403/0502/ 0503: 0.15 ~ 8.2μH(7.96MHz/1V), 10 ~ 82μH (2.52MHz/1V), 100 ~ 1000μH (1kHz/1V).
 SCD0504/0703/0705/1004: 1.0 ~ 8.2μH(7.96MHz/1V), 10 ~ 82μH (2.52MHz/1V), 100 ~ 1000μH (1kHz/1V).
 L : Agilent/ E4980 or HP4284A (under 1MHz), HP4285A (over 1MHz)

RDC : Chroma 16502

Isat : HP4284+42841A or WK3260B+WK3265B

Please be sure to request approval specifications that provide further details of the products. Kindly note that the content of these specifications are subject to change or may be discontinued without advance notice. Please contact our sales department before ordering.



Standard Specifications

| Stamp | Inductance (μH) | Isat (A) Max | | | | | | | | | | |
|-------|-----------------|--------------|-----------|----------|----------|----------|----------|----------|----------|----------|----------|----------|
| | | SCD 03015 | SCD 03021 | SCD 0403 | SCD 0502 | SCD 0503 | SCD 0504 | SCD 0703 | SCD 0705 | SCD 1004 | SCD 1005 | SCD 1006 |
| R15 | 0.15 | | | 7.5 | | | | | | | | |
| R82 | 0.82 | | 2.200 | | | | | | | | | |
| 1R0 | 1.0 | | 2.080 | 3.80 | 4.50 | 4.50 | | | | | | |
| 1R2 | 1.2 | | | 3.50 | | 4.20 | | | | | | |
| 1R4 | 1.4 | | 1.860 | 3.30 | 4.00 | | | | 3.70 | | | |
| 1R5 | 1.5 | | 1.800 | | | 4.10 | | | 3.70 | | | |
| 1R8 | 1.8 | | 1.800 | 2.91 | 3.30 | 3.70 | 3.50 | | 3.70 | | | |
| 2R2 | 2.2 | 0.79 | 1.390 | 2.60 | 2.94 | 3.50 | 3.20 | 3.20 | 3.70 | | | |
| 2R7 | 2.7 | | 1.320 | 2.43 | 2.50 | 3.20 | | | 3.70 | | | |
| 3R0 | | | | | | | | | 3.70 | | | |
| 3R3 | 3.3 | 0.73 | 1.250 | 2.15 | 2.35 | 2.80 | 2.59 | | 3.70 | 4.50 | 2.80 | |
| 3R5 | 3.5 | | | | | | 2.40 | | | | | |
| 3R8 | 3.8 | | | | | | | | | 4.20 | | |
| 3R9 | 3.9 | | 1.200 | 1.98 | 2.20 | 2.60 | | | 3.70 | | | |
| 4R7 | 4.7 | 0.65 | 1.130 | 1.70 | 2.00 | 2.50 | 2.30 | 1.60 | 3.50 | | 2.60 | |
| 5R6 | 5.6 | 0.60 | 0.910 | 1.60 | 1.80 | 2.40 | | | 3.30 | | 4.50 | |
| 6R2 | 6.2 | | | 1.50 | | | | | | | | |
| 6R8 | 6.8 | 0.77 | 0.850 | 1.41 | 1.70 | 2.20 | 1.80 | | 3.10 | 3.00 | 4.33 | |
| 7R0 | 7.0 | | 0.820 | | | | | | | | | |
| 8R2 | 8.2 | | 0.820 | 1.26 | 1.40 | 2.00 | | | 2.70 | | 3.50 | |
| 100 | 10 | 0.45 | 0.740 | 1.15 | 1.20 | 1.80 | 1.44 | 1.44 | 2.30 | 2.38 | 2.60 | |
| 120 | 12 | | 0.640 | 1.05 | 1.18 | 1.75 | 1.40 | 1.39 | 2.00 | 2.13 | 2.45 | |
| 150 | 15 | 0.30 | 0.600 | 0.92 | 1.15 | 1.70 | 1.30 | 1.24 | 1.80 | 1.87 | 2.27 | |
| 180 | 18 | | 0.540 | 0.84 | 1.10 | 1.60 | 1.23 | 1.12 | 1.60 | 1.73 | 2.15 | |
| 220 | 22 | 0.25 | 0.500 | 0.76 | 1.00 | 1.50 | 1.11 | 1.07 | 1.50 | 1.60 | 1.95 | 3.80 |
| 270 | 27 | | 0.430 | 0.71 | 0.86 | 1.40 | 0.97 | 0.94 | 1.30 | 1.44 | 1.76 | |
| 330 | 33 | 0.20 | 0.400 | 0.64 | 0.76 | 1.10 | 0.88 | 0.85 | 1.20 | 1.26 | 1.50 | |
| 390 | 39 | 0.17 | 0.370 | 0.59 | 0.75 | 1.00 | 0.80 | 0.74 | 1.10 | 1.20 | 1.37 | |
| 470 | 47 | 0.17 | 0.360 | 0.54 | 0.73 | 0.90 | 0.72 | 0.68 | 1.10 | 1.10 | 1.28 | |
| 500 | 50 | | 0.330 | | | | | | | | | |
| 560 | 56 | | 0.310 | 0.50 | 0.55 | 0.85 | 0.68 | 0.64 | 0.94 | 1.01 | 1.17 | |
| 680 | 68 | 0.13 | 0.300 | 0.46 | 0.52 | 0.80 | 0.61 | 0.59 | 0.85 | 0.91 | 1.11 | |
| 750 | 75 | | 0.290 | | | | | | | | | |
| 820 | 82 | | 0.280 | | 0.50 | 0.65 | 0.58 | 0.54 | 0.78 | 0.85 | 1.00 | |
| 101 | 100 | 0.10 | 0.250 | 0.40 | 0.40 | 0.60 | 0.52 | 0.51 | 0.72 | 0.74 | 0.97 | |
| 121 | 120 | | 0.200 | 0.38 | 0.36 | 0.58 | 0.48 | 0.49 | 0.66 | 0.69 | 0.89 | |
| 151 | 150 | | 0.190 | 0.30 | 0.30 | 0.43 | 0.40 | 0.40 | 0.58 | 0.61 | 0.78 | |
| 181 | 180 | | 0.170 | 0.25 | 0.26 | 0.41 | 0.38 | 0.36 | 0.51 | 0.56 | 0.72 | |
| 221 | 220 | 0.07 | 0.160 | 0.15 | 0.25 | 0.38 | 0.35 | 0.31 | 0.49 | 0.53 | 0.66 | |
| 271 | 270 | | 0.140 | | 0.21 | 0.35 | 0.29 | 0.29 | 0.42 | 0.45 | 0.57 | |
| 331 | 330 | | | 0.21 | 0.18 | 0.28 | 0.28 | 0.28 | 0.40 | 0.42 | 0.52 | |
| 391 | 390 | | | | 0.16 | 0.26 | 0.26 | | 0.36 | 0.38 | 0.48 | |
| 471 | 470 | | | | 0.15 | 0.20 | 0.12 | | 0.34 | 0.35 | 0.42 | 0.82 |
| 561 | 560 | | | | 0.14 | 0.19 | 0.10 | 0.14 | 0.32 | 0.32 | 0.33 | |
| 681 | 680 | | | | 0.13 | 0.18 | 0.08 | | 0.29 | | 0.28 | |
| 821 | 820 | | | | 0.07 | 0.15 | 0.05 | | | | 0.24 | |
| 102 | 1000 | | | | 0.05 | 0.13 | 0.03 | | 0.19 | | 0.20 | 0.60 |
| 122 | 1200 | | | | | | | | | | | 0.50 |
| 152 | 1500 | | | | | | | | | | | 0.60 |
| 202 | 2000 | | | | | | | | | | | 0.40 |
| 222 | 2200 | | | | | | | | | | | 0.40 |
| 602 | 6000 | | | | | | | | | | | 0.27 |
| 822 | 8200 | | | | | | | | | | | 0.20 |

Tolerance Of Inductors

- SCD03015 2.2 ~ 100μH ± 20%
- SCD03021 1.0 ~ 270μH ± 20%
- SCD0403 0.15 ~ 27μH ± 20% 33 ~ 100μH ± 10%
- SCD0502 1.0 ~ 27μH ± 20% 33 ~ 1000μH ± 10%
- SCD0503 1.0 ~ 27μH ± 20% 33 ~ 1000μH ± 10%
- SCD0504 1.0~27μH±20% 33~47μH ±15% 56~1000μH±10%
- SCD0703 10 ~ 27μH ± 20% 33 ~ 330μH ± 10%
- SCD0705 1.4 ~ 27μH ± 20% 33 ~ 470μH ± 10%
- SCD1004 10 ~ 27μH ± 20% 33 ~ 560μH ± 10%
- SCD1005 4.7 ~ 27μH ± 20% 33 ~ 820μH ± 10%
- SCD1006 6000μH ~8200μH±20%

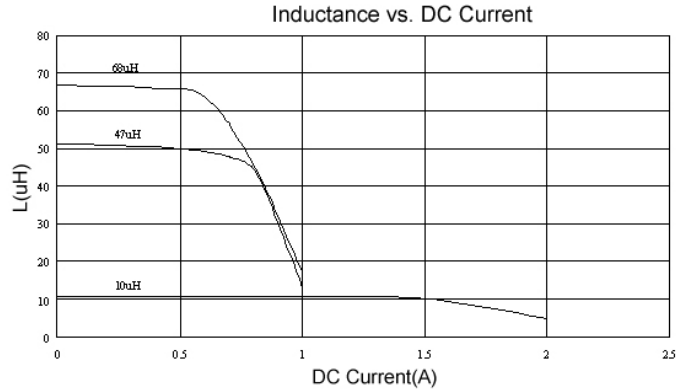
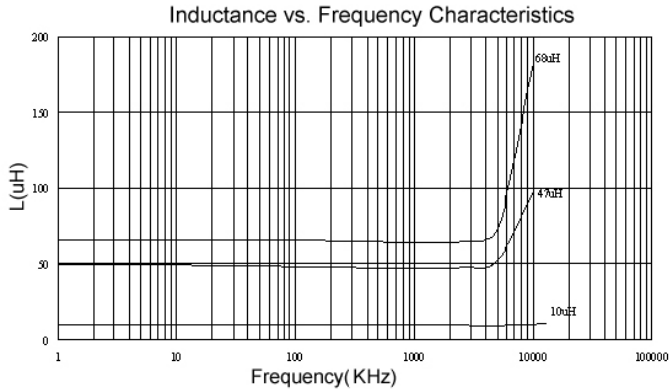
Tolerance: K = ±10% , M = ±20%

Please be sure to request approval specifications that provide further details of the products. Kindly note that the content of these specifications are subject to change or may be discontinued without advance notice. Please contact our sales department before ordering.

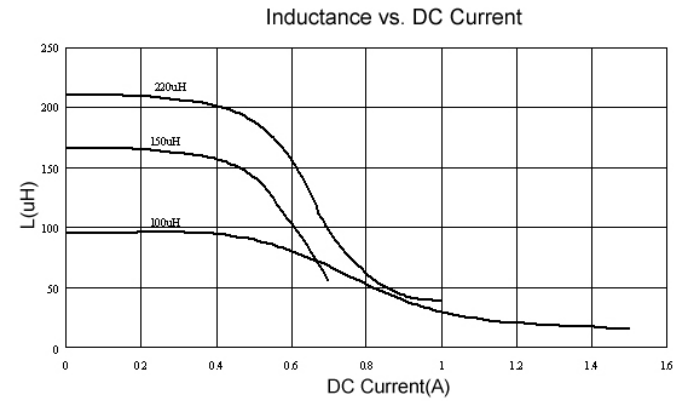
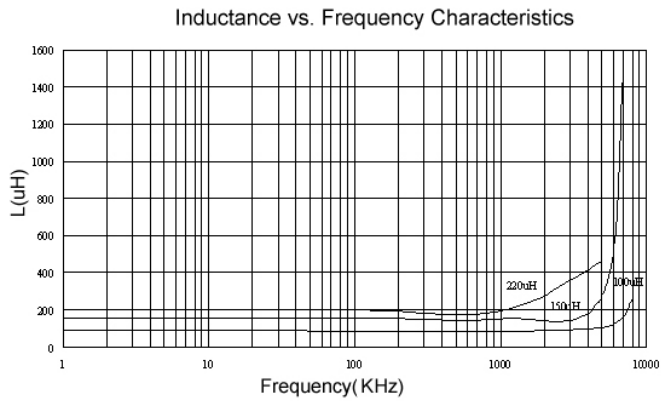


Test Instruments : HP4294A Impedance / Material Analyzer

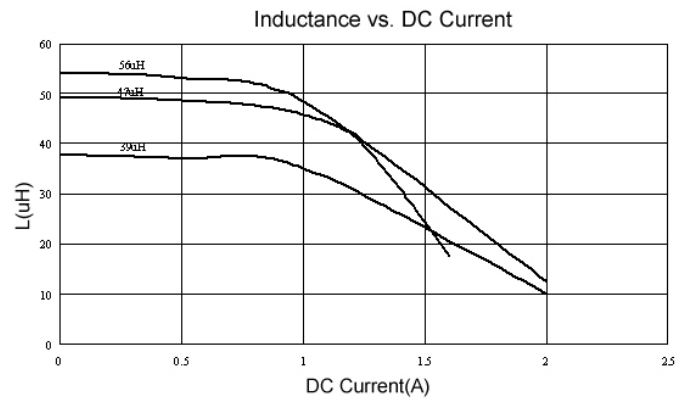
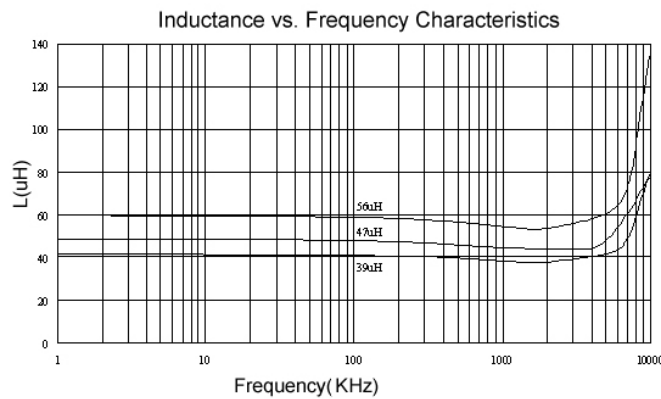
SCD0403



SCD0504



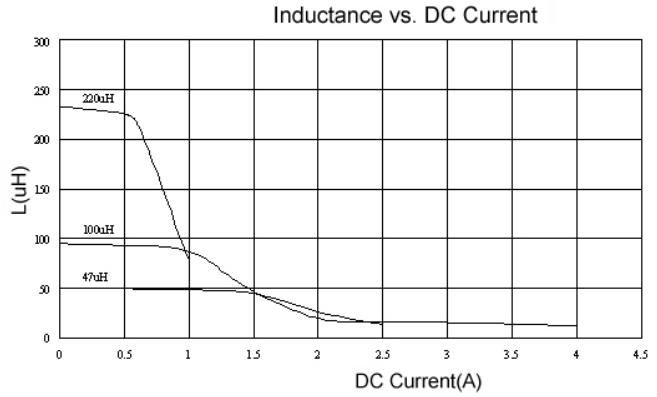
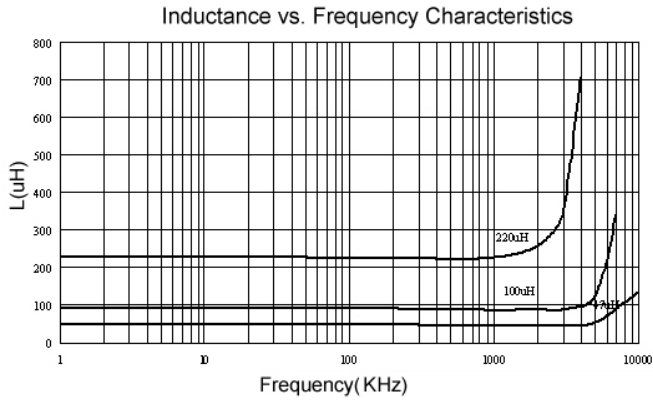
SCD0703



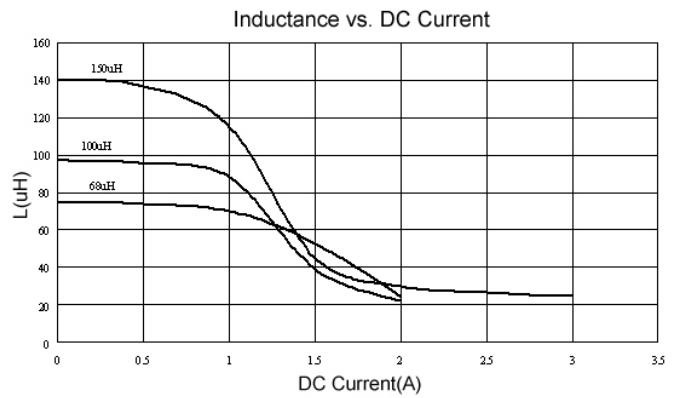
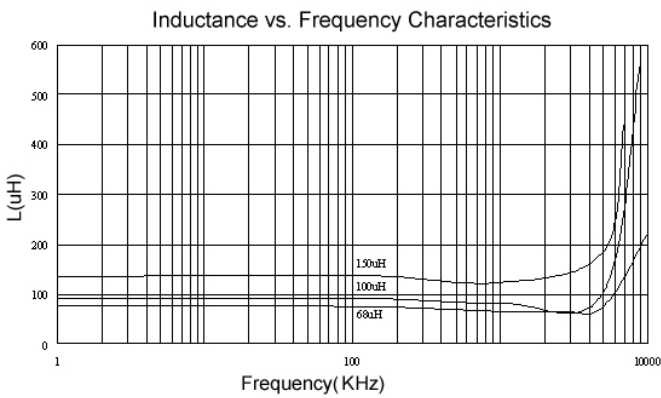
Please be sure to request approval specifications that provide further details of the products. Kindly note that the content of these specifications are subject to change or may be discontinued without advance notice. Please contact our sales department before ordering.

Test Instruments : HP4294A Impedance / Material Analyzer

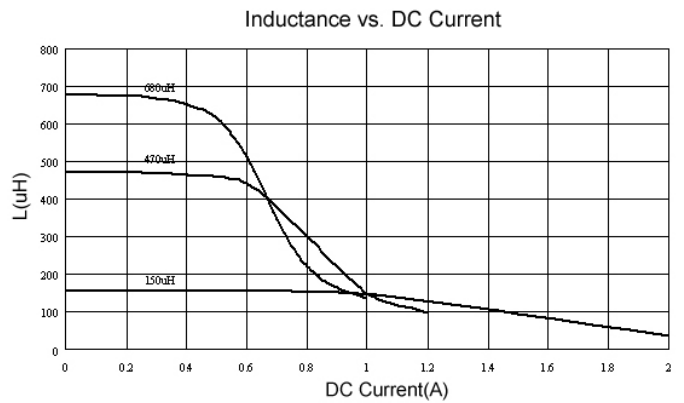
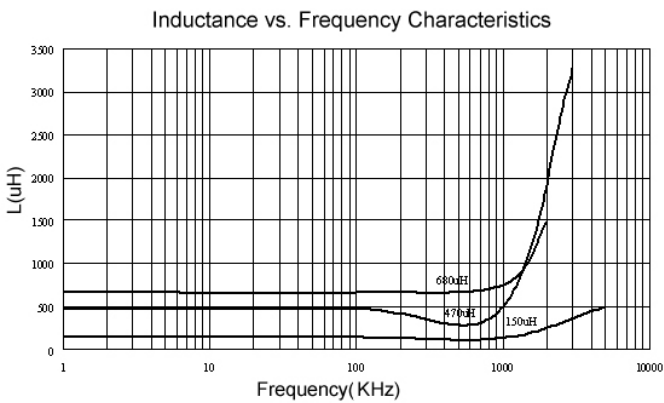
SCD0705



SCD1004



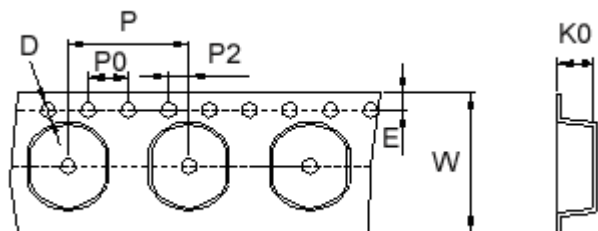
SCD1005



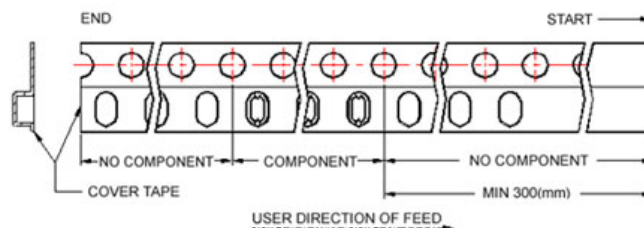
Please be sure to request approval specifications that provide further details of the products. Kindly note that the content of these specifications are subject to change or may be discontinued without advance notice. Please contact our sales department before ordering.

Packaging Specifications

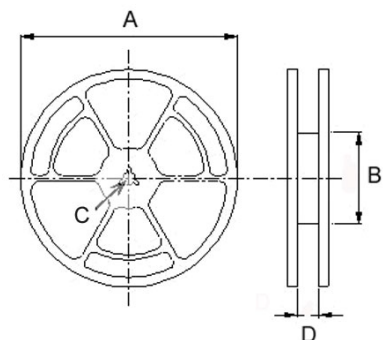
Tape Dimensions



Tape Material



Reel Dimensions



Dimensions in mm

| TYPE | Tape Dimensions | | | | | | | Reel Dimensions | | | | Quantity PCS / REEL |
|----------|-----------------|------|------|----|----|----|----|-----------------|-----|----|------|------------------------|
| | K0 | D | E | W | P | P0 | P2 | A | B | C | D | |
| SCD03015 | 1.80 | 1.55 | 1.75 | 12 | 8 | 4 | 2 | 330 | 100 | 13 | 13.4 | 3000 |
| SCD03021 | 2.50 | 1.55 | 1.75 | 12 | 8 | 4 | 2 | 330 | 100 | 13 | 13.4 | 3000 |
| SCD0403 | 3.55 | 1.55 | 1.75 | 12 | 8 | 4 | 2 | 330 | 100 | 13 | 13.4 | 2000 |
| SCD0502 | 3.30 | 1.50 | 1.75 | 16 | 8 | 4 | 2 | 330 | 100 | 13 | 16.0 | 2000 |
| SCD0503 | 3.30 | 1.50 | 1.75 | 16 | 8 | 4 | 2 | 330 | 100 | 13 | 16.0 | 2000 |
| SCD0504 | 4.8 | 1.55 | 1.75 | 16 | 8 | 4 | 2 | 330 | 100 | 13 | 16.0 | 1500 |
| SCD0703 | 3.8 | 1.55 | 1.75 | 16 | 12 | 4 | 2 | 330 | 100 | 13 | 16.0 | 1000 |
| SCD0705 | 5.2 | 1.55 | 1.75 | 16 | 12 | 4 | 2 | 330 | 100 | 13 | 16.0 | 700 |
| SCD1004 | 4.5 | 1.55 | 1.75 | 24 | 12 | 4 | 2 | 330 | 100 | 13 | 24.4 | 700 |
| SCD1005 | 5.8 | 1.55 | 1.75 | 24 | 12 | 4 | 2 | 330 | 100 | 13 | 24.4 | 700 |
| SCD1006 | 7.0 | 1.55 | 1.75 | 24 | 12 | 4 | 2 | 330 | 100 | 13 | 24.4 | 500 |

SSL Series

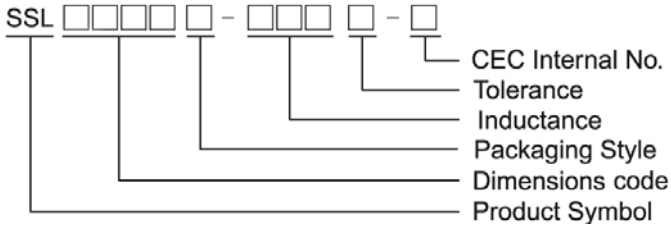
Features

- RoHS, Halogen Free and REACH Compliance
- Unshielded power inductor
- Various package size and wide inductance range. SSL-HC family is designed for low resistance and high current purpose

Applications

- DC/DC converters

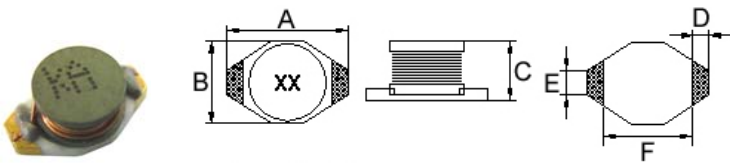
Product Identification



- Packaging: T : Tape and Reel , B : Bulk

Shape and Dimensions

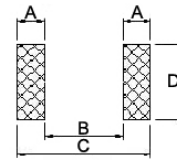
SSL0402



Dimensions in mm

| A | B | C | D | E | F |
|--------------------|--------------------|--------------------|------|------|------|
| 6.60 ⁺⁰ | 4.45 ⁺⁰ | 2.92 ⁺⁰ | 1.02 | 1.27 | 4.32 |

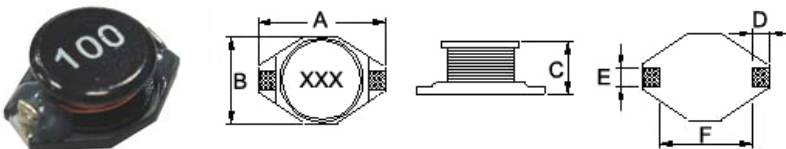
Recommended Pattern



Dimensions in mm

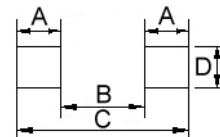
| TYPE | A | B | C | D |
|---------|------|------|------|------|
| SSL0402 | 1.40 | 4.06 | 6.86 | 3.56 |

SSL0804/ 0810



Dimensions in mm

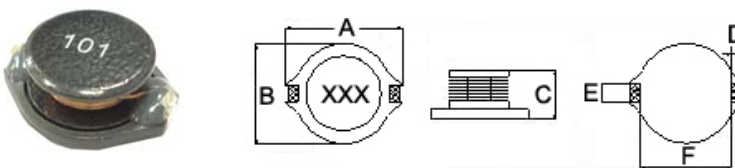
| TYPE | A | B | C | D | E | F |
|---------|---------------------|--------------------|---------------------|------|------|------|
| SSL0804 | 12.95 ⁺⁰ | 9.40 ⁺⁰ | 5.21 ⁺⁰ | 2.54 | 2.54 | 7.62 |
| SSL0810 | 12.95 ⁺⁰ | 9.40 ⁺⁰ | 11.43 ⁺⁰ | 2.54 | 2.54 | 7.62 |



Dimension in mm

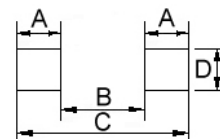
| TYPE | A | B | C | D |
|---------|------|------|-------|------|
| SSL0804 | 2.92 | 7.37 | 13.21 | 2.79 |
| SSL0810 | 2.92 | 7.37 | 13.21 | 2.79 |

SSL1306



Dimensions in mm

| A | B | C | D | E | F |
|---------------------|---------------------|--------------------|------|------|------|
| 18.54 ⁺⁰ | 15.24 ⁺⁰ | 7.11 ⁺⁰ | 2.54 | 2.54 | 12.7 |



Dimension in mm

| TYPE | A | B | C | D |
|---------|------|-------|-------|------|
| SSL1306 | 2.92 | 12.45 | 18.29 | 2.79 |

Electrical Characteristics

| Part Number | Inductance (μH) | Tolerance ($\pm\%$) | SRF (MHz) Typ. | RDC (Ω) Max | Isat (A) | Irms (A) |
|-----------------|---------------------------------|--------------------------|-------------------|-------------------------|-------------|-------------|
| SSL0402T-1R0M-N | 1.0 | 20 | 130 | 0.05 | 2.90 | 2.9 |
| SSL0402T-1R5M-N | 1.5 | 20 | 115 | 0.05 | 2.60 | 2.8 |
| SSL0402T-2R2M-N | 2.2 | 20 | 90 | 0.07 | 2.30 | 2.4 |
| SSL0402T-3R3M-N | 3.3 | 20 | 70 | 0.08 | 2.00 | 2.0 |
| SSL0402T-4R7M-N | 4.7 | 20 | 50 | 0.09 | 1.50 | 1.5 |
| SSL0402T-5R6M-N | 5.6 | 20 | 47 | 0.11 | 1.30 | 1.4 |
| SSL0402T-6R8M-N | 6.8 | 20 | 45 | 0.13 | 1.20 | 1.4 |
| SSL0402T-100M-N | 10 | 20 | 35 | 0.16 | 1.10 | 1.1 |
| SSL0402T-150M-N | 15 | 20 | 30 | 0.23 | 0.90 | 1.2 |
| SSL0402T-220M-N | 22 | 20 | 20 | 0.37 | 0.70 | 0.8 |
| SSL0402T-330M-N | 33 | 20 | 15 | 0.51 | 0.58 | 0.6 |
| SSL0402T-470M-N | 47 | 20 | 14 | 0.64 | 0.50 | 0.5 |
| SSL0402T-680M-N | 68 | 20 | 11 | 0.86 | 0.40 | 0.4 |
| SSL0402T-101M-N | 100 | 20 | 9 | 1.27 | 0.31 | 0.3 |
| SSL0402T-151M-N | 150 | 20 | 6 | 2.00 | 0.27 | 0.25 |
| SSL0402T-221M-N | 220 | 20 | 5.5 | 3.11 | 0.22 | 0.20 |
| SSL0402T-331M-N | 330 | 20 | 5 | 3.80 | 0.18 | 0.16 |
| SSL0402T-471M-N | 470 | 20 | 4 | 5.06 | 0.16 | 0.15 |
| SSL0402T-681M-N | 680 | 20 | 3 | 9.20 | 0.14 | 0.12 |
| SSL0402T-102M-N | 1000 | 20 | 2 | 13.8 | 0.10 | 0.07 |

Note: When ordering, please specify tolerance code. Tolerance: M= $\pm 20\%$

- Operating temperature range - 40°C ~ 125°C(Including self - temperature rise)
- Isat for Inductance drop 20% from its value without current
- I rms for a 30°C temperature rise from 25°C ambient with current
- Measure Equipment :

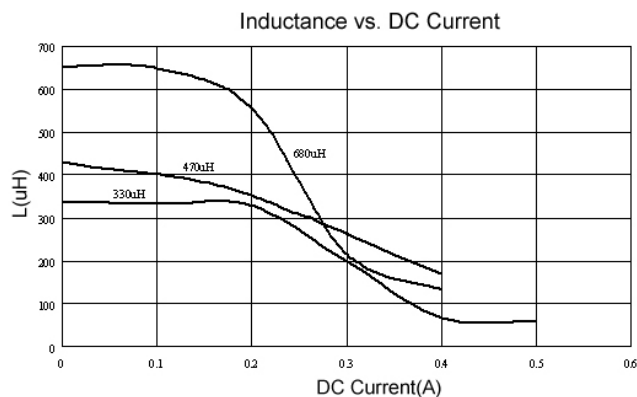
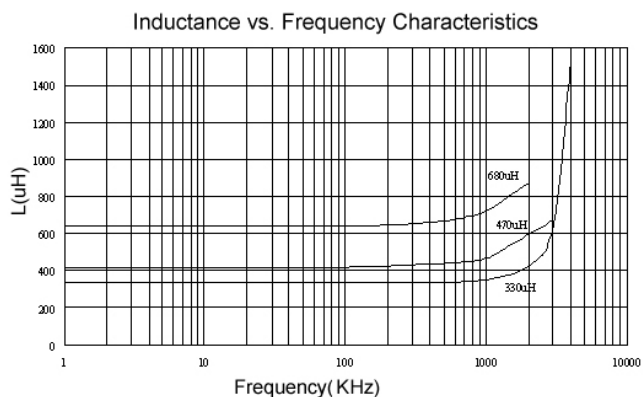
L : E4980 or HP4284A , 100kHz 0.1V

SRF : HP4291A or HP4192A

RDC : Chroma 16502

Isat : HP4284A+HP42841A or WK3260B+WK3265B

Test Instruments :



Please be sure to request approval specifications that provide further details of the products. Kindly note that the content of these specifications are subject to change or may be discontinued without advance notice. Please contact our sales department before ordering.

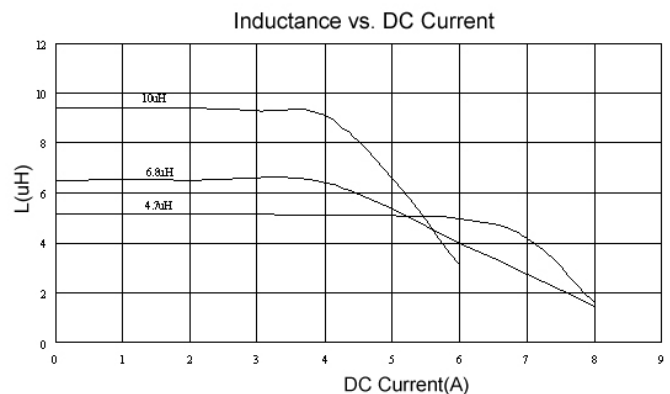
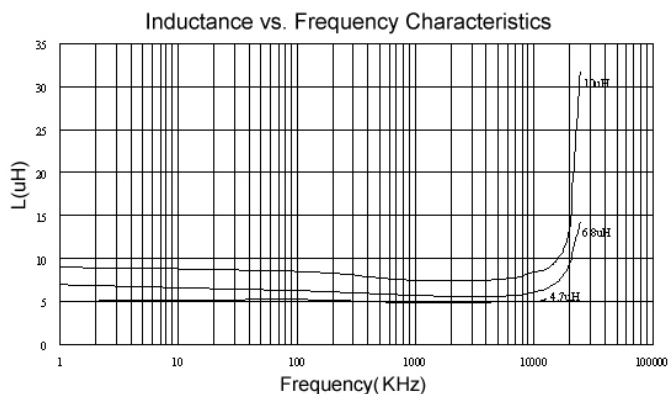
Electrical Characteristics

| Part Number | Inductance (μH) | Tolerance ($\pm\%$) | SRF (MHz) Typ. | RDC (Ω) Max | Isat (A) | Irms (A) |
|-----------------|---------------------------------|--------------------------|-------------------|-------------------------|-------------|-------------|
| SSL0804T-1R0M-N | 1.0 | 20 | 100 | 0.009 | 9.0 | 6.8 |
| SSL0804T-1R5M-N | 1.5 | 20 | 90 | 0.010 | 8.0 | 6.4 |
| SSL0804T-2R2M-N | 2.2 | 20 | 80 | 0.012 | 7.0 | 6.1 |
| SSL0804T-3R3M-N | 3.3 | 20 | 65 | 0.015 | 6.4 | 5.4 |
| SSL0804T-4R7M-N | 4.7 | 20 | 45 | 0.018 | 5.4 | 4.8 |
| SSL0804T-6R8M-N | 6.8 | 20 | 38 | 0.027 | 4.6 | 4.4 |
| SSL0804T-100M-N | 10 | 20 | 30 | 0.038 | 3.8 | 3.9 |
| SSL0804T-120M-N | 12 | 20 | 27 | 0.0432 | 3.5 | 3.6 |
| SSL0804T-150M-N | 15 | 20 | 27 | 0.046 | 3.0 | 3.1 |
| SSL0804T-220M-N | 22 | 20 | 19 | 0.085 | 2.6 | 2.7 |
| SSL0804T-330M-N | 33 | 20 | 15 | 0.100 | 2.0 | 2.1 |
| SSL0804T-470M-N | 47 | 20 | 12 | 0.140 | 1.6 | 1.8 |
| SSL0804T-680M-N | 68 | 20 | 10 | 0.200 | 1.4 | 1.5 |
| SSL0804T-101M-N | 100 | 20 | 9 | 0.260 | 1.2 | 1.3 |
| SSL0804T-151M-N | 150 | 20 | 6 | 0.400 | 1.0 | 1.0 |
| SSL0804T-221M-N | 220 | 20 | 5 | 0.610 | 0.8 | 0.8 |
| SSL0804T-331M-N | 330 | 20 | 4.5 | 1.020 | 0.6 | 0.6 |
| SSL0804T-471M-N | 470 | 20 | 3.5 | 1.270 | 0.5 | 0.5 |
| SSL0804T-681M-N | 680 | 20 | 2.5 | 2.020 | 0.4 | 0.4 |
| SSL0804T-102M-N | 1000 | 20 | 2.0 | 3.000 | 0.3 | 0.3 |
| SSL0804T-152M-N | 1500 | 20 | 1.4 | 4.500 | 0.25 | 0.2 |

Note: When ordering, please specify tolerance code. Tolerance: M=±20%

- Operating temperature range - 40°C ~ 125°C(Including self - temperature rise)
- Isat for Inductance drop 20% from its value without current
- I rms for a 15°C temperature rise from 25°C ambient with current
- Measure Equipment :
 L : E4980 or HP4284A , 100kHz 0.1V
 SRF:HP4291A or HP4192A
 RDC : Chroma 16502
 Isat : HP4284A+HP42841A or WK3260B+WK3265B

Test Instruments :



Please be sure to request approval specifications that provide further details of the products. Kindly note that the content of these specifications are subject to change or may be discontinued without advance notice. Please contact our sales department before ordering.

Electrical Characteristics

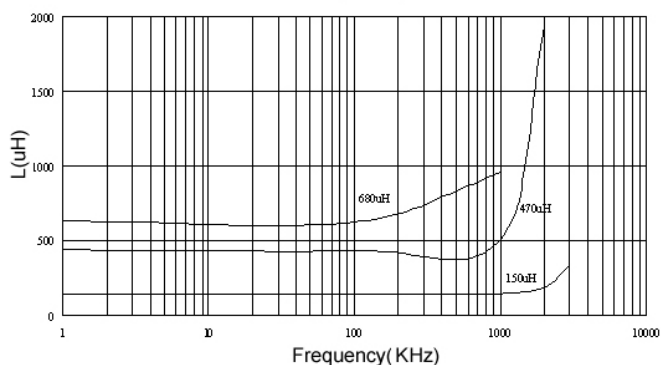
| Part Number | Inductance (μH) | Tolerance ($\pm\%$) | SRF (MHz) Typ. | RDC (Ω) Max | Isat (A) | Irms (A) |
|-----------------|---------------------------------|--------------------------|-------------------|-------------------------|-------------|-------------|
| SSL0810T-3R3M-N | 3.3 | 20 | 30 | 0.025 | 10 | 4.0 |
| SSL0810T-4R7M-N | 4.7 | 20 | 25 | 0.033 | 8.0 | 3.5 |
| SSL0810T-100M-N | 10 | 20 | 22 | 0.033 | 8.0 | 3.5 |
| SSL0810T-150M-N | 15 | 20 | 18 | 0.042 | 7.0 | 3.0 |
| SSL0810T-220M-N | 22 | 20 | 11 | 0.054 | 5.5 | 2.5 |
| SSL0810T-330M-N | 33 | 20 | 9 | 0.08 | 4.0 | 2.0 |
| SSL0810T-470M-N | 47 | 20 | 8 | 0.10 | 3.8 | 1.6 |
| SSL0810T-680M-N | 68 | 20 | 7 | 0.17 | 3.0 | 1.2 |
| SSL0810T-101M-N | 100 | 20 | 5 | 0.22 | 2.5 | 1.2 |
| SSL0810T-151M-N | 150 | 20 | 4 | 0.34 | 2.0 | 0.9 |
| SSL0810T-221M-N | 220 | 20 | 3.5 | 0.44 | 1.6 | 0.7 |
| SSL0810T-271M-N | 270 | 20 | 2.5 | 0.60 | 1.4 | 0.6 |
| SSL0810T-331M-N | 330 | 20 | 2.5 | 0.70 | 1.2 | 0.6 |
| SSL0810T-471M-N | 470 | 20 | 2 | 0.95 | 1.0 | 0.3 |
| SSL0810T-681M-N | 680 | 20 | 2 | 1.2 | 1.0 | 0.2 |
| SSL0810T-102M-N | 1000 | 20 | 1.5 | 2.0 | 0.8 | 0.1 |

Note: When ordering, please specify tolerance code. Tolerance: M= $\pm 20\%$

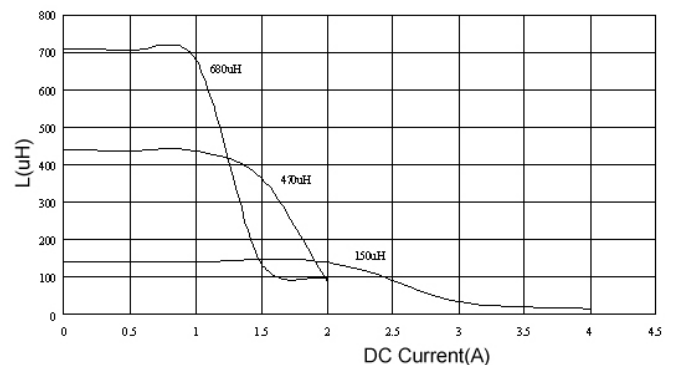
- Operating temperature range - 40°C ~ 125°C(Including self - temperature rise)
- Isat for Inductance drop 20% from its value without current
- Irms for a 40°C temperature rise from 25°C ambient with current
- Measure Equipment :
 L : E4980 or HP4284A , 100kHz 0.1V
 SRF:HP4291A or HP4192A
 RDC : Chroma 16502
 Isat : HP4284A+HP42841A or WK3260B+WK3265B

Test Instruments :

Inductance vs. Frequency Characteristics



Inductance vs. DC Current



Please be sure to request approval specifications that provide further details of the products. Kindly note that the content of these specifications are subject to change or may be discontinued without advance notice. Please contact our sales department before ordering.

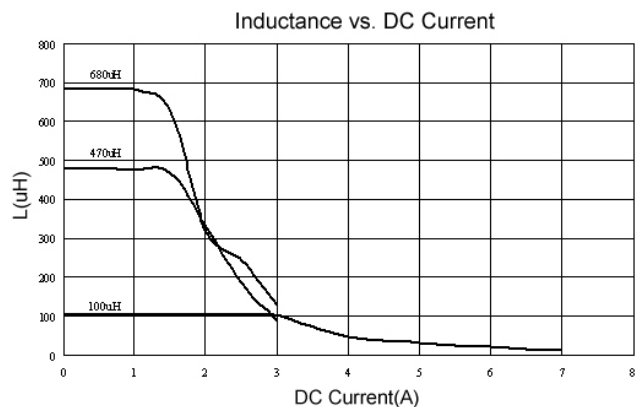
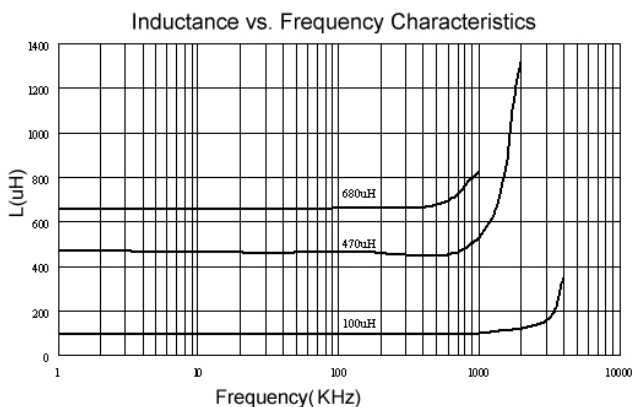
Electrical Characteristics

| Part Number | Inductance (μH) | Tolerance ($\pm\%$) | SRF (MHz) Typ. | RDC ($\Omega+15\%$) | Isat (A) | Irms (A) |
|-----------------|---------------------------------|--------------------------|-------------------|--------------------------|-------------|-------------|
| SSL1306T-1R0M-N | 1.0 | 20 | 80 | 0.011 | 20 | 8.6 |
| SSL1306T-2R2M-N | 2.2 | 20 | 80 | 0.014 | 16 | 7.1 |
| SSL1306T-3R3M-N | 3.3 | 20 | 60 | 0.016 | 14 | 6.2 |
| SSL1306T-4R7M-N | 4.7 | 20 | 45 | 0.022 | 13 | 5.5 |
| SSL1306T-5R6M-N | 5.6 | 20 | 40 | 0.022 | 12 | 5.3 |
| SSL1306T-6R8M-N | 6.8 | 20 | 30 | 0.022 | 10 | 5.0 |
| SSL1306T-100M-N | 10 | 20 | 30 | 0.032 | 10 | 4.3 |
| SSL1306T-150M-N | 15 | 20 | 22 | 0.036 | 8.0 | 4.0 |
| SSL1306T-180M-N | 18 | 20 | 20 | 0.039 | 7.5 | 3.7 |
| SSL1306T-220M-N | 22 | 20 | 20 | 0.047 | 7.0 | 3.5 |
| SSL1306T-330M-N | 33 | 20 | 15 | 0.066 | 5.5 | 3.0 |
| SSL1306T-470M-N | 47 | 20 | 9 | 0.087 | 4.5 | 2.6 |
| SSL1306T-680M-N | 68 | 20 | 8 | 0.13 | 3.5 | 2.3 |
| SSL1306T-101M-N | 100 | 20 | 7 | 0.19 | 3.0 | 1.8 |
| SSL1306T-151M-N | 150 | 20 | 6 | 0.25 | 2.6 | 1.5 |
| SSL1306T-221M-N | 220 | 20 | 5 | 0.38 | 2.4 | 1.2 |
| SSL1306T-331M-N | 330 | 20 | 4 | 0.56 | 1.9 | 1.0 |
| SSL1306T-471M-N | 470 | 20 | 3 | 0.85 | 1.4 | 0.82 |
| SSL1306T-681M-N | 680 | 20 | 2.5 | 1.2 | 1.2 | 0.72 |
| SSL1306T-102M-N | 1000 | 20 | 2 | 1.8 | 1.0 | 0.56 |

Note: When ordering, please specify tolerance code. Tolerance: M= $\pm 20\%$

- Operating temperature range - 40°C ~ 125°C(Including self - temperature rise)
- Isat for Inductance drop 20% from its value without current
- Irms for a 40°C temperature rise from 25°C ambient with current
- Measure Equipment :
 L : E4980 or HP4284A , 100kHz 0.1V
 SRF:HP4291A or HP4192A
 RDC : Chroma 16502
 Isat : HP4284A+HP42841A or WK3260B+WK3265B

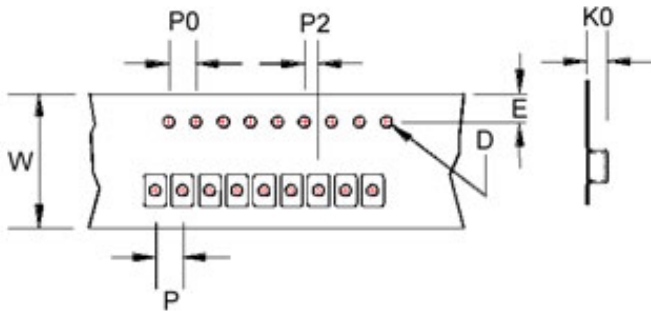
Test Instruments :



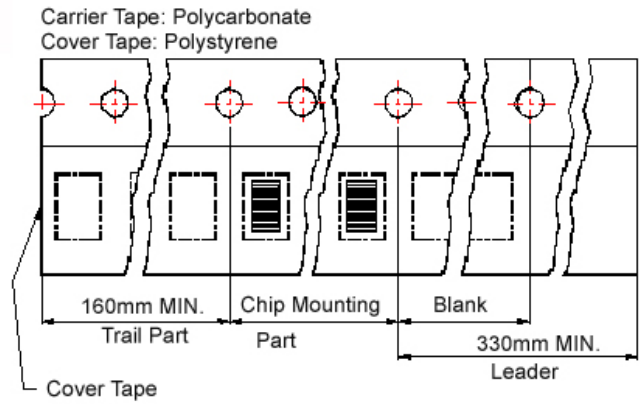
Please be sure to request approval specifications that provide further details of the products. Kindly note that the content of these specifications are subject to change or may be discontinued without advance notice. Please contact our sales department before ordering.

Packaging Specifications

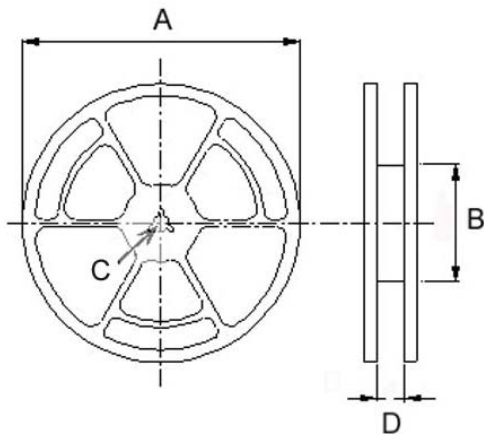
Tape Dimensions



Tape Material



Reel Dimensions



Dimensions in mm

| TYPE | Tape Dimensions | | | | | | | Reel Dimensions | | | | Quantity (PCS / REEL) | |
|----------|-----------------|------|------|----|----|----|----|-----------------|-----|----|------|-----------------------|-------|
| | K0 | D | E | W | P | P0 | P2 | A | B | C | D | 178mm | 330mm |
| SSL0402 | 3.2 | 1.55 | 1.75 | 12 | 8 | 4 | 2 | 330 | 100 | 13 | 13.4 | - | 2500 |
| | | | | | | | | 178 | 60 | | 13.2 | 750 | - |
| SSL 0804 | 5.4 | 1.55 | 1.75 | 24 | 16 | 4 | 2 | 330 | 100 | 13 | 24.4 | - | 750 |
| SSL 0810 | 11.5 | 1.55 | 1.75 | 24 | 20 | 4 | 2 | 330 | 100 | 13 | 24.4 | - | 225 |
| SSL 1306 | 7.5 | 1.55 | 1.75 | 32 | 20 | 4 | 2 | 330 | 100 | 13 | 33.4 | - | 350 |

SSL-HC Series



This series is specially designed for high current, low voltage DC-DC converter applications. Its simple, rugged design provides current ratings normally available in larger packages. With tinned self-leaded construction, SSL-HC series can achieve very low DCR values and excellent solderability. In addition, they have very low resistance. Standard parts shown in catalogue and custom values are also available.

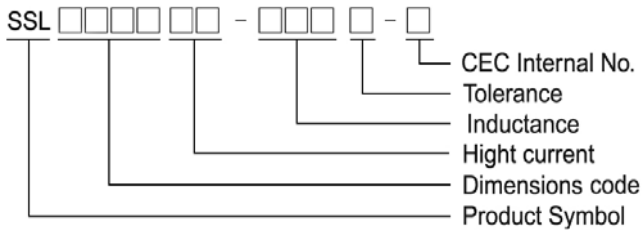
Features

- RoHS, Halogen Free and REACH Compliance
- Unshielded power inductor
- Various package size and wide inductance range. SSL-HC family is designed for low resistance and high current purpose

Applications

- DC/DC converters

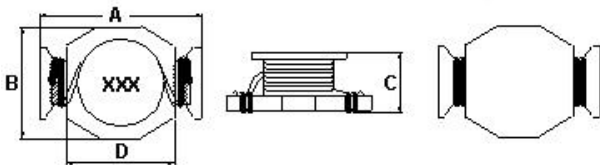
Product Identification



- Packaging: T : Tape and Reel , B : Bulk

Shape and Dimension

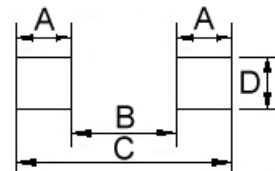
SSL0503HC



Dimension in mm

| A | B | C | D |
|--------------------|--------------------|--------------------|------|
| 8.89 ⁺⁰ | 6.10 ⁺⁰ | 5.00 ⁺⁰ | 5.84 |

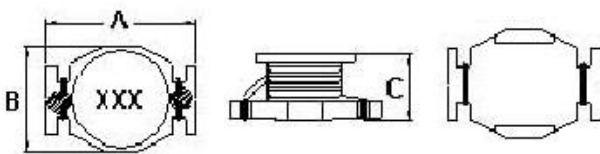
Recommended Pattern



Dimension in mm

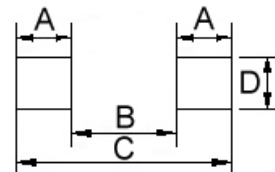
| A | B | C | D |
|------|------|------|------|
| 1.91 | 4.06 | 8.89 | 5.08 |

SSL0804HC



Dimension in mm

| A | B | C |
|---------------------|--------------------|--------------------|
| 13.21 ⁺⁰ | 9.91 ⁺⁰ | 6.35 ⁺⁰ |



Dimension in mm

| A | B | C | D |
|------|------|-------|------|
| 1.52 | 8.64 | 11.68 | 4.06 |

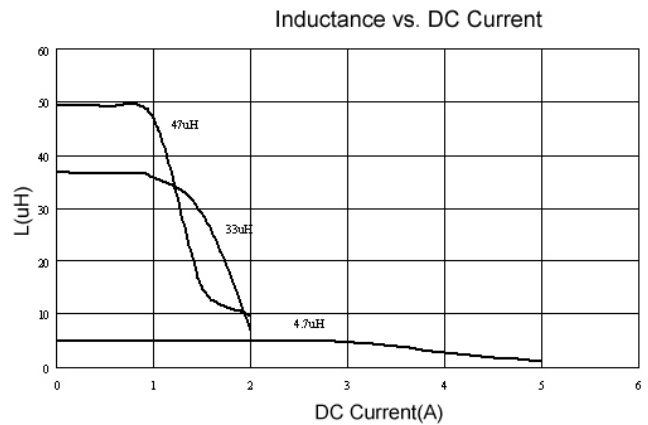
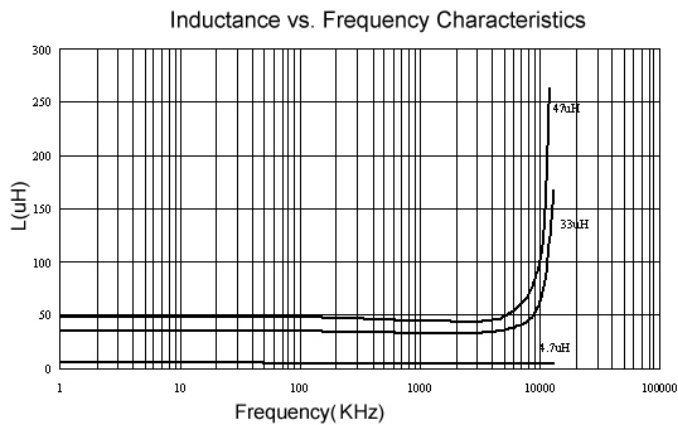
Electrical Characteristics

| Part Number | Inductance (μH) | Tolerance (±%) | SRF (MHz) Typ. | RDC (Ω) Max | Isat (A) | Irms (A) |
|------------------|-----------------|----------------|----------------|-------------|----------|----------|
| SSL0503HC-R33M-N | 0.33 | 20 | 330 | 0.007 | 8.2 | 7.0 |
| SSL0503HC-R56M-N | 0.56 | 20 | 200 | 0.010 | 7.7 | 6.0 |
| SSL0503HC-1R0M-N | 1.0 | 20 | 140 | 0.017 | 5.3 | 4.4 |
| SSL0503HC-1R2M-N | 1.2 | 20 | 140 | 0.017 | 5.3 | 4.4 |
| SSL0503HC-1R6M-N | 1.6 | 20 | 100 | 0.022 | 4.5 | 4.0 |
| SSL0503HC-2R2M-N | 2.2 | 20 | 100 | 0.035 | 3.5 | 3.1 |
| SSL0503HC-4R7M-N | 4.7 | 20 | 50 | 0.054 | 2.6 | 2.2 |
| SSL0503HC-6R8M-N | 6.8 | 20 | 45 | 0.070 | 2.0 | 1.8 |
| SSL0503HC-100M-N | 10 | 20 | 40 | 0.111 | 1.9 | 1.5 |
| SSL0503HC-150M-N | 15 | 20 | 30 | 0.17 | 1.5 | 1.2 |
| SSL0503HC-220M-N | 22 | 20 | 25 | 0.25 | 1.2 | 1.0 |
| SSL0503HC-270M-N | 27 | 20 | 20 | 0.32 | 1.0 | 0.85 |
| SSL0503HC-330M-N | 33 | 20 | 20 | 0.37 | 0.99 | 0.82 |
| SSL0503HC-470M-N | 47 | 20 | 15 | 0.47 | 0.87 | 0.72 |

Note: When ordering, please specify tolerance code. Tolerance: M=±20%

- Operating temperature range - 40°C ~ 125°C(Including self - temperature rise)
- Isat for Inductance drop 30% from its value without current
- I rms for a 40°C temperature rise from 25°C ambient with current
- Measure Equipment :
 L : E4980 or HP4284A , 100kHz 0.25V
 SRF : HP4291A or HP4192A
 RDC : Chroma 16502
 Isat : HP4284A+HP42841A or WK3260B+WK3265B

Test Instruments :



Please be sure to request approval specifications that provide further details of the products. Kindly note that the content of these specifications are subject to change or may be discontinued without advance notice. Please contact our sales department before ordering.

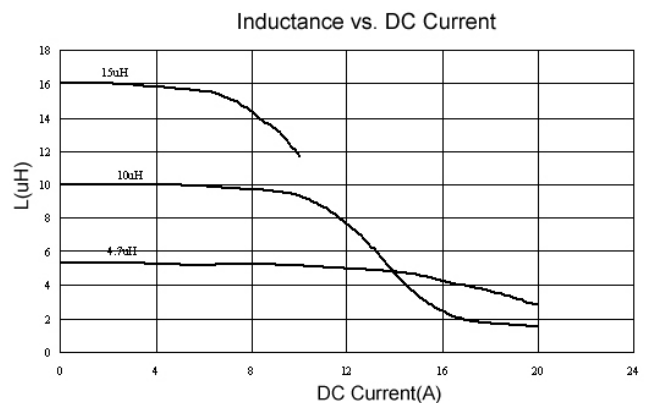
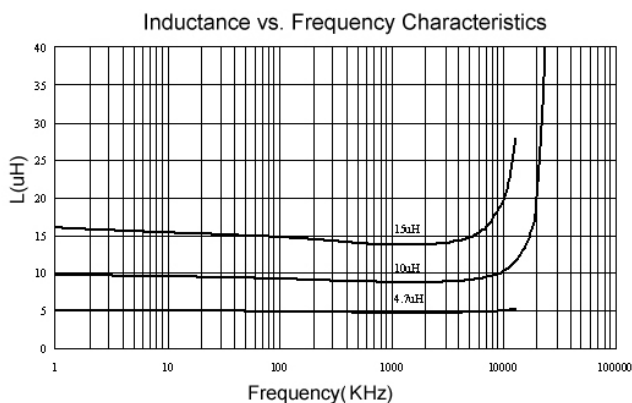
Electrical Characteristics

| Part Number | Inductance (μH) | Tolerance ($\pm\%$) | SRF (MHz) Typ. | RDC (Ω) Max | Isat (A) | Irms (A) |
|------------------|---------------------------------|--------------------------|-------------------|-------------------------|-------------|-------------|
| SSL0804HC-R33M-N | 0.33 | 20 | 300 | 0.002 | 20.0 | 16.0 |
| SSL0804HC-R68M-N | 0.68 | 20 | 200 | 0.005 | 13.0 | 12.0 |
| SSL0804HC-1R0M-N | 1.0 | 20 | 100 | 0.006 | 11.0 | 10.0 |
| SSL0804HC-1R5M-N | 1.5 | 20 | 90 | 0.008 | 9.0 | 9.0 |
| SSL0804HC-2R2M-N | 2.2 | 20 | 90 | 0.011 | 7.8 | 7.4 |
| SSL0804HC-2R7M-N | 2.7 | 20 | 65 | 0.012 | 7.0 | 6.6 |
| SSL0804HC-3R3M-N | 3.3 | 20 | 65 | 0.014 | 6.4 | 5.9 |
| SSL0804HC-4R7M-N | 4.7 | 20 | 45 | 0.018 | 5.4 | 4.8 |
| SSL0804HC-6R8M-N | 6.8 | 20 | 35 | 0.035 | 3.6 | 5.0 |
| SSL0804HC-100M-N | 10 | 20 | 26 | 0.04 | 3.3 | 4.3 |
| SSL0804HC-150M-N | 15 | 20 | 21 | 0.06 | 2.4 | 3.5 |
| SSL0804HC-220M-N | 22 | 20 | 17 | 0.08 | 2.0 | 2.8 |
| SSL0804HC-330M-N | 33 | 20 | 14 | 0.15 | 1.7 | 2.1 |
| SSL0804HC-470M-N | 47 | 20 | 12 | 0.28 | 1.4 | 1.7 |
| SSL0804HC-680M-N | 68 | 20 | 9 | 0.3 | 1.2 | 1.5 |
| SSL0804HC-101M-N | 100 | 20 | 7 | 0.4 | 0.95 | 1.2 |

Note: When ordering, please specify tolerance code. Tolerance: M= $\pm 20\%$

- Operating temperature range - 40°C ~ 125°C(Including self - temperature rise)
- Isat for Inductance drop 10% from its value without current
- Irms for a 40°C temperature rise from 25°C ambient with current
- Measure Equipment :
 L : E4980 or HP4284A , 100kHz 0.1V
 SRF : HP4291A or HP4192A
 RDC : Chroma 16502
 Isat : HP4284A+HP42841A or WK3260B+WK3265B.

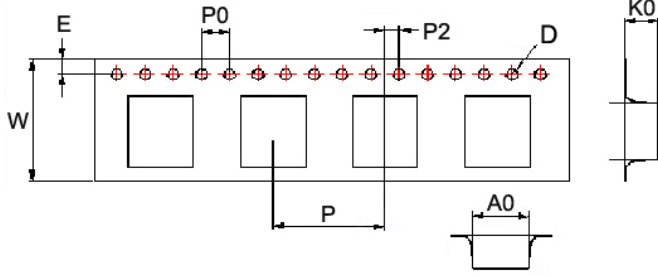
Test Instruments :



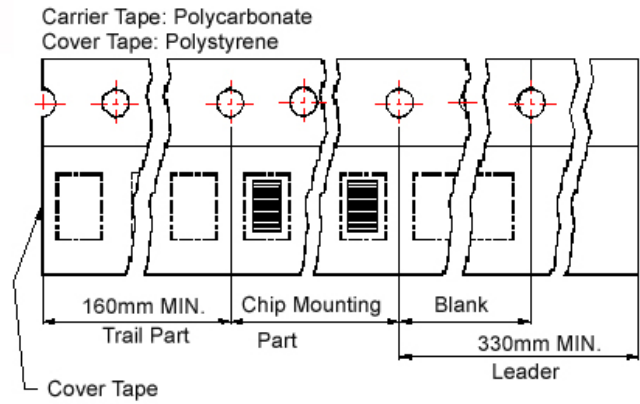
Please be sure to request approval specifications that provide further details of the products. Kindly note that the content of these specifications are subject to change or may be discontinued without advance notice. Please contact our sales department before ordering.

Packaging Specifications

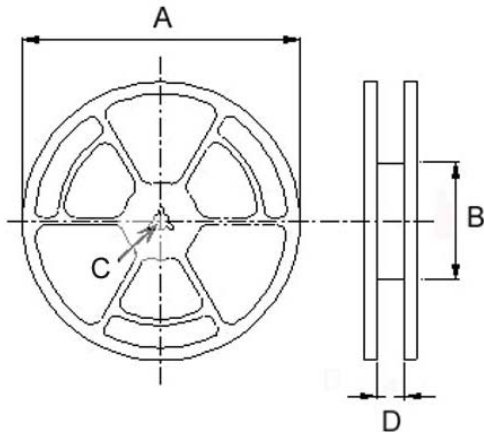
Tape Dimensions



Tape Material



Reel Dimensions



Dimensions in mm

| TPYE | Tape Dimensions | | | | | | | Reel Dimensions | | | | Quantity PCS / Reel |
|------------|-----------------|------|------|----|----|----|----|-----------------|-----|----|------|------------------------|
| | K0 | D | E | W | P | P0 | P2 | A | B | C | D | |
| SSL 0503HC | 5.3 | 1.55 | 1.75 | 16 | 12 | 4 | 2 | 330 | 100 | 13 | 16.0 | 1000 |
| SSL 0804HC | 6.1 | 1.55 | 1.75 | 24 | 16 | 4 | 2 | 330 | 100 | 13 | 24.2 | 700 |

TFL Series



The TFL Series is designed for miniaturized devices, featuring low inductance, high precision and low loss. It allows for easy impedance matching for both RF and IF circuit designs as well as compact high frequency circuit designs

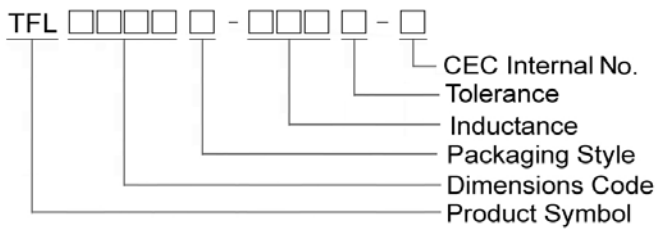
Features

- Ultra small size
- Excellent Q factor and SRF characteristics
- Minimal deviation in inductance
- Finely graded inductance level

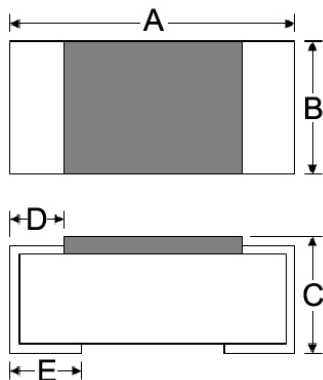
Applications

- RF and wireless communication
- Bluetooth, cellular phone, ultrabook, telecommunications, W-LAN
- High frequency circuits in general

Product Identification



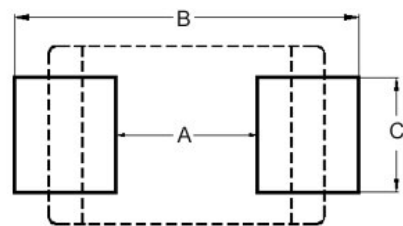
Shape and Dimensions



Dimensions in mm

| TYPE | A | B | C | D | E |
|---------|-----------|-----------|-----------|-----------|-----------|
| TFL0603 | 0.61±0.05 | 0.31±0.05 | 0.30±0.05 | 0.10±0.05 | 0.15±0.05 |

Recommended Pattern



Dimensions in mm

| TYPE | A | B | C |
|---------|-----|-------------|-----|
| TFL0603 | 0.3 | 0.75 ~ 1.05 | 0.3 |

SMD Thin Film Chip Inductors – TFL Series

Electrical Characteristics

| Part Number | Inductance (nH) | Tolerance (±%) | Q Min | Test Frequency (MHz) | SRF (MHz) Typ | RDC (Ω) Max | Rated Current (mA) Max |
|-----------------|-----------------|----------------|-------|----------------------|---------------|-------------|------------------------|
| TFL0603T-0N6□-S | 0.6 | ±0.1nH/±0.2nH | 14 | 500 / 500mV | 6000 | 0.10 | 900 |
| TFL0603T-0N7□-S | 0.7 | ±0.1nH/±0.2nH | 14 | 500 / 500mV | 6000 | 0.10 | 850 |
| TFL0603T-0N8□-S | 0.8 | ±0.1nH/±0.2nH | 14 | 500 / 500mV | 6000 | 0.10 | 850 |
| TFL0603T-0N9□-S | 0.9 | ±0.1nH/±0.2nH | 14 | 500 / 500mV | 6000 | 0.10 | 800 |
| TFL0603T-1N0□-S | 1.0 | ±0.1nH/±0.2nH | 14 | 500 / 500mV | 6000 | 0.10 | 800 |
| TFL0603T-1N1□-S | 1.1 | ±0.1nH/±0.2nH | 14 | 500 / 500mV | 6000 | 0.10 | 800 |
| TFL0603T-1N2□-S | 1.2 | ±0.1nH/±0.2nH | 14 | 500 / 500mV | 6000 | 0.10 | 800 |
| TFL0603T-1N3□-S | 1.3 | ±0.1nH/±0.2nH | 14 | 500 / 500mV | 6000 | 0.12 | 650 |
| TFL0603T-1N4□-S | 1.4 | ±0.1nH/±0.2nH | 14 | 500 / 500mV | 6000 | 0.13 | 650 |
| TFL0603T-1N5□-S | 1.5 | ±0.1nH/±0.2nH | 14 | 500 / 500mV | 6000 | 0.16 | 650 |
| TFL0603T-1N6□-S | 1.6 | ±0.1nH/±0.2nH | 14 | 500 / 500mV | 6000 | 0.16 | 650 |
| TFL0603T-1N7□-S | 1.7 | ±0.1nH/±0.2nH | 14 | 500 / 500mV | 6000 | 0.20 | 650 |
| TFL0603T-1N8□-S | 1.8 | ±0.1nH/±0.2nH | 14 | 500 / 500mV | 6000 | 0.20 | 650 |
| TFL0603T-1N9□-S | 1.9 | ±0.1nH/±0.2nH | 14 | 500 / 500mV | 6000 | 0.20 | 620 |
| TFL0603T-2N0□-S | 2.0 | ±0.1nH/±0.2nH | 14 | 500 / 500mV | 6000 | 0.20 | 620 |
| TFL0603T-2N1□-S | 2.1 | ±0.1nH/±0.2nH | 14 | 500 / 500mV | 6000 | 0.20 | 620 |
| TFL0603T-2N2□-S | 2.2 | ±0.1nH/±0.2nH | 14 | 500 / 500mV | 6000 | 0.20 | 620 |
| TFL0603T-2N3□-S | 2.3 | ±0.1nH/±0.2nH | 14 | 500 / 500mV | 6000 | 0.20 | 500 |
| TFL0603T-2N4□-S | 2.4 | ±0.1nH/±0.2nH | 14 | 500 / 500mV | 6000 | 0.20 | 500 |
| TFL0603T-2N5□-S | 2.5 | ±0.1nH/±0.2nH | 14 | 500 / 500mV | 6000 | 0.20 | 500 |
| TFL0603T-2N6□-S | 2.6 | ±0.1nH/±0.2nH | 14 | 500 / 500mV | 6000 | 0.20 | 500 |
| TFL0603T-2N7□-S | 2.7 | ±0.1nH/±0.2nH | 14 | 500 / 500mV | 6000 | 0.23 | 500 |
| TFL0603T-2N8□-S | 2.8 | ±0.1nH/±0.2nH | 14 | 500 / 500mV | 6000 | 0.25 | 500 |
| TFL0603T-2N9□-S | 2.9 | ±0.1nH/±0.2nH | 14 | 500 / 500mV | 6000 | 0.25 | 500 |
| TFL0603T-3N0□-S | 3.0 | ±0.1nH/±0.2nH | 14 | 500 / 500mV | 6000 | 0.30 | 450 |
| TFL0603T-3N1□-S | 3.1 | ±0.1nH/±0.2nH | 14 | 500 / 500mV | 6000 | 0.30 | 450 |
| TFL0603T-3N2□-S | 3.2 | ±0.1nH/±0.2nH | 14 | 500 / 500mV | 6000 | 0.30 | 450 |
| TFL0603T-3N3□-S | 3.3 | ±0.1nH/±0.2nH | 14 | 500 / 500mV | 6000 | 0.30 | 450 |
| TFL0603T-3N4□-S | 3.4 | ±0.1nH/±0.2nH | 14 | 500 / 500mV | 6000 | 0.32 | 450 |
| TFL0603T-3N5□-S | 3.5 | ±0.1nH/±0.2nH | 14 | 500 / 500mV | 6000 | 0.32 | 450 |
| TFL0603T-3N6□-S | 3.6 | ±0.1nH/±0.2nH | 14 | 500 / 500mV | 6000 | 0.32 | 400 |
| TFL0603T-3N7□-S | 3.7 | ±0.1nH/±0.2nH | 14 | 500 / 500mV | 6000 | 0.40 | 400 |
| TFL0603T-3N8□-S | 3.8 | ±0.1nH/±0.2nH | 14 | 500 / 500mV | 6000 | 0.40 | 350 |
| TFL0603T-3N9□-S | 3.9 | ±0.1nH/±0.2nH | 14 | 500 / 500mV | 5700 | 0.40 | 350 |
| TFL0603T-4N3□-S | 4.3 | 3 / 5 | 14 | 500 / 500mV | 5300 | 0.40 | 300 |
| TFL0603T-4N7□-S | 4.7 | 3 / 5 | 14 | 500 / 500mV | 4400 | 0.45 | 280 |
| TFL0603T-5N1□-S | 5.1 | 3 / 5 | 14 | 500 / 500mV | 4200 | 0.50 | 270 |
| TFL0603T-5N6□-S | 5.6 | 3 / 5 | 14 | 500 / 500mV | 4000 | 0.55 | 260 |
| TFL0603T-6N2□-S | 6.2 | 3 / 5 | 14 | 500 / 500mV | 4000 | 0.60 | 250 |
| TFL0603T-6N8□-S | 6.8 | 3 / 5 | 14 | 500 / 500mV | 3900 | 0.70 | 230 |
| TFL0603T-7N5□-S | 7.5 | 3 / 5 | 12 | 500 / 500mV | 3700 | 1.10 | 180 |
| TFL0603T-8N2□-S | 8.2 | 3 / 5 | 12 | 500 / 500mV | 3600 | 1.20 | 180 |
| TFL0603T-9N1□-S | 9.1 | 3 / 5 | 12 | 500 / 500mV | 3300 | 1.20 | 180 |
| TFL0603T-10N□-S | 10 | 3 / 5 | 12 | 500 / 500mV | 3200 | 1.30 | 180 |

Please be sure to request approval specifications that provide further details of the products. Kindly note that the content of these specifications are subject to change or may be discontinued without advance notice. Please contact our sales department before ordering.

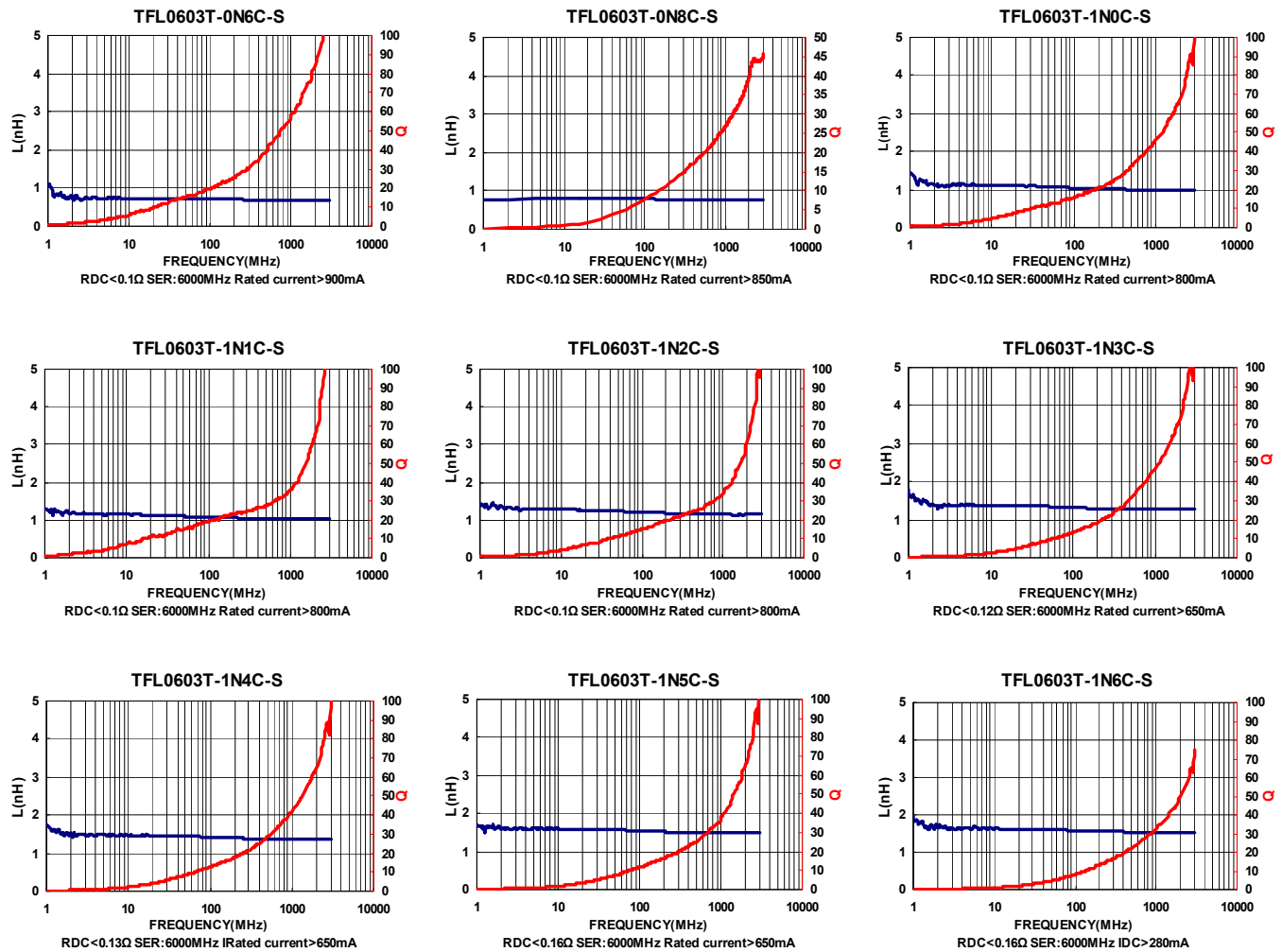
Electrical Characteristics

| Part Number | Inductance (nH) | Tolerance (±%) | Q Min | Test Frequency (MHz) | SRF (MHz) Typ | RDC (Ω) Max | Rated Current (mA) Max |
|-----------------|-----------------|----------------|-------|----------------------|---------------|-------------|------------------------|
| TFL0603T-12N□-S | 12 | 3 / 5 | 12 | 500 / 500mV | 2900 | 1.30 | 180 |
| TFL0603T-15N□-S | 15 | 3 / 5 | 12 | 500 / 500mV | 2600 | 1.50 | 180 |
| TFL0603T-18N□-S | 18 | 3 / 5 | 12 | 500 / 500mV | 2200 | 1.70 | 160 |
| TFL0603T-22N□-S | 22 | 3 / 5 | 12 | 500 / 500mV | 2200 | 2.55 | 120 |

Note: When ordering, please specify tolerance code. Tolerance: B=±0.1nH , C=±0.2nH , H=±3% , J=±5%

- Operating temperature range - 55°C ~ 125°C(Including self - temperature rise)
- Rated Current : Applied the current to coils, the inductance shall be less than 10% initial value
- Measure Equipment :
L & Q : Agilent E4991A+Agilent 16197A
SRF : HP8753D
RDC : HP4338B or CHEN HWA 502

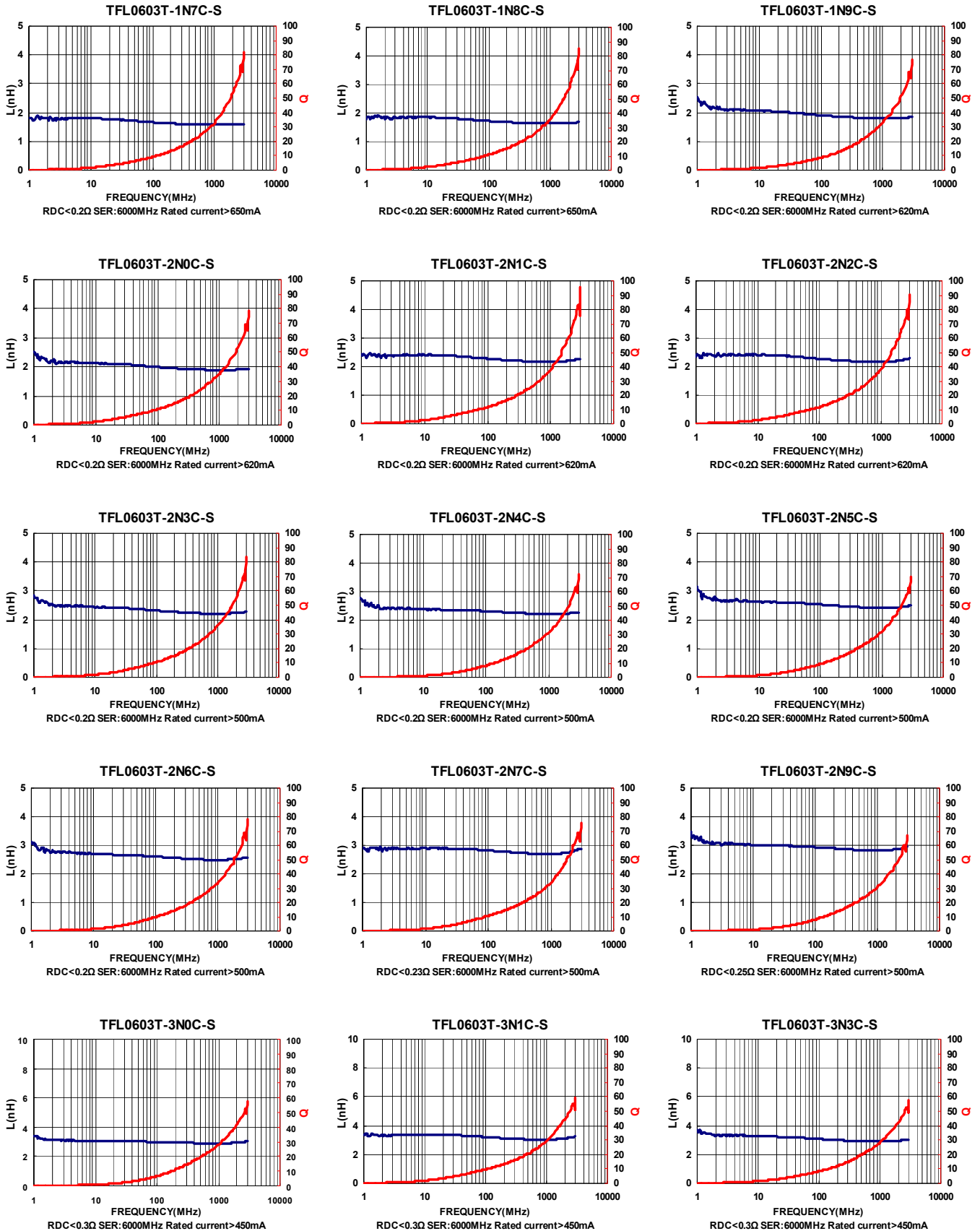
Test Instruments : Agilent E4991A Material/Impedance Analyzer



Please be sure to request approval specifications that provide further details of the products. Kindly note that the content of these specifications are subject to change or may be discontinued without advance notice. Please contact our sales department before ordering.

SMD Thin Film Chip Inductors - TFL Series

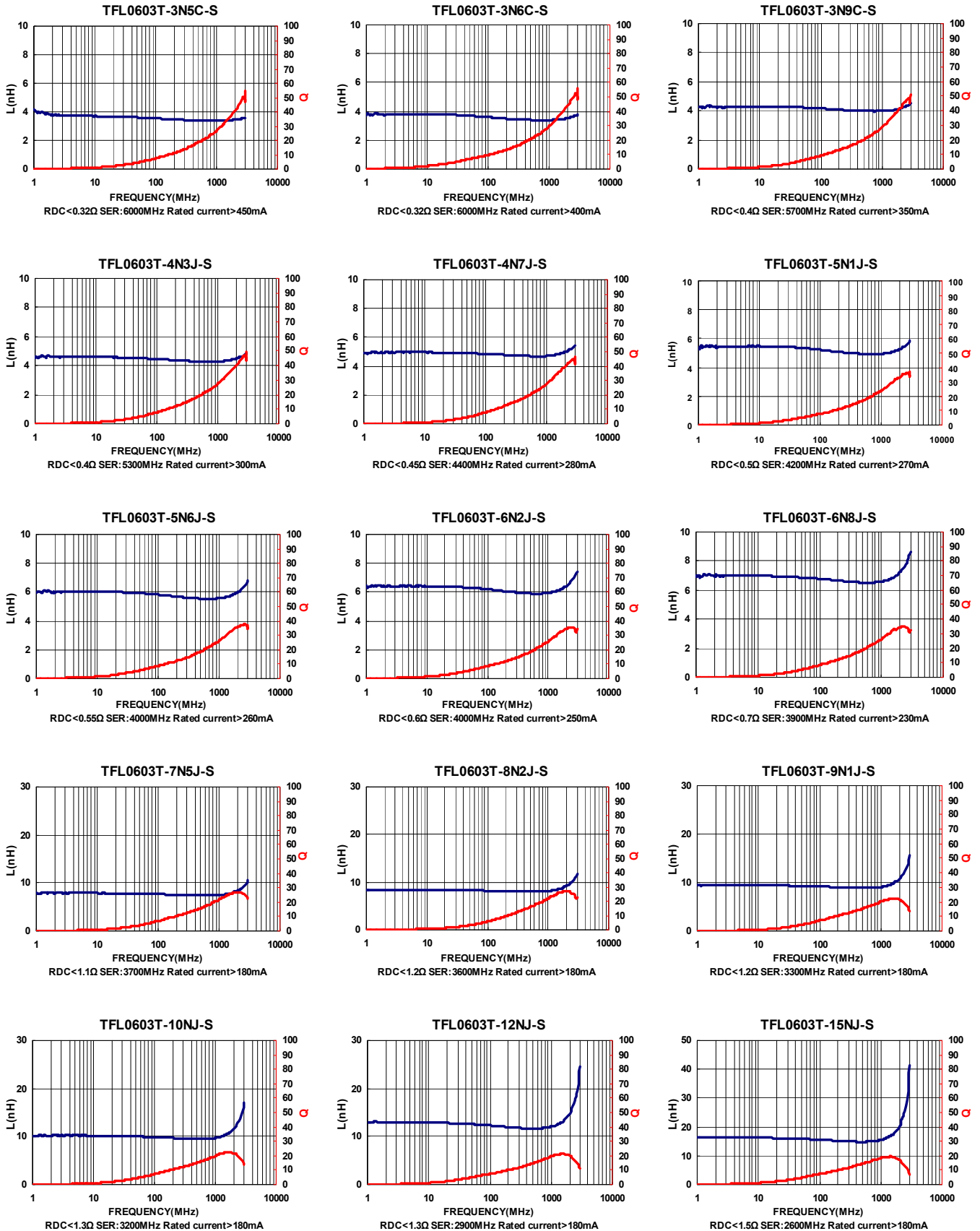
Test Instruments : Agilent E4991A Material/Impedance Analyzer



Please be sure to request approval specifications that provide further details of the products. Kindly note that the content of these specifications are subject to change or may be discontinued without advance notice. Please contact our sales department before ordering.

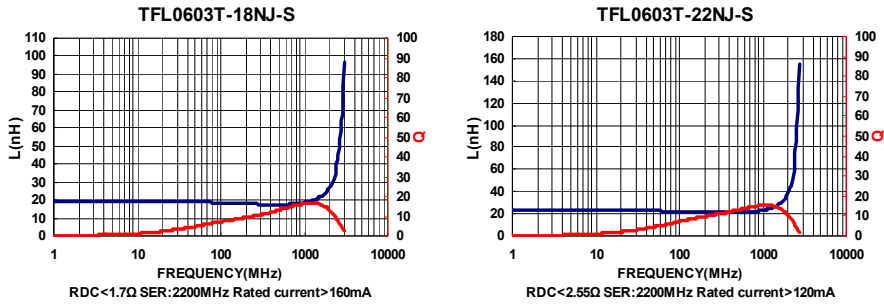
SMD Thin Film Chip Inductors - TFL Series

Test Instruments : Agilent E4991A Material/Impedance Analyzer



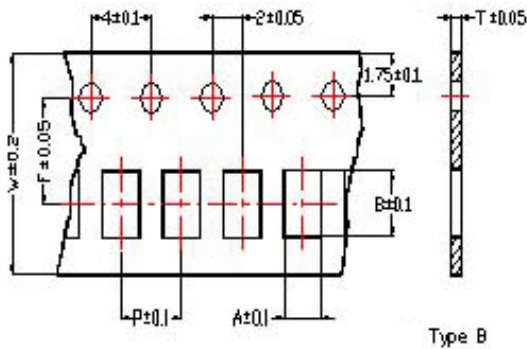
Please be sure to request approval specifications that provide further details of the products. Kindly note that the content of these specifications are subject to change or may be discontinued without advance notice. Please contact our sales department before ordering.

Test Instruments : Agilent E4991A Material/Impedance Analyzer



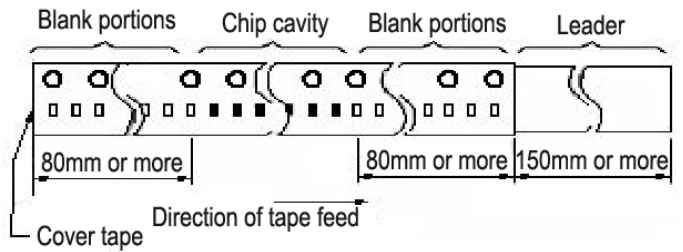
Packaging Specifications

Tape Dimensions

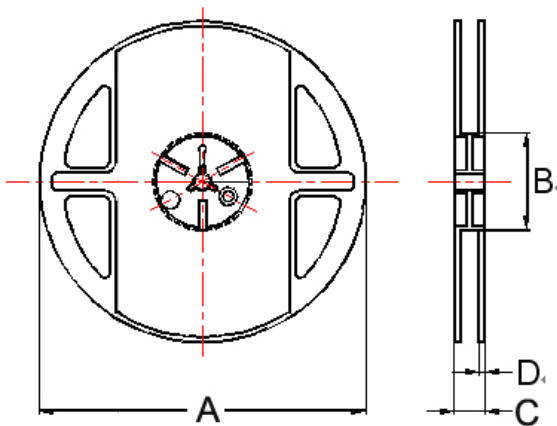


Tape Material

Carrier tape : Paper
Cover tape : Polyethylene



Reel Dimensions



Dimensions in mm

| TYPE | Tape Dimensions | | | | | | Reel Dimensions | | | | Quantity PCS / Reel |
|---------|-----------------|------|------|---|---|-----|-----------------|----|----|-----|------------------------|
| | A | B | T | W | P | F | A | B | C | D | |
| TFL0603 | 0.37 | 0.67 | 0.42 | 8 | 2 | 3.5 | 180 | 60 | 13 | 1.5 | 15000 |

Please be sure to request approval specifications that provide further details of the products. Kindly note that the content of these specifications are subject to change or may be discontinued without advance notice. Please contact our sales department before ordering.

THQ Series



THQ Series is a type of ceramic chip inductor produced using thin film technology designed for miniaturized devices, featuring low inductance and high precision. It is suitable for high frequency applications

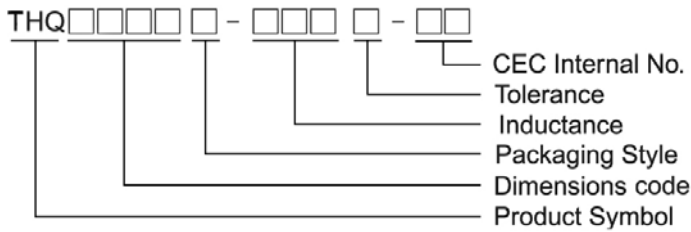
Features

- High frequency application
- Miniaturization
- Tight tolerance

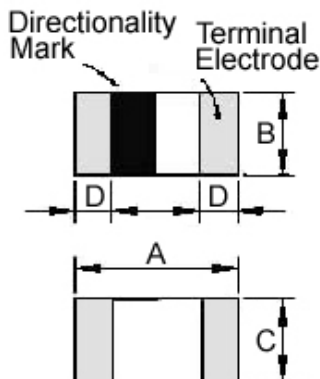
Applications

- RF matching circuit requiring Q value
- Bluetooth, WLAN, UWB, digital TV tuners and high-frequency circuit and module

Product Identification



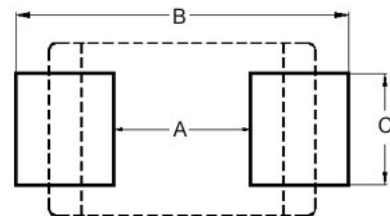
Shape and Dimensions



Dimensions in mm

| TYPE | A | B | C | D |
|---------|----------|----------|----------|-------------|
| THQ0402 | 0.4±0.02 | 0.2±0.02 | 0.2±0.02 | 0.095±0.025 |

Recommended Pattern



Dimensions in mm

| TYPE | A | B | C |
|---------|----------|------------|----------|
| THQ0402 | 0.16~0.2 | 0.4 ~ 0.56 | 0.2~0.23 |

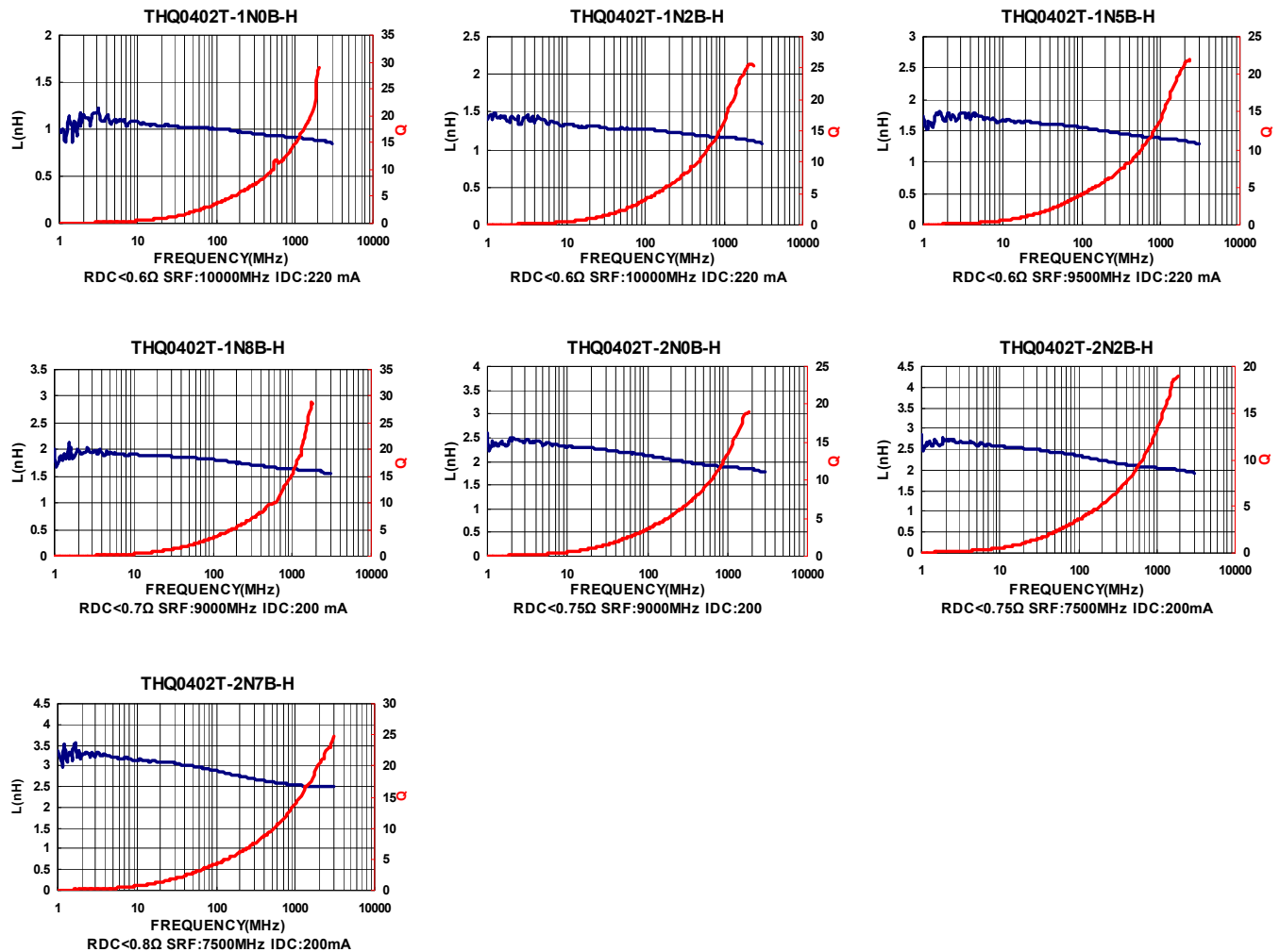
Electrical Characteristics

| Part Number | Inductance (nH) | Tolerance (±%) | Q Min | Test Frequency (MHz) | SRF (MHz) Min | RDC (Ω) Max | IDC (mA) Max |
|-----------------|-----------------|----------------|-------|----------------------|---------------|-------------|--------------|
| THQ0402T-1N0B-H | 1.0 | ±0.1nH | 8 | 500 | 10000 | 0.60 | 220 |
| THQ0402T-1N2B-H | 1.2 | ±0.1nH | 8 | 500 | 10000 | 0.60 | 220 |
| THQ0402T-1N5B-H | 1.5 | ±0.1nH | 8 | 500 | 9500 | 0.60 | 220 |
| THQ0402T-1N8B-H | 1.8 | ±0.1nH | 8 | 500 | 9000 | 0.70 | 200 |
| THQ0402T-2N0B-H | 2.0 | ±0.1nH | 8 | 500 | 9000 | 0.75 | 200 |
| THQ0402T-2N2B-H | 2.2 | ±0.1nH | 8 | 500 | 7500 | 0.75 | 200 |
| THQ0402T-2N7B-H | 2.7 | ±0.1nH | 8 | 500 | 7500 | 0.80 | 200 |

Note: When ordering, please specify tolerance code. Tolerance : B=±0.1nH , C=±0.2nH , S=±0.3nH

- Operating temperature range - 55°C ~ 125°C(Including self - temperature rise)
- IDC : Applied the current to coils, the inductance shall be less than 10% initial value
- Residual impedance of short chip : 0.11nH
- Measure Equipment :
 L & Q : Agilent E4991A+Agilent 16197A
 SRF : Agilent E4991A or HP19196C
 RDC : HP4338B or CHEN HWA 502

Test Instruments : Agilent E4991A Material/Impedance Analyzer



Please be sure to request approval specifications that provide further details of the products. Kindly note that the content of these specifications are subject to change or may be discontinued without advance notice. Please contact our sales department before ordering.

CHQ Series



CHQ Series supports miniaturized devices. Its low inductance, high precision and high Q enables easy impedance matching at both RF and IF circuits and compact high frequency circuit designing.

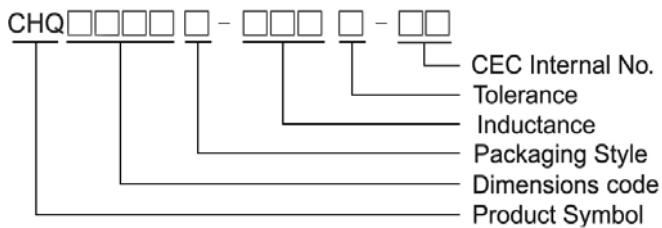
Features

- Excellent high frequency application
- High Q factor and SRF value
- Miniaturization
- Tight tolerance
- Wide inductance range

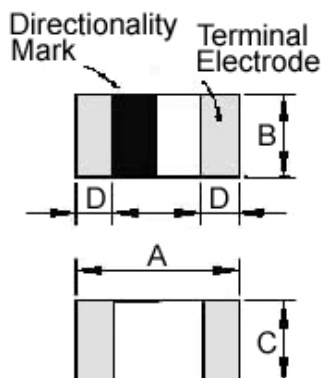
Applications

- RF matching circuit requiring Q value
- Bluetooth, WLAN, UWB, digital TV tuners and high-frequency circuit and module

Product Identification



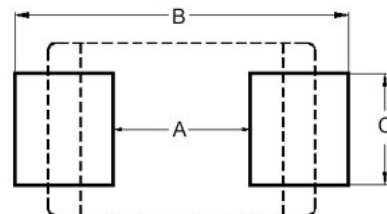
Shape and Dimensions



Dimensions in mm

| TYPE | A | B | C | D |
|---------|----------|----------|----------|-----------|
| CHQ0603 | 0.6±0.03 | 0.3±0.03 | 0.3±0.03 | 0.15±0.05 |
| CHQ1005 | 1.0±0.10 | 0.5±0.10 | 0.5±0.10 | 0.25±0.10 |

Recommended Pattern



Dimensions in mm

| TYPE | A | B | C |
|---------|-----|-------------|-----|
| CHQ0603 | 0.3 | 0.75 ~ 1.05 | 0.3 |
| CHQ1005 | 0.4 | 1.2 ~ 1.4 | 0.5 |

SMD Ceramic Multilayer Chip Inductors - CHQ Series

Electrical Characteristics

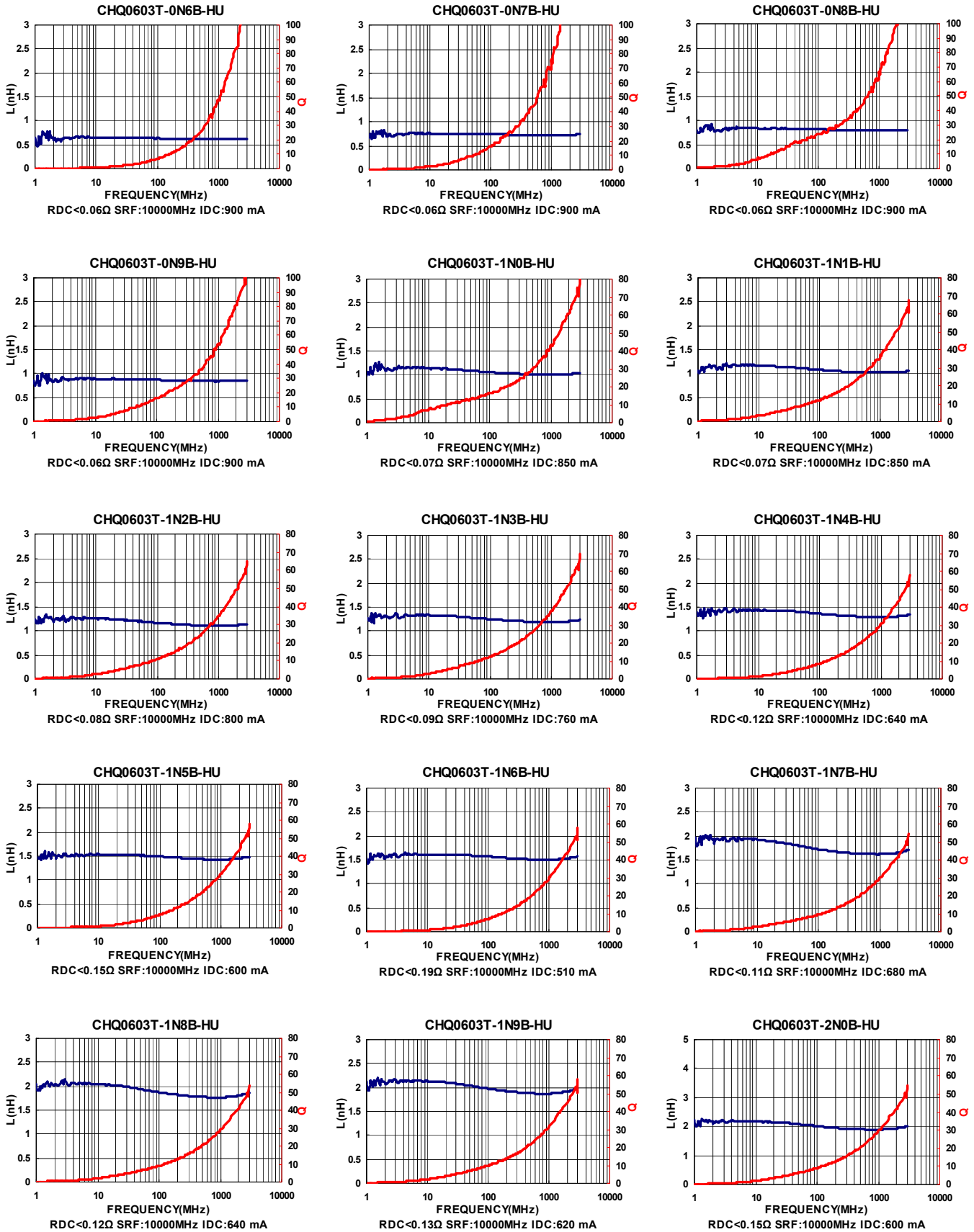
| Part Number | Inductance (nH) | Tolerance (±%) | Q Min | Test Frequency (MHz) | Q Typical | | | | | SRF (MHz) Min | RDC (Ω) Max | IDC (mA) Max |
|------------------|--------------------|----------------------|----------|----------------------------|------------|------------|------------|------------|------------|---------------------|----------------|-----------------|
| | | | | | 500 MHz | 800 MHz | 1.8 GHz | 2.0 GHz | 2.4 GHz | | | |
| CHQ0603T-0N6□-HU | 0.6 | ±0.1nH/±0.2nH/±0.3nH | 14 | 500 | >35 | >47 | >75 | >80 | >88 | 10000 | 0.06 | 900 |
| CHQ0603T-0N7□-HU | 0.7 | ±0.1nH/±0.2nH/±0.3nH | 14 | 500 | >35 | >47 | >75 | >80 | >88 | 10000 | 0.06 | 900 |
| CHQ0603T-0N8□-HU | 0.8 | ±0.1nH/±0.2nH/±0.3nH | 14 | 500 | >35 | >47 | >75 | >80 | >88 | 10000 | 0.06 | 900 |
| CHQ0603T-0N9□-HU | 0.9 | ±0.1nH/±0.2nH/±0.3nH | 14 | 500 | >35 | >47 | >75 | >80 | >88 | 10000 | 0.06 | 900 |
| CHQ0603T-1N0□-HU | 1.0 | ±0.1nH/±0.2nH/±0.3nH | 14 | 500 | >35 | >47 | >75 | >80 | >88 | 10000 | 0.07 | 850 |
| CHQ0603T-1N1□-HU | 1.1 | ±0.1nH/±0.2nH/±0.3nH | 14 | 500 | >35 | >47 | >75 | >80 | >88 | 10000 | 0.07 | 850 |
| CHQ0603T-1N2□-HU | 1.2 | ±0.1nH/±0.2nH/±0.3nH | 14 | 500 | 35 | 47 | 75 | 80 | 88 | 10000 | 0.08 | 800 |
| CHQ0603T-1N3□-HU | 1.3 | ±0.1nH/±0.2nH/±0.3nH | 14 | 500 | 32 | 43 | 70 | 74 | 82 | 10000 | 0.09 | 760 |
| CHQ0603T-1N4□-HU | 1.4 | ±0.1nH/±0.2nH/±0.3nH | 14 | 500 | 29 | 39 | 63 | 67 | 75 | 10000 | 0.12 | 640 |
| CHQ0603T-1N5□-HU | 1.5 | ±0.1nH/±0.2nH/±0.3nH | 14 | 500 | 27 | 36 | 59 | 62 | 69 | 10000 | 0.15 | 600 |
| CHQ0603T-1N6□-HU | 1.6 | ±0.1nH/±0.2nH/±0.3nH | 14 | 500 | 25 | 33 | 54 | 57 | 63 | 10000 | 0.19 | 510 |
| CHQ0603T-1N7□-HU | 1.7 | ±0.1nH/±0.2nH/±0.3nH | 14 | 500 | 25 | 32 | 52 | 54 | 61 | 10000 | 0.11 | 680 |
| CHQ0603T-1N8□-HU | 1.8 | ±0.1nH/±0.2nH/±0.3nH | 14 | 500 | 25 | 32 | 51 | 53 | 59 | 10000 | 0.12 | 640 |
| CHQ0603T-1N9□-HU | 1.9 | ±0.1nH/±0.2nH/±0.3nH | 14 | 500 | 24 | 31 | 50 | 53 | 58 | 10000 | 0.13 | 620 |
| CHQ0603T-2N0□-HU | 2.0 | ±0.1nH/±0.2nH/±0.3nH | 14 | 500 | 24 | 31 | 50 | 53 | 58 | 10000 | 0.15 | 600 |
| CHQ0603T-2N1□-HU | 2.1 | ±0.1nH/±0.2nH/±0.3nH | 14 | 500 | 24 | 31 | 50 | 53 | 58 | 10000 | 0.16 | 550 |
| CHQ0603T-2N2□-HU | 2.2 | ±0.1nH/±0.2nH/±0.3nH | 14 | 500 | 24 | 31 | 50 | 53 | 58 | 10000 | 0.20 | 500 |
| CHQ0603T-2N3□-HU | 2.3 | ±0.1nH/±0.2nH/±0.3nH | 14 | 500 | 24 | 31 | 49 | 52 | 58 | 10000 | 0.24 | 460 |
| CHQ0603T-2N4□-HU | 2.4 | ±0.1nH/±0.2nH/±0.3nH | 14 | 500 | 22 | 28 | 45 | 48 | 53 | 10000 | 0.26 | 430 |
| CHQ0603T-2N5□-HU | 2.5 | ±0.1nH/±0.2nH/±0.3nH | 14 | 500 | 22 | 29 | 46 | 49 | 54 | 10000 | 0.28 | 415 |
| CHQ0603T-2N6□-HU | 2.6 | ±0.1nH/±0.2nH/±0.3nH | 14 | 500 | 21 | 27 | 44 | 46 | 51 | 10000 | 0.30 | 405 |
| CHQ0603T-2N7□-HU | 2.7 | ±0.1nH/±0.2nH/±0.3nH | 14 | 500 | 20 | 26 | 41 | 43 | 48 | 10000 | 0.32 | 400 |
| CHQ0603T-2N8□-HU | 2.8 | ±0.1nH/±0.2nH/±0.3nH | 14 | 500 | 20 | 26 | 41 | 43 | 47 | 9500 | 0.20 | 500 |
| CHQ0603T-2N9□-HU | 2.9 | ±0.1nH/±0.2nH/±0.3nH | 14 | 500 | 20 | 26 | 41 | 43 | 47 | 9300 | 0.22 | 480 |
| CHQ0603T-3N0□-HU | 3.0 | ±0.1nH/±0.2nH/±0.3nH | 14 | 500 | 20 | 26 | 41 | 43 | 47 | 9100 | 0.24 | 460 |
| CHQ0603T-3N1□-HU | 3.1 | ±0.1nH/±0.2nH/±0.3nH | 14 | 500 | 20 | 26 | 41 | 43 | 47 | 8900 | 0.25 | 450 |
| CHQ0603T-3N2□-HU | 3.2 | ±0.1nH/±0.2nH/±0.3nH | 14 | 500 | 20 | 26 | 40 | 43 | 47 | 8700 | 0.28 | 415 |
| CHQ0603T-3N3□-HU | 3.3 | ±0.1nH/±0.2nH/±0.3nH | 14 | 500 | 20 | 26 | 40 | 43 | 47 | 8600 | 0.28 | 415 |
| CHQ0603T-3N4□-HU | 3.4 | ±0.1nH/±0.2nH/±0.3nH | 14 | 500 | 20 | 25 | 40 | 43 | 47 | 8400 | 0.29 | 410 |
| CHQ0603T-3N5□-HU | 3.5 | ±0.1nH/±0.2nH/±0.3nH | 14 | 500 | 20 | 25 | 40 | 42 | 46 | 8200 | 0.30 | 405 |
| CHQ0603T-3N6□-HU | 3.6 | ±0.1nH/±0.2nH/±0.3nH | 14 | 500 | 19 | 25 | 40 | 42 | 46 | 8100 | 0.32 | 400 |
| CHQ0603T-3N7□-HU | 3.7 | ±0.1nH/±0.2nH/±0.3nH | 14 | 500 | 19 | 25 | 40 | 42 | 46 | 8000 | 0.36 | 370 |
| CHQ0603T-3N8□-HU | 3.8 | ±0.1nH/±0.2nH/±0.3nH | 14 | 500 | 19 | 25 | 39 | 41 | 45 | 7800 | 0.40 | 355 |
| CHQ0603T-3N9□-HU | 3.9 | ±0.1nH/±0.2nH/±0.3nH | 14 | 500 | 19 | 25 | 39 | 41 | 45 | 7700 | 0.41 | 350 |
| CHQ0603T-4N3□-HU | 4.3 | ±0.2nH/±0.3nH | 14 | 500 | 18 | 24 | 37 | 39 | 43 | 6500 | 0.48 | 320 |
| CHQ0603T-4N7□-HU | 4.7 | ±0.2nH/±0.3nH | 14 | 500 | 19 | 24 | 37 | 39 | 42 | 6400 | 0.42 | 350 |
| CHQ0603T-5N1□-HU | 5.1 | ±0.2nH/±0.3nH | 14 | 500 | 19 | 24 | 37 | 39 | 42 | 6100 | 0.45 | 330 |
| CHQ0603T-5N6□-HU | 5.6 | ±0.2nH/±0.3nH | 14 | 500 | 18 | 24 | 36 | 37 | 41 | 5500 | 0.47 | 325 |
| CHQ0603T-6N2□-HU | 6.2 | ±0.2nH/±0.3nH | 14 | 500 | 18 | 23 | 35 | 36 | 39 | 5100 | 0.52 | 305 |
| CHQ0603T-6N8□-HU | 6.8 | 3 / 5 | 14 | 500 | 18 | 23 | 35 | 36 | 39 | 4800 | 0.55 | 305 |
| CHQ0603T-7N5□-HU | 7.5 | 3 / 5 | 14 | 500 | 18 | 23 | 34 | 35 | 38 | 4600 | 0.55 | 305 |
| CHQ0603T-8N2□-HU | 8.2 | 3 / 5 | 14 | 500 | 17 | 22 | 33 | 34 | 36 | 4300 | 0.57 | 290 |
| CHQ0603T-9N1□-HU | 9.1 | 3 / 5 | 14 | 500 | 17 | 22 | 33 | 34 | 36 | 4000 | 0.65 | 270 |
| CHQ0603T-10N□-HU | 10 | 3 / 5 | 14 | 500 | 17 | 22 | 33 | 34 | 36 | 3800 | 0.85 | 230 |
| CHQ0603T-12N□-HU | 12 | 3 / 5 | 14 | 500 | 17 | 22 | 31 | 32 | 33 | 3300 | 0.85 | 230 |
| CHQ0603T-15N□-HU | 15 | 3 / 5 | 14 | 500 | 17 | 21 | 28 | 29 | 29 | 2600 | 0.89 | 220 |
| CHQ0603T-18N□-HU | 18 | 3 / 5 | 14 | 500 | 16 | 21 | 26 | 26 | 25 | 2300 | 1.05 | 205 |
| CHQ0603T-22N□-HU | 22 | 3 / 5 | 14 | 500 | 16 | 21 | 26 | 26 | 24 | 1900 | 1.29 | 190 |

Note: When ordering, please specify tolerance code. Tolerance : B=±0.1nH , C=±0.2nH , S=±0.3nH , H=±3% , J=±5%

- Operating temperature range - 55°C ~ 125°C(Including self - temperature rise)
- IDC : Applied the current to coils, the inductance shall be less than 10% initial value
- Residual impedance of short chip : 0.48nH
- Measure Equipment :
L & Q : Agilent E4991A+Agilent 16197A
SRF : Agilent E4991A or HP19196C
RDC : HP4338B or CHEN HWA 502

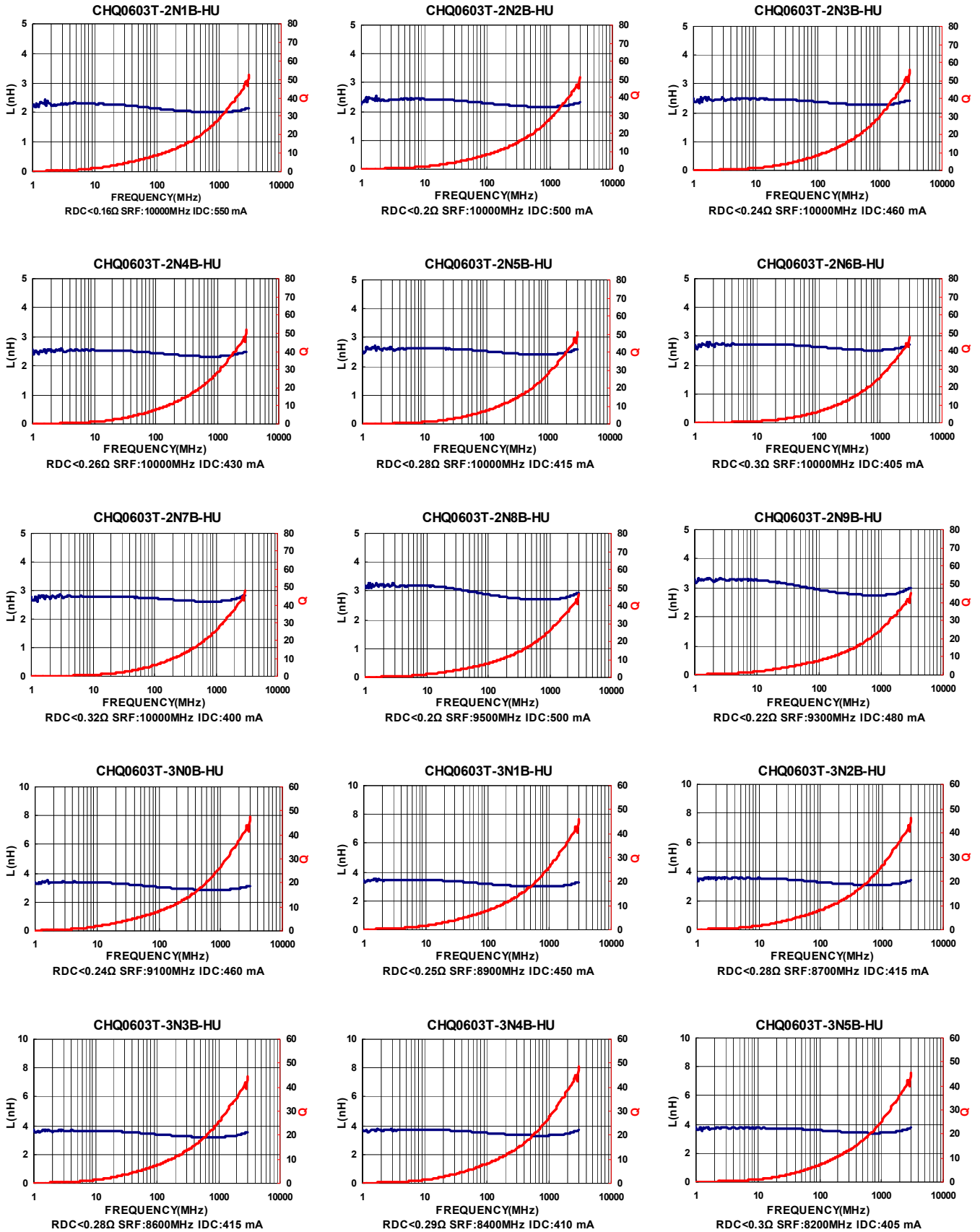
Please be sure to request approval specifications that provide further details of the products. Kindly note that the content of these specifications are subject to change or may be discontinued without advance notice. Please contact our sales department before ordering.

Test Instruments : Agilent E4991A Material/Impedance Analyzer



Please be sure to request approval specifications that provide further details of the products. Kindly note that the content of these specifications are subject to change or may be discontinued without advance notice. Please contact our sales department before ordering.

Test Instruments : Agilent E4991A Material/Impedance Analyzer



Please be sure to request approval specifications that provide further details of the products. Kindly note that the content of these specifications are subject to change or may be discontinued without advance notice. Please contact our sales department before ordering.

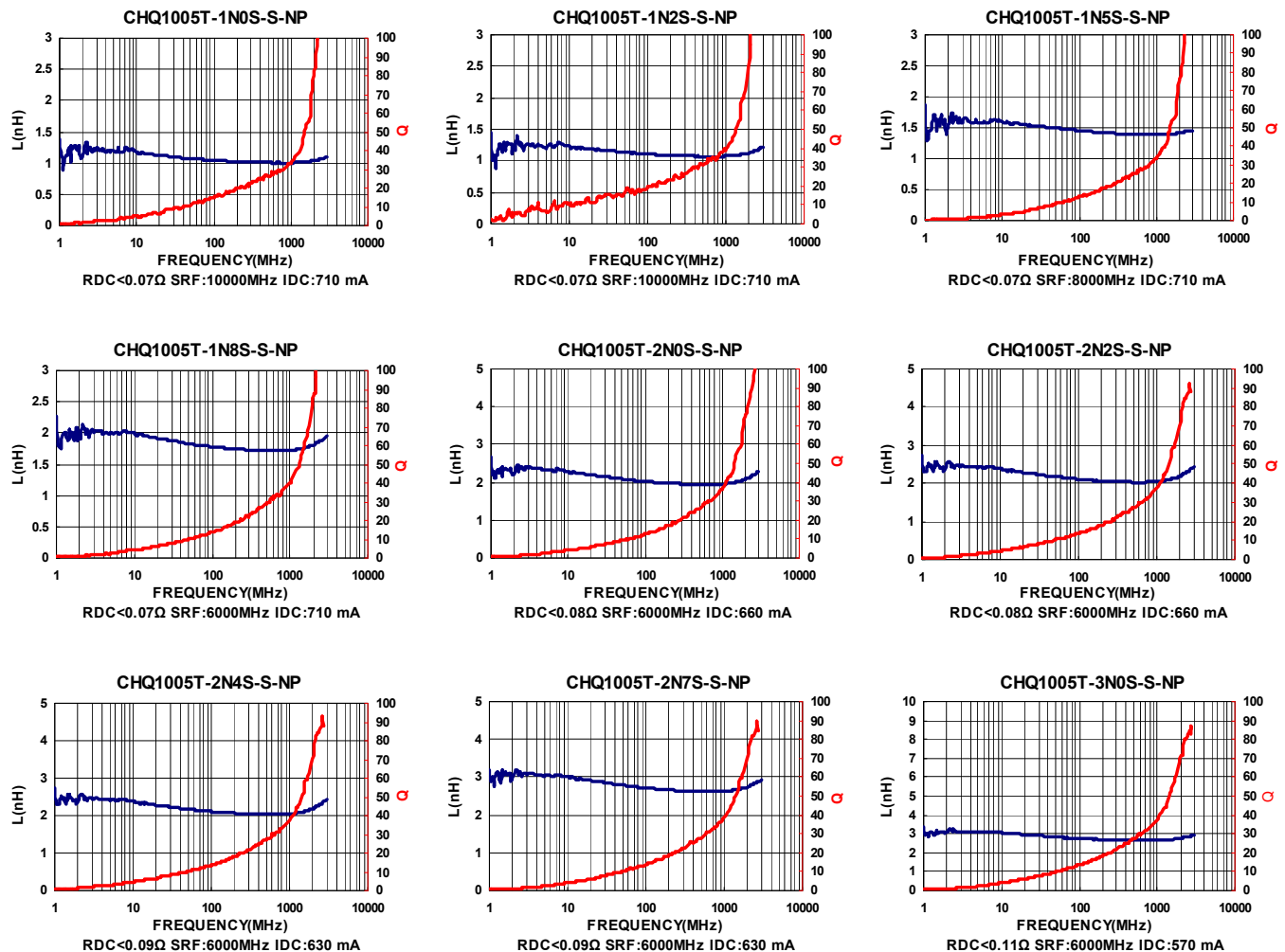
Electrical Characteristics

| Part Number | Inductance (nH) | Tolerance (±%) | Test Frequency (MHz) | Q | | SRF (MHz) Min | RDC (Ω) Max | IDC (mA) Max |
|--------------------|-----------------|----------------|----------------------|------------|------------|---------------|-------------|--------------|
| | | | | Min 100MHz | Typ 250MHz | | | |
| CHQ1005T-1N0□-S-NP | 1.0 | ±0.3nH | 100 | 8 | 23 | 10000 | 0.07 | 710 |
| CHQ1005T-1N2□-S-NP | 1.2 | ±0.3nH | 100 | 8 | 23 | 10000 | 0.07 | 710 |
| CHQ1005T-1N5□-S-NP | 1.5 | ±0.3nH | 100 | 8 | 20 | 8000 | 0.07 | 710 |
| CHQ1005T-1N8□-S-NP | 1.8 | ±0.3nH | 100 | 8 | 20 | 6000 | 0.07 | 710 |
| CHQ1005T-2N0□-S-NP | 2.0 | ±0.3nH | 100 | 8 | 20 | 6000 | 0.08 | 660 |
| CHQ1005T-2N2□-S-NP | 2.2 | ±0.3nH | 100 | 8 | 20 | 6000 | 0.08 | 660 |
| CHQ1005T-2N4□-S-NP | 2.4 | ±0.3nH | 100 | 8 | 18 | 6000 | 0.09 | 630 |
| CHQ1005T-2N7□-S-NP | 2.7 | ±0.3nH | 100 | 8 | 18 | 6000 | 0.09 | 630 |
| CHQ1005T-3N0□-S-NP | 3.0 | ±0.3nH | 100 | 8 | 18 | 6000 | 0.11 | 570 |
| CHQ1005T-3N3□-S-NP | 3.3 | ±0.3nH | 100 | 8 | 18 | 6000 | 0.12 | 540 |
| CHQ1005T-3N6□-S-NP | 3.6 | ±0.3nH | 100 | 8 | 18 | 5000 | 0.14 | 500 |
| CHQ1005T-3N9□-S-NP | 3.9 | ±0.3nH | 100 | 8 | 18 | 4000 | 0.15 | 490 |

Note: When ordering, please specify tolerance code. Tolerance : S=±0.3nH , J=±5%

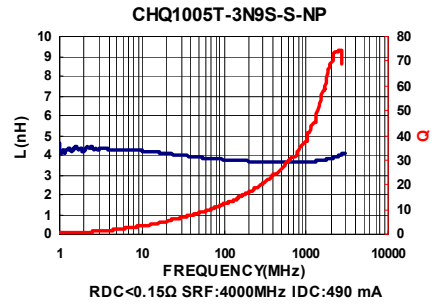
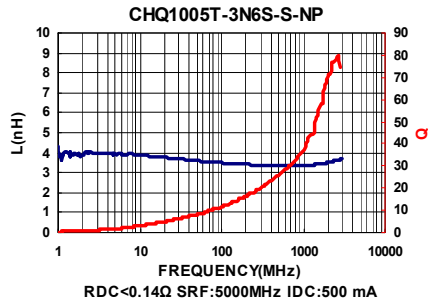
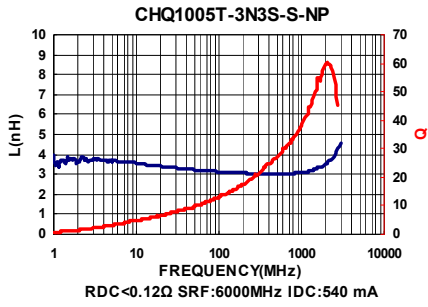
- Operating temperature range - 55°C ~ 125°C(Including self - temperature rise)
- IDC : Applied the current to coils, the inductance shall be less than 10% initial value
- Residual impedance of short chip : 0.19nH(Inductance ≤ 4.3nH) or 0.48nH(Inductance > 4.3nH)
- Measure Equipment :
 L & Q : Agilent E4991A+Agilent 16197A
 SRF : Agilent E4991A or HP19196C
 RDC : HP4338B or CHEN HWA 502

Test Instruments : Agilent E4991A Material/Impedance Analyzer



Please be sure to request approval specifications that provide further details of the products. Kindly note that the content of these specifications are subject to change or may be discontinued without advance notice. Please contact our sales department before ordering.

Test Instruments : Agilent E4991A Material/Impedance Analyzer

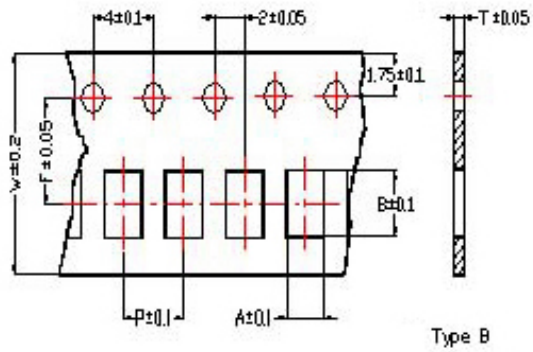


Please be sure to request approval specifications that provide further details of the products. Kindly note that the content of these specifications are subject to change or may be discontinued without advance notice. Please contact our sales department before ordering.

Packaging Specifications

Tape Dimensions

Figure A



Tape Material

Figure A

Carrier Tape: Polycarbonate (Tape A)
 Carrier Tape: Paper (Tape B)
 Cover Tape: Polystyrene

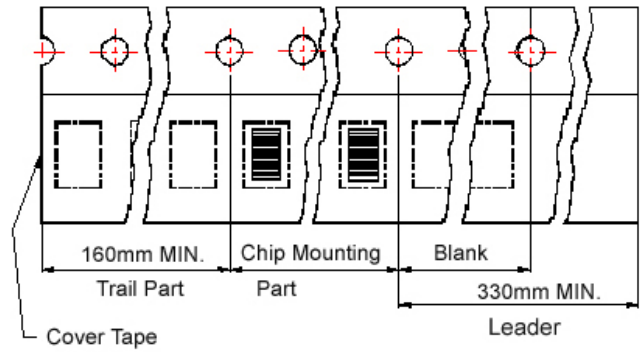
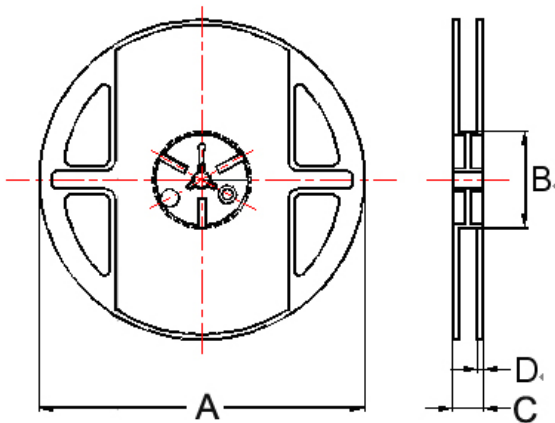
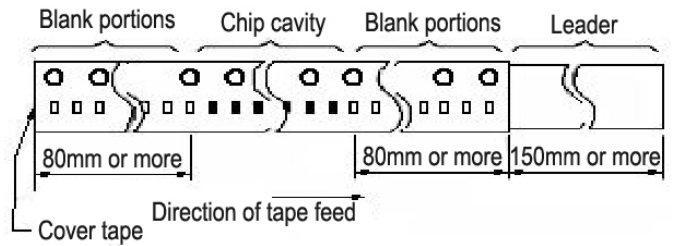


Figure B

Carrier tape : Paper
 Cover tape : Polyethylene



Dimensions in mm

| TYPE | Tape Dimensions | | | | | | | Tape Material | Reel Dimensions | | | | Quantity PCS / Reel |
|---------|-----------------|------|------|---|---|-----|---|---------------|-----------------|----|----|-----|------------------------|
| | A | B | T | W | P | F | A | | B | C | D | | |
| CHQ0603 | 0.37 | 0.67 | 0.42 | 8 | 2 | 3.5 | A | B | 180 | 60 | 13 | 1.5 | 15000 |
| CHQ1005 | 0.62 | 1.12 | 0.60 | 8 | 2 | 3.5 | A | A | 178 | 60 | 12 | 1.5 | 10000 |

CLH Series



The CLH Series is a type of ceramic chip inductor produced using the multilayer technology. The series provides excellent Q factor and SRF characteristics and is suitable for high frequency applications.

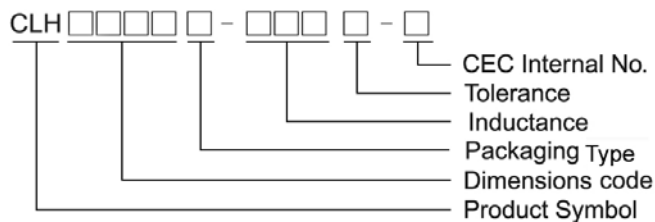
Features

- RoHS compliant
- Excellent Q factor and SRF characteristics
- Small size of 1005/1608 is suitable for small portable devices
- Supports operating frequency up to 6GHz with nominal inductance values from 1.0nH to 470nH.

Applications

- RF resonance and impedance matching circuit
- RF and wireless communication
- Information technology equipment, computers, telecommunications, radar detectors, automotive electronics, cellular phones, pagers, PDAs, keyless remote systems
- L-C filter configurations

Product Identification



- Packing Type: T: Taping B: Bulk
- Product series identification:

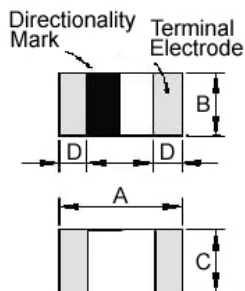
CLH0603-F: Top side half mark.

CLH1005-S: Top side full mark.

CLH1608-S: Top side full mark.

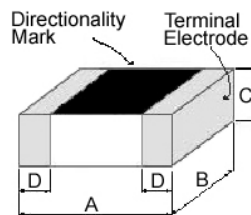
Shape and Dimensions

CLH0603-F Series

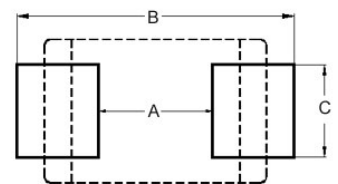


CLH1005-S Series

CLH1608-S Series



Recommended Pattern



Dimensions in mm

| TYPE | A | B | C | D |
|------|----------|----------|----------|-----------|
| 0603 | 0.6±0.03 | 0.3±0.03 | 0.3±0.03 | 0.15±0.05 |
| 1005 | 1.0±0.10 | 0.5±0.10 | 0.5±0.10 | 0.25±0.10 |
| 1608 | 1.6±0.15 | 0.8±0.15 | 0.8±0.15 | 0.3±0.2 |

Dimensions in mm

| TYPE | A | B | C |
|---------|-----------|-------------|-----------|
| CLH0603 | 0.3 | 0.75 ~ 1.05 | 0.3 |
| CLH1005 | 0.4 | 1.2 ~ 1.4 | 0.5 |
| CLH1608 | 0.7 ~ 0.8 | 1.8 ~ 2.0 | 0.6 ~ 0.8 |

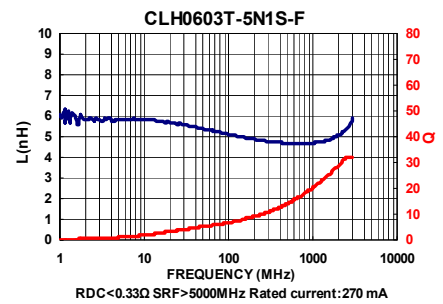
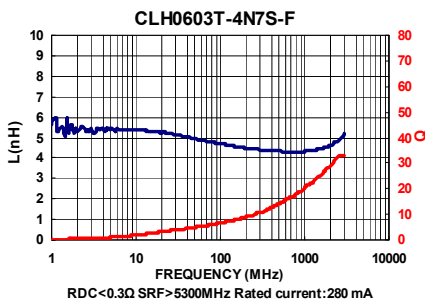
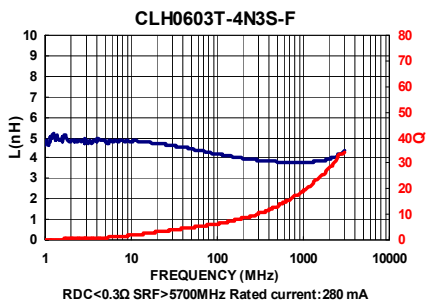
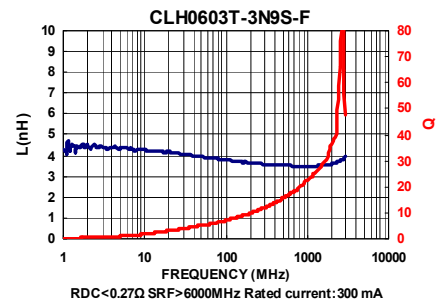
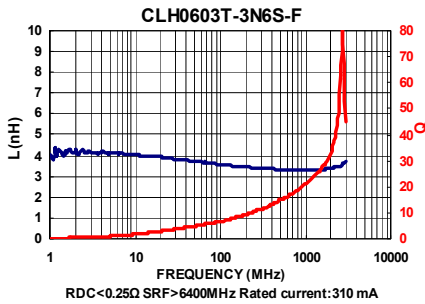
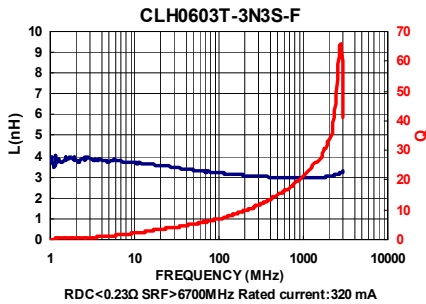
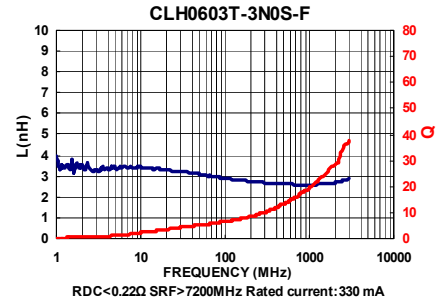
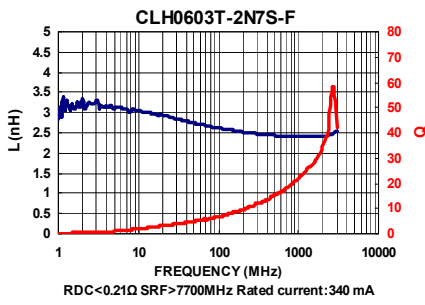
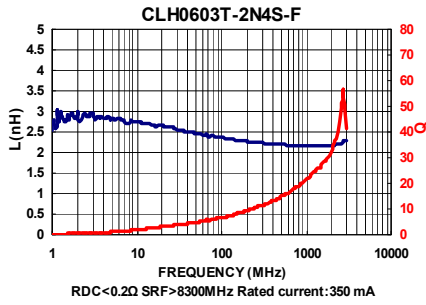
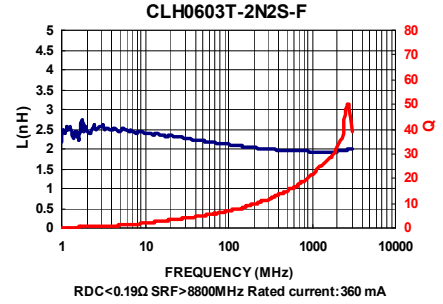
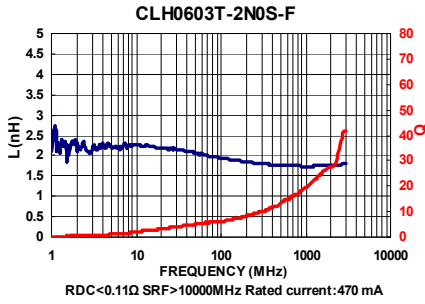
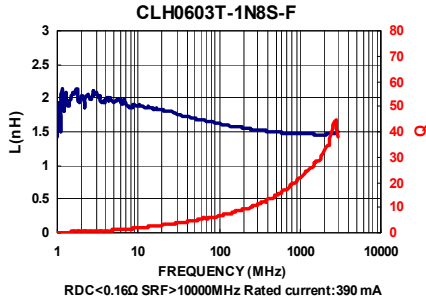
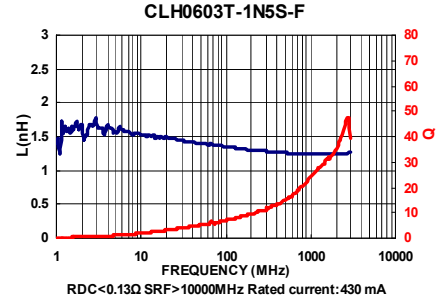
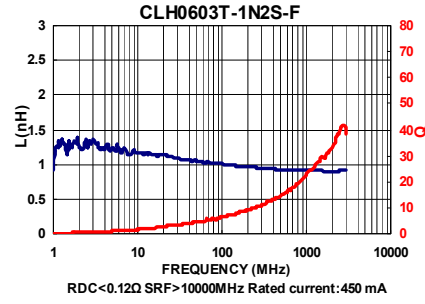
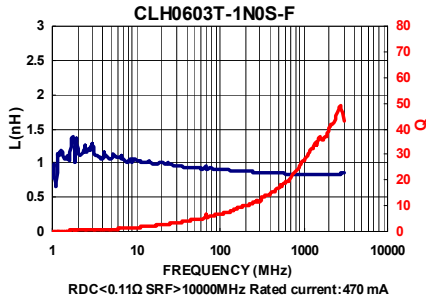
Electrical Characteristics

| Part Number | Inductance (nH) | Tolerance (±%) | Test Frequency (MHz) | Q Min | SRF (MHz) Min | RDC (Ω) Max | Rated Current (mA) Max |
|-----------------|-----------------|----------------|----------------------|-------|---------------|-------------|------------------------|
| CLH0603T-1N0□-F | 1.0 | ±0.3nH | 100 | 4 | >10000 | 0.11 | 470 |
| CLH0603T-1N2□-F | 1.2 | ±0.3nH | 100 | 4 | >10000 | 0.12 | 450 |
| CLH0603T-1N5□-F | 1.5 | ±0.3nH | 100 | 4 | >10000 | 0.13 | 430 |
| CLH0603T-1N8□-F | 1.8 | ±0.3nH | 100 | 4 | >10000 | 0.16 | 390 |
| CLH0603T-2N0□-F | 2.0 | ±0.3nH | 100 | 4 | >10000 | 0.17 | 380 |
| CLH0603T-2N2□-F | 2.2 | ±0.3nH | 100 | 4 | 8800 | 0.19 | 360 |
| CLH0603T-2N4□-F | 2.4 | ±0.3nH | 100 | 4 | 8300 | 0.20 | 350 |
| CLH0603T-2N7□-F | 2.7 | ±0.3nH | 100 | 4 | 7700 | 0.21 | 340 |
| CLH0603T-3N0□-F | 3.0 | ±0.3nH | 100 | 4 | 7200 | 0.22 | 330 |
| CLH0603T-3N3□-F | 3.3 | ±0.3nH | 100 | 4 | 6700 | 0.23 | 320 |
| CLH0603T-3N6□-F | 3.6 | ±0.3nH | 100 | 4 | 6400 | 0.25 | 310 |
| CLH0603T-3N9□-F | 3.9 | ±0.3nH | 100 | 4 | 6000 | 0.27 | 300 |
| CLH0603T-4N3□-F | 4.3 | ±0.3nH | 100 | 4 | 5700 | 0.30 | 280 |
| CLH0603T-4N7□-F | 4.7 | ±0.3nH | 100 | 4 | 5300 | 0.30 | 280 |
| CLH0603T-5N1□-F | 5.1 | ±0.3nH | 100 | 4 | 5000 | 0.33 | 270 |
| CLH0603T-5N6□-F | 5.6 | ±0.3nH | 100 | 4 | 4600 | 0.36 | 260 |
| CLH0603T-6N2□-F | 6.2 | ±0.3nH | 100 | 4 | 4200 | 0.38 | 250 |
| CLH0603T-6N8□-F | 6.8 | 5 | 100 | 4 | 3900 | 0.39 | 250 |
| CLH0603T-7N5□-F | 7.5 | 5 | 100 | 4 | 3600 | 0.41 | 240 |
| CLH0603T-8N2□-F | 8.2 | 5 | 100 | 4 | 3400 | 0.45 | 230 |
| CLH0603T-9N1□-F | 9.1 | 5 | 100 | 4 | 3200 | 0.48 | 220 |
| CLH0603T-10N□-F | 10 | 5 | 100 | 4 | 2900 | 0.51 | 220 |
| CLH0603T-12N□-F | 12 | 5 | 100 | 4 | 2700 | 0.68 | 190 |
| CLH0603T-15N□-F | 15 | 5 | 100 | 4 | 2300 | 0.71 | 180 |
| CLH0603T-18N□-F | 18 | 5 | 100 | 4 | 2100 | 0.81 | 170 |
| CLH0603T-22N□-F | 22 | 5 | 100 | 4 | 1800 | 1.00 | 150 |
| CLH0603T-27N□-F | 27 | 5 | 100 | 4 | 1800 | 1.35 | 120 |
| CLH0603T-33N□-F | 33 | 5 | 100 | 4 | 1700 | 1.47 | 110 |
| CLH0603T-39N□-F | 39 | 5 | 100 | 4 | 1500 | 1.72 | 100 |
| CLH0603T-47N□-F | 47 | 5 | 100 | 4 | 1300 | 1.90 | 100 |
| CLH0603T-56N□-F | 56 | 5 | 100 | 4 | 1100 | 2.27 | 80 |
| CLH0603T-68N□-F | 68 | 5 | 100 | 4 | 1100 | 2.66 | 80 |
| CLH0603T-82N□-F | 82 | 5 | 100 | 4 | 1000 | 3.37 | 70 |
| CLH0603T-R10□-F | 100 | 5 | 100 | 4 | 900 | 3.74 | 60 |

Note: When ordering, please specify tolerance code. Tolerance : S=±0.3nH , J=±5%

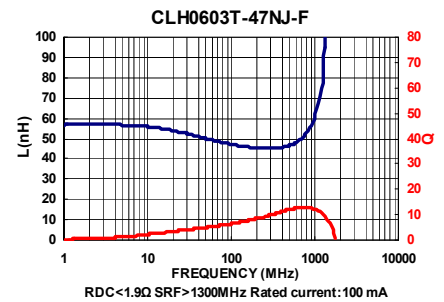
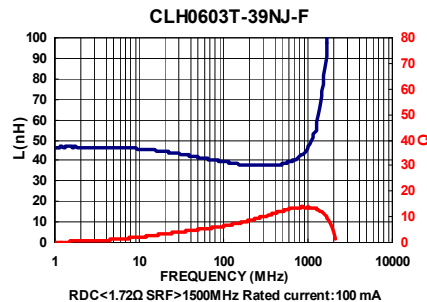
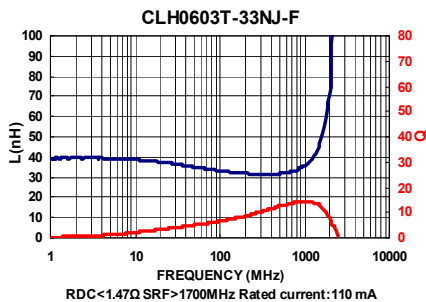
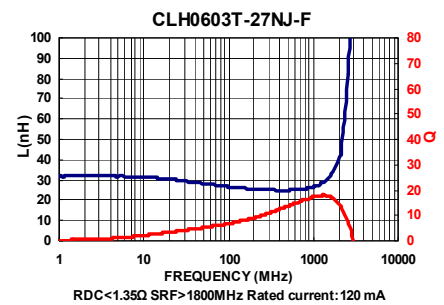
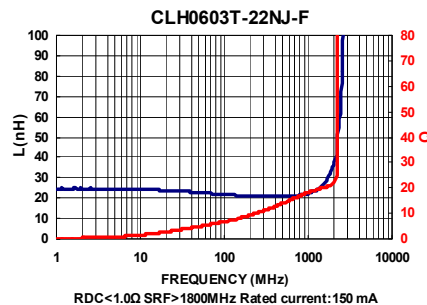
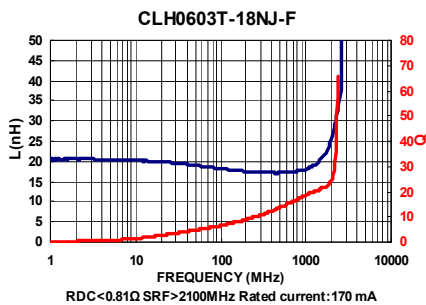
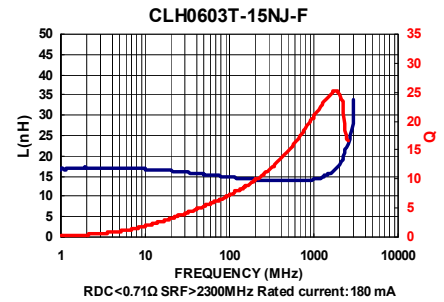
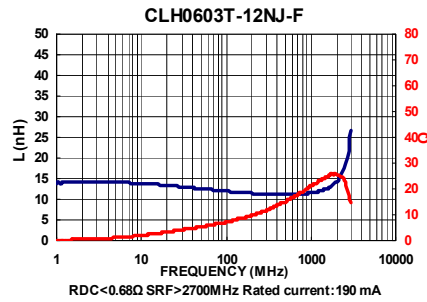
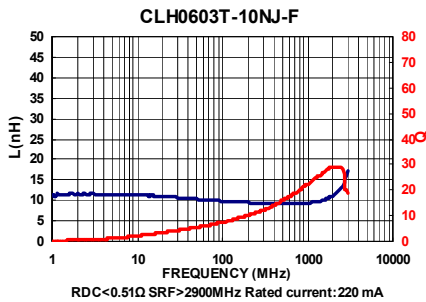
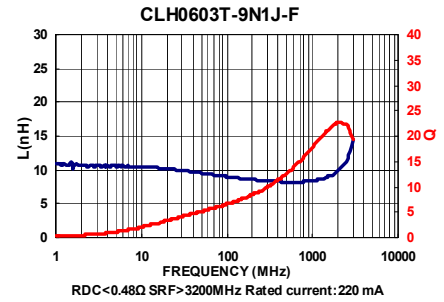
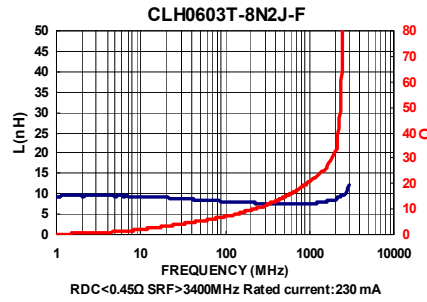
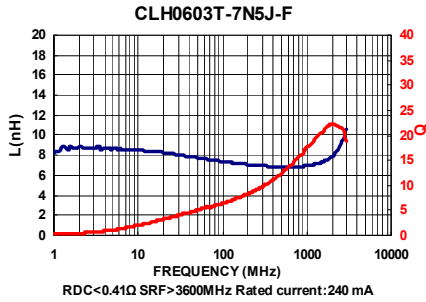
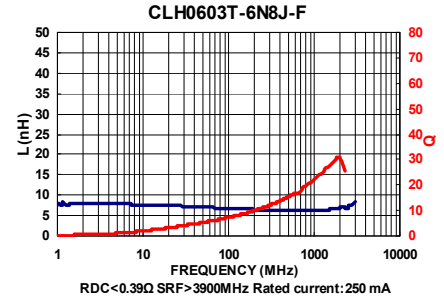
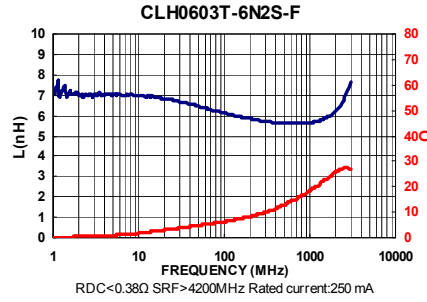
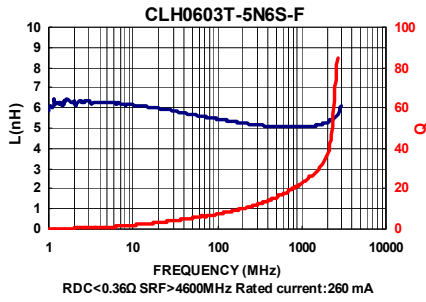
- Operating temperature range - 55°C ~ 125°C(Including self - temperature rise)
- Rate Current :Applied the current to coils, the temperature rise shall not be more than 30°C
- Residual impedance of short chip : 0.19nH
- Measure Equipment :
 - L & Q : Agilent E4991A+Agilent 16197A
 - SRF : Agilent E4991A or HP19196C
 - RDC : HP4338B or CHEN HWA 502

Test Instruments : Agilent E4991A Material/Impedance Analyzer



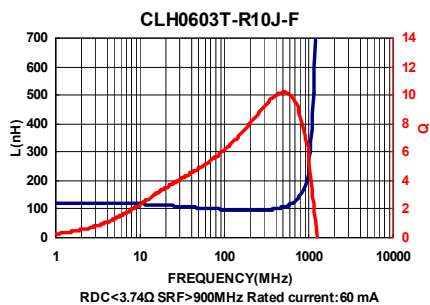
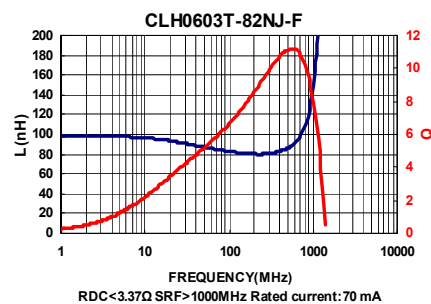
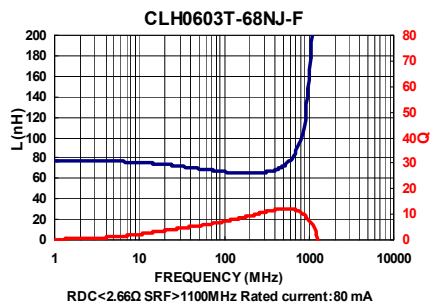
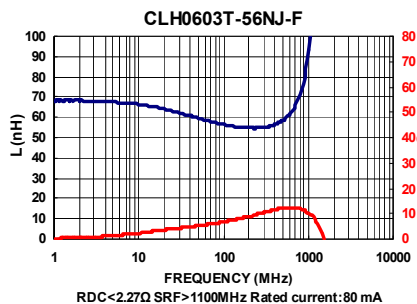
Please be sure to request approval specifications that provide further details of the products. Kindly note that the content of these specifications are subject to change or may be discontinued without advance notice. Please contact our sales department before ordering.

Test Instruments : Agilent E4991A Material/Impedance Analyzer



Please be sure to request approval specifications that provide further details of the products. Kindly note that the content of these specifications are subject to change or may be discontinued without advance notice. Please contact our sales department before ordering.

Test Instruments : Agilent E4991A Material/Impedance Analyzer



Please be sure to request approval specifications that provide further details of the products. Kindly note that the content of these specifications are subject to change or may be discontinued without advance notice. Please contact our sales department before ordering.

Electrical Characteristics

| Part Number | Inductance (nH) | Tolerance (±%) | Test Frequency (MHz) | Q Min | SRF (MHz) Typ. | RDC (Ω) Max | IDC (mA) Max |
|-----------------|-----------------|----------------|----------------------|-------|----------------|-------------|--------------|
| CLH1005T-1N0□-S | 1.0 | ±0.3nH | 100 | 8 | 10000 | 0.07 | 400 |
| CLH1005T-1N1□-S | 1.1 | ±0.3nH | 100 | 8 | 10000 | 0.07 | 400 |
| CLH1005T-1N2□-S | 1.2 | ±0.3nH | 100 | 8 | 10000 | 0.09 | 400 |
| CLH1005T-1N3□-S | 1.3 | ±0.3nH | 100 | 8 | 9000 | 0.10 | 400 |
| CLH1005T-1N5□-S | 1.5 | ±0.3nH | 100 | 8 | 9000 | 0.10 | 400 |
| CLH1005T-1N6□-S | 1.6 | ±0.3nH | 100 | 8 | 8700 | 0.10 | 400 |
| CLH1005T-1N8□-S | 1.8 | ±0.3nH | 100 | 8 | 8700 | 0.10 | 400 |
| CLH1005T-2N0□-S | 2.0 | ±0.3nH | 100 | 8 | 8100 | 0.10 | 400 |
| CLH1005T-2N2□-S | 2.2 | ±0.3nH | 100 | 8 | 8100 | 0.12 | 400 |
| CLH1005T-2N4□-S | 2.4 | ±0.3nH | 100 | 8 | 7700 | 0.15 | 400 |
| CLH1005T-2N7□-S | 2.7 | ±0.3nH | 100 | 8 | 7700 | 0.15 | 400 |
| CLH1005T-3N0□-S | 3.0 | ±0.3nH | 100 | 8 | 6300 | 0.15 | 400 |
| CLH1005T-3N3□-S | 3.3 | ±0.3nH/10 | 100 | 8 | 6300 | 0.15 | 400 |
| CLH1005T-3N6□-S | 3.6 | ±0.3nH/10 | 100 | 8 | 6100 | 0.15 | 400 |
| CLH1005T-3N9□-S | 3.9 | ±0.3nH/10 | 100 | 8 | 6100 | 0.18 | 400 |
| CLH1005T-4N3□-S | 4.3 | ±0.3nH/10 | 100 | 8 | 6000 | 0.18 | 400 |
| CLH1005T-4N7□-S | 4.7 | ±0.3nH/10 | 100 | 8 | 6000 | 0.18 | 400 |
| CLH1005T-5N0□-S | 5.0 | ±0.3nH/10 | 100 | 8 | 5100 | 0.20 | 400 |
| CLH1005T-5N1□-S | 5.1 | ±0.3nH/10 | 100 | 8 | 5300 | 0.20 | 400 |
| CLH1005T-5N6□-S | 5.6 | ±0.3nH/10 | 100 | 8 | 5100 | 0.20 | 400 |
| CLH1005T-6N8□-S | 6.8 | 5 / 10 | 100 | 8 | 4550 | 0.24 | 400 |
| CLH1005T-8N0□-S | 8.0 | 5 / 10 | 100 | 8 | 4100 | 0.30 | 300 |
| CLH1005T-8N2□-S | 8.2 | 5 / 10 | 100 | 8 | 4100 | 0.24 | 300 |
| CLH1005T-9N1□-S | 9.1 | 5 / 10 | 100 | 8 | 3900 | 0.26 | 300 |
| CLH1005T-10N□-S | 10 | 5 / 10 | 100 | 8 | 3900 | 0.26 | 300 |
| CLH1005T-12N□-S | 12 | 5 / 10 | 100 | 8 | 3000 | 0.40 | 300 |
| CLH1005T-15N□-S | 15 | 5 / 10 | 100 | 8 | 2800 | 0.50 | 300 |
| CLH1005T-18N□-S | 18 | 5 / 10 | 100 | 8 | 2500 | 0.55 | 300 |
| CLH1005T-22N□-S | 22 | 5 / 10 | 100 | 8 | 2200 | 0.70 | 300 |
| CLH1005T-24N□-S | 24 | 5 / 10 | 100 | 8 | 2100 | 0.70 | 300 |
| CLH1005T-27N□-S | 27 | 5 / 10 | 100 | 8 | 2000 | 0.80 | 300 |
| CLH1005T-33N□-S | 33 | 5 / 10 | 100 | 8 | 1800 | 0.9 | 200 |
| CLH1005T-39N□-S | 39 | 5 / 10 | 100 | 8 | 1600 | 1.0 | 150 |
| CLH1005T-47N□-S | 47 | 5 / 10 | 100 | 8 | 1400 | 1.2 | 150 |
| CLH1005T-56N□-S | 56 | 5 / 10 | 100 | 8 | 1300 | 1.3 | 150 |
| CLH1005T-68N□-S | 68 | 5 / 10 | 100 | 8 | 1100 | 1.5 | 100 |

Note: When ordering, please specify tolerance code. Tolerance : S=±0.3nH , J=±5% , K=±10%

- Operating temperature range - 55°C ~ 125°C(Including self - temperature rise)
- IDC : Applied the current to coils, the inductance shall be less than 10% initial value
- Measure Equipment :
 L & Q : Agilent E4991A+Agilent 16197A
 SRF : HP8753D
 RDC : HP4338B or CHEN HWA 502

Please be sure to request approval specifications that provide further details of the products. Kindly note that the content of these specifications are subject to change or may be discontinued without advance notice. Please contact our sales department before ordering.

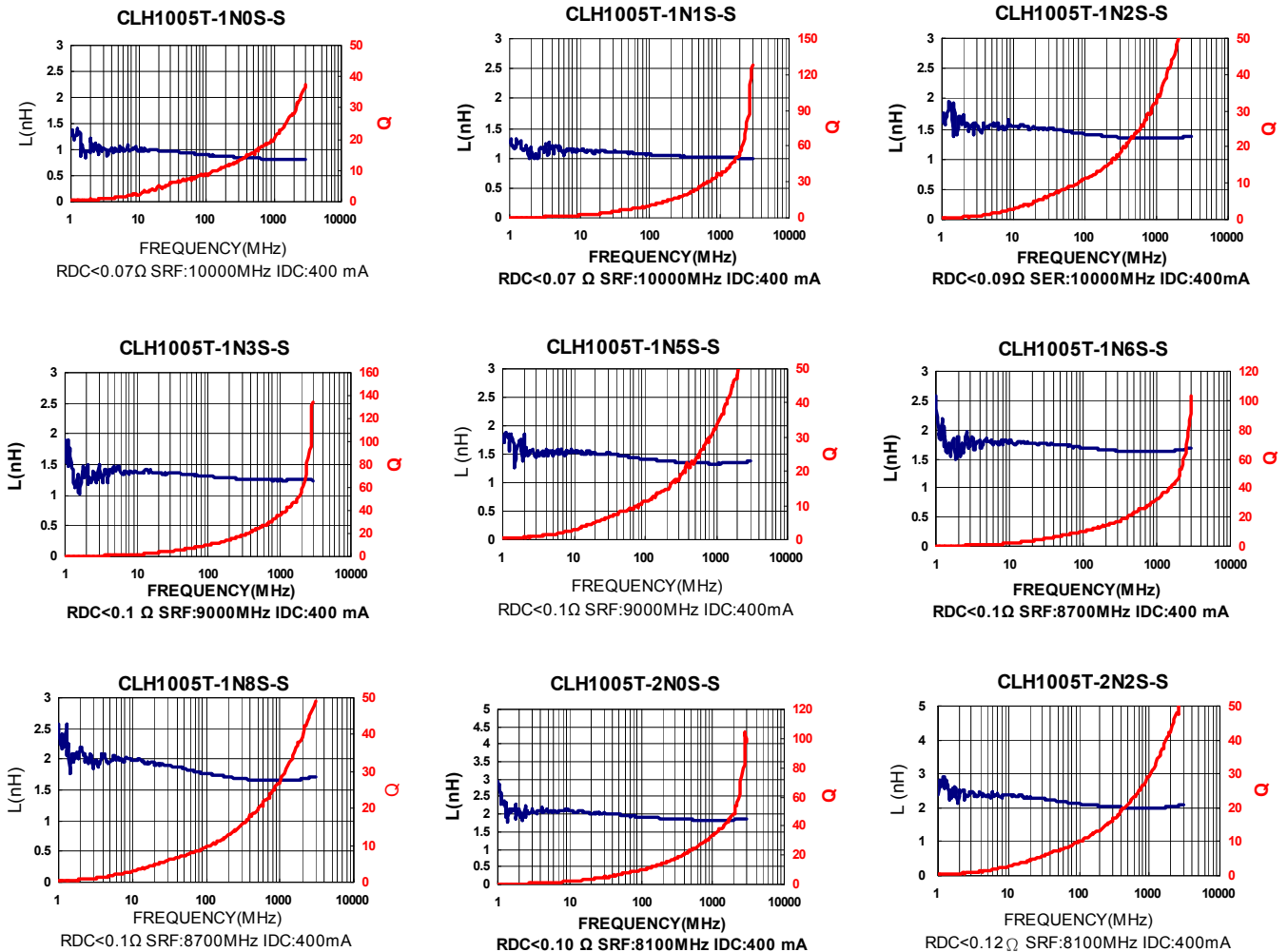
Electrical Characteristics

| Part Number | Inductance (nH) | Tolerance (±%) | Test Frequency (MHz) | Q Min | SRF (MHz) Typ. | RDC (Ω) Max | IDC (mA) Max |
|-----------------|-----------------|----------------|----------------------|-------|----------------|-------------|--------------|
| CLH1005T-75N□-S | 75 | 5 / 10 | 100 | 8 | 1080 | 1.5 | 100 |
| CLH1005T-82N□-S | 82 | 5 / 10 | 100 | 8 | 1000 | 1.6 | 100 |
| CLH1005T-R10□-S | 100 | 5 / 10 | 100 | 8 | 900 | 2.0 | 100 |
| CLH1005T-R12□-S | 120 | 5 / 10 | 100 | 8 | 800 | 2.2 | 100 |
| CLH1005T-R15□-S | 150 | 5 / 10 | 100 | 8 | 700 | 3.5 | 100 |
| CLH1005T-R18□-S | 180 | 5 / 10 | 100 | 8 | 600 | 3.8 | 100 |
| CLH1005T-R22□-S | 220 | 5 / 10 | 100 | 8 | 500 | 4.2 | 100 |
| CLH1005T-R27□-S | 270 | 5 / 10 | 100 | 8 | 500 | 4.8 | 100 |

Note: When ordering, please specify tolerance code. Tolerance : S=±0.3nH , J=±5% , K=±10%

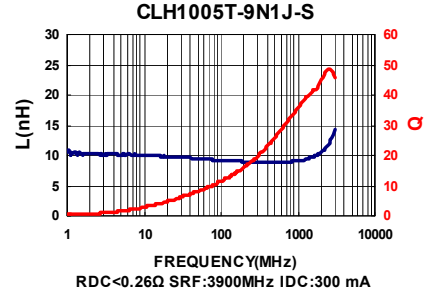
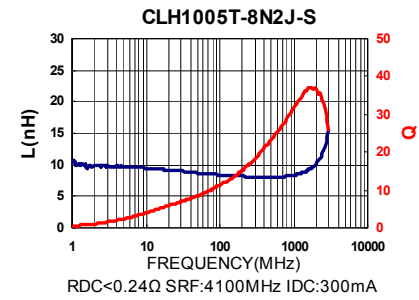
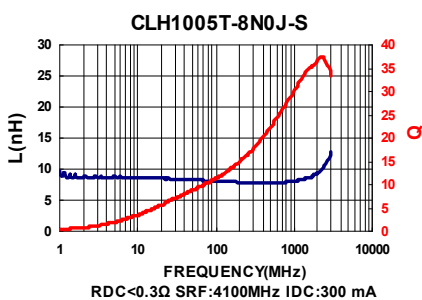
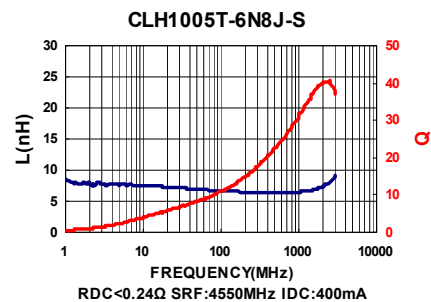
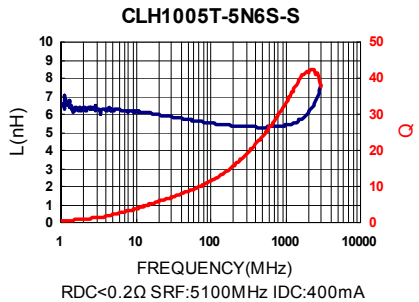
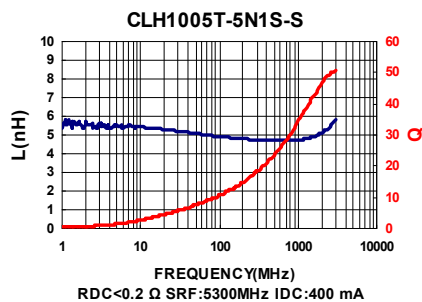
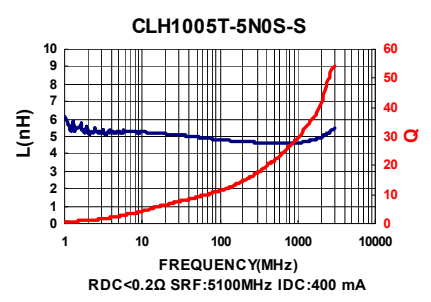
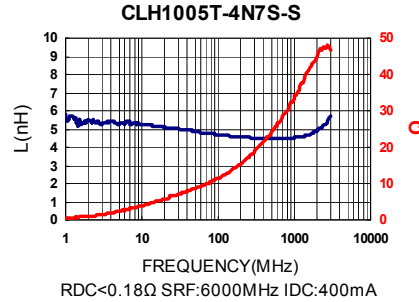
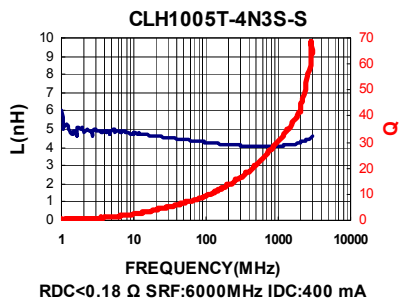
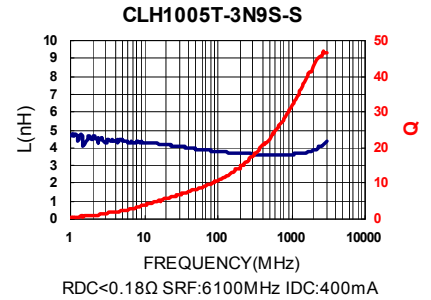
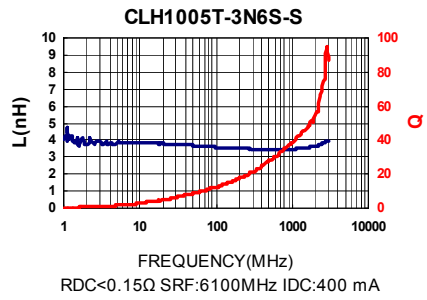
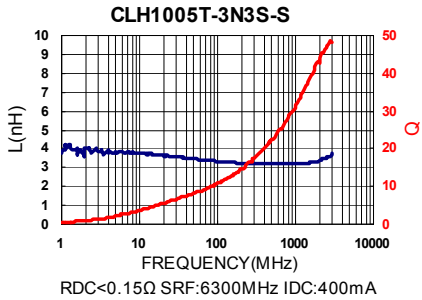
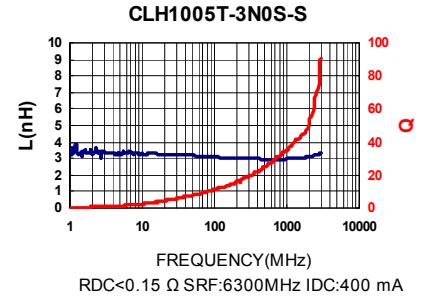
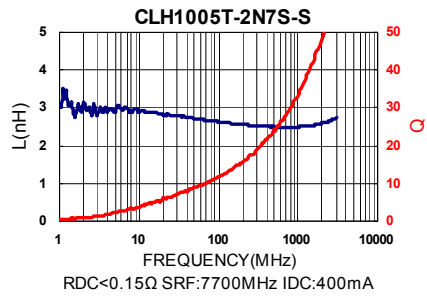
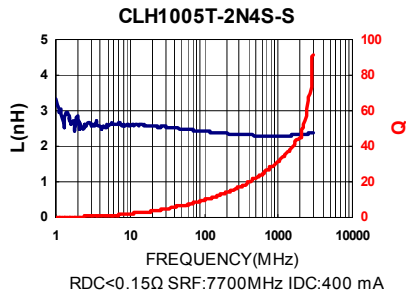
- Operating temperature range - 55°C ~ 125°C(Including self - temperature rise)
- IDC : Applied the current to coils, the inductance shall be less than 10% initial value
- Measure Equipment :
 L & Q : Agilent E4991A+Agilent 16197A
 SRF : HP8753D
 RDC : HP4338B or CHEN HWA 502

Test Instruments : Agilent E4991A Material/Impedance Analyzer



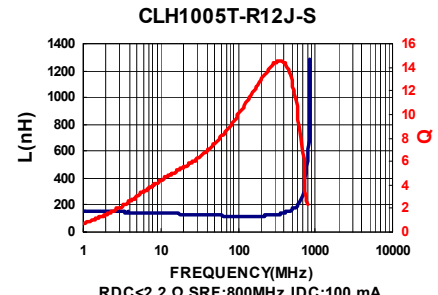
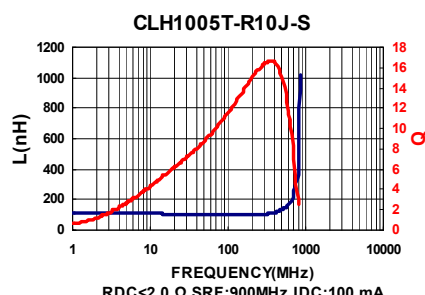
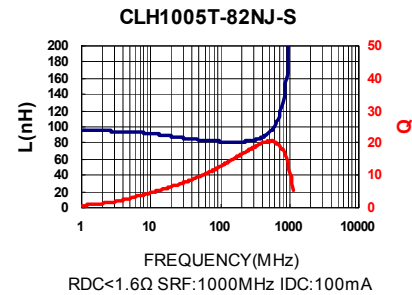
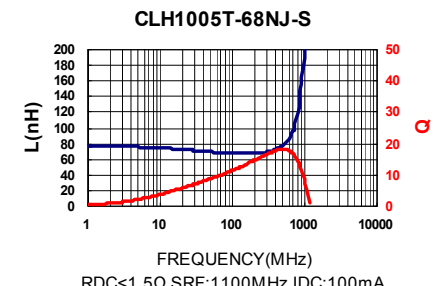
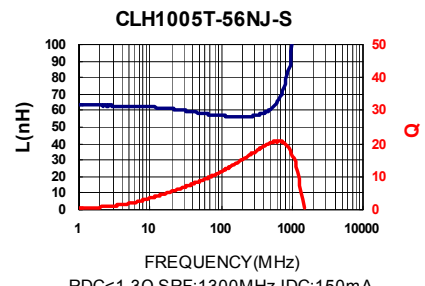
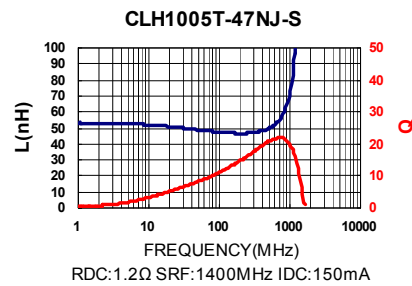
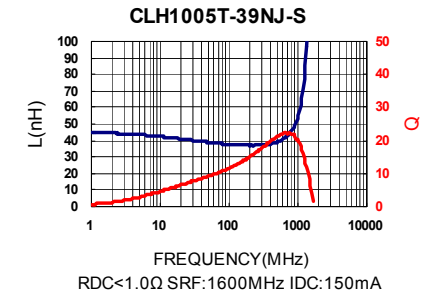
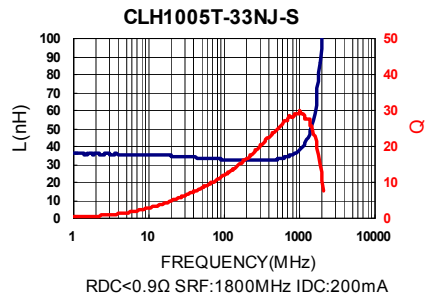
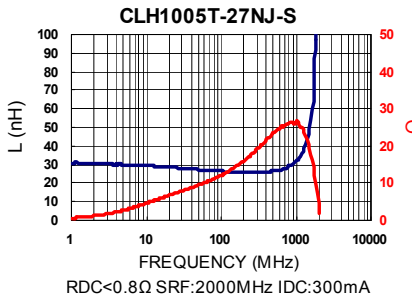
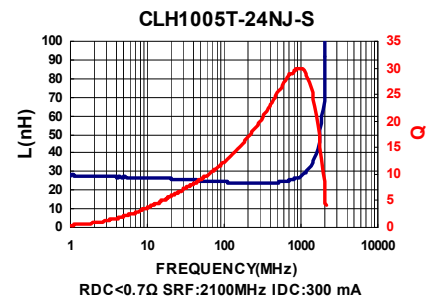
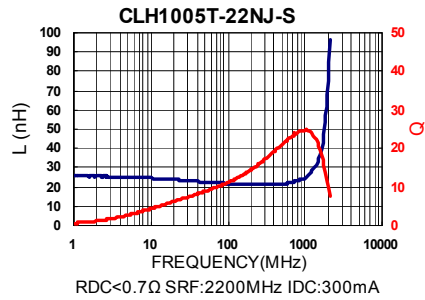
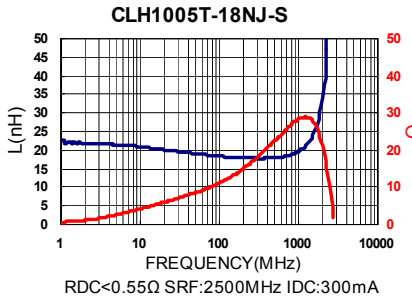
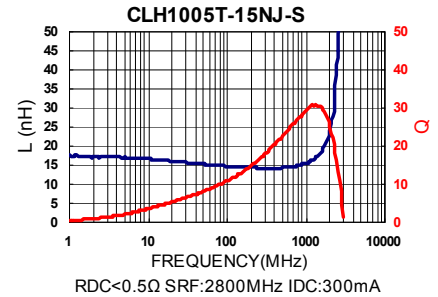
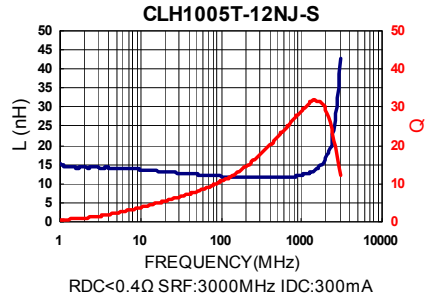
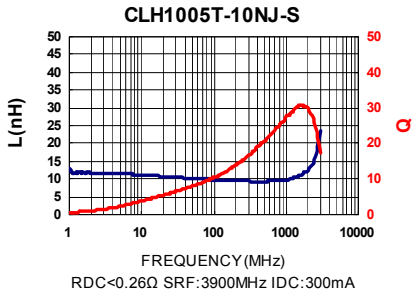
Please be sure to request approval specifications that provide further details of the products. Kindly note that the content of these specifications are subject to change or may be discontinued without advance notice. Please contact our sales department before ordering.

Test Instruments : Agilent E4991A Material/Impedance Analyzer



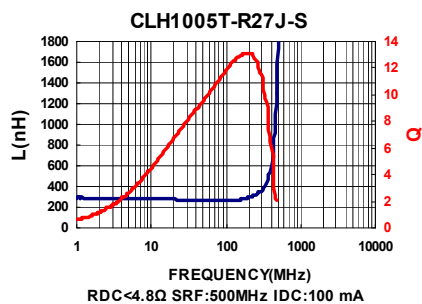
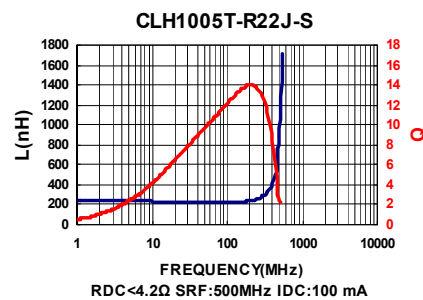
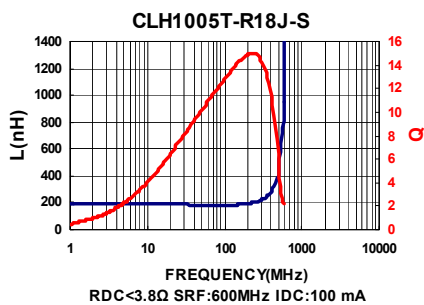
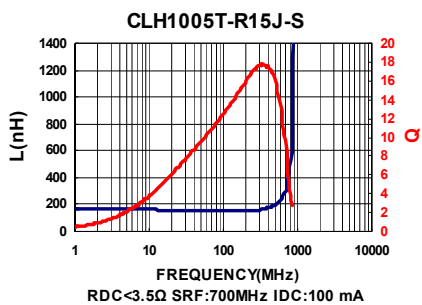
Please be sure to request approval specifications that provide further details of the products. Kindly note that the content of these specifications are subject to change or may be discontinued without advance notice. Please contact our sales department before ordering.

Test Instruments : Agilent E4991A Material/Impedance Analyzer



Please be sure to request approval specifications that provide further details of the products. Kindly note that the content of these specifications are subject to change or may be discontinued without advance notice. Please contact our sales department before ordering.

Test Instruments : Agilent E4991A Material/Impedance Analyzer



Please be sure to request approval specifications that provide further details of the products. Kindly note that the content of these specifications are subject to change or may be discontinued without advance notice. Please contact our sales department before ordering.

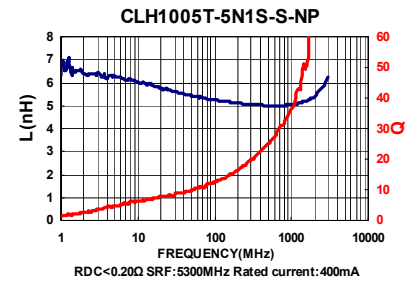
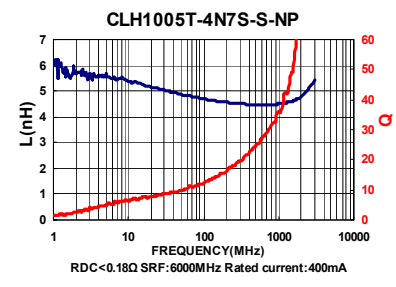
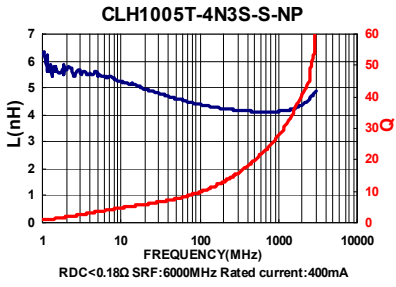
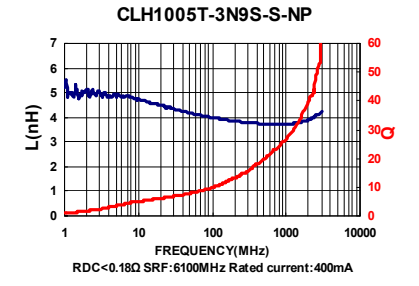
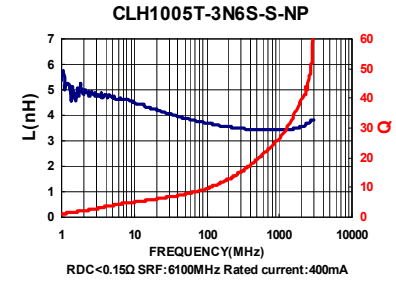
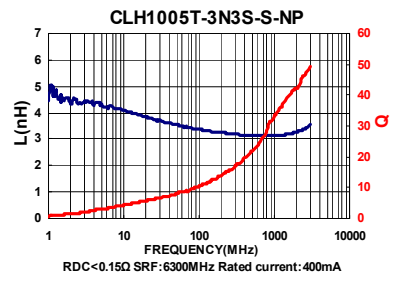
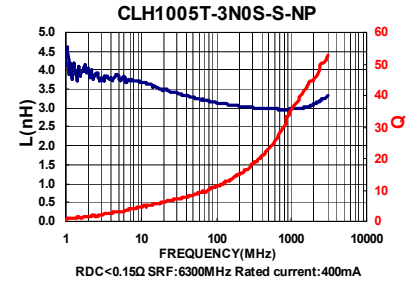
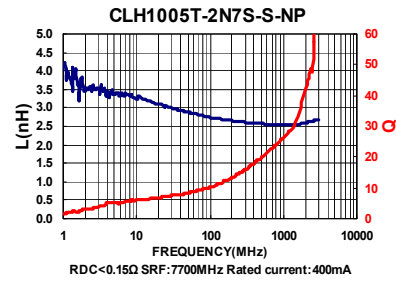
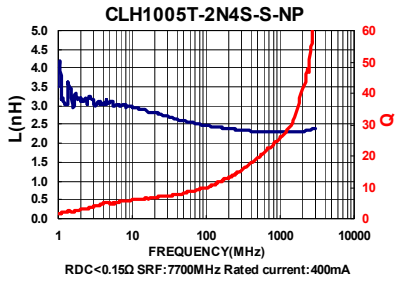
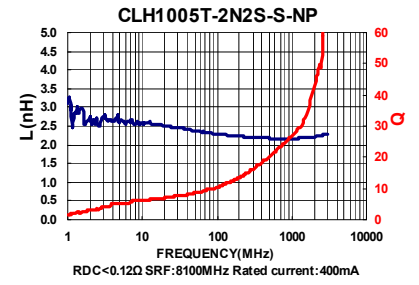
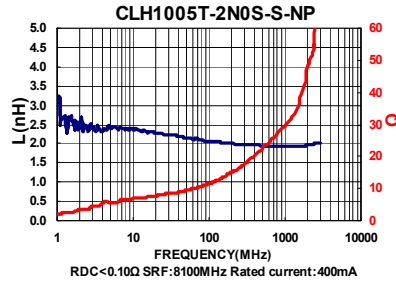
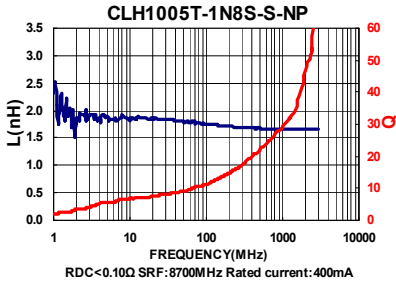
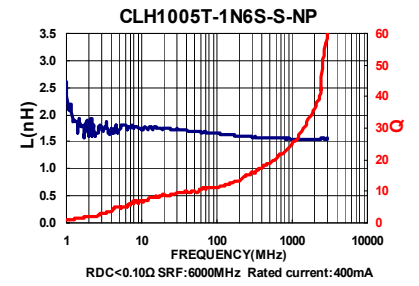
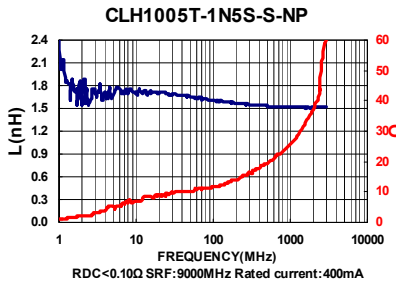
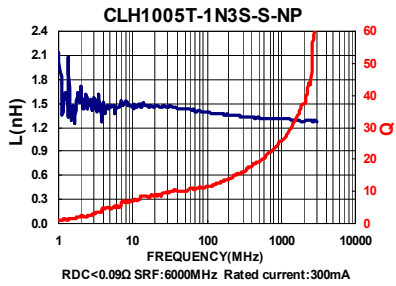
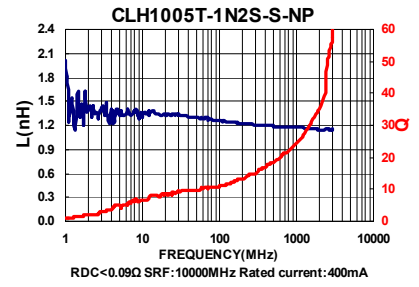
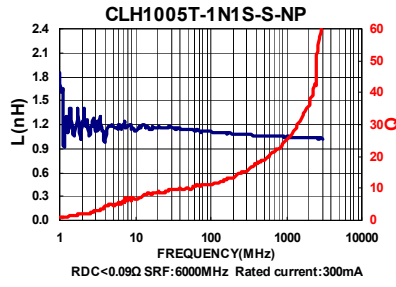
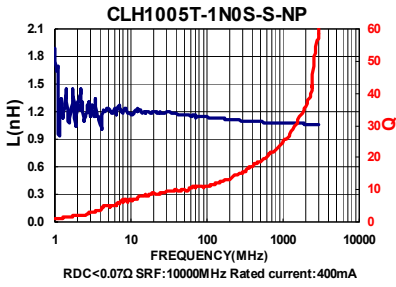
Electrical Characteristics

| Part Number | Inductance (nH) | Tolerance (±%) | Test Frequency (MHz) | Q Min | SRF (MHz) Typ. | RDC (Ω) Max | Rated Current (mA) Max |
|--------------------|-----------------|----------------|----------------------|-------|----------------|-------------|------------------------|
| CLH1005T-1N0□-S-NP | 1.0 | ±0.2nH/±0.3nH | 100 | 8 | 10000 | 0.07 | 400 |
| CLH1005T-1N1□-S-NP | 1.1 | ±0.3nH | 100 | 8 | 6000 | 0.09 | 300 |
| CLH1005T-1N2□-S-NP | 1.2 | ±0.2nH/±0.3nH | 100 | 8 | 10000 | 0.09 | 400 |
| CLH1005T-1N3□-S-NP | 1.3 | ±0.3nH | 100 | 8 | 6000 | 0.09 | 300 |
| CLH1005T-1N5□-S-NP | 1.5 | ±0.3nH | 100 | 8 | 9000 | 0.10 | 400 |
| CLH1005T-1N6□-S-NP | 1.6 | ±0.3nH | 100 | 8 | 6000 | 0.10 | 400 |
| CLH1005T-1N8□-S-NP | 1.8 | ±0.3nH | 100 | 8 | 8700 | 0.10 | 400 |
| CLH1005T-2N0□-S-NP | 2.0 | ±0.3nH | 100 | 8 | 8100 | 0.10 | 400 |
| CLH1005T-2N2□-S-NP | 2.2 | ±0.3nH | 100 | 8 | 8100 | 0.12 | 400 |
| CLH1005T-2N4□-S-NP | 2.4 | ±0.3nH | 100 | 8 | 7700 | 0.15 | 400 |
| CLH1005T-2N7□-S-NP | 2.7 | ±0.3nH | 100 | 8 | 7700 | 0.15 | 400 |
| CLH1005T-3N0□-S-NP | 3.0 | ±0.3nH | 100 | 8 | 6300 | 0.15 | 400 |
| CLH1005T-3N3□-S-NP | 3.3 | ±0.3nH | 100 | 8 | 6300 | 0.15 | 400 |
| CLH1005T-3N6□-S-NP | 3.6 | ±0.3nH | 100 | 8 | 6100 | 0.15 | 400 |
| CLH1005T-3N9□-S-NP | 3.9 | ±0.3nH | 100 | 8 | 6100 | 0.18 | 400 |
| CLH1005T-4N3□-S-NP | 4.3 | ±0.3nH | 100 | 8 | 6000 | 0.18 | 400 |
| CLH1005T-4N7□-S-NP | 4.7 | ±0.3nH | 100 | 8 | 6000 | 0.18 | 400 |
| CLH1005T-5N1□-S-NP | 5.1 | ±0.3nH | 100 | 8 | 5300 | 0.20 | 400 |
| CLH1005T-5N6□-S-NP | 5.6 | ±0.3nH | 100 | 8 | 5100 | 0.20 | 400 |
| CLH1005T-6N2□-S-NP | 6.2 | ±0.3nH/5/10 | 100 | 8 | 4500 | 0.22 | 400 |
| CLH1005T-6N8□-S-NP | 6.8 | 5 / 10 | 100 | 8 | 4550 | 0.24 | 400 |
| CLH1005T-7N5□-S-NP | 7.5 | 5 / 10 | 100 | 8 | 4200 | 0.24 | 300 |
| CLH1005T-8N2□-S-NP | 8.2 | 5 / 10 | 100 | 8 | 4100 | 0.24 | 300 |
| CLH1005T-9N1□-S-NP | 9.1 | 5 / 10 | 100 | 8 | 3900 | 0.26 | 300 |
| CLH1005T-10N□-S-NP | 10 | 5 / 10 | 100 | 8 | 3900 | 0.26 | 300 |
| CLH1005T-12N□-S-NP | 12 | 5 / 10 | 100 | 8 | 3000 | 0.28 | 300 |
| CLH1005T-15N□-S-NP | 15 | 5 / 10 | 100 | 8 | 2500 | 0.32 | 300 |
| CLH1005T-18N□-S-NP | 18 | 5 / 10 | 100 | 8 | 2200 | 0.36 | 300 |
| CLH1005T-22N□-S-NP | 22 | 5 / 10 | 100 | 8 | 1900 | 0.42 | 300 |
| CLH1005T-27N□-S-NP | 27 | 5 / 10 | 100 | 8 | 1700 | 0.46 | 300 |
| CLH1005T-33N□-S-NP | 33 | 5 / 10 | 100 | 8 | 1600 | 0.58 | 200 |
| CLH1005T-39N□-S-NP | 39 | 5 / 10 | 100 | 8 | 1200 | 0.65 | 200 |
| CLH1005T-47N□-S-NP | 47 | 5 / 10 | 100 | 8 | 1000 | 0.72 | 200 |
| CLH1005T-56N□-S-NP | 56 | 5 / 10 | 100 | 8 | 800 | 0.82 | 200 |
| CLH1005T-68N□-S-NP | 68 | 5 / 10 | 100 | 8 | 800 | 0.92 | 180 |
| CLH1005T-82N□-S-NP | 82 | 5 / 10 | 100 | 8 | 700 | 1.20 | 150 |

Note: When ordering, please specify tolerance code. Tolerance : C=±0.2nH , S=±0.3nH , J=±5% , K=±10%

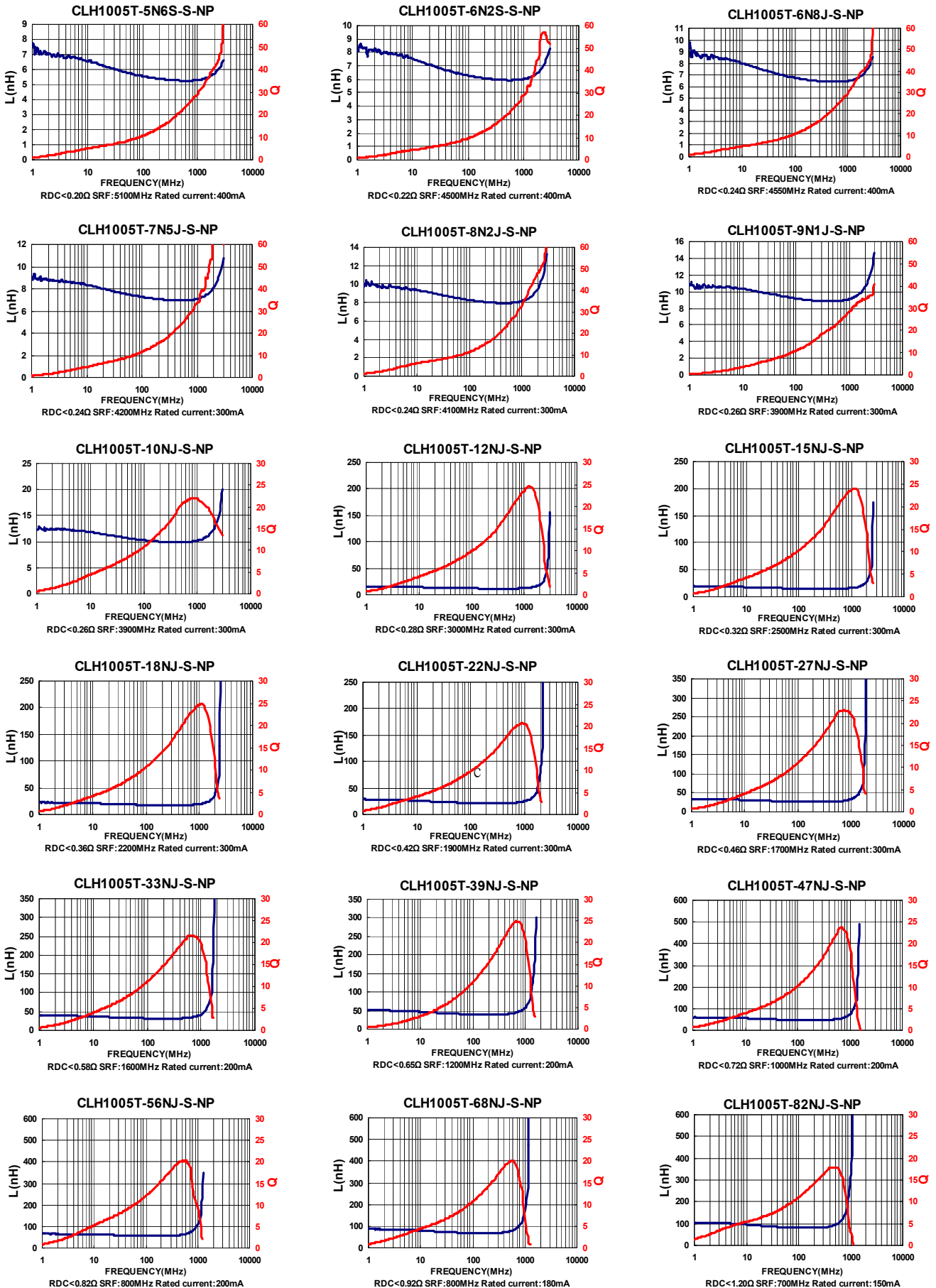
- Operating temperature range - 55°C ~ 125°C(Including self - temperature rise)
- Rate Current : Applied the current to coils, the temperature rise shall not be more than 30°C
- Measure Equipment :
L & Q : Agilent E4991A+Agilent 16197A
SRF : HP8753D
RDC : HP4338B or CHEN HWA 502

Test Instruments : Agilent E4991A Material/Impedance Analyzer



Please be sure to request approval specifications that provide further details of the products. Kindly note that the content of these specifications are subject to change or may be discontinued without advance notice. Please contact our sales department before ordering.

Test Instruments : Agilent E4991A Material/Impedance Analyzer



Please be sure to request approval specifications that provide further details of the products. Kindly note that the content of these specifications are subject to change or may be discontinued without advance notice. Please contact our sales department before ordering.

Electrical Characteristics

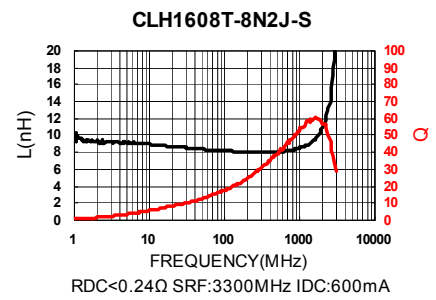
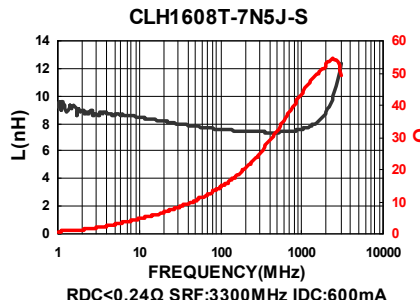
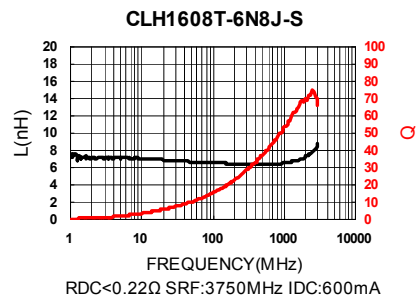
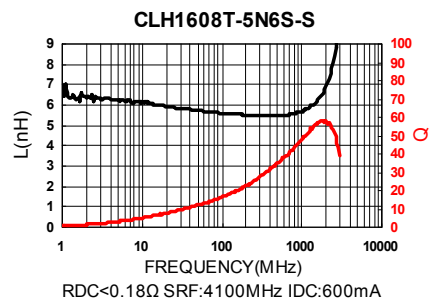
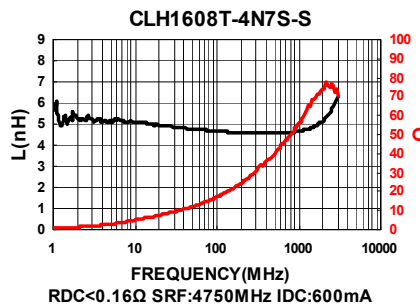
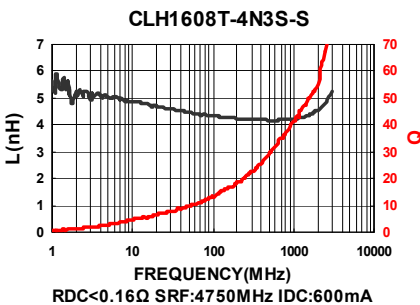
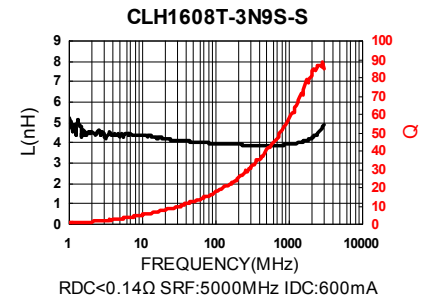
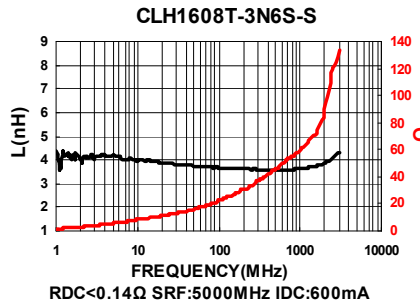
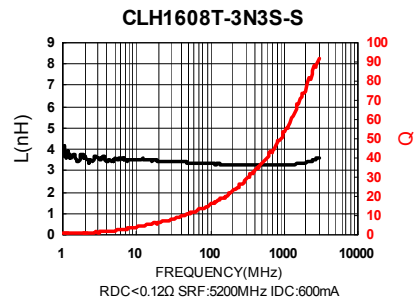
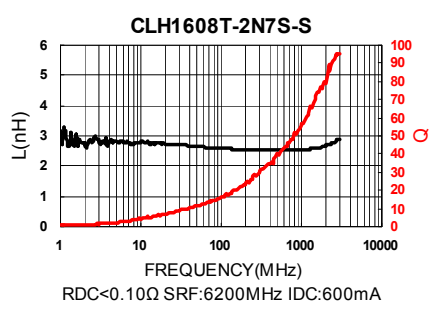
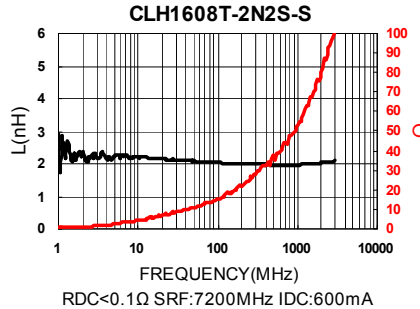
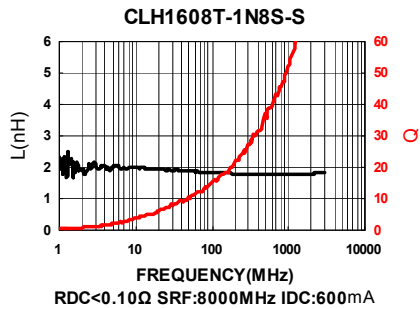
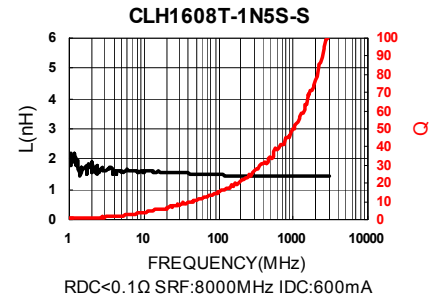
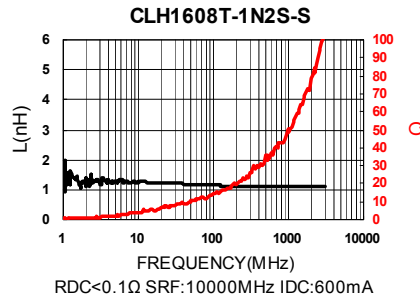
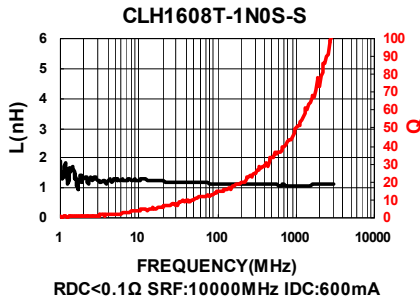
| Part Number | Inductance (nH) | Tolerance (±%) | Test Frequency (MHz) | Q Min | SRF (MHz) Typ. | RDC (Ω) Max | IDC (mA) Max |
|-----------------|-----------------|----------------|----------------------|-------|----------------|-------------|--------------|
| CLH1608T-1N0S-S | 1.0 | ±0.3nH | 100 | 8 | 10000 | 0.10 | 600 |
| CLH1608T-1N2S-S | 1.2 | ±0.3nH | 100 | 8 | 10000 | 0.10 | 600 |
| CLH1608T-1N5S-S | 1.5 | ±0.3nH | 100 | 8 | 8000 | 0.10 | 600 |
| CLH1608T-1N6S-S | 1.6 | ±0.3nH | 100 | 8 | 8000 | 0.10 | 600 |
| CLH1608T-1N8S-S | 1.8 | ±0.3nH | 100 | 8 | 8000 | 0.10 | 600 |
| CLH1608T-2N2S-S | 2.2 | ±0.3nH | 100 | 8 | 7200 | 0.10 | 600 |
| CLH1608T-2N7S-S | 2.7 | ±0.3nH | 100 | 10 | 6200 | 0.10 | 600 |
| CLH1608T-3N0S-S | 3.0 | ±0.3nH | 100 | 10 | 5200 | 0.12 | 600 |
| CLH1608T-3N3□-S | 3.3 | ±0.3nH/10 | 100 | 10 | 5200 | 0.12 | 600 |
| CLH1608T-3N6S-S | 3.6 | ±0.3nH | 100 | 10 | 5000 | 0.14 | 600 |
| CLH1608T-3N9□-S | 3.9 | ±0.3nH/10 | 100 | 10 | 5000 | 0.14 | 600 |
| CLH1608T-4N3□-S | 4.3 | ±0.3nH/10 | 100 | 10 | 4750 | 0.16 | 600 |
| CLH1608T-4N7□-S | 4.7 | ±0.3nH /10 | 100 | 10 | 4750 | 0.16 | 600 |
| CLH1608T-5N1□-S | 5.1 | ±0.3nH /10 | 100 | 10 | 4100 | 0.18 | 600 |
| CLH1608T-5N6□-S | 5.6 | ±0.3nH/10 | 100 | 10 | 4100 | 0.18 | 600 |
| CLH1608T-6N2□-S | 6.2 | 5 / 10 | 100 | 10 | 3750 | 0.22 | 600 |
| CLH1608T-6N8□-S | 6.8 | 5 / 10 | 100 | 10 | 3750 | 0.22 | 600 |
| CLH1608T-7N5□-S | 7.5 | 5 / 10 | 100 | 10 | 3300 | 0.24 | 600 |
| CLH1608T-8N2□-S | 8.2 | 5 / 10 | 100 | 10 | 3300 | 0.24 | 600 |
| CLH1608T-10N□-S | 10 | 5 / 10 | 100 | 12 | 3000 | 0.26 | 600 |
| CLH1608T-12N□-S | 12 | 5 / 10 | 100 | 12 | 2600 | 0.28 | 600 |
| CLH1608T-15N□-S | 15 | 5 / 10 | 100 | 12 | 2500 | 0.32 | 600 |
| CLH1608T-16N□-S | 16 | 5 / 10 | 100 | 12 | 2400 | 0.35 | 600 |
| CLH1608T-18N□-S | 18 | 5 / 10 | 100 | 12 | 2400 | 0.35 | 600 |
| CLH1608T-22N□-S | 22 | 5 / 10 | 100 | 12 | 2000 | 0.40 | 500 |
| CLH1608T-27N□-S | 27 | 5 / 10 | 100 | 12 | 1900 | 0.45 | 500 |
| CLH1608T-33N□-S | 33 | 5 / 10 | 100 | 12 | 1600 | 0.55 | 400 |
| CLH1608T-39N□-S | 39 | 5 / 10 | 100 | 12 | 1400 | 0.60 | 400 |
| CLH1608T-47N□-S | 47 | 5 / 10 | 100 | 12 | 1300 | 0.70 | 400 |
| CLH1608T-56N□-S | 56 | 5 / 10 | 100 | 12 | 1100 | 0.75 | 400 |
| CLH1608T-62N□-S | 62 | 5 / 10 | 100 | 12 | 1050 | 0.85 | 400 |
| CLH1608T-68N□-S | 68 | 5 / 10 | 100 | 12 | 1050 | 0.85 | 400 |
| CLH1608T-75N□-S | 75 | 5 / 10 | 100 | 12 | 900 | 1.00 | 300 |
| CLH1608T-82N□-S | 82 | 5 / 10 | 100 | 12 | 900 | 1.00 | 300 |
| CLH1608T-R10□-S | 100 | 5 / 10 | 100 | 12 | 770 | 1.20 | 300 |
| CLH1608T-R12□-S | 120 | 5 / 10 | 50 | 8 | 650 | 1.30 | 300 |
| CLH1608T-R15□-S | 150 | 5 / 10 | 50 | 8 | 550 | 1.70 | 250 |
| CLH1608T-R18□-S | 180 | 5 / 10 | 50 | 8 | 520 | 1.90 | 250 |
| CLH1608T-R22□-S | 220 | 5 / 10 | 50 | 8 | 500 | 2.00 | 250 |
| CLH1608T-R27□-S | 270 | 5 / 10 | 50 | 8 | 470 | 2.20 | 150 |
| CLH1608T-R33□-S | 330 | 5 / 10 | 50 | 8 | 320 | 2.80 | 100 |
| CLH1608T-R39□-S | 390 | 5 / 10 | 50 | 8 | 300 | 3.00 | 100 |

Note: When ordering, please specify tolerance code. Tolerance : S=±0.3nH , J=±5% , K=±10%

- Operating temperature range - 55°C ~ 125°C(Including self - temperature rise)
- IDC : Applied the current to coils, the inductance shall be less than 10% initial value
- Measure Equipment :
 L & Q : Agilent E4991A+Agilent 16197A
 SRF : HP8753D
 RDC : HP4338B or CHEN HWA 502

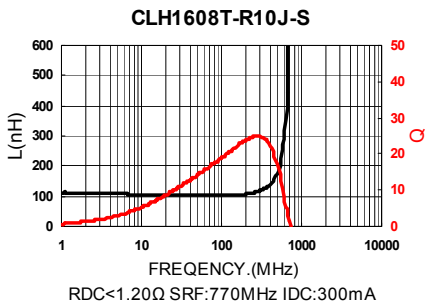
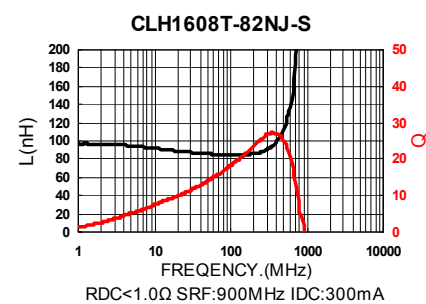
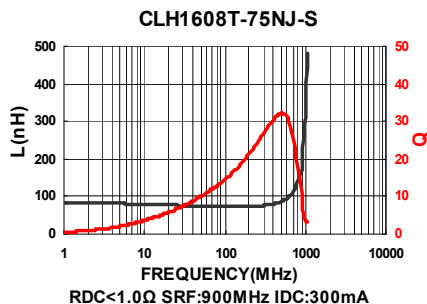
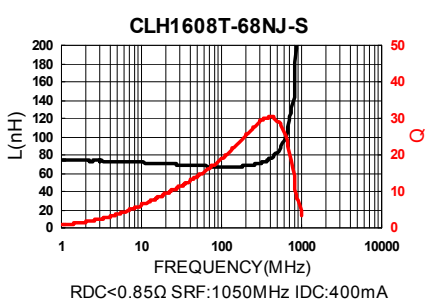
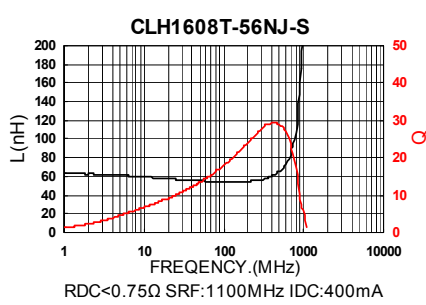
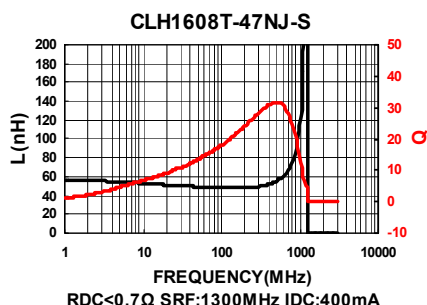
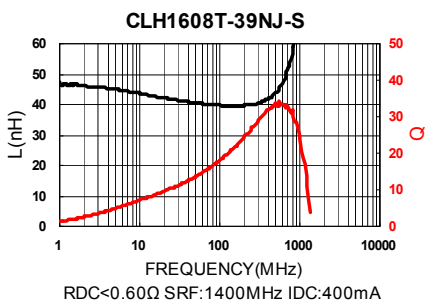
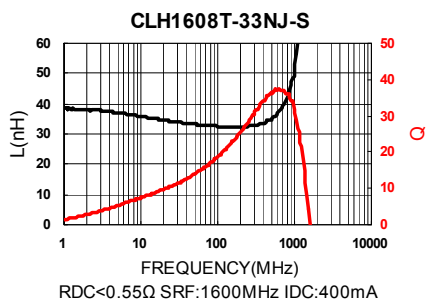
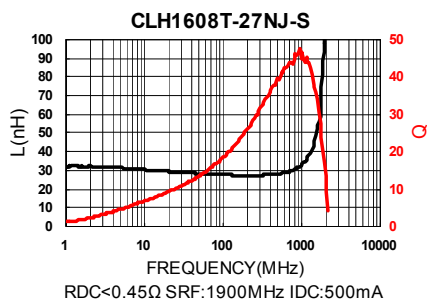
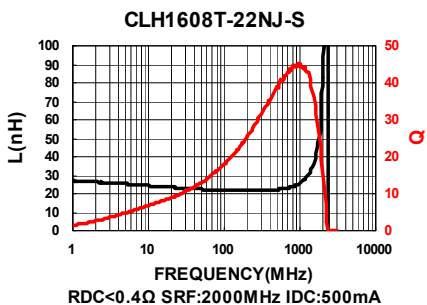
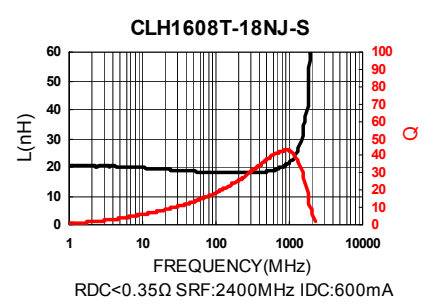
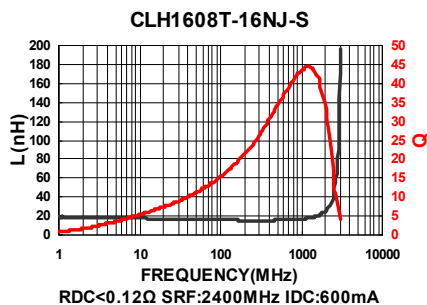
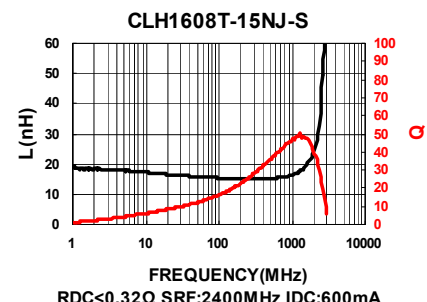
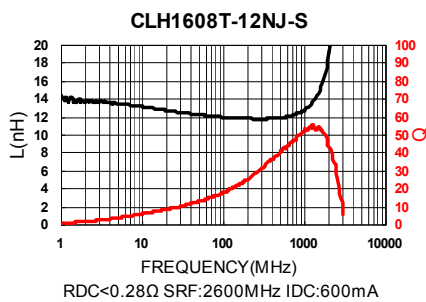
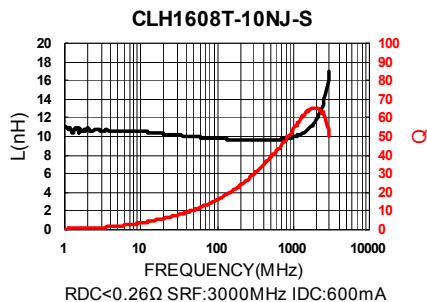
Please be sure to request approval specifications that provide further details of the products. Kindly note that the content of these specifications are subject to change or may be discontinued without advance notice. Please contact our sales department before ordering.

Test Instruments : Agilent E4991A Material/Impedance Analyzer



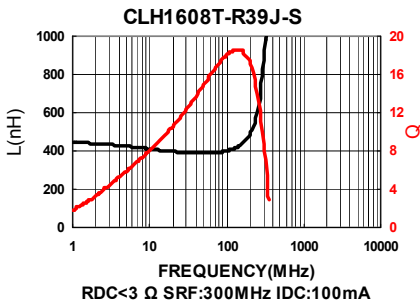
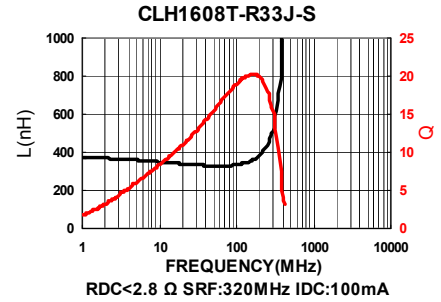
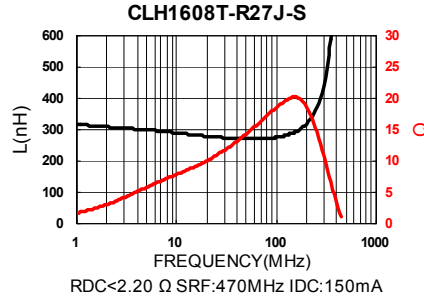
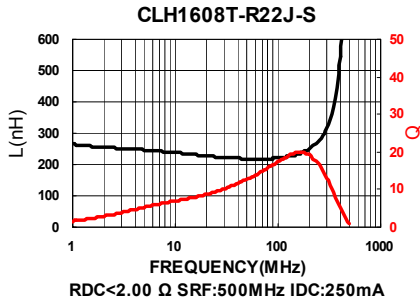
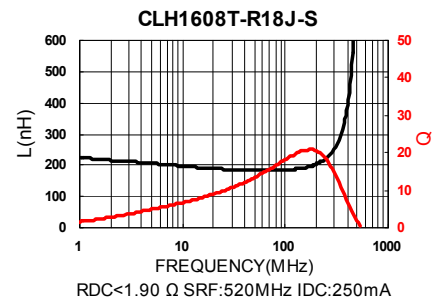
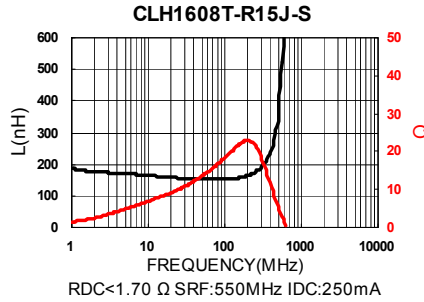
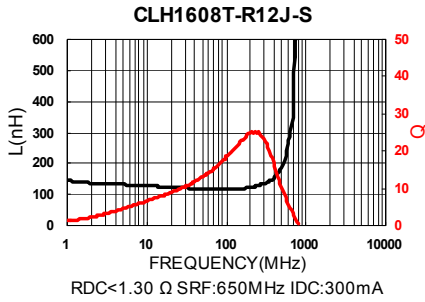
Please be sure to request approval specifications that provide further details of the products. Kindly note that the content of these specifications are subject to change or may be discontinued without advance notice. Please contact our sales department before ordering.

Test Instruments : Agilent E4991A Material/Impedance Analyzer



Please be sure to request approval specifications that provide further details of the products. Kindly note that the content of these specifications are subject to change or may be discontinued without advance notice. Please contact our sales department before ordering.

Test Instruments : Agilent E4991A Material/Impedance Analyzer

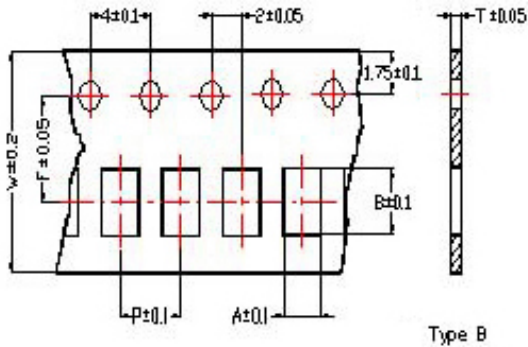


Please be sure to request approval specifications that provide further details of the products. Kindly note that the content of these specifications are subject to change or may be discontinued without advance notice. Please contact our sales department before ordering.

Packaging Specifications

Tape Dimensions

Figure A



Tape Material

Figure A

Carrier Tape: Polycarbonate (Tape A)
 Carrier Tape: Paper (Tape B)
 Cover Tape: Polystyrene

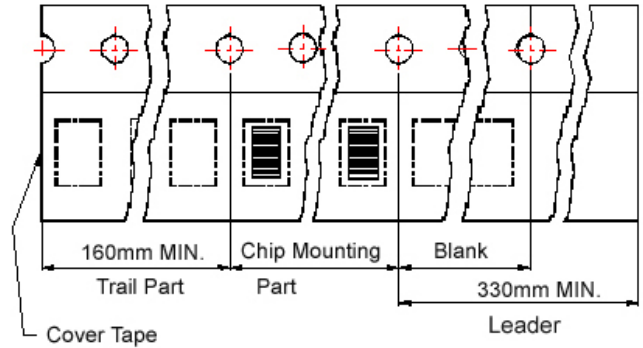
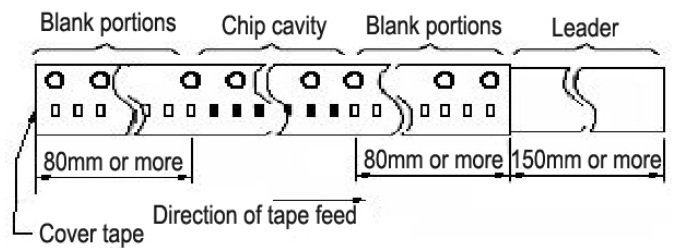
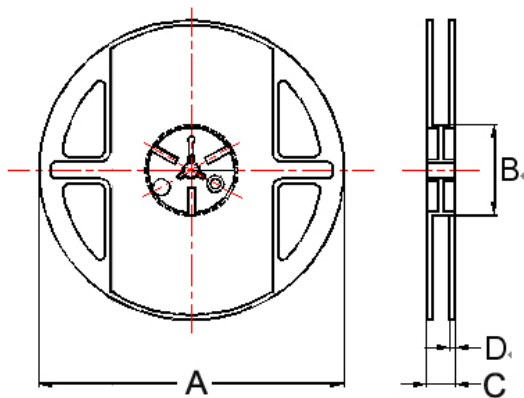


Figure B

Carrier tape : Paper
 Cover tape : Polyethylene



Reel Dimensions



Dimensions in mm

| TYPE | Tape Dimensions | | | | | | | Tape Material | Reel Dimensions | | | | Quantity PCS / Reel |
|---------|-----------------|------|------|---|---|-----|---|---------------|-----------------|----|----|-----|---------------------|
| | A | B | T | W | P | F | A | | B | C | D | | |
| CLH0603 | 0.37 | 0.67 | 0.42 | 8 | 2 | 3.5 | A | B | 180 | 60 | 13 | 1.5 | 15000 |
| CLH1005 | 0.62 | 1.12 | 0.60 | 8 | 2 | 3.5 | A | A | 178 | 60 | 12 | 1.5 | 10000 |
| CLH1608 | 1.00 | 1.80 | 0.95 | 8 | 4 | 3.5 | A | A | 178 | 60 | 12 | 1.5 | 4000 |

CM Series



Due to accurate wire winding technology, these chip inductors are designed for filtering impedance matching, resonance and choke circuits for RF designer. Both standard series and custom designs are available.

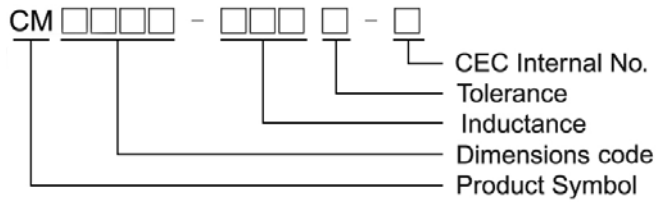
Features

- RoHS Compliant
- Ceramic body and wire wound construction provide high SRFs
- Exceptional Q value even at high frequencies
- Ceramic construction delivers the highest possible SRFs as well as high Q value
- Low DC resistance design supports low loss, high output and low power consumption
- CM series is standard for RF designers

Applications

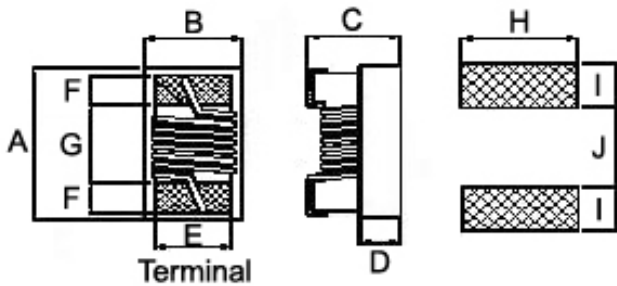
- RF products for cellular phone
- GPS receiver
- Base Station
- Repeater
- Wireless LAN/ mouse/ keyboard/ earphone
- Remote control
- Security system and other RF modules

Product Identification

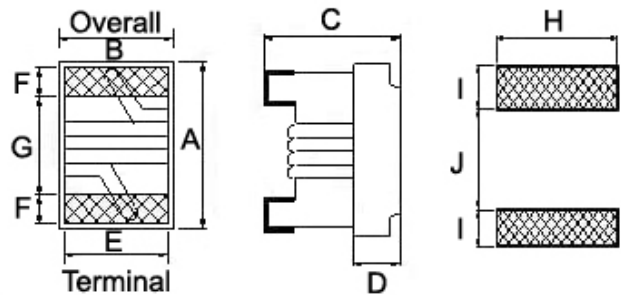


Shape and Dimensions / Recommended Pattern

CM0402



CM0603



Dimensions

| | A Max | B Max | C Max | D | E | F | G | H | I | J |
|---------------|-------------------------------------|------------|--------------------------------------|------|------|------|------|------|------|------|
| CM0402 | 1.19 | 0.70 | 0.66 | 0.25 | 0.51 | 0.23 | 0.56 | 0.66 | 0.36 | 0.46 |
| CM0603 | 1.6 ^{+0.2} _{-0.1} | 1.02 ± 0.1 | 0.82 ^{+0.2} _{-0.1} | 0.35 | 0.70 | 0.30 | 0.95 | 1.02 | 0.64 | 0.64 |

Electrical Characteristics

| Part Number | Inductance (nH) | Tolerance (±%) | Test Frequency (MHz) | Q Min | Test Frequency (MHz) | SRF (GHz) Min | RDC (Ω) Max | I _{rms} (mA) Max |
|---------------|-----------------|----------------------|----------------------|--------|----------------------|---------------|-------------|---------------------------|
| CM0402-1N5□-N | 1.5 | ±0.1nH/±0.2nH/±0.5nH | 100 | 10 | 250 | 18.0 | 0.03 | 1000 |
| CM0402-2N4□-N | 2.4 | ±0.1nH/±0.2nH/±0.5nH | 100 | 20 | 250 | 15.0 | 0.05 | 850 |
| CM0402-2N5□-N | 2.5 | ±0.1nH/±0.2nH/±0.5nH | 100 | 20 | 250 | 15.0 | 0.05 | 850 |
| CM0402-2N7□-N | 2.7 | ±0.1nH/±0.2nH/±0.5nH | 100 | 20 | 250 | 15.0 | 0.05 | 850 |
| CM0402-2N9□-N | 2.9 | ±0.1nH/±0.2nH/±0.5nH | 100 | 20 | 250 | 15.0 | 0.07 | 750 |
| CM0402-3N9□-N | 3.9 | 3 / 5 | 100 | 25 | 250 | 10.0 | 0.07 | 750 |
| CM0402-4N1□-N | 4.1 | 3 / 5 | 100 | 25 | 250 | 10.0 | 0.07 | 750 |
| CM0402-4N3□-N | 4.3 | 3 / 5 | 100 | 25 | 250 | 10.0 | 0.07 | 750 |
| CM0402-4N7□-N | 4.7 | 3 / 5 | 100 | 25 | 250 | 8.0 | 0.07 | 750 |
| CM0402-5N1□-N | 5.1 | 3 / 5 | 100 | 25 typ | 250 | 8.0 | 0.12 | 600 |
| CM0402-5N8□-N | 5.8 | 3 / 5 | 100 | 25 | 250 | 8.0 | 0.12 | 700 |
| CM0402-6N2□-N | 6.2 | 3 / 5 | 100 | 25 | 250 | 8.0 | 0.09 | 700 |
| CM0402-6N8□-N | 6.8 | 3 / 5 | 100 | 25 | 250 | 6.0 | 0.09 | 700 |
| CM0402-7N3□-N | 7.3 | 3 / 5 | 100 | 25 | 250 | 6.0 | 0.13 | 570 |
| CM0402-7N5□-N | 7.5 | 3 / 5 | 100 | 25 | 250 | 6.0 | 0.13 | 570 |
| CM0402-8N2□-N | 8.2 | 3 / 5 | 100 | 25 | 250 | 5.5 | 0.14 | 540 |
| CM0402-8N7□-N | 8.7 | 3 / 5 | 100 | 25 | 250 | 5.5 | 0.14 | 540 |
| CM0402-9N1□-N | 9.1 | 3 / 5 | 100 | 25 | 250 | 5.5 | 0.14 | 540 |
| CM0402-9N5□-N | 9.5 | 3 / 5 | 100 | 25 | 250 | 5.5 | 0.14 | 540 |
| CM0402-10N□-N | 10 | 2 / 3 / 5 | 100 | 25 | 250 | 5.5 | 0.17 | 500 |
| CM0402-11N□-N | 11 | 2 / 3 / 5 | 100 | 30 | 250 | 5.5 | 0.14 | 500 |
| CM0402-12N□-N | 12 | 2 / 3 / 5 | 100 | 30 | 250 | 5.5 | 0.14 | 500 |
| CM0402-13N□-N | 13 | 2 / 3 / 5 | 100 | 25 | 250 | 5.0 | 0.21 | 430 |
| CM0402-15N□-N | 15 | 2 / 3 / 5 | 100 | 30 | 250 | 5.0 | 0.16 | 460 |
| CM0402-16N□-N | 16 | 2 / 3 / 5 | 100 | 25 | 250 | 4.5 | 0.24 | 370 |
| CM0402-18N□-N | 18 | 2 / 3 / 5 | 100 | 25 | 250 | 4.5 | 0.27 | 370 |
| CM0402-19N□-N | 19 | 2 / 3 / 5 | 100 | 25 | 250 | 4.5 | 0.27 | 370 |
| CM0402-20N□-N | 20 | 2 / 3 / 5 | 100 | 25 | 250 | 4.0 | 0.27 | 370 |
| CM0402-22N□-N | 22 | 2 / 3 / 5 | 100 | 25 | 250 | 4.0 | 0.30 | 310 |
| CM0402-23N□-N | 23 | 2 / 3 / 5 | 100 | 25 | 250 | 3.8 | 0.30 | 310 |
| CM0402-24N□-N | 24 | 2 / 3 / 5 | 100 | 25 | 250 | 3.5 | 0.52 | 280 |
| CM0402-27N□-N | 27 | 2 / 3 / 5 | 100 | 25 | 250 | 3.5 | 0.52 | 280 |
| CM0402-30N□-N | 30 | 2 / 3 / 5 | 100 | 25 | 250 | 3.3 | 0.58 | 270 |
| CM0402-33N□-N | 33 | 2 / 3 / 5 | 100 | 25 | 250 | 3.2 | 0.63 | 260 |
| CM0402-36N□-N | 36 | 2 / 3 / 5 | 100 | 25 | 250 | 3.1 | 0.63 | 260 |
| CM0402-39N□-N | 39 | 2 / 3 / 5 | 100 | 25 | 250 | 3.0 | 0.70 | 250 |
| CM0402-40N□-N | 40 | 2 / 3 / 5 | 100 | 25 | 250 | 3.0 | 0.70 | 250 |
| CM0402-47N□-N | 47 | 2 / 3 / 5 | 100 | 25 | 200 | 2.9 | 1.08 | 210 |
| CM0402-51N□-N | 51 | 2 / 3 / 5 | 100 | 25 | 200 | 2.85 | 1.08 | 210 |
| CM0402-56N□-N | 56 | 2 / 3 / 5 | 100 | 25 | 200 | 2.80 | 1.17 | 200 |
| CM0402-62N□-N | 62 | 2 / 3 / 5 | 100 | 20 | 200 | 2.60 | 1.82 | 145 |

Note: When ordering, please specify tolerance code. Tolerance : B=±0.1nH , C=±0.2nH , D=±0.5nH , G=±2% , H=±3% , J=±5%

- Operating temperature range - 40°C ~ 125°C(Including self - temperature rise)
- I_{rms} for a 15°C temperature rise from 25°C ambient with current
- Measure Equipment :
 L & Q : Agilent E4991A+Agilent HP16197A
 SRF : Agilent HP8753D/Agilent HP8722ES
 RDC : Chroma 16502
 I_{rms} : HP4284A+HP42841A/HP4285A+HP42841A

Please be sure to request approval specifications that provide further details of the products. Kindly note that the content of these specifications are subject to change or may be discontinued without advance notice. Please contact our sales department before ordering.

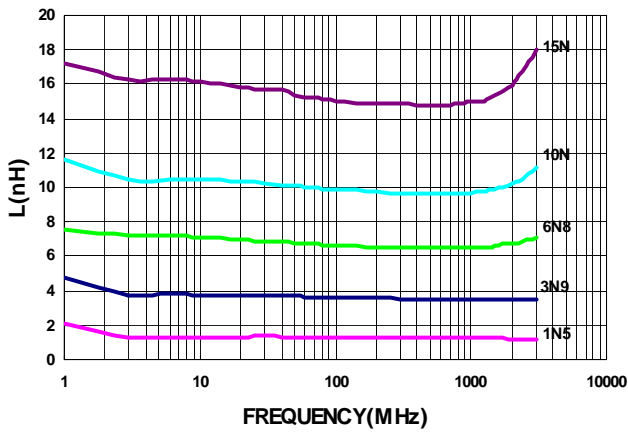
Electrical Characteristics

| Part Number | Inductance (nH) | Tolerance (±%) | Test Frequency (MHz) | Q Min | Test Frequency (MHz) | SRF (GHz) Min | RDC (Ω) Max | Irms (mA) Max |
|---------------|-----------------|----------------|----------------------|-------|----------------------|---------------|-------------|---------------|
| CM0402-68N□-N | 68 | 2 / 3 / 5 | 100 | 20 | 200 | 2.50 | 1.96 | 140 |
| CM0402-72N□-N | 72 | 2 / 3 / 5 | 100 | 20 | 150 | 2.50 | 2.10 | 135 |
| CM0402-75N□-N | 75 | 2 / 3 / 5 | 100 | 20 | 150 | 2.40 | 2.10 | 135 |
| CM0402-82N□-N | 82 | 2 / 3 / 5 | 100 | 20 | 150 | 2.30 | 2.24 | 130 |
| CM0402-91N□-N | 91 | 2 / 3 / 5 | 100 | 20 | 150 | 2.10 | 2.38 | 125 |
| CM0402-R10□-N | 100 | 2 / 3 / 5 | 100 | 20 | 150 | 1.50 | 2.52 | 120 |
| CM0402-R12□-N | 120 | 2 / 3 / 5 | 100 | 20 | 150 | 1.00 | 2.66 | 110 |

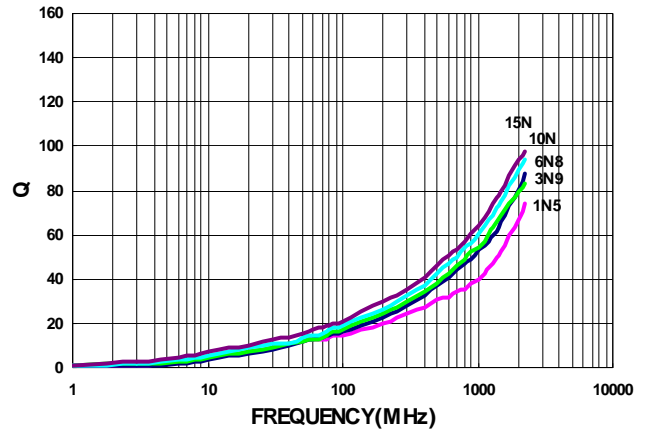
Note: When ordering, please specify tolerance code. Tolerance : B=±0.1nH , C=±0.2nH , D=±0.5nH , G=±2% , H=±3% , J=±5%

- Operating temperature range - 40°C ~ 125°C(Including self - temperature rise)
- I rms for a 15°C temperature rise from 25°C ambient with current
- Measure Equipment :
 L & Q : Agilent E4991A+Agilent HP16197A
 SRF : Agilent HP8753D/Agilent HP8722ES
 RDC : Chroma 16502
 I rms : HP4284A+HP42841A/HP4285A+HP42841A

Typical **L** vs. **F**requency



Typical **Q** vs. **F**requency



Please be sure to request approval specifications that provide further details of the products. Kindly note that the content of these specifications are subject to change or may be discontinued without advance notice. Please contact our sales department before ordering.

Electrical Characteristics

| Part Number | Inductance (nH) | Tolerance (±%) | Test Frequency (MHz) | Q Min | Test Frequency (MHz) | SRF (GHz) Min | RDC (Ω) Max | Irms (mA) Max |
|---------------|-----------------|----------------------|----------------------|-------|----------------------|---------------|-------------|---------------|
| CM0603-2N2□-N | 2.2 | ±0.1nH/±0.2nH/±0.5nH | 100 | 16 | 250 | 6.0 | 0.049 | 700 |
| CM0603-3N6□-N | 3.6 | 3 / 5 | 100 | 25 | 250 | 6.0 | 0.059 | 850 |
| CM0603-3N9□-N | 3.9 | 3 / 5 | 100 | 35 | 250 | 6.0 | 0.059 | 850 |
| CM0603-4N3□-N | 4.3 | 3 / 5 | 100 | 35 | 250 | 6.0 | 0.059 | 850 |
| CM0603-4N7□-N | 4.7 | 3 / 5 | 100 | 35 | 250 | 6.0 | 0.059 | 850 |
| CM0603-5N6□-N | 5.6 | 3 / 5 | 100 | 35 | 250 | 6.0 | 0.082 | 750 |
| CM0603-6N2□-N | 6.2 | 3 / 5 | 100 | 35 | 250 | 6.0 | 0.082 | 750 |
| CM0603-6N8□-N | 6.8 | 3 / 5 | 100 | 35 | 250 | 6.0 | 0.082 | 750 |
| CM0603-7N5□-N | 7.5 | 3 / 5 | 100 | 35 | 250 | 6.0 | 0.082 | 750 |
| CM0603-8N2□-N | 8.2 | 3 / 5 | 100 | 35 | 250 | 6.0 | 0.110 | 650 |
| CM0603-8N7□-N | 8.7 | 3 / 5 | 100 | 35 | 250 | 6.0 | 0.110 | 650 |
| CM0603-9N1□-N | 9.1 | 3 / 5 | 100 | 35 | 250 | 6.0 | 0.110 | 650 |
| CM0603-9N5□-N | 9.5 | 3 / 5 | 100 | 35 | 250 | 6.0 | 0.110 | 650 |
| CM0603-10N□-N | 10 | 2 / 3 / 5 | 100 | 35 | 250 | 6.0 | 0.110 | 650 |
| CM0603-11N□-N | 11 | 2 / 3 / 5 | 100 | 35 | 250 | 6.0 | 0.110 | 650 |
| CM0603-12N□-N | 12 | 2 / 3 / 5 | 100 | 35 | 250 | 6.0 | 0.130 | 600 |
| CM0603-13N□-N | 13 | 2 / 3 / 5 | 100 | 35 | 250 | 6.0 | 0.130 | 600 |
| CM0603-15N□-N | 15 | 2 / 3 / 5 | 100 | 40 | 250 | 6.0 | 0.130 | 600 |
| CM0603-16N□-N | 16 | 2 / 3 / 5 | 100 | 40 | 250 | 5.5 | 0.160 | 550 |
| CM0603-18N□-N | 18 | 2 / 3 / 5 | 100 | 40 | 250 | 5.5 | 0.160 | 550 |
| CM0603-20N□-N | 20 | 2 / 3 / 5 | 100 | 40 | 250 | 4.9 | 0.160 | 550 |
| CM0603-22N□-N | 22 | 2 / 3 / 5 | 100 | 40 | 250 | 4.6 | 0.170 | 500 |
| CM0603-24N□-N | 24 | 2 / 3 / 5 | 100 | 40 | 250 | 3.8 | 0.210 | 500 |
| CM0603-27N□-N | 27 | 2 / 3 / 5 | 100 | 40 | 250 | 3.7 | 0.210 | 440 |
| CM0603-30N□-N | 30 | 2 / 3 / 5 | 100 | 40 | 250 | 3.3 | 0.230 | 420 |
| CM0603-33N□-N | 33 | 2 / 3 / 5 | 100 | 40 | 250 | 3.2 | 0.230 | 420 |
| CM0603-36N□-N | 36 | 2 / 3 / 5 | 100 | 40 | 250 | 2.9 | 0.260 | 400 |
| CM0603-39N□-N | 39 | 2 / 3 / 5 | 100 | 40 | 250 | 2.8 | 0.260 | 400 |
| CM0603-43N□-N | 43 | 2 / 3 / 5 | 100 | 40 | 200 | 2.7 | 0.290 | 380 |
| CM0603-47N□-N | 47 | 2 / 3 / 5 | 100 | 38 | 200 | 2.6 | 0.290 | 380 |
| CM0603-51N□-N | 51 | 2 / 3 / 5 | 100 | 38 | 200 | 2.5 | 0.330 | 370 |
| CM0603-56N□-N | 56 | 2 / 3 / 5 | 100 | 38 | 200 | 2.4 | 0.350 | 360 |
| CM0603-62N□-N | 62 | 2 / 3 / 5 | 100 | 38 | 200 | 2.3 | 0.510 | 280 |
| CM0603-68N□-N | 68 | 2 / 3 / 5 | 100 | 38 | 200 | 2.2 | 0.380 | 340 |
| CM0603-72N□-N | 72 | 2 / 3 / 5 | 100 | 34 | 150 | 2.1 | 0.560 | 270 |
| CM0603-75N□-N | 75 | 2 / 3 / 5 | 100 | 34 | 150 | 2.05 | 0.560 | 270 |
| CM0603-82N□-N | 82 | 2 / 3 / 5 | 100 | 34 | 150 | 2.00 | 0.600 | 250 |
| CM0603-91N□-N | 91 | 2 / 3 / 5 | 100 | 34 | 150 | 1.90 | 0.640 | 230 |
| CM0603-R10□-N | 100 | 2 / 3 / 5 | 100 | 34 | 150 | 1.80 | 0.680 | 220 |
| CM0603-R11□-N | 110 | 2 / 3 / 5 | 100 | 32 | 150 | 1.70 | 1.200 | 200 |

Note: When ordering, please specify tolerance code. Tolerance : B=±0.1nH , C=±0.2nH , D=±0.5nH , G=±2% , H=±3% , J=±5%

- Operating temperature range - 40°C ~ 125°C(Including self - temperature rise)
- Irms for a 15°C temperature rise from 25°C ambient with current
- Measure Equipment :
 L & Q : Agilent E4991A+Agilent HP16197A
 SRF : Agilent HP8753D/Agilent HP8722ES
 RDC : Chroma 16502
 Irms : HP4284A+HP42841A/HP4285A+HP42841A

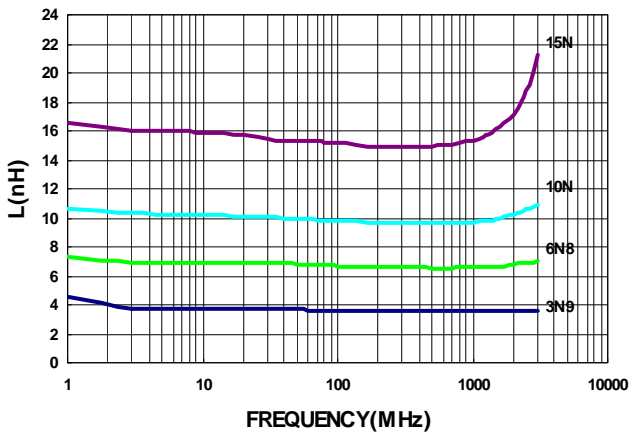
Electrical Characteristics

| Part Number | Inductance (nH) | Tolerance (±%) | Test Frequency (MHz) | Q Min | Test Frequency (MHz) | SRF (GHz) Min | RDC (Ω) Max | Irms (mA) Max |
|---------------|-----------------|----------------|----------------------|-------|----------------------|---------------|-------------|---------------|
| CM0603-R12□-N | 120 | 2 / 3 / 5 | 100 | 32 | 150 | 1.60 | 1.300 | 180 |
| CM0603-R13□-N | 130 | 2 / 3 / 5 | 100 | 32 | 150 | 1.45 | 1.400 | 170 |
| CM0603-R15□-N | 150 | 2 / 3 / 5 | 100 | 32 | 150 | 1.40 | 1.500 | 160 |
| CM0603-R16□-N | 160 | 2 / 3 / 5 | 100 | 32 | 150 | 1.35 | 2.100 | 150 |
| CM0603-R18□-N | 180 | 2 / 3 / 5 | 100 | 25 | 100 | 1.30 | 2.200 | 140 |
| CM0603-R20□-N | 200 | 2 / 3 / 5 | 100 | 25 | 100 | 1.25 | 2.400 | 120 |
| CM0603-R22□-N | 220 | 2 / 3 / 5 | 100 | 25 | 100 | 1.20 | 2.500 | 120 |
| CM0603-R27□-N | 270 | 2 / 3 / 5 | 100 | 30 | 100 | 0.96 | 3.400 | 110 |
| CM0603-R33□-N | 330 | 2 / 3 / 5 | 100 | 30 | 100 | 0.80 | 5.500 | 85 |
| CM0603-R39□-N | 390 | 2 / 3 / 5 | 100 | 30 | 100 | 0.80 | 6.200 | 80 |
| CM0603-R47□-N | 470 | 2 / 3 / 5 | 100 | 30 | 100 | 0.70 | 7.000 | 75 |

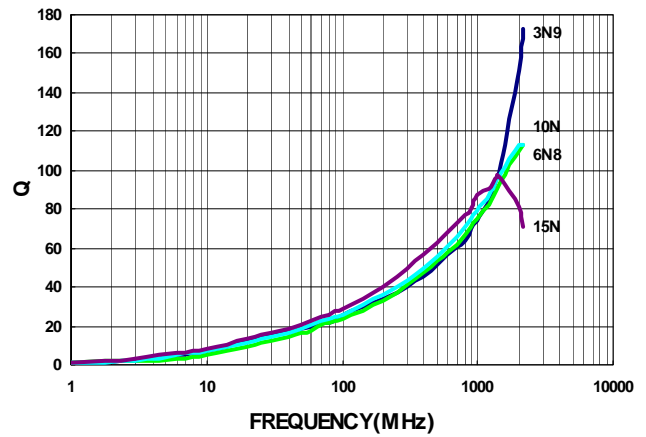
Note: When ordering, please specify tolerance code. Tolerance : B=±0.1nH , C=±0.2nH , D=±0.5nH , G=±2% , H=±3% , J=±5%

- Operating temperature range - 40°C ~ 125°C(Including self - temperature rise)
- I rms for a 15°C temperature rise from 25°C ambient with current
- Measure Equipment :
 L & Q : Agilent E4991A+Agilent HP16197A
 SRF : Agilent HP8753D/Agilent HP8722ES
 RDC : Chroma 16502
 I rms : HP4284A+HP42841A/HP4285A+HP42841A

Typical **L** vs. **F**requency



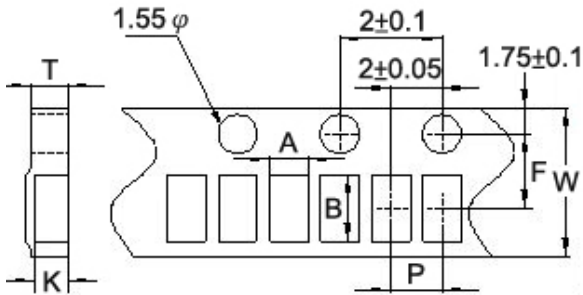
Typical **Q** vs. **F**requency



Packaging Specifications

Tape Dimensions

Figure 1



Tape Material

Carrier Tape: Paper
Cover Tape: Polystyrene

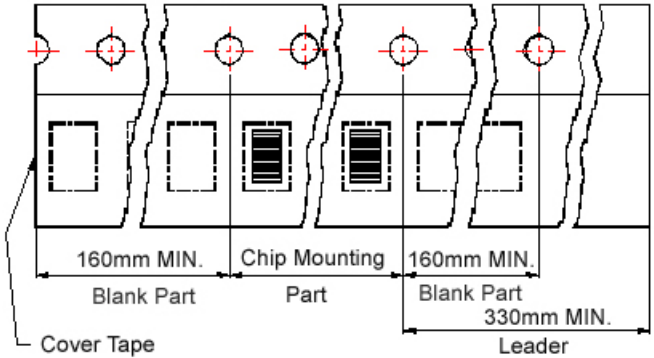
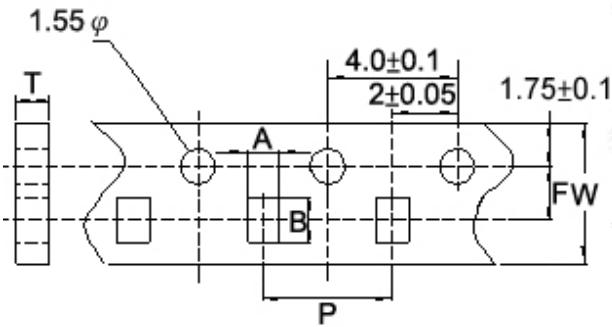
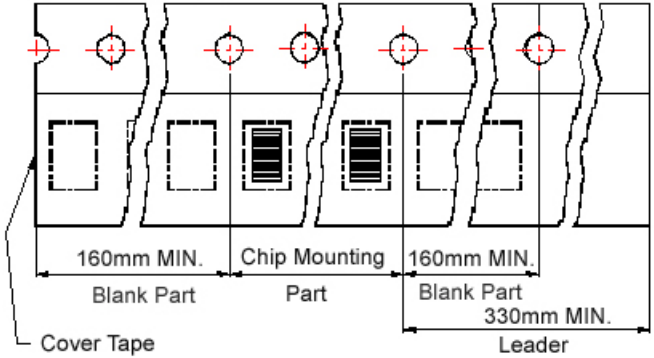


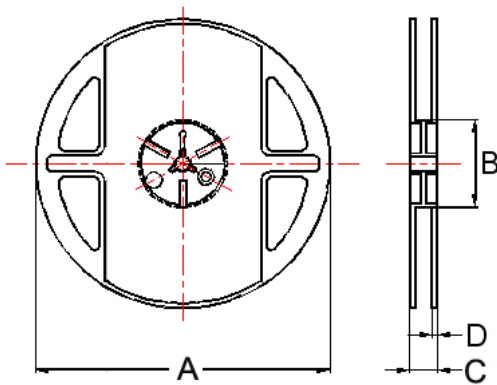
Figure 2



Carrier Tape: Paper
Cover Tape: Polystyrene



Reel Dimensions



Dimensions in mm

| TYPE | Fig. | Tape Dimensions | | | | | | | Reel Dimensions | | | | Quantity PCS / Reel |
|--------|------|-----------------|------|------|---|---|-----|------|-----------------|----|----|-----|------------------------|
| | | A | B | T | W | P | F | K | A | B | C | D | |
| CM0402 | 1 | 0.67 | 1.20 | 0.75 | 8 | 2 | 3.5 | 0.59 | 178 | 60 | 12 | 1.5 | 4000 |
| CM0603 | 2 | 1.20 | 1.80 | 1.05 | 8 | 4 | 3.5 | - | 178 | 60 | 12 | 1.5 | 4000 |

CS Series



Due to accurate wire winding technology, these chip inductors are designed for filtering, impedance matching, resonance and choke circuits for RF designer. Both standard series custom designs are available.

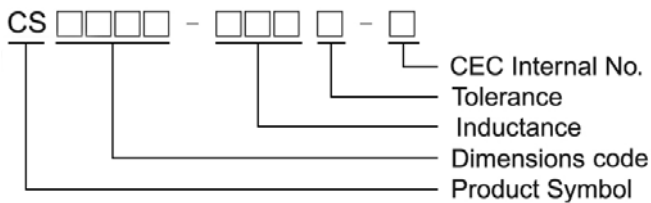
Features

- RoHS Compliant
- Ceramic body and wire wound construction provide high SRFs
- Exceptional Q values even at high frequencies
- Highest possible SRFs as well as excellent Q values
- The non-magnetic coil form assures utmost thermal stability, predictability and batch consistency
- CS series is standard for RF designers

Applications

- RF products for cellular phone
- GPS receiver
- Base Station
- Repeater
- Wireless LAN/ mouse/ keyboard/ earphone
- Remote control
- Security system and other RF modules

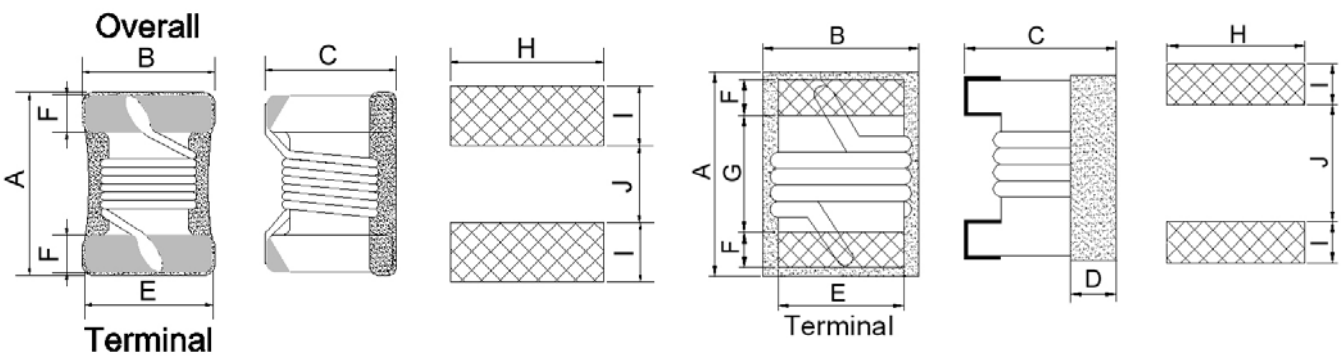
Product Identification



Shape and Dimensions / Recommended Pattern

CS0201

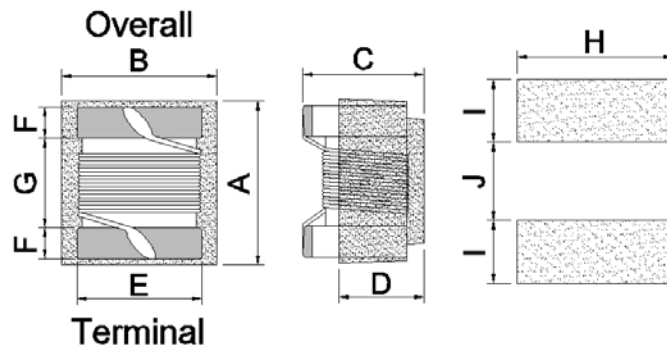
CS0402



Dimensions

| | | A Max | B Max | C Max | D | E | F | G | H | I | J |
|--------|------|-------|-------|-------|-------|-------|-------|-------|-------|-------|-------|
| CS0201 | inch | 0.023 | 0.018 | 0.018 | - | 0.015 | 0.004 | - | 0.018 | 0.007 | 0.009 |
| | mm | 0.58 | 0.46 | 0.45 | - | 0.38 | 0.1 | - | 0.46 | 0.18 | 0.23 |
| CS0402 | inch | 0.047 | 0.028 | 0.026 | 0.010 | 0.020 | 0.009 | 0.022 | 0.026 | 0.014 | 0.018 |
| | mm | 1.19 | 0.70 | 0.66 | 0.25 | 0.51 | 0.23 | 0.56 | 0.66 | 0.36 | 0.46 |

CS0603/0805/1008



Dimensions

| | | A | B | C | D | E | F | G | H | I | J |
|---------------|------|-------------------------------------|----------|--------------------------------------|-------|-------|-------|-------|-------|-------|-------|
| CS0603 | mm | 1.6 ^{+0.2} _{-0.1} | 1.02±0.1 | 0.82 ^{+0.2} _{-0.1} | 0.51 | 0.76 | 0.33 | 0.86 | 1.02 | 0.64 | 0.64 |
| | | A Max | B Max | C Max | D | E | F | G | H | I | J |
| CS0805 | inch | 0.093 | 0.068 | 0.06 | 0.028 | 0.050 | 0.020 | 0.040 | 0.070 | 0.040 | 0.030 |
| | mm | 2.35 | 1.73 | 1.52 | 0.71 | 1.27 | 0.51 | 1.02 | 1.78 | 1.02 | 0.76 |
| CS1008 | inch | 0.115 | 0.110 | 0.083 | 0.046 | 0.080 | 0.020 | 0.060 | 0.100 | 0.040 | 0.050 |
| | mm | 2.92 | 2.79 | 2.1 | 1.16 | 2.03 | 0.51 | 1.52 | 2.54 | 1.02 | 1.27 |

Electrical Characteristics

| Part Number | Inductance (nH) | Tolerance (±%) | Test Frequency (MHz) | Q Min | SRF (GHz) Typ | RDC (Ω) Max | Irms (mA) Typ |
|---------------|--------------------|-------------------|----------------------------|----------|------------------|----------------|------------------|
| CS0201-0N5□-S | 0.5 | 10 | 250 | 4 | 23.5 | 0.02 | 1250 |
| CS0201-0N6□-S | 0.6 | 10 | 250 | 6 | 24.5 | 0.03 | 1000 |
| CS0201-1N2□-S | 1.2 | 5 | 250 | 13 | 17.9 | 0.042 | 870 |
| CS0201-1N3□-S | 1.3 | 5 | 250 | 11 | 17.6 | 0.048 | 820 |
| CS0201-1N4□-S | 1.4 | 5 | 250 | 14 | 17 | 0.08 | 630 |
| CS0201-1N5□-S | 1.5 | 5 | 250 | 11 | 17 | 0.09 | 600 |
| CS0201-2N2□-S | 2.2 | 5 | 250 | 15 | 16.7 | 0.07 | 700 |
| CS0201-2N3□-S | 2.3 | 5 | 250 | 18 | 16.5 | 0.07 | 670 |
| CS0201-2N4□-S | 2.4 | 5 | 250 | 13 | 13 | 0.082 | 620 |
| CS0201-2N5□-S | 2.5 | 5 | 250 | 16 | 12.5 | 0.165 | 440 |
| CS0201-3N3□-S | 3.3 | 5 | 250 | 14 | 12.8 | 0.08 | 630 |
| CS0201-3N4□-S | 3.4 | 5 | 250 | 11 | 12.7 | 0.08 | 630 |
| CS0201-3N5□-S | 3.5 | 5 | 250 | 16 | 12.4 | 0.08 | 630 |
| CS0201-3N6□-S | 3.6 | 5 | 250 | 18 | 12.5 | 0.105 | 550 |
| CS0201-3N7□-S | 3.7 | 5 | 250 | 15 | 10.6 | 0.105 | 550 |
| CS0201-3N8□-S | 3.8 | 5 | 250 | 16 | 10.2 | 0.18 | 420 |
| CS0201-3N9□-S | 3.9 | 5 | 250 | 12 | 11.2 | 0.24 | 360 |
| CS0201-4N8□-S | 4.8 | 5 | 250 | 17 | 11 | 0.096 | 570 |
| CS0201-4N9□-S | 4.9 | 5 | 250 | 18 | 11.7 | 0.13 | 510 |
| CS0201-5N0□-S | 5.0 | 5 | 250 | 18 | 11.5 | 0.13 | 510 |
| CS0201-5N1□-S | 5.1 | 5 | 250 | 18 | 11.1 | 0.13 | 510 |
| CS0201-5N2□-S | 5.2 | 5 | 250 | 18 | 10 | 0.17 | 430 |
| CS0201-5N3□-S | 5.3 | 5 | 250 | 18 | 10.6 | 0.13 | 510 |
| CS0201-5N4□-S | 5.4 | 5 | 250 | 18 | 10.2 | 0.13 | 510 |
| CS0201-5N5□-S | 5.5 | 5 | 250 | 16 | 9.5 | 0.285 | 330 |
| CS0201-6N7□-S | 6.7 | 5 | 250 | 18 | 6.8 | 0.15 | 460 |
| CS0201-6N8□-S | 6.8 | 5 | 250 | 18 | 9.5 | 0.15 | 460 |
| CS0201-6N9□-S | 6.9 | 5 | 250 | 18 | 9.3 | 0.15 | 460 |
| CS0201-7N0□-S | 7.0 | 5 | 250 | 18 | 6.7 | 0.21 | 390 |
| CS0201-7N1□-S | 7.1 | 5 | 250 | 18 | 9.5 | 0.25 | 390 |
| CS0201-7N2□-S | 7.2 | 5 | 250 | 18 | 9.4 | 0.25 | 390 |
| CS0201-7N3□-S | 7.3 | 5 | 250 | 18 | 9.3 | 0.25 | 390 |
| CS0201-7N4□-S | 7.4 | 5 | 250 | 18 | 9.1 | 0.25 | 390 |
| CS0201-7N5□-S | 7.5 | 5 | 250 | 15 | 6.8 | 0.34 | 300 |
| CS0201-7N6□-S | 7.6 | 5 | 250 | 17 | 9.3 | 0.3 | 340 |
| CS0201-7N7□-S | 7.7 | 5 | 250 | 17 | 9.2 | 0.3 | 340 |
| CS0201-7N8□-S | 7.8 | 5 | 250 | 17 | 9.2 | 0.3 | 340 |
| CS0201-7N9□-S | 7.9 | 5 | 250 | 17 | 9.1 | 0.3 | 340 |
| CS0201-8N0□-S | 8.0 | 5 | 250 | 17 | 9.2 | 0.3 | 340 |
| CS0201-8N1□-S | 8.1 | 5 | 250 | 17 | 9.1 | 0.3 | 340 |
| CS0201-8N2□-S | 8.2 | 5 | 250 | 17 | 6.4 | 0.27 | 340 |

Note: When ordering, please specify tolerance code. Tolerance : J=±5% , K=±10%

- Operating temperature range - 40°C ~ 125°C(Including self - temperature rise)
- I rms for a 15°C temperature rise from 25°C ambient with current
- Measure Equipment :
L & Q : Agilent E4991A+Agilent HP16197A
SRF : Agilent HP8753D/Agilent HP8722ES
RDC : HP4287A
I rms : HP4284A+HP42841A/HP4285A+HP42841A

Please be sure to request approval specifications that provide further details of the products. Kindly note that the content of these specifications are subject to change or may be discontinued without advance notice. Please contact our sales department before ordering.

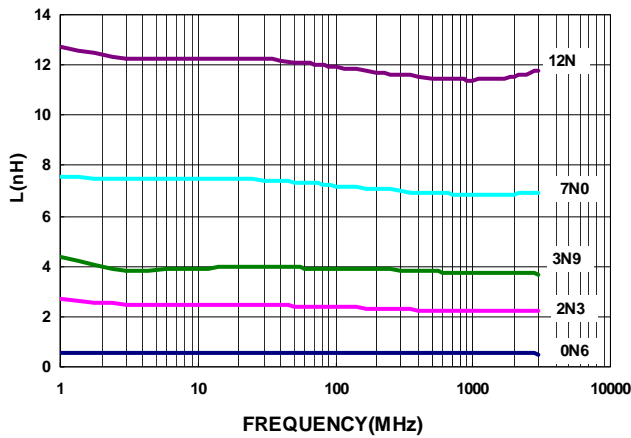
Electrical Characteristics

| Part Number | Inductance (nH) | Tolerance (±%) | Test Frequency (MHz) | Q Min | SRF (GHz) Typ | RDC (Ω) Max | Irms (mA) Typ |
|---------------|-----------------|----------------|----------------------|-------|---------------|-------------|---------------|
| CS0201-8N3□-S | 8.3 | 5 | 250 | 17 | 8.9 | 0.3 | 340 |
| CS0201-8N4□-S | 8.4 | 5 | 250 | 15 | 8.9 | 0.38 | 300 |
| CS0201-8N5□-S | 8.5 | 5 | 250 | 15 | 8.9 | 0.38 | 300 |
| CS0201-8N7□-S | 8.7 | 5 | 250 | 15 | 6.3 | 0.38 | 300 |
| CS0201-9N0□-S | 9.0 | 5 | 250 | 15 | 6.4 | 0.38 | 300 |
| CS0201-9N4□-S | 9.4 | 5 | 250 | 16 | 6.4 | 0.4 | 280 |
| CS0201-9N6□-S | 9.6 | 5 | 250 | 16 | 6.2 | 0.4 | 280 |
| CS0201-11N□-S | 11 | 5 | 250 | 16 | 5.7 | 0.44 | 280 |
| CS0201-12N□-S | 12 | 5 | 250 | 17 | 5.6 | 0.36 | 300 |
| CS0201-13N□-S | 13 | 5 | 250 | 16 | 6.7 | 0.5 | 270 |
| CS0201-14N□-S | 14 | 5 | 250 | 16 | 5.1 | 0.5 | 270 |

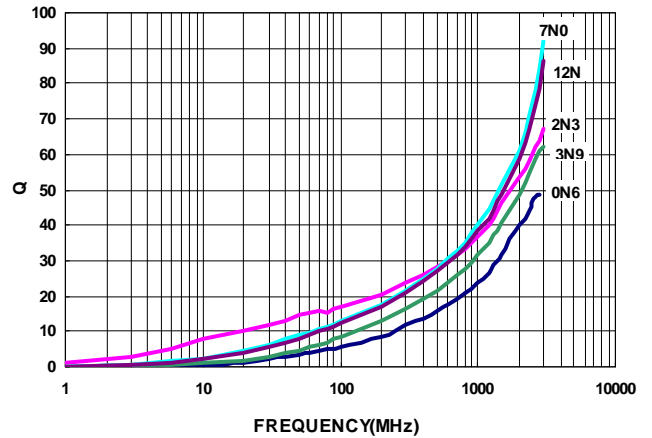
Note: When ordering, please specify tolerance code. Tolerance : J=±5% , K=±10%

- Operating temperature range - 40°C ~ 125°C(Including self - temperature rise)
- Irms for a 15°C temperature rise from 25°C ambient with current
- Measure Equipment :
 L & Q : Agilent E4991A+Agilent HP16197A
 SRF : Agilent HP8753D/Agilent HP8722ES
 RDC : HP4287A
 Irms : HP4284A+HP42841A/HP4285A+HP42841A

Typical **L** vs. **F** Frequency



Typical **Q** vs. **F** Frequency



Please be sure to request approval specifications that provide further details of the products. Kindly note that the content of these specifications are subject to change or may be discontinued without advance notice. Please contact our sales department before ordering.

Electrical Characteristics

| Part Number | Inductance (nH) | Tolerance (±%) | Test Frequency (MHz) | Q Min | SRF (GHz) Min | RDC (Ω) Max | Irms (mA) Max |
|---------------|-----------------|-----------------|----------------------|-------|---------------|-------------|---------------|
| CS0402-1N0□-S | 1.0 | 10 / 5 / ±0.1nH | 250 | 16 | 12.7 | 0.045 | 1360 |
| CS0402-1N2□-S | 1.2 | 10 / 5 / ±0.1nH | 250 | 10 | 10.4 | 0.140 | 640 |
| CS0402-1N3□-S | 1.3 | 10 / ±0.1nH | 250 | 10 | 10.4 | 0.140 | 640 |
| CS0402-1N9□-S | 1.9 | 10 / 5 / ±0.1nH | 250 | 16 | 11.3 | 0.070 | 1040 |
| CS0402-2N0□-S | 2.0 | 10 / 5 / ±0.1nH | 250 | 16 | 11.1 | 0.070 | 1040 |
| CS0402-2N2□-S | 2.2 | 10 / 5 / ±0.1nH | 250 | 19 | 10.8 | 0.070 | 960 |
| CS0402-2N4□-S | 2.4 | 10 / 5 / ±0.1nH | 250 | 15 | 10.5 | 0.068 | 790 |
| CS0402-2N5□-S | 2.5 | 10 / 5 / ±0.1nH | 250 | 13 | 10.4 | 0.150 | 640 |
| CS0402-2N7□-S | 2.7 | 10 / 5 / ±0.1nH | 250 | 16 | 10.4 | 0.120 | 640 |
| CS0402-3N3□-S | 3.3 | 10 / 5 / 3 | 250 | 19 | 7.00 | 0.066 | 840 |
| CS0402-3N6□-S | 3.6 | 10 / 5 / 3 | 250 | 19 | 6.80 | 0.066 | 840 |
| CS0402-3N9□-S | 3.9 | 10 / 5 / 3 | 250 | 19 | 6.00 | 0.066 | 840 |
| CS0402-4N3□-S | 4.3 | 10 / 5 / 3 | 250 | 18 | 6.00 | 0.091 | 700 |
| CS0402-4N7□-S | 4.7 | 10 / 5 / 3 | 250 | 15 | 4.77 | 0.130 | 640 |
| CS0402-5N1□-S | 5.1 | 10 / 5 / 3 | 250 | 20 | 4.80 | 0.083 | 800 |
| CS0402-5N6□-S | 5.6 | 10 / 5 / 3 | 250 | 20 | 4.80 | 0.083 | 760 |
| CS0402-5N8□-S | 5.8 | 10 / 5 / 3 | 250 | 20 | 4.80 | 0.083 | 760 |
| CS0402-6N2□-S | 6.2 | 10 / 5 / 3 | 250 | 20 | 4.80 | 0.083 | 760 |
| CS0402-6N8□-S | 6.8 | 10 / 5 / 3 | 250 | 20 | 4.80 | 0.083 | 680 |
| CS0402-7N3□-S | 7.3 | 10 / 5 / 3 | 250 | 20 | 4.80 | 0.12 | 680 |
| CS0402-7N5□-S | 7.5 | 10 / 5 / 3 | 250 | 22 | 4.80 | 0.10 | 680 |
| CS0402-8N2□-S | 8.2 | 10 / 5 / 3 | 250 | 22 | 4.40 | 0.10 | 680 |
| CS0402-8N7□-S | 8.7 | 10 / 5 / 3 | 250 | 18 | 4.10 | 0.20 | 480 |
| CS0402-9N0□-S | 9.0 | 10 / 5 / 3 | 250 | 22 | 4.16 | 0.10 | 680 |
| CS0402-9N1□-S | 9.1 | 10 / 5 / 3 | 250 | 22 | 4.16 | 0.10 | 680 |
| CS0402-9N5□-S | 9.5 | 10 / 5 / 3 | 250 | 18 | 4.00 | 0.20 | 480 |
| CS0402-10N□-S | 10 | 10 / 5 / 3 / 2 | 250 | 21 | 3.90 | 0.20 | 480 |
| CS0402-11N□-S | 11 | 10 / 5 / 3 / 2 | 250 | 24 | 3.68 | 0.12 | 640 |
| CS0402-12N□-S | 12 | 10 / 5 / 3 / 2 | 250 | 24 | 3.60 | 0.12 | 640 |
| CS0402-13N□-S | 13 | 10 / 5 / 3 / 2 | 250 | 24 | 3.45 | 0.21 | 440 |
| CS0402-15N□-S | 15 | 10 / 5 / 3 / 2 | 250 | 24 | 3.28 | 0.17 | 560 |
| CS0402-16N□-S | 16 | 10 / 5 / 3 / 2 | 250 | 24 | 3.10 | 0.22 | 560 |
| CS0402-18N□-S | 18 | 10 / 5 / 3 / 2 | 250 | 25 | 3.10 | 0.23 | 420 |
| CS0402-19N□-S | 19 | 10 / 5 / 3 / 2 | 250 | 24 | 3.04 | 0.20 | 480 |
| CS0402-20N□-S | 20 | 10 / 5 / 3 / 2 | 250 | 25 | 3.00 | 0.25 | 420 |
| CS0402-22N□-S | 22 | 10 / 5 / 3 / 2 | 250 | 25 | 2.80 | 0.30 | 400 |
| CS0402-23N□-S | 23 | 10 / 5 / 3 / 2 | 250 | 22 | 2.72 | 0.30 | 400 |
| CS0402-24N□-S | 24 | 10 / 5 / 3 / 2 | 250 | 25 | 2.70 | 0.30 | 400 |
| CS0402-27N□-S | 27 | 10 / 5 / 3 / 2 | 250 | 24 | 2.48 | 0.30 | 400 |
| CS0402-30N□-S | 30 | 10 / 5 / 3 / 2 | 250 | 25 | 2.35 | 0.35 | 400 |

Note: When ordering, please specify tolerance code. Tolerance : B=±0.1nH , G=±2% , H=±3% , J=±5% , K=±10%

- Operating temperature range - 40°C ~ 125°C(Including self - temperature rise)
- I rms for a 15°C temperature rise from 25°C ambient with current
- Measure Equipment :
L & Q : Agilent E4991A+Agilent HP16197A
SRF : Agilent HP8753D/Agilent HP8722ES
RDC : HP4287A
I rms : HP4284A+HP42841A/HP4285A+HP42841A

Please be sure to request approval specifications that provide further details of the products. Kindly note that the content of these specifications are subject to change or may be discontinued without advance notice. Please contact our sales department before ordering.

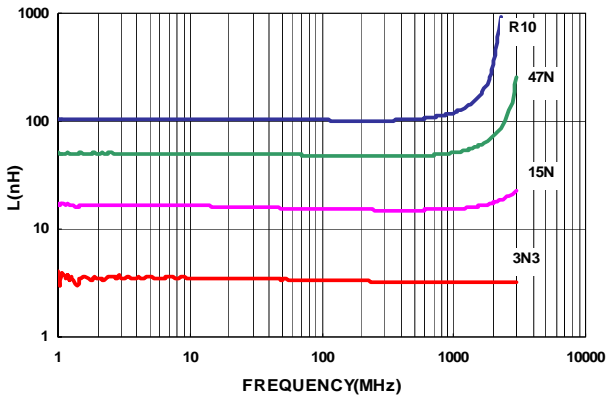
Electrical Characteristics

| Part Number | Inductance (nH) | Tolerance (±%) | Test Frequency (MHz) | Q Min | SRF (GHz) Min | RDC (Ω) Max | Irms (mA) Max |
|---------------|-----------------|----------------|----------------------|-------|---------------|-------------|---------------|
| CS0402-33N□-S | 33 | 10 / 5 / 3 / 2 | 250 | 24 | 2.35 | 0.40 | 400 |
| CS0402-36N□-S | 36 | 10 / 5 / 3 / 2 | 250 | 24 | 2.32 | 0.44 | 320 |
| CS0402-39N□-S | 39 | 10 / 5 / 3 / 2 | 250 | 25 | 2.10 | 0.55 | 200 |
| CS0402-40N□-S | 40 | 10 / 5 / 3 / 2 | 250 | 24 | 2.24 | 0.65 | 320 |
| CS0402-43N□-S | 43 | 10 / 5 / 3 / 2 | 250 | 25 | 2.03 | 0.81 | 100 |
| CS0402-47N□-S | 47 | 10 / 5 / 3 / 2 | 250 | 20 | 2.10 | 0.83 | 150 |
| CS0402-51N□-S | 51 | 10 / 5 / 3 / 2 | 250 | 25 | 1.75 | 0.82 | 100 |
| CS0402-56N□-S | 56 | 10 / 5 / 3 / 2 | 250 | 22 | 1.76 | 0.97 | 100 |
| CS0402-68N□-S | 68 | 10 / 5 / 3 / 2 | 250 | 22 | 1.62 | 1.12 | 100 |
| CS0402-82N□-S | 82 | 10 / 5 / 3 / 2 | 250 | 20 | 1.26 | 1.55 | 50 |
| CS0402-R10□-S | 100 | 10 / 5 / 3 / 2 | 250 | 20 | 1.16 | 2.00 | 30 |
| CS0402-R18□-S | 180 | 10 / 5 / 3 / 2 | 100 | 8 | 0.70 | 2.70 | 50 |
| CS0402-R22□-S | 220 | 10 / 5 / 3 / 2 | 100 | 8 | 0.70 | 4.00 | 50 |

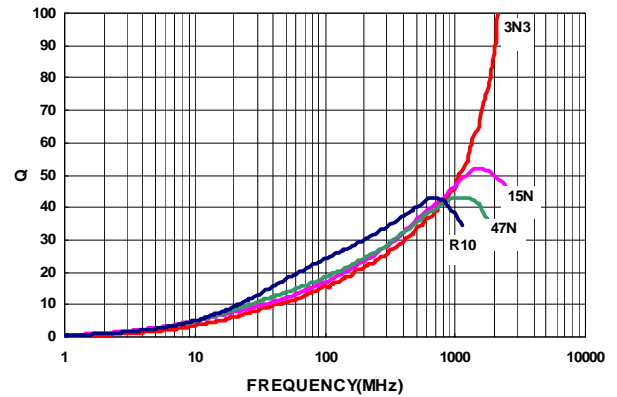
Note: When ordering, please specify tolerance code. Tolerance : B=±0.1nH , G=±2% , H=±3% , J=±5% , K=±10%

- Operating temperature range - 40°C ~ 125°C(Including self - temperature rise)
- I_{rms} for a 15°C temperature rise from 25°C ambient with current
- Measure Equipment :
 L & Q : Agilent E4991A+Agilent HP16197A
 SRF : Agilent HP8753D/Agilent HP8722ES
 RDC : HP4287A
 I_{rms} : HP4284A+HP42841A/HP4285A+HP42841A

Typical **L** vs. **Frequency**



Typical **Q** vs. **Frequency**



Please be sure to request approval specifications that provide further details of the products. Kindly note that the content of these specifications are subject to change or may be discontinued without advance notice. Please contact our sales department before ordering.

Electrical Characteristics

| Part Number | Inductance (nH) | Tolerance (±%) | Test Frequency (MHz) | Q Min | SRF (MHz) Min | RDC (Ω) Max | Irms (mA) Max | Color |
|---------------|--------------------|-------------------|----------------------------|----------|------------------|----------------|------------------|--------|
| CS0603-1N6□-S | 1.6 | 10 / 5 / ±0.1nH | 250 | 24 | 12500 | 0.030 | 700 | Red |
| CS0603-1N8□-S | 1.8 | 10 / 5 / ±0.1nH | 250 | 16 | 12500 | 0.045 | 700 | Black |
| CS0603-2N2□-S | 2.2 | 10 / 5 / ±0.1nH | 250 | 13 | 12500 | 0.250 | 700 | Yellow |
| CS0603-3N3□-S | 3.3 | 10 / 5 / 3 | 250 | 35 | 5900 | 0.045 | 700 | Blue |
| CS0603-3N6□-S | 3.6 | 10 / 5 / 3 / 2 | 250 | 22 | 5900 | 0.063 | 700 | Red |
| CS0603-3N9□-S | 3.9 | 10 / 5 / 3 / 2 | 250 | 22 | 6900 | 0.080 | 700 | Brown |
| CS0603-4N3□-S | 4.3 | 10 / 5 / 3 / 2 | 250 | 22 | 5900 | 0.063 | 700 | Orange |
| CS0603-4N7□-S | 4.7 | 10 / 5 / 3 / 2 | 250 | 20 | 5800 | 0.116 | 700 | Violet |
| CS0603-5N1□-S | 5.1 | 10 / 5 / 3 / 2 | 250 | 20 | 5700 | 0.140 | 700 | Green |
| CS0603-5N6□-S | 5.6 | 10 / 5 / 3 / 2 | 250 | 20 | 5800 | 0.170 | 700 | Yellow |
| CS0603-6N3□-S | 6.3 | 10 / 5 / 3 / 2 | 250 | 20 | 5700 | 0.140 | 700 | White |
| CS0603-6N8□-S | 6.8 | 10 / 5 / 3 / 2 | 250 | 27 | 5800 | 0.110 | 700 | Red |
| CS0603-7N5□-S | 7.5 | 10 / 5 / 3 / 2 | 250 | 28 | 4800 | 0.106 | 700 | Brown |
| CS0603-8N2□-S | 8.2 | 10 / 5 / 3 / 2 | 250 | 28 | 4700 | 0.109 | 700 | White |
| CS0603-8N7□-S | 8.7 | 10 / 5 / 3 / 2 | 250 | 28 | 4600 | 0.109 | 700 | Yellow |
| CS0603-9N1□-S | 9.1 | 10 / 5 / 3 / 2 | 250 | 28 | 4800 | 0.120 | 700 | Violet |
| CS0603-9N5□-S | 9.5 | 10 / 5 / 3 / 2 | 250 | 28 | 5400 | 0.135 | 700 | Blue |
| CS0603-10N□-S | 10 | 10 / 5 / 3 / 2 | 250 | 31 | 4800 | 0.130 | 700 | Orange |
| CS0603-11N□-S | 11 | 10 / 5 / 3 / 2 | 250 | 33 | 4000 | 0.086 | 700 | Gray |
| CS0603-12N□-S | 12 | 10 / 5 / 3 / 2 | 250 | 35 | 4000 | 0.130 | 700 | Yellow |
| CS0603-13N□-S | 13 | 10 / 5 / 3 / 2 | 250 | 30 | 4000 | 0.160 | 700 | Black |
| CS0603-15N□-S | 15 | 10 / 5 / 3 / 2 | 250 | 35 | 4000 | 0.170 | 700 | Green |
| CS0603-16N□-S | 16 | 10 / 5 / 3 / 2 | 250 | 34 | 3300 | 0.104 | 700 | White |
| CS0603-18N□-S | 18 | 10 / 5 / 3 / 2 | 250 | 35 | 3100 | 0.170 | 700 | Blue |
| CS0603-20N□-S | 20 | 10 / 5 / 3 / 2 | 250 | 38 | 3000 | 0.190 | 700 | Red |
| CS0603-22N□-S | 22 | 10 / 5 / 3 / 2 | 250 | 38 | 3000 | 0.190 | 700 | Violet |
| CS0603-23N□-S | 23 | 10 / 5 / 3 / 2 | 250 | 38 | 2850 | 0.190 | 700 | Orange |
| CS0603-24N□-S | 24 | 10 / 5 / 3 / 2 | 250 | 37 | 2650 | 0.135 | 700 | Black |
| CS0603-27N□-S | 27 | 10 / 5 / 3 / 2 | 250 | 40 | 2800 | 0.220 | 600 | Gray |
| CS0603-30N□-S | 30 | 10 / 5 / 3 / 2 | 250 | 37 | 2250 | 0.144 | 600 | Brown |
| CS0603-33N□-S | 33 | 10 / 5 / 3 / 2 | 250 | 40 | 2300 | 0.220 | 600 | White |
| CS0603-36N□-S | 36 | 10 / 5 / 3 / 2 | 250 | 38 | 2080 | 0.250 | 600 | Red |
| CS0603-39N□-S | 39 | 10 / 5 / 3 / 2 | 250 | 40 | 2200 | 0.250 | 600 | Black |
| CS0603-43N□-S | 43 | 10 / 5 / 3 / 2 | 250 | 39 | 2000 | 0.280 | 600 | Orange |
| CS0603-47N□-S | 47 | 10 / 5 / 3 / 2 | 200 | 38 | 2000 | 0.280 | 600 | Brown |
| CS0603-51N□-S | 51 | 10 / 5 / 3 / 2 | 200 | 38 | 1900 | 0.310 | 600 | Brown |
| CS0603-56N□-S | 56 | 10 / 5 / 3 / 2 | 200 | 38 | 1900 | 0.310 | 600 | Red |
| CS0603-68N□-S | 68 | 10 / 5 / 3 / 2 | 200 | 37 | 1700 | 0.340 | 600 | Orange |
| CS0603-72N□-S | 72 | 10 / 5 / 3 / 2 | 150 | 34 | 1700 | 0.490 | 400 | Yellow |
| CS0603-82N□-S | 82 | 10 / 5 / 3 / 2 | 150 | 34 | 1700 | 0.540 | 400 | Green |
| CS0603-91N□-S | 91 | 10 / 5 / 3 / 2 | 150 | 34 | 1400 | 0.580 | 400 | Black |

Note: When ordering, please specify tolerance code. Tolerance : B=±0.1nH , G=±2% , H=±3% , J=±5% , K=±10%

- Operating temperature range - 40°C ~ 125°C(Including self - temperature rise)
- Irms for a 15°C temperature rise from 25°C ambient with current
- Measure Equipment :

L & Q : Agilent E4991A+Agilent HP16197A

SRF : Agilent HP8753D/Agilent E4991A

RDC : Chroma 16502

Irms : HP4284A+HP42841A/HP4285A+HP42841A

Please be sure to request approval specifications that provide further details of the products. Kindly note that the content of these specifications are subject to change or may be discontinued without advance notice. Please contact our sales department before ordering.



Electrical Characteristics

| Part Number | Inductance (nH) | Tolerance (±%) | Test Frequency (MHz) | Q Min | SRF (MHz) Min | RDC (Ω) Max | Irms (mA) Max | Color |
|---------------|-----------------|----------------|----------------------|-------|---------------|-------------|---------------|--------|
| CS0603-R10□-S | 100 | 10 / 5 / 3 / 2 | 150 | 34 | 1400 | 0.580 | 400 | Blue |
| CS0603-R11□-S | 110 | 10 / 5 / 3 / 2 | 150 | 32 | 1350 | 0.610 | 300 | Violet |
| CS0603-R12□-S | 120 | 10 / 5 / 3 / 2 | 150 | 32 | 1300 | 0.750 | 300 | Gray |
| CS0603-R15□-S | 150 | 10 / 5 / 3 / 2 | 150 | 28 | 990 | 0.920 | 280 | White |
| CS0603-R16□-S | 160 | 10 / 5 / 3 / 2 | 100 | 25 | 990 | 1.250 | 240 | Yellow |
| CS0603-R18□-S | 180 | 10 / 5 / 3 / 2 | 100 | 25 | 990 | 1.250 | 240 | Black |
| CS0603-R20□-S | 200 | 10 / 5 / 3 / 2 | 100 | 25 | 900 | 2.100 | 200 | Red |
| CS0603-R21□-S | 210 | 10 / 5 / 3 / 2 | 100 | 27 | 895 | 2.060 | 200 | Gray |
| CS0603-R22□-S | 220 | 10 / 5 / 3 / 2 | 100 | 25 | 900 | 2.100 | 200 | Brown |
| CS0603-R24□-S | 240 | 10 / 5 / 3 / 2 | 100 | 25 | 900 | 2.200 | 200 | Green |
| CS0603-R25□-S | 250 | 10 / 5 / 3 / 2 | 100 | 25 | 822 | 3.550 | 120 | Violet |
| CS0603-R27□-S | 270 | 10 / 5 / 3 / 2 | 100 | 24 | 900 | 2.800 | 170 | Red |
| CS0603-R33□-S | 330 | 10 / 5 / 3 / 2 | 100 | 25 | 900 | 3.890 | 100 | Orange |
| CS0603-R39□-S | 390 | 10 / 5 / 3 / 2 | 100 | 25 | 900 | 4.350 | 100 | Yellow |
| CS0603-R47□-S | 470 | 10 / 5 / 3 / 2 | 100 | 25 | 500 | 4.500 | 100 | Brown |
| CS0603-R56□-S | 560 | 10 / 5 / 3 / 2 | 100 | 23 | 460 | 4.700 | 90 | Blue |

Note: When ordering, please specify tolerance code. Tolerance : B=±0.1nH , G=±2% , H=±3% , J=±5% , K=±10%

- Operating temperature range - 40°C ~ 125°C(Including self - temperature rise)
- Irms for a 15°C temperature rise from 25°C ambient with current
- Measure Equipment :

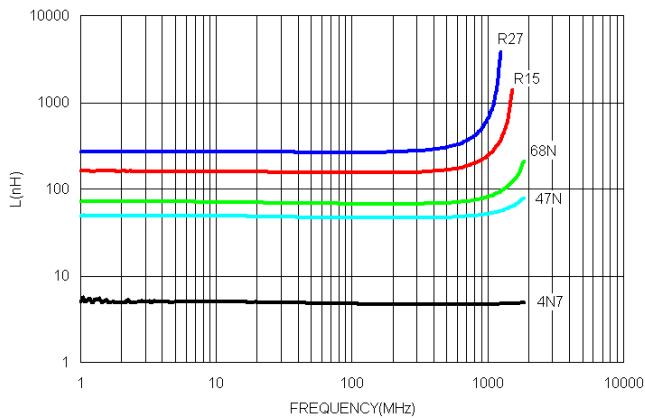
L & Q : Agilent E4991A+Agilent HP16197A

SRF : Agilent HP8753D/Agilent E4991A

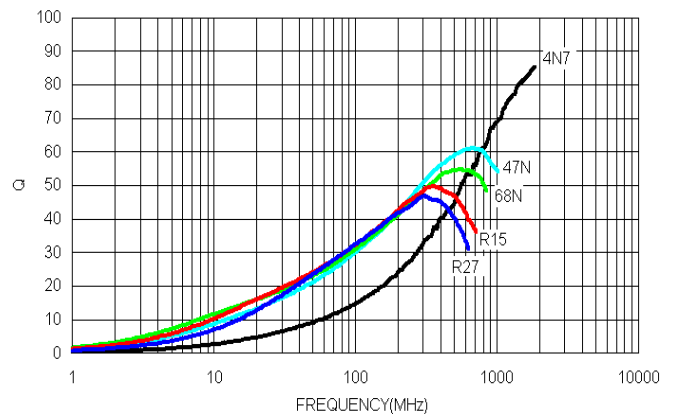
RDC : Chroma 16502

Irms : HP4284A+HP42841A/HP4285A+HP42841A

Typical L vs. Frequency



Typical Q vs. Frequency



Please be sure to request approval specifications that provide further details of the products. Kindly note that the content of these specifications are subject to change or may be discontinued without advance notice. Please contact our sales department before ordering.

SMD Wire Wound Ceramic Chip Inductors - CS Series

Electrical Characteristics

| Part Number | Inductance (nH) | Tolerance (±%) | Test Frequency (MHz) | Q Min | Test Frequency (MHz) | SRF (MHz) Min | RDC (Ω) Max | I _{rms} (mA) Max | Color |
|---------------|-----------------|----------------|----------------------|-------|----------------------|---------------|-------------|---------------------------|--------|
| CS0805-2N7□-S | 2.7 | 10 / 5 / 2 | 250 | 50 | 1500 | 7900 | 0.06 | 800 | Yellow |
| CS0805-2N8□-S | 2.8 | 10 / 5 / 2 | 250 | 80 | 1500 | 7900 | 0.06 | 800 | Gray |
| CS0805-3N0□-S | 3.0 | 10 / 5 / 2 | 250 | 65 | 1500 | 7900 | 0.06 | 800 | White |
| CS0805-3N3□-S | 3.3 | 10 / 5 / 2 | 250 | 50 | 1500 | 7900 | 0.08 | 600 | Black |
| CS0805-5N6□-S | 5.6 | 10 / 5 / 2 | 250 | 65 | 1000 | 5500 | 0.08 | 600 | Orange |
| CS0805-6N8□-S | 6.8 | 10 / 5 / 2 | 250 | 50 | 1000 | 5500 | 0.11 | 600 | Brown |
| CS0805-7N5□-S | 7.5 | 10 / 5 / 2 | 250 | 50 | 1000 | 4500 | 0.14 | 600 | Green |
| CS0805-8N2□-S | 8.2 | 10 / 5 / 2 | 250 | 50 | 1000 | 4700 | 0.12 | 600 | Red |
| CS0805-10N□-S | 10 | 10 / 5 / 2 | 250 | 60 | 500 | 4200 | 0.10 | 600 | Blue |
| CS0805-12N□-S | 12 | 10 / 5 / 2 | 250 | 50 | 500 | 4000 | 0.15 | 600 | Orange |
| CS0805-15N□-S | 15 | 10 / 5 / 2 | 250 | 50 | 500 | 3400 | 0.17 | 600 | Yellow |
| CS0805-18N□-S | 18 | 10 / 5 / 2 | 250 | 50 | 500 | 3300 | 0.20 | 600 | Green |
| CS0805-22N□-S | 22 | 10 / 5 / 2 | 250 | 55 | 500 | 2600 | 0.22 | 500 | Blue |
| CS0805-24N□-S | 24 | 10 / 5 / 2 | 250 | 50 | 500 | 2000 | 0.22 | 500 | Gray |
| CS0805-27N□-S | 27 | 10 / 5 / 2 | 250 | 55 | 500 | 2500 | 0.25 | 500 | Violet |
| CS0805-33N□-S | 33 | 10 / 5 / 2 | 250 | 60 | 500 | 2050 | 0.27 | 500 | Gray |
| CS0805-36N□-S | 36 | 10 / 5 / 2 | 250 | 55 | 500 | 1700 | 0.27 | 500 | Orange |
| CS0805-39N□-S | 39 | 10 / 5 / 2 | 250 | 60 | 500 | 2000 | 0.29 | 500 | White |
| CS0805-43N□-S | 43 | 10 / 5 / 2 | 200 | 60 | 500 | 1650 | 0.34 | 500 | Yellow |
| CS0805-47N□-S | 47 | 10 / 5 / 2 | 200 | 60 | 500 | 1650 | 0.31 | 500 | Black |
| CS0805-56N□-S | 56 | 10 / 5 / 2 | 200 | 60 | 500 | 1550 | 0.34 | 500 | Brown |
| CS0805-68N□-S | 68 | 10 / 5 / 2 | 200 | 60 | 500 | 1450 | 0.38 | 500 | Red |
| CS0805-82N□-S | 82 | 10 / 5 / 2 | 150 | 65 | 500 | 1300 | 0.42 | 400 | Orange |
| CS0805-91N□-S | 91 | 10 / 5 / 2 | 150 | 65 | 500 | 1200 | 0.48 | 400 | Black |
| CS0805-R10□-S | 100 | 10 / 5 / 2 | 150 | 65 | 500 | 1200 | 0.46 | 400 | Yellow |
| CS0805-R11□-S | 110 | 10 / 5 / 2 | 150 | 50 | 250 | 1000 | 0.48 | 400 | Brown |
| CS0805-R12□-S | 120 | 10 / 5 / 2 | 150 | 50 | 250 | 1100 | 0.51 | 400 | Green |
| CS0805-R15□-S | 150 | 10 / 5 / 2 | 100 | 50 | 250 | 920 | 0.56 | 400 | Blue |
| CS0805-R18□-S | 180 | 10 / 5 / 2 | 100 | 50 | 250 | 870 | 0.64 | 400 | Violet |
| CS0805-R20□-S | 200 | 10 / 5 / 2 | 100 | 50 | 250 | 860 | 0.68 | 400 | Red |
| CS0805-R22□-S | 220 | 10 / 5 / 2 | 100 | 50 | 250 | 850 | 0.70 | 400 | Gray |
| CS0805-R24□-S | 240 | 10 / 5 / 2 | 100 | 44 | 250 | 690 | 1.00 | 350 | Red |
| CS0805-R25□-S | 250 | 10 / 5 / 2 | 100 | 45 | 250 | 660 | 1.20 | 350 | Yellow |
| CS0805-R27□-S | 270 | 10 / 5 / 2 | 100 | 48 | 250 | 650 | 1.00 | 350 | White |
| CS0805-R30□-S | 300 | 10 / 5 / 2 | 100 | 25 | 250 | 450 | 1.40 | 310 | Orange |
| CS0805-R33□-S | 330 | 10 / 5 / 2 | 100 | 48 | 250 | 600 | 1.40 | 310 | Black |
| CS0805-R39□-S | 390 | 10 / 5 / 2 | 100 | 48 | 250 | 450 | 1.50 | 290 | Brown |
| CS0805-R47□-S | 470 | 10 / 5 / 2 | 50 | 33 | 100 | 375 | 1.76 | 250 | Violet |
| CS0805-R51□-S | 510 | 10 / 5 / 2 | 25 | 23 | 50 | 340 | 1.90 | 230 | Gray |
| CS0805-R56□-S | 560 | 10 / 5 / 2 | 25 | 23 | 50 | 340 | 1.90 | 230 | Orange |
| CS0805-R62□-S | 620 | 10 / 5 / 2 | 25 | 23 | 50 | 220 | 2.20 | 210 | Yellow |
| CS0805-R68□-S | 680 | 10 / 5 / 2 | 25 | 23 | 50 | 188 | 2.20 | 190 | Green |

Note: When ordering, please specify tolerance code. Tolerance : G=±2% , J=±5% , K=±10%

- Operating temperature range - 40°C ~ 125°C(Including self - temperature rise)
- I_{rms} for a 15°C temperature rise from 25°C ambient with current
- Measure Equipment :
 L & Q : Agilent E4991A+Agilent HP16197A
 SRF : Agilent HP8753D/Agilent E4991A
 RDC : Chroma 16502
 I_{rms} : HP4284A+HP42841A/HP4285A+HP42841A

Please be sure to request approval specifications that provide further details of the products. Kindly note that the content of these specifications are subject to change or may be discontinued without advance notice. Please contact our sales department before ordering.

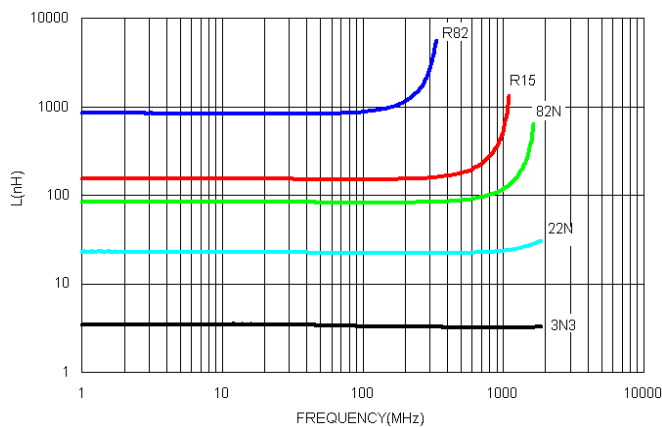
Electrical Characteristics

| Part Number | Inductance (nH) | Tolerance (±%) | Test Frequency (MHz) | Q Min | Test Frequency (MHz) | SRF (MHz) Min | RDC (Ω) Max | I _{rms} (mA) Max | Color |
|---------------|-----------------|----------------|----------------------|-------|----------------------|---------------|-------------|---------------------------|--------|
| CS0805-R82□-S | 820 | 10 / 5 / 2 | 25 | 23 | 50 | 215 | 2.35 | 180 | Blue |
| CS0805-1R0□-S | 1000 | 10 / 5 / 2 | 25 | 20 | 50 | 100 | 2.50 | 170 | Gray |
| CS0805-1R2□-S | 1200 | 10 / 5 | 7.9 | 18 | 25 | 100 | 2.50 | 170 | White |
| CS0805-1R8□-S | 1800 | 10 / 5 / 2 | 7.9 | 16 | 7.9 | 80 | 2.50 | 170 | Orange |
| CS0805-3R3□-S | 3300 | 10 / 5 / 2 | 7.9 | 15 | 7.9 | 40 | 4.40 | 90 | Red |
| CS0805-4R7□-S | 4700 | 10 / 5 / 2 | 7.9 | 15 | 7.9 | 40 | 6.40 | 90 | Yellow |

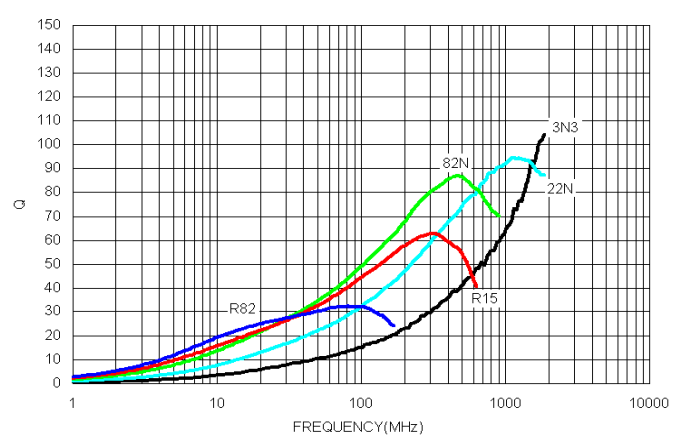
Note: When ordering, please specify tolerance code. Tolerance : G=±2% , J=±5% , K=±10%

- Operating temperature range - 40°C ~ 125°C(Including self - temperature rise)
- I_{rms} for a 15°C temperature rise from 25°C ambient with current
- Measure Equipment :
 L & Q : Agilent E4991A+Agilent HP16197A
 SRF : Agilent HP8753D/Agilent E4991A
 RDC : Chroma 16502
 I_{rms} : HP4284A+HP42841A/HP4285A+HP42841A

Typical **L** vs. **F** Frequency



Typical **Q** vs. **F** Frequency



Please be sure to request approval specifications that provide further details of the products. Kindly note that the content of these specifications are subject to change or may be discontinued without advance notice. Please contact our sales department before ordering.

Electrical Characteristics

| Part Number | Inductance (nH) | Tolerance (±%) | Test Frequency (MHz) | Q Min | Test Frequency (MHz) | SRF (MHz) Min | RDC (Ω) Max | I _{rms} (mA) Max | Color Coding | | |
|---------------|--------------------|-------------------|----------------------------|----------|----------------------------|------------------|----------------|------------------------------|-----------------|-----------------|-----------------|
| | | | | | | | | | 1 ST | 2 ND | 3 RD |
| CS1008-10N□-S | 10 | 10 / 5 / 2 | 50 | 50 | 500 | 4100 | 0.08 | 1000 | Brown | Black | Black |
| CS1008-12N□-S | 12 | 10 / 5 / 2 | 50 | 50 | 500 | 3300 | 0.09 | 1000 | Brown | Red | Black |
| CS1008-15N□-S | 15 | 10 / 5 / 2 | 50 | 50 | 500 | 2500 | 0.10 | 1000 | Brown | Green | Black |
| CS1008-18N□-S | 18 | 10 / 5 / 2 | 50 | 50 | 350 | 2500 | 0.11 | 1000 | Brown | Gray | Black |
| CS1008-22N□-S | 22 | 10 / 5 / 2 | 50 | 55 | 350 | 2400 | 0.12 | 1000 | Red | Red | Black |
| CS1008-27N□-S | 27 | 10 / 5 / 2 | 50 | 55 | 350 | 1600 | 0.13 | 1000 | Red | Violet | Black |
| CS1008-33N□-S | 33 | 10 / 5 / 2 | 50 | 60 | 350 | 1600 | 0.14 | 1000 | Orange | Orange | Black |
| CS1008-39N□-S | 39 | 10 / 5 / 2 | 50 | 60 | 350 | 1500 | 0.15 | 1000 | Orange | White | Black |
| CS1008-47N□-S | 47 | 10 / 5 / 2 | 50 | 65 | 350 | 1500 | 0.16 | 1000 | Yellow | Violet | Black |
| CS1008-56N□-S | 56 | 10 / 5 / 2 | 50 | 65 | 350 | 1300 | 0.18 | 1000 | Green | Blue | Black |
| CS1008-68N□-S | 68 | 10 / 5 / 2 | 50 | 65 | 350 | 1300 | 0.20 | 1000 | Blue | Gray | Black |
| CS1008-82N□-S | 82 | 10 / 5 / 2 | 50 | 60 | 350 | 1000 | 0.22 | 1000 | Gray | Red | Black |
| CS1008-R10□-S | 100 | 10 / 5 / 2 | 25 | 60 | 350 | 1000 | 0.56 | 650 | Brown | Black | Brown |
| CS1008-R12□-S | 120 | 10 / 5 / 2 | 25 | 60 | 350 | 950 | 0.63 | 650 | Brown | Red | Brown |
| CS1008-R15□-S | 150 | 10 / 5 / 2 | 25 | 45 | 100 | 850 | 0.70 | 580 | Brown | Green | Brown |
| CS1008-R18□-S | 180 | 10 / 5 / 2 | 25 | 45 | 100 | 750 | 0.77 | 620 | Brown | Gray | Brown |
| CS1008-R20□-S | 200 | 10 / 5 / 2 | 25 | 45 | 100 | 700 | 0.84 | 500 | Red | Black | Brown |
| CS1008-R22□-S | 220 | 10 / 5 / 2 | 25 | 45 | 100 | 700 | 0.84 | 500 | Red | Red | Brown |
| CS1008-R27□-S | 270 | 10 / 5 / 2 | 25 | 45 | 100 | 600 | 0.91 | 500 | Red | Violet | Brown |
| CS1008-R33□-S | 330 | 10 / 5 / 2 | 25 | 45 | 100 | 570 | 1.05 | 450 | Orange | Orange | Brown |
| CS1008-R39□-S | 390 | 10 / 5 / 2 | 25 | 45 | 100 | 500 | 1.12 | 470 | Orange | White | Brown |
| CS1008-R47□-S | 470 | 10 / 5 / 2 | 25 | 45 | 100 | 450 | 1.19 | 470 | Yellow | Violet | Brown |
| CS1008-R56□-S | 560 | 10 / 5 / 2 | 25 | 45 | 100 | 415 | 1.33 | 400 | Green | Blue | Brown |
| CS1008-R62□-S | 620 | 10 / 5 / 2 | 25 | 45 | 100 | 375 | 1.40 | 300 | Blue | Red | Brown |
| CS1008-R68□-S | 680 | 10 / 5 / 2 | 25 | 45 | 100 | 375 | 1.47 | 400 | Blue | Gray | Brown |
| CS1008-R75□-S | 750 | 10 / 5 / 2 | 25 | 45 | 100 | 360 | 1.54 | 360 | Violet | Green | Brown |
| CS1008-R82□-S | 820 | 10 / 5 / 2 | 25 | 45 | 100 | 350 | 1.61 | 400 | Gray | Red | Brown |
| CS1008-R91□-S | 910 | 10 / 5 / 2 | 25 | 35 | 50 | 320 | 1.68 | 380 | White | Brown | Brown |
| CS1008-1R0□-S | 1000 | 10 / 5 / 2 | 25 | 35 | 50 | 290 | 1.75 | 370 | Brown | Black | Red |
| CS1008-1R2□-S | 1200 | 10 / 5 / 2 | 7.9 | 35 | 50 | 250 | 2.0 | 310 | Brown | Red | Red |
| CS1008-1R5□-S | 1500 | 10 / 5 / 2 | 7.9 | 28 | 50 | 200 | 2.3 | 330 | Brown | Green | Red |
| CS1008-1R8□-S | 1800 | 10 / 5 / 2 | 7.9 | 28 | 50 | 160 | 2.6 | 300 | Brown | Gray | Red |
| CS1008-2R2□-S | 2200 | 10 / 5 / 2 | 7.9 | 28 | 50 | 160 | 2.8 | 280 | Red | Red | Red |
| CS1008-2R7□-S | 2700 | 10 / 5 / 2 | 7.9 | 22 | 25 | 140 | 3.2 | 290 | Red | Violet | Red |
| CS1008-3R3□-S | 3300 | 10 / 5 / 2 | 7.9 | 22 | 25 | 110 | 3.4 | 290 | Orange | Orange | Red |
| CS1008-3R9□-S | 3900 | 10 / 5 / 2 | 7.9 | 20 | 25 | 100 | 3.6 | 260 | Orange | White | Red |
| CS1008-4R7□-S | 4700 | 10 / 5 / 2 | 7.9 | 20 | 25 | 90 | 4.0 | 260 | Yellow | Violet | Red |
| CS1008-5R6□-S | 5600 | 10 / 5 / 2 | 7.9 | 18 | 7.9 | 45 | 4.0 | 240 | Green | Blue | Red |
| CS1008-6R8□-S | 6800 | 10 / 5 / 2 | 7.9 | 18 | 7.9 | 40 | 4.9 | 200 | Blue | Gray | Red |
| CS1008-8R2□-S | 8200 | 10 / 5 / 2 | 7.9 | 18 | 7.9 | 25 | 6.0 | 170 | Gray | Red | Red |
| CS1008-100□-S | 10000 | 10 / 5 / 2 | 2.52 | 18 | 7.9 | 25 | 8.0 | 150 | Brown | Black | Orange |
| CS1008-150□-S | 15000 | 10 / 5 / 2 | 2.52 | 15 | 7.9 | 20 | 11 | 100 | Brown | Green | Orange |

Note: When ordering, please specify tolerance code. Tolerance : G=±2% , J=±5% , K=±10%

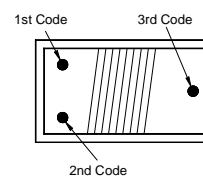
- Operating temperature range - 40°C ~ 125°C(Including self - temperature rise)
- I_{rms} for a 15°C temperature rise from 25°C ambient with current
- Measure Equipment :

L & Q : Agilent E4991A+Agilent HP16197A

SRF : Agilent HP8753D/Agilent E4991A

RDC : Chroma 16502

I_{rms} : HP4284A+HP42841A/HP4285A+HP42841A

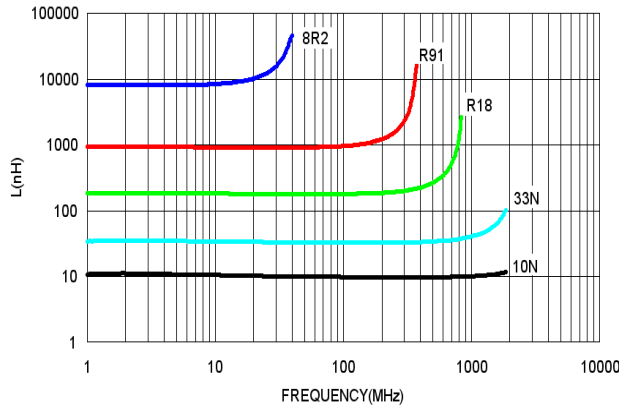


COLOR CODING

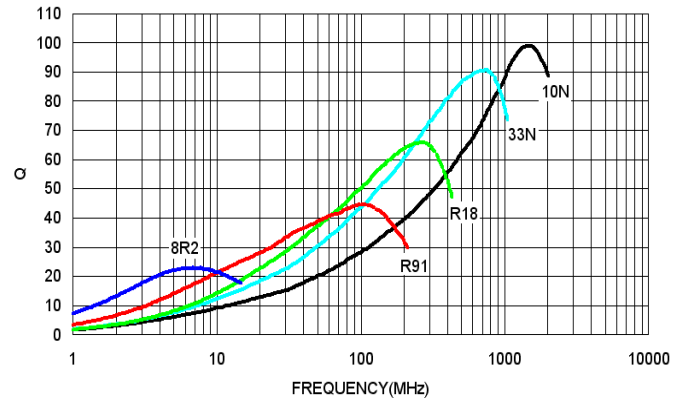
Please be sure to request approval specifications that provide further details of the products. Kindly note that the content of these specifications are subject to change or may be discontinued without advance notice. Please contact our sales department before ordering.

SMD Wire Wound Ceramic Chip Inductors - CS Series

Typical **L** vs. **F**requency



Typical **Q** vs. **F**requency



Please be sure to request approval specifications that provide further details of the products. Kindly note that the content of these specifications are subject to change or may be discontinued without advance notice. Please contact our sales department before ordering.

Packaging Specifications

Tape Dimensions

Figure 1

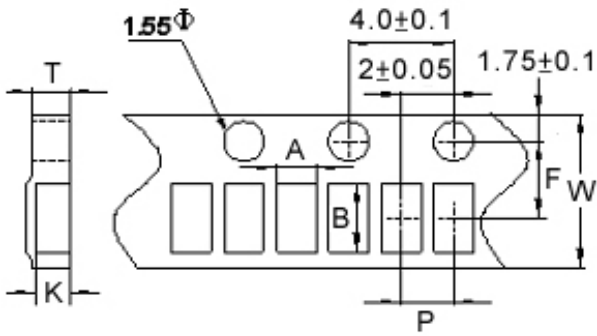


Figure 2

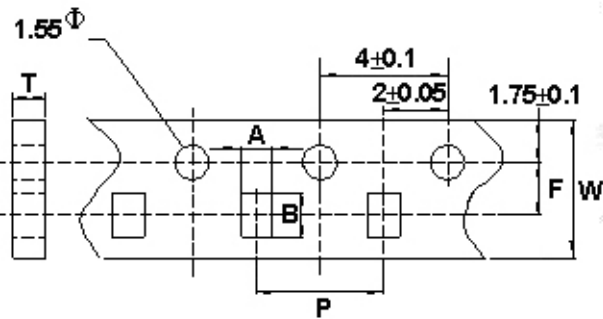
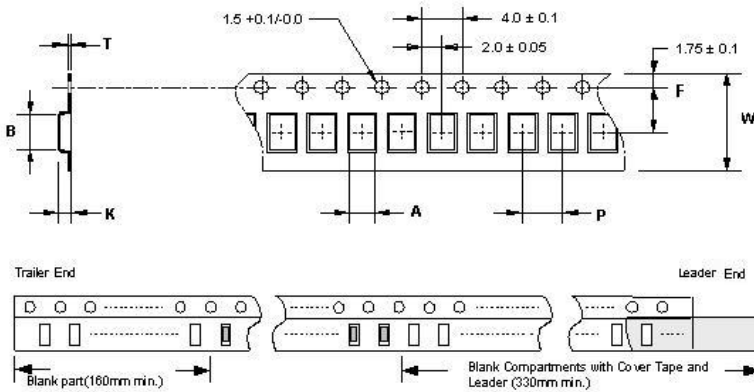
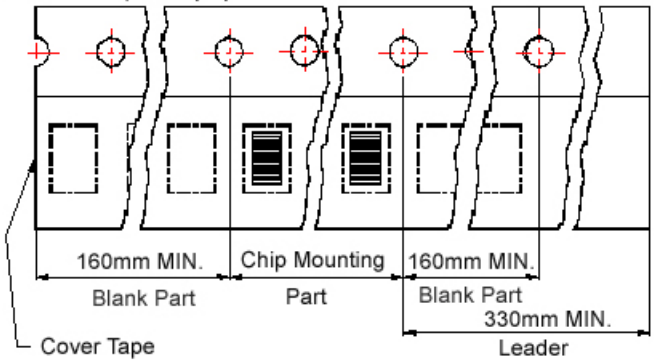


Figure 3

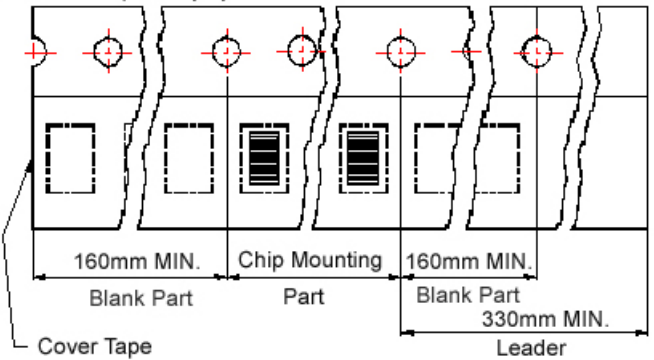


Tape Material

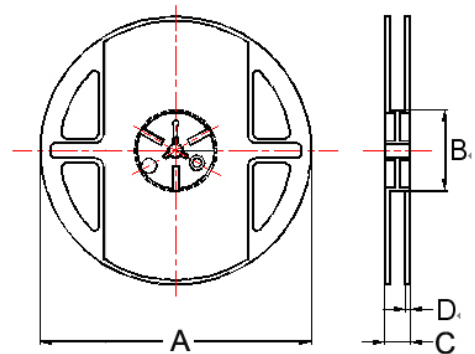
Carrier Tape: Paper
Cover Tape: Polystyrene



Carrier Tape: Paper
Cover Tape: Polystyrene



Reel Dimensions



Dimensions in mm

| TYPE | Fig. | Tape Dimensions | | | | | | | Reel Dimensions | | | | Quantity PCS / Reel |
|--------|------|-----------------|------|------|---|---|-----|------|-----------------|----|----|-----|------------------------|
| | | A | B | T | W | P | F | K | A | B | C | D | |
| CS0201 | 1 | 0.47 | 0.57 | 0.65 | 8 | 2 | 3.5 | 0.45 | 178 | 60 | 12 | 1.5 | 4000 |
| CS0402 | 1 | 0.67 | 1.20 | 0.75 | 8 | 2 | 3.5 | 0.59 | 178 | 60 | 12 | 1.5 | 4000 |
| CS0603 | 2 | 1.20 | 1.80 | 1.05 | 8 | 4 | 3.5 | - | 178 | 60 | 12 | 1.5 | 4000 |
| CS0805 | 3 | 1.85 | 2.45 | 0.23 | 8 | 4 | 3.5 | 1.50 | 178 | 60 | 12 | 1.5 | 2000 |
| CS1008 | 3 | 2.80 | 2.95 | 0.23 | 8 | 4 | 3.5 | 2.20 | 178 | 60 | 12 | 1.5 | 2000 |

PM Series



Due to accurate wire winding technology, these chip inductors are designed for filtering, impedance matching, resonance and choke circuits for RF designer. Both standard series custom designs are available.

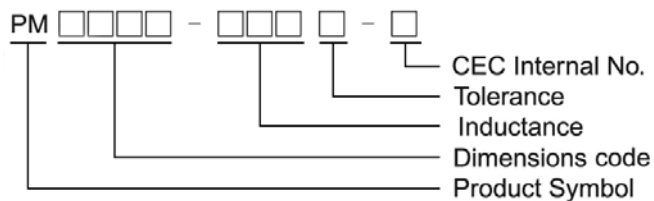
Features

- RoHS Compliant and Halogen Free
- Ceramic body and wire wound construction provide high Q and SRFs
- Higher Q and lower DCR than other inductors
- Exceptional current handling capability
- PM series is for high power and high frequency application

Applications

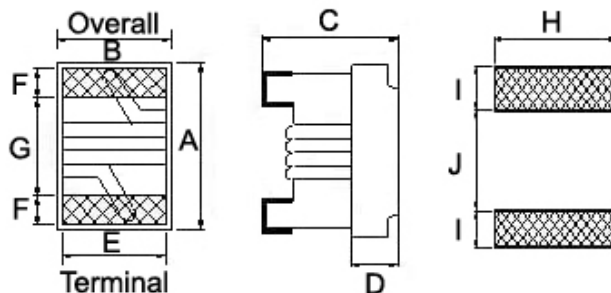
- Wireless embedded portable devices
- GPS receiver
- Base Station
- Repeater
- Set Top Box
- Cable / IP Modem
- Security system and other RF modules

Product Identification



Shape and Dimensions / Recommended Pattern

PM0603



Dimensions

| | A | B | C | D | E | F | G | H | I | J |
|---------------|-------------------------------------|------------|--------------------------------------|------|------|------|------|------|------|------|
| PM0603 | 1.6 ^{+0.2} _{-0.1} | 1.12 ± 0.1 | 0.82 ^{+0.2} _{-0.1} | 0.30 | 0.95 | 0.30 | 0.70 | 1.02 | 0.64 | 0.64 |

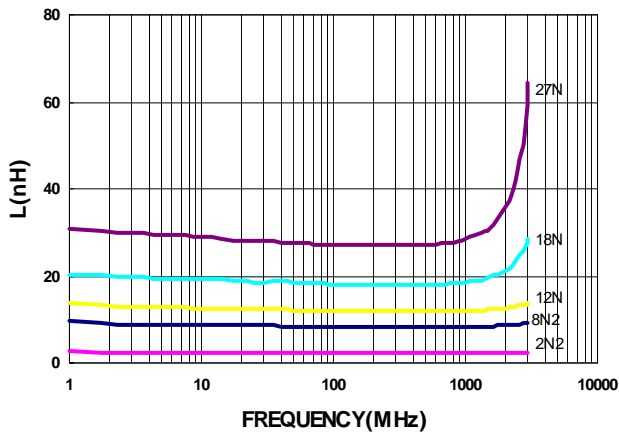
Electrical Characteristics

| Part Number | Inductance (nH) | Tolerance (±%) | Test Frequency (MHz) | Q Min | Test Frequency (MHz) | SRF (GHz) Min | RDC (Ω) Max | Irms (mA) Max | Color |
|---------------|-----------------|----------------|----------------------|-------|----------------------|---------------|-------------|---------------|--------|
| PM0603-2N2□-N | 2.2 | ±0.5nH | 100 | 25 | 250 | 18 | 0.018 | 1400 | Black |
| PM0603-3N9□-N | 3.9 | ±0.2nH/±0.5nH | 100 | 38 | 250 | 11 | 0.032 | 1000 | Brown |
| PM0603-5N6□-N | 5.6 | ±0.5nH | 100 | 38 | 250 | 10 | 0.045 | 900 | Red |
| PM0603-6N8□-N | 6.8 | ±0.2nH/±0.5nH | 100 | 38 | 250 | 7 | 0.045 | 900 | Orange |
| PM0603-8N2□-N | 8.2 | ±0.5nH | 100 | 38 | 250 | 7 | 0.058 | 800 | Yellow |
| PM0603-10N□-N | 10 | 5 / 2 | 100 | 38 | 250 | 5 | 0.058 | 800 | Green |
| PM0603-12N□-N | 12 | 5 / 2 | 100 | 38 | 250 | 5 | 0.071 | 750 | Blue |
| PM0603-15N□-N | 15 | 5 | 100 | 42 | 250 | 4.5 | 0.085 | 700 | Violet |
| PM0603-18N□-N | 18 | 5 / 2 | 100 | 42 | 250 | 3.5 | 0.085 | 700 | Gray |
| PM0603-22N□-N | 22 | 5 / 2 | 100 | 42 | 250 | 3.3 | 0.099 | 640 | White |
| PM0603-27N□-N | 27 | 5 / 2 | 100 | 42 | 250 | 2.8 | 0.116 | 590 | Black |
| PM0603-33N□-N | 33 | 5 | 100 | 42 | 250 | 2.5 | 0.132 | 550 | Brown |

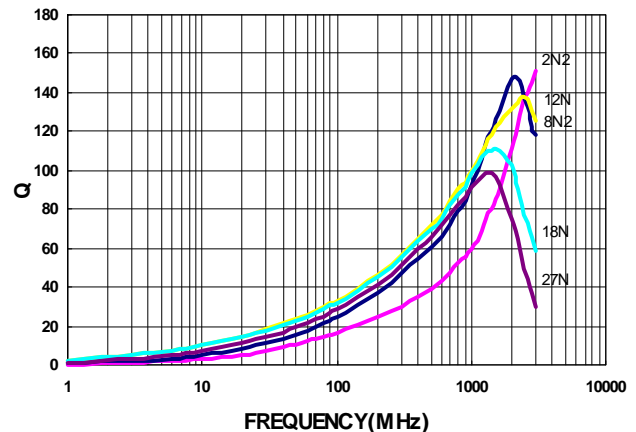
Note: When ordering, please specify tolerance code. Tolerance : C=±0.2nH , D=±0.5nH , G=±2% , J=±5%

- Operating temperature range - 40°C ~ 125°C(Including self - temperature rise)
- Irms for a 15°C temperature rise from 25°C ambient with current
- Measure Equipment :
 L & Q : Agilent E4991A+Agilent HP16197A
 SRF : Agilent HP8753D
 RDC : Chroma 16502
 Irms : HP4284A+HP42841A/HP4285A+HP42841A

Typical **L** vs. **F**requency

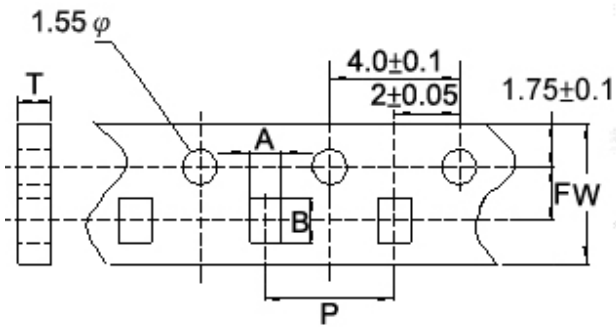


Typical **Q** vs. **F**requency

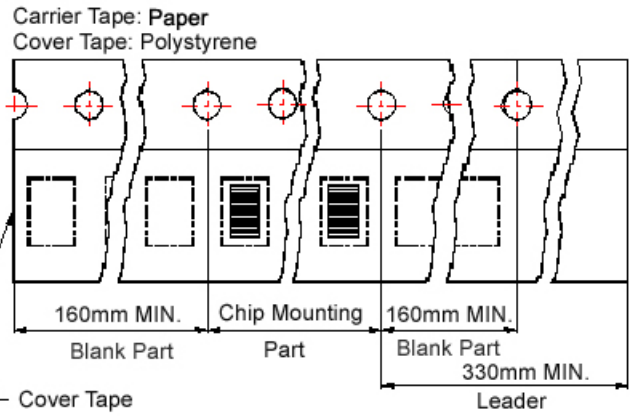


Packaging Specifications

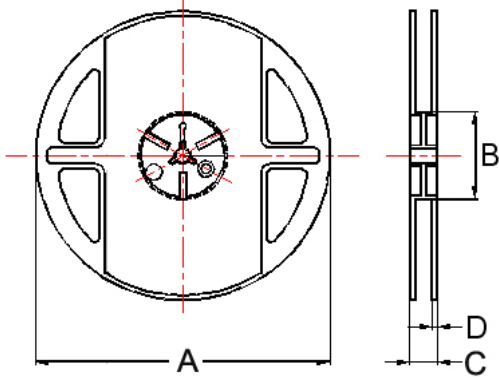
Tape Dimensions



Tape Material



Reel Dimensions



Dimensions in mm

| TYPE | Tape Dimensions | | | | | | Reel Dimensions | | | | Quantity PCS / Reel |
|--------|-----------------|------|------|---|---|-----|-----------------|----|----|-----|------------------------|
| | A | B | T | W | P | F | A | B | C | D | |
| PM0603 | 1.23 | 1.90 | 1.05 | 8 | 4 | 3.5 | 178 | 60 | 12 | 1.5 | 4000 |

HP Series



Due to accurate wire winding technology, these chip inductors are designed for filtering, impedance matching, resonance and choke circuits for RF designer. Both standard series custom designs are available.

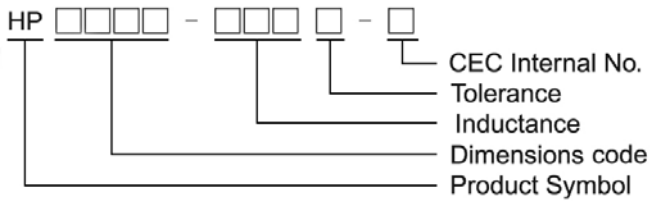
Features

- RoHS Compliant and Halogen Free
- Ceramic body and wire wound construction provide high Q and SRFs
- Higher Q and lower DCR than other inductors
- Exceptional current handling capability
- HP series is for high power and high frequency application

Applications

- Wireless embedded portable devices
- GPS receiver
- Base Station
- Repeater
- Set Top Box
- Cable / IP Modem
- Security system and other RF modules

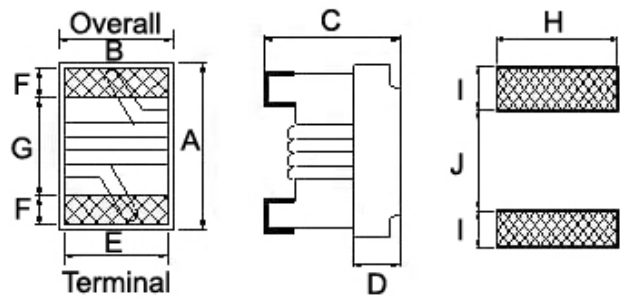
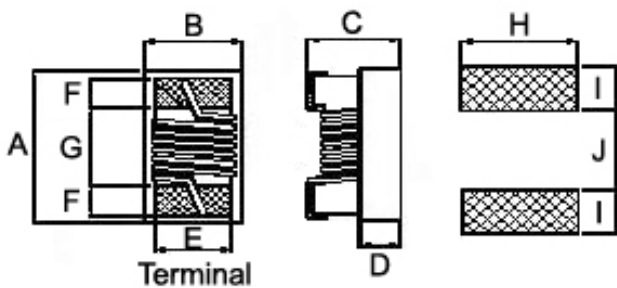
Product Identification



Shape and Dimensions / Recommended Pattern

HP0402

HP0603



Dimensions

| | A | B | C | D | E | F | G | H | I | J |
|---------------|-------------------------------------|-------------|--------------------------------------|------|------|------|------|------|------|------|
| HP0402 | 1.1 ± 0.05 | 0.70 ± 0.05 | 0.6 ± 0.05 | 0.25 | 0.45 | 0.20 | 0.54 | 0.66 | 0.36 | 0.51 |
| HP0603 | 1.6 ^{+0.2} _{-0.1} | 1.00 ± 0.1 | 0.82 ^{+0.2} _{-0.1} | 0.30 | 0.70 | 0.30 | 0.95 | 1.02 | 0.64 | 0.64 |

Electrical Characteristics

| Part Number | Inductance (nH) | Tolerance (±%) | Test Frequency (MHz) | Q Typ. | Test Frequency (MHz) | SRF (GHz) Typ. | RDC (Ω) Max | Irms (mA) Max |
|---------------|-----------------|----------------|----------------------|--------|----------------------|----------------|-------------|---------------|
| HP0402-1N0□-N | 1.0 | ±0.1nH | 250 | 18 | 250 | 16.0 | 0.030 | 2300 |
| HP0402-2N0□-N | 2.0 | ±0.2nH | 250 | 18 | 250 | 15.2 | 0.038 | 2100 |
| HP0402-2N2□-N | 2.2 | ±0.2nH | 250 | 25 | 250 | 15.1 | 0.045 | 2100 |
| HP0402-2N4□-N | 2.4 | ±0.2nH | 250 | 25 | 250 | 14.0 | 0.045 | 2000 |
| HP0402-2N7□-N | 2.7 | ±0.2nH | 250 | 20 | 250 | 13.0 | 0.090 | 1500 |
| HP0402-3N3□-N | 3.3 | 3 / 5 | 250 | 20 | 250 | 12.8 | 0.050 | 1700 |
| HP0402-3N6□-N | 3.6 | 3 / 5 | 250 | 28 | 250 | 11.7 | 0.065 | 1700 |
| HP0402-3N9□-N | 3.9 | 3 / 5 | 250 | 28 | 250 | 9.50 | 0.065 | 1700 |
| HP0402-4N3□-N | 4.3 | 3 / 5 | 250 | 22 | 250 | 7.15 | 0.060 | 1600 |
| HP0402-4N7□-N | 4.7 | 3 / 5 | 250 | 18 | 250 | 6.85 | 0.115 | 1500 |
| HP0402-5N1□-N | 5.1 | 3 / 5 | 250 | 20 | 250 | 6.80 | 0.125 | 1200 |
| HP0402-5N6□-N | 5.6 | 3 / 5 | 250 | 28 | 250 | 6.80 | 0.070 | 1600 |
| HP0402-6N2□-N | 6.2 | 3 / 5 | 250 | 25 | 250 | 5.80 | 0.070 | 1600 |
| HP0402-6N8□-N | 6.8 | 3 / 5 | 250 | 25 | 250 | 5.80 | 0.095 | 1500 |
| HP0402-7N5□-N | 7.5 | 3 / 5 | 250 | 25 | 250 | 5.40 | 0.130 | 1400 |
| HP0402-8N2□-N | 8.2 | 3 / 5 | 250 | 30 | 250 | 5.40 | 0.080 | 1500 |
| HP0402-8N7□-N | 8.7 | 3 / 5 | 250 | 30 | 250 | 5.00 | 0.085 | 1500 |
| HP0402-9N0□-N | 9.0 | 3 / 5 | 250 | 28 | 250 | 5.00 | 0.090 | 1400 |
| HP0402-9N5□-N | 9.5 | 3 / 5 | 250 | 30 | 250 | 4.70 | 0.095 | 1400 |
| HP0402-10N□-N | 10 | 3 / 5 | 250 | 30 | 250 | 4.70 | 0.120 | 1300 |
| HP0402-11N□-N | 11 | 3 / 5 | 250 | 30 | 250 | 4.70 | 0.095 | 1400 |
| HP0402-12N□-N | 12 | 3 / 5 | 250 | 25 | 250 | 4.40 | 0.110 | 1200 |
| HP0402-13N□-N | 13 | 3 / 5 | 250 | 30 | 250 | 4.20 | 0.140 | 870 |
| HP0402-15N□-N | 15 | 3 / 5 | 250 | 30 | 250 | 3.90 | 0.130 | 1100 |
| HP0402-16N□-N | 16 | 3 / 5 | 250 | 30 | 250 | 3.70 | 0.150 | 850 |
| HP0402-18N□-N | 18 | 3 / 5 | 250 | 30 | 250 | 3.55 | 0.160 | 900 |
| HP0402-19N□-N | 19 | 3 / 5 | 250 | 30 | 250 | 3.50 | 0.175 | 850 |
| HP0402-20N□-N | 20 | 3 / 5 | 250 | 30 | 250 | 3.50 | 0.220 | 780 |
| HP0402-21N□-N | 21 | 3 / 5 | 250 | 30 | 250 | 1.70 | 0.360 | 450 |
| HP0402-22N□-N | 22 | 3 / 5 | 250 | 30 | 250 | 3.30 | 0.210 | 800 |
| HP0402-23N□-N | 23 | 3 / 5 | 250 | 30 | 250 | 3.15 | 0.210 | 700 |
| HP0402-24N□-N | 24 | 3 / 5 | 250 | 30 | 250 | 3.15 | 0.260 | 700 |
| HP0402-25N□-N | 25 | 3 / 5 | 250 | 30 | 250 | 3.15 | 0.310 | 700 |
| HP0402-26N□-N | 26 | 3 / 5 | 250 | 30 | 250 | 3.15 | 0.275 | 700 |
| HP0402-27N□-N | 27 | 3 / 5 | 250 | 30 | 250 | 3.20 | 0.300 | 450 |
| HP0402-30N□-N | 30 | 3 / 5 | 250 | 30 | 250 | 2.90 | 0.350 | 450 |
| HP0402-33N□-N | 33 | 3 / 5 | 250 | 30 | 250 | 2.80 | 0.380 | 490 |
| HP0402-36N□-N | 36 | 3 / 5 | 250 | 30 | 250 | 2.80 | 0.480 | 480 |
| HP0402-37N□-N | 37 | 3 / 5 | 250 | 30 | 250 | 2.70 | 0.490 | 470 |
| HP0402-39N□-N | 39 | 3 / 5 | 250 | 30 | 250 | 2.60 | 0.520 | 450 |
| HP0402-40N□-N | 40 | 3 / 5 | 250 | 30 | 250 | 2.60 | 0.520 | 450 |
| HP0402-43N□-N | 43 | 3 / 5 | 250 | 29 | 250 | 2.50 | 0.720 | 450 |
| HP0402-47N□-N | 47 | 3 / 5 | 250 | 30 | 250 | 2.40 | 0.720 | 420 |
| HP0402-51N□-N | 51 | 3 / 5 | 250 | 30 | 250 | 2.30 | 0.980 | 360 |

Note: When ordering, please specify tolerance code. Tolerance : B=±0.1nH , C=±0.2nH , H=±3% , J=±5%

- Operating temperature range - 40°C ~ 125°C(Including self - temperature rise)
- Irms for a 15°C temperature rise from 25°C ambient with current
- Measure Equipment :
 L & Q : Agilent E4991A+Agilent HP16197A
 SRF : Agilent HP8753D/Agilent HP8722ES
 RDC : Chroma 16502
 Irms : HP4284A+HP42841A/HP4285A+HP42841A

Please be sure to request approval specifications that provide further details of the products. Kindly note that the content of these specifications are subject to change or may be discontinued without advance notice. Please contact our sales department before ordering.

Electrical Characteristics

| Part Number | Inductance (nH) | Tolerance (±%) | Test Frequency (MHz) | Q Typ. | Test Frequency (MHz) | SRF (GHz) Typ. | RDC (Ω) Max | Irms (mA) Max | Color |
|---------------|-----------------|----------------|----------------------|--------|----------------------|----------------|-------------|---------------|--------|
| HP0603-1N8□-N | 1.8 | 5 | 250 | 23 | 250 | 16.0 | 0.033 | 2100 | Black |
| HP0603-2N2□-N | 2.2 | 5 | 250 | 13 | 250 | 15.0 | 0.182 | 900 | Brown |
| HP0603-3N9□-N | 3.9 | 5 | 250 | 26 | 250 | 7.50 | 0.062 | 1600 | Red |
| HP0603-4N3□-N | 4.3 | 3 / 5 | 250 | 26 | 250 | 7.50 | 0.088 | 1300 | Orange |
| HP0603-4N7□-N | 4.7 | 3 / 5 | 250 | 25 | 250 | 7.90 | 0.130 | 1100 | Yellow |
| HP0603-6N8□-N | 6.8 | 3 / 5 | 250 | 40 | 250 | 5.80 | 0.065 | 1400 | Green |
| HP0603-7N2□-N | 7.2 | 3 / 5 | 250 | 32 | 250 | 5.40 | 0.100 | 1400 | Blue |
| HP0603-7N5□-N | 7.5 | 3 / 5 | 250 | 32 | 250 | 5.30 | 0.100 | 1300 | Violet |
| HP0603-11N□-N | 11 | 3 / 5 | 250 | 41 | 250 | 4.10 | 0.086 | 1400 | Gray |
| HP0603-15N□-N | 15 | 3 / 5 | 250 | 42 | 250 | 3.60 | 0.110 | 1200 | White |
| HP0603-16N□-N | 16 | 3 / 5 | 250 | 40 | 250 | 3.50 | 0.125 | 1100 | Black |
| HP0603-22N□-N | 22 | 3 / 5 | 250 | 40 | 250 | 3.15 | 0.195 | 850 | Brown |
| HP0603-23N□-N | 23 | 3 / 5 | 250 | 40 | 250 | 3.00 | 0.150 | 850 | Red |
| HP0603-24N□-N | 24 | 3 / 5 | 250 | 42 | 250 | 2.95 | 0.125 | 1100 | Orange |
| HP0603-27N□-N | 27 | 3 / 5 | 250 | 42 | 250 | 2.80 | 0.200 | 780 | Yellow |
| HP0603-30N□-N | 30 | 3 / 5 | 250 | 49 | 250 | 2.80 | 0.130 | 920 | Green |
| HP0603-33N□-N | 33 | 3 / 5 | 250 | 45 | 250 | 2.70 | 0.170 | 680 | Blue |
| HP0603-36N□-N | 36 | 3 / 5 | 250 | 44 | 250 | 2.50 | 0.225 | 720 | Violet |
| HP0603-39N□-N | 39 | 3 / 5 | 250 | 48 | 250 | 2.45 | 0.190 | 680 | Gray |
| HP0603-43N□-N | 43 | 3 / 5 | 250 | 45 | 250 | 2.45 | 0.225 | 810 | White |
| HP0603-47N□-N | 47 | 3 / 5 | 200 | 43 | 250 | 2.30 | 0.240 | 680 | Black |
| HP0603-51N□-N | 51 | 3 / 5 | 200 | 42 | 250 | 2.30 | 0.280 | 660 | Brown |
| HP0603-56N□-N | 56 | 3 / 5 | 200 | 43 | 250 | 2.20 | 0.300 | 610 | Red |
| HP0603-68N□-N | 68 | 3 / 5 | 200 | 43 | 250 | 2.00 | 0.330 | 600 | Orange |
| HP0603-72N□-N | 72 | 3 / 5 | 150 | 37 | 250 | 1.90 | 0.420 | 550 | Yellow |
| HP0603-75N□-N | 75 | 3 / 5 | 150 | 37 | 250 | 1.90 | 0.520 | 500 | Green |
| HP0603-82N□-N | 82 | 3 / 5 | 150 | 38 | 250 | 1.80 | 0.460 | 510 | Blue |
| HP0603-91N□-N | 91 | 3 / 5 | 150 | 45 | 250 | 1.65 | 0.580 | 440 | Violet |
| HP0603-R10□-N | 100 | 3 / 5 | 150 | 49 | 250 | 1.70 | 0.540 | 470 | Gray |
| HP0603-R11□-N | 110 | 3 / 5 | 150 | 47 | 250 | 1.60 | 0.620 | 440 | White |
| HP0603-R12□-N | 120 | 3 / 5 | 150 | 47 | 250 | 1.55 | 0.720 | 420 | Black |
| HP0603-R15□-N | 150 | 3 / 5 | 150 | 47 | 250 | 1.35 | 1.150 | 390 | Brown |
| HP0603-R18□-N | 180 | 3 / 5 | 100 | 48 | 250 | 1.30 | 1.500 | 310 | Red |
| HP0603-R20□-N | 200 | 3 / 5 | 100 | 47 | 250 | 1.25 | 2.000 | 280 | Orange |
| HP0603-R21□-N | 210 | 3 / 5 | 100 | 48 | 250 | 1.20 | 2.000 | 280 | Yellow |
| HP0603-R22□-N | 220 | 3 / 5 | 100 | 47 | 250 | 1.10 | 2.000 | 280 | Green |
| HP0603-R25□-N | 250 | 3 / 5 | 100 | 45 | 250 | 1.05 | 3.000 | 240 | Blue |
| HP0603-R27□-N | 270 | 3 / 5 | 100 | 46 | 250 | 1.05 | 2.250 | 260 | Violet |
| HP0603-R30□-N | 300 | 3 / 5 | 100 | 47 | 250 | 0.99 | 2.800 | 220 | Gray |
| HP0603-R33□-N | 330 | 3 / 5 | 100 | 46 | 250 | 0.93 | 3.600 | 180 | White |
| HP0603-R36□-N | 360 | 3 / 5 | 100 | 47 | 250 | 0.93 | 4.000 | 170 | Black |
| HP0603-R39□-N | 390 | 3 / 5 | 100 | 47 | 250 | 0.88 | 4.000 | 170 | Brown |

Note: When ordering, please specify tolerance code. Tolerance : H=±3% , J=±5%

- Operating temperature range - 40°C ~ 125°C(Including self - temperature rise)
- Irms for a 15°C temperature rise from 25°C ambient with current
- Measure Equipment :
 - L & Q : Agilent E4991A+Agilent HP16197A
 - SRF : Agilent HP8753D/Agilent HP8722ES
 - RDC : Chroma 16502
 - Irms : HP4284A+HP42841A/HP4285A+HP42841A

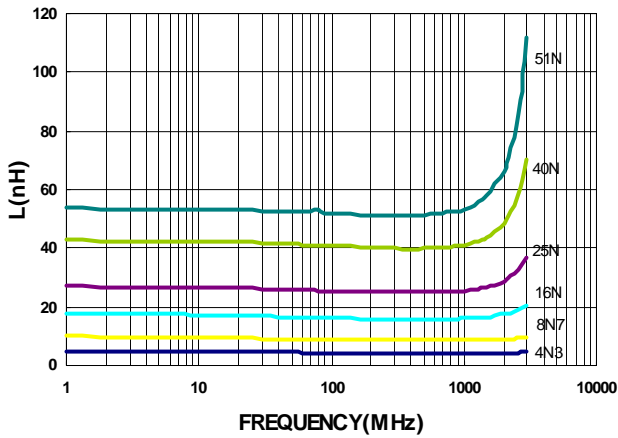
Please be sure to request approval specifications that provide further details of the products. Kindly note that the content of these specifications are subject to change or may be discontinued without advance notice. Please contact our sales department before ordering.

SMD Wire Wound Ceramic Chip Inductors - HP Series

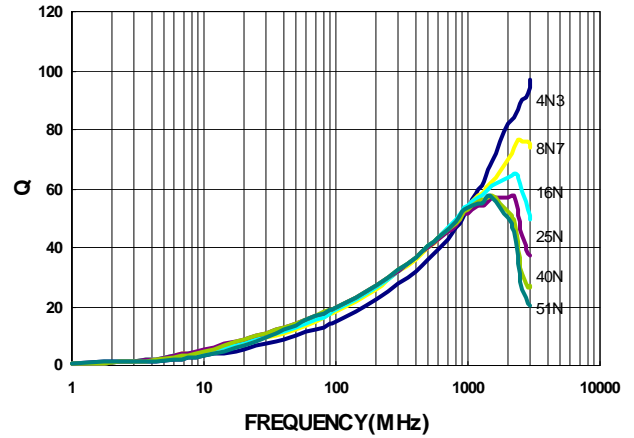
Test Instruments : Agilent E4991A Material/Impedance Analyzer

HP0402

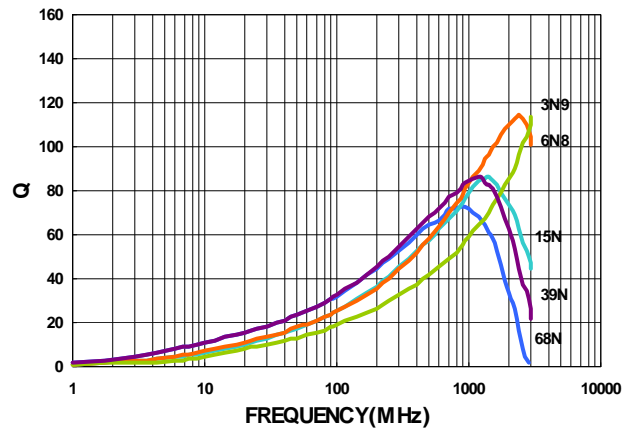
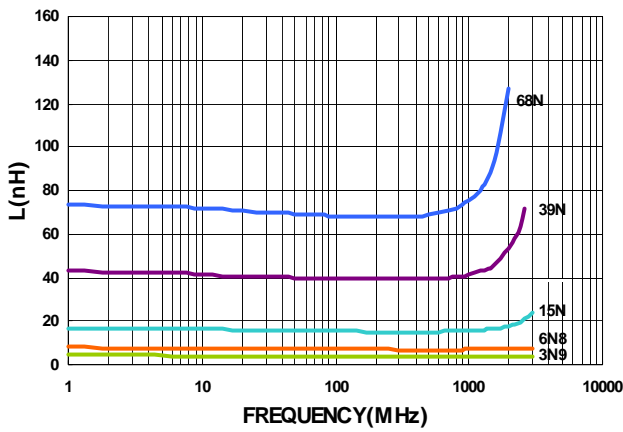
Typical **L** vs. **F** Frequency



Typical **Q** vs. **F** Frequency



HP0603



Please be sure to request approval specifications that provide further details of the products. Kindly note that the content of these specifications are subject to change or may be discontinued without advance notice. Please contact our sales department before ordering.

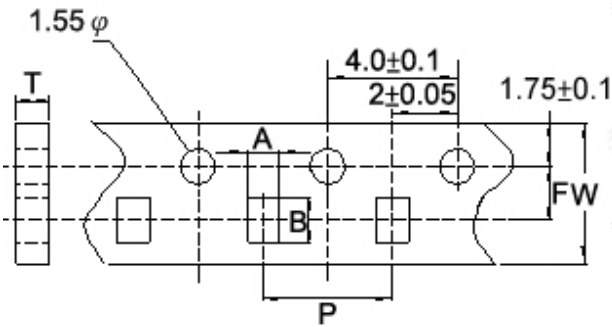
Packaging Specifications

Tape Dimensions

Figure 1

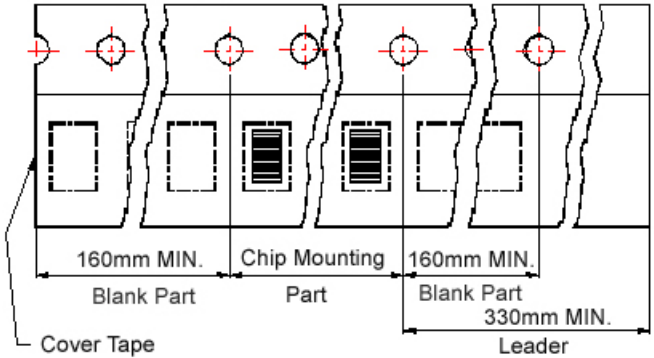


Figure 2

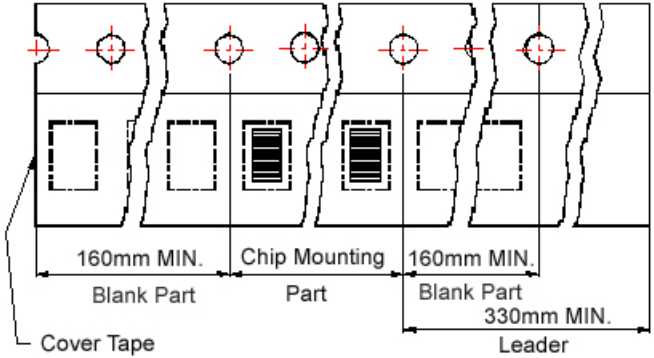


Tape Material

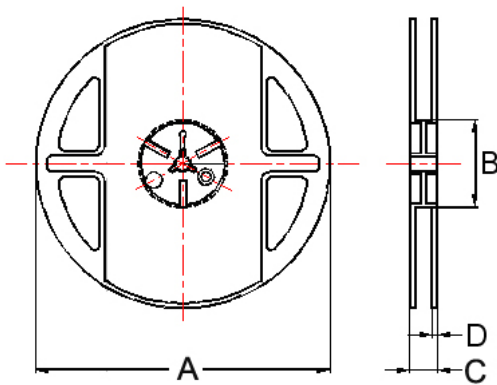
Carrier Tape: Paper
Cover Tape: Polystyrene



Carrier Tape: Paper
Cover Tape: Polystyrene



Reel Dimensions



Dimensions in mm

| TYPE | Fig. | Tape Dimensions | | | | | | | Reel Dimensions | | | | Quantity PCS / Reel |
|--------|------|-----------------|------|------|---|---|-----|------|-----------------|----|----|-----|------------------------|
| | | A | B | T | W | P | F | K | A | B | C | D | |
| HP0402 | 1 | 0.80 | 1.20 | 0.75 | 8 | 2 | 3.5 | 0.62 | 178 | 60 | 12 | 1.5 | 4000 |
| HP0603 | 2 | 1.23 | 1.90 | 1.05 | 8 | 4 | 3.5 | - | 178 | 60 | 12 | 1.5 | 4000 |

HPH Series



Due to accurate wire winding technology, these chip inductors are designed for filtering, impedance matching, resonance and choke circuits for RF designer. Both standard series custom designs are available.

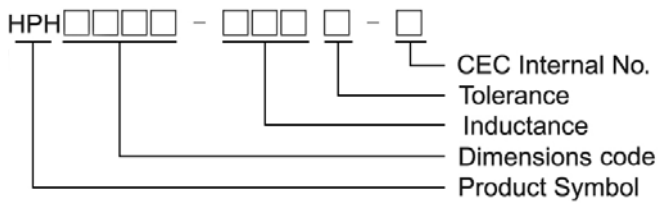
Features

- RoHS Compliant and Halogen Free
- Ceramic body and wire wound construction provide high Q and SRFs
- Higher Q and lower DCR than other inductors
- Exceptional current handling capability
- HPH series is for high power and high frequency application

Applications

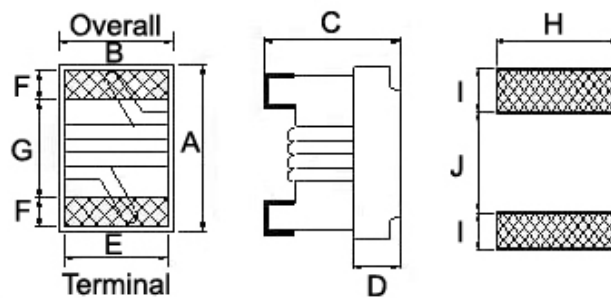
- Wireless embedded portable devices
- GPS receiver
- Base Station
- Repeater
- Set Top Box
- Cable / IP Modem
- Security system and other RF modules

Product Identification



Shape and Dimensions / Recommended Pattern

HPH0603



Dimensions

| | A | B | C | D | E | F | G | H | I | J |
|----------------|-------------------------------------|------------|--------------------------------------|------|------|------|------|------|------|------|
| HPH0603 | 1.6 ^{+0.2} _{-0.1} | 1.12 ± 0.1 | 0.82 ^{+0.2} _{-0.1} | 0.30 | 0.70 | 0.30 | 0.95 | 1.02 | 0.64 | 0.64 |

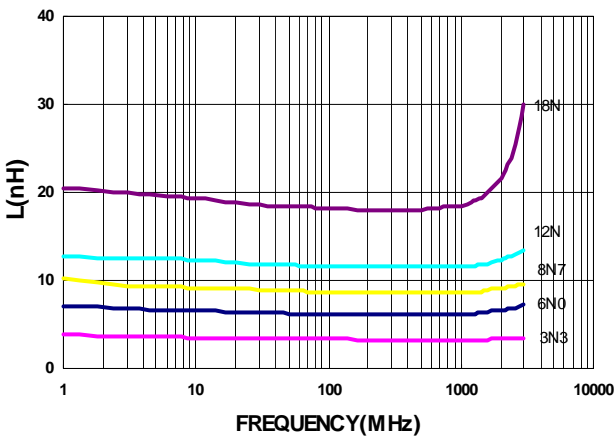
Electrical Characteristics

| Part Number | Inductance (nH) | Tolerance (±%) | Test Frequency (MHz) | Q Typ. | Test Frequency (MHz) | SRF (GHz) Typ. | RDC (Ω) Max | I _{rms} (mA) Max | Color Code |
|----------------|-----------------|----------------|----------------------|--------|----------------------|----------------|-------------|---------------------------|------------|
| HPH0603-3N3□-N | 3.3 | 5 / 3 | 250 | 36 | 250 | 9.6 | 0.034 | 1900 | Black |
| HPH0603-3N6□-N | 3.6 | 5 / 3 | 250 | 28 | 250 | 9.7 | 0.040 | 1900 | Brown |
| HPH0603-5N1□-N | 5.1 | 5 / 3 | 250 | 38 | 250 | 8.9 | 0.042 | 1700 | Red |
| HPH0603-5N6□-N | 5.6 | 5 / 3 | 250 | 35 | 250 | 6.6 | 0.042 | 1700 | Orange |
| HPH0603-6N0□-N | 6.0 | 5 / 3 | 250 | 49 | 250 | 6.0 | 0.042 | 1700 | Yellow |
| HPH0603-8N2□-N | 8.2 | 5 / 3 | 250 | 40 | 250 | 5.9 | 0.054 | 1400 | Green |
| HPH0603-8N7□-N | 8.7 | 5 / 3 | 250 | 46 | 250 | 5.5 | 0.054 | 1400 | Blue |
| HPH0603-9N1□-N | 9.1 | 5 / 3 | 250 | 40 | 250 | 5.1 | 0.052 | 1400 | Violet |
| HPH0603-9N5□-N | 9.5 | 5 / 3 | 250 | 42 | 250 | 4.9 | 0.054 | 1400 | Gray |
| HPH0603-10N□-N | 10 | 5 / 3 | 250 | 44 | 250 | 4.3 | 0.054 | 1400 | White |
| HPH0603-12N□-N | 12 | 5 / 3 | 250 | 40 | 250 | 4.1 | 0.088 | 1100 | Black |
| HPH0603-18N□-N | 18 | 5 / 3 | 250 | 45 | 250 | 3.3 | 0.082 | 1200 | Brown |

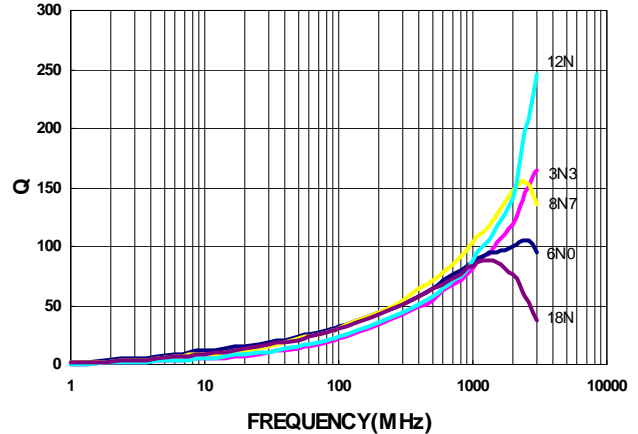
Note: When ordering, please specify tolerance code. Tolerance : H=±3% , J=±5%

- Operating temperature range - 40°C ~ 125°C(Including self - temperature rise)
- I_{rms} for a 15°C temperature rise from 25°C ambient with current
- Measure Equipment :
 L & Q : Agilent E4991A+Agilent HP16197A
 SRF : Agilent E5071C
 RDC : Chroma 16502
 I_{rms} : HP4284A+HP42841A/HP4285A+HP42841A

Typical **L** vs. **F**requency



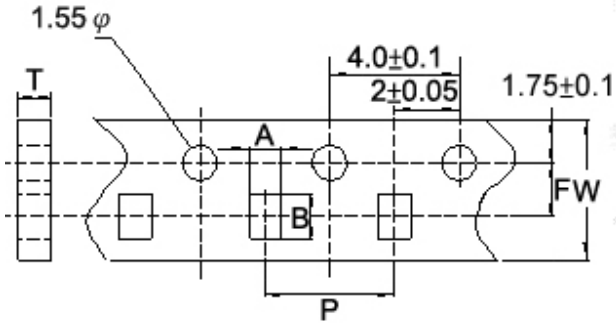
Typical **Q** vs. **F**requency



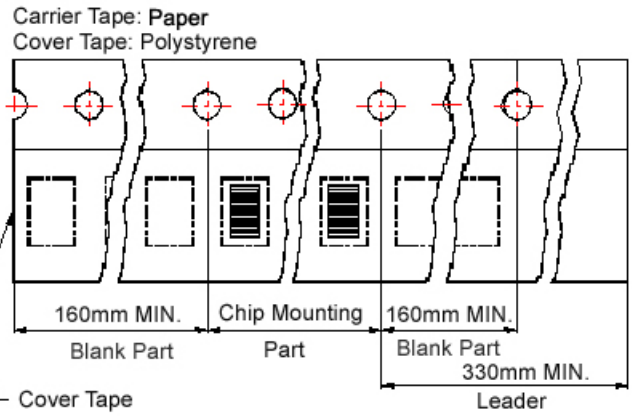
Please be sure to request approval specifications that provide further details of the products. Kindly note that the content of these specifications are subject to change or may be discontinued without advance notice. Please contact our sales department before ordering.

Packaging Specifications

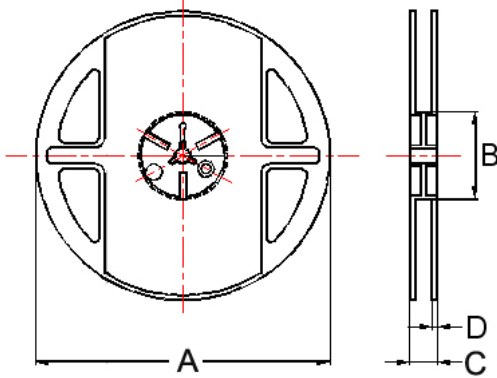
Tape Dimensions



Tape Material



Reel Dimensions



Dimensions in mm

| TYPE | Tape Dimensions | | | | | | Reel Dimensions | | | | Quantity PCS / Reel |
|---------|-----------------|------|------|---|---|-----|-----------------|----|----|-----|------------------------|
| | A | B | T | W | P | F | A | B | C | D | |
| HPH0603 | 1.23 | 1.90 | 1.05 | 8 | 4 | 3.5 | 178 | 60 | 12 | 1.5 | 4000 |

CT Series



Due to accurate wire winding technology, these chip inductors are designed for filtering, impedance matching, resonance and choke circuits for RF designer. Both standard series custom designs are available.

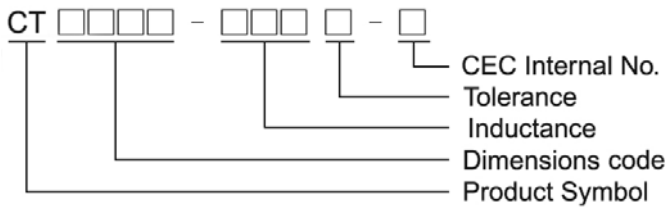
Features

- RoHS compliant.
- Ceramic body and wire wound construction provide highest SRFs
- Exceptional Q values even at high frequencies
- Highest possible SRFs as well as excellent Q values
- The non-magnetic coil form assures utmost thermal stability, predictability and batch consistency

Applications

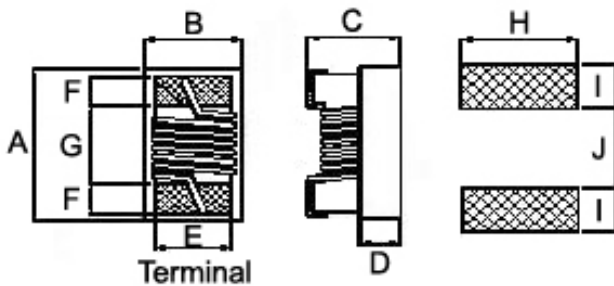
- RF products for cellular phone
- GPS receiver
- Base Station
- Repeater
- Wireless LAN/ mouse/ keyboard/ earphone
- Remote control
- Security system and other RF modules

Product Identification

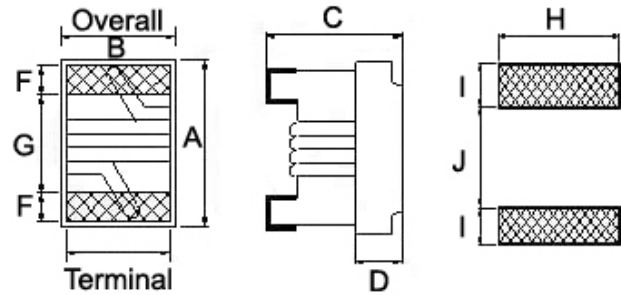


Shape and Dimensions/ Recommended Pattern

CT0603



CT0805



Dimensions

| | | A | B | C | D | E | F | G | H | I | J |
|--------|----|-------------------------------------|---------|-----------|------|------|------|------|------|------|------|
| CT0603 | mm | 1.6 ^{+0.2} _{-0.1} | 0.9±0.1 | 0.55±0.05 | 0.25 | 0.76 | 0.30 | 0.92 | 1.02 | 0.64 | 0.64 |

| | | A Max | B Max | C Max | D | E | F | G | H | I | J |
|--------|------|-------|-------|-------|-------|-------|-------|-------|-------|-------|-------|
| CT0805 | inch | 0.093 | 0.068 | 0.039 | 0.020 | 0.050 | 0.020 | 0.040 | 0.070 | 0.040 | 0.030 |
| | mm | 2.35 | 1.73 | 1.10 | 0.51 | 1.27 | 0.51 | 1.02 | 1.78 | 1.02 | 0.76 |

Electrical Characteristics

| Part Number | Inductance (nH) | Tolerance (±%) | Test Frequency (MHz) | Q Min | Test Frequency (MHz) | SRF (MHz) Min | RDC (Ω) Max | Irms (mA) Max |
|---------------|-----------------|----------------|----------------------|-------|----------------------|---------------|-------------|---------------|
| CT0603-1N0□-N | 1.0 | 10 | 250 | 13 | 250 | 16000 | 0.045 | 1600 |
| CT0603-1N2□-N | 1.2 | 10 | 250 | 12 | 250 | 16000 | 0.105 | 1100 |
| CT0603-2N0□-N | 2.0 | 5,10 | 250 | 21 | 250 | 12000 | 0.034 | 1900 |
| CT0603-2N2□-N | 2.2 | 5,10 | 250 | 21 | 250 | 10700 | 0.046 | 1600 |
| CT0603-2N3□-N | 2.3 | 5,10 | 250 | 25 | 250 | 11000 | 0.046 | 1600 |
| CT0603-2N5□-N | 2.5 | 5,10 | 250 | 20 | 250 | 11000 | 0.060 | 1300 |
| CT0603-3N0□-N | 3 | 5,10 | 250 | 25 | 250 | 10700 | 0.039 | 1600 |
| CT0603-3N3□-N | 3.3 | 3,5 | 250 | 26 | 250 | 7000 | 0.039 | 1600 |
| CT0603-3N6□-N | 3.6 | 3,5 | 250 | 28 | 250 | 7000 | 0.044 | 1600 |
| CT0603-3N9□-N | 3.9 | 3,5 | 250 | 26 | 250 | 6300 | 0.050 | 1400 |
| CT0603-4N3□-N | 4.3 | 3,5 | 250 | 22 | 250 | 6300 | 0.076 | 1300 |
| CT0603-4N7□-N | 4.7 | 3,5 | 250 | 22 | 250 | 5600 | 0.120 | 960 |
| CT0603-5N1□-N | 5.1 | 3,5 | 250 | 24 | 250 | 5500 | 0.050 | 1400 |
| CT0603-5N6□-N | 5.6 | 3,5 | 250 | 27 | 250 | 5050 | 0.058 | 1300 |
| CT0603-6N8□-N | 6.8 | 3,5 | 250 | 24 | 250 | 4500 | 0.080 | 1200 |
| CT0603-7N2□-N | 7.2 | 3,5 | 250 | 29 | 250 | 4500 | 0.047 | 1500 |
| CT0603-8N2□-N | 8.2 | 3,5 | 250 | 27 | 250 | 4250 | 0.075 | 1300 |
| CT0603-9N5□-N | 9.5 | 3,5 | 250 | 27 | 250 | 3950 | 0.092 | 1100 |
| CT0603-10N□-N | 10 | 2,5 | 250 | 27 | 250 | 3950 | 0.075 | 1300 |
| CT0603-11N□-N | 11 | 2,5 | 250 | 26 | 250 | 4000 | 0.110 | 1000 |
| CT0603-12N□-N | 12 | 2,5 | 250 | 28 | 250 | 3500 | 0.130 | 920 |
| CT0603-15N□-N | 15 | 2,5 | 250 | 26 | 250 | 3300 | 0.145 | 800 |
| CT0603-16N□-N | 16 | 2,5 | 250 | 26 | 250 | 3100 | 0.175 | 760 |
| CT0603-18N□-N | 18 | 2,5 | 250 | 26 | 250 | 2950 | 0.200 | 720 |
| CT0603-20N□-N | 20 | 2,5 | 250 | 28 | 250 | 2900 | 0.175 | 760 |
| CT0603-22N□-N | 22 | 2,5 | 250 | 28 | 250 | 2750 | 0.220 | 700 |
| CT0603-24N□-N | 24 | 2,5 | 250 | 29 | 250 | 2700 | 0.240 | 680 |
| CT0603-27N□-N | 27 | 2,5 | 250 | 27 | 250 | 2550 | 0.270 | 670 |
| CT0603-30N□-N | 30 | 2,5 | 250 | 27 | 250 | 2450 | 0.330 | 600 |
| CT0603-33N□-N | 33 | 2,5 | 250 | 27 | 250 | 2200 | 0.330 | 600 |
| CT0603-36N□-N | 36 | 2,5 | 250 | 28 | 250 | 2300 | 0.335 | 600 |
| CT0603-39N□-N | 39 | 2,5 | 250 | 28 | 250 | 2250 | 0.400 | 570 |
| CT0603-43N□-N | 43 | 2,5 | 250 | 27 | 250 | 2100 | 0.440 | 530 |
| CT0603-47N□-N | 47 | 2,5 | 250 | 27 | 250 | 1900 | 0.540 | 470 |
| CT0603-51N□-N | 51 | 2,5 | 250 | 26 | 250 | 1850 | 0.570 | 440 |
| CT0603-56N□-N | 56 | 2,5 | 250 | 26 | 250 | 1750 | 0.700 | 420 |

Note: When ordering, please specify tolerance code. Tolerance : G=±2% , H=±3% , J=±5% , K=±10%

- Operating temperature range - 40°C ~ 125°C(Including self - temperature rise)
- I rms for a 15°C temperature rise from 25°C ambient with current
- Measure Equipment :
 L & Q : Agilent E4991A+Agilent HP16197A
 SRF : Agilent/HP8753D/Agilent E4991A
 RDC: HP4338B or Chroma 16502
 I rms : HP4284A+HP42841A/HP4285A+HP42841A

Electrical Characteristics

| Part Number | Inductance (nH) | Tolerance (±%) | Test Frequency (MHz) | Q Min | Test Frequency (MHz) | SRF (MHz) Min | RDC (Ω) Max | Irms (mA) Max | Color |
|---------------|-----------------|----------------|----------------------|-------|----------------------|---------------|-------------|---------------|--------|
| CT0805-1N8□-S | 1.8 | 10 | 250 | 55 | 1500 | 9400 | 0.03 | 800 | Black |
| CT0805-3N9□-S | 3.9 | 10 | 250 | 50 | 1000 | 6100 | 0.06 | 800 | Brown |
| CT0805-4N7□-S | 4.7 | 10 / 5 | 250 | 50 | 1000 | 5500 | 0.06 | 800 | Red |
| CT0805-6N8□-S | 6.8 | 10 / 5 | 250 | 50 | 1000 | 5500 | 0.08 | 800 | Orange |
| CT0805-8N2□-S | 8.2 | 10 / 5 | 250 | 50 | 1000 | 4800 | 0.08 | 800 | Yellow |
| CT0805-10N□-S | 10 | 10 / 5 / 2 | 250 | 55 | 750 | 3300 | 0.08 | 800 | Green |
| CT0805-12N□-S | 12 | 10 / 5 / 2 | 250 | 55 | 750 | 3800 | 0.10 | 800 | Blue |
| CT0805-15N□-S | 15 | 10 / 5 / 2 | 250 | 50 | 500 | 2950 | 0.10 | 800 | Violet |
| CT0805-18N□-S | 18 | 10 / 5 / 2 | 250 | 50 | 500 | 3100 | 0.13 | 800 | Gray |
| CT0805-22N□-S | 22 | 10 / 5 / 2 | 250 | 50 | 500 | 2900 | 0.15 | 800 | White |
| CT0805-27N□-S | 27 | 10 / 5 / 2 | 250 | 50 | 500 | 2450 | 0.23 | 600 | Black |
| CT0805-33N□-S | 33 | 10 / 5 / 2 | 250 | 55 | 500 | 2350 | 0.28 | 600 | Brown |
| CT0805-39N□-S | 39 | 10 / 5 / 2 | 250 | 55 | 500 | 2200 | 0.33 | 600 | Red |
| CT0805-47N□-S | 47 | 10 / 5 / 2 | 200 | 50 | 500 | 2000 | 0.39 | 600 | Orange |
| CT0805-56N□-S | 56 | 10 / 5 / 2 | 200 | 50 | 500 | 1850 | 0.39 | 500 | Yellow |
| CT0805-68N□-S | 68 | 10 / 5 / 2 | 200 | 50 | 500 | 1500 | 0.40 | 500 | Green |
| CT0805-82N□-S | 82 | 10 / 5 / 2 | 150 | 50 | 500 | 1500 | 0.44 | 500 | Blue |
| CT0805-R10□-S | 100 | 10 / 5 / 2 | 150 | 50 | 500 | 1200 | 0.64 | 400 | Violet |
| CT0805-R12□-S | 120 | 10 / 5 / 2 | 150 | 40 | 250 | 1150 | 0.68 | 300 | Gray |
| CT0805-R15□-S | 150 | 10 / 5 / 2 | 150 | 40 | 250 | 1050 | 0.80 | 300 | White |
| CT0805-R18□-S | 180 | 10 / 5 / 2 | 150 | 40 | 250 | 950 | 0.90 | 300 | Black |
| CT0805-R22□-S | 220 | 10 / 5 / 2 | 150 | 40 | 250 | 900 | 0.98 | 300 | Brown |
| CT0805-R27□-S | 270 | 10 / 5 / 2 | 150 | 40 | 250 | 850 | 1.30 | 300 | Red |
| CT0805-R33□-S | 330 | 10 / 5 / 2 | 100 | 40 | 250 | 800 | 1.45 | 300 | Orange |
| CT0805-R39□-S | 390 | 10 / 5 / 2 | 100 | 35 | 250 | 700 | 1.60 | 300 | Yellow |
| CT0805-R47□-S | 470 | 10 / 5 / 2 | 50 | 25 | 100 | 600 | 1.80 | 300 | Green |
| CT0805-R56□-S | 560 | 10 / 5 / 2 | 25 | 18 | 50 | 550 | 1.90 | 300 | Blue |
| CT0805-R62□-S | 620 | 10 / 5 / 2 | 25 | 18 | 50 | 450 | 2.00 | 300 | Violet |
| CT0805-R68□-S | 680 | 10 / 5 / 2 | 25 | 18 | 50 | 420 | 2.10 | 300 | Gray |
| CT0805-R75□-S | 750 | 10 / 5 / 2 | 25 | 18 | 50 | 400 | 2.20 | 300 | White |
| CT0805-R82□-S | 820 | 10 / 5 / 2 | 25 | 18 | 50 | 400 | 2.50 | 300 | Black |
| CT0805-1R0□-S | 1000 | 10 / 5 | 25 | 17 | 50 | 330 | 3.10 | 300 | Brown |

Note: When ordering, please specify tolerance code. Tolerance : G=±2% , J=±5% , K=±10%

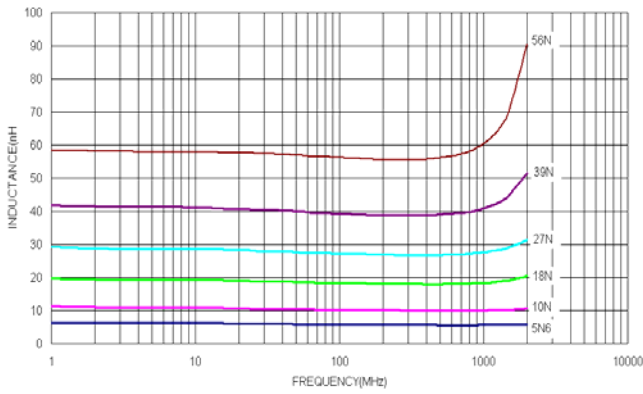
- Operating temperature range - 40°C ~ 125°C(Including self - temperature rise)
- Irms for a 15°C temperature rise from 25°C ambient with current
- Measure Equipment :
 - L & Q : Agilent E4991A+Agilent HP16197A
 - SRF : Agilent/HP8753D/Agilent E4991A
 - RDC: HP4338B or Chroma 16502
 - Irms : HP4284A+HP42841A/HP4285A+HP42841A

SMD Wire Wound Ceramic Chip Inductors - CT Series

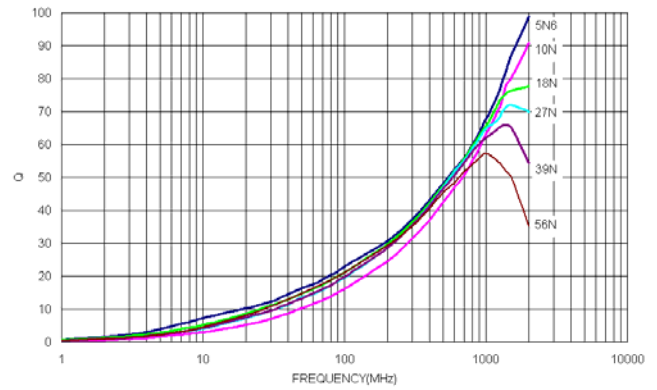
Test Instruments : Agilent E4991A Material/Impedance Analyzer

CT0603

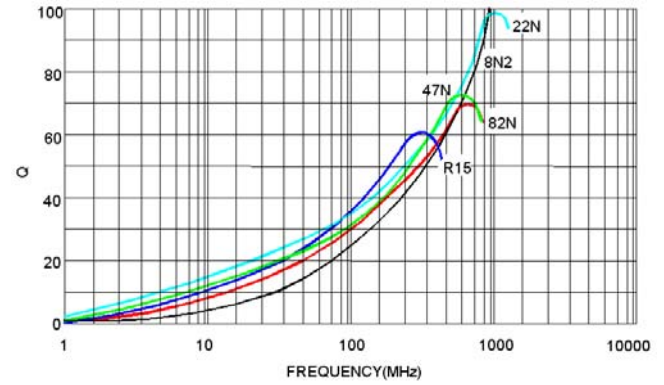
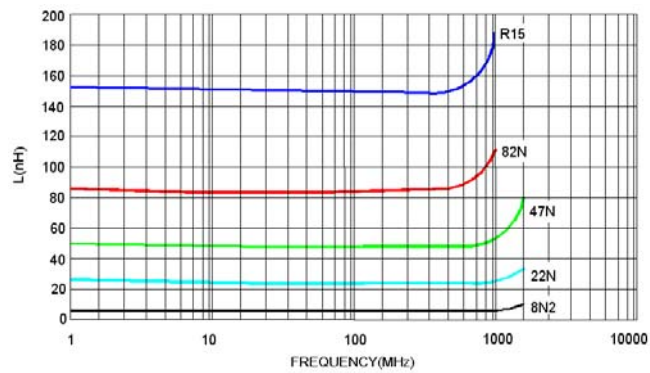
Typical **L** vs. **F** Frequency



Typical **Q** vs. **F** Frequency



CT0805

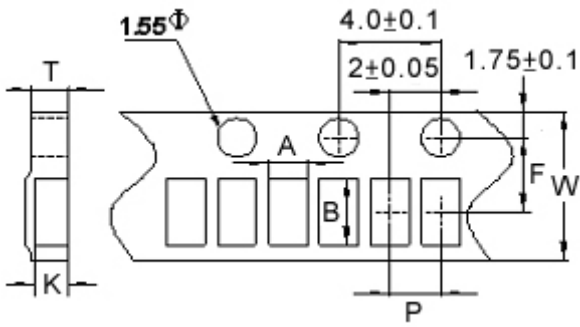


Please be sure to request approval specifications that provide further details of the products. Kindly note that the content of these specifications are subject to change or may be discontinued without advance notice. Please contact our sales department before ordering.

Packaging Specifications

Tape Dimensions

Figure 1



Tape Material

Carrier Tape: Paper
Cover Tape: Polystyrene

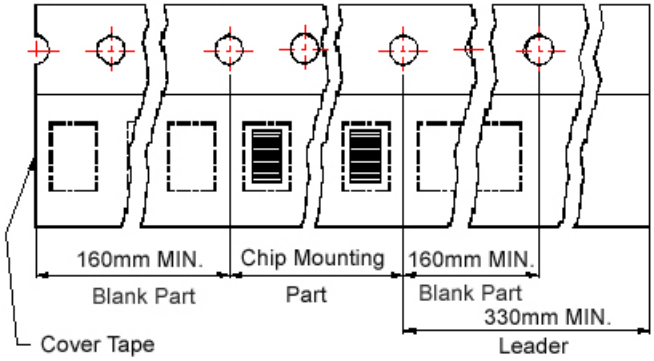
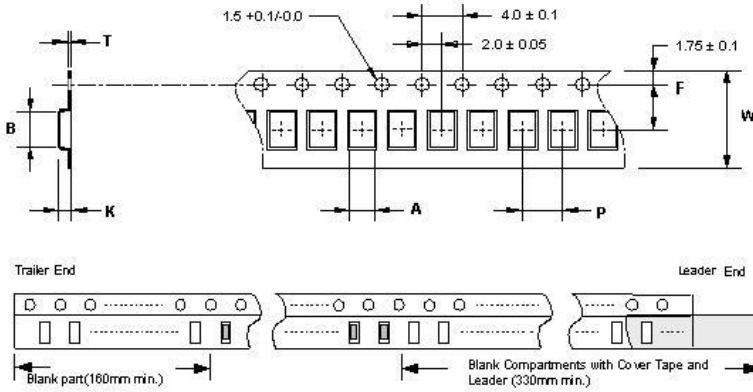
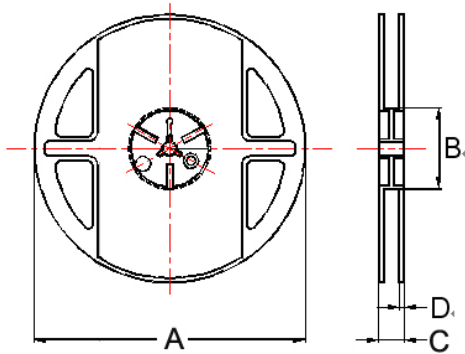


Figure 2



Reel Dimensions



Dimensions in mm

| TYPE | Fig. | Tape Dimensions | | | | | | | Reel Dimensions | | | | Quantity PCS / Reel |
|--------|------|-----------------|------|------|---|---|-----|------|-----------------|----|----|-----|------------------------|
| | | A | B | T | W | P | F | K | A | B | C | D | |
| CT0603 | 1 | 1.05 | 1.80 | 0.75 | 8 | 4 | 3.5 | 0.60 | 178 | 60 | 12 | 1.5 | 4000 |
| CT0805 | 2 | 1.85 | 2.45 | 0.23 | 8 | 4 | 3.5 | 1.10 | 178 | 60 | 12 | 1.5 | 2000 |

HQ Series



Due to accurate wire winding technology, these chip inductors are designed for filtering, impedance matching, resonance and choke circuits for RF designer. Both standard series custom designs are available.

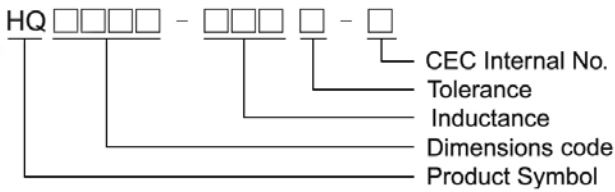
Features

- RoHS compliant.
- Ceramic body and wire wound construction provide highest SRFs
- Exceptional Q values even at high frequencies
- Highest possible SRFs as well as excellent Q values
- The non-magnetic coil form assures utmost thermal stability, predictability and batch consistency
- The highest Q factors and low RDC to fulfill the needs of mobile applications

Applications

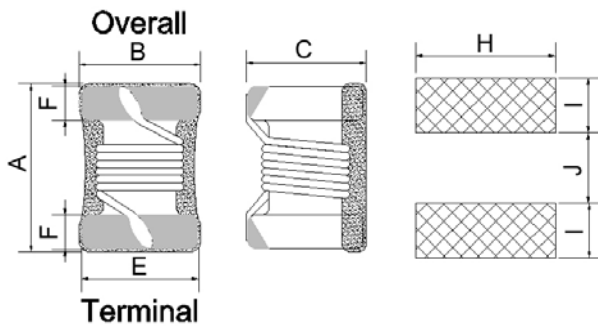
- RF products for cellular phone
- GPS receiver
- Base Station
- Repeater
- Wireless LAN/ mouse/ keyboard/ earphone
- Remote control
- Security system and other RF modules

Product Identification

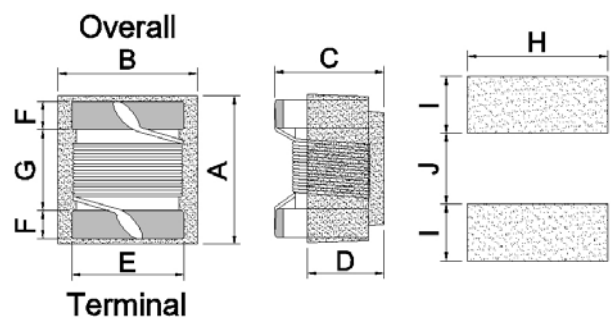


Shape and Dimensions/ Recommended Pattern

HQ0201



HQ0805/1008



Dimensions

| | | A Max | B Max | C Max | D | E | F | G | H | I | J |
|--------|------|-------|-------|-------|-------|-------|-------|-------|-------|-------|-------|
| HQ0201 | inch | 0.027 | 0.021 | 0.020 | - | 0.018 | 0.005 | - | 0.021 | 0.007 | 0.013 |
| | mm | 0.68 | 0.53 | 0.50 | - | 0.46 | 0.12 | - | 0.54 | 0.18 | 0.33 |
| HQ0805 | inch | 0.090 | 0.070 | 0.061 | 0.020 | 0.050 | 0.017 | 0.050 | 0.070 | 0.040 | 0.030 |
| | mm | 2.29 | 1.78 | 1.56 | 0.50 | 1.27 | 0.44 | 1.27 | 1.78 | 1.02 | 0.76 |
| HQ1008 | inch | 0.117 | 0.110 | 0.083 | 0.028 | 0.080 | 0.020 | 0.060 | 0.100 | 0.040 | 0.050 |
| | mm | 2.96 | 2.79 | 2.10 | 0.70 | 2.03 | 0.51 | 1.52 | 2.54 | 1.02 | 1.27 |

Electrical Characteristics

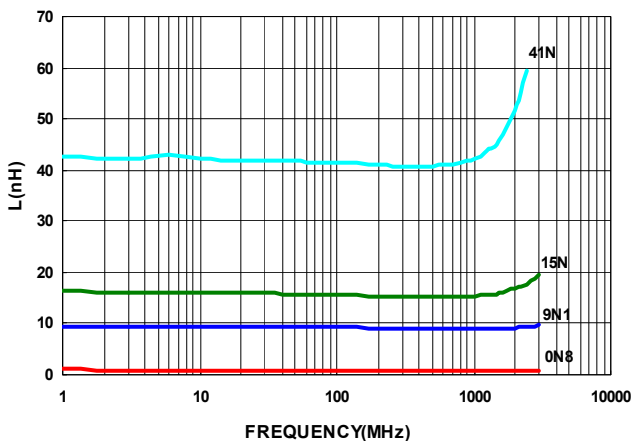
| Part Number | Inductance (nH) | Tolerance (±%) | Q Min. | Test Frequency (MHz) | SRF (MHz)Min. | RDC (Ω)Max. | Irms (mA)Max. |
|---------------|-----------------|----------------|--------|----------------------|---------------|-------------|---------------|
| HQ0201-0N8□-S | 0.8 | ±0.1 / ±0.2nH | 10 | 250 | 8500 | 0.05 | 1200 |
| HQ0201-2N0□-S | 2 | 10 | 18 | 250 | 8500 | 0.12 | 880 |
| HQ0201-3N6□-S | 3.6 | 10 | 16 | 250 | 8500 | 0.2 | 670 |
| HQ0201-5N9□-S | 5.9 | 10 | 20 | 250 | 8000 | 0.25 | 620 |
| HQ0201-7N6□-S | 7.6 | 10 | 18 | 250 | 6000 | 0.25 | 620 |
| HQ0201-9N1□-S | 9.1 | 10 | 20 | 250 | 6000 | 0.28 | 600 |
| HQ0201-10N□-S | 10 | 10 | 20 | 250 | 6000 | 0.28 | 600 |
| HQ0201-15N□-S | 15 | 10 | 22 | 250 | 4000 | 0.35 | 560 |
| HQ0201-18N□-S | 18 | 10 | 24 | 250 | 4000 | 0.40 | 460 |
| HQ0201-22N□-S | 22 | 10 | 24 | 250 | 4000 | 0.45 | 450 |
| HQ0201-27N□-S | 27 | 10 | 24 | 250 | 3500 | 0.50 | 440 |
| HQ0201-34N□-S | 34 | 10 | 22 | 250 | 3500 | 0.68 | 420 |
| HQ0201-41N□-S | 41 | 10 | 21 | 250 | 3500 | 1.1 | 330 |
| HQ0201-48N□-S | 48 | 10 | 21 | 250 | 3000 | 1.2 | 320 |
| HQ0201-50N□-S | 50 | 10 | 21 | 250 | 3000 | 1.55 | 290 |
| HQ0201-56N□-S | 56 | 10 | 21 | 250 | 3000 | 1.6 | 280 |
| HQ0201-68N□-S | 68 | 10 | 22 | 250 | 3000 | 2.3 | 250 |

Note: When ordering, please specify tolerance code. Tolerance : B=±0.1nH , C=±0.2nH , K=±10%

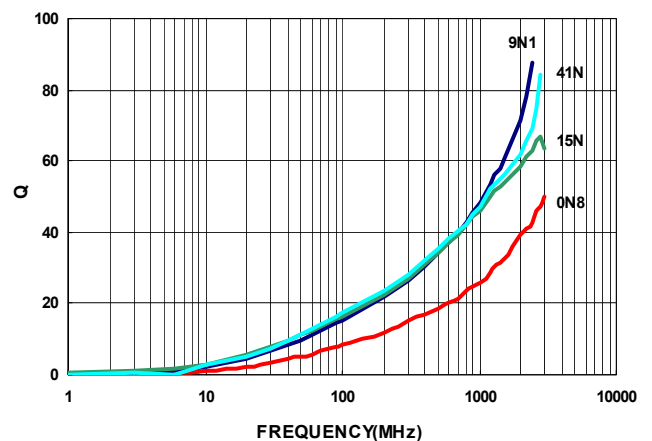
- Operating temperature range - 40°C ~ 125°C(Including self - temperature rise)
- I rms for a 15°C temperature rise from 25°C ambient with current
- Measure Equipment :
 L & Q : Agilent E4991A+Agilent HP16197A
 SRF : Agilent HP8753D/Agilent HP8722ES
 RDC : HP4287A
 I rms : HP4284A+HP42841A/HP4285A+HP42841A

Test Instruments : Agilent E4991A Material/Impedance Analyzer

Typical L vs. Frequency



Typical Q vs. Frequency



Please be sure to request approval specifications that provide further details of the products. Kindly note that the content of these specifications are subject to change or may be discontinued without advance notice. Please contact our sales department before ordering.

Electrical Characteristics

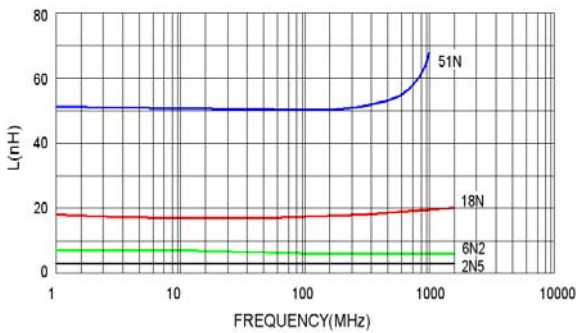
| Part Number | Inductance (nH) | Tolerance (±%) | Test Frequency (MHz) | Q Min | Test Frequency (MHz) | SRF (MHz) Min | RDC (Ω) Max | Irms (mA) Max | Color |
|---------------|-----------------|----------------|----------------------|-------|----------------------|---------------|-------------|---------------|--------|
| HQ0805-2N5□-S | 2.5 | 10 / 5 | 250 | 80 | 1500 | 6000 | 0.020 | 1600 | Black |
| HQ0805-5N6□-S | 5.6 | 10 / 5 | 250 | 98 | 1500 | 6000 | 0.035 | 1600 | Brown |
| HQ0805-6N2□-S | 6.2 | 10 / 5 | 250 | 88 | 1000 | 4750 | 0.035 | 1600 | Red |
| HQ0805-12N□-S | 12.0 | 10 / 5 | 250 | 80 | 1000 | 3000 | 0.045 | 1600 | Orange |
| HQ0805-16N□-S | 16.0 | 10 / 5 / 2 | 250 | 72 | 500 | 2950 | 0.060 | 1500 | Yellow |
| HQ0805-18N□-S | 18.0 | 10 / 5 / 2 | 250 | 75 | 500 | 2550 | 0.060 | 1400 | Green |
| HQ0805-20N□-S | 20.0 | 10 / 5 / 2 | 250 | 70 | 500 | 2050 | 0.055 | 1400 | Blue |
| HQ0805-27N□-S | 27.0 | 10 / 5 / 2 | 250 | 75 | 500 | 2000 | 0.070 | 1300 | Violet |
| HQ0805-30N□-S | 30.0 | 10 / 5 / 2 | 250 | 65 | 500 | 1950 | 0.095 | 1200 | Gray |
| HQ0805-39N□-S | 39.0 | 10 / 5 / 2 | 250 | 65 | 500 | 1600 | 0.095 | 1100 | White |
| HQ0805-48N□-S | 48.0 | 10 / 5 / 2 | 200 | 65 | 500 | 1400 | 0.110 | 1200 | Black |
| HQ0805-51N□-S | 51.0 | 10 / 5 / 2 | 200 | 65 | 500 | 1400 | 0.120 | 1000 | Brown |

Note: When ordering, please specify tolerance code. Tolerance : G=±2% , J=±5% , K=±10%

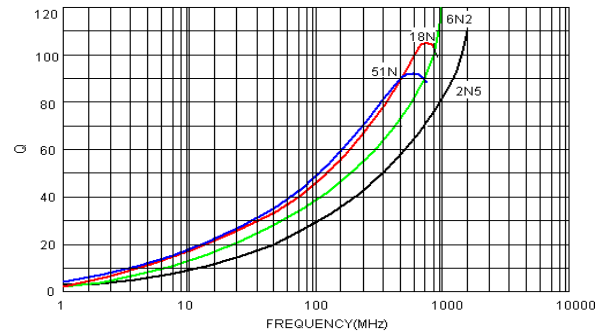
- Operating temperature range - 40°C ~ 125°C(Including self - temperature rise)
- I rms for a 15°C temperature rise from 25°C ambient with current
- Measure Equipment :
 L & Q : Agilent E4991A+Agilent HP16197A
 SRF : Agilent HP8753D/Agilent E4991A
 RDC : HP 4338B or Chroma 16502
 I rms : HP4284A+HP42841A/HP4285A+HP42841A

Test Instruments : Agilent E4991A Material/Impedance Analyzer

Typical L vs. Frequency



Typical Q vs. Frequency



Electrical Characteristics

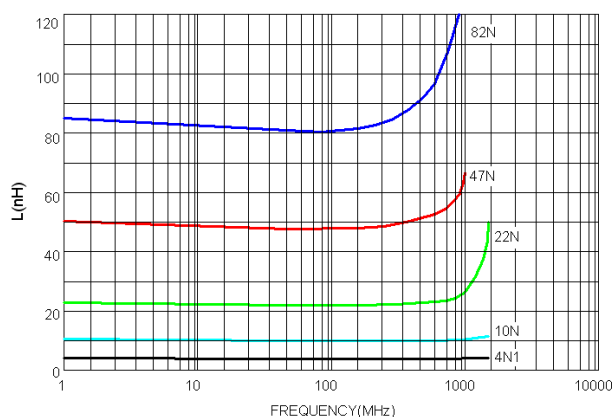
| Part Number | Inductance (nH) | Tolerance (±%) | Test Frequency (MHz) | Q Min | Test Frequency (MHz) | SRF (MHz) Min | RDC (Ω) Max | I _{rms} (mA) Max | Color Coding | | |
|---------------|-----------------|----------------|----------------------|-------|----------------------|---------------|-------------|---------------------------|-----------------|-----------------|-----------------|
| | | | | | | | | | 1 ST | 2 ND | 3 RD |
| HQ1008-4N1□-S | 4.1 | 10 / 5 | 50 | 75 | 1500 | 6000 | 0.05 | 1600 | Black | Yellow | Black |
| HQ1008-8N2□-S | 8.2 | 10 / 5 | 50 | 60 | 500 | 3600 | 0.06 | 1600 | Gray | Red | White |
| HQ1008-10N□-S | 10 | 10 / 5 | 50 | 60 | 500 | 3600 | 0.06 | 1600 | Brown | Black | Black |
| HQ1008-12N□-S | 12 | 10 / 5 / 2 | 50 | 70 | 500 | 2800 | 0.06 | 1500 | Brown | Red | Black |
| HQ1008-18N□-S | 18 | 10 / 5 / 2 | 50 | 62 | 350 | 2700 | 0.07 | 1400 | Brown | Gray | Black |
| HQ1008-22N□-S | 22 | 10 / 5 / 2 | 50 | 62 | 350 | 2050 | 0.07 | 1400 | Red | Red | Black |
| HQ1008-33N□-S | 33 | 10 / 5 / 2 | 50 | 75 | 350 | 1700 | 0.09 | 1300 | Orange | Orange | Black |
| HQ1008-39N□-S | 39 | 10 / 5 / 2 | 50 | 75 | 350 | 1300 | 0.09 | 1300 | Orange | White | Black |
| HQ1008-47N□-S | 47 | 10 / 5 / 2 | 50 | 75 | 350 | 1450 | 0.12 | 1200 | Yellow | Violet | Black |
| HQ1008-56N□-S | 56 | 10 / 5 / 2 | 50 | 75 | 350 | 1230 | 0.12 | 1200 | Green | Blue | Black |
| HQ1008-68N□-S | 68 | 10 / 5 / 2 | 50 | 80 | 350 | 1150 | 0.13 | 1100 | Blue | Gray | Black |
| HQ1008-82N□-S | 82 | 10 / 5 / 2 | 50 | 80 | 350 | 1060 | 0.16 | 1100 | Gray | Red | Black |
| HQ1008-R10□-S | 100 | 10 / 5 / 2 | 50 | 62 | 350 | 1000 | 0.16 | 1000 | Brown | Black | Brown |
| HQ1008-R12□-S | 120 | 10 / 5 / 2 | 25 | 50 | 100 | 950 | 0.20 | 1000 | Brown | Red | Brown |
| HQ1008-R15□-S | 150 | 10 / 5 / 2 | 25 | 48 | 100 | 820 | 0.23 | 1000 | Brown | Green | Brown |
| HQ1008-R22□-S | 220 | 10 / 5 / 2 | 25 | 48 | 100 | 730 | 0.45 | 1000 | Red | Red | Brown |
| HQ1008-R27□-S | 270 | 10 / 5 / 2 | 25 | 48 | 100 | 650 | 0.50 | 900 | Red | Violet | Brown |
| HQ1008-R33□-S | 330 | 10 / 5 / 2 | 25 | 48 | 100 | 570 | 0.65 | 900 | Orange | Orange | Brown |
| HQ1008-R39□-S | 390 | 10 / 5 / 2 | 25 | 48 | 100 | 530 | 0.70 | 900 | Orange | White | Brown |

Note: When ordering, please specify tolerance code. Tolerance : G=±2% , J=±5% , K=±10%

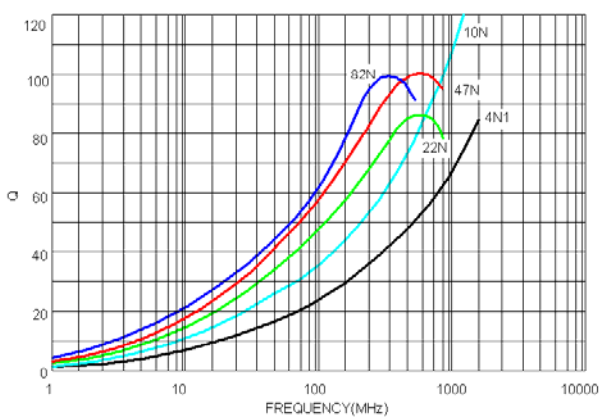
- Operating temperature range - 40°C ~ 125°C(Including self - temperature rise)
- I_{rms} for a 15°C temperature rise from 25°C ambient with current
- Measure Equipment :
 - L & Q : Agilent E4991A+Agilent HP16197A
 - SRF : Agilent HP8753D/Agilent E4991A
 - RDC : HP 4338B or Chroma 16502
 - I_{rms} : HP4284A+HP42841A/HP4285A+HP42841A

Test Instruments : Agilent E4991A Material/Impedance Analyzer

Typical L vs. Frequency



Typical Q vs. Frequency



Please be sure to request approval specifications that provide further details of the products. Kindly note that the content of these specifications are subject to change or may be discontinued without advance notice. Please contact our sales department before ordering.

Packaging Specifications

Tape Dimensions

Reel Dimensions

Figure 1

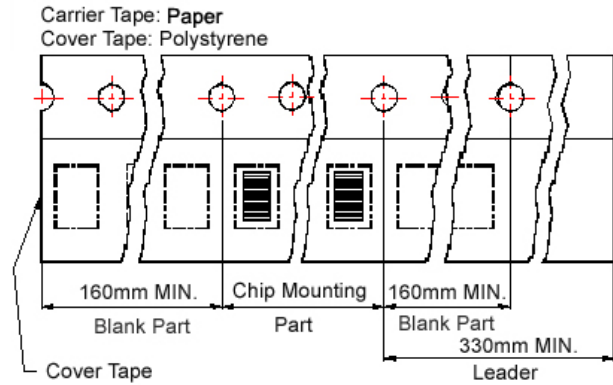
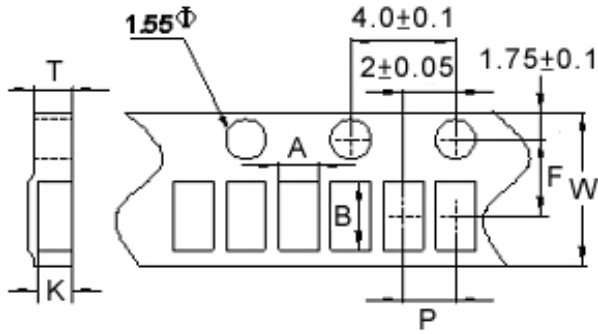
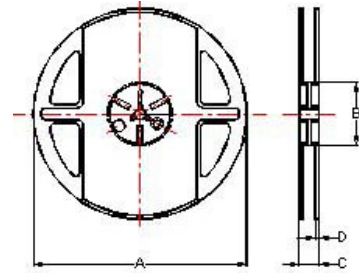
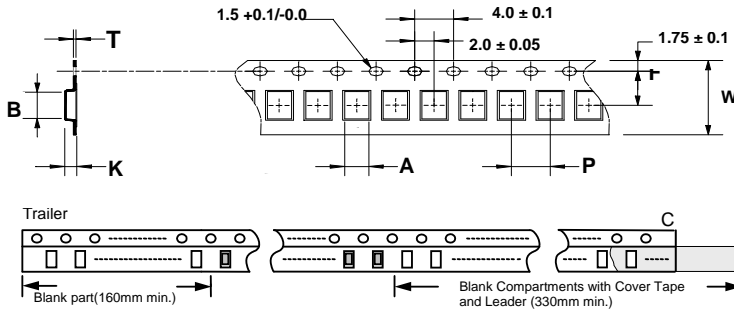


Figure 2



Dimensions in mm

| TYPE | Fig. | Tape Dimensions | | | | | | | Reel Dimensions | | | | Quantity PCS / REEL |
|--------|------|-----------------|------|------|---|---|-----|------|-----------------|----|----|-----|------------------------|
| | | A | B | T | W | P | F | K | A | B | C | D | |
| HQ0201 | 1 | 0.56 | 0.71 | 0.65 | 8 | 2 | 3.5 | 0.54 | 178 | 60 | 12 | 1.5 | 2000 |
| HQ0805 | 2 | 1.85 | 2.45 | 0.23 | 8 | 4 | 3.5 | 1.45 | 178 | 60 | 12 | 1.5 | 2000 |
| HQ1008 | 2 | 2.80 | 2.95 | 0.23 | 8 | 4 | 3.5 | 2.20 | 178 | 60 | 12 | 1.5 | 2000 |

HC Series



Due to accurate wire winding technology, these chip inductors are designed for filtering, impedance matching, resonance and choke circuits for RF designer. Both standard series custom designs are available.

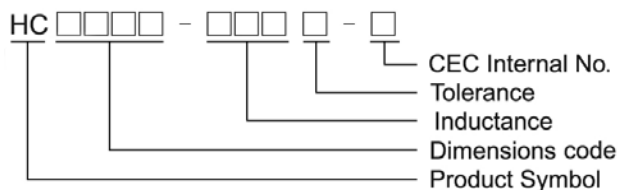
Features

- RoHS compliant
- Ceramic body and wire wound construction provide highest SRFs
- Exceptional Q values even at high frequencies
- Highest possible SRFs as well as excellent Q values
- The non-magnetic coil form assures utmost thermal stability, predictability and batch consistency
- The high current rating and low loss to fit the RF applications

Applications

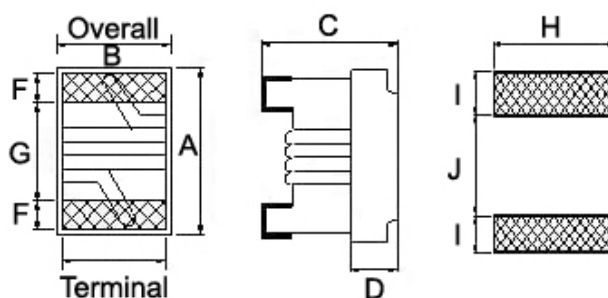
- RF products for cellular phone
- GPS receiver
- Base Station
- Repeater
- Wireless LAN/ mouse/ keyboard/ earphone
- Remote control
- Security system and other RF modules

Product Identification



Shape and Dimensions/ Recommended Pattern

HC0603



Dimensions

| | | A Max | B Max | C Max | D | E | F | G | H | I | J |
|--------|------|-------|-------|-------|-------|-------|-------|-------|-------|-------|-------|
| HC0603 | inch | 0.071 | 0.049 | 0.04 | 0.015 | 0.030 | 0.013 | 0.034 | 0.040 | 0.025 | 0.025 |
| | mm | 1.80 | 1.25 | 1.02 | 0.38 | 0.76 | 0.33 | 0.86 | 1.02 | 0.64 | 0.64 |

Electrical Characteristics

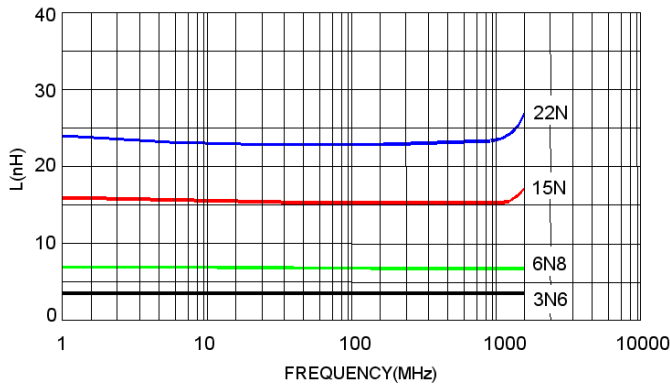
| Part Number | Inductance (nH) | Tolerance (±%) | Test Frequency (MHz) | Q Min | Test Frequency (MHz) | SRF (MHz) Min | RDC (Ω) Max | I _{rms} (mA) Max | Color |
|---------------|-----------------|----------------|----------------------|-------|----------------------|---------------|-------------|---------------------------|--------|
| HC0603-1N6□-S | 1.6 | 10 / 5 | 250 | 24 | 250 | 12500 | 0.030 | 2400 | Black |
| HC0603-3N6□-S | 3.6 | 10 / 5 | 250 | 24 | 250 | 5900 | 0.048 | 2300 | Brown |
| HC0603-3N9□-S | 3.9 | 10 / 5 | 250 | 25 | 250 | 5900 | 0.054 | 2200 | Red |
| HC0603-4N3□-S | 4.3 | 10 / 5 | 250 | 35 | 250 | 5800 | 0.054 | 2100 | Orange |
| HC0603-6N8□-S | 6.8 | 10 / 5 | 250 | 35 | 250 | 5800 | 0.054 | 2100 | Orange |
| HC0603-7N5□-S | 7.5 | 10 / 5 | 250 | 35 | 250 | 3700 | 0.059 | 2100 | Yellow |
| HC0603-8N2□-S | 8.2 | 10 / 5 | 250 | 38 | 250 | 3700 | 0.071 | 2000 | Brown |
| HC0603-10N□-S | 10.0 | 10 / 5 | 250 | 38 | 250 | 3700 | 0.071 | 2000 | Green |
| HC0603-12N□-S | 12.0 | 10 / 5 / 2 | 250 | 38 | 250 | 3000 | 0.075 | 2000 | Blue |
| HC0603-15N□-S | 15.0 | 10 / 5 / 2 | 250 | 38 | 250 | 2800 | 0.080 | 1900 | Violet |
| HC0603-18N□-S | 18.0 | 10 / 5 / 2 | 250 | 40 | 250 | 2800 | 0.099 | 1900 | Gray |
| HC0603-22N□-S | 22.0 | 10 / 5 / 2 | 250 | 42 | 250 | 2400 | 0.099 | 1800 | White |
| HC0603-24N□-S | 24.0 | 10 / 5 / 2 | 250 | 42 | 250 | 2400 | 0.105 | 1800 | Black |

Note: When ordering, please specify tolerance code. Tolerance : G=±2% , J=±5% , K=±10%

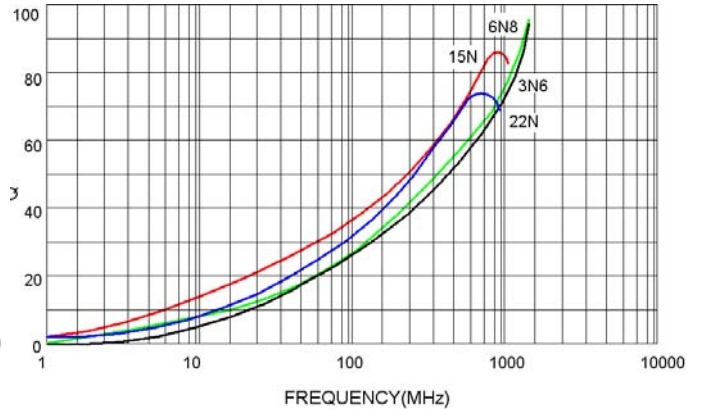
- Operating temperature range - 40°C ~ 125°C(Including self - temperature rise)
- I_{rms} for a 20°C temperature rise from 25°C ambient with current
- Measure Equipment :
 - L & Q : Agilent E4991A+Agilent HP16197A
 - SRF : Agilent HP8753D
 - RDC : HP4338B or Chroma 16502
 - I_{rms} : HP4284A+HP42841A/HP4285A+HP42841A

Test Instruments : Agilent E4991A Material/Impedance Analyzer

Typical L vs. Frequency



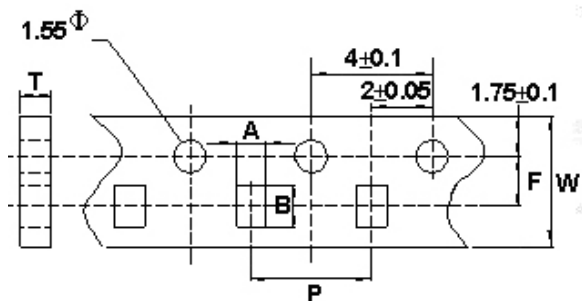
Typical Q vs. Frequency



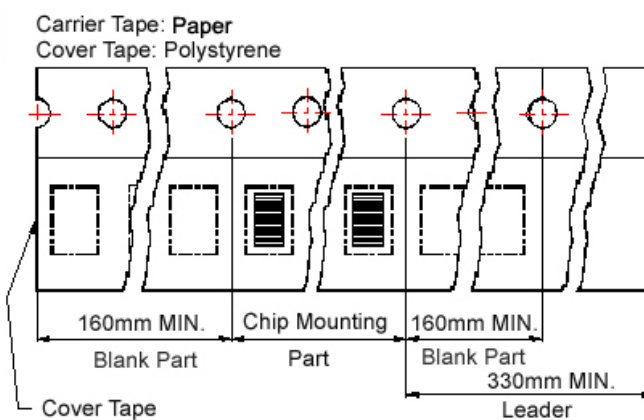
Please be sure to request approval specifications that provide further details of the products. Kindly note that the content of these specifications are subject to change or may be discontinued without advance notice. Please contact our sales department before ordering.

Packaging Specifications

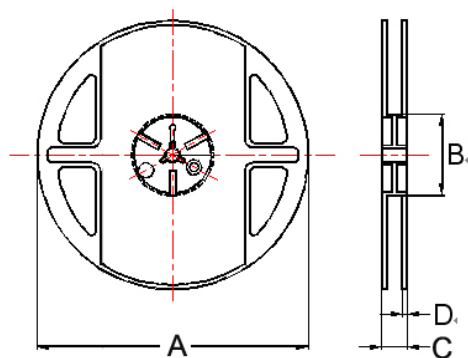
Tape Dimensions



Tape Material



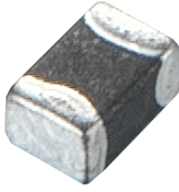
Reel Dimensions



Dimensions in mm

| TYPE | Tape Dimensions | | | | | | Reel Dimensions | | | | Quantity |
|--------|-----------------|------|------|---|---|-----|-----------------|----|----|-----|------------|
| | A | B | T | W | P | F | A | B | C | D | PCS / REEL |
| HC0603 | 1.20 | 1.80 | 1.05 | 8 | 4 | 3.5 | 178 | 60 | 12 | 1.5 | 4000 |

CL Series



The SMD multi-layered ferrite chip inductors provide a cost-effective solution for densely packed PC board designs. CL series comes in 4 sizes and is suitable for low frequency applications.

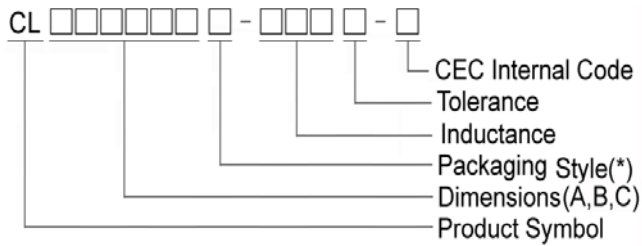
Features

- RoHS compliant
- High mounting density of compact circuit due to crosstalk elimination that results from a closed magnetic flux in a ferrite material
- Suitable for flow and re-flow soldering
- Available in 5 sizes

Applications

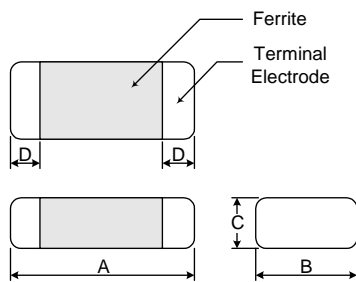
- Personal computers, HDDs, other various electronic devices
- Any portable device where compact size and high mounting densities are required

Product Identification

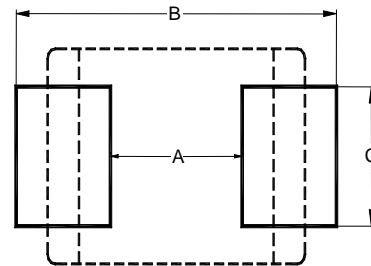


- Packaging : T : Tape and Reel ; B : Bulk

Shape and Dimensions



Recommended Pattern



Dimensions in mm

| TYPE | A | B | C | D |
|----------|----------|-----------|-----------|----------|
| CL160808 | 1.6±0.20 | 0.80±0.20 | 0.80±0.20 | 0.3±0.20 |
| CL201209 | 2.0±0.20 | 1.25±0.20 | 0.90±0.20 | 0.5±0.30 |
| CL201212 | 2.0±0.20 | 1.25±0.20 | 1.25±0.20 | 0.5±0.30 |
| CL321611 | 3.2±0.20 | 1.60±0.20 | 1.10±0.20 | 0.5±0.30 |

Dimensions in mm

| TYPE | A | B | C |
|----------|-----------|-----------|-----------|
| CL160808 | 0.7 ~ 0.8 | 1.8 ~ 2.0 | 0.6 ~ 0.8 |
| CL201209 | 1.0 ~ 1.2 | 2.6 ~ 4.0 | 1.0 ~ 1.2 |
| CL201212 | 1.0 ~ 1.2 | 2.6 ~ 4.0 | 1.0 ~ 1.2 |
| CL321611 | 2.0 | 4.2 ~ 5.2 | 1.2 |

Electrical Characteristics

| Part Number | Inductance (μ H) | Tolerance (\pm %) | Q Min | Test Frequency (MHz) | SRF (MHz) Min | RDC (Ω) Max | IDC (mA) Max |
|------------------|--------------------------|-------------------------|----------|----------------------------|------------------|-------------------------|-----------------|
| CL160808T-10N□-N | 0.010 | 20 | 15 | 50 | 300 | 0.2 | 50 |
| CL160808T-33N□-N | 0.033 | 20 | 15 | 50 | 270 | 0.2 | 50 |
| CL160808T-47N□-N | 0.047 | 20 | 15 | 50 | 260 | 0.3 | 50 |
| CL160808T-56N□-N | 0.056 | 20 | 15 | 50 | 255 | 0.3 | 50 |
| CL160808T-68N□-N | 0.068 | 20 | 15 | 50 | 250 | 0.3 | 50 |
| CL160808T-82N□-N | 0.082 | 20 | 15 | 50 | 245 | 0.3 | 50 |
| CL160808T-R10□-N | 0.10 | 20 / 15 / 10 | 25 | 25 | 240 | 0.5 | 50 |
| CL160808T-R12□-N | 0.12 | 20 / 15 / 10 | 25 | 25 | 205 | 0.5 | 50 |
| CL160808T-R15□-N | 0.15 | 20 / 15 / 10 | 25 | 25 | 180 | 0.6 | 50 |
| CL160808T-R18□-N | 0.18 | 20 / 15 / 10 | 25 | 25 | 165 | 0.6 | 50 |
| CL160808T-R22□-N | 0.22 | 20 / 15 / 10 | 25 | 25 | 150 | 0.8 | 50 |
| CL160808T-R27□-N | 0.27 | 20 / 15 / 10 | 25 | 25 | 136 | 0.8 | 50 |
| CL160808T-R33□-N | 0.33 | 20 / 15 / 10 | 25 | 25 | 125 | 0.85 | 35 |
| CL160808T-R39□-N | 0.39 | 20 / 15 / 10 | 25 | 25 | 110 | 1.00 | 35 |
| CL160808T-R47□-N | 0.47 | 20 / 15 / 10 | 25 | 25 | 105 | 1.35 | 35 |
| CL160808T-R56□-N | 0.56 | 20 / 15 / 10 | 25 | 25 | 95 | 1.50 | 35 |
| CL160808T-R68□-N | 0.68 | 20 / 15 / 10 | 25 | 25 | 85 | 1.70 | 35 |
| CL160808T-R82□-N | 0.82 | 20 / 15 / 10 | 25 | 25 | 75 | 2.10 | 35 |
| CL160808T-1R0□-N | 1.0 | 20 / 15 / 10 | 35 | 10 | 65 | 0.60 | 25 |
| CL160808T-1R2□-N | 1.2 | 20 / 15 / 10 | 35 | 10 | 60 | 0.80 | 25 |
| CL160808T-1R5□-N | 1.5 | 20 / 15 / 10 | 35 | 10 | 55 | 0.80 | 25 |
| CL160808T-1R8□-N | 1.8 | 20 / 15 / 10 | 35 | 10 | 50 | 0.95 | 25 |
| CL160808T-2R2□-N | 2.2 | 20 / 15 / 10 | 35 | 10 | 45 | 1.00 | 15 |
| CL160808T-2R7□-N | 2.7 | 20 / 15 / 10 | 35 | 10 | 40 | 1.15 | 15 |
| CL160808T-3R3□-N | 3.3 | 20 / 15 / 10 | 35 | 10 | 38 | 1.30 | 15 |
| CL160808T-3R9□-N | 3.9 | 20 / 15 / 10 | 35 | 10 | 36 | 1.50 | 15 |
| CL160808T-4R7□-N | 4.7 | 20 / 15 / 10 | 35 | 10 | 33 | 1.60 | 15 |
| CL160808T-5R6□-N | 5.6 | 20 / 15 / 10 | 35 | 4 | 22 | 1.10 | 5 |
| CL160808T-6R8□-N | 6.8 | 20 / 15 / 10 | 35 | 4 | 20 | 1.30 | 5 |
| CL160808T-8R2□-N | 8.2 | 20 / 15 / 10 | 30 | 4 | 18 | 1.50 | 5 |
| CL160808T-100□-N | 10 | 20 / 15 / 10 | 30 | 2 | 17 | 1.70 | 5 |
| CL160808T-120□-N | 12 | 20 / 15 / 10 | 30 | 2 | 15 | 1.80 | 3 |
| CL160808T-150□-N | 15 | 20 / 15 / 10 | 20 | 1 | 14 | 1.50 | 1 |
| CL160808T-220□-N | 22 | 20 / 15 / 10 | 20 | 1 | 11 | 1.70 | 1 |

Note: When ordering, please specify tolerance code. Tolerance : K= \pm 10% , L= \pm 15% , M= \pm 20%

- Operating temperature range - 40°C ~ 125°C(Including self - temperature rise)
- IDC : Applied the current to coils, the inductance shall be less than 10% initial value
- Measure Equipment :
 - L & Q : HP4291A
 - SRF : Agilent HP8753D/Agilent E4991A
 - RDC : HP4338B or CHEN HWA 502

Electrical Characteristics

| Part Number | Inductance (μ H) | Tolerance (\pm %) | Q Min | Test Frequency (MHz) | SRF (MHz) Min | RDC (Ω) Max | IDC (mA) Max |
|------------------|--------------------------|-------------------------|----------|-------------------------|------------------|-------------------------|-----------------|
| CL201209T-22N□-N | 0.022 | 20 | 20 | 50 | 320 | 0.20 | 300 |
| CL201209T-33N□-N | 0.033 | 20 / 15 | 20 | 50 | 320 | 0.20 | 300 |
| CL201209T-47N□-N | 0.047 | 20 / 15 | 20 | 50 | 320 | 0.20 | 300 |
| CL201209T-56N□-N | 0.056 | 20 / 15 | 20 | 50 | 320 | 0.20 | 300 |
| CL201209T-68N□-N | 0.068 | 20 / 15 | 20 | 50 | 280 | 0.20 | 300 |
| CL201209T-82N□-N | 0.082 | 20 / 15 | 20 | 50 | 255 | 0.20 | 300 |
| CL201209T-R10□-N | 0.10 | 20 / 15 / 0 | 25 | 25 | 235 | 0.30 | 250 |
| CL201209T-R12□-N | 0.12 | 20 / 15 / 10 | 25 | 25 | 220 | 0.30 | 250 |
| CL201209T-R15□-N | 0.15 | 20 / 15 / 10 | 25 | 25 | 200 | 0.40 | 250 |
| CL201209T-R18□-N | 0.18 | 20 / 15 / 10 | 25 | 25 | 185 | 0.40 | 250 |
| CL201209T-R22□-N | 0.22 | 20 / 15 / 10 | 25 | 25 | 170 | 0.50 | 250 |
| CL201209T-R27□-N | 0.27 | 20 / 15 / 10 | 25 | 25 | 150 | 0.50 | 250 |
| CL201209T-R33□-N | 0.33 | 20 / 15 / 10 | 25 | 25 | 145 | 0.55 | 250 |
| CL201209T-R39□-N | 0.39 | 20 / 15 / 10 | 25 | 25 | 135 | 0.65 | 250 |
| CL201209T-R47□-N | 0.47 | 20 / 15 / 10 | 25 | 25 | 125 | 0.65 | 250 |
| CL201209T-R56□-N | 0.56 | 20 / 15 / 10 | 25 | 25 | 115 | 0.75 | 150 |
| CL201209T-R68□-N | 0.68 | 20 / 15 / 10 | 25 | 25 | 105 | 0.80 | 150 |
| CL201209T-R82□-N | 0.82 | 20 / 15 / 10 | 25 | 25 | 100 | 1.00 | 150 |
| CL201209T-1R0□-N | 1.0 | 20 / 15 / 10 | 45 | 10 | 75 | 0.40 | 50 |
| CL201209T-1R2□-N | 1.2 | 20 / 15 / 10 | 45 | 10 | 65 | 0.50 | 50 |
| CL201209T-1R5□-N | 1.5 | 20 / 15 / 10 | 45 | 10 | 60 | 0.50 | 50 |
| CL201209T-1R8□-N | 1.8 | 20 / 15 / 10 | 45 | 10 | 55 | 0.60 | 50 |
| CL201209T-2R2□-N | 2.2 | 20 / 15 / 10 | 45 | 10 | 50 | 0.65 | 30 |

Note: When ordering, please specify tolerance code. Tolerance : K= \pm 10% , L= \pm 15% , M= \pm 20%

- Operating temperature range - 40°C ~ 125°C(Including self - temperature rise)
- IDC : Applied the current to coils, the inductance shall be less than 10% initial value
- Measure Equipment :
L & Q : HP4291A
SRF : Agilent HP8753D/Agilent E4991A
RDC : HP4338B or CHEN HWA 502

Electrical Characteristics

| Part Number | Inductance (μ H) | Tolerance (\pm %) | Q Min | Test Frequency (MHz) | SRF (MHz) Min | RDC (Ω) Max | IDC (mA) Max |
|------------------|--------------------------|-------------------------|----------|-------------------------|------------------|-------------------------|-----------------|
| CL201212T-2R7□-N | 2.7 | 20 / 15 / 10 | 45 | 10 | 45 | 0.75 | 30 |
| CL201212T-3R3□-N | 3.3 | 20 / 15 / 10 | 45 | 10 | 41 | 0.80 | 30 |
| CL201212T-3R9□-N | 3.9 | 20 / 15 / 10 | 45 | 10 | 38 | 0.90 | 30 |
| CL201212T-4R7□-N | 4.7 | 20 / 15 / 10 | 45 | 10 | 35 | 1.00 | 30 |
| CL201212T-5R6□-N | 5.6 | 20 / 15 / 10 | 45 | 4 | 32 | 0.90 | 15 |
| CL201212T-6R8□-N | 6.8 | 20 / 15 / 10 | 45 | 4 | 29 | 1.00 | 15 |
| CL201212T-8R2□-N | 8.2 | 20 / 15 / 10 | 45 | 4 | 26 | 1.10 | 15 |
| CL201212T-100□-N | 10 | 20 / 15 / 10 | 45 | 2 | 24 | 1.10 | 15 |
| CL201212T-120□-N | 12 | 20 / 15 / 10 | 45 | 2 | 22 | 1.20 | 15 |
| CL201212T-150□-N | 15 | 20 / 15 / 10 | 30 | 1 | 19 | 0.80 | 5 |
| CL201212T-180□-N | 18 | 20 / 15 / 10 | 30 | 1 | 18 | 0.90 | 5 |
| CL201212T-220□-N | 22 | 20 / 15 / 10 | 30 | 1 | 16 | 1.1 | 5 |

Note: When ordering, please specify tolerance code. Tolerance : K= \pm 10% , L= \pm 15% , M= \pm 20%

- Operating temperature range - 40°C ~ 125°C(Including self - temperature rise)
- IDC : Applied the current to coils, the inductance shall be less than 10% initial value
- Measure Equipment :
L & Q : HP4291A
SRF : Agilent HP8753D/Agilent E4991A
RDC : HP4338B or CHEN HWA 502

Please be sure to request approval specifications that provide further details of the products. Kindly note that the content of these specifications are subject to change or may be discontinued without advance notice. Please contact our sales department before ordering.

Electrical Characteristics

| Part Number | Inductance (μ H) | Tolerance (\pm %) | Q Min | Test Frequency (MHz) | SRF (MHz) Min | RDC (Ω) Max | IDC (mA) Max |
|------------------|--------------------------|-------------------------|----------|----------------------------|------------------|-------------------------|-----------------|
| CL321611T-47N□-N | 0.047 | 20 | 20 | 50 | 320 | 0.15 | 300 |
| CL321611T-56N□-N | 0.056 | 20 | 20 | 50 | 280 | 0.25 | 300 |
| CL321611T-68N□-N | 0.068 | 20 | 20 | 50 | 280 | 0.25 | 300 |
| CL321611T-82N□-N | 0.082 | 20 | 20 | 50 | 250 | 0.25 | 300 |
| CL321611T-R10□-N | 0.10 | 20 / 15 / 10 | 25 | 25 | 235 | 0.25 | 250 |
| CL321611T-R12□-N | 0.12 | 20 / 15 / 10 | 25 | 25 | 220 | 0.30 | 250 |
| CL321611T-R15□-N | 0.15 | 20 / 15 / 10 | 25 | 25 | 200 | 0.30 | 250 |
| CL321611T-R18□-N | 0.18 | 20 / 15 / 10 | 25 | 25 | 185 | 0.40 | 250 |
| CL321611T-R22□-N | 0.22 | 20 / 15 / 10 | 25 | 25 | 170 | 0.40 | 250 |
| CL321611T-R27□-N | 0.27 | 20 / 15 / 10 | 25 | 25 | 150 | 0.50 | 250 |
| CL321611T-R33□-N | 0.33 | 20 / 15 / 10 | 25 | 25 | 145 | 0.60 | 250 |
| CL321611T-R39□-N | 0.39 | 20 / 15 / 10 | 25 | 25 | 135 | 0.50 | 200 |
| CL321611T-R47□-N | 0.47 | 20 / 15 / 10 | 25 | 25 | 125 | 0.60 | 200 |
| CL321611T-R56□-N | 0.56 | 20 / 15 / 10 | 25 | 25 | 115 | 0.70 | 150 |
| CL321611T-R68□-N | 0.68 | 20 / 15 / 10 | 25 | 25 | 105 | 0.80 | 150 |
| CL321611T-R82□-N | 0.82 | 20 / 15 / 10 | 25 | 25 | 100 | 0.90 | 150 |
| CL321611T-1R0□-N | 1.0 | 20 / 15 / 10 | 45 | 10 | 75 | 0.40 | 100 |
| CL321611T-1R2□-N | 1.2 | 20 / 15 / 10 | 45 | 10 | 65 | 0.50 | 100 |
| CL321611T-1R5□-N | 1.5 | 20 / 15 / 10 | 45 | 10 | 60 | 0.50 | 80 |
| CL321611T-1R8□-N | 1.8 | 20 / 15 / 10 | 45 | 10 | 55 | 0.50 | 70 |
| CL321611T-2R2□-N | 2.2 | 20 / 15 / 10 | 45 | 10 | 50 | 0.60 | 60 |
| CL321611T-2R7□-N | 2.7 | 20 / 15 / 10 | 45 | 10 | 45 | 0.60 | 60 |
| CL321611T-3R3□-N | 3.3 | 20 / 15 / 10 | 45 | 10 | 41 | 0.70 | 60 |
| CL321611T-3R9□-N | 3.9 | 20 / 15 / 10 | 45 | 10 | 38 | 0.80 | 50 |
| CL321611T-4R7□-N | 4.7 | 20 / 15 / 10 | 45 | 10 | 35 | 0.90 | 50 |
| CL321611T-5R6□-N | 5.6 | 20 / 15 / 10 | 45 | 4 | 32 | 0.70 | 25 |
| CL321611T-6R8□-N | 6.8 | 20 / 15 / 10 | 45 | 4 | 29 | 0.80 | 25 |
| CL321611T-8R2□-N | 8.2 | 20 / 15 / 10 | 45 | 4 | 26 | 0.90 | 25 |
| CL321611T-100□-N | 10 | 20 / 15 / 10 | 45 | 2 | 24 | 1.00 | 25 |
| CL321611T-120□-N | 12 | 20 / 15 / 10 | 45 | 2 | 22 | 1.00 | 15 |
| CL321611T-150□-N | 15 | 20 / 15 / 10 | 35 | 1 | 19 | 0.70 | 5 |
| CL321611T-180□-N | 18 | 20 / 15 / 10 | 35 | 1 | 18 | 0.75 | 5 |
| CL321611T-220□-N | 22 | 20 / 15 / 10 | 35 | 1 | 16 | 0.90 | 5 |
| CL321611T-270□-N | 27 | 20 / 15 / 10 | 35 | 1 | 14 | 0.90 | 5 |

Note: When ordering, please specify tolerance code. Tolerance : K= \pm 10% , L= \pm 15% , M= \pm 20%

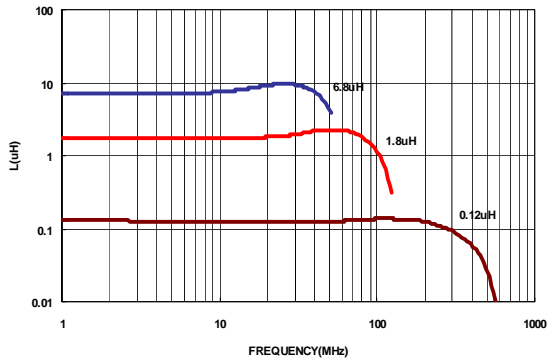
- Operating temperature range - 40°C ~ 125°C(Including self - temperature rise)
- IDC : Applied the current to coils, the inductance shall be less than 10% initial value
- Measure Equipment :
 - L & Q : HP4291A
 - SRF : Agilent HP8753D/Agilent E4991A
 - RDC : HP4338B or CHEN HWA 502

SMD Multilayer Ferrite Chip Inductors - CL Series

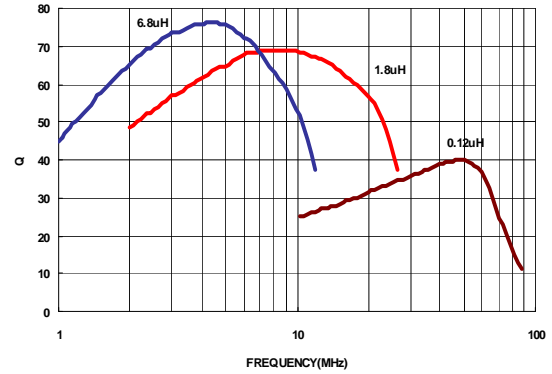
Test Instruments : Agilent E4991A Impedance / Material Analyzer

CL160808

INDUCTANCE vs. FREQUENCY CHARACTERISTICS

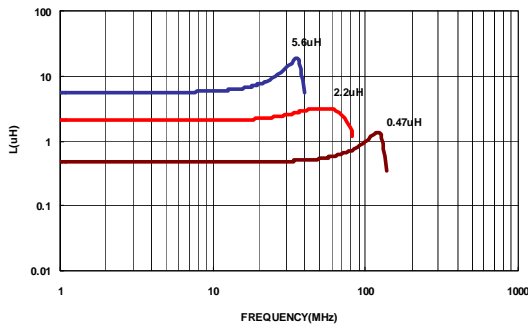


Q vs. FREQUENCY CHARACTERISTICS

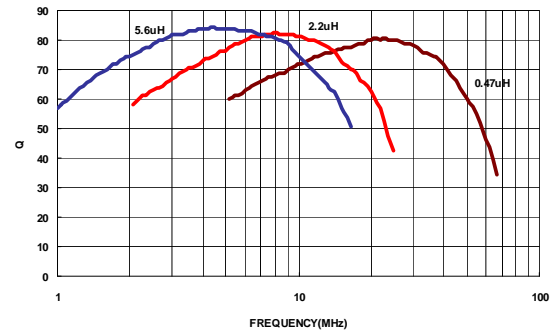


CL201209

INDUCTANCE vs. FREQUENCY CHARACTERISTICS

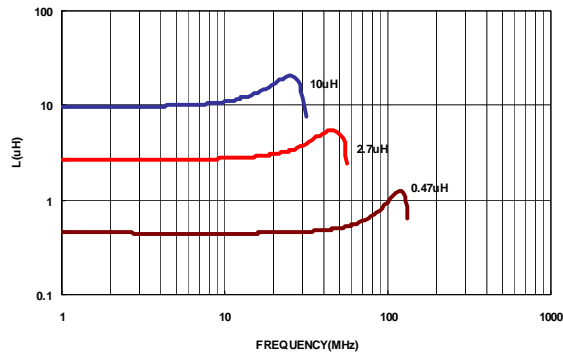


Q vs. FREQUENCY CHARACTERISTICS

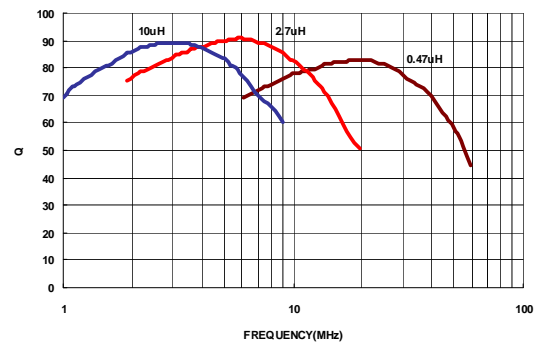


CL321611

INDUCTANCE vs. FREQUENCY CHARACTERISTICS

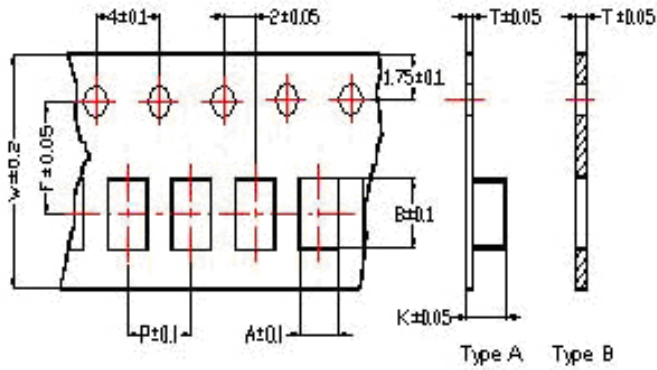


Q vs. FREQUENCY CHARACTERISTICS

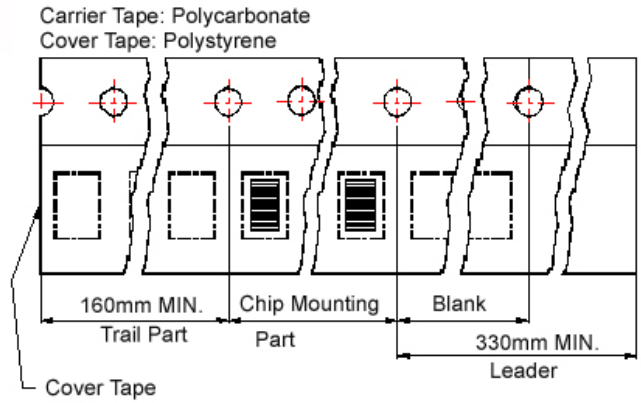


Packaging Specifications

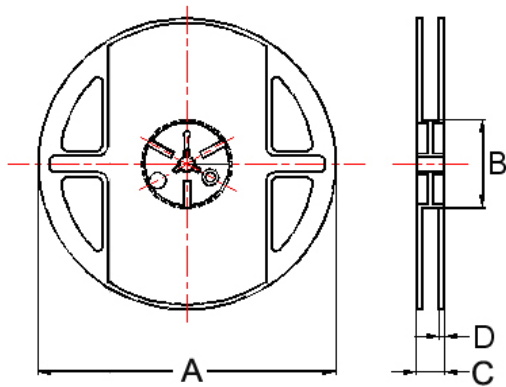
Tape Dimensions



Tape Material



Reel Dimensions



Dimensions in mm

| TYPE | Tape Dimensions | | | | | | | | Tape | Reel Dimensions | | | | Quantity PCS / Reel |
|----------|-----------------|------|------|-----|-----|-----|------|---|------|-----------------|----|-----|------|------------------------|
| | A | B | T | W | P | F | K | A | | B | C | D | | |
| CL160808 | 1.05 | 1.85 | 0.95 | 8.0 | 4.0 | 3.5 | - | B | 178 | 60 | 12 | 1.5 | 4000 | |
| CL201209 | 1.50 | 2.30 | 0.97 | 8.0 | 4.0 | 3.5 | - | B | 178 | 60 | 12 | 1.5 | 4000 | |
| CL201212 | 1.35 | 2.25 | 0.22 | 8.0 | 4.0 | 3.5 | 1.35 | A | 178 | 60 | 12 | 1.5 | 3000 | |
| CL321611 | 1.88 | 3.50 | 0.22 | 8.0 | 4.0 | 3.5 | 1.27 | A | 178 | 60 | 12 | 1.5 | 3000 | |

NL Series



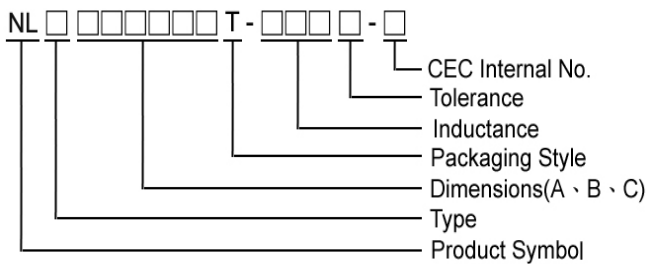
Features

- RoHS compliant
- Strong solderability by reflow soldering and soldering iron
- Highly accurate dimensions
- Can be mounted automatically
- Terminals are highly resistant to external forces
- Highly resistant to mechanical shocks and pressure
- Highly reliable in environments of sudden temperature change and humidity
- Superior Q characteristics and the broadest L selections among peers

Applications

- Microtelevisions
- Liquid crystal televisions
- Video cameras
- Portable VCRs
- Car radios
- Car stereos
- Thin tape radios
- Television tuners
- Mobile telephones
- Radio and other electronic devices

Product Identification

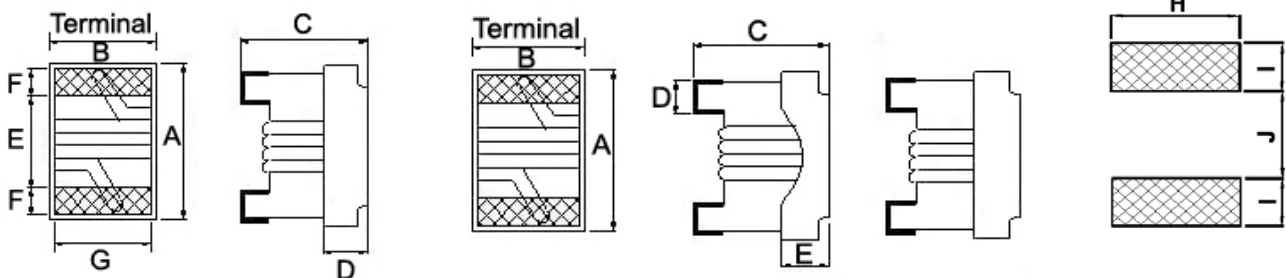


- Packaging: T : Tape and Reel

Shape and Dimensions

NL201614

NL252018

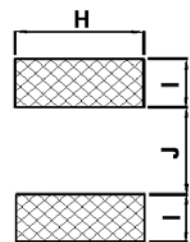


Dimensions in mm

| TYPE | A Max | B Max | C Max | D | E | F | G | H | I | J |
|----------|-------|-----------|-------|------|------|------|------|------|------|------|
| NL201614 | 2.40 | 1.72 | 1.52 | 0.70 | 1.02 | 0.50 | 1.27 | 1.78 | 1.02 | 0.76 |
| NL252018 | 2.92 | 2.50 2.79 | 2.20 | 0.51 | 0.51 | - | - | 2.54 | 1.02 | 1.27 |

NL252018: B Max: 2.79 mm, at 5N0-R10,
2.50 mm, at R12-101

Recommended Pattern



Electrical Characteristics

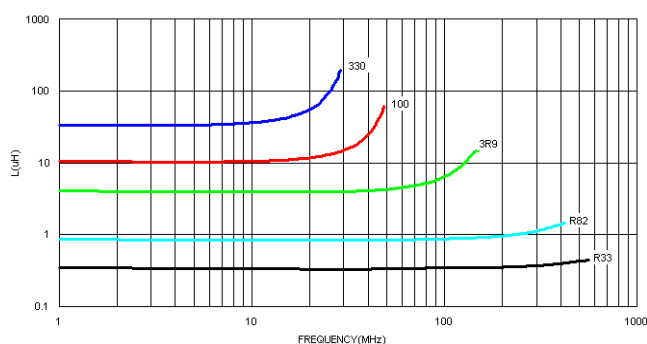
| Part Number | Inductance (uH) | Tolerance (±%) | Q Min | Test Frequency (MHz) | SRF (MHz) Min | RDC (Ω) Max | IDC (mA) | Color |
|------------------|-----------------|----------------|-------|----------------------|---------------|-------------|----------|--------|
| NL201614T-R12□-N | 0.12 | 10 / 5 | 25 | 25.2 | 500 | 0.20 | 600 | White |
| NL201614T-R15□-N | 0.15 | 10 / 5 | 25 | 25.2 | 450 | 0.25 | 600 | Black |
| NL201614T-R18□-N | 0.18 | 10 / 5 | 25 | 25.2 | 410 | 0.30 | 570 | Brown |
| NL201614T-R22□-N | 0.22 | 10 / 5 | 25 | 25.2 | 350 | 0.35 | 550 | Red |
| NL201614T-R27□-N | 0.27 | 10 / 5 | 25 | 25.2 | 280 | 0.40 | 530 | Orange |
| NL201614T-R33□-N | 0.33 | 10 / 5 | 25 | 25.2 | 235 | 0.45 | 510 | Yellow |
| NL201614T-R39□-N | 0.39 | 10 / 5 | 25 | 25.2 | 210 | 0.50 | 490 | Green |
| NL201614T-R47□-N | 0.47 | 10 / 5 | 25 | 25.2 | 170 | 0.55 | 470 | Blue |
| NL201614T-R56□-N | 0.56 | 10 / 5 | 25 | 25.2 | 150 | 0.60 | 450 | Violet |
| NL201614T-R68□-N | 0.68 | 10 / 5 | 25 | 25.2 | 140 | 0.70 | 420 | Gray |
| NL201614T-R82□-N | 0.82 | 10 / 5 | 25 | 25.2 | 130 | 0.75 | 400 | White |
| NL201614T-1R0□-N | 1.00 | 10 / 5 | 15 | 7.96 | 115 | 0.80 | 350 | Black |
| NL201614T-1R2□-N | 1.20 | 10 / 5 | 15 | 7.96 | 95 | 0.90 | 325 | Brown |
| NL201614T-1R5□-N | 1.50 | 10 / 5 | 15 | 7.96 | 85 | 1.05 | 300 | Red |
| NL201614T-1R8□-N | 1.80 | 10 / 5 | 15 | 7.96 | 80 | 1.20 | 270 | Orange |
| NL201614T-2R2□-N | 2.20 | 10 / 5 | 15 | 7.96 | 75 | 1.40 | 250 | Yellow |
| NL201614T-2R7□-N | 2.70 | 10 / 5 | 15 | 7.96 | 70 | 1.60 | 230 | Green |
| NL201614T-3R3□-N | 3.30 | 10 / 5 | 15 | 7.96 | 60 | 1.80 | 210 | Blue |
| NL201614T-3R9□-N | 3.90 | 10 / 5 | 15 | 7.96 | 55 | 2.00 | 190 | Violet |
| NL201614T-4R7□-N | 4.70 | 10 / 5 | 15 | 7.96 | 45 | 2.40 | 170 | Gray |
| NL201614T-5R6□-N | 5.60 | 10 / 5 | 15 | 7.96 | 40 | 2.70 | 150 | White |
| NL201614T-6R8□-N | 6.80 | 10 / 5 | 15 | 7.96 | 36 | 3.20 | 140 | Black |
| NL201614T-8R2□-N | 8.20 | 10 / 5 | 15 | 7.96 | 33 | 3.60 | 120 | Brown |
| NL201614T-100□-N | 10.0 | 10 / 5 | 15 | 2.52 | 30 | 4.50 | 110 | Red |
| NL201614T-120□-N | 12.0 | 10 / 5 | 15 | 2.52 | 25 | 5.70 | 105 | Orange |
| NL201614T-150□-N | 15.0 | 10 / 5 | 15 | 2.52 | 23 | 6.50 | 90 | Yellow |
| NL201614T-180□-N | 18.0 | 10 / 5 | 15 | 2.52 | 21 | 7.00 | 85 | Green |
| NL201614T-220□-N | 22.0 | 10 / 5 | 15 | 2.52 | 20 | 8.00 | 78 | Blue |
| NL201614T-270□-N | 27.0 | 10 / 5 | 15 | 2.52 | 18 | 9.00 | 75 | Violet |
| NL201614T-330□-N | 33.0 | 10 / 5 | 15 | 2.52 | 17 | 10.0 | 70 | Gray |

Note: When ordering, please specify tolerance code. Tolerance : J=±5% , K=±10%

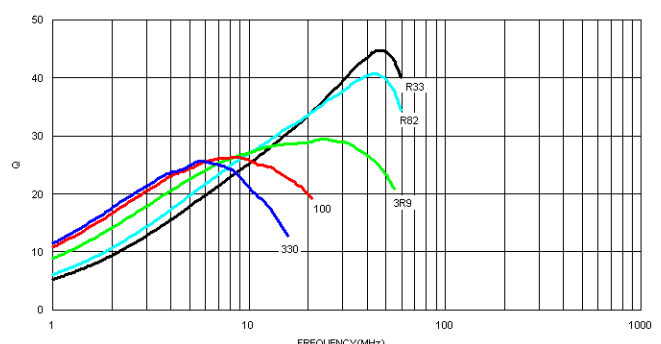
- Operating temperature range - 25°C ~ 105°C(Including self - temperature rise)
- IDC for Inductance drop 10% from its value with current
- Measure Equipment :
 L & Q : Agilent E4991A+Agilent HP16197A
 SRF : Agilent E4991A
 RDC : HP4338B or Chroma 16502

Test Instruments : Agilent E4991A Material/Impedance Analyzer

Typical L vs. Frequency



Typical Q vs. Frequency



Please be sure to request approval specifications that provide further details of the products. Kindly note that the content of these specifications are subject to change or may be discontinued without advance notice. Please contact our sales department before ordering.

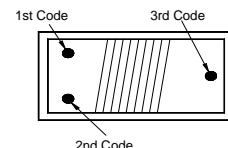
SMD Wire Wound Ferrite Chip Inductors – NL Series

Electrical Characteristics

| Part Number | Inductance (uH) | Tolerance (±%) | Q Min | Test Frequency (MHz) | SRF (MHz) Min | RDC (Ω) Max | IDC (mA) | Color Coding | | |
|------------------|--------------------|-------------------|----------|-------------------------|------------------|----------------|-------------|-----------------|-----------------|-----------------|
| | | | | | | | | 1 ST | 2 ND | 3 RD |
| NL252018T-5N0□-N | 0.005 | 10 | 10 | 100 | 3000 | 0.25 | 2000 | Black | Green | Black |
| NL252018T-10N□-N | 0.010 | 10 | 10 | 100 | 2500 | 0.25 | 1800 | Brown | Black | Black |
| NL252018T-12N□-N | 0.012 | 10 | 15 | 100 | 2400 | 0.26 | 1700 | Brown | Red | Black |
| NL252018T-15N□-N | 0.015 | 10 | 15 | 100 | 2300 | 0.28 | 1600 | Brown | Green | Black |
| NL252018T-18N□-N | 0.018 | 10 | 15 | 100 | 2200 | 0.30 | 1550 | Brown | Gray | Black |
| NL252018T-22N□-N | 0.022 | 10 / 5 | 20 | 100 | 2100 | 0.35 | 1500 | Red | Red | Black |
| NL252018T-27N□-N | 0.027 | 10 / 5 | 20 | 100 | 2000 | 0.40 | 1450 | Red | Violet | Black |
| NL252018T-33N□-N | 0.033 | 10 / 5 | 30 | 100 | 1600 | 0.42 | 1400 | Orange | Orange | Black |
| NL252018T-39N□-N | 0.039 | 10 / 5 | 35 | 100 | 1500 | 0.45 | 1350 | Orange | White | Black |
| NL252018T-47N□-N | 0.047 | 10 / 5 | 35 | 100 | 1400 | 0.50 | 1300 | Yellow | Violet | Black |
| NL252018T-56N□-N | 0.056 | 10 / 5 | 35 | 100 | 1300 | 0.60 | 1250 | Green | Blue | Black |
| NL252018T-68N□-N | 0.068 | 10 / 5 | 35 | 100 | 1200 | 0.65 | 1240 | Blue | Gray | Black |
| NL252018T-82N□-N | 0.082 | 10 / 5 | 35 | 100 | 1100 | 0.75 | 1230 | Gray | Red | Black |
| NL252018T-R10□-N | 0.10 | 10 / 5 | 35 | 100 | 800 | 0.80 | 1220 | Brown | Black | Brown |
| NL252018T-R12□-N | 0.12 | 10 / 5 | 30 | 25.2 | 700 | 0.30 | 900 | Brown | Red | Brown |
| NL252018T-R15□-N | 0.15 | 10 / 5 | 30 | 25.2 | 550 | 0.35 | 900 | Brown | Green | Brown |
| NL252018T-R18□-N | 0.18 | 10 / 5 | 30 | 25.2 | 500 | 0.40 | 850 | Brown | Gray | Brown |
| NL252018T-R22□-N | 0.22 | 10 / 5 | 30 | 25.2 | 450 | 0.50 | 840 | Red | Red | Brown |
| NL252018T-R27□-N | 0.27 | 10 / 5 | 30 | 25.2 | 425 | 0.55 | 830 | Red | Violet | Brown |
| NL252018T-R33□-N | 0.33 | 10 / 5 | 30 | 25.2 | 400 | 0.60 | 820 | Orange | Orange | Brown |
| NL252018T-R39□-N | 0.39 | 10 / 5 | 30 | 25.2 | 375 | 0.65 | 810 | Orange | White | Brown |
| NL252018T-R47□-N | 0.47 | 10 / 5 | 30 | 25.2 | 350 | 0.68 | 800 | Yellow | Violet | Brown |
| NL252018T-R56□-N | 0.56 | 10 / 5 | 30 | 25.2 | 325 | 0.75 | 800 | Green | Blue | Brown |
| NL252018T-R68□-N | 0.68 | 10 / 5 | 30 | 25.2 | 300 | 0.85 | 800 | Blue | Gray | Brown |
| NL252018T-R82□-N | 0.82 | 10 / 5 | 30 | 25.2 | 260 | 1.0 | 800 | Gray | Red | Brown |
| NL252018T-1R0□-N | 1.0 | 10 / 5 | 25 | 7.96 | 245 | 1.1 | 800 | Brown | Black | Red |
| NL252018T-1R2□-N | 1.2 | 10 / 5 | 25 | 7.96 | 230 | 1.2 | 790 | Brown | Red | Red |
| NL252018T-1R5□-N | 1.5 | 10 / 5 | 25 | 7.96 | 182 | 1.3 | 750 | Brown | Green | Red |
| NL252018T-1R8□-N | 1.8 | 10 / 5 | 25 | 7.96 | 135 | 1.45 | 750 | Brown | Gray | Red |
| NL252018T-2R2□-N | 2.2 | 10 / 5 | 25 | 7.96 | 105 | 1.55 | 750 | Red | Red | Red |
| NL252018T-2R7□-N | 2.7 | 10 / 5 | 25 | 7.96 | 70 | 1.7 | 740 | Red | Violet | Red |
| NL252018T-3R3□-N | 3.3 | 10 / 5 | 25 | 7.96 | 55 | 1.9 | 730 | Orange | Orange | Red |
| NL252018T-3R9□-N | 3.9 | 10 / 5 | 25 | 7.96 | 48 | 2.1 | 700 | Orange | White | Red |
| NL252018T-4R7□-N | 4.7 | 10 / 5 | 25 | 7.96 | 43 | 2.3 | 650 | Yellow | Violet | Red |
| NL252018T-5R6□-N | 5.6 | 10 / 5 | 20 | 7.96 | 42 | 2.5 | 640 | Green | Blue | Red |
| NL252018T-6R8□-N | 6.8 | 10 / 5 | 20 | 7.96 | 39 | 2.7 | 630 | Blue | Gray | Red |
| NL252018T-8R2□-N | 8.2 | 10 / 5 | 20 | 7.96 | 36 | 3.05 | 600 | Gray | Red | Red |
| NL252018T-100□-N | 10 | 10 / 5 | 15 | 2.52 | 33 | 3.5 | 600 | Brown | Black | Orange |
| NL252018T-120□-N | 12 | 10 / 5 | 15 | 2.52 | 30 | 3.8 | 550 | Brown | Red | Orange |
| NL252018T-150□-N | 15 | 10 / 5 | 15 | 2.52 | 26 | 4.4 | 430 | Brown | Green | Orange |
| NL252018T-180□-N | 18 | 10 / 5 | 15 | 2.52 | 24 | 4.8 | 400 | Brown | Gray | Orange |
| NL252018T-220□-N | 22 | 10 / 5 | 15 | 2.52 | 22 | 5.5 | 400 | Red | Red | Orange |
| NL252018T-270□-N | 27 | 10 / 5 | 15 | 2.52 | 21 | 6.3 | 360 | Red | Violet | Orange |
| NL252018T-330□-N | 33 | 10 / 5 | 15 | 2.52 | 20 | 7.1 | 350 | Orange | Orange | Orange |
| NL252018T-390□-N | 39 | 10 / 5 | 10 | 2.52 | 18 | 9.5 | 330 | Orange | White | Orange |
| NL252018T-470□-N | 47 | 10 / 5 | 10 | 2.52 | 17 | 11.1 | 300 | Yellow | Violet | Orange |
| NL252018T-560□-N | 56 | 10 / 5 | 10 | 2.52 | 16 | 12.1 | 270 | Green | Blue | Orange |
| NL252018T-680□-N | 68 | 10 / 5 | 10 | 2.52 | 15 | 16.6 | 250 | Blue | Gray | Orange |
| NL252018T-820□-N | 82 | 10 / 5 | 10 | 2.52 | 13 | 19 | 200 | Gray | Red | Orange |
| NL252018T-101□-N | 100 | 10 / 5 | 8 | 0.796 | 12 | 21 | 120 | Brown | Black | Yellow |

Note: When ordering, please specify tolerance code. Tolerance : J=±5% , K=±10%

- Operating temperature range - 25°C ~ 105°C(Including self - temperature rise)
- IDC for Inductance drop 10% from its value with current
- Measure Equipment :
L & Q : HP4291A/HP4285A
SRF : HP4291A/HP8753D
RDC : HP4338B or Chroma 16502



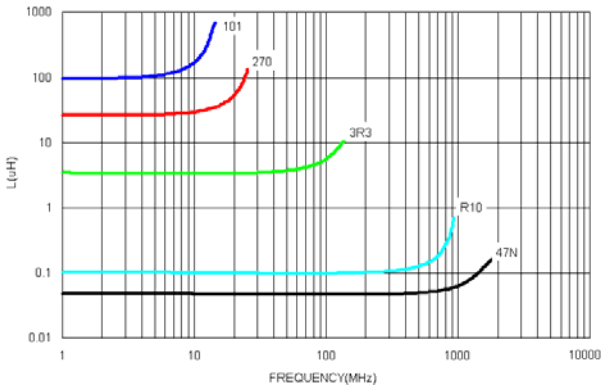
COLOR CODING

Please be sure to request approval specifications that provide further details of the products. Kindly note that the content of these specifications are subject to change or may be discontinued without advance notice. Please contact our sales department before ordering.

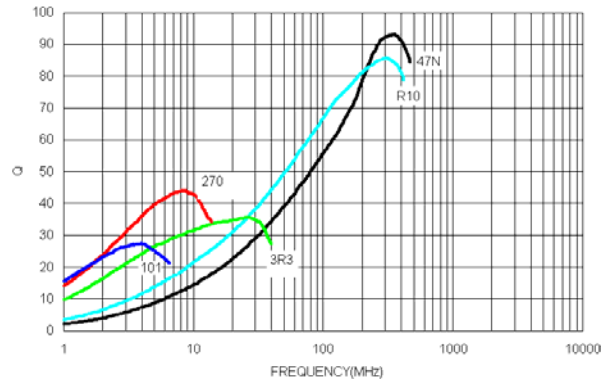
SMD Wire Wound Ferrite Chip Inductors – NL Series

Test Instruments : Agilent E4991A Material/Impedance Analyzer

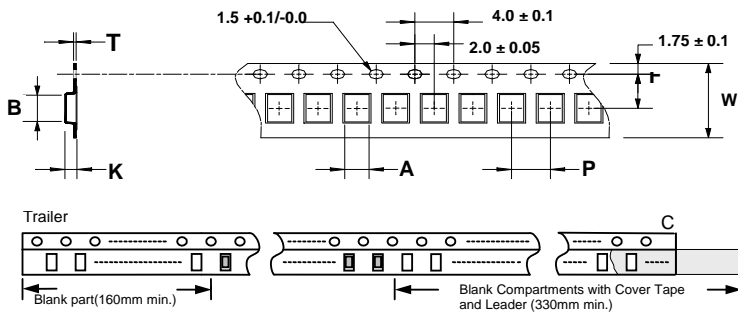
Typical L vs. Frequency



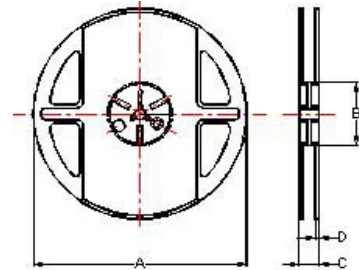
Typical Q vs. Frequency



Tape Dimensions



Reel Dimensions



Dimensions in mm

| TYPE | Tape Dimensions | | | | | | | Reel Dimensions | | | | Quantity PCS / Reel |
|-------------------|-----------------|------|------|---|---|-----|------|-----------------|----|----|-----|------------------------|
| | A | B | T | W | P | F | K | A | B | C | D | |
| NL201614 | 1.85 | 2.45 | 0.23 | 8 | 4 | 3.5 | 1.45 | 178 | 60 | 12 | 1.5 | 2000 |
| NL252018(5N0~R10) | 2.80 | 2.95 | 0.23 | 8 | 4 | 3.5 | 2.20 | 178 | 60 | 12 | 1.5 | 2000 |
| NL252018(R12~101) | 2.40 | 2.93 | 0.26 | 8 | 4 | 3.5 | 2.25 | 178 | 60 | 12 | 1.5 | 2000 |

NLC Series



The characteristics of this series perform low RDC and carry large current. These unique open type inductors offer many superior features in opposition to the molding type one of Japanese peers.

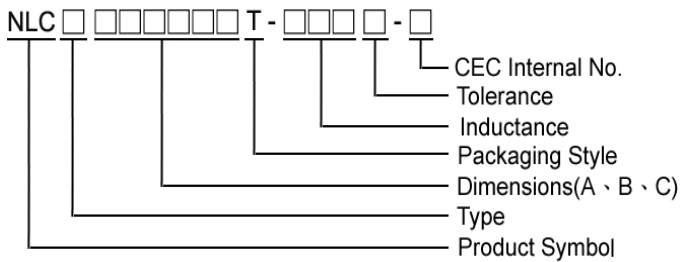
Features

- RoHS compliant
- Very strong solderability by reflow soldering and soldering iron
- Highly accurate dimensions can be mounted automatically
- Terminals are highly resistant to pull forces
- Highly resistant to mechanical shocks and pressure
- Highly reliable in environments of sudden temperature change and humidity
- Superior IDC for DC/DC converter

Applications

- DC/DC converter such as DSC
- LCD TV
- Game console
- Portable VCRs
- Conveyable telephone and others

Product Identification

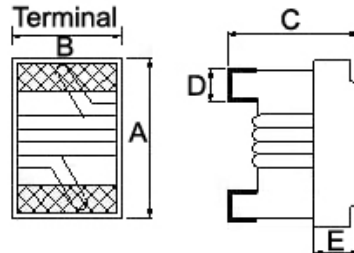
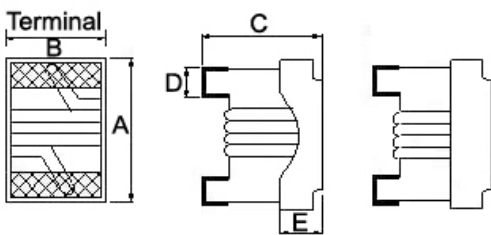


- Packaging: T : Tape and Reel

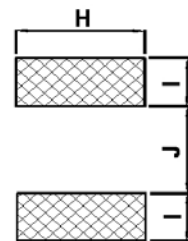
Shape and Dimensions

NLC252018

NLC322522



Recommended Pattern



Dimensions in mm

| TYPE | A Max | B Max | C Max | D | E | H | I | J |
|-----------|-------|-------|-------|------|------|------|------|------|
| NLC252018 | 2.92 | 2.50 | 2.20 | 0.51 | 0.51 | 2.54 | 1.02 | 1.27 |
| NLC322522 | 3.70 | 2.90 | 2.60 | 0.51 | 0.51 | 2.70 | 1.00 | 2.00 |

Electrical Characteristics

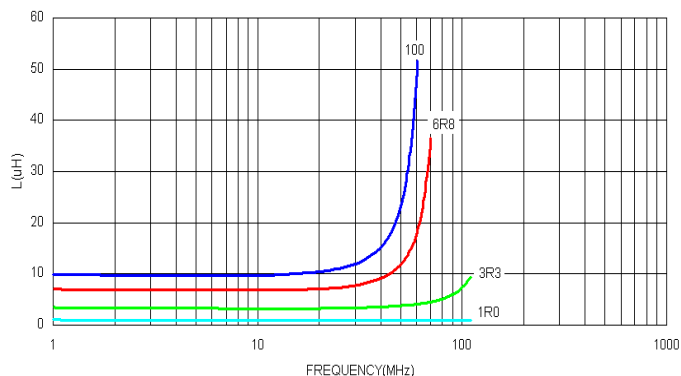
| | | | | | | | | Color Coding | | |
|-------------------|-----|--------|----|------|-----|------|------|-----------------|-----------------|-----------------|
| | | | | | | | | 1 ST | 2 ND | 3 RD |
| NLC252018T-1R0□-N | 1.0 | 10 / 5 | 25 | 7.96 | 300 | 0.34 | 1500 | Brown | Black | Red |
| NLC252018T-1R2□-N | 1.2 | 10 / 5 | 25 | 7.96 | 280 | 0.40 | 1400 | Brown | Red | Red |
| NLC252018T-1R5□-N | 1.5 | 10 / 5 | 25 | 7.96 | 270 | 0.42 | 1400 | Brown | Green | Red |
| NLC252018T-1R8□-N | 1.8 | 10 / 5 | 25 | 7.96 | 150 | 0.45 | 1200 | Brown | Gray | Red |
| NLC252018T-2R2□-N | 2.2 | 10 / 5 | 25 | 7.96 | 140 | 0.50 | 1200 | Red | Red | Red |
| NLC252018T-3R3□-N | 3.3 | 10 / 5 | 25 | 7.96 | 95 | 0.65 | 1000 | Orange | Orange | Red |
| NLC252018T-4R7□-N | 4.7 | 10 / 5 | 25 | 7.96 | 90 | 0.80 | 800 | Yellow | Violet | Red |
| NLC252018T-6R8□-N | 6.8 | 10 / 5 | 25 | 7.96 | 68 | 1.00 | 730 | Blue | Gray | Red |
| NLC252018T-100□-N | 10 | 10 / 5 | 20 | 2.52 | 45 | 1.50 | 700 | Brown | Black | Orange |
| NLC252018T-150□-N | 15 | 10 / 5 | 20 | 2.52 | 40 | 2.20 | 500 | Brown | Green | Orange |
| NLC252018T-220□-N | 22 | 10 / 5 | 20 | 2.52 | 25 | 2.70 | 470 | Red | Red | Orange |
| NLC252018T-330□-N | 33 | 10 / 5 | 20 | 2.52 | 25 | 4.00 | 400 | Orange | Orange | Orange |
| NLC252018T-390□-N | 39 | 10 / 5 | 16 | 2.52 | 20 | 7.00 | 320 | Orange | White | Orange |
| NLC252018T-470□-N | 47 | 10 / 5 | 16 | 2.52 | 20 | 8.00 | 300 | Yellow | Violet | Orange |

Note: When ordering, please specify tolerance code. Tolerance : J=±5% , K=±10%

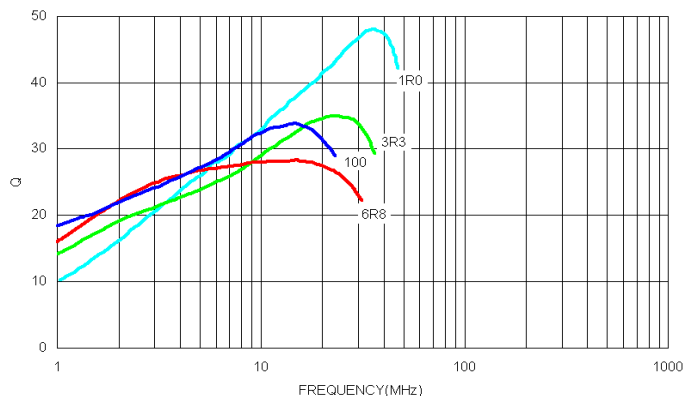
- Operating temperature range - 25°C ~ 105°C(Including self - temperature rise)
- IDC for Inductance drop 10% from its value with current
- Measure Equipment :
 L & Q : Agilent HP4291A/Agilent HP4285A+Agilent HP16197A
 SRF : Agilent HP4291A
 RDC : HP4338B or Chroma 16502

Test Instruments : Agilent HP4291A Material/Impedance Analyzer

Typical L vs. Frequency



Typical Q vs. Frequency



Please be sure to request approval specifications that provide further details of the products. Kindly note that the content of these specifications are subject to change or may be discontinued without advance notice. Please contact our sales department before ordering.

Electrical Characteristics

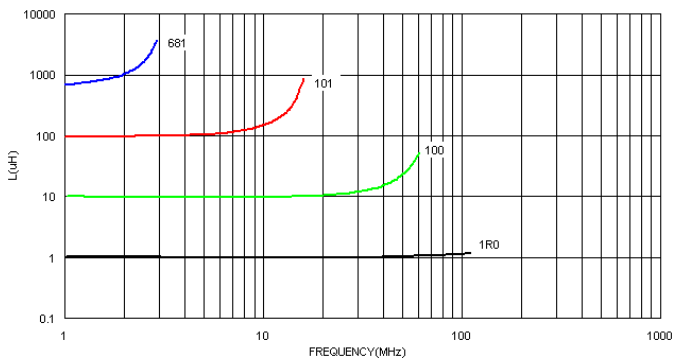
| Part Number | Inductance (uH) | Tolerance (±%) | Q Min | Test Frequency (MHz) | SRF (MHz) Typ. | RDC (Ω)±30% | IDC (mA) | Color Coding | | |
|-------------------|--------------------|-------------------|----------|-------------------------|-------------------|----------------|-------------|-----------------|-----------------|-----------------|
| | | | | | | | | 1 ST | 2 ND | 3 RD |
| NLC322522T-R47□-N | 0.47 | 5 / 10 | 40 | 25.2 | 450 | 0.07 | 1800 | Yellow | Violet | Brown |
| NLC322522T-1R0□-N | 1.0 | 5 / 10 | 20 | 7.96 | 100 | 0.08 | 1500 | Brown | Black | Red |
| NLC322522T-1R2□-N | 1.2 | 5 / 10 | 20 | 7.96 | 90 | 0.12 | 1400 | Brown | Red | Red |
| NLC322522T-1R5□-N | 1.5 | 5 / 10 | 20 | 7.96 | 80 | 0.13 | 1125 | Brown | Green | Red |
| NLC322522T-1R8□-N | 1.8 | 5 / 10 | 20 | 7.96 | 70 | 0.13 | 970 | Brown | Gray | Red |
| NLC322522T-2R2□-N | 2.2 | 5 / 10 | 20 | 7.96 | 68 | 0.13 | 970 | Red | Red | Red |
| NLC322522T-2R7□-N | 2.7 | 5 / 10 | 20 | 7.96 | 62 | 0.15 | 900 | Red | Violet | Red |
| NLC322522T-3R3□-N | 3.3 | 5 / 10 | 20 | 7.96 | 54 | 0.16 | 837 | Orange | Orange | Red |
| NLC322522T-4R7□-N | 4.7 | 5 / 10 | 20 | 7.96 | 43 | 0.23 | 675 | Yellow | Violet | Red |
| NLC322522T-5R6□-N | 5.6 | 5 / 10 | 20 | 7.96 | 36 | 0.26 | 620 | Green | Blue | Red |
| NLC322522T-6R8□-N | 6.8 | 5 / 10 | 20 | 7.96 | 33 | 0.27 | 600 | Blue | Gray | Red |
| NLC322522T-8R2□-N | 8.2 | 5 / 10 | 20 | 7.96 | 30 | 0.32 | 580 | Gray | Red | Red |
| NLC322522T-100□-N | 10 | 5 / 10 | 15 | 2.52 | 28 | 0.36 | 520 | Brown | Black | Orange |
| NLC322522T-120□-N | 12 | 5 / 10 | 15 | 2.52 | 25 | 0.50 | 500 | Brown | Red | Orange |
| NLC322522T-150□-N | 15 | 5 / 10 | 15 | 2.52 | 19 | 0.56 | 480 | Brown | Green | Orange |
| NLC322522T-180□-N | 18 | 5 / 10 | 15 | 2.52 | 17 | 0.67 | 330 | Brown | Gray | Orange |
| NLC322522T-220□-N | 22 | 5 / 10 | 15 | 2.52 | 16 | 0.77 | 310 | Red | Red | Orange |
| NLC322522T-270□-N | 27 | 5 / 10 | 15 | 2.52 | 13 | 1.00 | 280 | Red | Violet | Orange |
| NLC322522T-330□-N | 33 | 5 / 10 | 15 | 2.52 | 12 | 1.10 | 270 | Orange | Orange | Orange |
| NLC322522T-390□-N | 39 | 5 / 10 | 15 | 2.52 | 11 | 1.40 | 220 | Orange | White | Orange |
| NLC322522T-470□-N | 47 | 5 / 10 | 15 | 2.52 | 10 | 1.64 | 210 | Yellow | Violet | Orange |
| NLC322522T-560□-N | 56 | 5 / 10 | 15 | 2.52 | 9 | 2.49 | 189 | Green | Blue | Orange |
| NLC322522T-680□-N | 68 | 5 / 10 | 15 | 2.52 | 9 | 2.80 | 189 | Blue | Gray | Orange |
| NLC322522T-820□-N | 82 | 5 / 10 | 15 | 2.52 | 6 | 3.00 | 145 | Gray | Red | Orange |
| NLC322522T-101□-N | 100 | 5 / 10 | 15 | 0.796 | 6 | 3.70 | 145 | Brown | Black | Yellow |
| NLC322522T-151□-N | 150 | 5 / 10 | 15 | 0.796 | 5 | 6.10 | 120 | Brown | Green | Yellow |
| NLC322522T-181□-N | 180 | 5 / 10 | 15 | 0.796 | 4 | 8.00 | 105 | Brown | Gray | Yellow |
| NLC322522T-221□-N | 220 | 5 / 10 | 15 | 0.796 | 4 | 8.40 | 100 | Red | Red | Yellow |
| NLC322522T-331□-N | 330 | 5 / 10 | 15 | 0.796 | 3.5 | 12.3 | 80 | Orange | Orange | Yellow |
| NLC322522T-391□-N | 390 | 5 / 10 | 15 | 0.796 | 2.8 | 17.6 | 75 | Orange | White | Yellow |
| NLC322522T-471□-N | 470 | 5 / 10 | 15 | 0.796 | 2.8 | 22.0 | 75 | Yellow | Violet | Yellow |
| NLC322522T-561□-N | 560 | 5 / 10 | 15 | 0.796 | 2.5 | 23.0 | 65 | Green | Blue | Yellow |
| NLC322522T-681□-N | 680 | 5 / 10 | 15 | 0.796 | 2 | 28.0 | 65 | Blue | Gray | Yellow |

Note: When ordering, please specify tolerance code. Tolerance : J=±5% , K=±10%

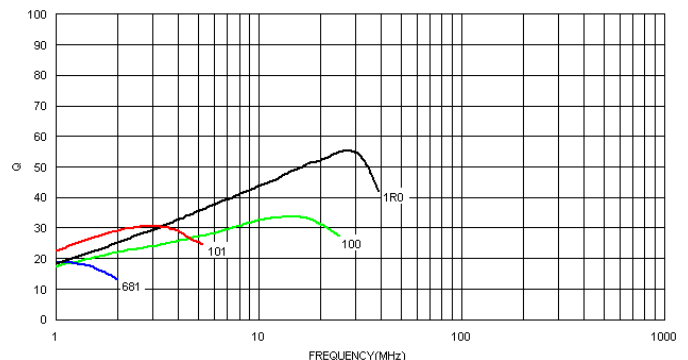
- Operating temperature range - 25°C ~ 105°C(Including self - temperature rise)
- IDC for Inductance drop 10% from its value with current
- Measure Equipment :
L & Q : Agilent HP4291A(over 1MHz)/Agilent HP4285A+Agilent HP16197A (under 1MHz)
SRF : Agilent HP4291A
RDC : HP4338B or Chroma 16502

Test Instruments : Agilent HP4291A Material/Impedance Analyzer

Typical L vs. Frequency

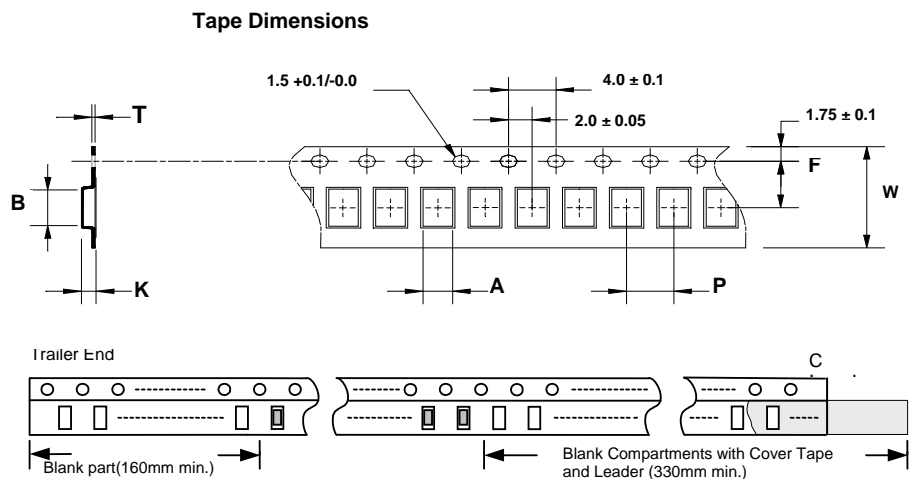


Typical Q vs. Frequency

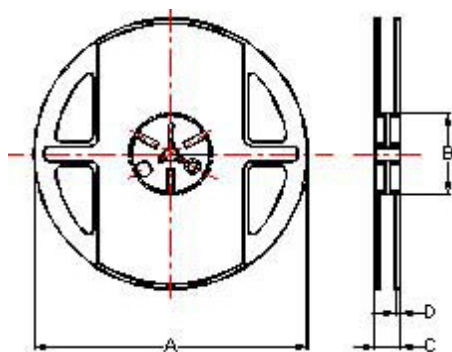


Please be sure to request approval specifications that provide further details of the products. Kindly note that the content of these specifications are subject to change or may be discontinued without advance notice. Please contact our sales department before ordering.

Packaging Specifications



Reel Dimensions



Dimensions in mm

| TYPE | Tape Dimensions | | | | | | | Reel Dimensions | | | | Quantity PCS / Reel |
|-----------|-----------------|------|------|----|---|-----|------|-----------------|----|----|-----|------------------------|
| | A | B | T | W | P | F | K | A | B | C | D | |
| NLC252018 | 2.40 | 2.93 | 0.26 | 8 | 4 | 3.5 | 2.25 | 178 | 60 | 12 | 1.5 | 2000 |
| NLC322522 | 2.85 | 3.58 | 0.25 | 12 | 4 | 5.5 | 2.55 | 178 | 60 | 16 | 1.4 | 2000 |

LD Series



LD series is the newest open type ferrite wire wound chip inductors. The wire wound ferrite construction supports lower DCR than other open type inductors.

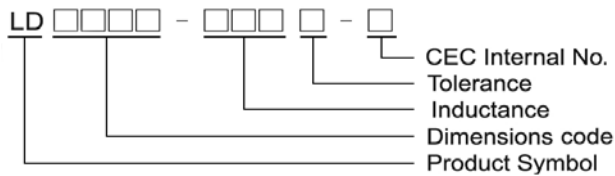
Features

- RoHS compliant
- SMD type wire-wound chip inductor with low DC resistance
- Wide inductance range (0.9uH~100uH)

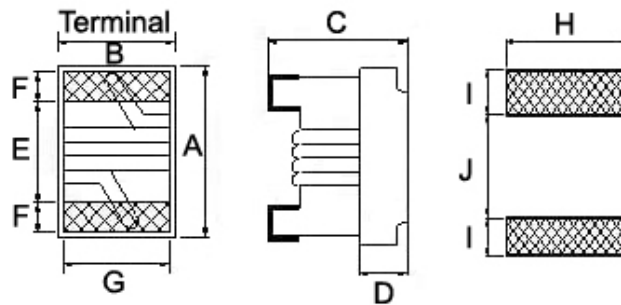
Applications

- DSC, DVC, MD, PDA
- Portable digital devices

Product Identification



Shape and Dimensions / Recommended Pattern



Dimensions in mm

| TYPE | A Max | B Max | C Max | D | E | F | G | H | I | J |
|--------|-------|-------|-------|------|------|------|------|------|------|------|
| LD0805 | 2.4 | 1.72 | 1.52 | 0.70 | 1.00 | 0.50 | 1.27 | 1.78 | 1.02 | 0.76 |
| LD1008 | 2.99 | 2.50 | 2.20 | 0.70 | 1.52 | 0.51 | 2.03 | 2.54 | 1.02 | 1.27 |

Electrical Characteristics

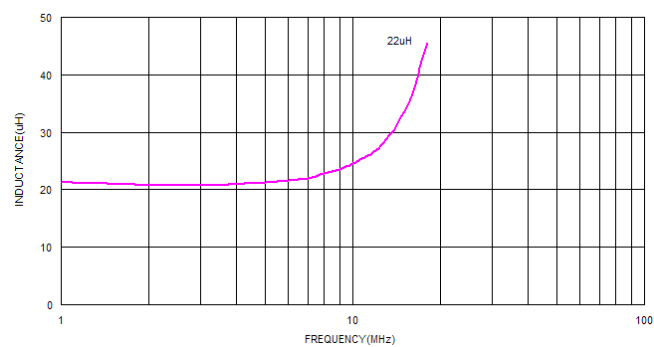
| Part Number | Inductance (uH) | Tolerance (±%) | Test Frequency (MHz) | Q Typ. | SRF (MHz) Min | RDC (Ω±30%) | IDC (mA) Max | Color |
|---------------|-----------------|----------------|----------------------|--------|---------------|-------------|--------------|--------|
| LD0805-1R0□-N | 1.0 | 10 / 20 | 7.96 | 18 | 100 | 0.10 | 800 | Black |
| LD0805-1R5□-N | 1.5 | 10 / 20 | 7.96 | 18 | 90 | 0.18 | 650 | Brown |
| LD0805-2R2□-N | 2.2 | 10 / 20 | 7.96 | 18 | 70 | 0.24 | 550 | Red |
| LD0805-3R3□-N | 3.3 | 10 / 20 | 7.96 | 18 | 55 | 0.30 | 450 | Orange |
| LD0805-4R7□-N | 4.7 | 10 / 20 | 7.96 | 18 | 50 | 0.47 | 360 | Yellow |
| LD0805-6R8□-N | 6.8 | 10 / 20 | 7.96 | 24 | 60 | 0.75 | 290 | Green |
| LD0805-100□-N | 10 | 10 / 20 | 2.52 | 18 | 25 | 0.90 | 290 | Blue |
| LD0805-150□-N | 15 | 10 / 20 | 2.52 | 18 | 25 | 1.60 | 230 | Violet |
| LD0805-220□-N | 22 | 10 / 20 | 2.52 | 18 | 17 | 1.95 | 190 | Gray |
| LD0805-330□-N | 33 | 10 / 20 | 2.52 | 17 | 15 | 2.60 | 120 | White |
| LD0805-470□-N | 47 | 10 / 20 | 2.52 | 17 | 11 | 3.90 | 95 | Black |
| LD0805-680□-N | 68 | 10 / 20 | 2.52 | 17 | 11 | 5.50 | 95 | Brown |
| LD0805-101□-N | 100 | 10 / 20 | 1.00 | 12 | 9 | 9.00 | 70 | Red |

Note: When ordering, please specify tolerance code. Tolerance: K=±10% , M=±20%

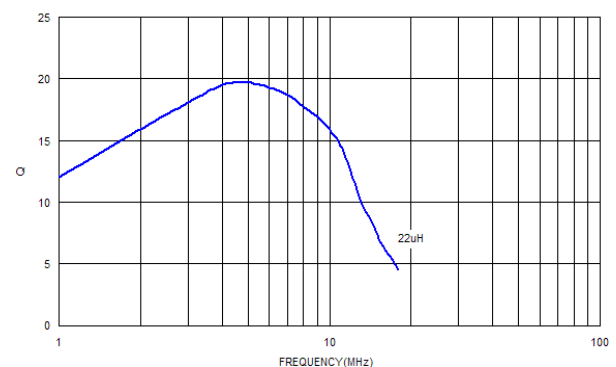
- Operating temperature range - 25°C ~ 105°C(Including self - temperature rise)
- IDC for Inductance drop 10% from its value with current
- Measure Equipment :
 L & Q : Agilent E4991A+Agilent HP16197A(over 1MHz)/Agilent HP4285A(under 1MHz)
 SRF : HP8753D/Agilent E4991A
 RDC : Chroma 16502
 IDC : HP4284A+HP42841A/HP4285A+HP42841A

Test Instruments : Agilent E4991A Material/Impedance Analyzer

Typical L vs. Frequency



Typical Q vs. Frequency



Please be sure to request approval specifications that provide further details of the products. Kindly note that the content of these specifications are subject to change or may be discontinued without advance notice. Please contact our sales department before ordering.

Electrical Characteristics

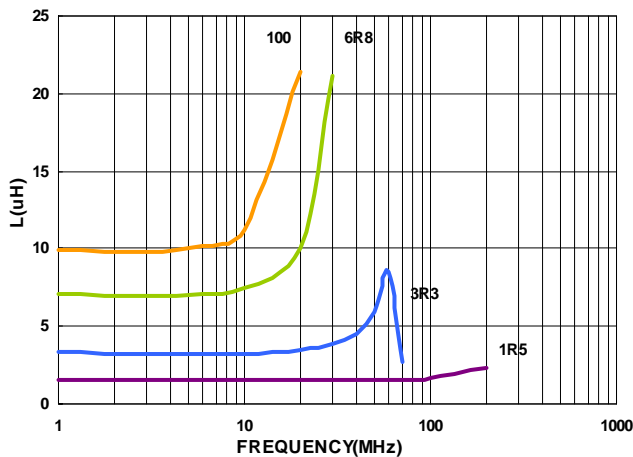
| Part Number | Inductance (uH) | Tolerance (±%) | Test Frequency (MHz) | Q Typ. | SRF (MHz) Min | RDC (Ω) Max | IDC (mA) Typ. | Irms (mA) Max | Color | | |
|---------------|-----------------|----------------|----------------------|--------|---------------|-------------|---------------|---------------|-----------------|-----------------|-----------------|
| | | | | | | | | | 1 ST | 2 ND | 3 RD |
| LD1008-R90□-N | 0.9 | 10 | 2.5 | 25 | 300 | 0.1 | 1400 | 1300 | White | Black | Brown |
| LD1008-1R1□-N | 1.1 | 10 | 2.5 | 24 | 275 | 0.105 | 1300 | 1200 | Brown | Brown | Red |
| LD1008-1R3□-N | 1.3 | 5 / 10 | 2.5 | 24 | 220 | 0.11 | 1200 | 1100 | Brown | Orange | Red |
| LD1008-1R5□-N | 1.5 | 5 / 10 | 2.5 | 22 | 210 | 0.125 | 1100 | 1000 | Brown | Yellow | Red |
| LD1008-1R9□-N | 1.9 | 5 / 10 | 2.5 | 22 | 165 | 0.14 | 1000 | 1000 | Brown | White | Red |
| LD1008-2R2□-N | 2.2 | 5 / 10 | 2.5 | 21 | 75 | 0.155 | 950 | 950 | Red | Red | Red |
| LD1008-2R7□-N | 2.7 | 5 / 10 | 2.5 | 22 | 57 | 0.19 | 800 | 900 | Red | Violet | Red |
| LD1008-3R3□-N | 3.3 | 5 / 10 | 2.5 | 21 | 54 | 0.21 | 750 | 800 | Orange | Orange | Red |
| LD1008-3R9□-N | 3.9 | 5 / 10 | 2.5 | 21 | 50 | 0.22 | 700 | 800 | Orange | White | Red |
| LD1008-4R7□-N | 4.7 | 5 / 10 | 2.5 | 27 | 48 | 0.435 | 700 | 650 | Yellow | Violet | Red |
| LD1008-5R8□-N | 5.8 | 5 / 10 | 2.5 | 21 | 33 | 0.28 | 550 | 750 | Green | Gray | Red |
| LD1008-6R8□-N | 6.8 | 5 / 10 | 2.5 | 20 | 28 | 0.315 | 500 | 700 | Blue | Gray | Red |
| LD1008-8R2□-N | 8.2 | 5 / 10 | 2.5 | 20 | 24 | 0.395 | 500 | 650 | Gray | Red | Red |
| LD1008-100□-N | 10 | 5 / 10 | 2.5 | 22 | 20 | 0.48 | 450 | 550 | Brown | Black | Orange |

Note: When ordering, please specify tolerance code. Tolerance: J=±5% , K=±10%

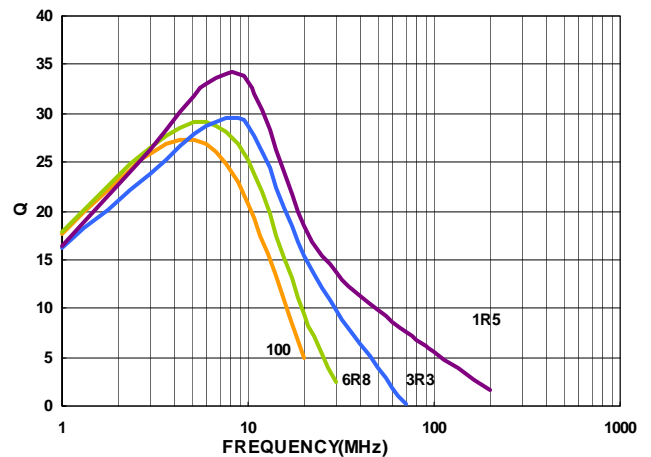
- Operating temperature range - 25°C ~ 105°C(Including self - temperature rise)
- IDC for Inductance drop 10% from its value with current
- Irms for a 40°C temperature rise from 25°C ambient with current
- Measure Equipment :
 - L : Agilent E4991A/HP4287A+16197A
 - SRF : HP8753D/Agilent E4991A
 - RDC : Chroma 16502
 - IDC : HP4284A+HP42841A/HP4285A+HP42841A

Test Instruments : Agilent E4991A Material/Impedance Analyzer

Typical L vs. Frequency

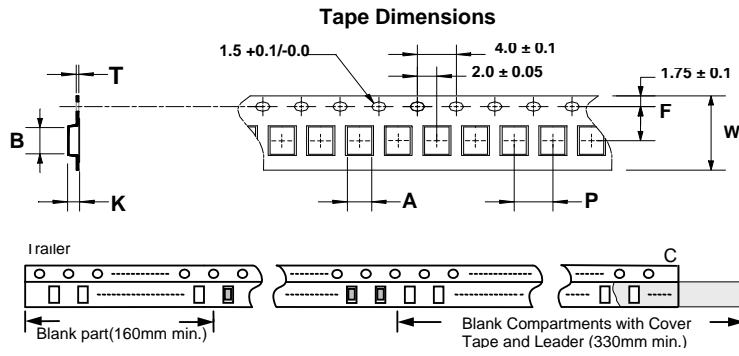


Typical Q vs. Frequency

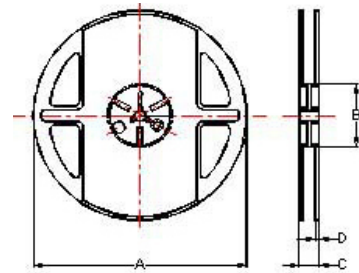


Please be sure to request approval specifications that provide further details of the products. Kindly note that the content of these specifications are subject to change or may be discontinued without advance notice. Please contact our sales department before ordering.

Packaging Specifications



Reel Dimensions



Dimensions in mm

| TYPE | Tape Dimensions | | | | | | | Reel Dimensions | | | | Quantity |
|---------|-----------------|------|------|---|---|-----|------|-----------------|----|----|-----|------------|
| | A | B | T | W | P | F | K | A | B | C | D | PCS / REEL |
| LD 0805 | 1.60 | 2.42 | 0.22 | 8 | 4 | 3.5 | 1.45 | 178 | 60 | 12 | 1.5 | 2000 |
| LD 1008 | 2.40 | 2.93 | 0.26 | 8 | 4 | 3.5 | 2.25 | 178 | 60 | 12 | 1.5 | 2000 |

LS Series



LS Series is the newest in open type ferrite wire wound chip inductors. The wire wound ferrite construction supports higher SRF, lower DCR and superior Q values than other ferrite chip inductors.

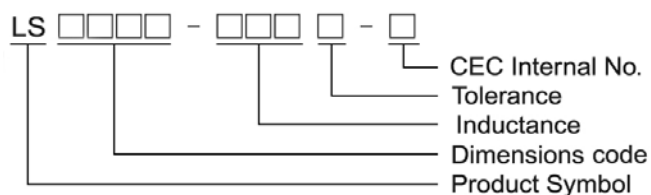
Features

- RoHS compliant
- Very strong solderability by reflow soldering and soldering iron
- Highly accurate dimensions
- Can be mounted automatically
- Terminals are highly resistant to external forces
- Highly resistant to mechanical shocks and pressure
- Highly reliable in environments of sudden temperature change and humidity
- Low DCR & better Q value in ferrite series

Applications

- Telecom and datacom applications such as xDSL
- Cable modem
- Set-top box
- CATV filter/tuner
- Wireless LAN, etc

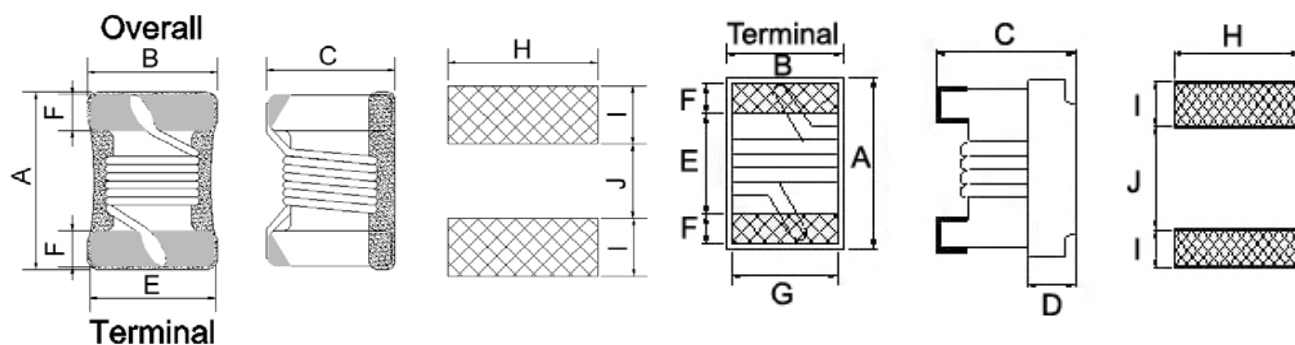
Product Identification



Shape and Dimensions / Recommended Pattern

LS0201

LS0402/0603/0805/1008



Dimensions in mm

| TYPE | A Max | B Max | C Max | D | E | F | G | H | I | J |
|--------|-------------------------------------|----------|-------------------------------------|------|------|------|------|------|------|------|
| LS0201 | 0.58 | 0.46 | 0.45 | - | 0.38 | 0.10 | - | 0.46 | 0.18 | 0.23 |
| LS0402 | 1.02±0.1 | 0.55±0.1 | 0.56±0.1 | 0.25 | 0.54 | 0.23 | 0.50 | 0.65 | 0.38 | 0.44 |
| LS0603 | 1.6 ^{+0.2} _{-0.1} | 1.1±0.1 | 0.9 ^{+0.2} _{-0.1} | 0.38 | 0.86 | 0.33 | 0.76 | 1.02 | 0.64 | 0.64 |
| LS0805 | 2.4 | 1.72 | 1.52 | 0.70 | 1.02 | 0.50 | 1.27 | 1.78 | 1.02 | 0.76 |
| LS1008 | 2.99 | 2.50 | 2.20 | 0.70 | 1.52 | 0.51 | 2.03 | 2.54 | 1.02 | 1.27 |

SMD Wire Wound Ferrite Chip Inductors – LS Series

Electrical Characteristics

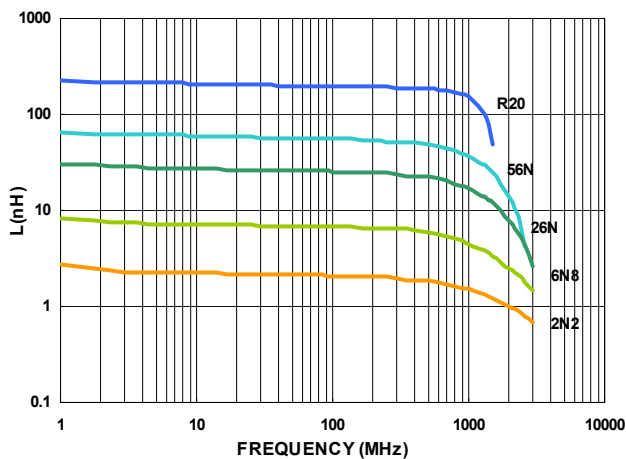
| Part Number | Inductance (nH) | Tolerance (±%) | Test Frequency (MHz) | Q Typ. | SRF (MHz)Typ. | RDC (Ω)Max. | Irms (mA)Typ. |
|---------------|-----------------|----------------|----------------------|--------|---------------|-------------|---------------|
| LS0201-2N2□-N | 2.2 | 10 | 100 | 5 | 3000 | 0.09 | 1600 |
| LS0201-6N8□-N | 6.8 | 10 / 5 | 100 | 6 | 2400 | 0.11 | 950 |
| LS0201-7N8□-N | 7.8 | 10 / 5 | 100 | 7 | 2500 | 0.11 | 1050 |
| LS0201-15N□-N | 15 | 10 / 5 | 100 | 7 | 2300 | 0.12 | 750 |
| LS0201-17N□-N | 17 | 10 / 5 | 100 | 7 | 2400 | 0.13 | 750 |
| LS0201-26N□-N | 26 | 10 / 5 | 100 | 7 | 2200 | 0.20 | 750 |
| LS0201-28N□-N | 28 | 10 / 5 | 100 | 7 | 2400 | 0.2 | 700 |
| LS0201-39N□-N | 39 | 10 / 5 | 100 | 7 | 2300 | 0.24 | 580 |
| LS0201-43N□-N | 43 | 10 / 5 | 100 | 7 | 2200 | 0.24 | 600 |
| LS0201-56N□-N | 56 | 10 / 5 | 100 | 7 | 2200 | 0.26 | 550 |
| LS0201-59N□-N | 59 | 10 / 5 | 100 | 7 | 2200 | 0.26 | 500 |
| LS0201-76N□-N | 76 | 10 / 5 | 100 | 7 | 2000 | 0.30 | 500 |
| LS0201-78N□-N | 78 | 10 / 5 | 100 | 7 | 2000 | 0.30 | 500 |
| LS0201-R10□-N | 100 | 10 / 5 | 100 | 7 | 1500 | 0.41 | 430 |
| LS0201-R13□-N | 130 | 10 / 5 | 100 | 7 | 1500 | 0.44 | 400 |
| LS0201-R16□-N | 160 | 10 / 5 | 100 | 7 | 1400 | 0.71 | 350 |
| LS0201-R20□-N | 200 | 10 / 5 | 50 | 9 | 1400 | 0.95 | 260 |

Note: When ordering, please specify tolerance code. Tolerance : J=±5% , K=±10%

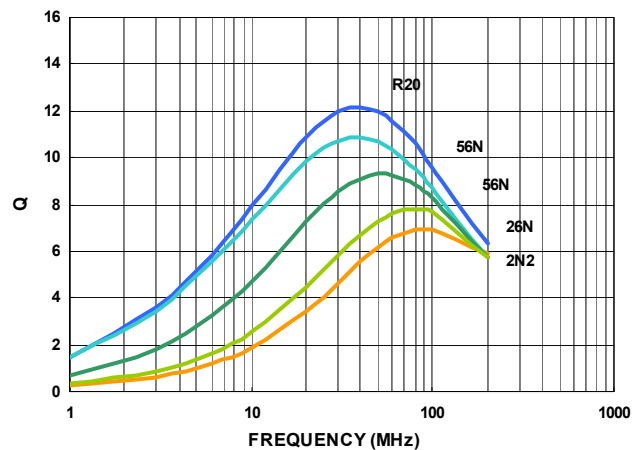
- Operating temperature range - 25°C ~ 105°C(Including self - temperature rise)
- I rms for a 15°C temperature rise from 25°C ambient with current
- Measure Equipment :
 L & Q : Agilent E4991A+Agilent HP16197A
 SRF : Agilent E4991A
 RDC : Chroma 16502
 I rms : HP4284A+HP42841A

Test Instruments : Agilent E4991A Material/Impedance Analyzer

Typical L vs. Frequency



Typical Q vs. Frequency



Please be sure to request approval specifications that provide further details of the products. Kindly note that the content of these specifications are subject to change or may be discontinued without advance notice. Please contact our sales department before ordering.

SMD Wire Wound Ferrite Chip Inductors – LS Series

Electrical Characteristics

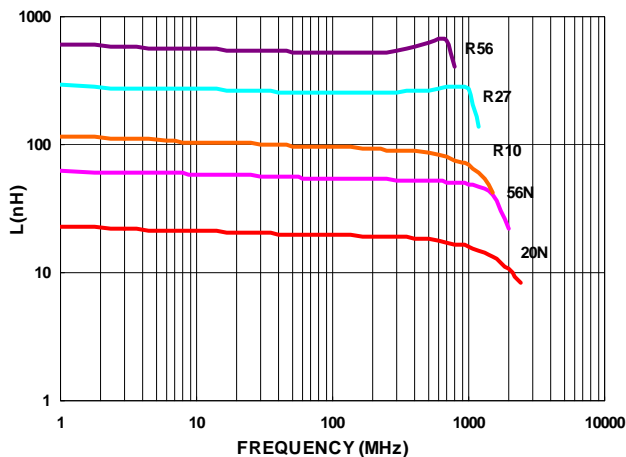
| Part Number | Inductance (uH) | Tolerance (±%) | Test Frequency (MHz) | Q Typ. | SRF (MHz)Typ. | RDC (Ω) Max | I _{rms} (mA)Typ. |
|---------------|-----------------|----------------|----------------------|--------|---------------|-------------|---------------------------|
| LS0402-18N□-N | 0.018 | 10 / 5 | 100 | 10 | 2600 | 0.055 | 1600 |
| LS0402-20N□-N | 0.020 | 10 / 5 | 100 | 10 | 2600 | 0.050 | 1600 |
| LS0402-22N□-N | 0.022 | 10 | 100 | 10 | 2500 | 0.072 | 1300 |
| LS0402-33N□-N | 0.033 | 10 / 5 | 100 | 10 | 2300 | 0.060 | 1400 |
| LS0402-36N□-N | 0.036 | 10 / 5 | 100 | 10 | 2300 | 0.092 | 1000 |
| LS0402-39N□-N | 0.039 | 10 / 5 | 100 | 10 | 2200 | 0.150 | 830 |
| LS0402-51N□-N | 0.051 | 10 | 100 | 10 | 1930 | 0.070 | 1100 |
| LS0402-56N□-N | 0.056 | 10 | 100 | 10 | 1900 | 0.125 | 900 |
| LS0402-72N□-N | 0.072 | 10 / 5 | 100 | 10 | 1650 | 0.100 | 900 |
| LS0402-78N□-N | 0.078 | 10 / 5 | 100 | 10 | 1600 | 0.190 | 850 |
| LS0402-R10□-N | 0.10 | 10 | 100 | 9 | 1400 | 0.160 | 900 |
| LS0402-R14□-N | 0.14 | 10 / 5 | 50 | 11 | 1220 | 0.260 | 540 |
| LS0402-R18□-N | 0.18 | 10 | 50 | 11 | 1150 | 0.330 | 560 |
| LS0402-R20□-N | 0.20 | 10 / 5 | 50 | 11 | 1000 | 0.440 | 400 |
| LS0402-R22□-N | 0.22 | 10 / 5 | 50 | 11 | 1150 | 0.530 | 380 |
| LS0402-R25□-N | 0.25 | 10 / 5 | 25 | 11 | 900 | 0.360 | 520 |
| LS0402-R27□-N | 0.27 | 10 | 25 | 11 | 860 | 0.550 | 360 |
| LS0402-R30□-N | 0.30 | 10 / 5 | 25 | 11 | 860 | 0.410 | 420 |
| LS0402-R33□-N | 0.33 | 10 / 5 | 7.9 | 11 | 820 | 0.680 | 350 |
| LS0402-R36□-N | 0.36 | 10 / 5 | 7.9 | 11 | 810 | 0.575 | 360 |
| LS0402-R39□-N | 0.39 | 10 / 5 | 7.9 | 11 | 760 | 0.890 | 300 |
| LS0402-R42□-N | 0.42 | 10 / 5 | 7.9 | 11 | 700 | 1.100 | 340 |
| LS0402-R47□-N | 0.47 | 10 | 7.9 | 11 | 650 | 0.730 | 310 |
| LS0402-R56□-N | 0.56 | 10 / 5 | 7.9 | 11 | 600 | 1.100 | 200 |

Note: When ordering, please specify tolerance code. Tolerance : J=±5% , K=±10%

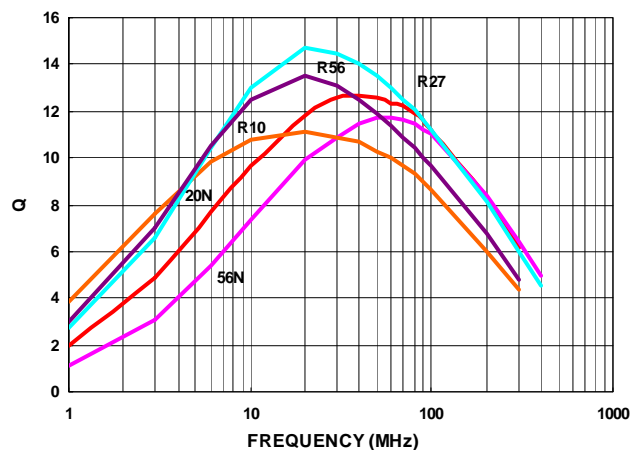
- Operating temperature range - 25°C ~ 105°C(Including self - temperature rise)
- I_{rms} for a 15°C temperature rise from 25°C ambient with current
- Measure Equipment :
 L & Q : Agilent E4991A+Agilent HP16197A
 SRF : Agilent E4991A
 RDC : Chroma 16502
 I_{rms} : HP4284A+HP42841A

Test Instruments : Agilent E4991A Material/Impedance Analyzer

Typical L vs. Frequency



Typical Q vs. Frequency



Please be sure to request approval specifications that provide further details of the products. Kindly note that the content of these specifications are subject to change or may be discontinued without advance notice. Please contact our sales department before ordering.

SMD Wire Wound Ferrite Chip Inductors – LS Series

Electrical Characteristics

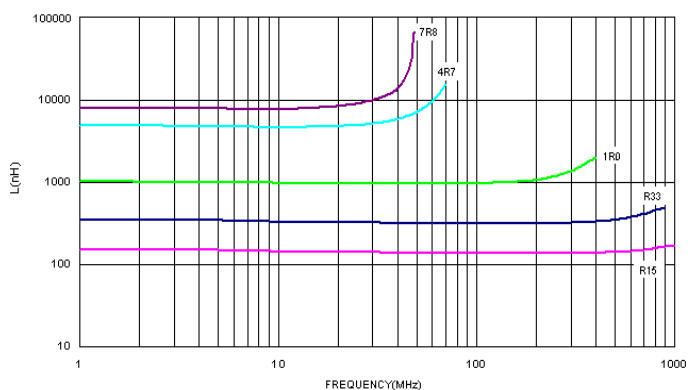
| Part Number | Inductance (uH) | Tolerance (±%) | Test Frequency (MHz) | Q Typ. | SRF (MHz) Min | RDC (Ω) Max | IDC (mA) | Color |
|---------------|-----------------|----------------|----------------------|--------|---------------|-------------|----------|--------|
| LS0603-47N□-N | 0.047 | 10 / 5 | 7.9 | 17 | 1700 | 0.075 | 1500 | Black |
| LS0603-72N□-N | 0.072 | 10 / 5 | 7.9 | 17 | 1700 | 0.12 | 1500 | Brown |
| LS0603-R10□-N | 0.10 | 10 / 5 | 7.9 | 17 | 1650 | 0.13 | 1500 | Red |
| LS0603-R12□-N | 0.12 | 10 / 5 | 7.9 | 17 | 1350 | 0.15 | 1500 | Orange |
| LS0603-R15□-N | 0.15 | 10 / 5 | 7.9 | 17 | 1350 | 0.15 | 1450 | Yellow |
| LS0603-R18□-N | 0.18 | 10 / 5 | 7.9 | 17 | 1150 | 0.15 | 1400 | Green |
| LS0603-R22□-N | 0.22 | 10 / 5 | 7.9 | 17 | 1050 | 0.16 | 1350 | Blue |
| LS0603-R24□-N | 0.24 | 10 / 5 | 7.9 | 17 | 1050 | 0.19 | 1300 | Violet |
| LS0603-R27□-N | 0.27 | 10 / 5 | 7.9 | 17 | 1050 | 0.30 | 1050 | Gray |
| LS0603-R33□-N | 0.33 | 10 / 5 | 7.9 | 17 | 850 | 0.46 | 1200 | White |
| LS0603-R39□-N | 0.39 | 10 / 5 | 7.9 | 17 | 810 | 0.51 | 1200 | Black |
| LS0603-R47□-N | 0.47 | 10 / 5 | 7.9 | 17 | 720 | 0.62 | 1050 | Brown |
| LS0603-R56□-N | 0.56 | 10 / 5 | 7.9 | 17 | 600 | 0.44 | 850 | Red |
| LS0603-R68□-N | 0.68 | 10 / 5 | 7.9 | 17 | 600 | 0.52 | 850 | Orange |
| LS0603-R78□-N | 0.78 | 10 / 5 | 7.9 | 17 | 460 | 0.83 | 850 | Yellow |
| LS0603-R82□-N | 0.82 | 10 / 5 | 7.9 | 17 | 480 | 0.69 | 750 | Green |
| LS0603-R91□-N | 0.91 | 10 / 5 | 7.9 | 17 | 330 | 0.76 | 670 | Black |
| LS0603-1R0□-N | 1.0 | 10 / 5 | 7.9 | 18 | 310 | 0.81 | 600 | Blue |
| LS0603-1R2□-N | 1.2 | 10 / 5 | 7.9 | 17 | 270 | 0.87 | 550 | Violet |
| LS0603-1R5□-N | 1.5 | 10 / 5 | 7.9 | 17 | 270 | 1.06 | 540 | Gray |
| LS0603-1R8□-N | 1.8 | 10 / 5 | 7.9 | 17 | 230 | 1.10 | 520 | White |
| LS0603-2R2□-N | 2.2 | 10 / 5 | 7.9 | 17 | 140 | 1.20 | 500 | Black |
| LS0603-2R7□-N | 2.7 | 10 / 5 | 7.9 | 17 | 105 | 1.50 | 480 | Brown |
| LS0603-3R3□-N | 3.3 | 10 / 5 | 7.9 | 17 | 84 | 1.50 | 440 | Red |
| LS0603-3R9□-N | 3.9 | 10 / 5 | 7.9 | 17 | 80 | 1.60 | 430 | Orange |
| LS0603-4R7□-N | 4.7 | 10 / 5 | 7.9 | 18 | 69 | 2.10 | 420 | Yellow |
| LS0603-5R6□-N | 5.6 | 10 / 5 | 7.9 | 18 | 65 | 2.60 | 400 | Green |
| LS0603-6R8□-N | 6.8 | 10 / 5 | 7.9 | 19 | 55 | 3.10 | 400 | Blue |
| LS0603-7R8□-N | 7.8 | 10 / 5 | 7.9 | 17 | 47 | 3.50 | 400 | Violet |
| LS0603-8R2□-N | 8.2 | 10 / 5 | 7.9 | 17 | 42 | 3.80 | 400 | Gray |
| LS0603-100□-N | 10 | 10 / 5 | 7.9 | 19 | 40 | 4.80 | 300 | White |

Note: When ordering, please specify tolerance code. Tolerance : J=±5% , K=±10%

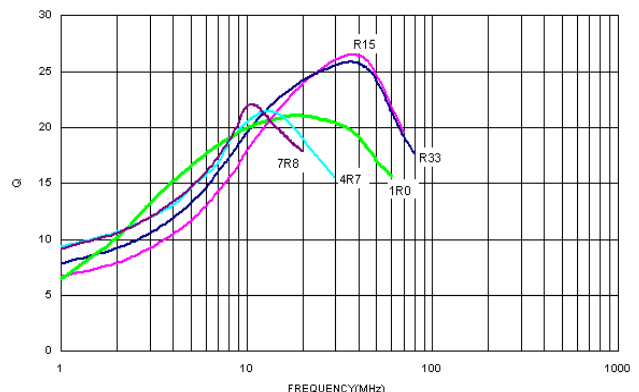
- Operating temperature range - 25°C ~ 105°C(Including self - temperature rise)
- IDC for Inductance drop 10% from its value without current
- Measure Equipment :
 L & Q : Agilent E4991A+Agilent HP16197A
 SRF : Agilent HP8753D/Agilent E4991A
 RDC : Chroma 16502
 IDC : HP4284A+HP42841A/HP4285A+HP42841A

Test Instruments : Agilent E4991A Material/Impedance Analyzer

Typical **L** vs. **Frequency**



Typical **Q** vs. **Frequency**



Please be sure to request approval specifications that provide further details of the products. Kindly note that the content of these specifications are subject to change or may be discontinued without advance notice. Please contact our sales department before ordering.

Electrical Characteristics

| Part Number | Inductance (uH) | Tolerance (±%) | Test Frequency (MHz) | Q Typ. | SRF (MHz) Min | RDC (Ω) Max | IDC (mA) | Color |
|---------------|-----------------|----------------|----------------------|--------|---------------|-------------|----------|--------|
| LS0805-78N□-N | 0.078 | 10 / 5 | 7.9 | 19 | 1440 | 0.06 | 2000 | Black |
| LS0805-90N□-N | 0.090 | 10 / 5 | 7.9 | 19 | 1200 | 0.07 | 2000 | Red |
| LS0805-R11□-N | 0.11 | 10 / 5 | 7.9 | 19 | 1200 | 0.07 | 2000 | Brown |
| LS0805-R47□-N | 0.47 | 10 / 5 | 7.9 | 19 | 480 | 0.40 | 800 | Red |
| LS0805-R56□-N | 0.56 | 10 / 5 | 7.9 | 35 | 480 | 0.40 | 800 | Yellow |
| LS0805-R68□-N | 0.68 | 10 / 5 | 7.9 | 20 | 480 | 0.40 | 800 | Orange |
| LS0805-R91□-N | 0.91 | 10 / 5 | 7.9 | 20 | 400 | 0.69 | 700 | Yellow |
| LS0805-1R0□-N | 1.0 | 10 / 5 | 7.9 | 20 | 400 | 0.69 | 700 | Yellow |
| LS0805-1R2□-N | 1.2 | 10 / 5 | 7.9 | 20 | 330 | 0.83 | 700 | Red |
| LS0805-1R5□-N | 1.5 | 10 / 5 | 7.9 | 20 | 330 | 0.83 | 700 | Green |
| LS0805-1R8□-N | 1.8 | 10 / 5 | 7.9 | 20 | 300 | 1.00 | 650 | Blue |
| LS0805-2R2□-N | 2.2 | 10 / 5 | 7.9 | 20 | 250 | 1.10 | 650 | Violet |
| LS0805-2R7□-N | 2.7 | 10 / 5 | 7.9 | 23 | 200 | 1.25 | 650 | Gray |
| LS0805-3R3□-N | 3.3 | 10 / 5 | 7.9 | 23 | 160 | 1.45 | 650 | White |
| LS0805-3R9□-N | 3.9 | 10 / 5 | 7.9 | 23 | 90 | 1.50 | 600 | Black |
| LS0805-4R7□-N | 4.7 | 10 / 5 | 7.9 | 20 | 70 | 1.60 | 530 | Brown |
| LS0805-5R6□-N | 5.6 | 10 / 5 | 7.9 | 20 | 65 | 1.70 | 500 | Red |
| LS0805-6R8□-N | 6.8 | 10 / 5 | 7.9 | 20 | 45 | 1.95 | 470 | Orange |
| LS0805-8R2□-N | 8.2 | 10 / 5 | 2.5 | 16 | 45 | 2.10 | 450 | Yellow |
| LS0805-100□-N | 10 | 10 / 5 | 2.5 | 16 | 40 | 2.40 | 400 | Green |
| LS0805-120□-N | 12 | 10 / 5 | 2.5 | 16 | 38 | 3.20 | 360 | Red |
| LS0805-150□-N | 15 | 10 / 5 | 2.5 | 16 | 30 | 3.55 | 350 | Blue |
| LS0805-180□-N | 18 | 10 / 5 | 2.5 | 16 | 25 | 4.90 | 300 | Orange |
| LS0805-220□-N | 22 | 10 / 5 | 2.5 | 16 | 20 | 5.45 | 270 | Violet |
| LS0805-270□-N | 27 | 10 / 5 | 2.5 | 16 | 19 | 7.80 | 240 | Gray |
| LS0805-330□-N | 33 | 10 / 5 | 2.5 | 16 | 16 | 9.50 | 210 | White |
| LS0805-470□-N | 47 | 10 / 5 | 2.5 | 16 | 15 | 14.50 | 180 | Brown |

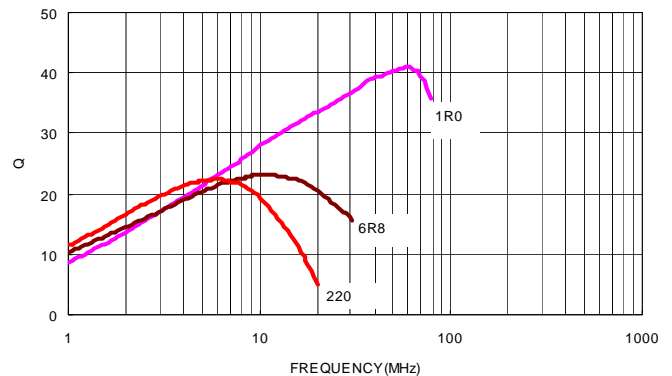
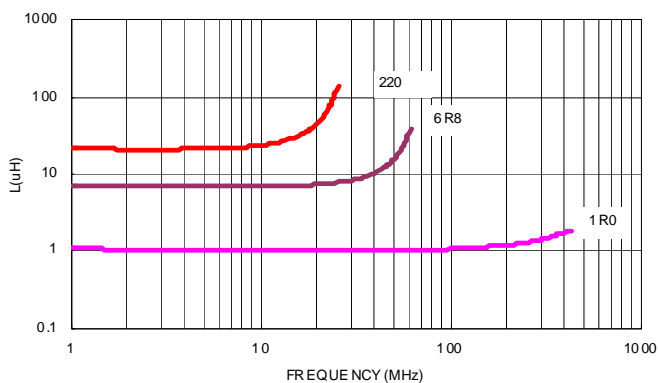
Note: When ordering, please specify tolerance code. Tolerance : J=±5% , K=±10%

- Operating temperature range - 25°C ~ 105°C(Including self - temperature rise)
- IDC for Inductance drop 10% from its value without current
- Measure Equipment :
 L & Q : Agilent E4991A+Agilent HP16197A
 SRF : Agilent E4991A
 RDC : HP4338B or Chroma 16502
 IDC : HP4284A+HP42841A/HP4285A+HP42841A

Test Instruments : Agilent E4991A Material/Impedance Analyzer

Typical **L** vs. **F** Frequency

Typical **Q** vs. **F** Frequency



Please be sure to request approval specifications that provide further details of the products. Kindly note that the content of these specifications are subject to change or may be discontinued without advance notice. Please contact our sales department before ordering.

Electrical Characteristics

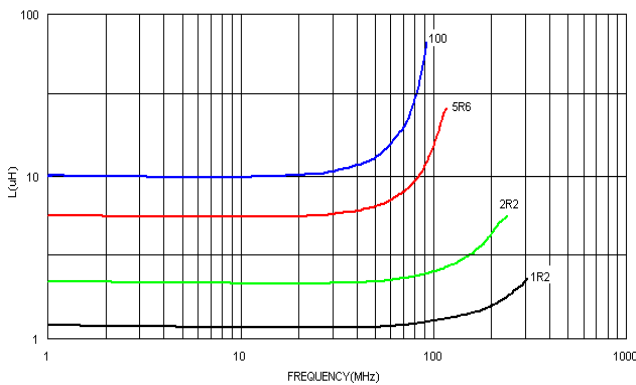
| Part Number | Inductance (uH) | Tolerance (±%) | Test Frequency (MHz) | Q Typ. | Test Frequency (MHz) | SRF (MHz) Min | RDC (Ω) Max | IDC (mA) | Color Coding | | |
|---------------|-----------------|----------------|----------------------|--------|----------------------|---------------|-------------|----------|-----------------|-----------------|-----------------|
| | | | | | | | | | 1 ST | 2 ND | 3 RD |
| LS1008-1R2□-N | 1.2 | 10 / 5 | 7.9 | 55 | 50 | 350 | 0.50 | 1200 | Brown | Red | Red |
| LS1008-1R5□-N | 1.5 | 10 / 5 | 7.9 | 58 | 50 | 300 | 0.65 | 1200 | Brown | Green | Red |
| LS1008-1R8□-N | 1.8 | 10 / 5 | 7.9 | 54 | 50 | 280 | 0.75 | 1050 | Brown | Gray | Red |
| LS1008-2R2□-N | 2.2 | 10 / 5 | 7.9 | 48 | 50 | 250 | 0.90 | 950 | Red | Red | Red |
| LS1008-2R7□-N | 2.7 | 10 / 5 | 7.9 | 51 | 50 | 200 | 1.00 | 950 | Red | Violet | Red |
| LS1008-3R3□-N | 3.3 | 10 / 5 | 7.9 | 58 | 50 | 200 | 1.15 | 900 | Orange | Orange | Red |
| LS1008-3R9□-N | 3.9 | 10 / 5 | 7.9 | 37 | 7.9 | 170 | 1.25 | 850 | Orange | White | Red |
| LS1008-4R7□-N | 4.7 | 10 / 5 | 7.9 | 37 | 7.9 | 130 | 1.35 | 700 | Yellow | Violet | Red |
| LS1008-5R6□-N | 5.6 | 10 / 5 | 7.9 | 36 | 7.9 | 110 | 1.45 | 700 | Green | Blue | Red |
| LS1008-6R8□-N | 6.8 | 10 / 5 | 7.9 | 33 | 7.9 | 105 | 1.60 | 600 | Blue | Gray | Red |
| LS1008-8R2□-N | 8.2 | 10 / 5 | 7.9 | 40 | 7.9 | 90 | 1.80 | 550 | Gray | Red | Red |
| LS1008-100□-N | 10 | 10 / 5 | 7.9 | 40 | 7.9 | 85 | 2.40 | 500 | Brown | Black | Orange |
| LS1008-120□-N | 12 | 10 / 5 | 7.9 | 40 | 7.9 | 80 | 2.40 | 450 | Brown | Red | Orange |
| LS1008-150□-N | 15 | 10 / 5 | 7.9 | 35 | 7.9 | 38 | 2.40 | 450 | Brown | Green | Orange |
| LS1008-390□-N | 39 | 10 / 5 | 2.5 | 33 | 2.5 | 26 | 10 | 170 | Orange | White | Orange |

Note: When ordering, please specify tolerance code. Tolerance : J=±5% , K=±10%

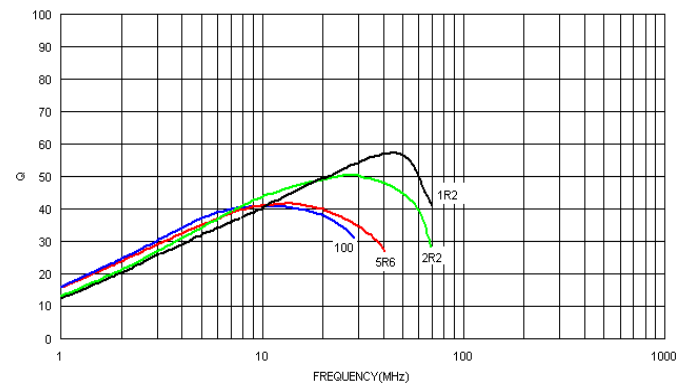
- Operating temperature range - 25°C ~ 105°C(Including self - temperature rise)
- IDC for Inductance drop 10% from its value without current
- Measure Equipment :
 L & Q : Agilent E4991A+Agilent HP16197A
 SRF : Agilent E4991A
 RDC : HP4338B or Chroma 16502
 IDC : HP4284A+HP42841A/HP4285A+HP42841A

Test Instruments : Agilent E4991A Material/Impedance Analyzer

Typical L vs. Frequency



Typical Q vs. Frequency



Please be sure to request approval specifications that provide further details of the products. Kindly note that the content of these specifications are subject to change or may be discontinued without advance notice. Please contact our sales department before ordering.

Packaging Specifications

Tape Dimensions

Figure 1

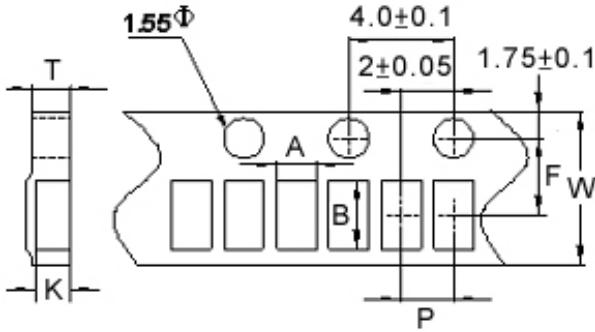


Figure 2

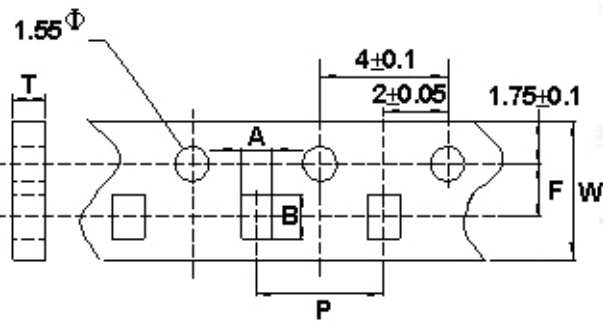
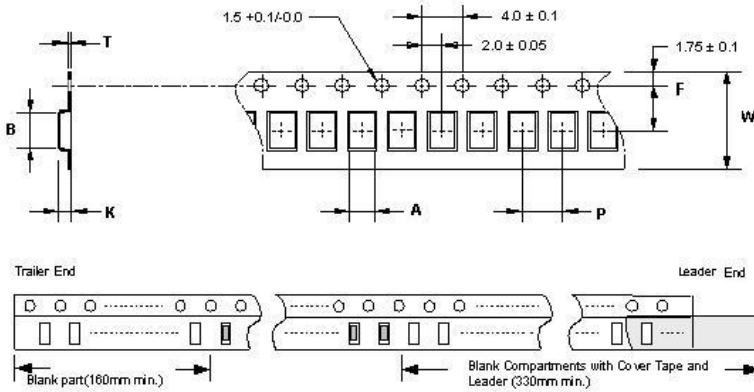
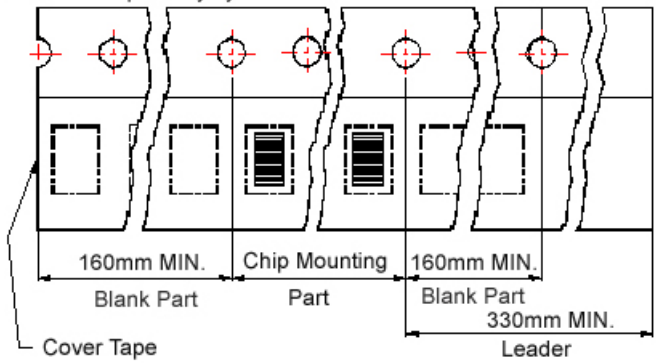


Figure 3

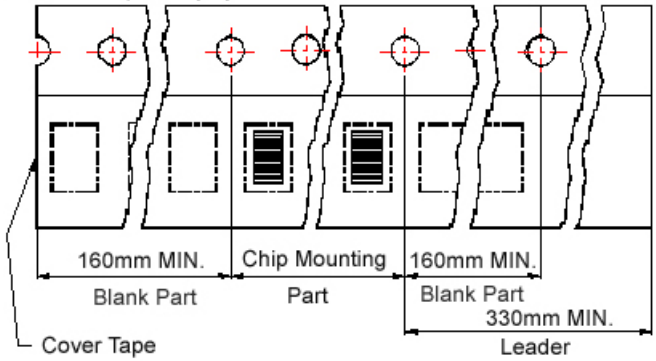


Tape Material

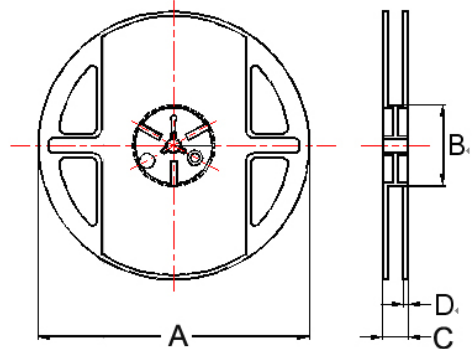
Carrier Tape: Paper
Cover Tape: Polystyrene



Carrier Tape: Paper
Cover Tape: Polystyrene



Reel Dimensions



Dimensions in mm

| TYPE | Fig. | Tape Dimensions | | | | | | | Reel Dimensions | | | | Quantity PCS / REEL |
|-----------------|------|-----------------|------|------|---|---|-----|------|-----------------|----|----|-----|------------------------|
| | | A | B | T | W | P | F | K | A | B | C | D | |
| LS0201 | 1 | 0.44 | 0.62 | 0.61 | 8 | 2 | 3.5 | 0.46 | 178 | 60 | 12 | 1.5 | 4000 |
| LS0402 | 1 | 0.67 | 1.20 | 0.75 | 8 | 2 | 3.5 | 0.59 | 178 | 60 | 12 | 1.5 | 4000 |
| LS0603(47N~1R8) | 2 | 1.20 | 1.80 | 1.05 | 8 | 4 | 3.5 | - | 178 | 60 | 12 | 1.5 | 4000 |
| LS0603(2R2~100) | 2 | 1.23 | 1.9 | 1.05 | 8 | 4 | 3.5 | - | 178 | 60 | 12 | 1.5 | 4000 |
| LS0805 | 3 | 1.60 | 2.42 | 0.22 | 8 | 4 | 3.5 | 1.45 | 178 | 60 | 12 | 1.5 | 2000 |
| LS1008 | 3 | 2.40 | 2.93 | 0.26 | 8 | 4 | 3.5 | 2.25 | 178 | 60 | 12 | 1.5 | 2000 |

PS Series



PS series is the newest shielding type ferrite wire wound chip inductor. This wire wound ferrite construction provides extremely low DCR and high rating current.

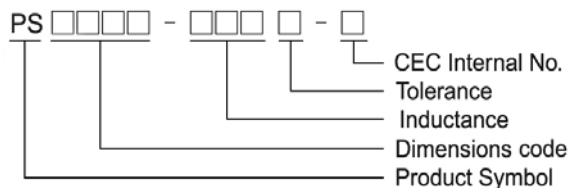
Features

- RoHS compliant
- Shielded power inductors
- Specially designed ferrite cover provides magnetic shielding
- Best possible surface for pick and place handling

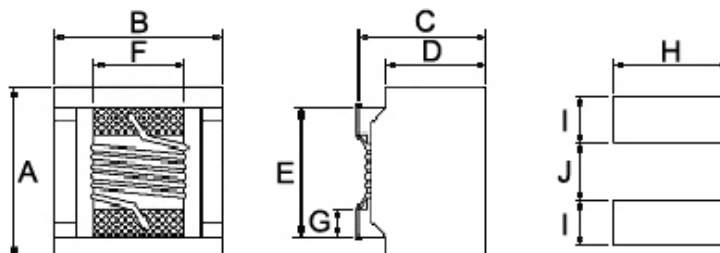
Applications

- Notebook computers
- PC cards
- Wireless communication
- Handheld devices

Product Identification



Shape and Dimensions / Recommended Pattern



Dimensions in mm

| TYPE | A Max | B Max | C Max | D | E | F | G | H | I | J | |
|--------|-------|-------|-------|------|------|------|------|------|------|------|------|
| PS1008 | 3.81 | 3.81 | 2.94 | 3.05 | 2.20 | 2.54 | 2.03 | 0.51 | 2.54 | 1.02 | 1.27 |

C : 2.94⁺⁰mm at 1R0~331/ 561~102
3.05⁺⁰mm at 471

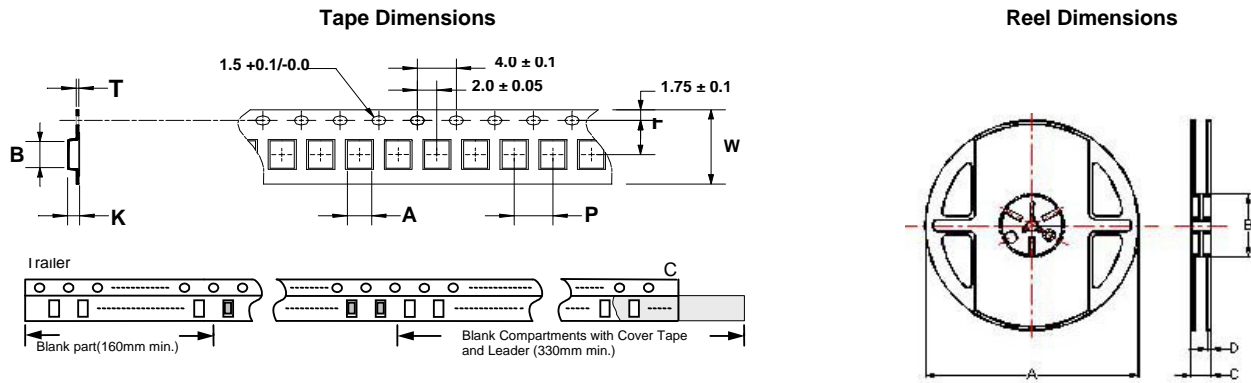
Electrical Characteristics

| Part Number | Inductance (uH) | Tolerance (±%) | Test Frequency (MHz) | Q Typ. | Test Frequency (MHz) | SRF (MHz) Typ. | RDC (Ω) Max | IDC (A) |
|---------------|-----------------|----------------|----------------------|--------|----------------------|----------------|-------------|---------|
| PS1008-1R0□-N | 1.0 | 20 / 10 | 0.1 | 26 | 1 | 344 | 0.05 | 3.0 |
| PS1008-1R5□-N | 1.5 | 20 / 10 | 0.1 | 26 | 1 | 260 | 0.08 | 2.8 |
| PS1008-1R8□-N | 1.8 | 20 / 10 | 0.1 | 28 | 1 | 225 | 0.09 | 2.1 |
| PS1008-2R7□-N | 2.7 | 20 / 10 | 0.1 | 30 | 1 | 185 | 0.14 | 1.5 |
| PS1008-3R9□-N | 3.9 | 20 / 10 | 0.1 | 30 | 1 | 172 | 0.29 | 1.2 |
| PS1008-4R7□-N | 4.7 | 20 / 10 | 0.1 | 30 | 1 | 157 | 0.35 | 1.1 |
| PS1008-5R6□-N | 5.6 | 20 / 10 | 0.1 | 30 | 1 | 150 | 0.39 | 1.1 |
| PS1008-6R8□-N | 6.8 | 20 / 10 | 0.1 | 30 | 1 | 110 | 0.58 | 0.9 |
| PS1008-100□-N | 10 | 20 / 10 | 0.1 | 30 | 1 | 95 | 0.75 | 0.82 |
| PS1008-150□-N | 15 | 20 / 10 | 0.1 | 30 | 1 | 75 | 1.15 | 0.70 |
| PS1008-220□-N | 22 | 20 / 10 | 0.1 | 33 | 1 | 30 | 1.40 | 0.65 |
| PS1008-330□-N | 33 | 20 / 10 | 0.1 | 33 | 1 | 21 | 1.61 | 0.52 |
| PS1008-390□-N | 39 | 20 / 10 | 0.1 | 33 | 1 | 18 | 1.85 | 0.46 |
| PS1008-470□-N | 47 | 20 / 10 | 0.1 | 33 | 1 | 15 | 2.20 | 0.43 |
| PS1008-680□-N | 68 | 20 / 10 | 0.1 | 33 | 1 | 12 | 3.80 | 0.33 |
| PS1008-820□-N | 82 | 20 / 10 | 0.1 | 33 | 1 | 10 | 4.30 | 0.32 |
| PS1008-101□-N | 100 | 20 / 10 | 0.1 | 33 | 1 | 8 | 4.80 | 0.31 |
| PS1008-121□-N | 120 | 20 / 10 | 0.1 | 33 | 1 | 8 | 5.0 | 0.25 |
| PS1008-151□-N | 150 | 20 / 10 | 0.1 | 33 | 1 | 5.8 | 6.5 | 0.24 |
| PS1008-221□-N | 220 | 20 / 10 | 0.1 | 33 | 1 | 5.5 | 12.0 | 0.22 |
| PS1008-331□-N | 330 | 20 / 10 | 0.1 | 33 | 1 | 3.8 | 17.0 | 0.20 |
| PS1008-471□-N | 470 | 20 / 10 | 0.1 | 33 | 1 | 3.1 | 19.0 | 0.16 |
| PS1008-561□-N | 560 | 20 / 10 | 0.1 | 33 | 1 | 2.8 | 18.4 | 0.13 |
| PS1008-681□-N | 680 | 20 / 10 | 0.1 | 33 | 1 | 2.5 | 24.0 | 0.12 |
| PS1008-821□-N | 820 | 20 / 10 | 0.1 | 23 | 1 | 2.0 | 26.0 | 0.10 |
| PS1008-102□-N | 1000 | 20 / 10 | 0.1 | 20 | 1 | 1.5 | 29.2 | 0.10 |

Note: When ordering, please specify tolerance code. Tolerance : K=±10% , M=±20%

- Operating temperature range - 40°C ~ 105°C(Including self - temperature rise)
- IDC for Inductance drop 10% from its value without current
- Measure Equipment :
 - L : Agilent HP4285A
 - Q : Agilent HP4291A
 - SRF : Agilent HP4291A
 - RDC : HP4338B or Chroma 16502
 - IDC : CHEN HWA1061+301A

Packaging Specifications



Dimensions in mm

| TYPE | Tape Dimensions | | | | | | | Reel Dimensions | | | | Quantity PCS / REEL |
|---------|-----------------|------|------|----|---|-----|------|-----------------|----|----|-----|------------------------|
| | A | B | T | W | P | F | K | A | B | C | D | |
| PS 1008 | 3.85 | 3.85 | 0.25 | 12 | 8 | 5.5 | 2.85 | 178 | 60 | 16 | 1.4 | 750 |

LT Series



LT series is the newest open type ferrite wire wound chip inductors. This wire wound ferrite construction supports thinness for low profile application.

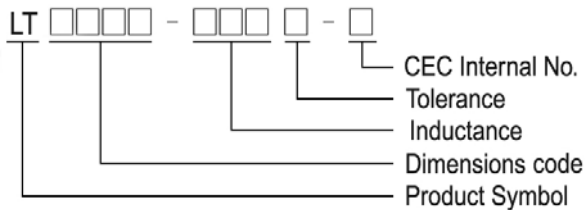
Features

- RoHS compliant
- At just 1.05mm in height, these are one of Chilisin's lowest profile surface mount inductors
- Wire wound ferrite design supports lower R_{dc}, higher current ratings and exceptional Q values
- Inductance values from 0.12 to 39uH

Applications

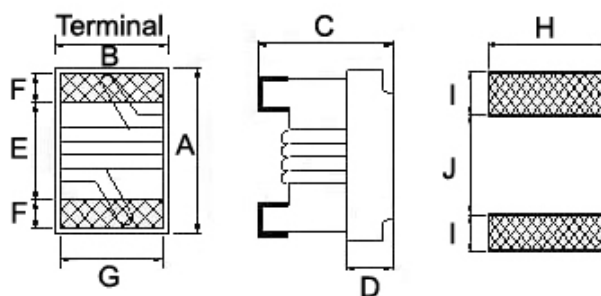
- Boost IC for tiny panels of C-STN, TFT-LCD and OLED in backlight
- Buck/Boost IC using in DC to DC converter
- LC filter in power as well as signal lines

Product Identification



Shape and Dimensions / Recommended Pattern

LT0805/1210



Dimensions in mm

| TYPE | A Max | B Max | C Max | D Ref | E | F | G | H | I | J |
|--------|-------|-------|-------|-------|------|------|------|------|------|------|
| LT0805 | 2.40 | 1.85 | 1.05 | 0.70 | 1.02 | 0.50 | 1.27 | 1.78 | 1.02 | 0.76 |
| LT1210 | 3.75 | 3.10 | 1.05 | 0.65 | 1.80 | 0.65 | 2.35 | 2.70 | 1.00 | 2.00 |

Electrical Characteristics

| Part Number | Inductance (uH) | Tolerance (±%) | Test Frequency (MHz) | Q Min | SRF (MHz) Min | RDC (Ω) Max | IDC (mA) Max | Color |
|---------------|-----------------|----------------|----------------------|-------|---------------|-------------|--------------|--------|
| LT0805-R12□-N | 0.12 | 10 / 5 | 25.2 | 22 | 1500 | 0.33 | 1200 | Black |
| LT0805-R15□-N | 0.15 | 10 / 5 | 25.2 | 22 | 1100 | 0.33 | 1200 | Brown |
| LT0805-R18□-N | 0.18 | 10 / 5 | 25.2 | 22 | 1100 | 0.36 | 1100 | Red |
| LT0805-R22□-N | 0.22 | 10 / 5 | 25.2 | 22 | 1100 | 0.39 | 1100 | Orange |
| LT0805-R27□-N | 0.27 | 10 / 5 | 25.2 | 22 | 950 | 0.43 | 1050 | Yellow |
| LT0805-R33□-N | 0.33 | 10 / 5 | 25.2 | 22 | 650 | 0.46 | 900 | Green |
| LT0805-R39□-N | 0.39 | 10 / 5 | 25.2 | 22 | 640 | 0.48 | 850 | Blue |
| LT0805-R47□-N | 0.47 | 10 / 5 | 25.2 | 22 | 570 | 0.65 | 800 | Violet |
| LT0805-R56□-N | 0.56 | 10 / 5 | 25.2 | 22 | 540 | 0.67 | 770 | Gray |
| LT0805-R68□-N | 0.68 | 10 / 5 | 25.2 | 22 | 500 | 0.73 | 750 | White |
| LT0805-R82□-N | 0.82 | 10 / 5 | 25.2 | 22 | 480 | 0.85 | 730 | Black |
| LT0805-1R0□-N | 1.0 | 10 / 5 | 7.96 | 15 | 470 | 0.87 | 720 | Brown |
| LT0805-1R2□-N | 1.2 | 10 / 5 | 7.96 | 15 | 450 | 0.97 | 690 | Red |
| LT0805-1R5□-N | 1.5 | 10 / 5 | 7.96 | 15 | 400 | 1.10 | 670 | Orange |
| LT0805-1R8□-N | 1.8 | 10 / 5 | 7.96 | 15 | 340 | 1.15 | 650 | Yellow |
| LT0805-2R2□-N | 2.2 | 10 / 5 | 7.96 | 15 | 265 | 1.28 | 630 | Green |
| LT0805-2R7□-N | 2.7 | 10 / 5 | 7.96 | 15 | 235 | 1.40 | 620 | Blue |
| LT0805-3R3□-N | 3.3 | 10 / 5 | 7.96 | 15 | 190 | 1.62 | 580 | Violet |
| LT0805-3R9□-N | 3.9 | 10 / 5 | 7.96 | 15 | 180 | 1.75 | 570 | Gray |
| LT0805-4R7□-N | 4.7 | 10 / 5 | 7.96 | 13 | 160 | 1.95 | 550 | White |
| LT0805-5R6□-N | 5.6 | 10 / 5 | 7.96 | 15 | 120 | 2.14 | 540 | Black |
| LT0805-6R8□-N | 6.8 | 10 / 5 | 7.96 | 15 | 45 | 2.28 | 520 | Brown |
| LT0805-8R2□-N | 8.2 | 10 / 5 | 7.96 | 15 | 42 | 2.55 | 500 | Red |
| LT0805-100□-N | 10 | 10 / 5 | 2.52 | 10 | 38 | 2.70 | 450 | Orange |
| LT0805-120□-N | 12 | 10 / 5 | 2.52 | 10 | 33 | 4.20 | 400 | Yellow |
| LT0805-150□-N | 15 | 10 / 5 | 2.52 | 10 | 30 | 4.80 | 380 | Green |
| LT0805-180□-N | 18 | 10 / 5 | 2.52 | 10 | 25 | 5.74 | 300 | Blue |
| LT0805-220□-N | 22 | 10 / 5 | 2.52 | 10 | 23 | 7.75 | 260 | Violet |
| LT0805-270□-N | 27 | 10 / 5 | 2.52 | 10 | 21 | 10.0 | 230 | Gray |
| LT0805-330□-N | 33 | 10 / 5 | 2.52 | 10 | 16 | 13.5 | 200 | White |
| LT0805-390□-N | 39 | 10 / 5 | 2.52 | 10 | 15 | 16.0 | 190 | Black |

Note: When ordering, please specify tolerance code. Tolerance : J=±5% , K=±10%

- Operating temperature range - 25°C ~ 105°C(Including self - temperature rise)
- IDC for Inductance drop 10% from its value without current
- Measure Equipment :
 L & Q : Agilent E4991A+Agilent HP16197A
 SRF : Agilent E4991A
 RDC : HP4338B or Chroma 16502
 IDC : HP4284A+HP42841A/HP4285A+HP42841A

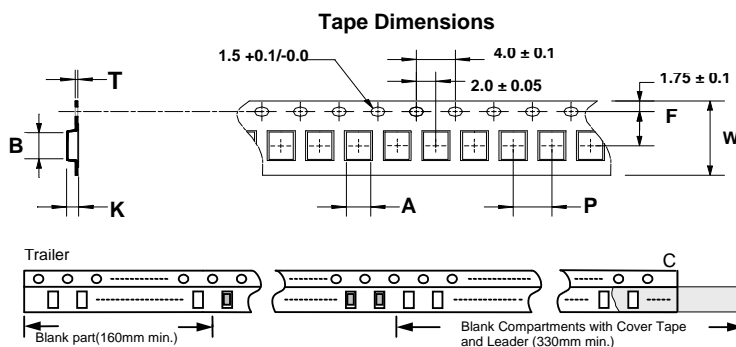
Electrical Characteristics

| Part Number | Inductance (uH) | Tolerance (±%) | Test Frequency (MHz) | Q Typ. | SRF (MHz) Min | RDC (Ω) Max | IDC (mA) Max | Color Coding | | |
|---------------|-----------------|----------------|----------------------|--------|---------------|-------------|--------------|-----------------|-----------------|-----------------|
| | | | | | | | | 1 ST | 2 ND | 3 RD |
| LT1210-1R0□-N | 1.0 | 10 / 5 | 7.96 | 20 | 350 | 0.45 | 1500 | Brown | Black | Red |
| LT1210-1R2□-N | 1.2 | 10 / 5 | 7.96 | 20 | 330 | 0.49 | 1300 | Brown | Red | Red |
| LT1210-1R5□-N | 1.5 | 10 / 5 | 7.96 | 20 | 310 | 0.68 | 1200 | Brown | Green | Red |
| LT1210-1R8□-N | 1.8 | 10 / 5 | 7.96 | 20 | 290 | 0.72 | 1150 | Brown | Gray | Red |
| LT1210-2R2□-N | 2.2 | 10 / 5 | 7.96 | 20 | 270 | 1.02 | 1020 | Red | Red | Red |
| LT1210-2R7□-N | 2.7 | 10 / 5 | 7.96 | 20 | 265 | 1.15 | 1000 | Red | Violet | Red |
| LT1210-3R3□-N | 3.3 | 10 / 5 | 7.96 | 20 | 195 | 1.20 | 970 | Orange | Orange | Red |
| LT1210-3R9□-N | 3.9 | 10 / 5 | 7.96 | 20 | 170 | 1.35 | 910 | Orange | White | Red |
| LT1210-4R7□-N | 4.7 | 10 / 5 | 7.96 | 20 | 155 | 1.48 | 880 | Yellow | Violet | Red |
| LT1210-5R6□-N | 5.6 | 10 / 5 | 7.96 | 20 | 125 | 1.65 | 820 | Green | Blue | Red |
| LT1210-6R8□-N | 6.8 | 10 / 5 | 7.96 | 20 | 110 | 1.68 | 750 | Blue | Gray | Red |
| LT1210-8R2□-N | 8.2 | 10 / 5 | 7.96 | 20 | 100 | 1.88 | 700 | Gray | Red | Red |
| LT1210-100□-N | 10 | 10 / 5 | 2.52 | 16 | 85 | 2.90 | 610 | Brown | Black | Orange |
| LT1210-120□-N | 12 | 10 / 5 | 2.52 | 16 | 70 | 3.05 | 540 | Brown | Red | Orange |
| LT1210-150□-N | 15 | 10 / 5 | 2.52 | 16 | 65 | 3.45 | 500 | Brown | Green | Orange |
| LT1210-180□-N | 18 | 10 / 5 | 2.52 | 16 | 55 | 4.79 | 420 | Brown | Gray | Orange |
| LT1210-220□-N | 22 | 10 / 5 | 2.52 | 16 | 50 | 5.20 | 350 | Red | Red | Orange |

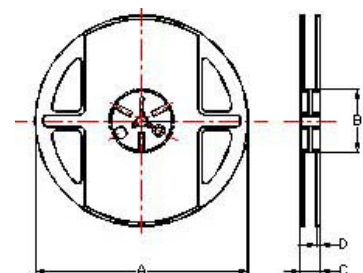
Note: When ordering, please specify tolerance code. Tolerance : J=±5% , K=±10%

- Operating temperature range - 25°C ~ 105°C(Including self - temperature rise)
- IDC for Inductance drop 10% from its value without current
- Measure Equipment :
 L & Q : Agilent E4991A+Agilent HP16197A
 SRF : Agilent E4991A
 RDC : HP4338B or Chroma 16502
 IDC : HP4284A+HP42841A/HP4285A+HP42841A

Packaging Specifications



Reel Dimensions



Dimensions in mm

| TYPE | Tape Dimensions | | | | | | | Reel Dimensions | | | | Quantity PCS / REEL |
|--------|-----------------|------|------|----|---|-----|-----|-----------------|----|----|-----|------------------------|
| | A | B | T | W | P | F | K | A | B | C | D | |
| LT0805 | 1.85 | 2.45 | 0.23 | 8 | 4 | 3.5 | 1.0 | 178 | 60 | 12 | 1.5 | 2000 |
| LT1210 | 3.05 | 3.70 | 0.25 | 12 | 4 | 5.5 | 1.1 | 178 | 60 | 12 | 1.5 | 2000 |

Please be sure to request approval specifications that provide further details of the products. Kindly note that the content of these specifications are subject to change or may be discontinued without advance notice. Please contact our sales department before ordering.

SQV Series



SQV Series comes in 2 sizes with wide inductance range, high Q value at high frequencies and low DC resistance.

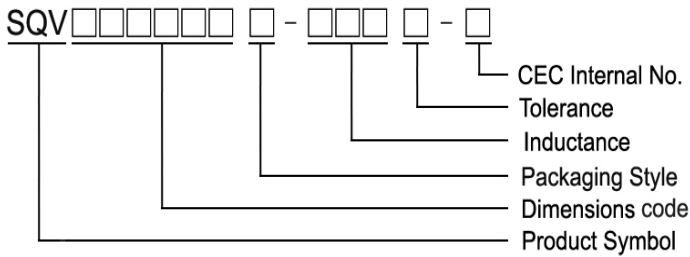
Features

- RoHS compliant
- Miniature chip inductors wound on a special ferrite core
- High Q value at high frequencies and low DC resistance
- Wide inductance range
- Excellent solder heat resistance
- Both flow and reflow soldering methods can be employed

Applications

- Personal, cordless phone
- High Freq. communication products
- GPS (global position system)
- Personal computers

Product Identification

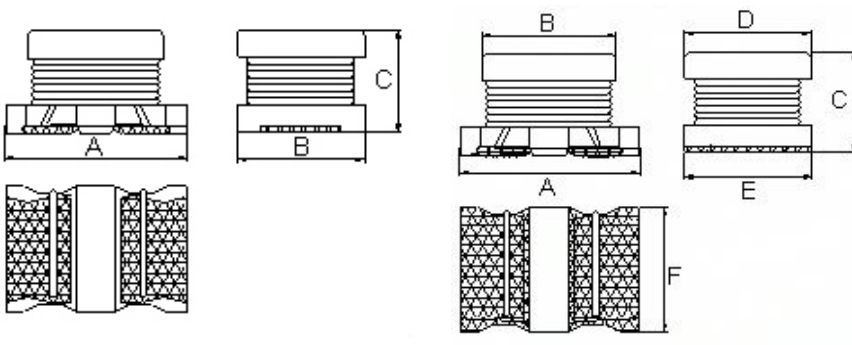


- Packaging: T : Tape and Reel

Shape and Dimensions

SQV322520

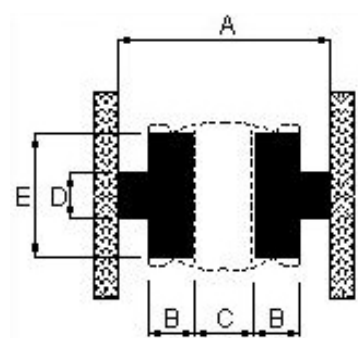
SQV453226



Dimensions in mm

| TYPE | A | B | C | D | E | F |
|-----------|---------|---------|---------|---------|---------|---------|
| SQV322520 | 3.2±0.3 | 2.5±0.2 | 2.0±0.2 | - | - | - |
| SQV453226 | 4.5±0.3 | 3.6±0.2 | 2.6±0.2 | 3.2±0.2 | 3.2±0.2 | 3.2±0.2 |

Recommended Pattern



Dimensions in mm

| TYPE | A | B | C | D | E |
|-----------|-----|-----|-----|-----|-----|
| SQV322520 | 5.5 | 1.0 | 1.3 | 1.0 | 2.0 |
| SQV453226 | 7.5 | 1.5 | 1.5 | 1.5 | 3.0 |

Electrical Characteristics

| Part Number | Inductance (uH) | Tolerance (±%) | Test Frequency (MHz) | Q Min | Test Frequency (MHz) | SRF (MHz) Min | RDC (Ω) Max | Rated current (mA) |
|-------------------|-----------------|----------------|----------------------|-------|----------------------|---------------|-------------|--------------------|
| SQV322520T-R47□-N | 0.47 | 20 | 1 | 20 | 1 | 150 | 0.06 | 1100 |
| SQV322520T-R82□-N | 0.82 | 20 | 1 | 20 | 1 | 120 | 0.25 | 450 |
| SQV322520T-1R0□-N | 1.0 | 20 | 1 | 20 | 1 | 100 | 0.50 | 445 |
| SQV322520T-1R2□-N | 1.2 | 20 | 1 | 20 | 1 | 100 | 0.60 | 425 |
| SQV322520T-1R5□-N | 1.5 | 20 / 10 | 1 | 20 | 1 | 75 | 0.60 | 400 |
| SQV322520T-1R8□-N | 1.8 | 20 / 10 | 1 | 20 | 1 | 60 | 0.70 | 390 |
| SQV322520T-2R2□-N | 2.2 | 20 / 10 | 1 | 20 | 1 | 50 | 0.80 | 370 |
| SQV322520T-2R7□-N | 2.7 | 20 / 10 | 1 | 20 | 1 | 43 | 0.90 | 320 |
| SQV322520T-3R3□-N | 3.3 | 20 / 10 | 1 | 20 | 1 | 38 | 1.0 | 300 |
| SQV322520T-3R9□-N | 3.9 | 20 / 10 | 1 | 20 | 1 | 35 | 1.1 | 290 |
| SQV322520T-4R7□-N | 4.7 | 20 / 10 | 1 | 20 | 1 | 31 | 1.2 | 270 |
| SQV322520T-5R6□-N | 5.6 | 20 / 10 | 1 | 20 | 1 | 28 | 1.3 | 250 |
| SQV322520T-6R8□-N | 6.8 | 20 / 10 | 1 | 20 | 1 | 25 | 1.5 | 240 |
| SQV322520T-8R2□-N | 8.2 | 20 / 10 | 1 | 20 | 1 | 23 | 1.6 | 225 |
| SQV322520T-100□-N | 10 | 20 / 10 | 1 | 35 | 1 | 20 | 1.8 | 190 |
| SQV322520T-120□-N | 12 | 20 / 10 | 1 | 35 | 1 | 18 | 2.0 | 180 |
| SQV322520T-150□-N | 15 | 20 / 10 | 1 | 35 | 1 | 16 | 2.2 | 170 |
| SQV322520T-180□-N | 18 | 20 / 10 | 1 | 35 | 1 | 15 | 2.5 | 165 |
| SQV322520T-220□-N | 22 | 20 / 10 / 5 | 1 | 35 | 1 | 14 | 2.8 | 150 |
| SQV322520T-270□-N | 27 | 20 / 10 | 1 | 35 | 1 | 13 | 3.1 | 125 |
| SQV322520T-330□-N | 33 | 20 / 10 | 1 | 40 | 1 | 12 | 3.5 | 115 |
| SQV322520T-390□-N | 39 | 20 / 10 | 1 | 40 | 1 | 11 | 3.9 | 110 |
| SQV322520T-470□-N | 47 | 20 / 10 | 1 | 40 | 1 | 11 | 4.3 | 100 |
| SQV322520T-560□-N | 56 | 20 / 10 | 1 | 40 | 1 | 10.0 | 4.9 | 85 |
| SQV322520T-680□-N | 68 | 20 / 10 | 1 | 40 | 1 | 9.0 | 5.5 | 80 |
| SQV322520T-820□-N | 82 | 20 / 10 / 5 | 1 | 40 | 1 | 8.5 | 6.2 | 70 |
| SQV322520T-101□-N | 100 | 20 / 10 / 5 | 1 | 40 | 0.796 | 8.0 | 7.0 | 80 |
| SQV322520T-121□-N | 120 | 20 / 10 | 1 | 40 | 0.796 | 7.5 | 8.0 | 75 |
| SQV322520T-151□-N | 150 | 20 / 10 | 1 | 40 | 0.796 | 7.0 | 9.3 | 70 |
| SQV322520T-181□-N | 180 | 20 / 10 | 1 | 40 | 0.796 | 6.0 | 10.2 | 65 |
| SQV322520T-221□-N | 220 | 20 / 10 | 1 | 40 | 0.796 | 5.5 | 11.8 | 65 |
| SQV322520T-271□-N | 270 | 20 / 10 | 1 | 40 | 0.796 | 5.0 | 12.5 | 65 |
| SQV322520T-331□-N | 330 | 20 / 10 | 1 | 40 | 0.796 | 5.0 | 13.0 | 65 |
| SQV322520T-391□-N | 390 | 20 / 10 | 1 | 50 | 0.796 | 5.0 | 22.0 | 50 |
| SQV322520T-471□-N | 470 | 20 / 10 | 0.001 | 50 | 0.796 | 5.0 | 25.0 | 45 |
| SQV322520T-561□-N | 560 | 20 / 10 / 5 | 0.001 | 50 | 0.796 | 2.0 | 28.0 | 40 |

Note: When ordering, please specify tolerance code. Tolerance : J=±5% , K=±10% , M=±20%

- Operating temperature range - 40°C ~ 125°C(Including self - temperature rise)
- Rated Current : Self temperature rise shall be limited to 35°C Max Inductance drop 10% typ.
- Measure Equipment :
 - L : Agilent HP4285A(1MHz)/Agilent HP4192A(1kHz)
 - Q : Agilent HP4285A
 - SRF : Agilent HP4286A
 - RDC : HP4338B or Chroma 16502
 - Rated Current : HP4284A+HP42841A

Electrical Characteristics

| Part Number | Inductance (uH) | Tolerance (±%) | Test Frequency (MHz) | Q Min | Test Frequency (MHz) | SRF (MHz) Min | RDC (Ω) Max | Rated current (mA) |
|-------------------|-----------------|----------------|----------------------|-------|----------------------|---------------|-------------|--------------------|
| SQV453226T-1R0□-N | 1.0 | 20 | 1 | 20 | 1 | 120 | 0.20 | 500 |
| SQV453226T-1R2□-N | 1.2 | 20 | 1 | 20 | 1 | 100 | 0.20 | 500 |
| SQV453226T-1R5□-N | 1.5 | 20 | 1 | 20 | 1 | 85 | 0.30 | 500 |
| SQV453226T-1R8□-N | 1.8 | 20 | 1 | 20 | 1 | 75 | 0.30 | 500 |
| SQV453226T-2R2□-N | 2.2 | 20 | 1 | 20 | 1 | 62 | 0.30 | 500 |
| SQV453226T-2R7□-N | 2.7 | 20 | 1 | 20 | 1 | 53 | 0.32 | 500 |
| SQV453226T-3R3□-N | 3.3 | 20 | 1 | 20 | 1 | 47 | 0.35 | 500 |
| SQV453226T-3R9□-N | 3.9 | 20 | 1 | 20 | 1 | 41 | 0.38 | 500 |
| SQV453226T-4R7□-N | 4.7 | 20 / 10 | 1 | 30 | 1 | 38 | 0.40 | 500 |
| SQV453226T-5R6□-N | 5.6 | 20 / 10 | 1 | 30 | 1 | 33 | 0.47 | 500 |
| SQV453226T-6R8□-N | 6.8 | 20 / 10 | 1 | 30 | 1 | 31 | 0.50 | 450 |
| SQV453226T-8R2□-N | 8.2 | 20 / 10 | 1 | 30 | 1 | 27 | 0.56 | 450 |
| SQV453226T-100□-N | 10 | 20 / 10 | 1 | 35 | 1 | 23 | 0.56 | 400 |
| SQV453226T-120□-N | 12 | 20 / 10 | 1 | 35 | 1 | 21 | 0.62 | 380 |
| SQV453226T-150□-N | 15 | 20 / 10 / 5 | 1 | 35 | 1 | 19 | 0.73 | 360 |
| SQV453226T-180□-N | 18 | 20 / 10 | 1 | 35 | 1 | 17 | 0.82 | 340 |
| SQV453226T-220□-N | 22 | 20 / 10 / 5 | 1 | 35 | 1 | 15 | 0.94 | 320 |
| SQV453226T-270□-N | 27 | 20 / 10 / 5 | 1 | 35 | 1 | 14 | 1.1 | 300 |
| SQV453226T-330□-N | 33 | 20 / 10 | 1 | 35 | 1 | 12 | 1.2 | 270 |
| SQV453226T-390□-N | 39 | 20 / 10 / 5 | 1 | 35 | 1 | 11 | 1.4 | 240 |
| SQV453226T-470□-N | 47 | 20 / 10 / 5 | 1 | 35 | 1 | 10 | 1.5 | 220 |
| SQV453226T-560□-N | 56 | 20 / 10 | 1 | 35 | 1 | 9.3 | 1.7 | 200 |
| SQV453226T-680□-N | 68 | 20 / 10 / 5 | 1 | 35 | 1 | 8.4 | 1.9 | 180 |
| SQV453226T-820□-N | 82 | 20 / 10 | 1 | 35 | 1 | 7.5 | 2.2 | 170 |
| SQV453226T-101□-N | 100 | 20 / 10 / 5 | 1 | 40 | 0.796 | 6.8 | 2.5 | 160 |
| SQV453226T-121□-N | 120 | 20 / 10 | 1 | 40 | 0.796 | 6.2 | 3.0 | 150 |
| SQV453226T-151□-N | 150 | 20 / 10 | 1 | 40 | 0.796 | 5.5 | 3.7 | 130 |
| SQV453226T-181□-N | 180 | 20 / 10 | 1 | 40 | 0.796 | 5.0 | 4.5 | 120 |
| SQV453226T-221□-N | 220 | 20 / 10 / 5 | 1 | 40 | 0.796 | 4.5 | 5.4 | 110 |
| SQV453226T-271□-N | 270 | 20 / 10 | 1 | 40 | 0.796 | 4.0 | 6.8 | 100 |
| SQV453226T-331□-N | 330 | 20 / 10 | 1 | 40 | 0.796 | 3.6 | 8.2 | 95 |
| SQV453226T-391□-N | 390 | 20 / 10 / 5 | 1 | 40 | 0.796 | 3.3 | 9.7 | 90 |
| SQV453226T-471□-N | 470 | 20 / 10 / 5 | 0.001 | 40 | 0.796 | 3.0 | 11.8 | 80 |
| SQV453226T-561□-N | 560 | 20 / 10 / 5 | 0.001 | 40 | 0.796 | 2.7 | 14.5 | 70 |
| SQV453226T-681□-N | 680 | 20 / 10 | 0.001 | 40 | 0.796 | 2.5 | 17.5 | 65 |
| SQV453226T-821□-N | 820 | 20 / 10 | 0.001 | 40 | 0.796 | 2.2 | 20.5 | 60 |
| SQV453226T-102□-N | 1000 | 20 / 10 / 5 | 0.001 | 40 | 0.252 | 2.0 | 25.0 | 50 |
| SQV453226T-122□-N | 1200 | 20 / 10 | 0.001 | 40 | 0.252 | 1.8 | 30.0 | 45 |
| SQV453226T-152□-N | 1500 | 20 / 10 | 0.001 | 40 | 0.252 | 1.6 | 37.0 | 40 |
| SQV453226T-182□-N | 1800 | 20 / 10 | 0.001 | 40 | 0.252 | 1.5 | 45.0 | 35 |
| SQV453226T-222□-N | 2200 | 20 / 10 / 5 | 0.001 | 40 | 0.252 | 1.3 | 50.0 | 30 |

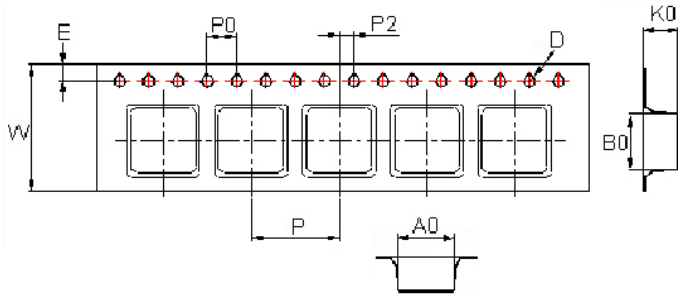
Note: When ordering, please specify tolerance code. Tolerance : J=±5% , K=±10% , M=±20%

- Operating temperature range - 40°C ~ 125°C(Including self - temperature rise)
- Rated Current : Self temperature rise shall be limited to 35°C Max Inductance drop 10% typ.
- Measure Equipment :
 - L : Agilent HP4285A(1MHz)/Agilent HP4192A(1kHz)
 - Q : Agilent HP4285A
 - SRF : Agilent HP4291A
 - RDC : HP4338B or Chroma 16502
 - Rated Current : HP4284A+HP42841A

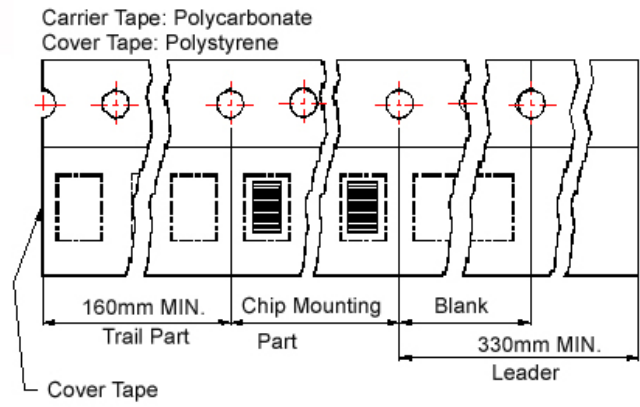
Please be sure to request approval specifications that provide further details of the products. Kindly note that the content of these specifications are subject to change or may be discontinued without advance notice. Please contact our sales department before ordering.

Packaging Specifications

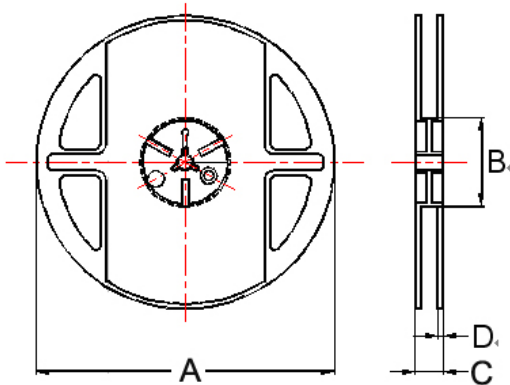
Tape Dimensions



Tape Material



Reel Dimensions



Dimensions in mm

| TYPE | Tape Dimensions | | | | | | | | | Reel Dimensions | | | | Quantity |
|-----------|-----------------|------|------|-----|------|----|---|----|----|-----------------|----|------|-----|------------|
| | A0 | B0 | K0 | D | E | W | P | P0 | P2 | A | B | C | D | PCS / REEL |
| SQV322520 | 2.90 | 3.60 | 2.25 | 1.5 | 1.75 | 8 | 4 | 4 | 2 | 178 | 60 | 9 | 1.5 | 2000 |
| SQV453226 | 3.60 | 4.90 | 3.00 | 1.5 | 1.75 | 12 | 8 | 4 | 2 | 178 | 60 | 13.2 | 1.5 | 500 |

SQC Series



The SQC Series is a type of miniature wire-wound chip inductor designed on a special ferrite core. They are excellent for use in DC power supply circuits.

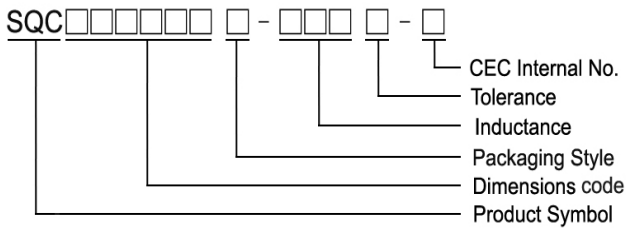
Features

- RoHS compliant
- Low DC resistance, high current capacity, and high impedance characteristics
- Excellent solder heat resistance
- Both flow and reflow soldering methods can be employed
- Available in 4 sizes

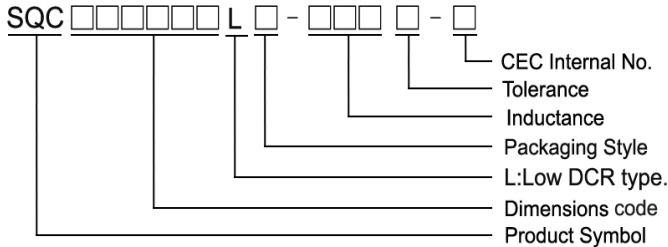
Applications

- Personal computers
- Disk drives and computer peripherals
- Pagers, cordless phone
- DC power supply circuit

Product Identification



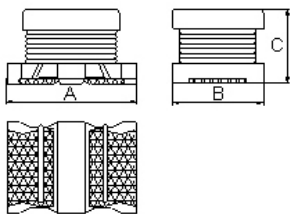
- Packaging: T : Tape and Reel



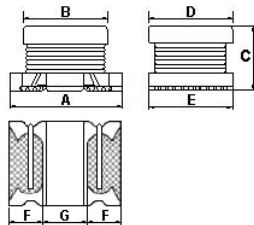
- Packaging: T : Tape and Reel

Shape and Dimensions

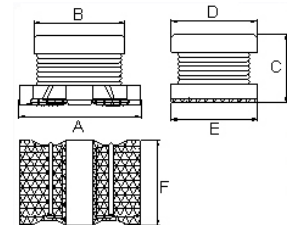
SQC322520 & SQC322520LT



SQC322517 & SQC322517HP



SQC453226



Dimensions in mm

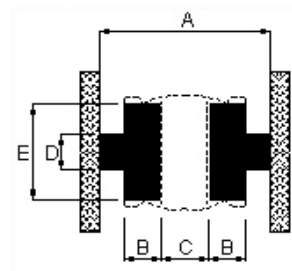
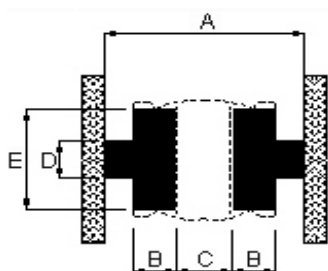
| TYPE | A | B | C | D | E | F | G |
|-------------|-----------|-----------|-------------|-----------|-----------|------------|-----------|
| SQC322517 | 3.2 ± 0.3 | 2.5 ± 0.2 | 1.55 ± 0.15 | 2.5 ± 0.2 | 2.5 ± 0.2 | 0.9 ± 0.3 | 1.3 ± 0.2 |
| SQC322517HP | 3.2 ± 0.3 | 2.5 ± 0.2 | 1.55 ± 0.15 | 2.5 ± 0.2 | 2.5 ± 0.2 | 0.95 ± 0.3 | 1.2 ± 0.2 |
| SQC322520 | 3.2 ± 0.3 | 2.5 ± 0.2 | 2.0 ± 0.2 | - | - | - | - |
| SQC322520LT | 3.2 ± 0.3 | 2.5 ± 0.2 | 2.0 ± 0.2 | - | - | - | - |
| SQC453226 | 4.5 ± 0.3 | 3.6 ± 0.2 | 2.6 ± 0.2 | 3.2 ± 0.2 | 3.2 ± 0.2 | 3.2 ± 0.2 | - |

Please be sure to request approval specifications that provide further details of the products. Kindly note that the content of these specifications are subject to change or may be discontinued without advance notice. Please contact our sales department before ordering.

Recommended Pattern

SQC322517 & SQC322517HP

SQC322520 & SQC322520LT & SQC453226



Dimensions in mm

| TYPE | A | B | C | D | E |
|-------------|-----|-----|-----|-----|-----|
| SQC322517 | 5.5 | 1.0 | 1.3 | 1.0 | 2.0 |
| SQC322517HP | 5.5 | 1.0 | 1.3 | 1.0 | 2.0 |
| SQC322520 | 5.5 | 1.0 | 1.3 | 1.0 | 2.0 |
| SQC322520LT | 5.5 | 1.0 | 1.3 | 1.0 | 2.0 |
| SQC453226 | 7.5 | 1.5 | 1.5 | 1.5 | 3.0 |

Electrical Characteristics

| Part Number | Inductance (uH) | Tolerance (±%) | Test Frequency (MHz) | SRF (MHz) Min | RDC (Ω±20%) | Rated current (mA) | I _{rms} (mA) |
|--------------------|-----------------|----------------|----------------------|---------------|-------------|--------------------|-----------------------|
| SQC322517HP-R47□-N | 0.47 | 30 | 1 | 100 | 0.030 | 3400 | 2550 |
| SQC322517HP-1R0□-N | 1.0 | 30 | 1 | 100 | 0.045 | 2300 | 2050 |
| SQC322517HP-1R5□-N | 1.5 | 30 | 1 | 70 | 0.057 | 1750 | 1750 |
| SQC322517HP-2R2□-N | 2.2 | 30 / 20 | 1 | 70 | 0.076 | 1550 | 1600 |
| SQC322517HP-3R3□-N | 3.3 | 30 / 20 | 1 | 50 | 0.120 | 1250 | 1200 |
| SQC322517HP-4R7□-N | 4.7 | 30 / 20 | 1 | 40 | 0.180 | 1000 | 1000 |
| SQC322517HP-6R8□-N | 6.8 | 30 / 20 | 1 | 40 | 0.240 | 850 | 850 |
| SQC322517HP-100□-N | 10 | 30 / 20 | 1 | 30 | 0.380 | 750 | 700 |
| SQC322517HP-150□-N | 15 | 30 / 20 | 1 | 25 | 0.700 | 550 | 500 |
| SQC322517HP-220□-N | 22 | 30 / 20 | 1 | 20 | 0.810 | 500 | 450 |
| SQC322517HP-330□-N | 33 | 30 / 20 | 1 | 14 | 1.050 | 360 | 320 |
| SQC322517HP-470□-N | 47 | 30 / 20 | 1 | 11 | 1.480 | 280 | 240 |

Note: When ordering, please specify tolerance code. Tolerance : M=±20% ,T=±30%

- Operating temperature range - 25°C ~ 125°C(Including self - temperature rise)
- Rated Current : Self temperature rise shall be limited to 35°C Max Inductance drop 10% typ.
- Measure Equipment :
 - L : Agilent HP4192A
 - SRF : Agilent HP4291A
 - RDC : Chroma 16502

Rate Current : HP4284A+HP42841A

Electrical Characteristics

| Part Number | Inductance (uH) | Tolerance (±%) | Test Frequency (MHz) | SRF (MHz) Min | RDC (Ω±30%) | Rated current (mA) |
|-------------------|-----------------|----------------|----------------------|---------------|-------------|--------------------|
| SQC322517T-2R2□-N | 2.2 | 20 | 1 | 64 | 0.097 | 790 |
| SQC322517T-3R3□-N | 3.3 | 20 | 1 | 50 | 0.12 | 710 |
| SQC322517T-6R8□-N | 6.8 | 20 | 1 | 32 | 0.25 | 540 |
| SQC322517T-100□-N | 10 | 20 / 10 | 1 | 26 | 0.30 | 350 |
| SQC322517T-220□-N | 22 | 20 / 10 | 1 | 19 | 0.71 | 250 |
| SQC322517T-101□-N | 100 | 20 / 10 | 1 | 10 | 3.50 | 100 |

Note: When ordering, please specify tolerance code. Tolerance : K=±10% , M=±20%

- Operating temperature range - 25°C ~ 125°C(Including self - temperature rise)
- Rated Current for Inductance drop 10% from its value with current
- Measure Equipment :
L : Agilent HP4192A
SRF : Agilent HP4287A
RDC : Chroma 16502

Electrical Characteristics

| Part Number | Inductance (uH) | Tolerance (±%) | Test Frequency (MHz) | SRF (MHz) Min | RDC (Ω±30%) | Rated current (mA) |
|-------------------|-----------------|----------------|----------------------|---------------|-------------|--------------------|
| SQC322520T-R47□-N | 0.47 | 20 | 1 | 150 | 0.042 | 1100 |
| SQC322520T-1R0□-N | 1.0 | 20 | 1 | 96 | 0.09 | 1000 |
| SQC322520T-2R2□-N | 2.2 | 20 | 1 | 64 | 0.13 | 600 |
| SQC322520T-3R3□-N | 3.3 | 20 / 10 | 1 | 60 | 0.15 | 600 |
| SQC322520T-3R9□-N | 3.9 | 20 | 1 | 50 | 0.16 | 500 |
| SQC322520T-4R7□-N | 4.7 | 20 | 1 | 43 | 0.20 | 450 |
| SQC322520T-6R8□-N | 6.8 | 20 | 1 | 30 | 0.26 | 400 |
| SQC322520T-100□-N | 10 | 20 / 10 | 1 | 26 | 0.44 | 300 |
| SQC322520T-150□-N | 15 | 20 / 10 | 1 | 22 | 0.55 | 350 |
| SQC322520T-220□-N | 22 | 20 / 10 | 1 | 19 | 0.71 | 250 |
| SQC322520T-270□-N | 27 | 20 / 10 | 1 | 15 | 0.90 | 230 |
| SQC322520T-330□-N | 33 | 20 / 10 | 1 | 15 | 1.10 | 200 |
| SQC322520T-470□-N | 47 | 20 / 10 | 1 | 15 | 1.30 | 170 |
| SQC322520T-560□-N | 56 | 20 / 10 | 1 | 12 | 2.30 | 150 |
| SQC322520T-101□-N | 100 | 20 / 10 | 1 | 10 | 3.50 | 100 |
| SQC322520T-151□-N | 150 | 20 / 10 / 5 | 1 | 7 | 6.00 | 80 |
| SQC322520T-221□-N | 220 | 20 / 10 / 5 | 1 | 6.8 | 8.40 | 70 |
| SQC322520T-271□-N | 270 | 20 / 10 | 1 | 6 | 10.0 | 65 |
| SQC322520T-331□-N | 330 | 20 / 10 / 5 | 1 | 5.6 | 10.0 | 60 |
| SQC322520T-391□-N | 390 | 20 / 10 | 1 | 5 | 17.0 | 60 |
| SQC322520T-471□-N | 470 | 20 / 10 | 0.001 | 5 | 19.0 | 60 |
| SQC322520T-561□-N | 560 | 20 / 10 | 0.001 | 5 | 22.0 | 60 |

Note: When ordering, please specify tolerance code. Tolerance : J=±5% , K=±10% , M=±20%

- Operating temperature range - 25°C ~ 125°C(Including self - temperature rise)
- Rated Current : Self temperature rise shall be limited to 35°C Max Inductance drop 10% typ.
- Measure Equipment :
L : Agilent HP4192A
SRF : Agilent HP4291A
RDC : Chroma 16502
Rate Current : HP4284A+HP42841A

Electrical Characteristics (LOW DCR Type)

| Part Number | Inductance (uH) | Tolerance (±%) | Test Frequency (MHz) | SRF (MHz) Min | RDC (Ω±30%) | Rated current (mA) |
|--------------------|-----------------|----------------|----------------------|---------------|-------------|--------------------|
| SQC322520LT-R15□-N | 0.15 | 20 | 1 | 400 | 0.028 | 1450 |
| SQC322520LT-R27□-N | 0.27 | 20 | 1 | 250 | 0.034 | 1250 |
| SQC322520LT-R47□-N | 0.47 | 20 | 1 | 150 | 0.042 | 1100 |
| SQC322520LT-1R0□-N | 1.0 | 20 | 1 | 100 | 0.060 | 1000 |
| SQC322520LT-1R5□-N | 1.5 | 20 | 1 | 85 | 0.085 | 900 |
| SQC322520LT-2R2□-N | 2.2 | 20 | 1 | 64 | 0.097 | 790 |
| SQC322520LT-3R3□-N | 3.3 | 20 | 1 | 55 | 0.13 | 700 |
| SQC322520LT-4R7□-N | 4.7 | 20 / 10 | 1 | 43 | 0.15 | 650 |
| SQC322520LT-6R8□-N | 6.8 | 20 | 1 | 30 | 0.21 | 600 |
| SQC322520LT-100□-N | 10 | 20 / 10 | 1 | 26 | 0.30 | 450 |

Note: When ordering, please specify tolerance code. Tolerance : K=±10% , M=±20%

- Operating temperature range - 40°C ~ 125°C(Including self - temperature rise)
- Rated Current : Self temperature rise shall be limited to 35°C Max Inductance drop 10% typ.
- Measure Equipment :
 L : Agilent HP4192A
 SRF : Agilent HP4291A
 RDC : Chroma 16502
 Rate Current : HP4284A+HP42841A

Electrical Characteristics

| Part Number | Inductance (uH) | Tolerance (±%) | Test Frequency (MHz) | SRF (MHz) Min | RDC (Ω) Max | Rated current (mA) |
|-------------------|-----------------|----------------|----------------------|---------------|-------------|--------------------|
| SQC453226T-1R0□-N | 1.0 | 20 | 1 | 100 | 0.08 | 1080 |
| SQC453226T-1R5□-N | 1.5 | 20 | 1 | 85 | 0.09 | 1000 |
| SQC453226T-1R8□-N | 1.8 | 20 | 1 | 65 | 0.10 | 900 |
| SQC453226T-2R2□-N | 2.2 | 20 / 10 | 1 | 60 | 0.11 | 900 |
| SQC453226T-3R3□-N | 3.3 | 20 | 1 | 47 | 0.13 | 800 |
| SQC453226T-4R7□-N | 4.7 | 20 / 10 | 1 | 35 | 0.15 | 750 |
| SQC453226T-6R8□-N | 6.8 | 20 / 10 | 1 | 30 | 0.20 | 720 |
| SQC453226T-100□-N | 10 | 20 / 10 / 5 | 1 | 23 | 0.24 | 650 |
| SQC453226T-150□-N | 15 | 20 / 10 / 5 | 1 | 20 | 0.32 | 570 |
| SQC453226T-220□-N | 22 | 20 / 10 / 5 | 1 | 15 | 0.60 | 420 |
| SQC453226T-330□-N | 33 | 20 / 10 / 5 | 1 | 12 | 1.0 | 310 |
| SQC453226T-470□-N | 47 | 20 / 10 / 5 | 1 | 10 | 1.1 | 280 |
| SQC453226T-680□-N | 68 | 20 / 10 / 5 | 1 | 8.4 | 1.7 | 220 |
| SQC453226T-101□-N | 100 | 20 / 10 / 5 | 1 | 6.8 | 2.2 | 190 |
| SQC453226T-151□-N | 150 | 20 / 10 / 5 | 1 | 5.5 | 3.5 | 130 |
| SQC453226T-221□-N | 220 | 20 / 10 / 5 | 1 | 4.5 | 4.0 | 110 |
| SQC453226T-331□-N | 330 | 20 / 10 / 5 | 1 | 3.6 | 6.8 | 100 |
| SQC453226T-471□-N | 470 | 20 / 10 / 5 | 1 | 3.0 | 8.5 | 90 |
| SQC453226T-561□-N | 560 | 20 / 10 / 5 | 0.001 | 2.5 | 10.4 | 80 |
| SQC453226T-681□-N | 680 | 20 / 10 / 5 | 0.001 | 2.2 | 14.7 | 70 |
| SQC453226T-821□-N | 820 | 20 / 10 / 5 | 0.001 | 2.0 | 20.0 | 60 |
| SQC453226T-102□-N | 1000 | 20 / 10 / 5 | 0.001 | 2.0 | 27.9 | 50 |
| SQC453226T-152□-N | 1500 | 20 / 10 / 5 | 0.001 | 1.8 | 35.0 | 40 |

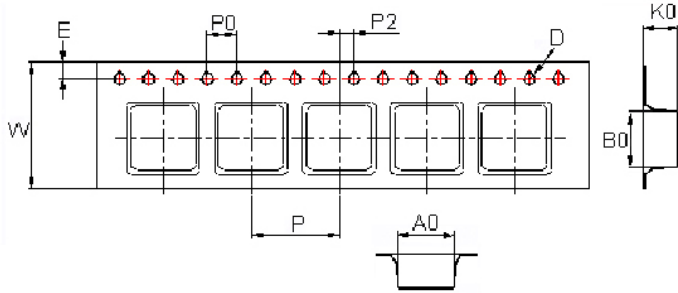
Note: When ordering, please specify tolerance code. Tolerance : J=±5% , K=±10% , M=±20%

- Operating temperature range - 40°C ~ 125°C(Including self - temperature rise)
- Rated Current : Self temperature rise shall be limited to 35°C Max Inductance drop 10% typ.
- Measure Equipment :
 L : Agilent HP4192A
 SRF : Agilent HP4291A
 RDC : Chroma 16502
 Rate Current : HP4284A+HP42841A

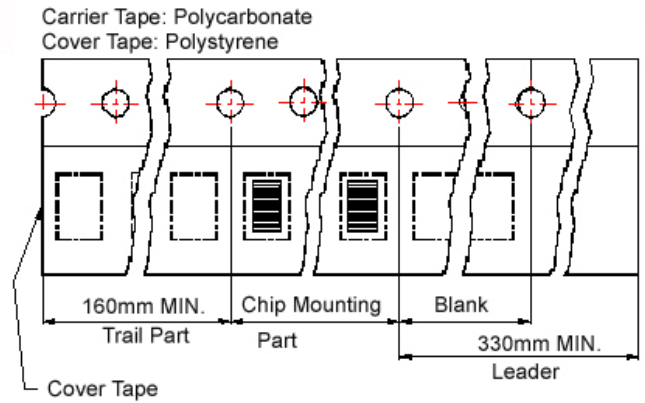
Please be sure to request approval specifications that provide further details of the products. Kindly note that the content of these specifications are subject to change or may be discontinued without advance notice. Please contact our sales department before ordering.

Packaging Specifications

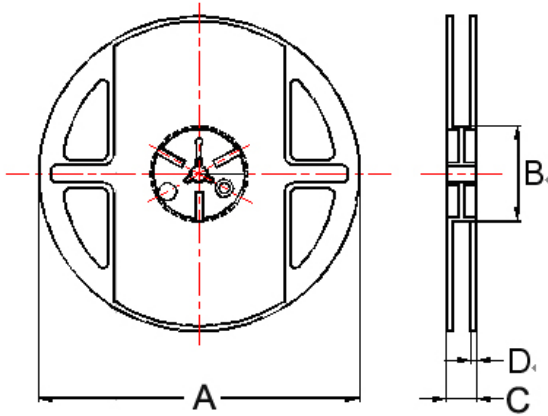
Tape Dimensions



Tape Material



Reel Dimensions



Dimensions in mm

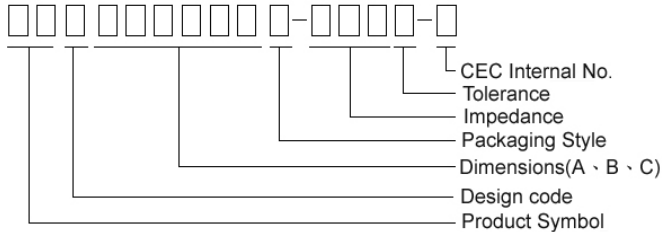
| TYPE | Tape Dimensions | | | | | | | | | Reel Dimensions | | | | Quantity |
|-------------|-----------------|------|------|------|------|----|---|----|----|-----------------|----|------|-----|------------|
| | A0 | B0 | K0 | D | E | W | P | P0 | P2 | A | B | C | D | PCS / REEL |
| SQC322517 | 2.85 | 3.56 | 1.80 | 1.55 | 1.75 | 8 | 4 | 4 | 2 | 178 | 60 | 9 | 1.5 | 2000 |
| SQC322517HP | 2.85 | 3.56 | 1.80 | 1.55 | 1.75 | 8 | 4 | 4 | 2 | 178 | 60 | 9 | 1.5 | 2000 |
| SQC322520 | 2.90 | 3.60 | 2.25 | 1.5 | 1.75 | 8 | 4 | 4 | 2 | 178 | 60 | 9 | 1.5 | 2000 |
| SQC322520LT | 2.90 | 3.60 | 2.25 | 1.5 | 1.75 | 8 | 4 | 4 | 2 | 178 | 60 | 9 | 1.5 | 2000 |
| SQC453226 | 3.60 | 4.90 | 3.00 | 1.5 | 1.75 | 12 | 8 | 4 | 2 | 178 | 60 | 13.2 | 1.5 | 500 |

Multilayer Ferrite Chip Beads



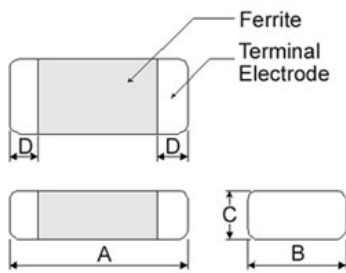
Chilisin offers a wide range of multi-layered ferrite chip beads with various sizes, frequency characteristics, and impedance values for EMI solutions. These ferrite formulas are used to compose seven types of EMI suppression chip beads: SB, GB, PB, UPB, NB, HF, and VPB series.

Product Identification

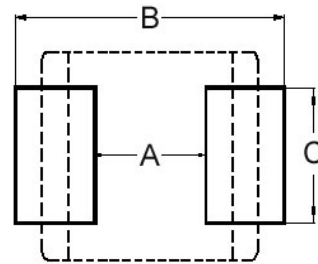


- Product symbol: SB, GB, PB, UPB, NB, HF, VPB
- Packaging: T : Tape and Reel ; B : Bulk
- Tolerance: Y = ± 25%; M = ± 20%; T:±30%
- Note: RoHS Compliant

Shape and Dimensions



Recommended Pattern



Dimensions in mm

| TYPE | A | B | C | D |
|---------|----------|-----------|----------|-----------|
| ①060303 | 0.6±0.03 | 0.30±0.03 | 0.3±0.03 | 0.15±0.05 |
| ②100505 | 1.0±0.10 | 0.50±0.10 | 0.5±0.10 | 0.25±0.10 |
| ③160805 | 1.6±0.15 | 0.80±0.15 | 0.5±0.15 | 0.3±0.2 |
| ④160808 | 1.6±0.15 | 0.80±0.15 | 0.8±0.15 | 0.3±0.2 |
| ⑤201209 | 2.0±0.20 | 1.25±0.20 | 0.9±0.20 | 0.5±0.3 |
| ⑥321611 | 3.2±0.20 | 1.60±0.20 | 1.1±0.20 | 0.5±0.3 |

- ① : SBY / SBJ / NB / PB ② : SBY / SBJ / NB / PB / UPB / HF
 ③ : UPB ④ : SBK / SBJ / GB / PB / NB / UPB / VPB
 ⑤ : SBK / GB / PB / UPB ⑥ : SBY / SBK / PB / UPB

Dimensions in mm

| TYPE | A | B | C |
|---------|-----------|-------------|-----------|
| ①060303 | 0.2 ~ 0.3 | 0.75 ~ 1.05 | 0.3 |
| ②100505 | 0.4 | 1.2 ~ 1.4 | 0.5 |
| ③160805 | 0.7 ~ 0.8 | 1.8 ~ 2.0 | 0.6 ~ 0.8 |
| ④160808 | 0.7 ~ 0.8 | 1.8 ~ 2.0 | 0.6 ~ 0.8 |
| ⑤201209 | 1.0 ~ 1.2 | 2.6 ~ 4.0 | 1.0 ~ 1.2 |
| ⑥321611 | 2.0 | 4.2 ~ 5.2 | 1.2 |

- * Don't apply narrower pattern than listed above to PB and UPB. Narrow pattern might cause excessive heat or open circuit.

Dimension Conversion

| Code | Dimension in mm (AxBxC) | EIA |
|--------|----------------------------|------|
| 060303 | 0.6X0.3X0.3 | 0201 |
| 100505 | 1.0X0.5X0.5 | 0402 |
| 160805 | 1.6x0.8x0.5 | 0603 |
| 160808 | 1.6x0.8x0.8 | 0603 |
| 201209 | 2.0x1.2x0.9 | 0805 |
| 321611 | 3.2x1.6x1.1 | 1206 |

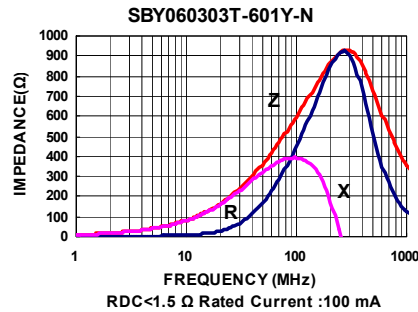
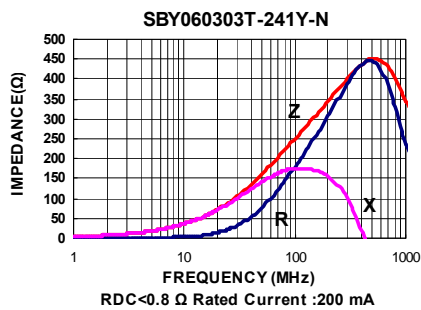
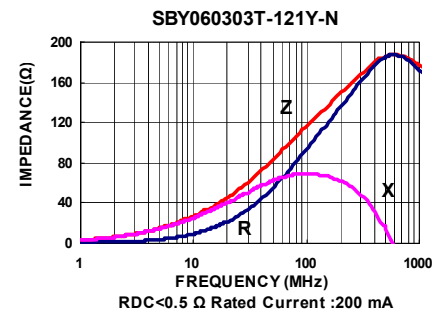
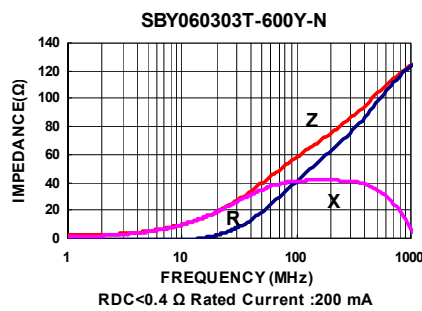
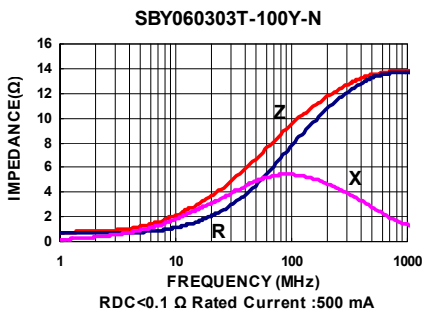
Electrical Characteristics

| Part Number | Impedance ($\Omega \pm 25\%$) | Test Frequency (MHz) | RDC (Ω) Max | Rated current (mA) Max |
|-------------------|------------------------------------|-------------------------|-------------------------|---------------------------|
| SBY060303T-100Y-N | 10 | 100 | 0.1 | 500 |
| SBY060303T-600Y-N | 60 | 100 | 0.4 | 200 |
| SBY060303T-121Y-N | 120 | 100 | 0.5 | 200 |
| SBY060303T-241Y-N | 240 | 100 | 0.8 | 200 |
| SBY060303T-601Y-N | 600 | 100 | 1.5 | 100 |

Note: When ordering, please specify tolerance code. Tolerance : Y=±25%

- Operating temperature range - 55°C ~ 125°C(Including self - temperature rise)
- Rate Current : Applied the current to coils, the temperature rise shall not be more than 30°C
- Measure Equipment :
Z : HP4291A
RDC : HP4338B or CHEN HWA 502

Test Instruments : Agilent E4991A Impedance / Material Analyzer



Please be sure to request approval specifications that provide further details of the products. Kindly note that the content of these specifications are subject to change or may be discontinued without advance notice. Please contact our sales department before ordering.

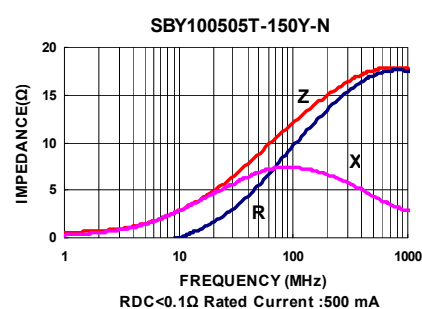
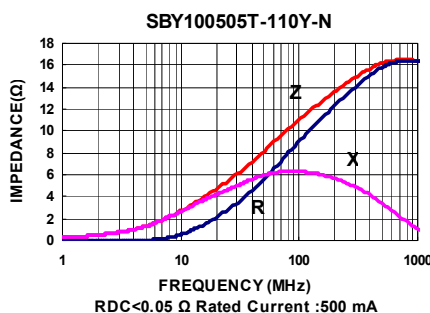
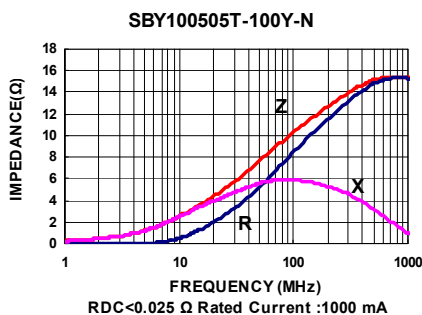
Electrical Characteristics

| Part Number | Impedance ($\Omega \pm 25\%$) | Test Frequency (MHz) | RDC (Ω) Max | Rated current (mA) Max |
|-------------------|------------------------------------|-------------------------|-------------------------|---------------------------|
| SBY100505T-100Y-N | 10 | 100 | 0.025 | 1000 |
| SBY100505T-110Y-N | 11 | 100 | 0.05 | 500 |
| SBY100505T-150Y-N | 15 | 100 | 0.10 | 500 |
| SBY100505T-190Y-N | 19 | 100 | 0.10 | 500 |
| SBY100505T-220Y-N | 22 | 100 | 0.15 | 500 |
| SBY100505T-300Y-N | 30 | 100 | 0.20 | 500 |
| SBY100505T-320Y-N | 32 | 100 | 0.20 | 500 |
| SBY100505T-330Y-N | 33 | 100 | 0.20 | 500 |
| SBY100505T-400Y-N | 40 | 100 | 0.20 | 500 |
| SBY100505T-470Y-N | 47 | 100 | 0.20 | 500 |
| SBY100505T-500Y-N | 50 | 100 | 0.20 | 500 |
| SBY100505T-600Y-N | 60 | 100 | 0.20 | 500 |
| SBY100505T-700Y-N | 70 | 100 | 0.15 | 600 |
| SBY100505T-750Y-N | 75 | 100 | 0.20 | 500 |
| SBY100505T-800Y-N | 80 | 100 | 0.20 | 500 |
| SBY100505T-900Y-N | 90 | 100 | 0.25 | 500 |
| SBY100505T-101Y-N | 100 | 100 | 0.25 | 500 |
| SBY100505T-121Y-N | 120 | 100 | 0.19 | 550 |
| SBY100505T-151Y-N | 150 | 100 | 0.40 | 400 |
| SBY100505T-181Y-N | 180 | 100 | 0.40 | 400 |
| SBY100505T-221Y-N | 220 | 100 | 0.29 | 450 |
| SBY100505T-241Y-N | 240 | 100 | 0.40 | 400 |
| SBY100505T-301Y-N | 300 | 100 | 0.50 | 300 |
| SBY100505T-331Y-N | 330 | 100 | 0.50 | 300 |
| SBY100505T-471Y-N | 470 | 100 | 0.50 | 300 |
| SBY100505T-481Y-N | 480 | 100 | 0.50 | 300 |
| SBY100505T-601Y-N | 600 | 100 | 0.52 | 300 |
| SBY100505T-102Y-N | 1000 | 100 | 0.65 | 300 |
| SBY100505T-182Y-N | 1800 | 100 | 1.40 | 100 |
| SBY100505T-222Y-N | 2200 | 100 | 1.40 | 100 |

Note: When ordering, please specify tolerance code. Tolerance : Y \pm 25%

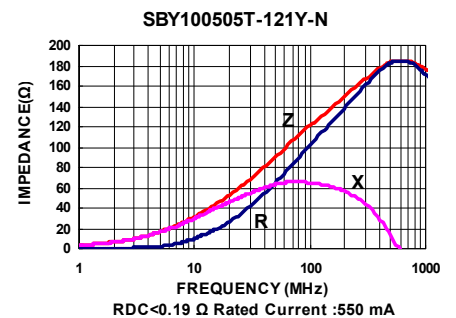
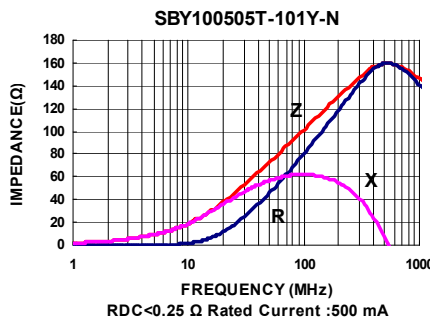
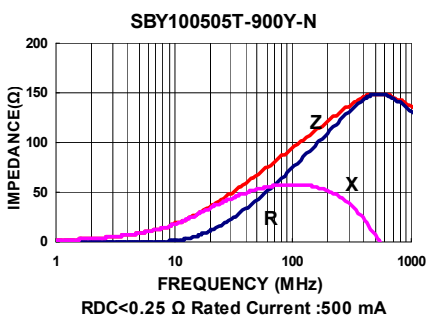
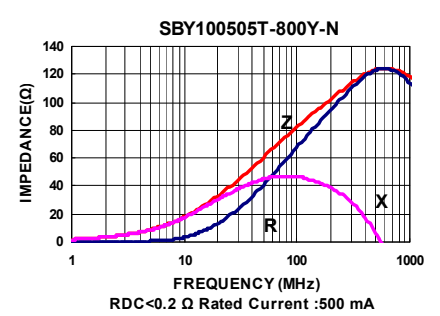
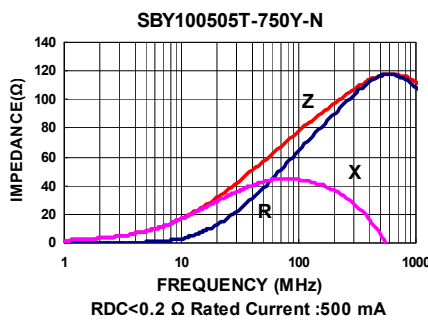
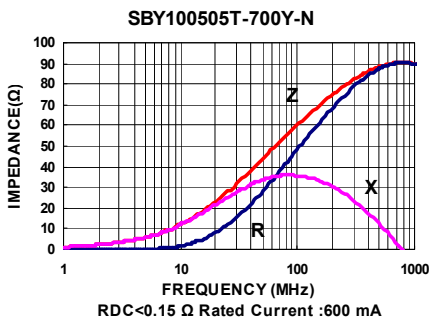
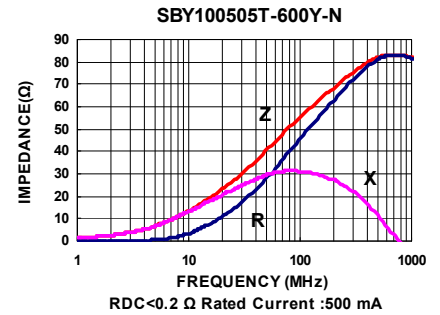
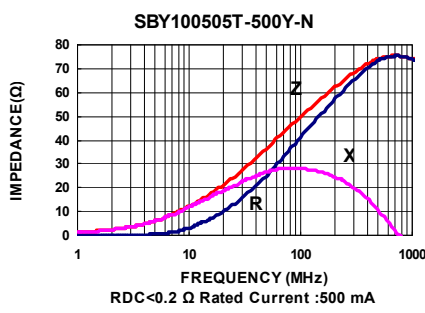
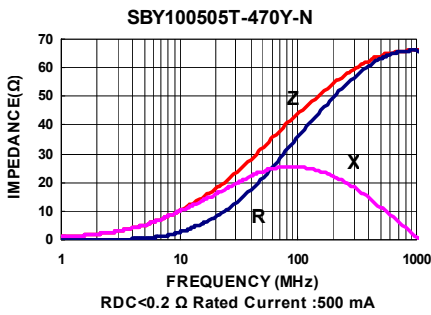
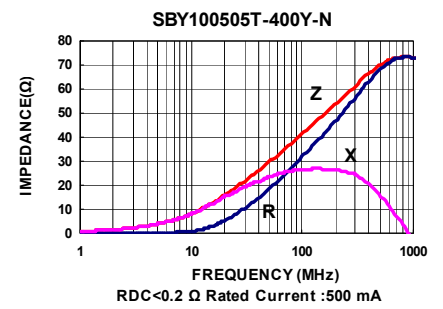
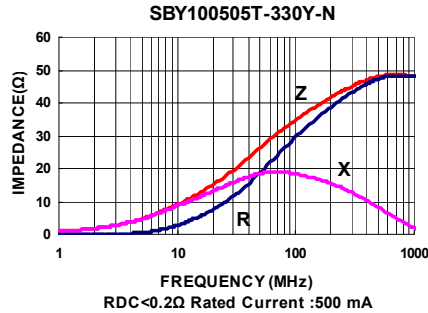
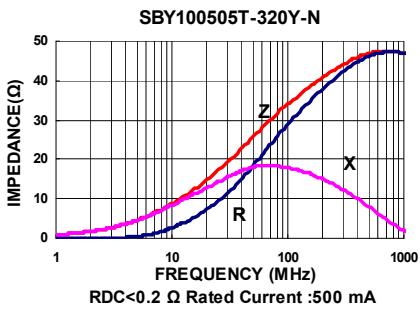
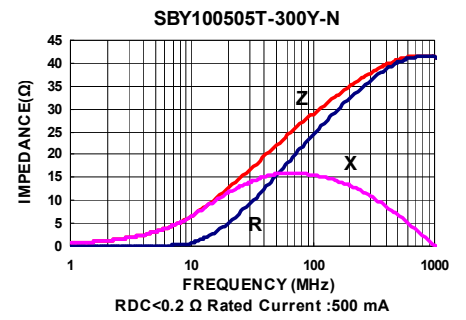
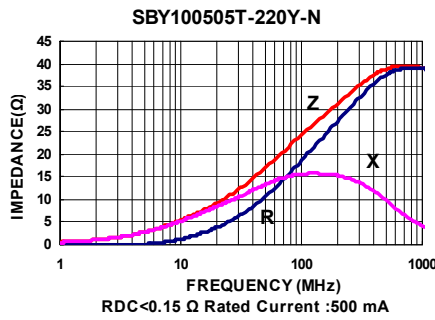
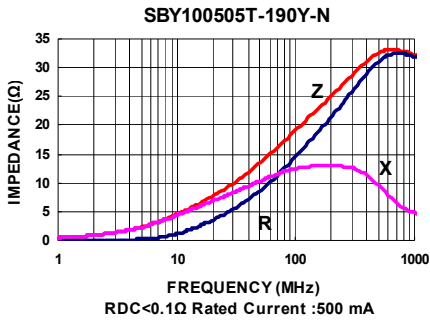
- Operating temperature range - 55°C ~ 125°C(Including self - temperature rise)
- Rate Current : Applied the current to coils, the temperature rise shall not be more than 30°C
- Measure Equipment :
Z : HP4291A
RDC : HP4338B or CHEN HWA 502

Test Instruments : Agilent E4991A Impedance / Material Analyzer



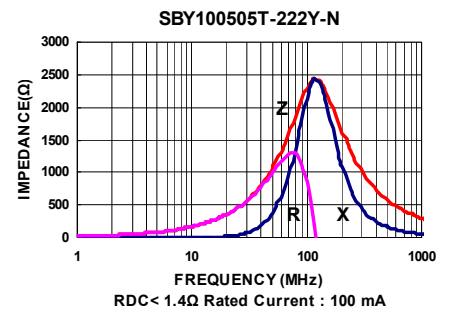
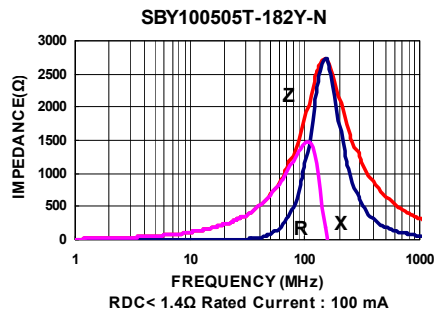
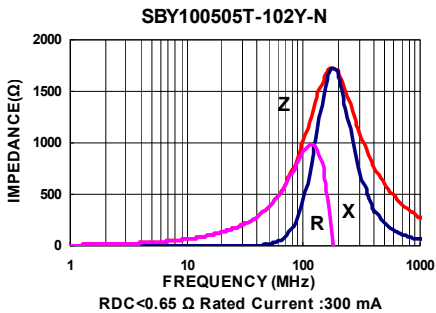
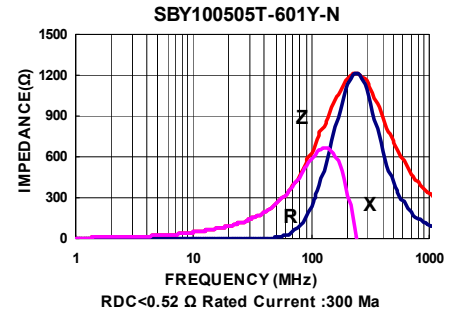
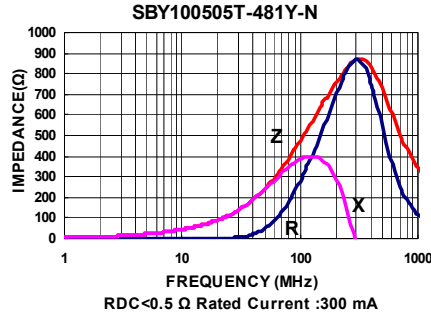
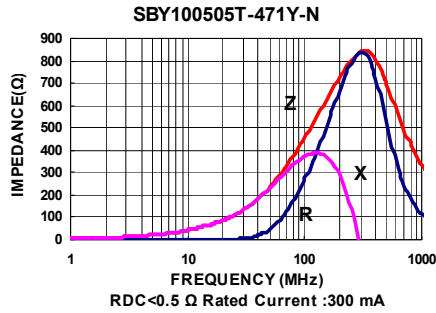
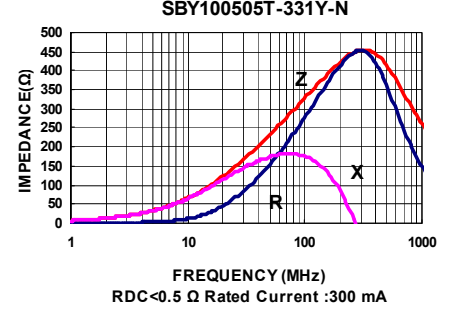
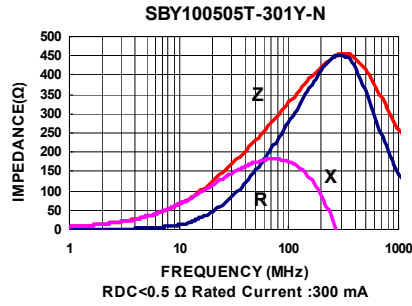
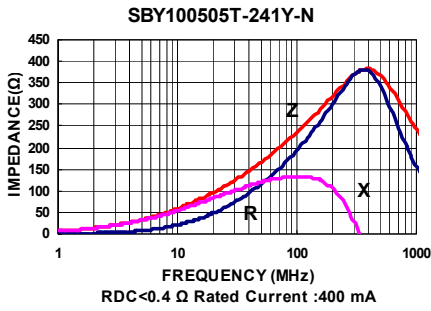
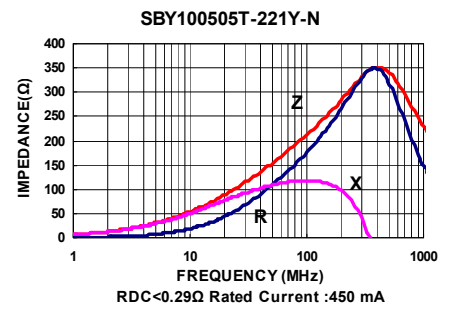
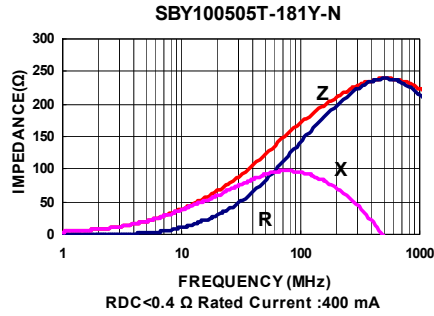
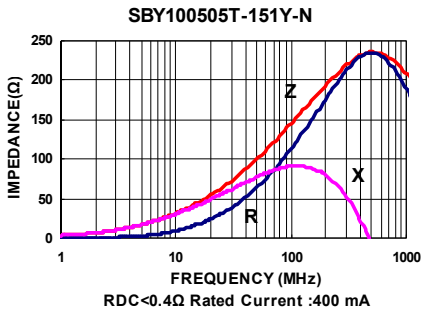
Please be sure to request approval specifications that provide further details of the products. Kindly note that the content of these specifications are subject to change or may be discontinued without advance notice. Please contact our sales department before ordering.

Test Instruments : Agilent E4991A Impedance / Material Analyzer



Please be sure to request approval specifications that provide further details of the products. Kindly note that the content of these specifications are subject to change or may be discontinued without advance notice. Please contact our sales department before ordering.

Test Instruments : Agilent E4991A Impedance / Material Analyzer



Please be sure to request approval specifications that provide further details of the products. Kindly note that the content of these specifications are subject to change or may be discontinued without advance notice. Please contact our sales department before ordering.

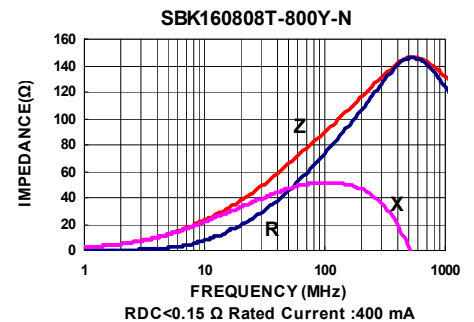
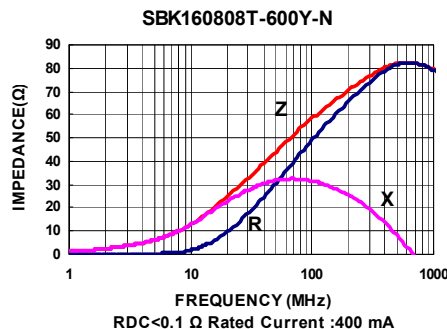
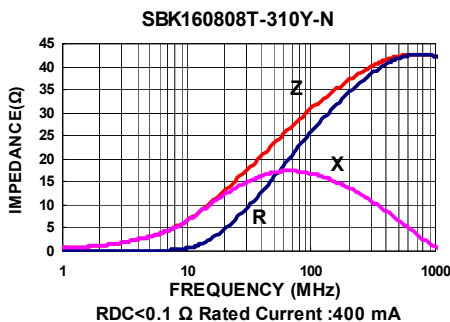
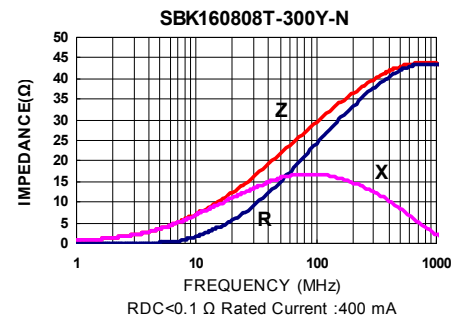
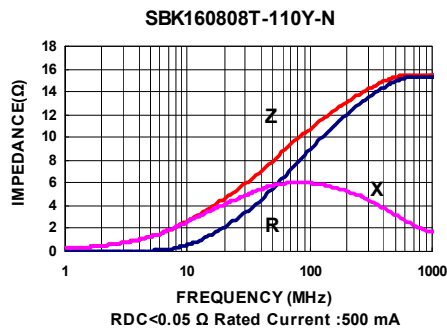
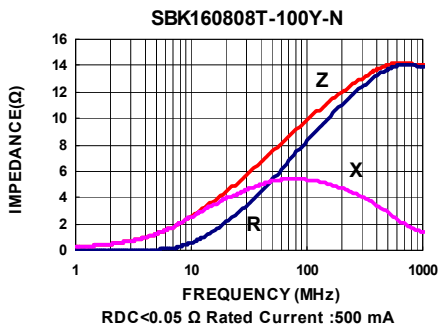
Electrical Characteristics

| Part Number | Impedance ($\Omega \pm 25\%$) | Test Frequency (MHz) | RDC (Ω) Max | Rated current (mA) Max |
|-------------------|------------------------------------|-------------------------|-------------------------|---------------------------|
| SBK160808T-100Y-N | 10 | 100 | 0.05 | 500 |
| SBK160808T-110Y-N | 11 | 100 | 0.05 | 500 |
| SBK160808T-300Y-N | 30 | 100 | 0.10 | 400 |
| SBK160808T-310Y-N | 31 | 100 | 0.10 | 400 |
| SBK160808T-600Y-N | 60 | 100 | 0.10 | 400 |
| SBK160808T-800Y-N | 80 | 100 | 0.15 | 400 |
| SBK160808T-121Y-N | 120 | 100 | 0.25 | 400 |
| SBK160808T-221Y-N | 220 | 100 | 0.30 | 300 |
| SBK160808T-301Y-N | 300 | 100 | 0.40 | 300 |
| SBK160808T-471Y-N | 470 | 100 | 0.50 | 300 |
| SBK160808T-601Y-N | 600 | 100 | 0.50 | 300 |
| SBK160808T-102Y-N | 1000 | 100 | 0.60 | 300 |
| SBK160808T-152Y-N | 1500 | 100 | 0.60 | 300 |
| SBK160808T-182Y-N | 1800 | 100 | 0.80 | 200 |
| SBK160808T-202Y-N | 2000 | 100 | 0.80 | 200 |
| SBK160808T-222Y-N | 2200 | 100 | 0.80 | 200 |
| SBK160808T-252Y-N | 2500 | 100 | 0.80 | 200 |
| SBK160808T-272Y-N | 2700 | 100 | 0.80 | 200 |

Note: When ordering, please specify tolerance code. Tolerance : Y=±25%

- Operating temperature range - 55°C ~ 125°C(Including self - temperature rise)
- Rate Current : Applied the current to coils, the temperature rise shall not be more than 30°C
- Measure Equipment :
Z : HP4291A
RDC : HP4338B or CHEN HWA 502

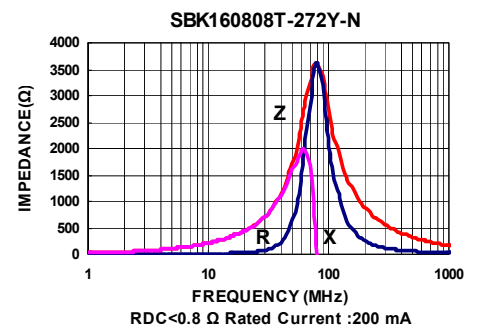
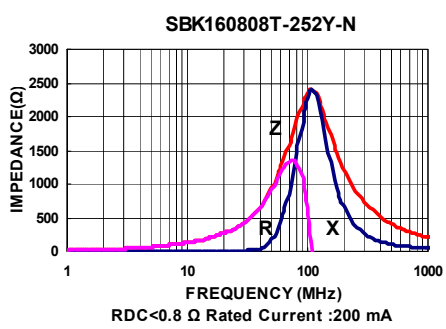
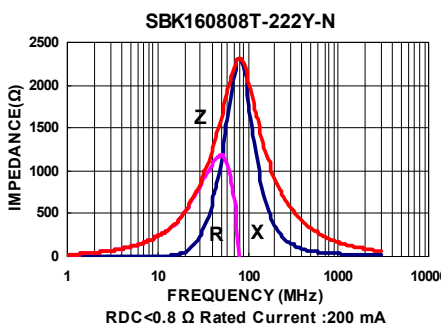
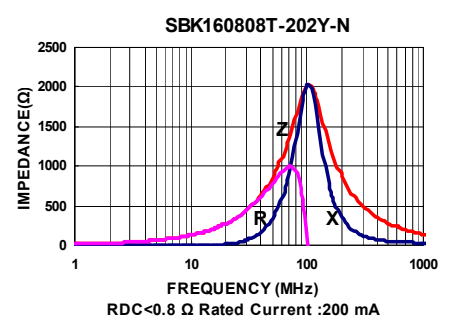
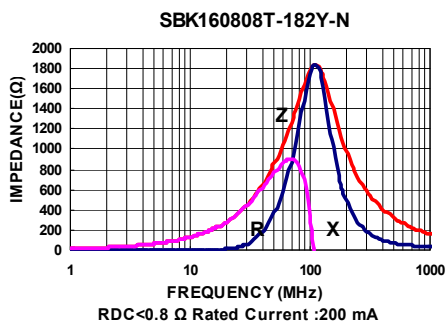
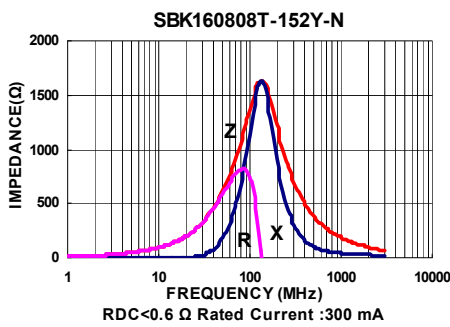
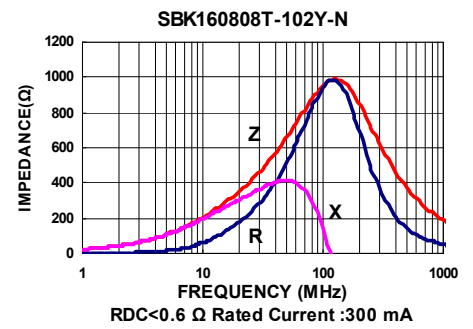
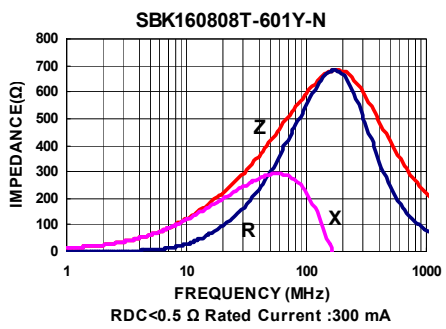
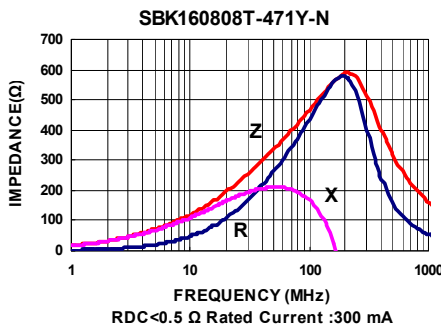
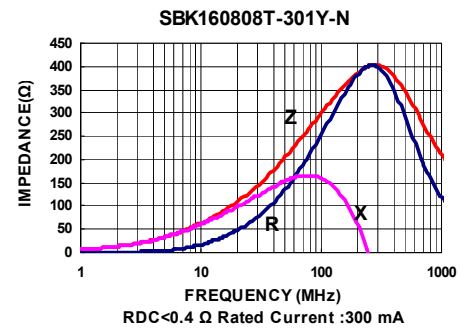
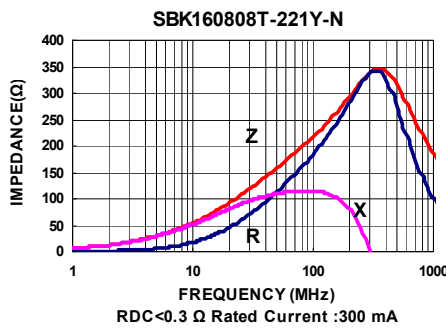
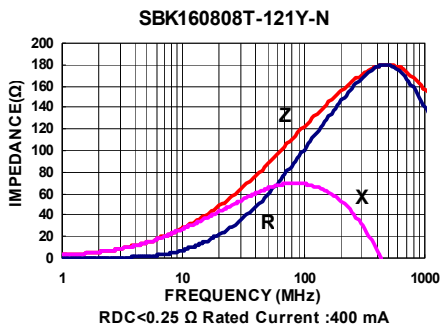
Test Instruments : Agilent E4991A Impedance / Material Analyzer



Please be sure to request approval specifications that provide further details of the products. Kindly note that the content of these specifications are subject to change or may be discontinued without advance notice. Please contact our sales department before ordering.

SMD Multilayer Ferrite Chip Beads – SBY/SBK Series

Test Instruments : Agilent E4991A Impedance / Material Analyzer



Please be sure to request approval specifications that provide further details of the products. Kindly note that the content of these specifications are subject to change or may be discontinued without advance notice. Please contact our sales department before ordering.

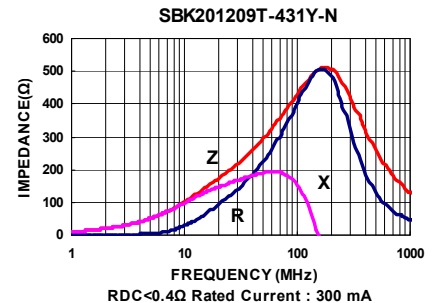
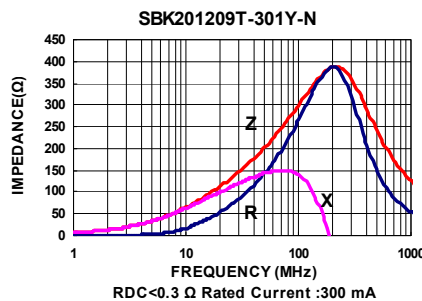
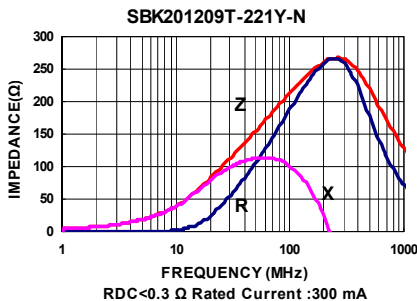
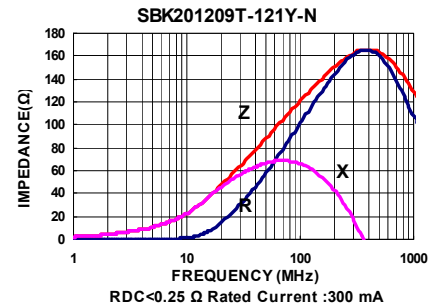
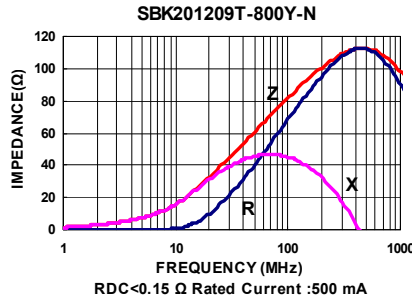
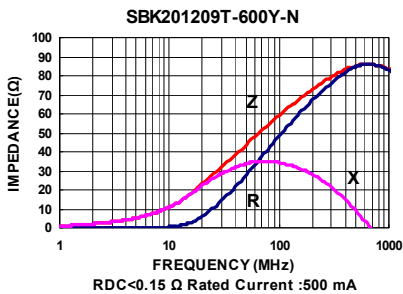
Electrical Characteristics

| Part Number | Impedance ($\Omega \pm 25\%$) | Test Frequency (MHz) | DC Resistance (Ω) Max | Rated current (mA) Max |
|-------------------|------------------------------------|-------------------------|-----------------------------------|---------------------------|
| SBK201209T-600Y-N | 60 | 100 | 0.15 | 500 |
| SBK201209T-800Y-N | 80 | 100 | 0.15 | 500 |
| SBK201209T-121Y-N | 120 | 100 | 0.25 | 300 |
| SBK201209T-221Y-N | 220 | 100 | 0.30 | 300 |
| SBK201209T-301Y-N | 300 | 100 | 0.30 | 300 |
| SBK201209T-431Y-N | 430 | 100 | 0.40 | 300 |
| SBK201209T-471Y-N | 470 | 100 | 0.40 | 300 |
| SBK201209T-601Y-N | 600 | 100 | 0.40 | 300 |
| SBK201209T-102Y-N | 1000 | 100 | 0.50 | 200 |
| SBK201209T-122Y-N | 1200 | 100 | 0.60 | 200 |
| SBK201209T-152Y-N | 1500 | 100 | 0.60 | 200 |
| SBK201209T-202Y-N | 2000 | 100 | 0.70 | 200 |
| SBK201209T-222Y-N | 2200 | 100 | 0.70 | 200 |
| SBK201209T-252Y-N | 2500 | 100 | 0.70 | 200 |
| SBK201209T-272Y-N | 2700 | 100 | 0.70 | 200 |

Note: When ordering, please specify tolerance code. Tolerance : Y= $\pm 25\%$

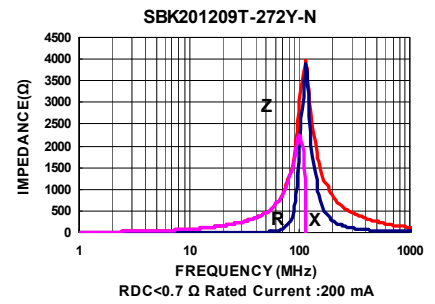
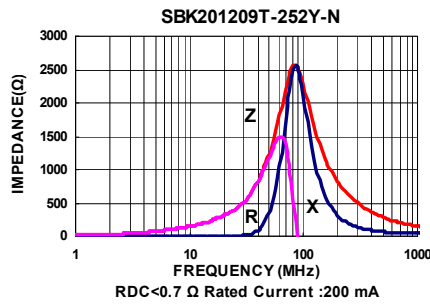
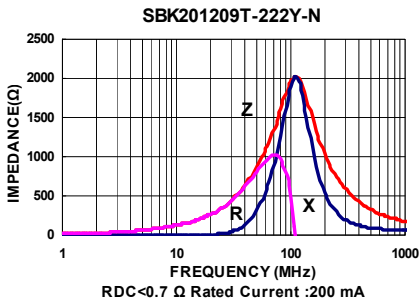
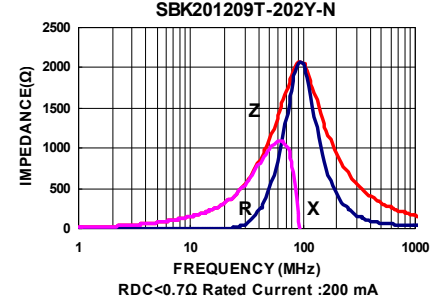
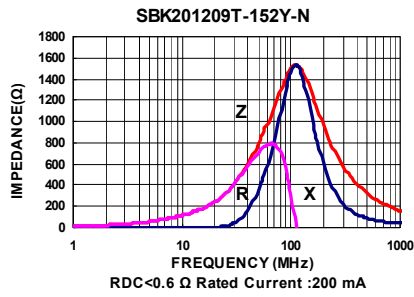
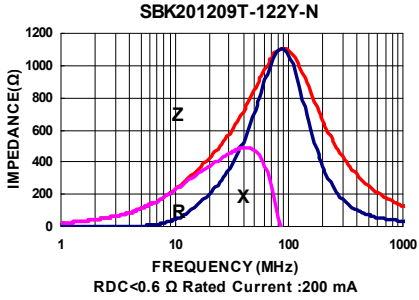
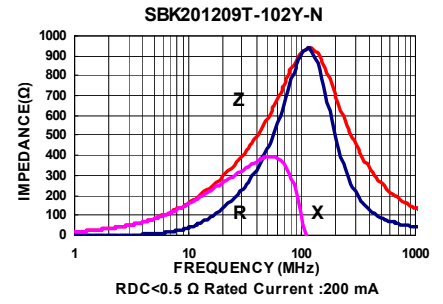
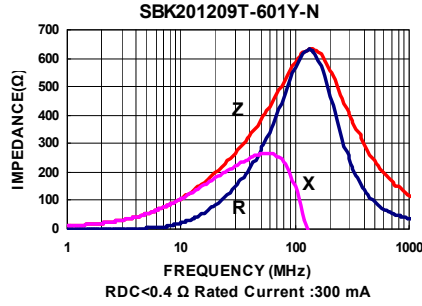
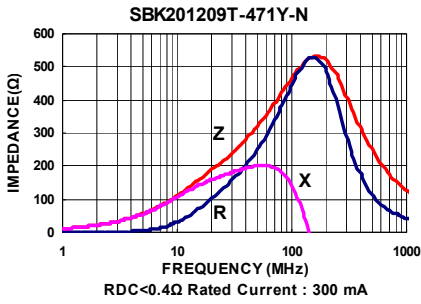
- Operating temperature range - 55°C ~ 125°C(Including self - temperature rise)
- Rate Current : Applied the current to coils, the temperature rise shall not be more than 30°C
- Measure Equipment :
Z : HP4291A
RDC : HP4338B or CHEN HWA 502

Test Instruments : Agilent E4991A Impedance / Material Analyzer



Please be sure to request approval specifications that provide further details of the products. Kindly note that the content of these specifications are subject to change or may be discontinued without advance notice. Please contact our sales department before ordering.

Test Instruments : Agilent E4991A Impedance / Material Analyzer



Please be sure to request approval specifications that provide further details of the products. Kindly note that the content of these specifications are subject to change or may be discontinued without advance notice. Please contact our sales department before ordering.

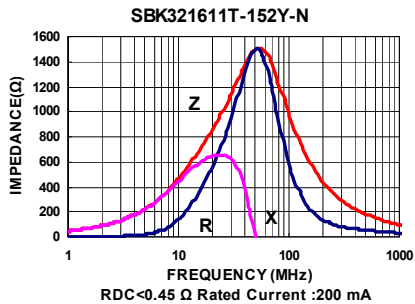
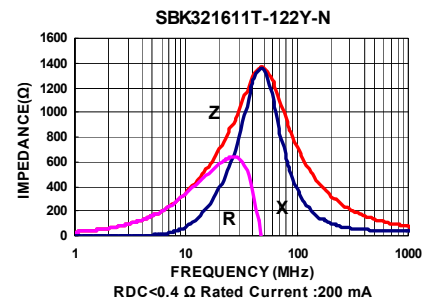
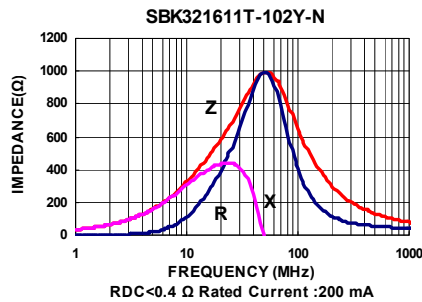
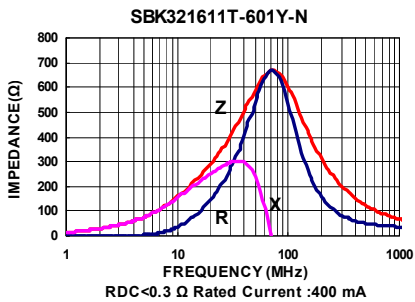
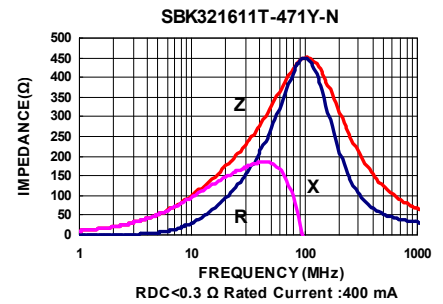
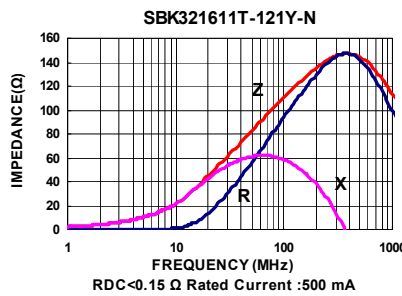
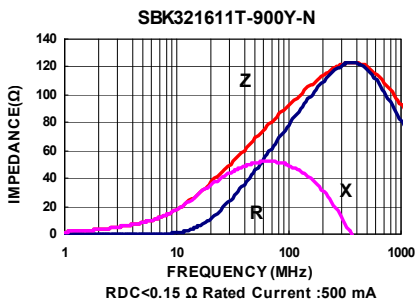
Electrical Characteristics

| Part Number | Impedance ($\Omega \pm 25\%$) | Test Frequency (MHz) | RDC (Ω) Max | Rated current (mA) Max |
|-------------------|------------------------------------|-------------------------|-------------------------|---------------------------|
| SBK321611T-900Y-N | 90 | 100 | 0.15 | 500 |
| SBK321611T-121Y-N | 120 | 100 | 0.15 | 500 |
| SBK321611T-471Y-N | 470 | 100 | 0.20 | 400 |
| SBK321611T-601Y-N | 600 | 100 | 0.30 | 400 |
| SBK321611T-102Y-N | 1000 | 50 | 0.40 | 200 |
| SBK321611T-122Y-N | 1200 | 50 | 0.40 | 200 |
| SBK321611T-152Y-N | 1500 | 50 | 0.45 | 200 |

Note: When ordering, please specify tolerance code. Tolerance : Y $\pm 25\%$

- Operating temperature range - 55°C ~ 125°C(Including self - temperature rise)
- Rate Current : Applied the current to coils, the temperature rise shall not be more than 30°C
- Measure Equipment :
Z : HP4291A
RDC : HP4338B or CHEN HWA 502

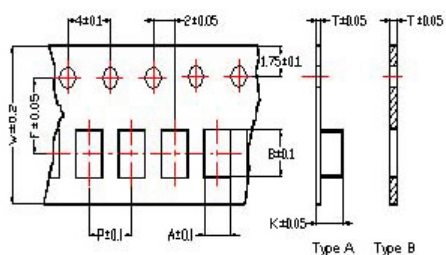
Test Instruments : Agilent E4991A Impedance / Material Analyzer



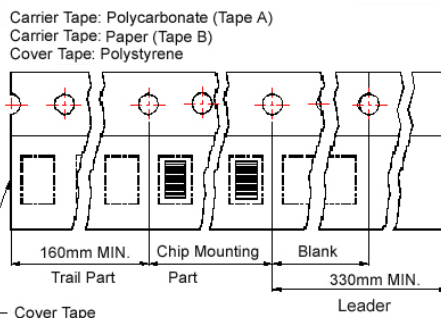
Please be sure to request approval specifications that provide further details of the products. Kindly note that the content of these specifications are subject to change or may be discontinued without advance notice. Please contact our sales department before ordering.

Packaging Specifications

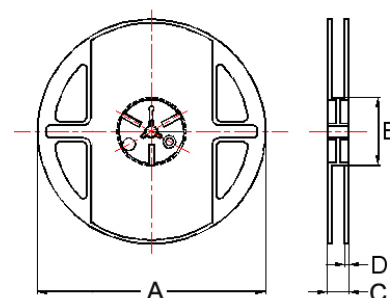
Tape Dimensions



Tape Material



Reel Dimensions



- ① : SBY / SBJ / NB / PB
- ② : SBY / SBJ / NB / PB / UPB / HF ③ : UPB
- ④ : SBK / SBJ / GB / PB / NB / UPB / VPB
- ⑤ : SBK / GB / PB / UPB ⑥ : SBY / SBK / PBY / UPB

Dimensions in mm

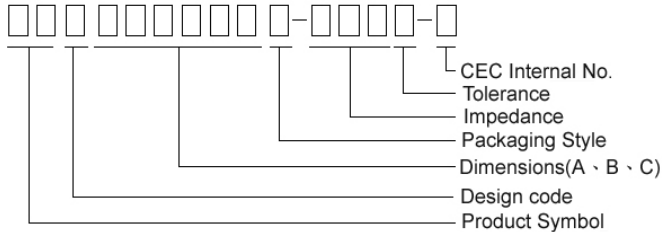
| TYPE | Tape Dimensions | | | | | | | | Reel Dimensions | | | | Quantity PCS / REEL |
|---------|-----------------|------|------|-----|-----|-----|------|------|-----------------|----|----|---|------------------------|
| | A | B | T | W | P | F | K | Tape | A | B | C | D | |
| ①060303 | 0.37 | 0.67 | 0.42 | 8.0 | 2.0 | 3.5 | - | B | 178 | 60 | 10 | 2 | 15000 |
| ②100505 | 0.62 | 1.12 | 0.60 | 8.0 | 2.0 | 3.5 | - | B | 178 | 60 | 12 | 2 | 10000 |
| ③160805 | 1.05 | 1.85 | 0.60 | 8.0 | 2.0 | 3.5 | - | B | 178 | 60 | 12 | 2 | 10000 |
| ④160808 | 1.05 | 1.85 | 0.95 | 8.0 | 4.0 | 3.5 | - | B | 178 | 60 | 12 | 2 | 4000 |
| ⑤201209 | 1.50 | 2.30 | 0.97 | 8.0 | 4.0 | 3.5 | - | B | 178 | 60 | 12 | 2 | 4000 |
| ⑥321611 | 1.88 | 3.50 | 0.22 | 8.0 | 4.0 | 3.5 | 1.27 | A | 178 | 60 | 12 | 2 | 3000 |

Multilayer Ferrite Chip Beads



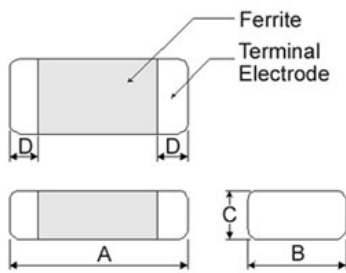
Chilisin offers a wide range of multi-layered ferrite chip beads with various sizes, frequency characteristics, and impedance values for EMI solutions. These ferrite formulas are used to compose seven types of EMI suppression chip beads: SB, GB, PB, UPB, NB, HF, and VPB series.

Product Identification

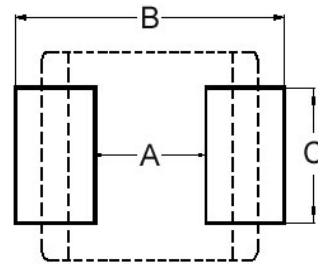


- Product symbol: SB, GB, PB, UPB, NB, HF, VPB
- Packaging: T : Tape and Reel ; B : Bulk
- Tolerance: Y = $\pm 25\%$; M = $\pm 20\%$; T: $\pm 30\%$
- Note: RoHS Compliant

Shape and Dimensions



Recommended Pattern



Dimensions in mm

| TYPE | A | B | C | D |
|---------|----------------|-----------------|----------------|-----------------|
| ①060303 | 0.6 \pm 0.03 | 0.30 \pm 0.03 | 0.3 \pm 0.03 | 0.15 \pm 0.05 |
| ②100505 | 1.0 \pm 0.10 | 0.50 \pm 0.10 | 0.5 \pm 0.10 | 0.25 \pm 0.10 |
| ③160805 | 1.6 \pm 0.15 | 0.80 \pm 0.15 | 0.5 \pm 0.15 | 0.3 \pm 0.2 |
| ④160808 | 1.6 \pm 0.15 | 0.80 \pm 0.15 | 0.8 \pm 0.15 | 0.3 \pm 0.2 |
| ⑤201209 | 2.0 \pm 0.20 | 1.25 \pm 0.20 | 0.9 \pm 0.20 | 0.5 \pm 0.3 |
| ⑥321611 | 3.2 \pm 0.20 | 1.60 \pm 0.20 | 1.1 \pm 0.20 | 0.5 \pm 0.3 |

① : SBY / SBJ / NB / PB ② : SBY / SBJ / NB / PB / UPB / HF
 ③ : UPB ④ : SBK / SBJ / GB / PB / NB / UPB / VPB
 ⑤ : SBK / GB / PB / UPB ⑥ : SBY / SBK / PB / UPB

Dimensions in mm

| TYPE | A | B | C |
|---------|-----------|-------------|-----------|
| ①060303 | 0.2 ~ 0.3 | 0.75 ~ 1.05 | 0.3 |
| ②100505 | 0.4 | 1.2 ~ 1.4 | 0.5 |
| ③160805 | 0.7 ~ 0.8 | 1.8 ~ 2.0 | 0.6 ~ 0.8 |
| ④160808 | 0.7 ~ 0.8 | 1.8 ~ 2.0 | 0.6 ~ 0.8 |
| ⑤201209 | 1.0 ~ 1.2 | 2.6 ~ 4.0 | 1.0 ~ 1.2 |
| ⑥321611 | 2.0 | 4.2 ~ 5.2 | 1.2 |

* Don't apply narrower pattern than listed above to PB and UPB. Narrow pattern might cause excessive heat or open circuit.

Dimension Conversion

| Code | Dimension in mm (AxBxC) | EIA |
|--------|----------------------------|------|
| 060303 | 0.6X0.3X0.3 | 0201 |
| 100505 | 1.0X0.5X0.5 | 0402 |
| 160805 | 1.6x0.8x0.5 | 0603 |
| 160808 | 1.6x0.8x0.8 | 0603 |
| 201209 | 2.0x1.2x0.9 | 0805 |
| 321611 | 3.2x1.6x1.1 | 1206 |

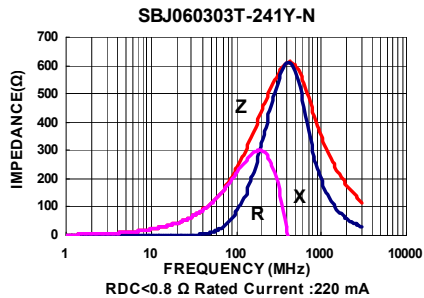
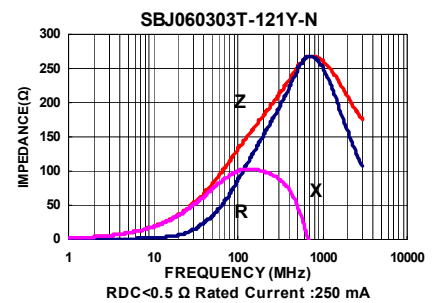
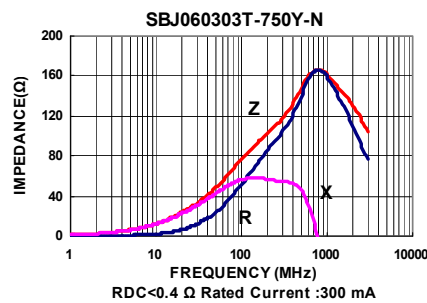
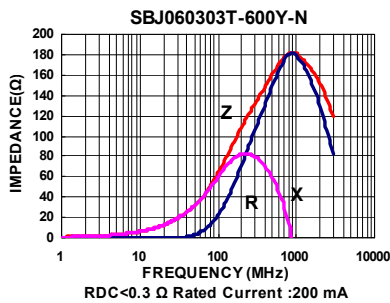
Electrical Characteristics

| Part Number | Impedance ($\Omega \pm 25\%$) | Test Frequency (MHz) | RDC (Ω) Max | Rated current (mA) Max |
|-------------------|------------------------------------|-------------------------|-------------------------|---------------------------|
| SBJ060303T-600Y-N | 60 | 100 | 0.3 | 200 |
| SBJ060303T-750Y-N | 75 | 100 | 0.4 | 300 |
| SBJ060303T-121Y-N | 120 | 100 | 0.5 | 250 |
| SBJ060303T-241Y-N | 240 | 100 | 0.8 | 220 |

Note: When ordering, please specify tolerance code. Tolerance : Y= $\pm 25\%$

- Operating temperature range - 55°C ~ 125°C(Including self - temperature rise)
- Rate Current : Applied the current to coils, the temperature rise shall not be more than 30°C
- Measure Equipment :
Z : HP4291A
RDC : HP4338B or CHEN HWA 502

Test Instruments : Agilent E4991A Impedance / Material Analyzer



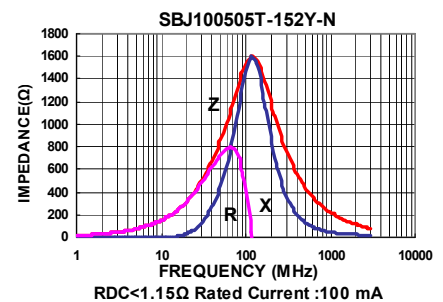
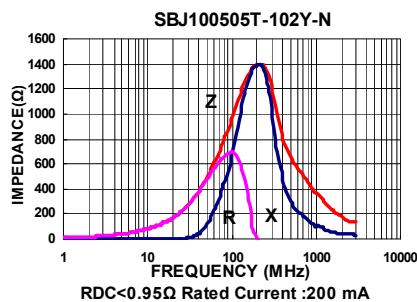
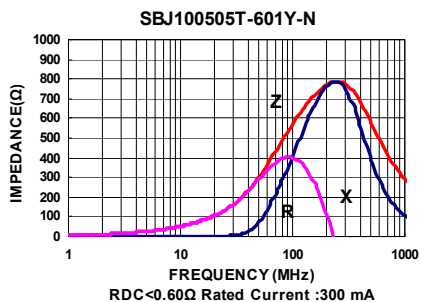
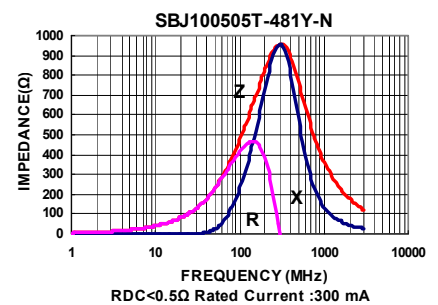
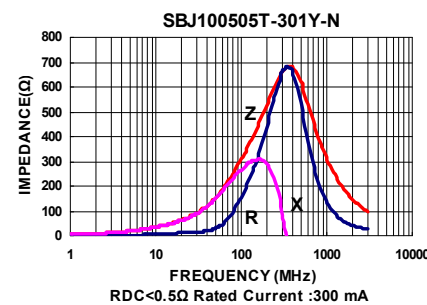
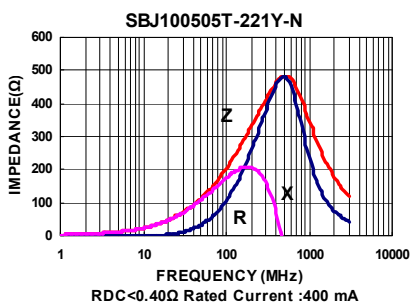
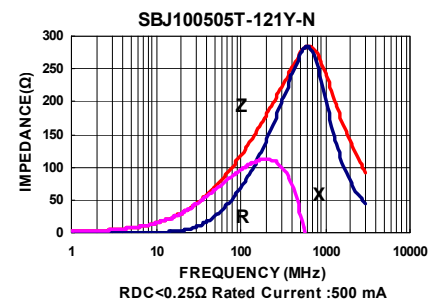
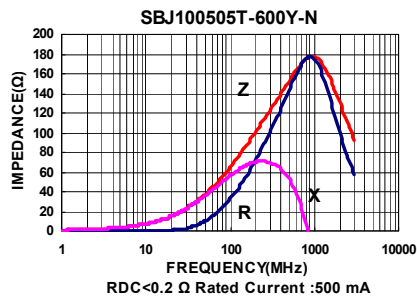
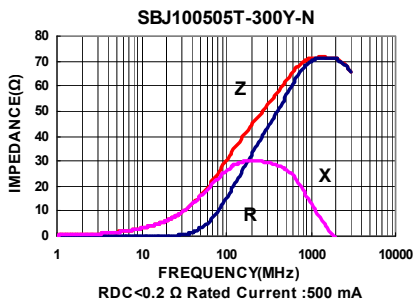
Electrical Characteristics

| Part Number | Impedance ($\Omega \pm 25\%$) | Test Frequency (MHz) | RDC (Ω) Max | Rated current (mA) Max |
|-------------------|------------------------------------|-------------------------|-------------------------|---------------------------|
| SBJ100505T-300Y-N | 30 | 100 | 0.20 | 500 |
| SBJ100505T-600Y-N | 60 | 100 | 0.20 | 500 |
| SBJ100505T-121Y-N | 120 | 100 | 0.25 | 500 |
| SBJ100505T-221Y-N | 220 | 100 | 0.40 | 400 |
| SBJ100505T-301Y-N | 300 | 100 | 0.50 | 300 |
| SBJ100505T-481Y-N | 480 | 100 | 0.50 | 300 |
| SBJ100505T-601Y-N | 600 | 100 | 0.60 | 300 |
| SBJ100505T-102Y-N | 1000 | 100 | 0.95 | 200 |
| SBJ100505T-152Y-N | 1500 | 100 | 1.15 | 100 |
| SBJ100505T-182Y-N | 1800 | 100 | 1.40 | 100 |
| SBJ100505T-252Y-N | 2500 | 100 | 1.80 | 100 |

Note: When ordering, please specify tolerance code. Tolerance : Y=±25%

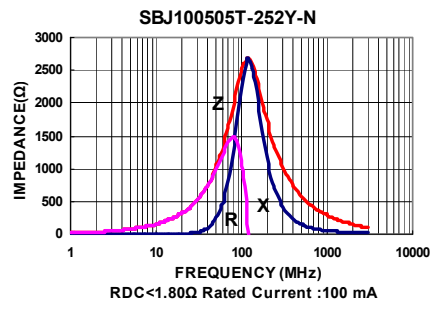
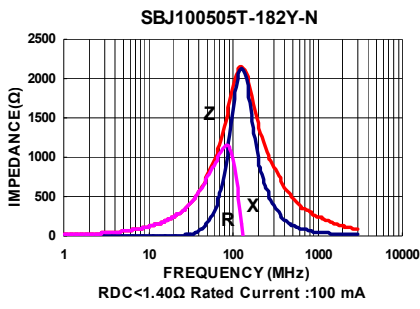
- Operating temperature range - 55°C ~ 125°C(Including self - temperature rise)
- Rate Current : Applied the current to coils, the temperature rise shall not be more than 30°C
- Measure Equipment :
Z : HP4291A
RDC : HP4338B or CHEN HWA 502

Test Instruments : Agilent E4991A Impedance / Material Analyzer



Please be sure to request approval specifications that provide further details of the products. Kindly note that the content of these specifications are subject to change or may be discontinued without advance notice. Please contact our sales department before ordering.

Test Instruments : Agilent E4991A Impedance / Material Analyzer



Please be sure to request approval specifications that provide further details of the products. Kindly note that the content of these specifications are subject to change or may be discontinued without advance notice. Please contact our sales department before ordering.

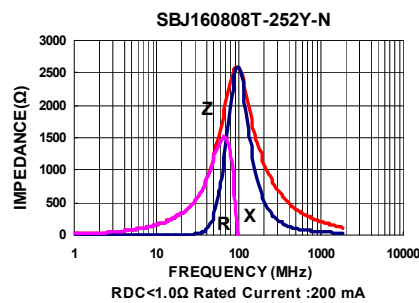
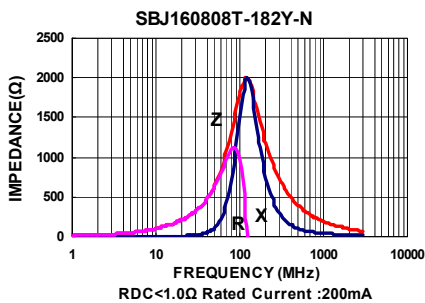
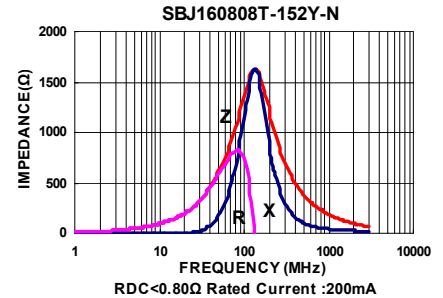
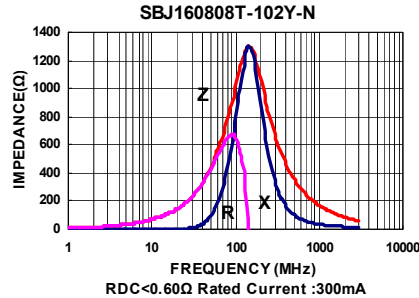
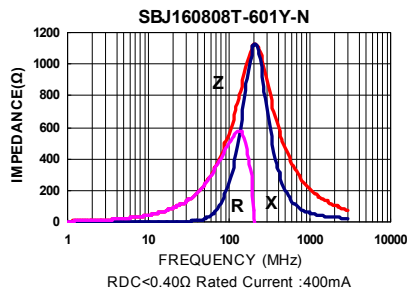
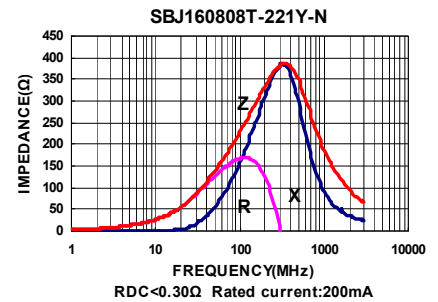
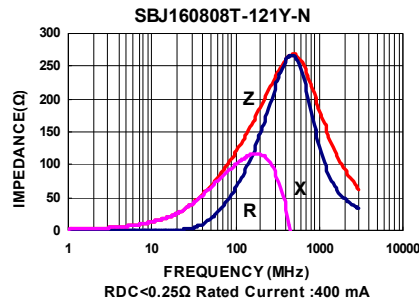
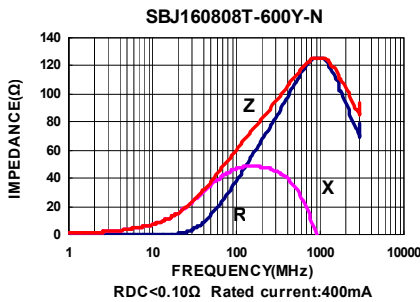
Electrical Characteristics

| Part Number | Impedance ($\Omega \pm 25\%$) | Test Frequency (MHz) | RDC (Ω) Max | Rated current (mA) Max |
|-------------------|------------------------------------|-------------------------|-------------------------|---------------------------|
| SBJ160808T-600Y-N | 60 | 100 | 0.10 | 400 |
| SBJ160808T-121Y-N | 120 | 100 | 0.25 | 400 |
| SBJ160808T-221Y-N | 220 | 100 | 0.30 | 400 |
| SBJ160808T-601Y-N | 600 | 100 | 0.40 | 400 |
| SBJ160808T-102Y-N | 1000 | 100 | 0.60 | 300 |
| SBJ160808T-152Y-N | 1500 | 100 | 0.80 | 200 |
| SBJ160808T-182Y-N | 1800 | 100 | 1.0 | 200 |
| SBJ160808T-252Y-N | 2500 | 100 | 1.0 | 200 |

Note: When ordering, please specify tolerance code. Tolerance : Y= $\pm 25\%$

- Operating temperature range - 55°C ~ 125°C(Including self - temperature rise)
- Rate Current : Applied the current to coils, the temperature rise shall not be more than 30°C
- Measure Equipment :
Z : HP4291A
RDC : HP4338B or CHEN HWA 502

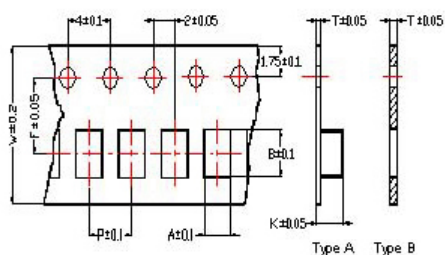
Test Instruments : Agilent E4991A Impedance / Material Analyzer



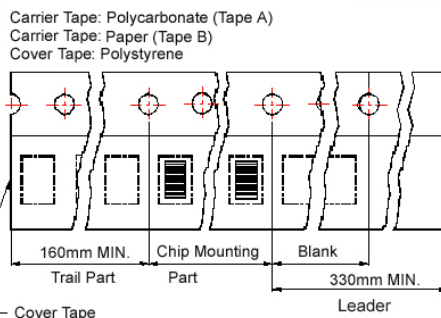
Please be sure to request approval specifications that provide further details of the products. Kindly note that the content of these specifications are subject to change or may be discontinued without advance notice. Please contact our sales department before ordering.

Packaging Specifications

Tape Dimensions



Tape Material



Reel Dimensions



- ① : SBY / SBJ / NB / PB
- ② : SBY / SBJ / NB / PB / UPB / HF ③ : UPB
- ④ : SBK / SBJ / GB / PB / NB / UPB / VPB
- ⑤ : SBK / GB / PB / UPB ⑥ : SBY / SBK / PBY / UPB

Dimensions in mm

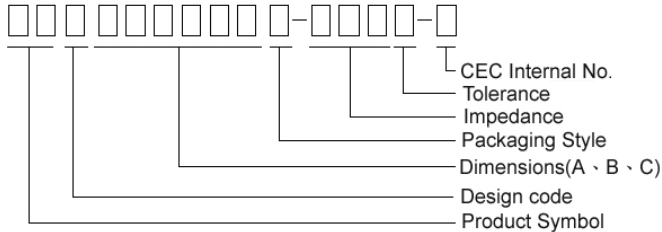
| TYPE | Tape Dimensions | | | | | | | | Reel Dimensions | | | | Quantity PCS / REEL |
|---------|-----------------|------|------|-----|-----|-----|------|------|-----------------|----|----|---|------------------------|
| | A | B | T | W | P | F | K | Tape | A | B | C | D | |
| ①060303 | 0.37 | 0.67 | 0.42 | 8.0 | 2.0 | 3.5 | - | B | 178 | 60 | 10 | 2 | 15000 |
| ②100505 | 0.62 | 1.12 | 0.60 | 8.0 | 2.0 | 3.5 | - | B | 178 | 60 | 12 | 2 | 10000 |
| ③160805 | 1.05 | 1.85 | 0.60 | 8.0 | 2.0 | 3.5 | - | B | 178 | 60 | 12 | 2 | 10000 |
| ④160808 | 1.05 | 1.85 | 0.95 | 8.0 | 4.0 | 3.5 | - | B | 178 | 60 | 12 | 2 | 4000 |
| ⑤201209 | 1.50 | 2.30 | 0.97 | 8.0 | 4.0 | 3.5 | - | B | 178 | 60 | 12 | 2 | 4000 |
| ⑥321611 | 1.88 | 3.50 | 0.22 | 8.0 | 4.0 | 3.5 | 1.27 | A | 178 | 60 | 12 | 2 | 3000 |

Multilayer Ferrite Chip Beads



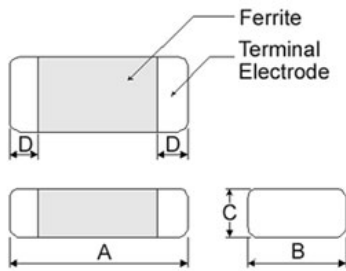
Chilisin offers a wide range of multi-layered ferrite chip beads with various sizes, frequency characteristics, and impedance values for EMI solutions. These ferrite formulas are used to compose seven types of EMI suppression chip beads: SB, GB, PB, UPB, NB, HF, and VPB series.

Product Identification

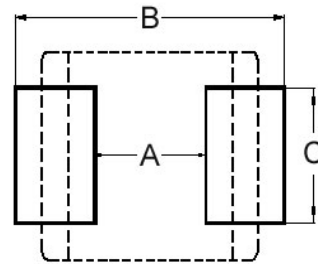


- Product symbol: SB, GB, PB, UPB, NB, HF, VPB
- Packaging: T : Tape and Reel ; B : Bulk
- Tolerance: Y = ± 25%; M = ± 20%; T:±30%
- Note: RoHS Compliant

Shape and Dimensions



Recommended Pattern



Dimensions in mm

| TYPE | A | B | C | D |
|---------|----------|-----------|----------|-----------|
| ①060303 | 0.6±0.03 | 0.30±0.03 | 0.3±0.03 | 0.15±0.05 |
| ②100505 | 1.0±0.10 | 0.50±0.10 | 0.5±0.10 | 0.25±0.10 |
| ③160805 | 1.6±0.15 | 0.80±0.15 | 0.5±0.15 | 0.3±0.2 |
| ④160808 | 1.6±0.15 | 0.80±0.15 | 0.8±0.15 | 0.3±0.2 |
| ⑤201209 | 2.0±0.20 | 1.25±0.20 | 0.9±0.20 | 0.5±0.3 |
| ⑥321611 | 3.2±0.20 | 1.60±0.20 | 1.1±0.20 | 0.5±0.3 |

① : SBY / SBJ / NB / PB ② : SBY / SBJ / NB / PB / UPB / HF
 ③ : UPB ④ : SBK / SBJ / GB / PB / NB / UPB / VPB
 ⑤ : SBK / GB / PB / UPB ⑥ : SBY / SBK / PB / UPB

Dimensions in mm

| TYPE | A | B | C |
|---------|-----------|-------------|-----------|
| ①060303 | 0.2 ~ 0.3 | 0.75 ~ 1.05 | 0.3 |
| ②100505 | 0.4 | 1.2 ~ 1.4 | 0.5 |
| ③160805 | 0.7 ~ 0.8 | 1.8 ~ 2.0 | 0.6 ~ 0.8 |
| ④160808 | 0.7 ~ 0.8 | 1.8 ~ 2.0 | 0.6 ~ 0.8 |
| ⑤201209 | 1.0 ~ 1.2 | 2.6 ~ 4.0 | 1.0 ~ 1.2 |
| ⑥321611 | 2.0 | 4.2 ~ 5.2 | 1.2 |

* Don't apply narrower pattern than listed above to PB and UPB. Narrow pattern might cause excessive heat or open circuit.

Dimension Conversion

| Code | Dimension in mm (AxBxC) | EIA |
|--------|----------------------------|------|
| 060303 | 0.6X0.3X0.3 | 0201 |
| 100505 | 1.0X0.5X0.5 | 0402 |
| 160805 | 1.6x0.8x0.5 | 0603 |
| 160808 | 1.6x0.8x0.8 | 0603 |
| 201209 | 2.0x1.2x0.9 | 0805 |
| 321611 | 3.2x1.6x1.1 | 1206 |

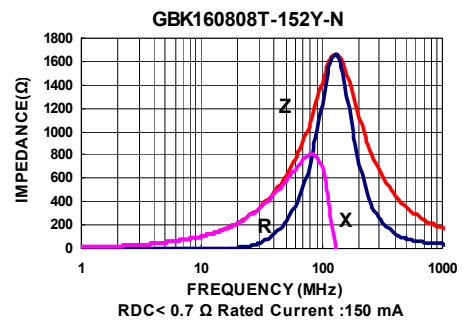
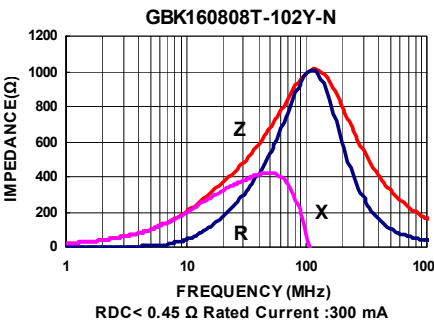
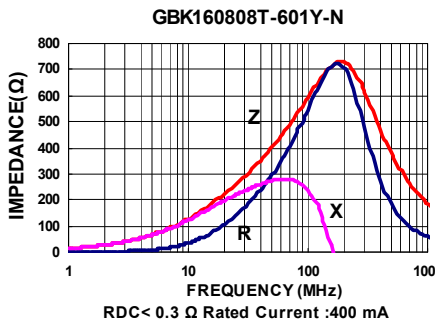
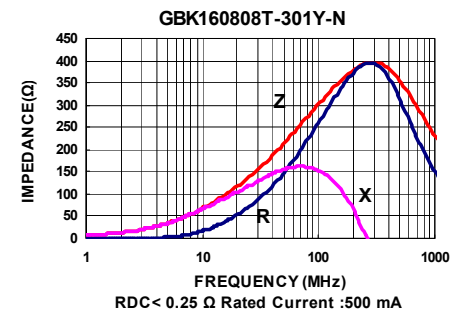
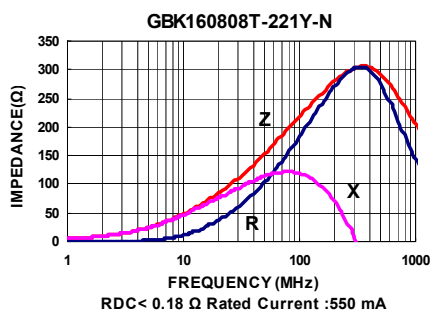
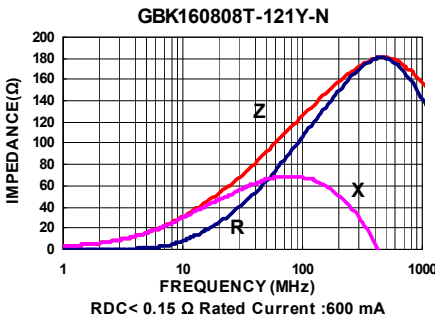
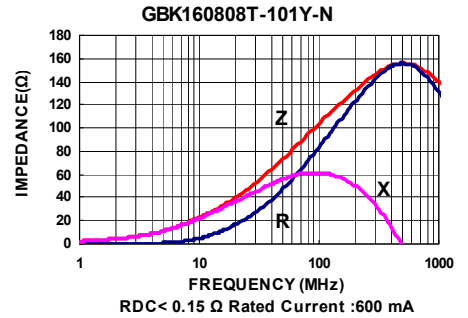
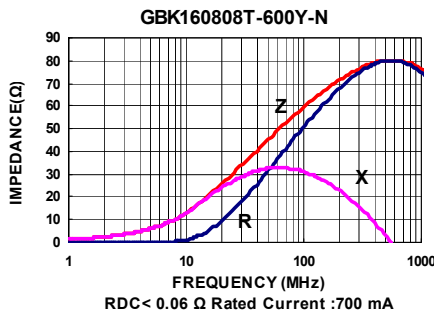
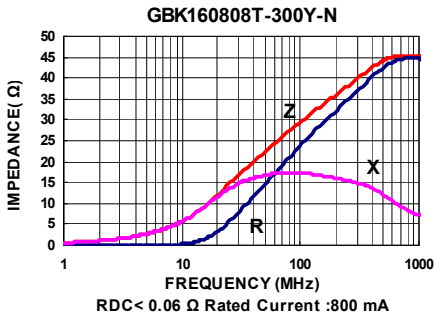
Electrical Characteristics

| Part Number | Impedance ($\Omega \pm 25\%$) | Test Frequency (MHz) | RDC (Ω) Max | Rated current (mA) Max |
|-------------------|---------------------------------|----------------------|----------------------|------------------------|
| GBK160808T-300Y-N | 30 | 100 | 0.06 | 800 |
| GBK160808T-600Y-N | 60 | 100 | 0.06 | 700 |
| GBK160808T-101Y-N | 100 | 100 | 0.15 | 600 |
| GBK160808T-121Y-N | 120 | 100 | 0.15 | 600 |
| GBK160808T-221Y-N | 220 | 100 | 0.18 | 550 |
| GBK160808T-301Y-N | 300 | 100 | 0.25 | 500 |
| GBK160808T-601Y-N | 600 | 100 | 0.30 | 400 |
| GBK160808T-102Y-N | 1000 | 100 | 0.45 | 300 |
| GBK160808T-152Y-N | 1500 | 100 | 0.70 | 150 |

Note: When ordering, please specify tolerance code. Tolerance : Y \pm 25%

- Operating temperature range - 55°C ~ 125°C(Including self - temperature rise)
- Rate Current : Applied the current to coils, the temperature rise shall not be more than 30°C
- Measure Equipment :
 Z : HP4291A
 RDC : HP4338B or CHEN HWA 502

Test Instruments : Agilent E4991A Impedance / Material Analyzer



Please be sure to request approval specifications that provide further details of the products. Kindly note that the content of these specifications are subject to change or may be discontinued without advance notice. Please contact our sales department before ordering.

SMD Multilayer Ferrite Chip Beads - GBK Series

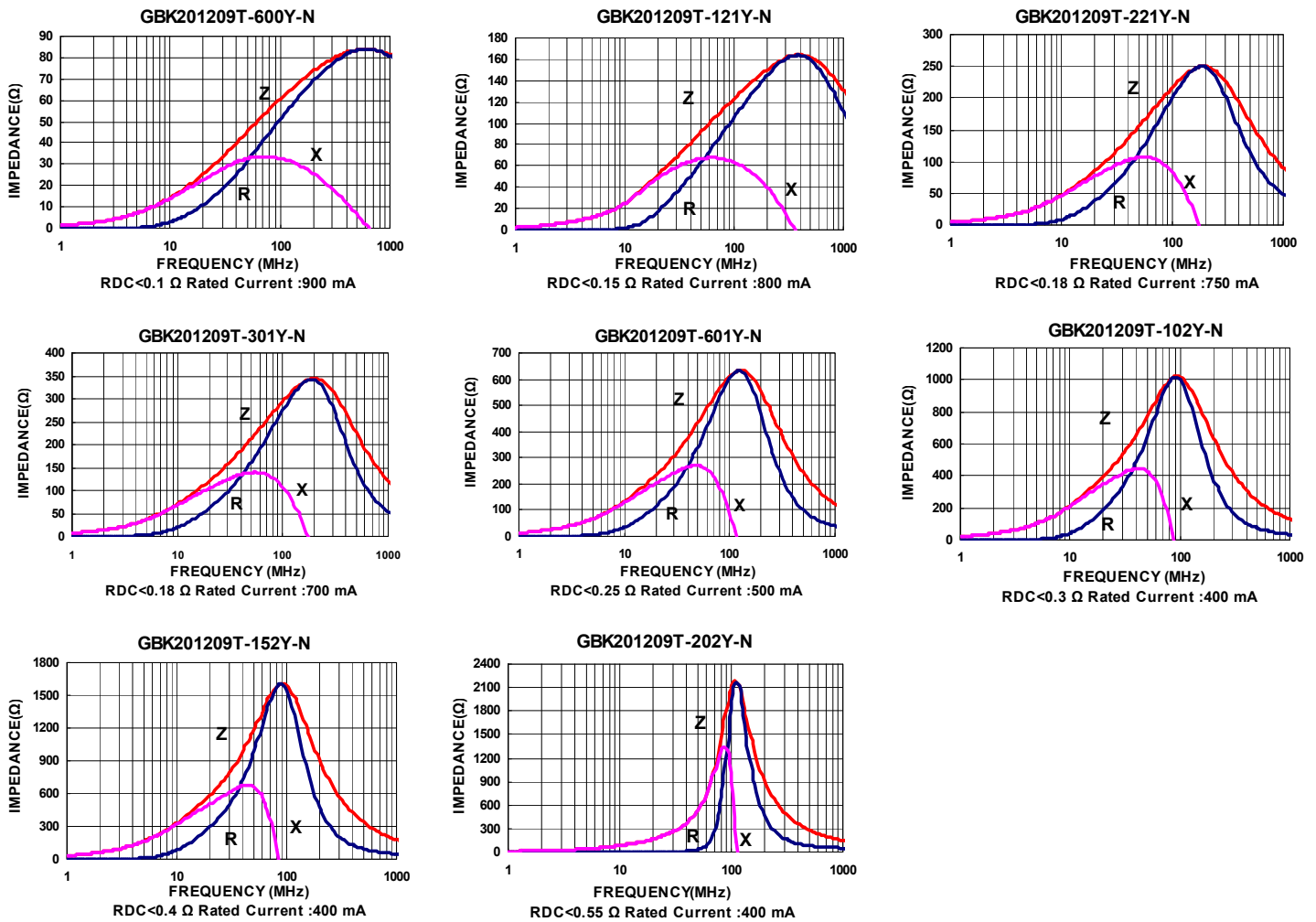
Electrical Characteristics

| Part Number | Impedance ($\Omega \pm 25\%$) | Test Frequency (MHz) | RDC (Ω) Max | Rated current (mA) Max |
|-------------------|------------------------------------|-------------------------|-------------------------|---------------------------|
| GBK201209T-600Y-N | 60 | 100 | 0.10 | 900 |
| GBK201209T-121Y-N | 120 | 100 | 0.15 | 800 |
| GBK201209T-221Y-N | 220 | 100 | 0.18 | 750 |
| GBK201209T-301Y-N | 300 | 100 | 0.18 | 700 |
| GBK201209T-601Y-N | 600 | 100 | 0.25 | 500 |
| GBK201209T-102Y-N | 1000 | 100 | 0.30 | 400 |
| GBK201209T-152Y-N | 1500 | 100 | 0.40 | 400 |
| GBK201209T-202Y-N | 2000 | 100 | 0.55 | 400 |

Note: When ordering, please specify tolerance code. Tolerance : Y= $\pm 25\%$

- Operating temperature range - 55°C ~ 125°C(Including self - temperature rise)
- Rate Current : Applied the current to coils, the temperature rise shall not be more than 30°C
- Measure Equipment :
Z : HP4291A
RDC : HP4338B or CHEN HWA 502

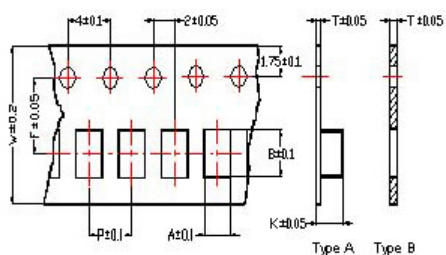
Test Instruments : Agilent E4991A Impedance / Material Analyzer



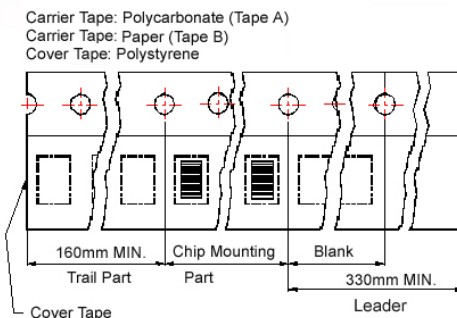
Please be sure to request approval specifications that provide further details of the products. Kindly note that the content of these specifications are subject to change or may be discontinued without advance notice. Please contact our sales department before ordering.

Packaging Specifications

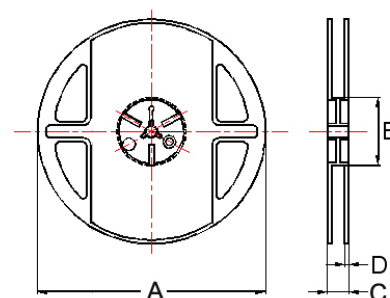
Tape Dimensions



Tape Material



Reel Dimensions



- ① : SBY / SBJ / NB / PB
- ② : SBY / SBJ / NB / PB / UPB / HF ③ : UPB
- ④ : SBK / SBJ / GB / PB / NB / UPB / VPB
- ⑤ : SBK / GB / PB / UPB ⑥ : SBY / SBK / PBY / UPB

Dimensions in mm

| TYPE | Tape Dimensions | | | | | | | | Reel Dimensions | | | | Quantity PCS / REEL |
|---------|-----------------|------|------|-----|-----|-----|------|------|-----------------|----|----|---|------------------------|
| | A | B | T | W | P | F | K | Tape | A | B | C | D | |
| ①060303 | 0.37 | 0.67 | 0.42 | 8.0 | 2.0 | 3.5 | - | B | 178 | 60 | 10 | 2 | 15000 |
| ②100505 | 0.62 | 1.12 | 0.60 | 8.0 | 2.0 | 3.5 | - | B | 178 | 60 | 12 | 2 | 10000 |
| ③160805 | 1.05 | 1.85 | 0.60 | 8.0 | 2.0 | 3.5 | - | B | 178 | 60 | 12 | 2 | 10000 |
| ④160808 | 1.05 | 1.85 | 0.95 | 8.0 | 4.0 | 3.5 | - | B | 178 | 60 | 12 | 2 | 4000 |
| ⑤201209 | 1.50 | 2.30 | 0.97 | 8.0 | 4.0 | 3.5 | - | B | 178 | 60 | 12 | 2 | 4000 |
| ⑥321611 | 1.88 | 3.50 | 0.22 | 8.0 | 4.0 | 3.5 | 1.27 | A | 178 | 60 | 12 | 2 | 3000 |

Multilayer Ferrite Chip Beads



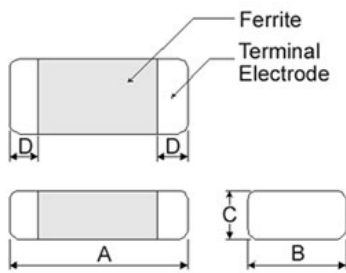
Chilisin offers a wide range of multi-layered ferrite chip beads with various sizes, frequency characteristics, and impedance values for EMI solutions. These ferrite formulas are used to compose seven types of EMI suppression chip beads: SB, GB, PB, UPB, NB, HF, and VPB series.

Product Identification

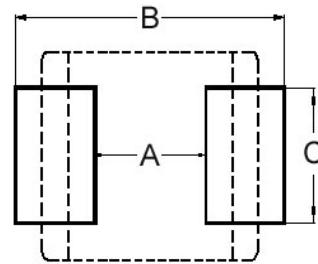


- Product symbol: SB, GB, PB, UPB, NB, HF, VPB
- Packaging: T : Tape and Reel ; B : Bulk
- Tolerance: Y = ± 25%; M = ± 20%; T:±30%
- Note: RoHS Compliant

Shape and Dimensions



Recommended Pattern



Dimensions in mm

| TYPE | A | B | C | D |
|---------|----------|-----------|----------|-----------|
| ①060303 | 0.6±0.03 | 0.30±0.03 | 0.3±0.03 | 0.15±0.05 |
| ②100505 | 1.0±0.10 | 0.50±0.10 | 0.5±0.10 | 0.25±0.10 |
| ③160805 | 1.6±0.15 | 0.80±0.15 | 0.5±0.15 | 0.3±0.2 |
| ④160808 | 1.6±0.15 | 0.80±0.15 | 0.8±0.15 | 0.3±0.2 |
| ⑤201209 | 2.0±0.20 | 1.25±0.20 | 0.9±0.20 | 0.5±0.3 |
| ⑥321611 | 3.2±0.20 | 1.60±0.20 | 1.1±0.20 | 0.5±0.3 |

- ① : SBY / SBJ / NB / PB ② : SBY / SBJ / NB / PB / UPB / HF
 ③ : UPB ④ : SBK / SBJ / GB / PB / NB / UPB / VPB
 ⑤ : SBK / GB / PB / UPB ⑥ : SBY / SBK / PB / UPB

Dimensions in mm

| TYPE | A | B | C |
|---------|-----------|-------------|-----------|
| ①060303 | 0.2 ~ 0.3 | 0.75 ~ 1.05 | 0.3 |
| ②100505 | 0.4 | 1.2 ~ 1.4 | 0.5 |
| ③160805 | 0.7 ~ 0.8 | 1.8 ~ 2.0 | 0.6 ~ 0.8 |
| ④160808 | 0.7 ~ 0.8 | 1.8 ~ 2.0 | 0.6 ~ 0.8 |
| ⑤201209 | 1.0 ~ 1.2 | 2.6 ~ 4.0 | 1.0 ~ 1.2 |
| ⑥321611 | 2.0 | 4.2 ~ 5.2 | 1.2 |

- * Don't apply narrower pattern than listed above to PB and UPB. Narrow pattern might cause excessive heat or open circuit.

Dimension Conversion

| Code | Dimension in mm (AxBxC) | EIA |
|--------|----------------------------|------|
| 060303 | 0.6X0.3X0.3 | 0201 |
| 100505 | 1.0X0.5X0.5 | 0402 |
| 160805 | 1.6x0.8x0.5 | 0603 |
| 160808 | 1.6x0.8x0.8 | 0603 |
| 201209 | 2.0x1.2x0.9 | 0805 |
| 321611 | 3.2x1.6x1.1 | 1206 |

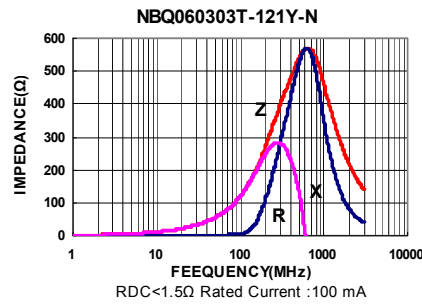
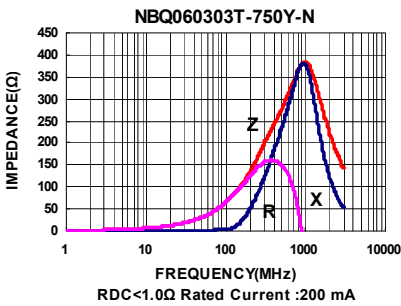
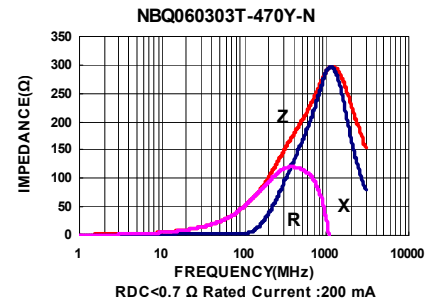
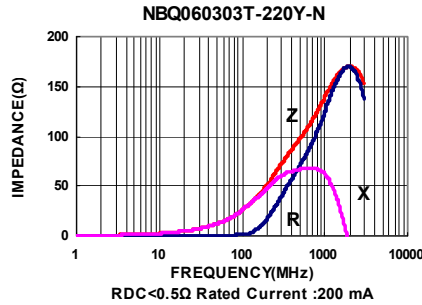
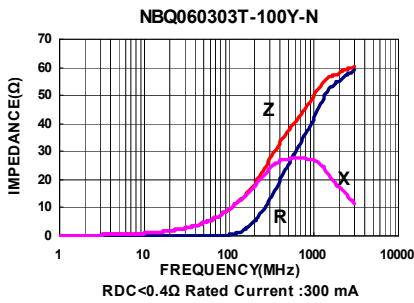
Electrical Characteristics

| Part Number | Impedance ($\Omega \pm 25\%$) | Test Frequency (MHz) | RDC (Ω) Max | Rated current (mA) Max |
|-------------------|------------------------------------|-------------------------|-------------------------|---------------------------|
| NBQ060303T-100Y-N | 10 | 100 | 0.4 | 300 |
| NBQ060303T-220Y-N | 22 | 100 | 0.5 | 200 |
| NBQ060303T-470Y-N | 47 | 100 | 0.7 | 200 |
| NBQ060303T-750Y-N | 75 | 100 | 1.0 | 200 |
| NBQ060303T-121Y-N | 120 | 100 | 1.5 | 100 |

Note: When ordering, please specify tolerance code. Tolerance : Y=±25%

- Operating temperature range - 55°C ~ 125°C(Including self - temperature rise)
- Rate Current : Applied the current to coils, the temperature rise shall not be more than 30°C
- Measure Equipment :
Z : HP4291A
RDC : HP4338B or CHEN HWA 502

Test Instruments : Agilent E4991A Impedance / Material Analyzer



Please be sure to request approval specifications that provide further details of the products. Kindly note that the content of these specifications are subject to change or may be discontinued without advance notice. Please contact our sales department before ordering.

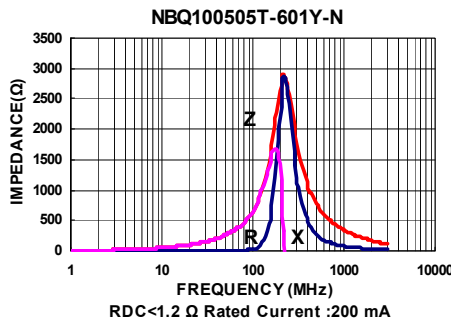
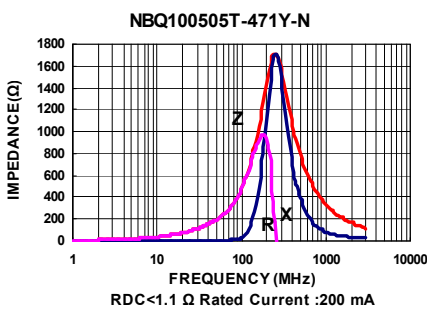
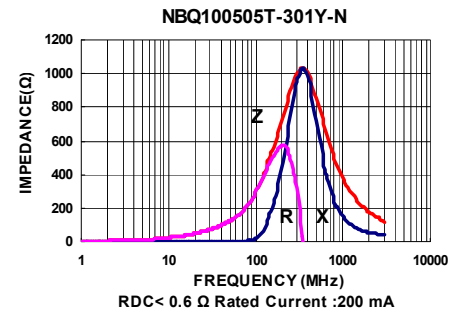
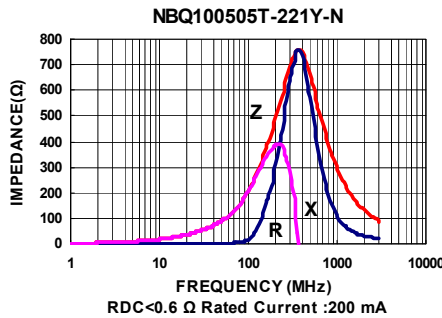
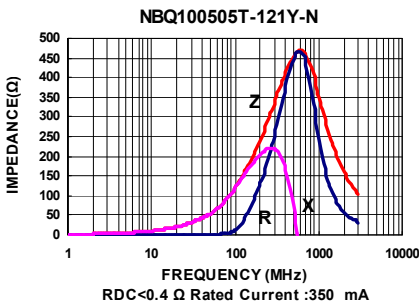
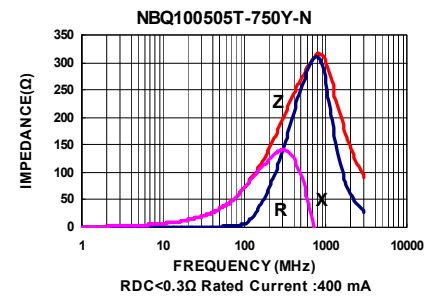
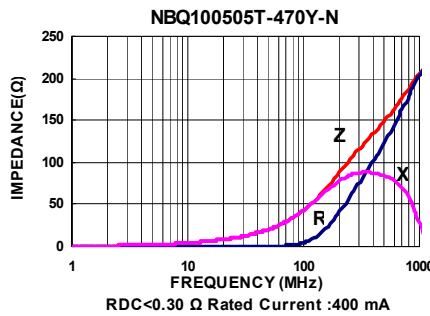
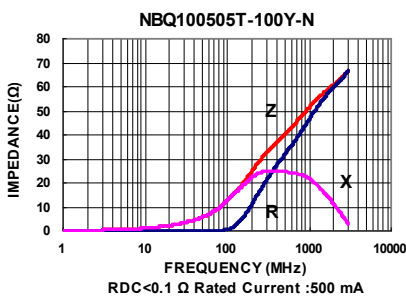
Electrical Characteristics

| Part Number | Impedance ($\Omega \pm 25\%$) | Test Frequency (MHz) | RDC (Ω) Max | Rated current (mA) Max |
|-------------------|------------------------------------|-------------------------|-------------------------|---------------------------|
| NBQ100505T-100Y-N | 10 | 100 | 0.10 | 500 |
| NBQ100505T-470Y-N | 47 | 100 | 0.30 | 400 |
| NBQ100505T-750Y-N | 75 | 100 | 0.30 | 400 |
| NBQ100505T-121Y-N | 120 | 100 | 0.40 | 350 |
| NBQ100505T-221Y-N | 220 | 100 | 0.60 | 200 |
| NBQ100505T-301Y-N | 300 | 100 | 0.80 | 200 |
| NBQ100505T-471Y-N | 470 | 100 | 1.10 | 200 |
| NBQ100505T-601Y-N | 600 | 100 | 1.20 | 200 |

Note: When ordering, please specify tolerance code. Tolerance : Y= $\pm 25\%$

- Operating temperature range - 55°C ~ 125°C(Including self - temperature rise)
- Rate Current : Applied the current to coils, the temperature rise shall not be more than 30°C
- Measure Equipment :
Z : HP4291A
RDC : HP4338B or CHEN HWA 502

Test Instruments : Agilent E4991A Impedance / Material Analyzer



Please be sure to request approval specifications that provide further details of the products. Kindly note that the content of these specifications are subject to change or may be discontinued without advance notice. Please contact our sales department before ordering.

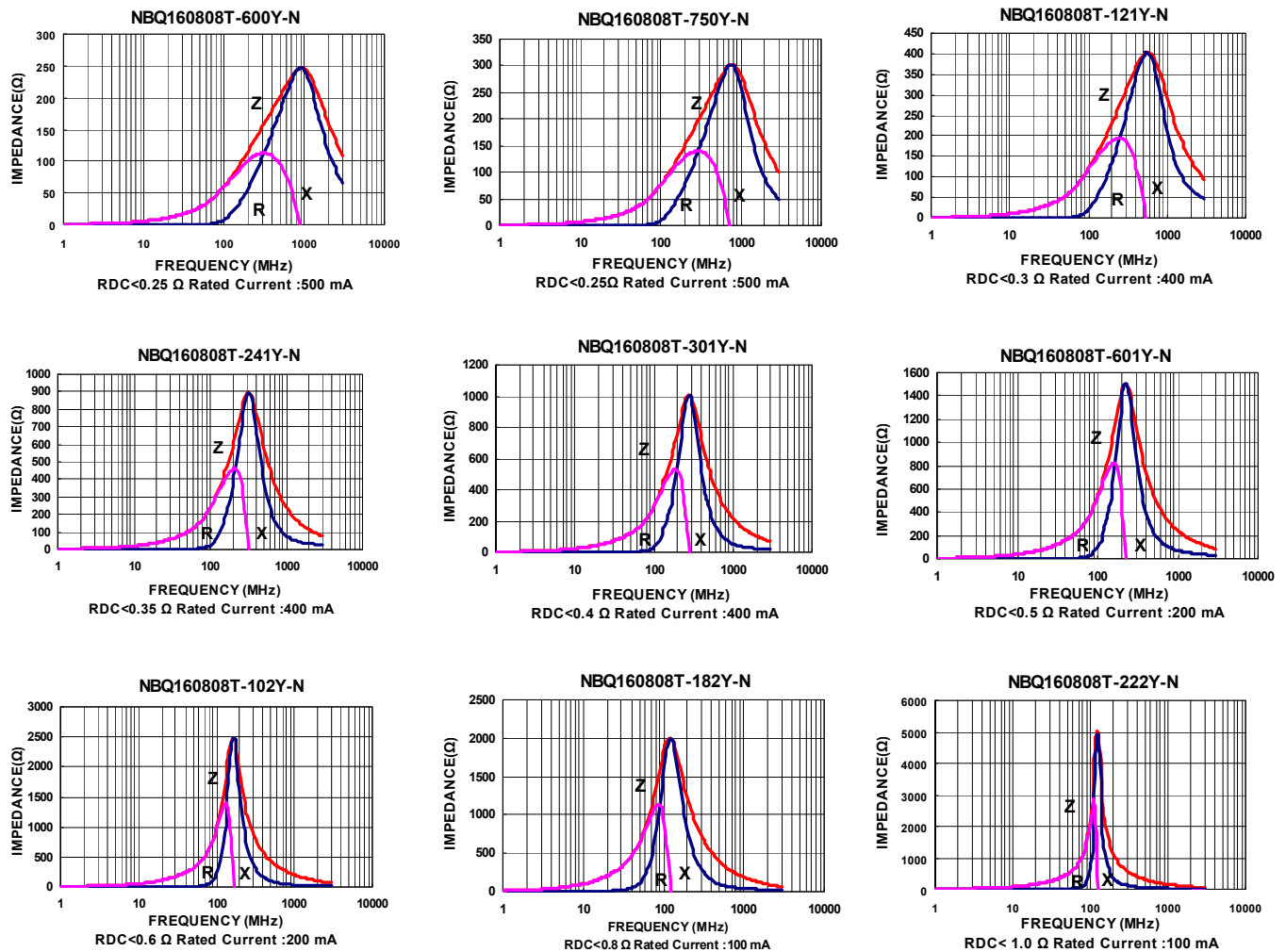
Electrical Characteristics

| Part Number | Impedance ($\Omega \pm 25\%$) | Test Frequency (MHz) | RDC (Ω) Max | Rated current (mA) Max |
|-------------------|------------------------------------|-------------------------|-------------------------|---------------------------|
| NBQ160808T-600Y-N | 60 | 100 | 0.25 | 500 |
| NBQ160808T-750Y-N | 75 | 100 | 0.25 | 500 |
| NBQ160808T-121Y-N | 120 | 100 | 0.30 | 400 |
| NBQ160808T-241Y-N | 240 | 100 | 0.35 | 400 |
| NBQ160808T-301Y-N | 300 | 100 | 0.40 | 400 |
| NBQ160808T-601Y-N | 600 | 100 | 0.50 | 200 |
| NBQ160808T-102Y-N | 1000 | 100 | 0.60 | 200 |
| NBQ160808T-182Y-N | 1800 | 100 | 0.80 | 100 |
| NBQ160808T-222Y-N | 2200 | 100 | 1.0 | 100 |
| NBQ160808T-252Y-N | 2500 | 100 | 1.0 | 100 |

Note: When ordering, please specify tolerance code. Tolerance : Y= $\pm 25\%$

- Operating temperature range - 55°C ~ 125°C(Including self - temperature rise)
- Rate Current : Applied the current to coils, the temperature rise shall not be more than 30°C
- Measure Equipment :
Z : HP4291A
RDC : HP4338B or CHEN HWA 502

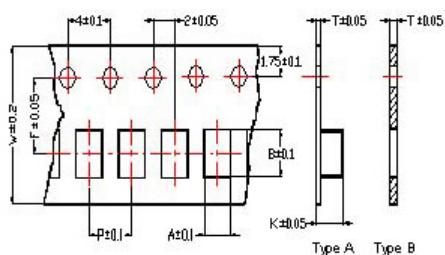
Test Instruments : Agilent E4991A Impedance / Material Analyzer



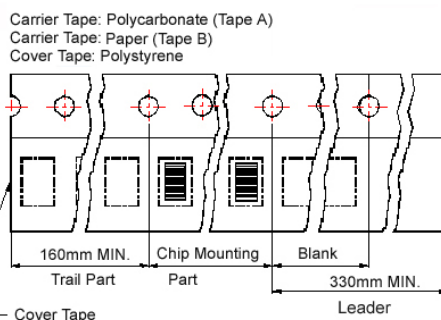
Please be sure to request approval specifications that provide further details of the products. Kindly note that the content of these specifications are subject to change or may be discontinued without advance notice. Please contact our sales department before ordering.

Packaging Specifications

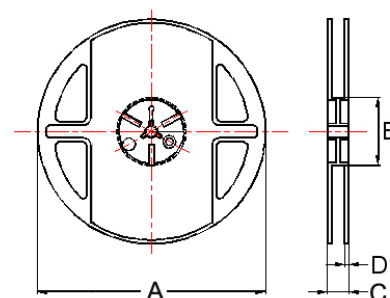
Tape Dimensions



Tape Material



Reel Dimensions



- ① : SBY / SBJ / NB / PB
- ② : SBY / SBJ / NB / PB / UPB / HF ③ : UPB
- ④ : SBK / SBJ / GB / PB / NB / UPB / VPB
- ⑤ : SBK / GB / PB / UPB ⑥ : SBY / SBK / PBY / UPB

Dimensions in mm

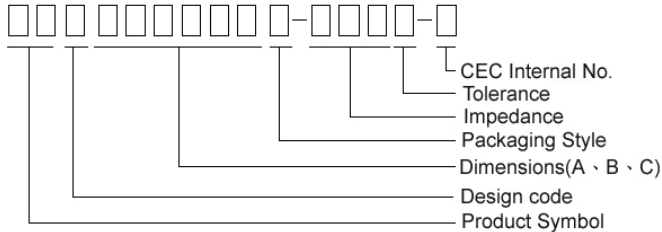
| TYPE | Tape Dimensions | | | | | | | | Reel Dimensions | | | | Quantity PCS / REEL |
|---------|-----------------|------|------|-----|-----|-----|------|------|-----------------|----|----|---|------------------------|
| | A | B | T | W | P | F | K | Tape | A | B | C | D | |
| ①060303 | 0.37 | 0.67 | 0.42 | 8.0 | 2.0 | 3.5 | - | B | 178 | 60 | 10 | 2 | 15000 |
| ②100505 | 0.62 | 1.12 | 0.60 | 8.0 | 2.0 | 3.5 | - | B | 178 | 60 | 12 | 2 | 10000 |
| ③160805 | 1.05 | 1.85 | 0.60 | 8.0 | 2.0 | 3.5 | - | B | 178 | 60 | 12 | 2 | 10000 |
| ④160808 | 1.05 | 1.85 | 0.95 | 8.0 | 4.0 | 3.5 | - | B | 178 | 60 | 12 | 2 | 4000 |
| ⑤201209 | 1.50 | 2.30 | 0.97 | 8.0 | 4.0 | 3.5 | - | B | 178 | 60 | 12 | 2 | 4000 |
| ⑥321611 | 1.88 | 3.50 | 0.22 | 8.0 | 4.0 | 3.5 | 1.27 | A | 178 | 60 | 12 | 2 | 3000 |

Multilayer Ferrite Chip Beads



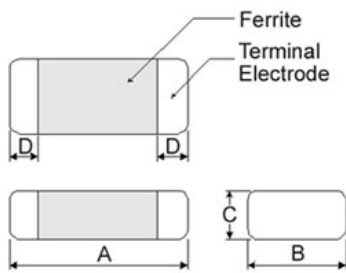
Chilisin offers a wide range of multi-layered ferrite chip beads with various sizes, frequency characteristics, and impedance values for EMI solutions. These ferrite formulas are used to compose seven types of EMI suppression chip beads: SB, GB, PB, UPB, NB, HF, and VPB series.

Product Identification

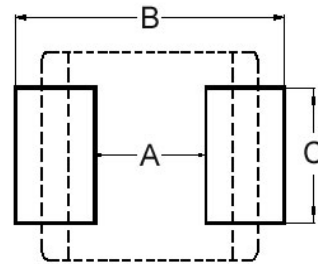


- Product symbol: SB, GB, PB, UPB, NB, HF, VPB
- Packaging: T : Tape and Reel ; B : Bulk
- Tolerance: Y = ± 25%; M = ± 20%; T:±30%
- Note: RoHS Compliant

Shape and Dimensions



Recommended Pattern



Dimensions in mm

| TYPE | A | B | C | D |
|---------|----------|-----------|----------|-----------|
| ①060303 | 0.6±0.03 | 0.30±0.03 | 0.3±0.03 | 0.15±0.05 |
| ②100505 | 1.0±0.10 | 0.50±0.10 | 0.5±0.10 | 0.25±0.10 |
| ③160805 | 1.6±0.15 | 0.80±0.15 | 0.5±0.15 | 0.3±0.2 |
| ④160808 | 1.6±0.15 | 0.80±0.15 | 0.8±0.15 | 0.3±0.2 |
| ⑤201209 | 2.0±0.20 | 1.25±0.20 | 0.9±0.20 | 0.5±0.3 |
| ⑥321611 | 3.2±0.20 | 1.60±0.20 | 1.1±0.20 | 0.5±0.3 |

① : SBY / SBJ / NB / PB ② : SBY / SBJ / NB / PB / UPB / HF
 ③ : UPB ④ : SBK / SBJ / GB / PB / NB / UPB / VPB
 ⑤ : SBK / GB / PB / UPB ⑥ : SBY / SBK / PB / UPB

Dimensions in mm

| TYPE | A | B | C |
|---------|-----------|-------------|-----------|
| ①060303 | 0.2 ~ 0.3 | 0.75 ~ 1.05 | 0.3 |
| ②100505 | 0.4 | 1.2 ~ 1.4 | 0.5 |
| ③160805 | 0.7 ~ 0.8 | 1.8 ~ 2.0 | 0.6 ~ 0.8 |
| ④160808 | 0.7 ~ 0.8 | 1.8 ~ 2.0 | 0.6 ~ 0.8 |
| ⑤201209 | 1.0 ~ 1.2 | 2.6 ~ 4.0 | 1.0 ~ 1.2 |
| ⑥321611 | 2.0 | 4.2 ~ 5.2 | 1.2 |

* Don't apply narrower pattern than listed above to PB and UPB. Narrow pattern might cause excessive heat or open circuit.

Dimension Conversion

| Code | Dimension in mm (AxBxC) | EIA |
|--------|----------------------------|------|
| 060303 | 0.6X0.3X0.3 | 0201 |
| 100505 | 1.0X0.5X0.5 | 0402 |
| 160805 | 1.6x0.8x0.5 | 0603 |
| 160808 | 1.6x0.8x0.8 | 0603 |
| 201209 | 2.0x1.2x0.9 | 0805 |
| 321611 | 3.2x1.6x1.1 | 1206 |

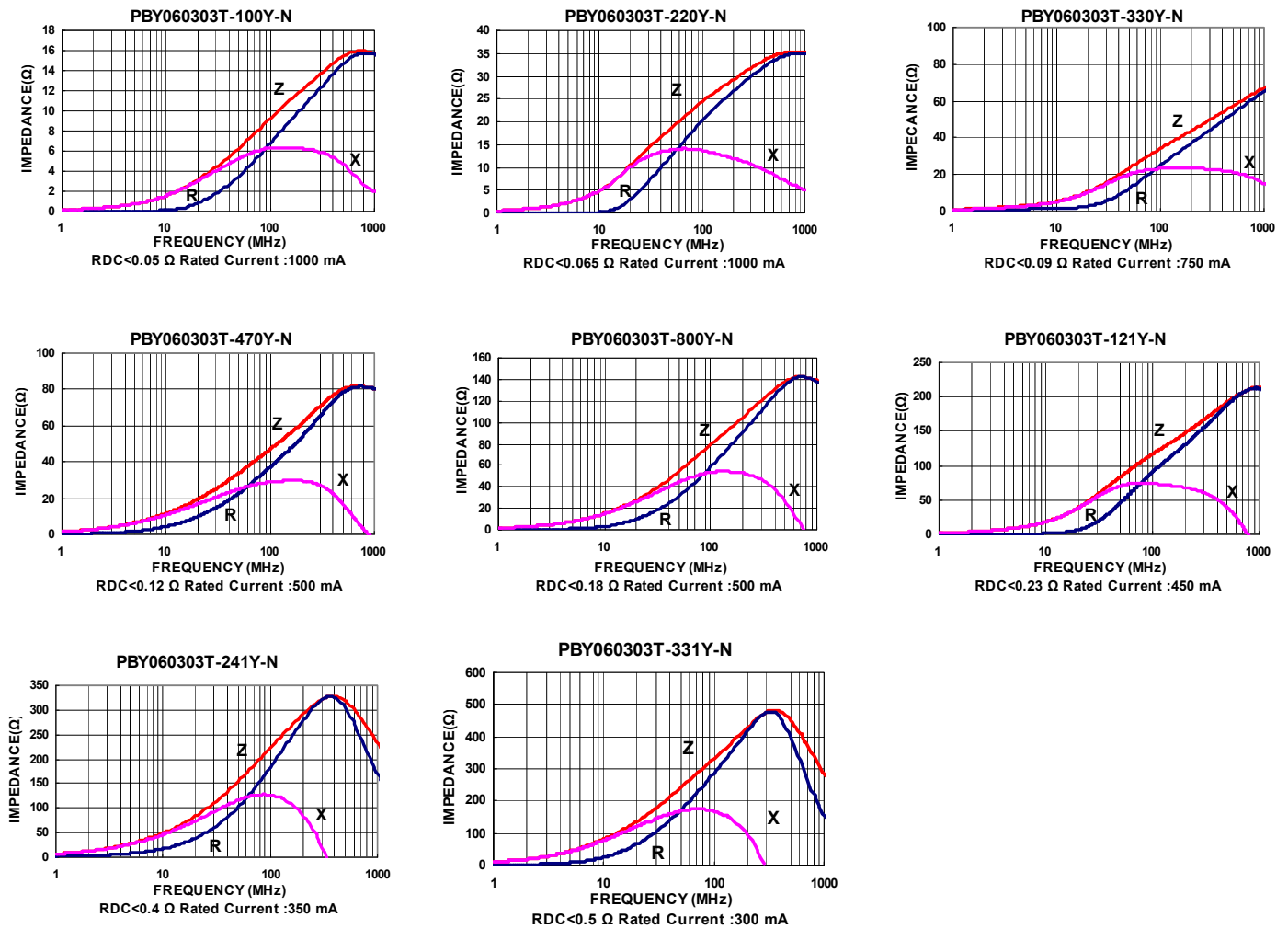
Electrical Characteristics

| Part Number | Impedance ($\Omega \pm 25\%$) | Test Frequency (MHz) | RDC (Ω) Max | Rated current (mA) Max |
|-------------------|------------------------------------|-------------------------|-------------------------|---------------------------|
| PBY060303T-100Y-N | 10 | 100 | 0.050 | 1000 |
| PBY060303T-220Y-N | 22 | 100 | 0.065 | 1000 |
| PBY060303T-330Y-N | 33 | 100 | 0.090 | 750 |
| PBY060303T-470Y-N | 47 | 100 | 0.120 | 500 |
| PBY060303T-800Y-N | 80 | 100 | 0.180 | 500 |
| PBY060303T-121Y-N | 120 | 100 | 0.230 | 450 |
| PBY060303T-241Y-N | 240 | 100 | 0.400 | 350 |
| PBY060303T-331Y-N | 330 | 100 | 0.500 | 300 |

Note: When ordering, please specify tolerance code. Tolerance : Y \pm 25%

- Operating temperature range - 55°C ~ 125°C(Including self - temperature rise)
- Rate Current : Applied the current to coils, the temperature rise shall not be more than 30°C
- Measure Equipment :
Z : HP4291A
RDC : HP4338B or CHEN HWA 502

Test Instruments : Agilent E4991A Impedance / Material Analyzer



Please be sure to request approval specifications that provide further details of the products. Kindly note that the content of these specifications are subject to change or may be discontinued without advance notice. Please contact our sales department before ordering.

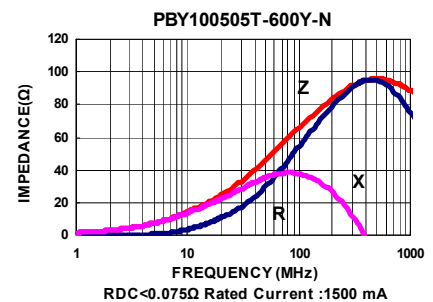
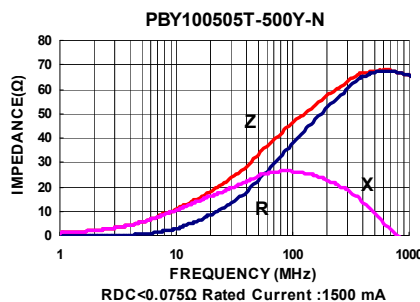
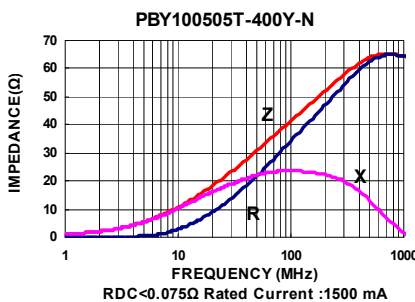
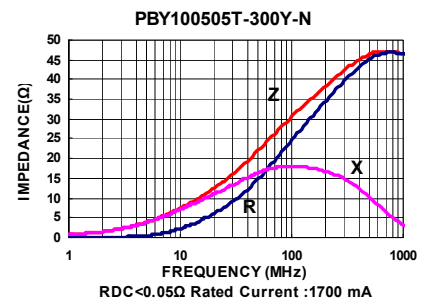
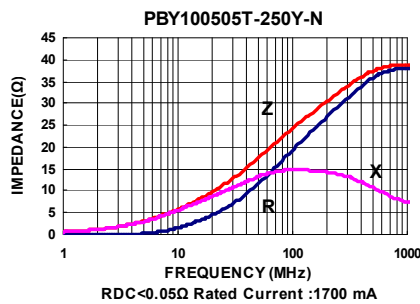
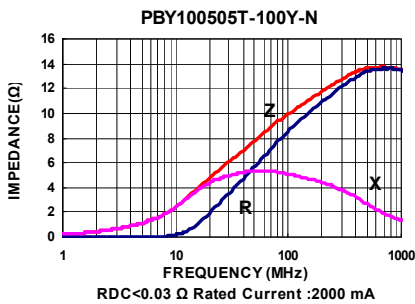
Electrical Characteristics

| Part Number | Impedance ($\Omega \pm 25\%$) | Test Frequency (MHz) | RDC (Ω) Max | Rated current (mA) Max |
|-------------------|------------------------------------|-------------------------|-------------------------|---------------------------|
| PBY100505T-100Y-N | 10 | 100 | 0.03 | 2000 |
| PBY100505T-250Y-N | 25 | 100 | 0.05 | 1700 |
| PBY100505T-300Y-N | 30 | 100 | 0.05 | 1700 |
| PBY100505T-320Y-N | 32 | 100 | 0.05 | 1700 |
| PBY100505T-400Y-N | 40 | 100 | 0.075 | 1500 |
| PBY100505T-500Y-N | 50 | 100 | 0.075 | 1500 |
| PBY100505T-600Y-N | 60 | 100 | 0.075 | 1500 |
| PBY100505T-680Y-N | 68 | 100 | 0.09 | 1200 |
| PBY100505T-700Y-N | 70 | 100 | 0.09 | 1200 |
| PBY100505T-800Y-N | 80 | 100 | 0.09 | 1200 |
| PBY100505T-101Y-N | 100 | 100 | 0.09 | 1200 |
| PBY100505T-121Y-N | 120 | 100 | 0.09 | 1400 |
| PBY100505T-151Y-N | 150 | 100 | 0.14 | 1400 |
| PBY100505T-181Y-N | 180 | 100 | 0.14 | 900 |
| PBY100505T-221Y-N | 220 | 100 | 0.18 | 1100 |
| PBY100505T-601Y-N | 600 | 100 | 0.34 | 700 |
| PBY100505T-102Y-N | 1000 | 100 | 0.49 | 500 |

Note: When ordering, please specify tolerance code. Tolerance : Y= $\pm 25\%$

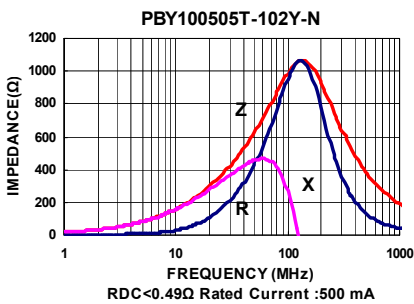
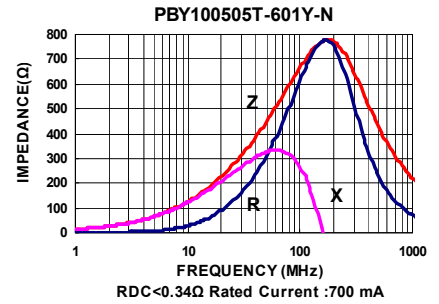
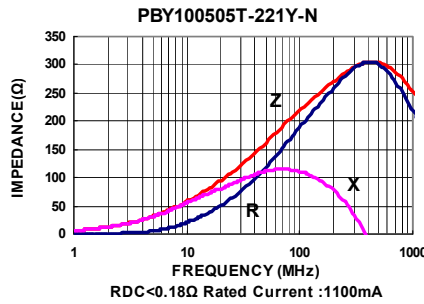
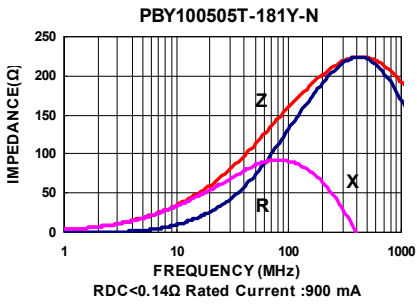
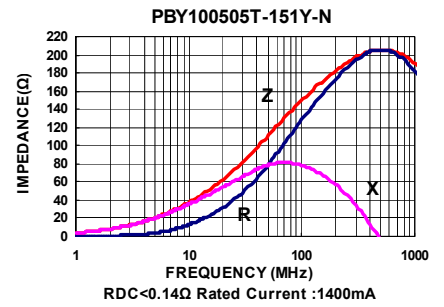
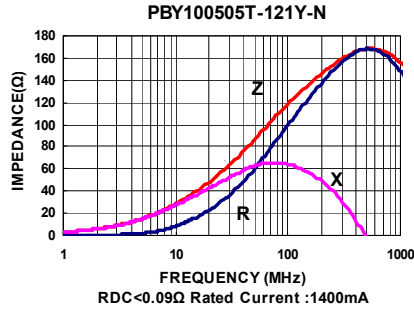
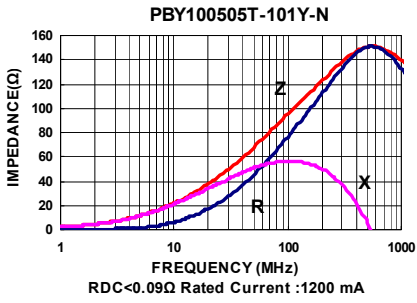
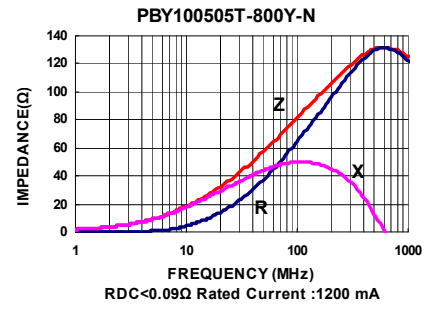
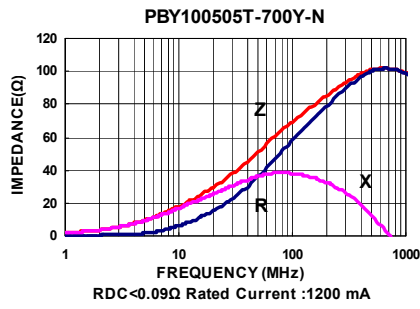
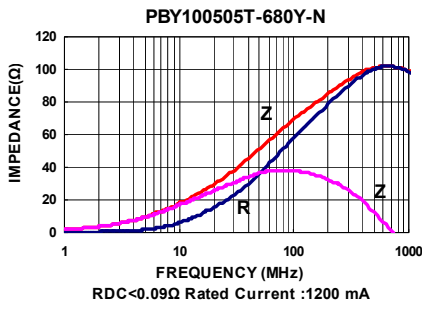
- Operating temperature range - 55°C ~ 125°C(Including self - temperature rise)
- Rate Current : Applied the current to coils, the temperature rise shall not be more than 30°C
- Measure Equipment :
Z : HP4291A
RDC : HP4338B or CHEN HWA 502

Test Instruments : Agilent E4991A Impedance / Material Analyzer



Please be sure to request approval specifications that provide further details of the products. Kindly note that the content of these specifications are subject to change or may be discontinued without advance notice. Please contact our sales department before ordering.

Test Instruments : Agilent E4991A Impedance / Material Analyzer



Please be sure to request approval specifications that provide further details of the products. Kindly note that the content of these specifications are subject to change or may be discontinued without advance notice. Please contact our sales department before ordering.

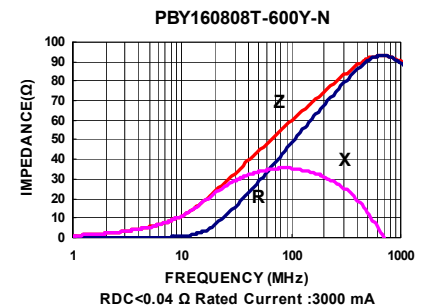
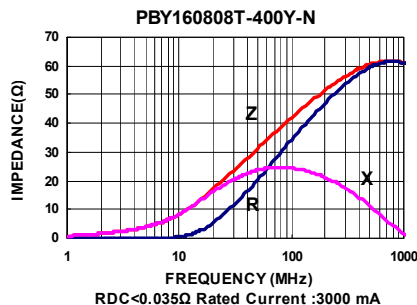
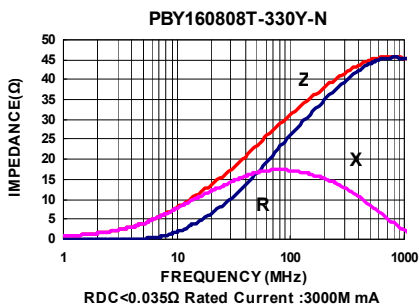
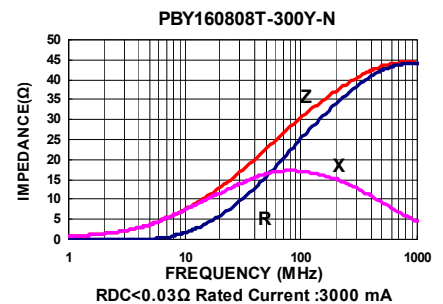
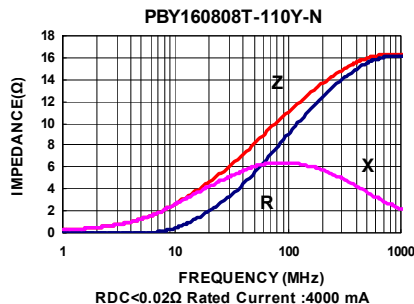
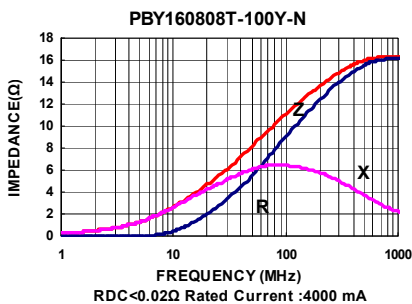
Electrical Characteristics

| Part Number | Impedance ($\Omega \pm 25\%$) | Test Frequency (MHz) | RDC (Ω) Max | Rated current (mA) Max |
|-------------------|------------------------------------|-------------------------|-------------------------|---------------------------|
| PBY160808T-100Y-N | 10 | 100 | 0.020 | 4000 |
| PBY160808T-110Y-N | 11 | 100 | 0.020 | 4000 |
| PBY160808T-300Y-N | 30 | 100 | 0.030 | 3000 |
| PBY160808T-330Y-N | 33 | 100 | 0.035 | 3000 |
| PBY160808T-400Y-N | 40 | 100 | 0.035 | 3000 |
| PBY160808T-600Y-N | 60 | 100 | 0.040 | 3000 |
| PBY160808T-800Y-N | 80 | 100 | 0.050 | 2500 |
| PBY160808T-101Y-N | 100 | 100 | 0.050 | 2500 |
| PBY160808T-121Y-N | 120 | 100 | 0.080 | 2500 |
| PBY160808T-151Y-N | 150 | 100 | 0.085 | 2000 |
| PBY160808T-181Y-N | 180 | 100 | 0.090 | 2000 |
| PBY160808T-221Y-N | 220 | 100 | 0.100 | 2000 |
| PBY160808T-301Y-N | 300 | 100 | 0.120 | 1500 |
| PBY160808T-331Y-N | 330 | 100 | 0.120 | 1500 |
| PBY160808T-471Y-N | 470 | 100 | 0.150 | 1500 |
| PBY160808T-601Y-N | 600 | 100 | 0.200 | 1000 |
| PBY160808T-102Y-N | 1000 | 100 | 0.250 | 800 |
| PBY160808T-122Y-N | 1200 | 100 | 0.250 | 800 |
| PBY160808T-152Y-N | 1500 | 100 | 0.400 | 500 |

Note: When ordering, please specify tolerance code. Tolerance : Y \pm 25%

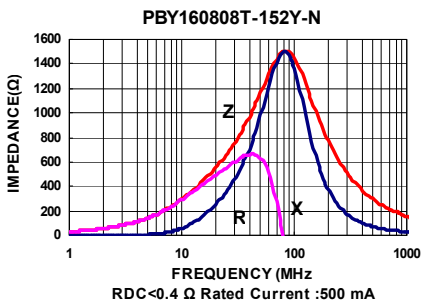
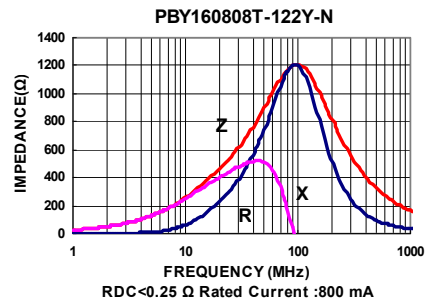
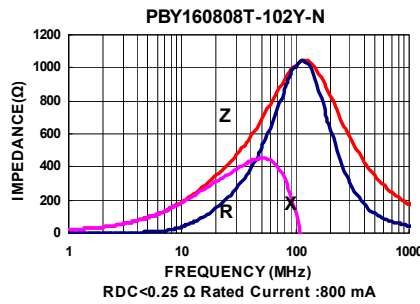
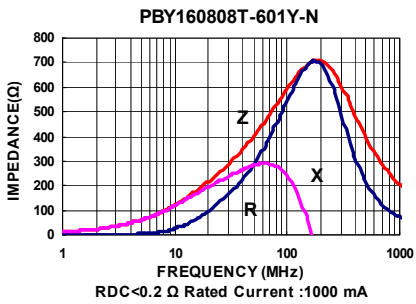
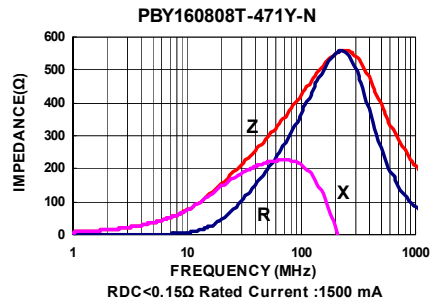
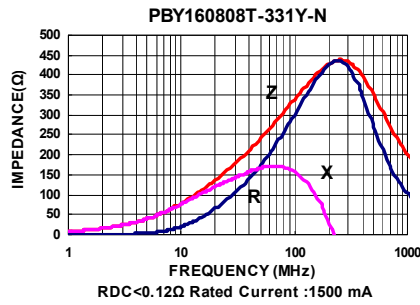
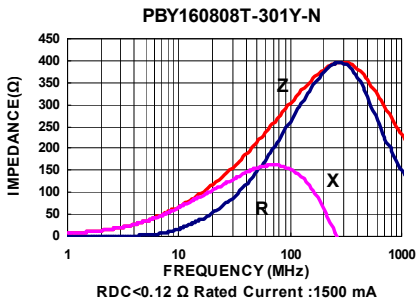
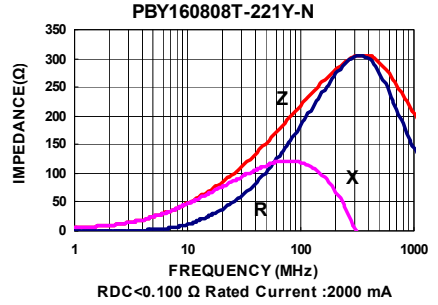
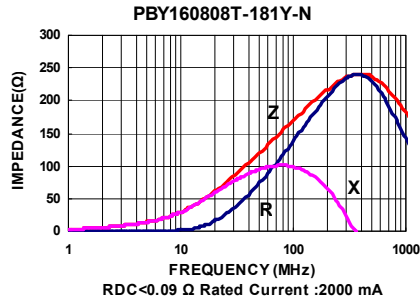
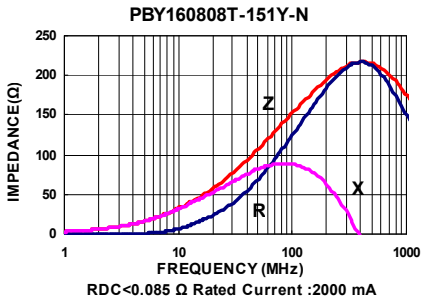
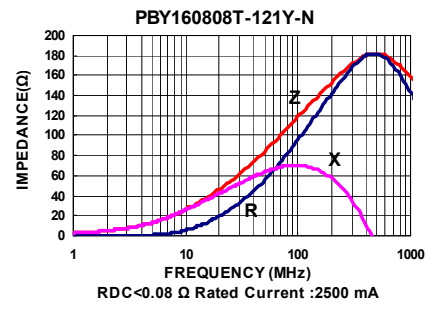
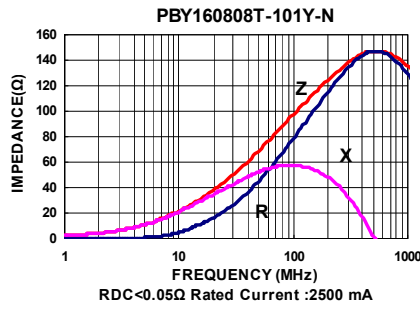
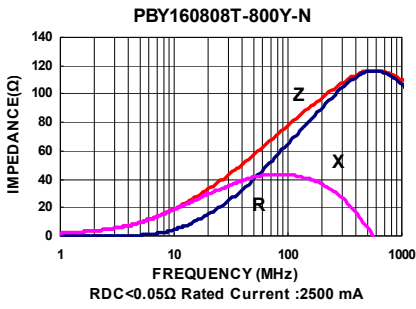
- Operating temperature range - 55°C ~ 125°C(Including self - temperature rise)
- Rate Current : Applied the current to coils, the temperature rise shall not be more than 30°C
- Measure Equipment :
Z : HP4291A
RDC : HP4338B or CHEN HWA 502

Test Instruments : Agilent E4991A Impedance / Material Analyzer



Please be sure to request approval specifications that provide further details of the products. Kindly note that the content of these specifications is subject to change or may be discontinued without advance notice. Please contact our sales department before ordering.

Test Instruments : Agilent E4991A Impedance / Material Analyzer



Please be sure to request approval specifications that provide further details of the products. Kindly note that the content of these specifications are subject to change or may be discontinued without advance notice. Please contact our sales department before ordering.

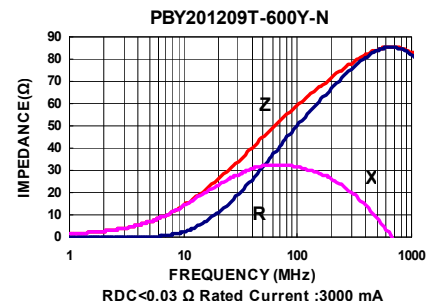
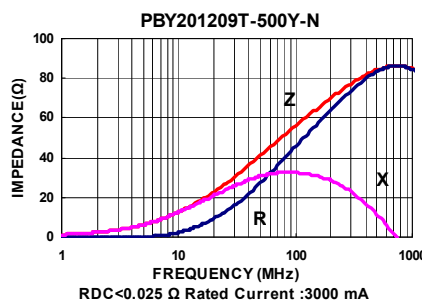
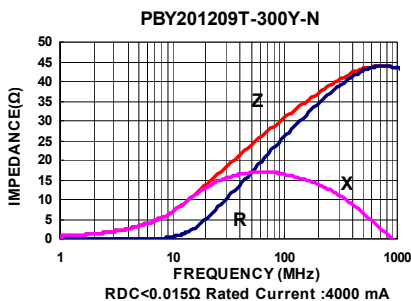
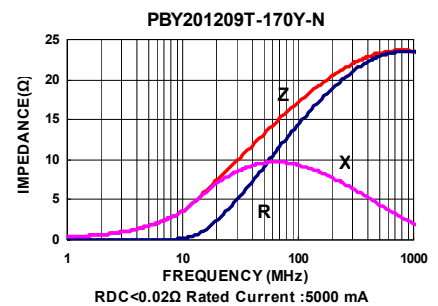
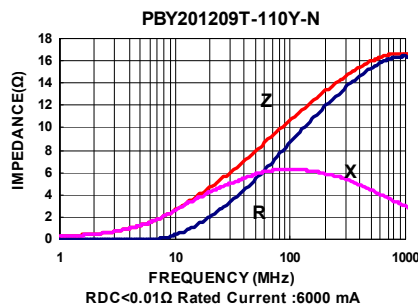
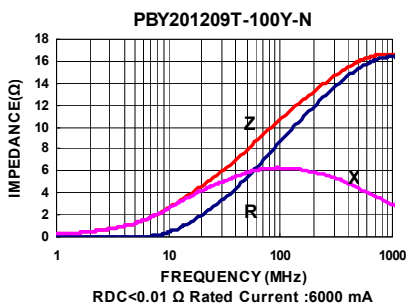
Electrical Characteristics

| Part Number | Impedance ($\Omega \pm 25\%$) | Test Frequency (MHz) | RDC (Ω) Max | Rated current (mA) Max |
|-------------------|------------------------------------|-------------------------|-------------------------|---------------------------|
| PBY201209T-100Y-N | 10 | 100 | 0.01 | 6000 |
| PBY201209T-110Y-N | 11 | 100 | 0.01 | 6000 |
| PBY201209T-170Y-N | 17 | 100 | 0.02 | 5000 |
| PBY201209T-300Y-N | 30 | 100 | 0.015 | 4000 |
| PBY201209T-500Y-N | 50 | 100 | 0.025 | 3000 |
| PBY201209T-600Y-N | 60 | 100 | 0.03 | 3000 |
| PBY201209T-800Y-N | 80 | 100 | 0.04 | 3000 |
| PBY201209T-101Y-N | 100 | 100 | 0.04 | 3000 |
| PBY201209T-121Y-N | 120 | 100 | 0.04 | 3000 |
| PBY201209T-221Y-N | 220 | 100 | 0.08 | 2000 |
| PBY201209T-301Y-N | 300 | 100 | 0.08 | 2000 |
| PBY201209T-331Y-N | 330 | 100 | 0.08 | 2000 |
| PBY201209T-471Y-N | 470 | 100 | 0.10 | 2000 |
| PBY201209T-601Y-N | 600 | 100 | 0.10 | 2000 |
| PBY201209T-102Y-N | 1000 | 100 | 0.12 | 1500 |
| PBY201209T-152Y-N | 1500 | 100 | 0.30 | 1000 |

Note: When ordering, please specify tolerance code. Tolerance : Y= $\pm 25\%$

- Operating temperature range - 55°C ~ 125°C(Including self - temperature rise)
- Rate Current : Applied the current to coils, the temperature rise shall not be more than 30°C
- Measure Equipment :
Z : HP4291A
RDC : HP4338B or CHEN HWA 502

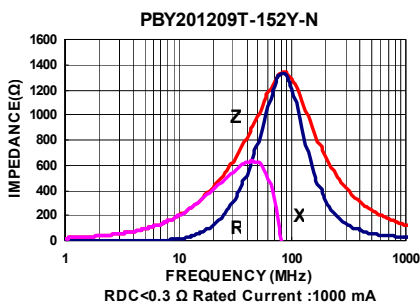
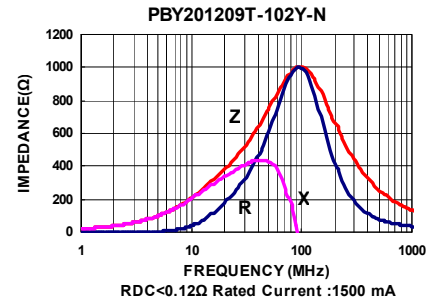
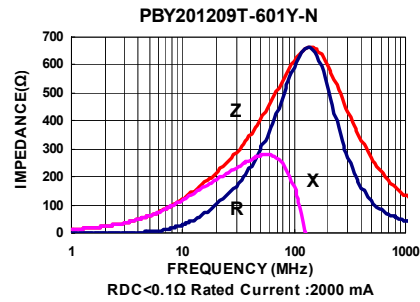
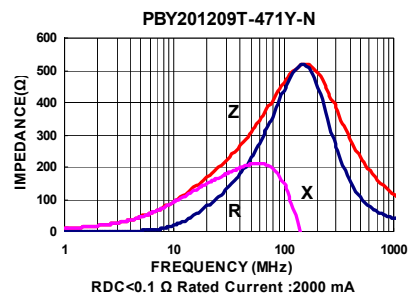
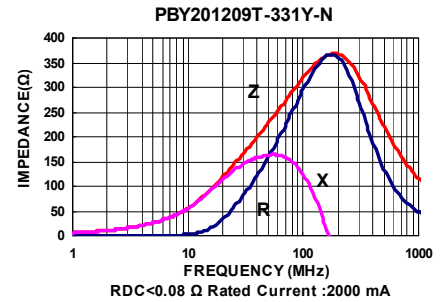
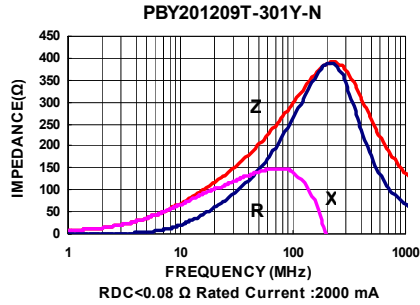
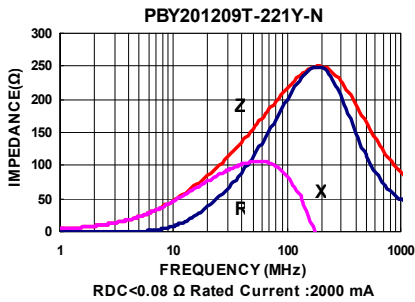
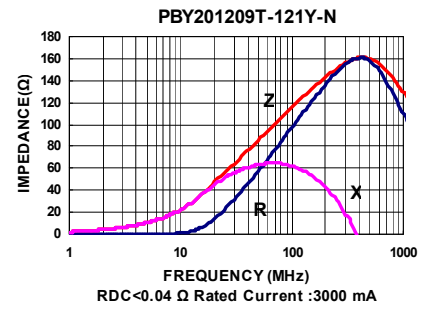
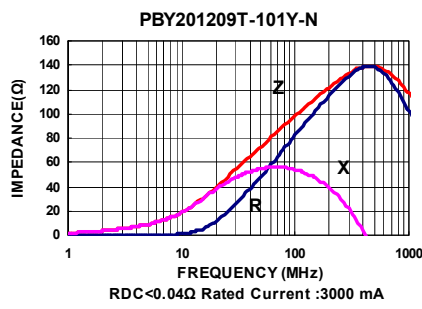
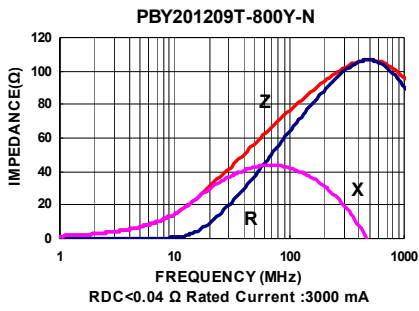
Test Instruments : Agilent E4991A Impedance / Material Analyzer



Please be sure to request approval specifications that provide further details of the products. Kindly note that the content of these specifications are subject to change or may be discontinued without advance notice. Please contact our sales department before ordering.

SMD Multilayer Ferrite Chip Beads – PBY Series

Test Instruments : Agilent E4991A Impedance / Material Analyzer



Please be sure to request approval specifications that provide further details of the products. Kindly note that the content of these specifications are subject to change or may be discontinued without advance notice. Please contact our sales department before ordering.

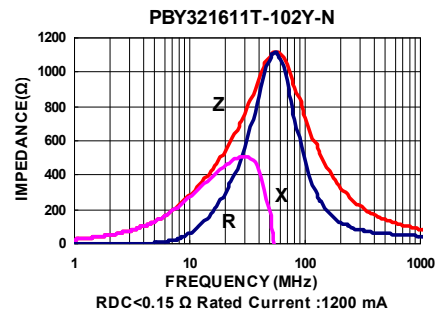
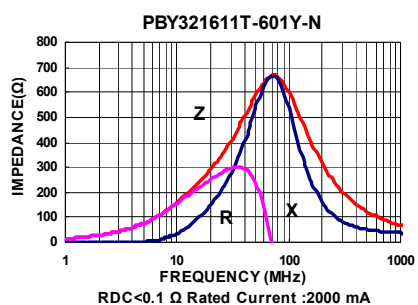
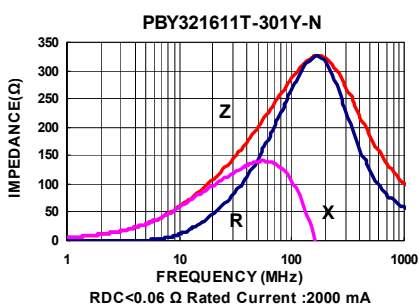
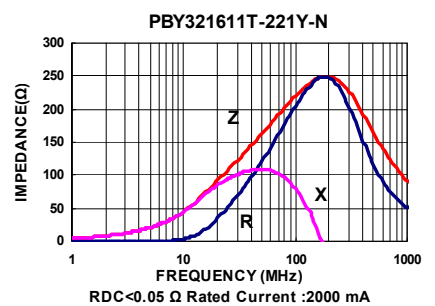
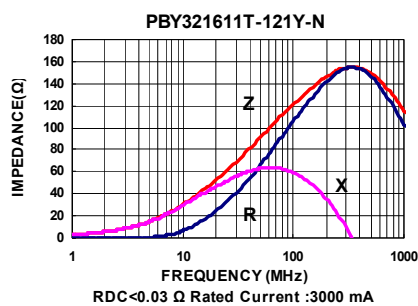
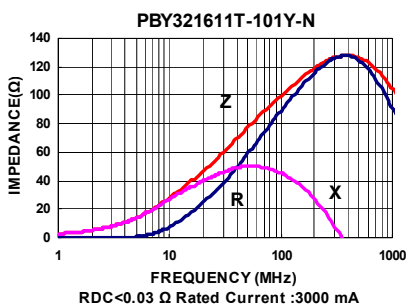
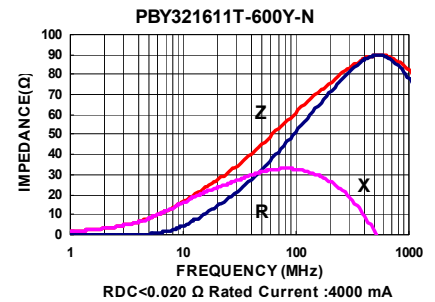
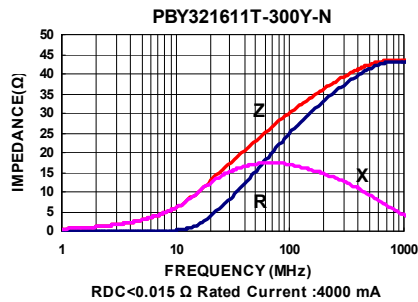
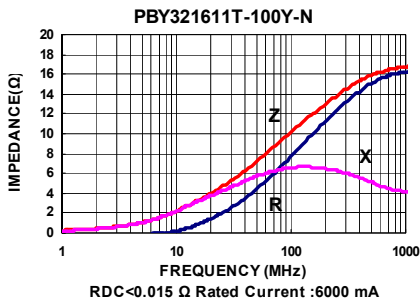
Electrical Characteristics

| Part Number | Impedance ($\Omega \pm 25\%$) | Test Frequency (MHz) | RDC (Ω) Max | Rated current (mA) Max |
|-------------------|------------------------------------|-------------------------|-------------------------|---------------------------|
| PBY321611T-100Y-N | 10 | 100 | 0.015 | 6000 |
| PBY321611T-300Y-N | 30 | 100 | 0.015 | 4000 |
| PBY321611T-600Y-N | 60 | 100 | 0.020 | 4000 |
| PBY321611T-101Y-N | 100 | 100 | 0.030 | 3000 |
| PBY321611T-121Y-N | 120 | 100 | 0.030 | 3000 |
| PBY321611T-221Y-N | 220 | 100 | 0.050 | 2000 |
| PBY321611T-301Y-N | 300 | 100 | 0.060 | 2000 |
| PBY321611T-601Y-N | 600 | 100 | 0.100 | 2000 |
| PBY321611T-102Y-N | 1000 | 50 | 0.150 | 1200 |
| PBY321611T-122Y-N | 1200 | 50 | 0.180 | 1000 |
| PBY321611T-152Y-N | 1500 | 50 | 0.200 | 800 |

Note: When ordering, please specify tolerance code. Tolerance : Y= $\pm 25\%$

- Operating temperature range - 55°C ~ 125°C(Including self - temperature rise)
- Rate Current : Applied the current to coils, the temperature rise shall not be more than 30°C
- Measure Equipment :
Z : HP4291A
RDC : HP4338B or CHEN HWA 502

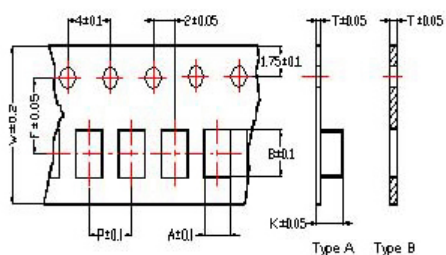
Test Instruments : Agilent E4991A Impedance / Material Analyzer



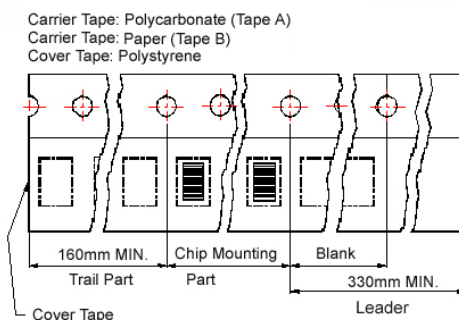
Please be sure to request approval specifications that provide further details of the products. Kindly note that the content of these specifications are subject to change or may be discontinued without advance notice. Please contact our sales department before ordering.

Packaging Specifications

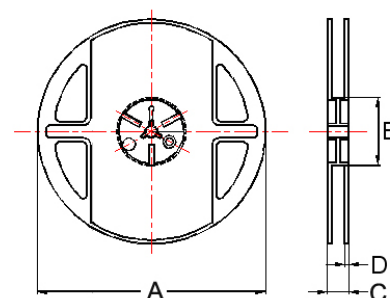
Tape Dimensions



Tape Material



Reel Dimensions



- ① : SBY / SBJ / NB / PB
- ② : SBY / SBJ / NB / PB / UPB / HF ③ : UPB
- ④ : SBK / SBJ / GB / PB / NB / UPB / VPB
- ⑤ : SBK / GB / PB / UPB ⑥ : SBY / SBK / PBY / UPB

Dimensions in mm

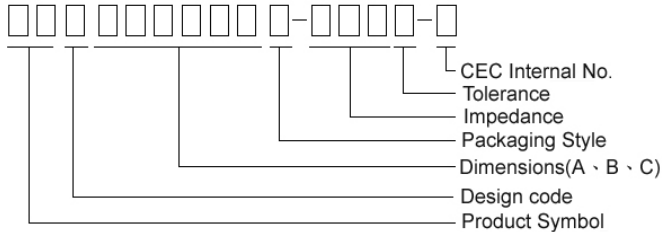
| TYPE | Tape Dimensions | | | | | | | | Reel Dimensions | | | | Quantity PCS / REEL |
|---------|-----------------|------|------|-----|-----|-----|------|------|-----------------|----|----|---|------------------------|
| | A | B | T | W | P | F | K | Tape | A | B | C | D | |
| ①060303 | 0.37 | 0.67 | 0.42 | 8.0 | 2.0 | 3.5 | - | B | 178 | 60 | 10 | 2 | 15000 |
| ②100505 | 0.62 | 1.12 | 0.60 | 8.0 | 2.0 | 3.5 | - | B | 178 | 60 | 12 | 2 | 10000 |
| ③160805 | 1.05 | 1.85 | 0.60 | 8.0 | 2.0 | 3.5 | - | B | 178 | 60 | 12 | 2 | 10000 |
| ④160808 | 1.05 | 1.85 | 0.95 | 8.0 | 4.0 | 3.5 | - | B | 178 | 60 | 12 | 2 | 4000 |
| ⑤201209 | 1.50 | 2.30 | 0.97 | 8.0 | 4.0 | 3.5 | - | B | 178 | 60 | 12 | 2 | 4000 |
| ⑥321611 | 1.88 | 3.50 | 0.22 | 8.0 | 4.0 | 3.5 | 1.27 | A | 178 | 60 | 12 | 2 | 3000 |

Multilayer Ferrite Chip Beads



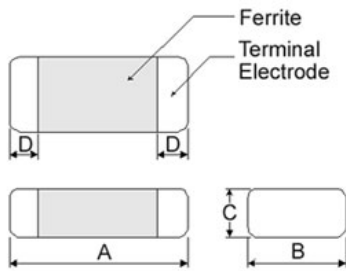
Chilisin offers a wide range of multi-layered ferrite chip beads with various sizes, frequency characteristics, and impedance values for EMI solutions. These ferrite formulas are used to compose seven types of EMI suppression chip beads: SB, GB, PB, UPB, NB, HF, and VPB series.

Product Identification

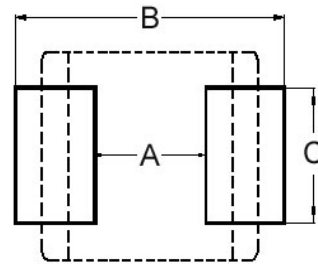


- Product symbol: SB, GB, PB, UPB, NB, HF, VPB
- Packaging: T : Tape and Reel ; B : Bulk
- Tolerance: Y = ± 25%; M = ± 20%; T:±30%
- Note: RoHS Compliant

Shape and Dimensions



Recommended Pattern



Dimensions in mm

| TYPE | A | B | C | D |
|---------|----------|-----------|----------|-----------|
| ①060303 | 0.6±0.03 | 0.30±0.03 | 0.3±0.03 | 0.15±0.05 |
| ②100505 | 1.0±0.10 | 0.50±0.10 | 0.5±0.10 | 0.25±0.10 |
| ③160805 | 1.6±0.15 | 0.80±0.15 | 0.5±0.15 | 0.3±0.2 |
| ④160808 | 1.6±0.15 | 0.80±0.15 | 0.8±0.15 | 0.3±0.2 |
| ⑤201209 | 2.0±0.20 | 1.25±0.20 | 0.9±0.20 | 0.5±0.3 |
| ⑥321611 | 3.2±0.20 | 1.60±0.20 | 1.1±0.20 | 0.5±0.3 |

- ① : SBY / SBJ / NB / PB ② : SBY / SBJ / NB / PB / UPB / HF
 ③ : UPB ④ : SBK / SBJ / GB / PB / NB / UPB / VPB
 ⑤ : SBK / GB / PB / UPB ⑥ : SBY / SBK / PB / UPB

Dimensions in mm

| TYPE | A | B | C |
|---------|-----------|-------------|-----------|
| ①060303 | 0.2 ~ 0.3 | 0.75 ~ 1.05 | 0.3 |
| ②100505 | 0.4 | 1.2 ~ 1.4 | 0.5 |
| ③160805 | 0.7 ~ 0.8 | 1.8 ~ 2.0 | 0.6 ~ 0.8 |
| ④160808 | 0.7 ~ 0.8 | 1.8 ~ 2.0 | 0.6 ~ 0.8 |
| ⑤201209 | 1.0 ~ 1.2 | 2.6 ~ 4.0 | 1.0 ~ 1.2 |
| ⑥321611 | 2.0 | 4.2 ~ 5.2 | 1.2 |

- * Don't apply narrower pattern than listed above to PB and UPB. Narrow pattern might cause excessive heat or open circuit.

Dimension Conversion

| Code | Dimension in mm (AxBxC) | EIA |
|--------|----------------------------|------|
| 060303 | 0.6X0.3X0.3 | 0201 |
| 100505 | 1.0X0.5X0.5 | 0402 |
| 160805 | 1.6x0.8x0.5 | 0603 |
| 160808 | 1.6x0.8x0.8 | 0603 |
| 201209 | 2.0x1.2x0.9 | 0805 |
| 321611 | 3.2x1.6x1.1 | 1206 |

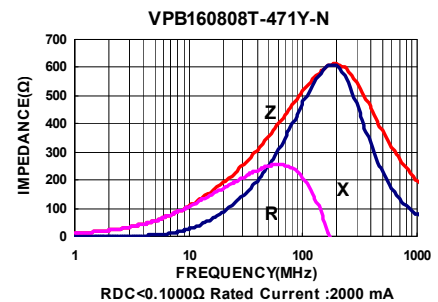
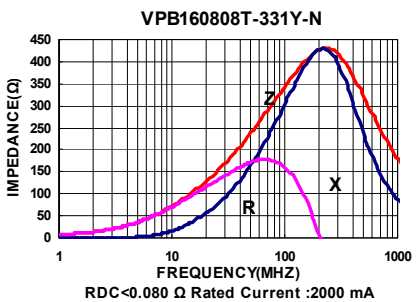
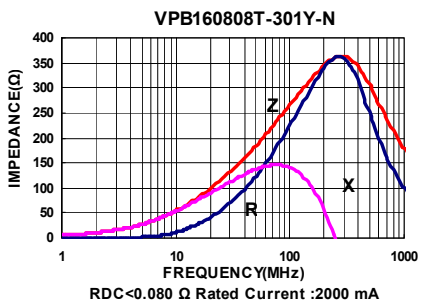
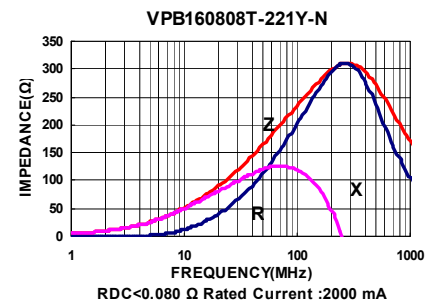
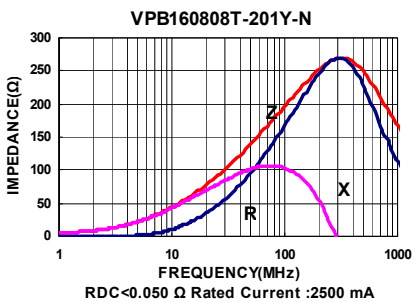
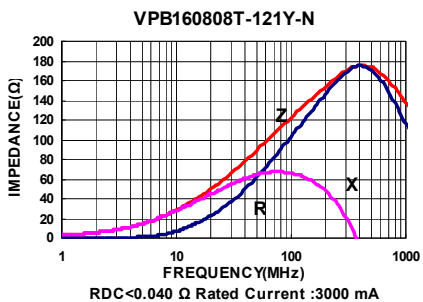
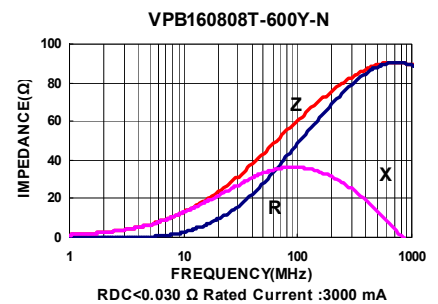
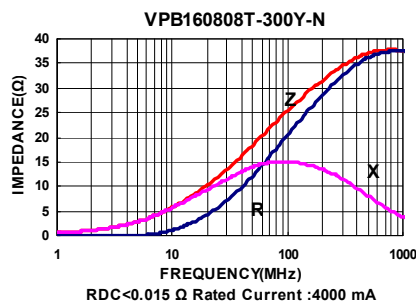
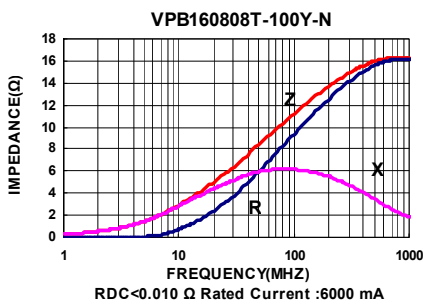
Electrical Characteristics

| Part Number | Impedance ($\Omega \pm 25\%$) | Test Frequency (MHz) | RDC (Ω) Max | Rated current (mA) Max |
|-------------------|---------------------------------|----------------------|----------------------|------------------------|
| VPB160808T-100Y-N | 10 | 100 | 0.010 | 6000 |
| VPB160808T-300Y-N | 30 | 100 | 0.015 | 4000 |
| VPB160808T-600Y-N | 60 | 100 | 0.030 | 3000 |
| VPB160808T-121Y-N | 120 | 100 | 0.040 | 3000 |
| VPB160808T-201Y-N | 200 | 100 | 0.050 | 2500 |
| VPB160808T-221Y-N | 220 | 100 | 0.080 | 2000 |
| VPB160808T-301Y-N | 300 | 100 | 0.080 | 2000 |
| VPB160808T-331Y-N | 330 | 100 | 0.080 | 2000 |
| VPB160808T-471Y-N | 470 | 100 | 0.100 | 2000 |
| VPB160808T-601Y-N | 600 | 100 | 0.100 | 2000 |

Note: When ordering, please specify tolerance code. Tolerance : Y \pm 25%

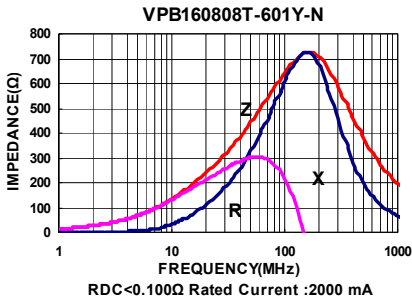
- Operating temperature range - 55°C ~ 125°C(Including self - temperature rise)
- Rate Current : Applied the current to coils, the temperature rise shall not be more than 30°C
- Measure Equipment :
Z : HP4291A
RDC : HP4338B or CHEN HWA 502

Test Instruments : Agilent E4991A Impedance / Material Analyzer



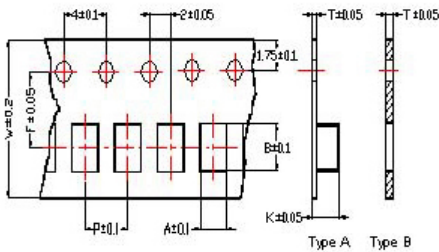
Please be sure to request approval specifications that provide further details of the products. Kindly note that the content of these specifications are subject to change or may be discontinued without advance notice. Please contact our sales department before ordering.

Test Instruments : Agilent E4991A Impedance / Material Analyzer

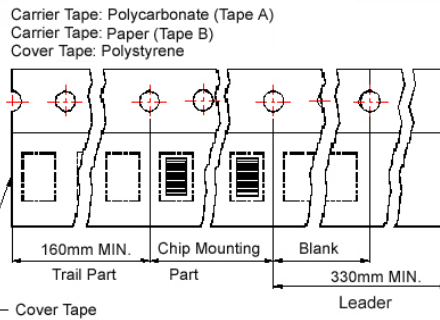


Packaging Specifications

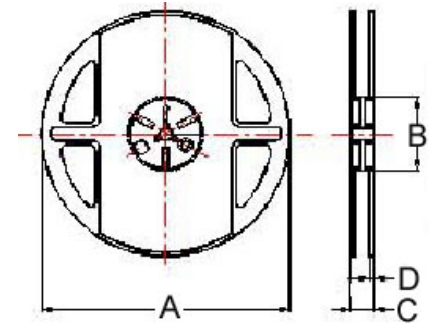
Tape Dimensions



Tape Material



Reel Dimensions



Dimensions in mm

| TYPE | Tape Dimensions | | | | | | | Reel Dimensions | | | | Quantity PCS / Reel |
|--------|-----------------|------|------|-----|-----|-----|-----------|-----------------|----|----|---|------------------------|
| | A | B | T | W | P | F | Tape Type | A | B | C | D | |
| 160808 | 1.05 | 1.85 | 0.95 | 8.0 | 4.0 | 3.5 | B | 178 | 60 | 12 | 2 | 4000 |

Please be sure to request approval specifications that provide further details of the products. Kindly note that the content of these specifications are subject to change or may be discontinued without advance notice. Please contact our sales department before ordering.

Multilayer Ferrite Chip Beads



Chilisin offers a wide range of multi-layered ferrite chip beads with various sizes, frequency characteristics, and impedance values for EMI solutions. These ferrite formulas are used to compose seven types of EMI suppression chip beads: SB, GB, PB, UPB, NB, HF, and VPB series.

Product Identification



- Product symbol: SB, GB, PB, UPB, NB, HF, VPB
- Packaging: T : Tape and Reel ; B : Bulk
- Tolerance: Y = $\pm 25\%$; M = $\pm 20\%$; T: $\pm 30\%$
- Note: RoHS Compliant

Shape and Dimensions



Recommended Pattern



Dimensions in mm

| TYPE | A | B | C | D |
|---------|----------------|-----------------|----------------|-----------------|
| ①060303 | 0.6 \pm 0.03 | 0.30 \pm 0.03 | 0.3 \pm 0.03 | 0.15 \pm 0.05 |
| ②100505 | 1.0 \pm 0.10 | 0.50 \pm 0.10 | 0.5 \pm 0.10 | 0.25 \pm 0.10 |
| ③160805 | 1.6 \pm 0.15 | 0.80 \pm 0.15 | 0.5 \pm 0.15 | 0.3 \pm 0.2 |
| ④160808 | 1.6 \pm 0.15 | 0.80 \pm 0.15 | 0.8 \pm 0.15 | 0.3 \pm 0.2 |
| ⑤201209 | 2.0 \pm 0.20 | 1.25 \pm 0.20 | 0.9 \pm 0.20 | 0.5 \pm 0.3 |
| ⑥321611 | 3.2 \pm 0.20 | 1.60 \pm 0.20 | 1.1 \pm 0.20 | 0.5 \pm 0.3 |

- ① : SBY / SBJ / NB / PB ② : SBY / SBJ / NB / PB / UPB / HF
 ③ : UPB ④ : SBK / SBJ / GB / PB / NB / UPB / VPB
 ⑤ : SBK / GB / PB / UPB ⑥ : SBY / SBK / PB / UPB

Dimensions in mm

| TYPE | A | B | C |
|---------|-----------|-------------|-----------|
| ①060303 | 0.2 ~ 0.3 | 0.75 ~ 1.05 | 0.3 |
| ②100505 | 0.4 | 1.2 ~ 1.4 | 0.5 |
| ③160805 | 0.7 ~ 0.8 | 1.8 ~ 2.0 | 0.6 ~ 0.8 |
| ④160808 | 0.7 ~ 0.8 | 1.8 ~ 2.0 | 0.6 ~ 0.8 |
| ⑤201209 | 1.0 ~ 1.2 | 2.6 ~ 4.0 | 1.0 ~ 1.2 |
| ⑥321611 | 2.0 | 4.2 ~ 5.2 | 1.2 |

- * Don't apply narrower pattern than listed above to PB and UPB. Narrow pattern might cause excessive heat or open circuit.

Dimension Conversion

| Code | Dimension in mm (AxBxC) | EIA |
|--------|----------------------------|------|
| 060303 | 0.6X0.3X0.3 | 0201 |
| 100505 | 1.0X0.5X0.5 | 0402 |
| 160805 | 1.6x0.8x0.5 | 0603 |
| 160808 | 1.6x0.8x0.8 | 0603 |
| 201209 | 2.0x1.2x0.9 | 0805 |
| 321611 | 3.2x1.6x1.1 | 1206 |

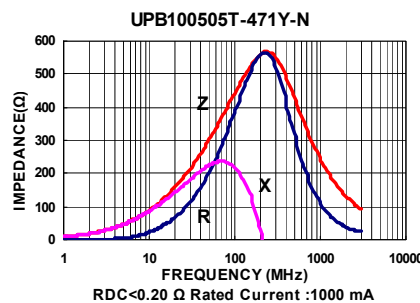
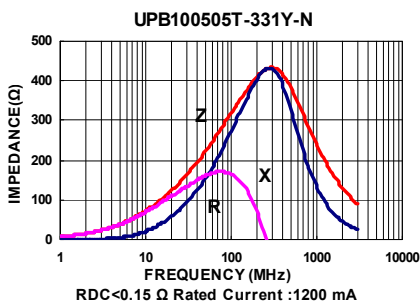
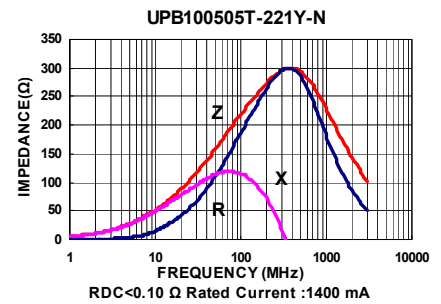
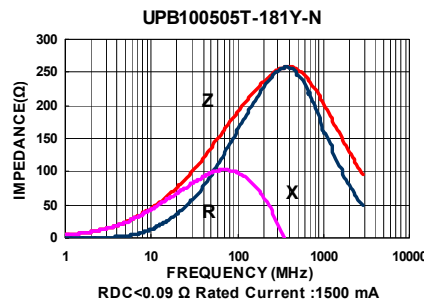
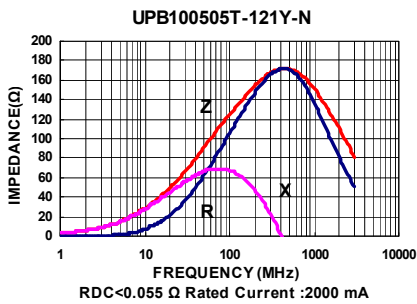
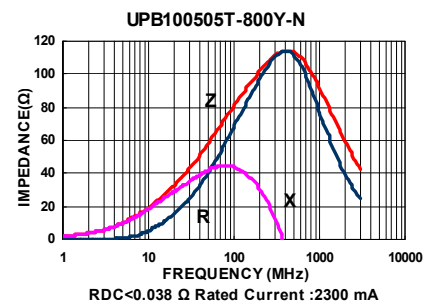
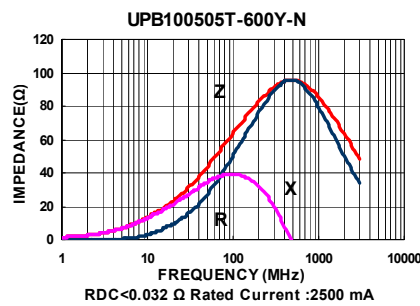
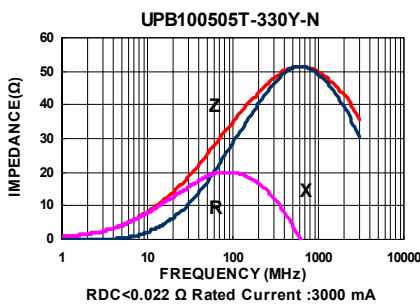
Electrical Characteristics

| Part Number | Impedance ($\Omega \pm 25\%$) | Test Frequency (MHz) | RDC (Ω) Max | Rated current (mA) Max |
|-------------------|------------------------------------|-------------------------|-------------------------|---------------------------|
| UPB100505T-330Y-N | 33 | 100 | 0.022 | 3000 |
| UPB100505T-600Y-N | 60 | 100 | 0.032 | 2500 |
| UPB100505T-800Y-N | 80 | 100 | 0.038 | 2300 |
| UPB100505T-121Y-N | 120 | 100 | 0.055 | 2000 |
| UPB100505T-181Y-N | 180 | 100 | 0.090 | 1500 |
| UPB100505T-221Y-N | 220 | 100 | 0.100 | 1400 |
| UPB100505T-331Y-N | 330 | 100 | 0.150 | 1200 |
| UPB100505T-471Y-N | 470 | 100 | 0.200 | 1000 |

Note: When ordering, please specify tolerance code. Tolerance : Y= $\pm 25\%$

- Operating temperature range - 55°C ~ 125°C(Including self - temperature rise)
- Rate Current : Applied the current to coils, the temperature rise shall not be more than 30°C
- Measure Equipment :
Z : HP4291A
RDC : HP4338B or CHEN HWA 502

Test Instruments : Agilent E4991A Impedance / Material Analyzer



Please be sure to request approval specifications that provide further details of the products. Kindly note that the content of these specifications are subject to change or may be discontinued without advance notice. Please contact our sales department before ordering.

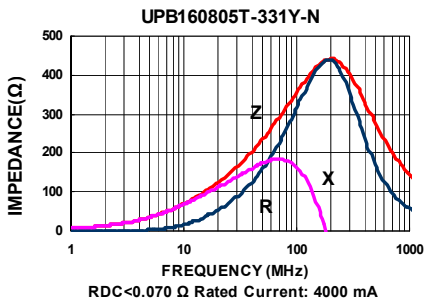
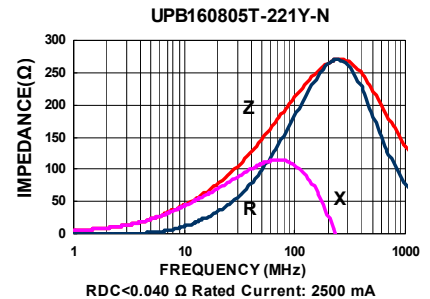
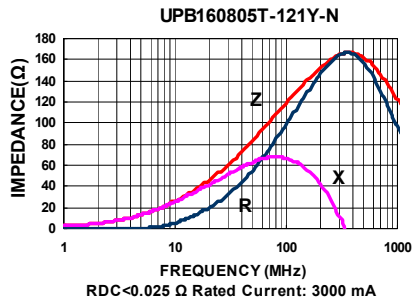
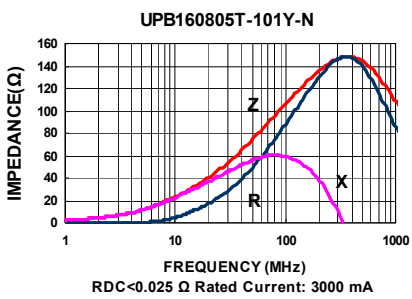
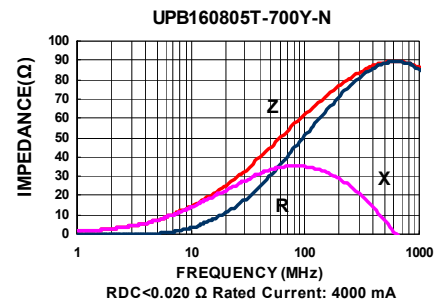
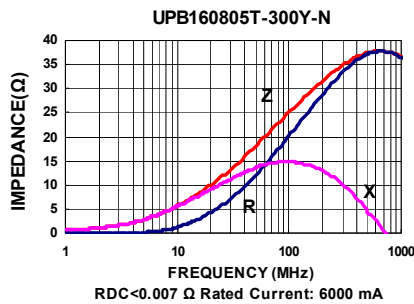
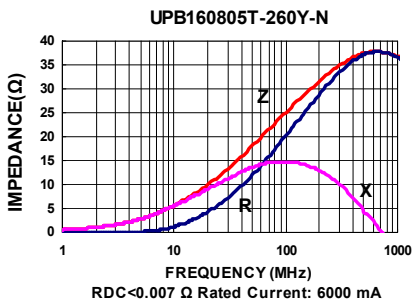
Electrical Characteristics

| Part Number | Impedance ($\Omega \pm 25\%$) | Test Frequency (MHz) | RDC (Ω) Max | Rated current (mA) Max |
|-------------------|------------------------------------|-------------------------|-------------------------|---------------------------|
| UPB160805T-260Y-N | 26 | 100 | 0.007 | 6000 |
| UPB160805T-300Y-N | 30 | 100 | 0.007 | 6000 |
| UPB160805T-700Y-N | 70 | 100 | 0.020 | 4000 |
| UPB160805T-101Y-N | 100 | 100 | 0.025 | 3000 |
| UPB160805T-121Y-N | 120 | 100 | 0.025 | 3000 |
| UPB160805T-221Y-N | 220 | 100 | 0.040 | 2500 |
| UPB160805T-331Y-N | 330 | 100 | 0.070 | 1500 |

Note: When ordering, please specify tolerance code. Tolerance : Y= $\pm 25\%$

- Operating temperature range - 55°C ~ 125°C(Including self - temperature rise)
- Rate Current : Applied the current to coils, the temperature rise shall not be more than 30°C
- Measure Equipment :
Z : HP4291A
RDC : HP4338B or CHEN HWA 502

Test Instruments : Agilent E4991A Impedance / Material Analyzer



Please be sure to request approval specifications that provide further details of the products. Kindly note that the content of these specifications are subject to change or may be discontinued without advance notice. Please contact our sales department before ordering.

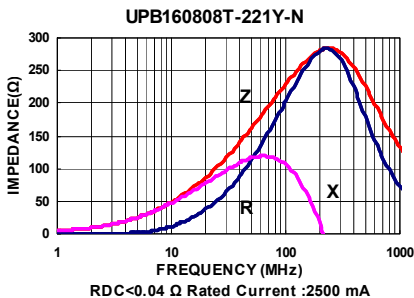
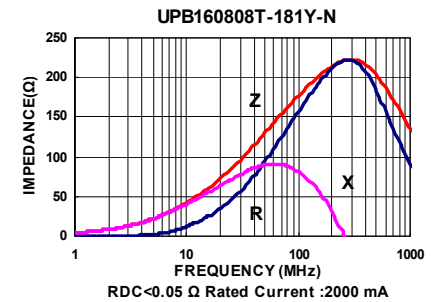
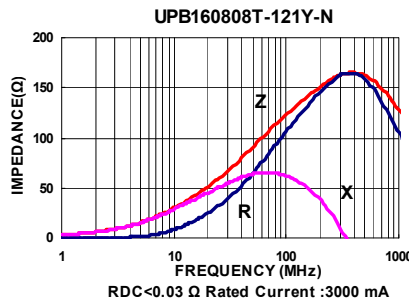
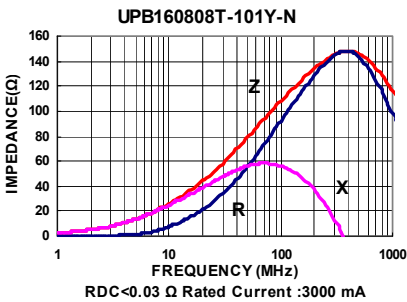
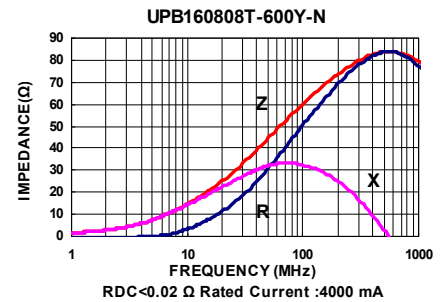
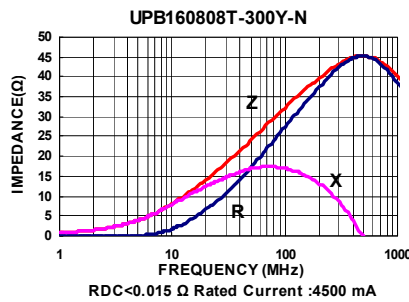
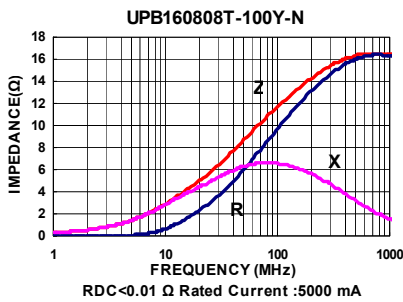
Electrical Characteristics

| Part Number | Impedance ($\Omega \pm 25\%$) | Test Frequency (MHz) | RDC (Ω) Max | Rated current (mA) Max |
|-------------------|------------------------------------|-------------------------|-------------------------|---------------------------|
| UPB160808T-100Y-N | 10 | 100 | 0.010 | 5000 |
| UPB160808T-300Y-N | 30 | 100 | 0.015 | 4500 |
| UPB160808T-600Y-N | 60 | 100 | 0.020 | 4000 |
| UPB160808T-700Y-N | 70 | 100 | 0.020 | 4000 |
| UPB160808T-101Y-N | 100 | 100 | 0.030 | 3000 |
| UPB160808T-121Y-N | 120 | 100 | 0.030 | 3000 |
| UPB160808T-181Y-N | 180 | 100 | 0.050 | 2000 |
| UPB160808T-221Y-N | 220 | 100 | 0.040 | 2500 |

Note: When ordering, please specify tolerance code. Tolerance : Y= $\pm 25\%$

- Operating temperature range - 55°C ~ 125°C(Including self - temperature rise)
- Rate Current : Applied the current to coils, the temperature rise shall not be more than 30°C
- Measure Equipment :
Z : HP4291A
RDC : HP4338B or CHEN HWA 502

Test Instruments : Agilent E4991A Impedance / Material Analyzer



Please be sure to request approval specifications that provide further details of the products. Kindly note that the content of these specifications are subject to change or may be discontinued without advance notice. Please contact our sales department before ordering.

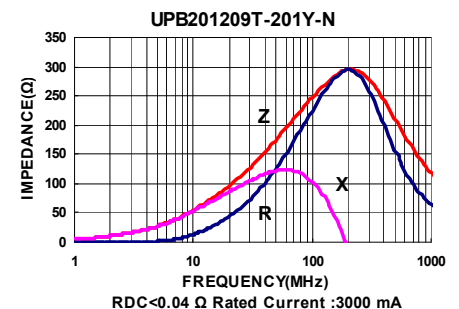
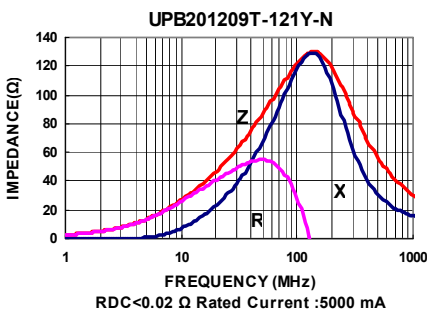
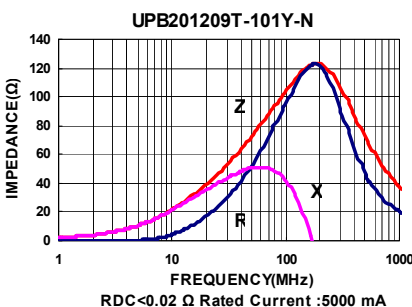
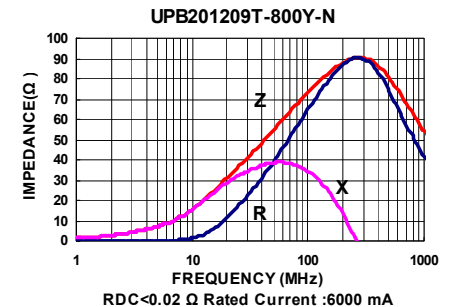
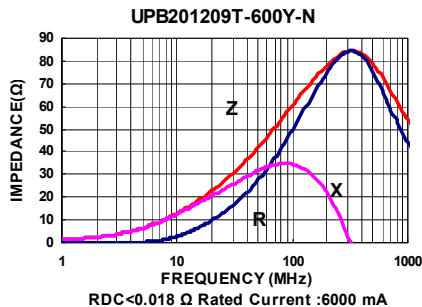
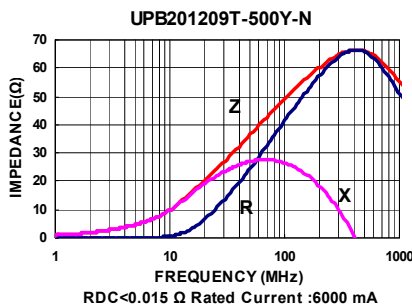
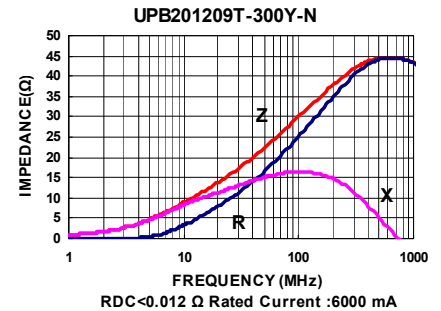
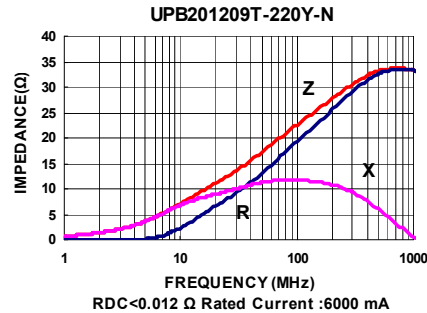
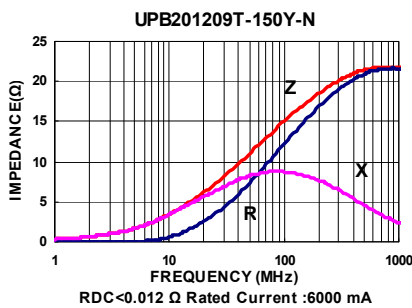
Electrical Characteristics

| Part Number | Impedance ($\Omega \pm 25\%$) | Test Frequency (MHz) | RDC (Ω) Max | Rated current (mA) Max |
|-------------------|---------------------------------|----------------------|----------------------|------------------------|
| UPB201209T-150Y-N | 15 | 100 | 0.012 | 6000 |
| UPB201209T-220Y-N | 22 | 100 | 0.012 | 6000 |
| UPB201209T-300Y-N | 30 | 100 | 0.012 | 6000 |
| UPB201209T-500Y-N | 50 | 100 | 0.015 | 6000 |
| UPB201209T-600Y-N | 60 | 100 | 0.018 | 6000 |
| UPB201209T-800Y-N | 80 | 100 | 0.02 | 6000 |
| UPB201209T-101Y-N | 100 | 100 | 0.02 | 5000 |
| UPB201209T-121Y-N | 120 | 100 | 0.02 | 5000 |
| UPB201209T-201Y-N | 200 | 100 | 0.04 | 3000 |
| UPB201209T-221Y-N | 220 | 100 | 0.04 | 3000 |
| UPB201209T-301Y-N | 300 | 100 | 0.05 | 3000 |
| UPB201209T-331Y-N | 330 | 100 | 0.05 | 3000 |

Note: When ordering, please specify tolerance code. Tolerance : Y $\pm 25\%$

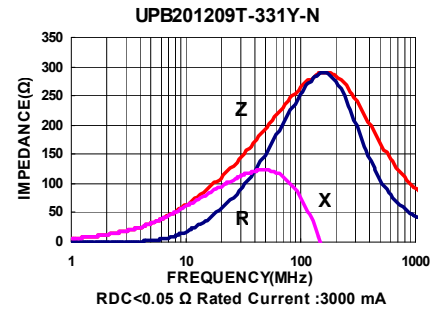
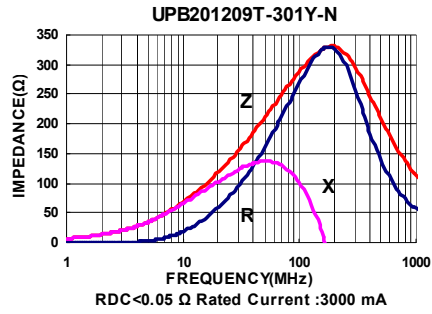
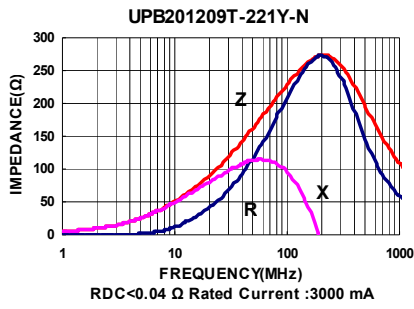
- Operating temperature range - 55°C ~ 125°C(Including self - temperature rise)
- Rate Current : Applied the current to coils, the temperature rise shall not be more than 30°C
- Measure Equipment :
Z : HP4291A
RDC : HP4338B or CHEN HWA 502

Test Instruments : Agilent E4991A Impedance / Material Analyzer



Please be sure to request approval specifications that provide further details of the products. Kindly note that the content of these specifications are subject to change or may be discontinued without advance notice. Please contact our sales department before ordering.

Test Instruments : Agilent E4991A Impedance / Material Analyzer



Please be sure to request approval specifications that provide further details of the products. Kindly note that the content of these specifications are subject to change or may be discontinued without advance notice. Please contact our sales department before ordering.

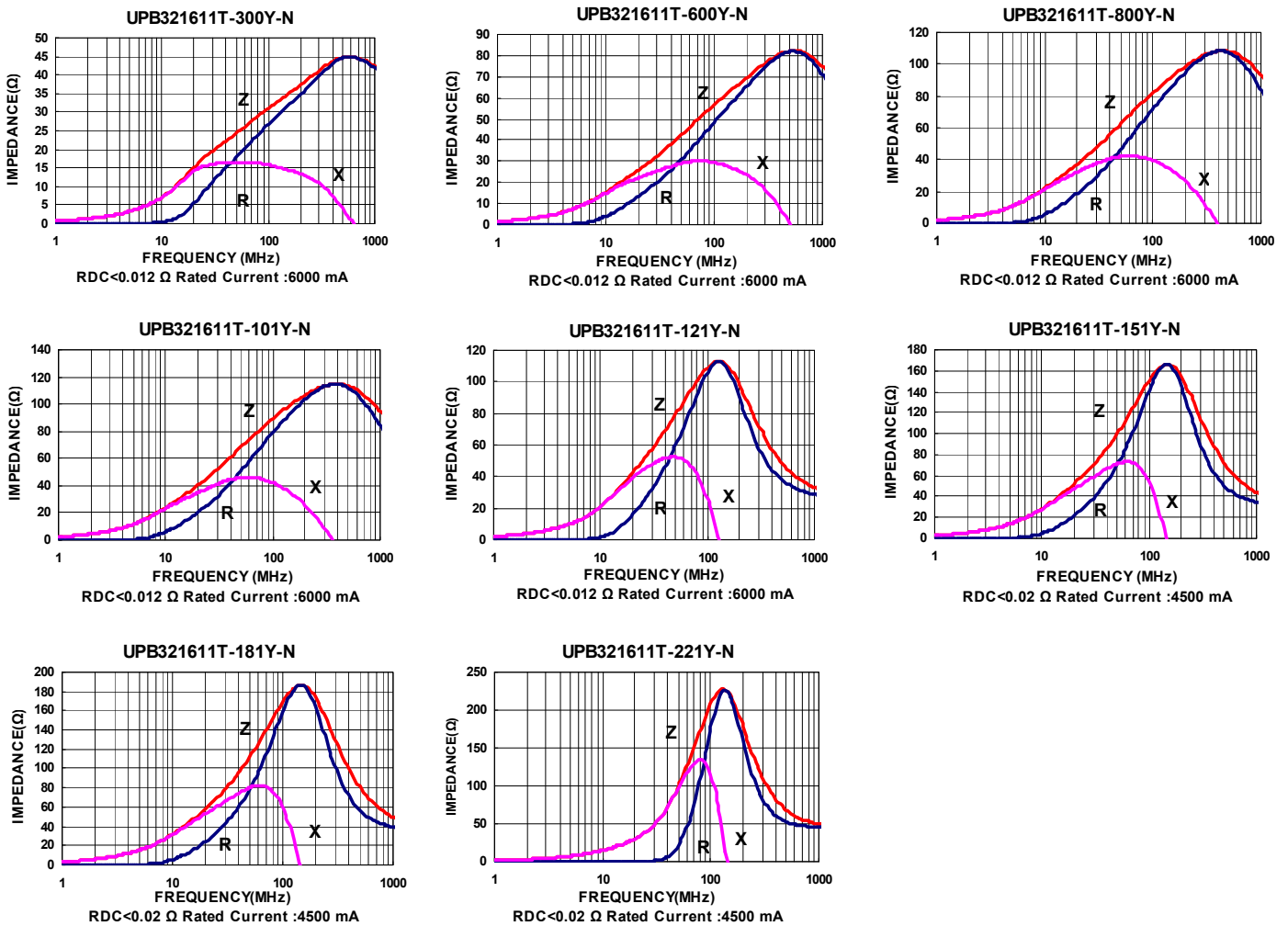
Electrical Characteristics

| Part Number | Impedance ($\Omega \pm 25\%$) | Test Frequency (MHz) | RDC (Ω) Max | Rated current (mA) Max |
|-------------------|------------------------------------|-------------------------|-------------------------|---------------------------|
| UPB321611T-300Y-N | 30 | 100 | 0.012 | 6000 |
| UPB321611T-600Y-N | 60 | 100 | 0.012 | 6000 |
| UPB321611T-800Y-N | 80 | 100 | 0.012 | 6000 |
| UPB321611T-101Y-N | 100 | 100 | 0.012 | 6000 |
| UPB321611T-121Y-N | 120 | 100 | 0.012 | 6000 |
| UPB321611T-151Y-N | 150 | 100 | 0.020 | 4500 |
| UPB321611T-181Y-N | 180 | 100 | 0.020 | 4500 |
| UPB321611T-221Y-N | 220 | 100 | 0.020 | 4500 |

Note: When ordering, please specify tolerance code. Tolerance : Y \pm 25%

- Operating temperature range - 55°C ~ 125°C(Including self - temperature rise)
- Rate Current : Applied the current to coils, the temperature rise shall not be more than 30°C
- Measure Equipment :
Z : HP4291A
RDC : HP4338B or CHEN HWA 502

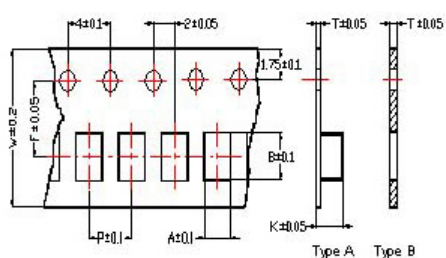
Test Instruments : Agilent E4991A Impedance / Material Analyzer



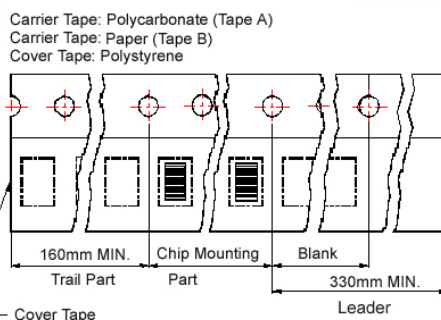
Please be sure to request approval specifications that provide further details of the products. Kindly note that the content of these specifications are subject to change or may be discontinued without advance notice. Please contact our sales department before ordering.

Packaging Specifications

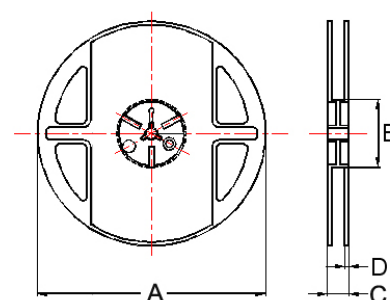
Tape Dimensions



Tape Material



Reel Dimensions



- ① : SBY / SBJ / NB / PB
- ② : SBY / SBJ / NB / PB / UPB / HF ③ : UPB
- ④ : SBK / SBJ / GB / PB / NB / UPB / VPB
- ⑤ : SBK / GB / PB / UPB ⑥ : SBY / SBK / PBY / UPB

Dimensions in mm

| TYPE | Tape Dimensions | | | | | | | | Reel Dimensions | | | | Quantity PCS / REEL |
|---------|-----------------|------|------|-----|-----|-----|------|------|-----------------|----|----|---|------------------------|
| | A | B | T | W | P | F | K | Tape | A | B | C | D | |
| ①060303 | 0.37 | 0.67 | 0.42 | 8.0 | 2.0 | 3.5 | - | B | 178 | 60 | 10 | 2 | 15000 |
| ②100505 | 0.62 | 1.12 | 0.60 | 8.0 | 2.0 | 3.5 | - | B | 178 | 60 | 12 | 2 | 10000 |
| ③160805 | 1.05 | 1.85 | 0.60 | 8.0 | 2.0 | 3.5 | - | B | 178 | 60 | 12 | 2 | 10000 |
| ④160808 | 1.05 | 1.85 | 0.95 | 8.0 | 4.0 | 3.5 | - | B | 178 | 60 | 12 | 2 | 4000 |
| ⑤201209 | 1.50 | 2.30 | 0.97 | 8.0 | 4.0 | 3.5 | - | B | 178 | 60 | 12 | 2 | 4000 |
| ⑥321611 | 1.88 | 3.50 | 0.22 | 8.0 | 4.0 | 3.5 | 1.27 | A | 178 | 60 | 12 | 2 | 3000 |

Multilayer Ferrite Chip Beads



Chilisin offers a wide range of multi-layered ferrite chip beads with various sizes, frequency characteristics, and impedance values for EMI solutions. These ferrite formulas are used to compose seven types of EMI suppression chip beads: SB, GB, PB, UPB, NB, HF, and VPB series.

Product Identification



- Product symbol: SB, GB, PB, UPB, NB, HF, VPB
- Packaging: T : Tape and Reel ; B : Bulk
- Tolerance: Y = $\pm 25\%$; M = $\pm 20\%$; T: $\pm 30\%$
- Note: RoHS Compliant

Shape and Dimensions



Recommended Pattern



Dimensions in mm

| TYPE | A | B | C | D |
|---------|----------------|-----------------|----------------|-----------------|
| ①060303 | 0.6 \pm 0.03 | 0.30 \pm 0.03 | 0.3 \pm 0.03 | 0.15 \pm 0.05 |
| ②100505 | 1.0 \pm 0.10 | 0.50 \pm 0.10 | 0.5 \pm 0.10 | 0.25 \pm 0.10 |
| ③160805 | 1.6 \pm 0.15 | 0.80 \pm 0.15 | 0.5 \pm 0.15 | 0.3 \pm 0.2 |
| ④160808 | 1.6 \pm 0.15 | 0.80 \pm 0.15 | 0.8 \pm 0.15 | 0.3 \pm 0.2 |
| ⑤201209 | 2.0 \pm 0.20 | 1.25 \pm 0.20 | 0.9 \pm 0.20 | 0.5 \pm 0.3 |
| ⑥321611 | 3.2 \pm 0.20 | 1.60 \pm 0.20 | 1.1 \pm 0.20 | 0.5 \pm 0.3 |

- ① : SBY / SBJ / NB / PB ② : SBY / SBJ / NB / PB / UPB / HF
 ③ : UPB ④ : SBK / SBJ / GB / PB / NB / UPB / VPB
 ⑤ : SBK / GB / PB / UPB ⑥ : SBY / SBK / PB / UPB

Dimensions in mm

| TYPE | A | B | C |
|---------|-----------|-------------|-----------|
| ①060303 | 0.2 ~ 0.3 | 0.75 ~ 1.05 | 0.3 |
| ②100505 | 0.4 | 1.2 ~ 1.4 | 0.5 |
| ③160805 | 0.7 ~ 0.8 | 1.8 ~ 2.0 | 0.6 ~ 0.8 |
| ④160808 | 0.7 ~ 0.8 | 1.8 ~ 2.0 | 0.6 ~ 0.8 |
| ⑤201209 | 1.0 ~ 1.2 | 2.6 ~ 4.0 | 1.0 ~ 1.2 |
| ⑥321611 | 2.0 | 4.2 ~ 5.2 | 1.2 |

- * Don't apply narrower pattern than listed above to PB and UPB. Narrow pattern might cause excessive heat or open circuit.

Dimension Conversion

| Code | Dimension in mm (AxBxC) | EIA |
|--------|----------------------------|------|
| 060303 | 0.6X0.3X0.3 | 0201 |
| 100505 | 1.0X0.5X0.5 | 0402 |
| 160805 | 1.6x0.8x0.5 | 0603 |
| 160808 | 1.6x0.8x0.8 | 0603 |
| 201209 | 2.0x1.2x0.9 | 0805 |
| 321611 | 3.2x1.6x1.1 | 1206 |

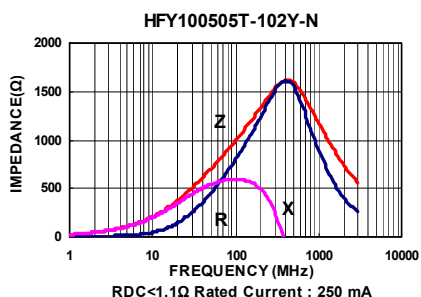
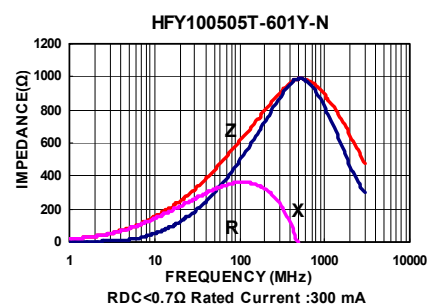
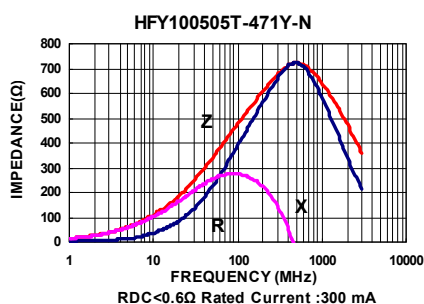
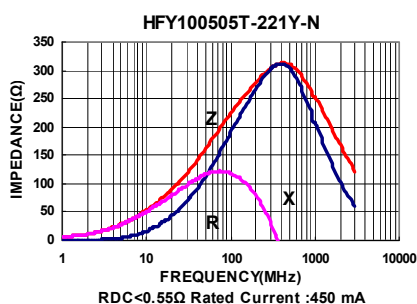
Electrical Characteristics

| Part Number | Impedance ($\Omega \pm 25\%$) | Test Frequency (MHz) | Impedance ($\Omega \pm 40\%$) | Test Frequency (MHz) | RDC (Ω) Max | Rated current (mA) Max |
|-------------------|------------------------------------|-------------------------|------------------------------------|-------------------------|-------------------------|---------------------------|
| HFY100505T-221Y-N | 220 | 100 | 270 | 1000 | 0.55 | 450 |
| HFY100505T-301Y-N | 300 | 100 | 450 | 1000 | 0.55 | 350 |
| HFY100505T-471Y-N | 470 | 100 | 650 | 1000 | 0.60 | 300 |
| HFY100505T-601Y-N | 600 | 100 | 1000 | 1000 | 0.7 | 300 |
| HFY100505T-102Y-N | 1000 | 100 | 1400 | 1000 | 1.1 | 250 |

Note: When ordering, please specify tolerance code. Tolerance : Y= $\pm 25\%$

- Operating temperature range - 55°C ~ 125°C(Including self - temperature rise)
- Rate Current : Applied the current to coils, the temperature rise shall not be more than 30°C
- Measure Equipment :
Z : HP4291A
RDC : HP4338B or CHEN HWA 502

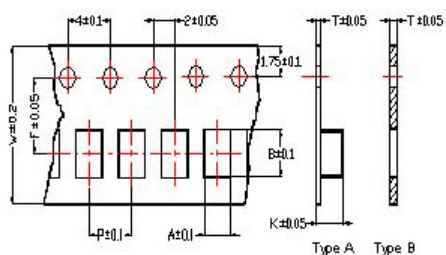
Test Instruments : Agilent E4991A Impedance / Material Analyzer



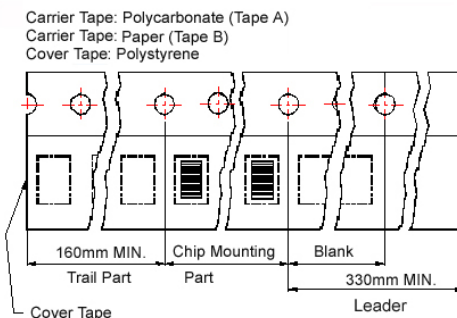
Please be sure to request approval specifications that provide further details of the products. Kindly note that the content of these specifications are subject to change or may be discontinued without advance notice. Please contact our sales department before ordering.

Packaging Specifications

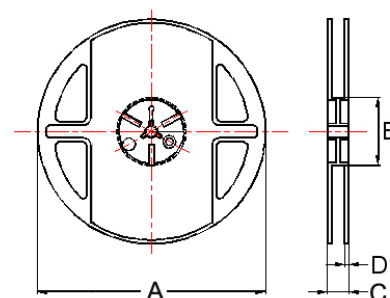
Tape Dimensions



Tape Material



Reel Dimensions



- ① : SBY / SBJ / NB / PB
- ② : SBY / SBJ / NB / PB / UPB / HF ③ : UPB
- ④ : SBK / SBJ / GB / PB / NB / UPB / VPB
- ⑤ : SBK / GB / PB / UPB ⑥ : SBY / SBK / PBY / UPB

Dimensions in mm

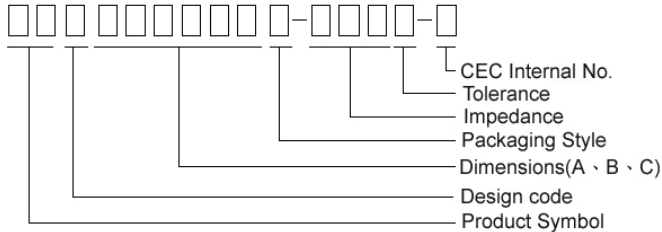
| TYPE | Tape Dimensions | | | | | | | | Reel Dimensions | | | | Quantity PCS / REEL |
|---------|-----------------|------|------|-----|-----|-----|------|------|-----------------|----|----|---|------------------------|
| | A | B | T | W | P | F | K | Tape | A | B | C | D | |
| ①060303 | 0.37 | 0.67 | 0.42 | 8.0 | 2.0 | 3.5 | - | B | 178 | 60 | 10 | 2 | 15000 |
| ②100505 | 0.62 | 1.12 | 0.60 | 8.0 | 2.0 | 3.5 | - | B | 178 | 60 | 12 | 2 | 10000 |
| ③160805 | 1.05 | 1.85 | 0.60 | 8.0 | 2.0 | 3.5 | - | B | 178 | 60 | 12 | 2 | 10000 |
| ④160808 | 1.05 | 1.85 | 0.95 | 8.0 | 4.0 | 3.5 | - | B | 178 | 60 | 12 | 2 | 4000 |
| ⑤201209 | 1.50 | 2.30 | 0.97 | 8.0 | 4.0 | 3.5 | - | B | 178 | 60 | 12 | 2 | 4000 |
| ⑥321611 | 1.88 | 3.50 | 0.22 | 8.0 | 4.0 | 3.5 | 1.27 | A | 178 | 60 | 12 | 2 | 3000 |

Multilayer Ferrite Chip Beads



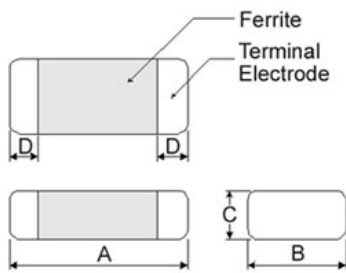
Chilisin offers a wide range of multi-layered ferrite chip beads with various sizes, frequency characteristics, and impedance values for EMI solutions. These ferrite formulas are used to compose seven types of EMI suppression chip beads: SB, GB, PB, UPB, NB, HF, and VPB series.

Product Identification

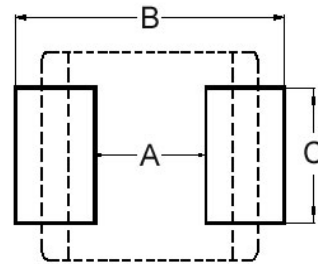


- Product symbol: SB, GB, PB, UPB, NB, HF, VPB
- Packaging: T : Tape and Reel ; B : Bulk
- Tolerance: Y = ± 25%; M = ± 20%; T:±30%
- Note: RoHS Compliant

Shape and Dimensions



Recommended Pattern



Dimensions in mm

| TYPE | A | B | C | D |
|---------|----------|-----------|----------|-----------|
| ①060303 | 0.6±0.03 | 0.30±0.03 | 0.3±0.03 | 0.15±0.05 |
| ②100505 | 1.0±0.10 | 0.50±0.10 | 0.5±0.10 | 0.25±0.10 |
| ③160805 | 1.6±0.15 | 0.80±0.15 | 0.5±0.15 | 0.3±0.2 |
| ④160808 | 1.6±0.15 | 0.80±0.15 | 0.8±0.15 | 0.3±0.2 |
| ⑤201209 | 2.0±0.20 | 1.25±0.20 | 0.9±0.20 | 0.5±0.3 |
| ⑥321611 | 3.2±0.20 | 1.60±0.20 | 1.1±0.20 | 0.5±0.3 |

- ① : SBY / SBJ / NB / PB ② : SBY / SBJ / NB / PB / UPB / HF
 ③ : UPB ④ : SBK / SBJ / GB / PB / NB / UPB / VPB
 ⑤ : SBK / GB / PB / UPB ⑥ : SBY / SBK / PB / UPB

Dimensions in mm

| TYPE | A | B | C |
|---------|-----------|-------------|-----------|
| ①060303 | 0.2 ~ 0.3 | 0.75 ~ 1.05 | 0.3 |
| ②100505 | 0.4 | 1.2 ~ 1.4 | 0.5 |
| ③160805 | 0.7 ~ 0.8 | 1.8 ~ 2.0 | 0.6 ~ 0.8 |
| ④160808 | 0.7 ~ 0.8 | 1.8 ~ 2.0 | 0.6 ~ 0.8 |
| ⑤201209 | 1.0 ~ 1.2 | 2.6 ~ 4.0 | 1.0 ~ 1.2 |
| ⑥321611 | 2.0 | 4.2 ~ 5.2 | 1.2 |

- * Don't apply narrower pattern than listed above to PB and UPB. Narrow pattern might cause excessive heat or open circuit.

Dimension Conversion

| Code | Dimension in mm (AxBxC) | EIA |
|--------|----------------------------|------|
| 060303 | 0.6X0.3X0.3 | 0201 |
| 100505 | 1.0X0.5X0.5 | 0402 |
| 160805 | 1.6x0.8x0.5 | 0603 |
| 160808 | 1.6x0.8x0.8 | 0603 |
| 201209 | 2.0x1.2x0.9 | 0805 |
| 321611 | 3.2x1.6x1.1 | 1206 |

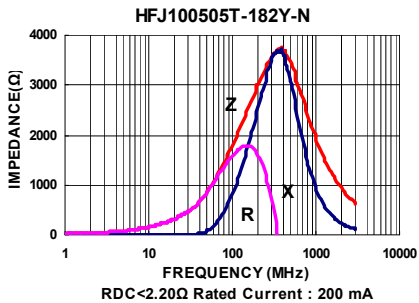
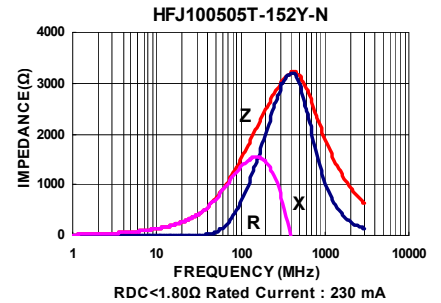
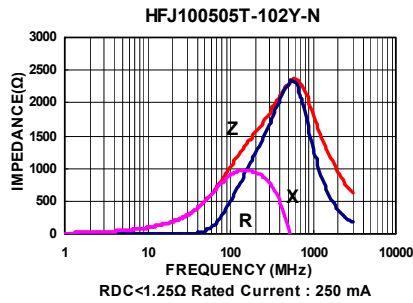
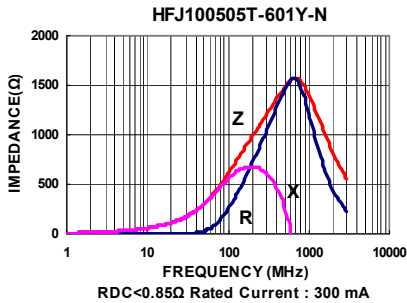
Electrical Characteristics

| Part Number | Impedance ($\Omega \pm 25\%$) | Test Frequency (MHz) | Impedance ($\Omega \pm 40\%$) | Test Frequency (MHz) | RDC (Ω) Max | Rated current (mA) Max |
|-------------------|------------------------------------|-------------------------|------------------------------------|-------------------------|-------------------------|---------------------------|
| HFJ100505T-601Y-N | 600 | 100 | 1400 | 1000 | 0.85 | 300 |
| HFJ100505T-102Y-N | 1000 | 100 | 2000 | 1000 | 1.25 | 250 |
| HFJ100505T-152Y-N | 1500 | 100 | 2400 | 1000 | 1.80 | 230 |
| HFJ100505T-182Y-N | 1800 | 100 | 2700 | 1000 | 2.20 | 200 |

Note: When ordering, please specify tolerance code. Tolerance : Y \pm 25%

- Operating temperature range - 55°C ~ 125°C(Including self - temperature rise)
- Rate Current : Applied the current to coils, the temperature rise shall not be more than 30°C
- Measure Equipment :
Z : HP4291A
RDC : HP4338B or CHEN HWA 502

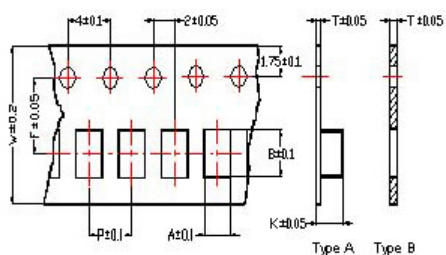
Test Instruments : Agilent E4991A Impedance / Material Analyzer



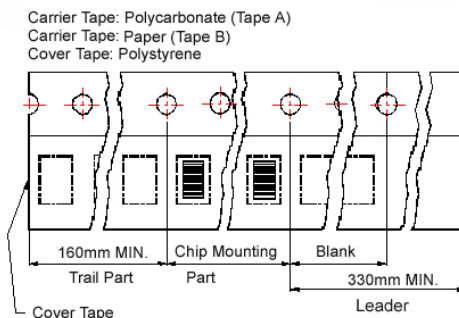
Please be sure to request approval specifications that provide further details of the products. Kindly note that the content of these specifications are subject to change or may be discontinued without advance notice. Please contact our sales department before ordering.

Packaging Specifications

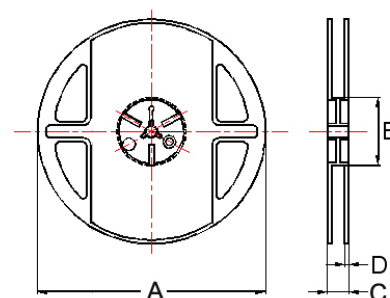
Tape Dimensions



Tape Material



Reel Dimensions



- ① : SBY / SBJ / NB / PB
- ② : SBY / SBJ / NB / PB / UPB / HF ③ : UPB
- ④ : SBK / SBJ / GB / PB / NB / UPB / VPB
- ⑤ : SBK / GB / PB / UPB ⑥ : SBY / SBK / PBY / UPB

Dimensions in mm

| TYPE | Tape Dimensions | | | | | | | | Reel Dimensions | | | | Quantity PCS / REEL |
|---------|-----------------|------|------|-----|-----|-----|------|------|-----------------|----|----|---|------------------------|
| | A | B | T | W | P | F | K | Tape | A | B | C | D | |
| ①060303 | 0.37 | 0.67 | 0.42 | 8.0 | 2.0 | 3.5 | - | B | 178 | 60 | 10 | 2 | 15000 |
| ②100505 | 0.62 | 1.12 | 0.60 | 8.0 | 2.0 | 3.5 | - | B | 178 | 60 | 12 | 2 | 10000 |
| ③160805 | 1.05 | 1.85 | 0.60 | 8.0 | 2.0 | 3.5 | - | B | 178 | 60 | 12 | 2 | 10000 |
| ④160808 | 1.05 | 1.85 | 0.95 | 8.0 | 4.0 | 3.5 | - | B | 178 | 60 | 12 | 2 | 4000 |
| ⑤201209 | 1.50 | 2.30 | 0.97 | 8.0 | 4.0 | 3.5 | - | B | 178 | 60 | 12 | 2 | 4000 |
| ⑥321611 | 1.88 | 3.50 | 0.22 | 8.0 | 4.0 | 3.5 | 1.27 | A | 178 | 60 | 12 | 2 | 3000 |

Multilayer Ferrite Chip Beads



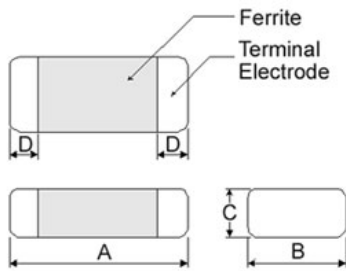
Chilisin offers a wide range of multi-layered ferrite chip beads with various sizes, frequency characteristics, and impedance values for EMI solutions. These ferrite formulas are used to compose seven types of EMI suppression chip beads: SB, GB, PB, UPB, NB, HF, and VPB series.

Product Identification

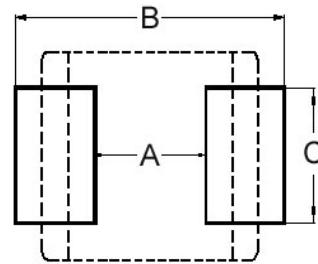


- Product symbol: SB, GB, PB, UPB, NB, HF, VPB
- Packaging: T : Tape and Reel ; B : Bulk
- Tolerance: Y = $\pm 25\%$; M = $\pm 20\%$; T: $\pm 30\%$
- Note: RoHS Compliant

Shape and Dimensions



Recommended Pattern



Dimensions in mm

| TYPE | A | B | C | D |
|---------|----------------|-----------------|----------------|-----------------|
| ①060303 | 0.6 \pm 0.03 | 0.30 \pm 0.03 | 0.3 \pm 0.03 | 0.15 \pm 0.05 |
| ②100505 | 1.0 \pm 0.10 | 0.50 \pm 0.10 | 0.5 \pm 0.10 | 0.25 \pm 0.10 |
| ③160805 | 1.6 \pm 0.15 | 0.80 \pm 0.15 | 0.5 \pm 0.15 | 0.3 \pm 0.2 |
| ④160808 | 1.6 \pm 0.15 | 0.80 \pm 0.15 | 0.8 \pm 0.15 | 0.3 \pm 0.2 |
| ⑤201209 | 2.0 \pm 0.20 | 1.25 \pm 0.20 | 0.9 \pm 0.20 | 0.5 \pm 0.3 |
| ⑥321611 | 3.2 \pm 0.20 | 1.60 \pm 0.20 | 1.1 \pm 0.20 | 0.5 \pm 0.3 |

- ① : SBY / SBJ / NB / PB ② : SBY / SBJ / NB / PB / UPB / HF
 ③ : UPB ④ : SBK / SBJ / GB / PB / NB / UPB / VPB
 ⑤ : SBK / GB / PB / UPB ⑥ : SBY / SBK / PB / UPB

Dimensions in mm

| TYPE | A | B | C |
|---------|-----------|-------------|-----------|
| ①060303 | 0.2 ~ 0.3 | 0.75 ~ 1.05 | 0.3 |
| ②100505 | 0.4 | 1.2 ~ 1.4 | 0.5 |
| ③160805 | 0.7 ~ 0.8 | 1.8 ~ 2.0 | 0.6 ~ 0.8 |
| ④160808 | 0.7 ~ 0.8 | 1.8 ~ 2.0 | 0.6 ~ 0.8 |
| ⑤201209 | 1.0 ~ 1.2 | 2.6 ~ 4.0 | 1.0 ~ 1.2 |
| ⑥321611 | 2.0 | 4.2 ~ 5.2 | 1.2 |

- * Don't apply narrower pattern than listed above to PB and UPB. Narrow pattern might cause excessive heat or open circuit.

Dimension Conversion

| Code | Dimension in mm (AxBxC) | EIA |
|--------|----------------------------|------|
| 060303 | 0.6X0.3X0.3 | 0201 |
| 100505 | 1.0X0.5X0.5 | 0402 |
| 160805 | 1.6x0.8x0.5 | 0603 |
| 160808 | 1.6x0.8x0.8 | 0603 |
| 201209 | 2.0x1.2x0.9 | 0805 |
| 321611 | 3.2x1.6x1.1 | 1206 |

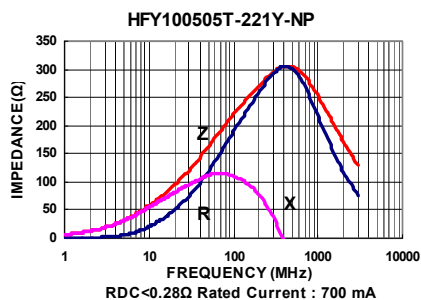
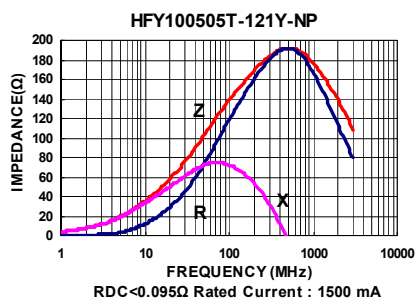
Electrical Characteristics

| Part Number | Impedance ($\Omega \pm 25\%$) | Test Frequency (MHz) | Impedance ($\Omega \pm 40\%$) | Test Frequency (MHz) | RDC (Ω) Max | Rated current (mA) Max |
|--------------------|------------------------------------|-------------------------|------------------------------------|-------------------------|-------------------------|---------------------------|
| HFY100505T-121Y-NP | 120 | 100 | 150 | 1000 | 0.095 | 1500 |
| HFY100505T-221Y-NP | 220 | 100 | 270 | 1000 | 0.280 | 700 |

Note: When ordering, please specify tolerance code. Tolerance : Y= $\pm 25\%$

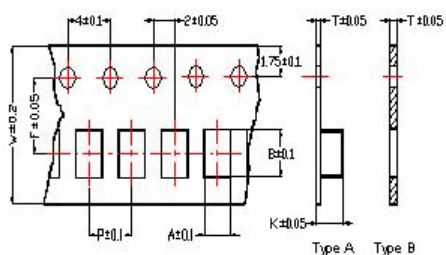
- Operating temperature range - 55°C ~ 125°C(Including self - temperature rise)
- Rate Current : Applied the current to coils, the temperature rise shall not be more than 30°C
- Measure Equipment :
Z : HP4291A
RDC : HP4338B or CHEN HWA 502

Test Instruments : Agilent E4991A Impedance / Material Analyzer

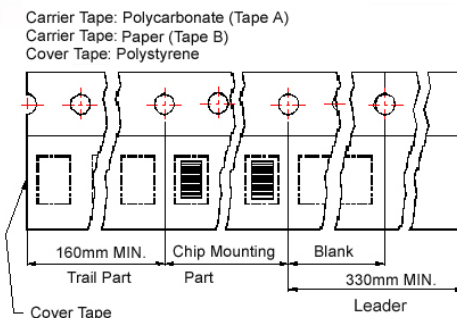


Packaging Specifications

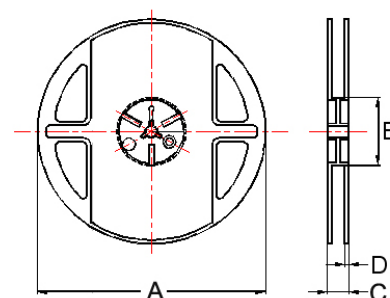
Tape Dimensions



Tape Material



Reel Dimensions



- ① : SBY / SBJ / NB / PB
- ② : SBY / SBJ / NB / PB / UPB / HF ③ : UPB
- ④ : SBK / SBJ / GB / PB / NB / UPB / VPB
- ⑤ : SBK / GB / PB / UPB ⑥ : SBY / SBK / PBY / UPB

Dimensions in mm

| TYPE | Tape Dimensions | | | | | | | | Reel Dimensions | | | | Quantity PCS / REEL |
|---------|-----------------|------|------|-----|-----|-----|------|------|-----------------|----|----|---|------------------------|
| | A | B | T | W | P | F | K | Tape | A | B | C | D | |
| ①060303 | 0.37 | 0.67 | 0.42 | 8.0 | 2.0 | 3.5 | - | B | 178 | 60 | 10 | 2 | 15000 |
| ②100505 | 0.62 | 1.12 | 0.60 | 8.0 | 2.0 | 3.5 | - | B | 178 | 60 | 12 | 2 | 10000 |
| ③160805 | 1.05 | 1.85 | 0.60 | 8.0 | 2.0 | 3.5 | - | B | 178 | 60 | 12 | 2 | 10000 |
| ④160808 | 1.05 | 1.85 | 0.95 | 8.0 | 4.0 | 3.5 | - | B | 178 | 60 | 12 | 2 | 4000 |
| ⑤201209 | 1.50 | 2.30 | 0.97 | 8.0 | 4.0 | 3.5 | - | B | 178 | 60 | 12 | 2 | 4000 |
| ⑥321611 | 1.88 | 3.50 | 0.22 | 8.0 | 4.0 | 3.5 | 1.27 | A | 178 | 60 | 12 | 2 | 3000 |

MCF Series



The MCF series is a type of common mode filter designed and produced using the multilayer technology. The multilayer construction allows for excellent noise suppression for signal lines used in high-speed and high-density digital equipment such as personal computers, facsimiles, DSC, STB, etc. Both standard series and custom-design products are available.

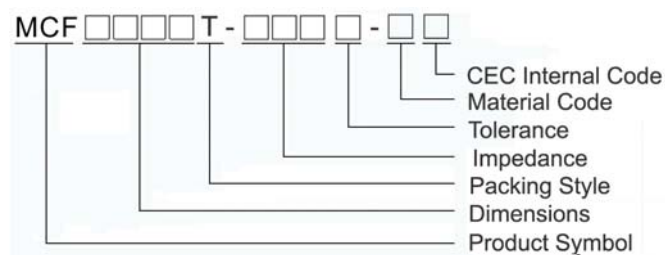
Features

- Multilayer construction for effective suppression of common mode noise at high frequency
- Excellent solderability
- Compact design

Applications

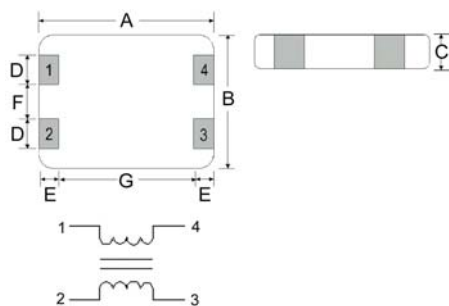
- High speed interfaces (IEEE1394, USB2.0, and LVDS) in electronic devices
- PDP, LCD TV, DVD player, PC, Audio player, DSC
- Digital audio and video equipment such as PDAs, DVC, CD player, MD player, etc.

Product Identification

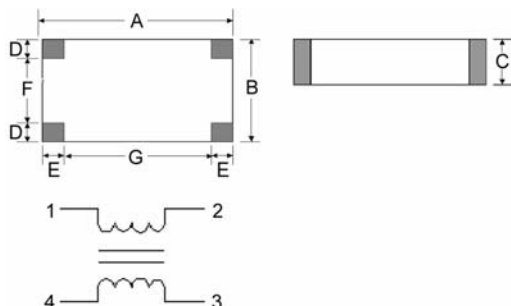


Shape and Dimensions

MCF11



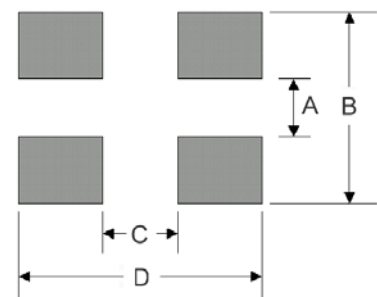
MCF21



Dimensions in mm

| TYPE | A | B | C | D | E | F | G |
|-------|-----------|-----------|-----------|-----------|-----------|-----------|-----------|
| MCF11 | 1.25±0.15 | 1.00±0.15 | 0.60±0.15 | 0.30±0.15 | 0.20±0.15 | 0.25±0.15 | 0.85±0.15 |
| MCF21 | 2.00±0.20 | 1.25±0.20 | 1.00±0.20 | 0.35±0.10 | 0.40±0.10 | 0.55±0.20 | 1.20±0.20 |

Recommended Pattern



Dimensions in mm

| TYPE | A | B | C | D |
|-------|---------|---------|---------|---------|
| MCF11 | 0.2~0.3 | 0.7~1.0 | 0.7~0.8 | 1.6~1.9 |
| MCF21 | 0.50 | 1.30 | 0.80 | 2.60 |

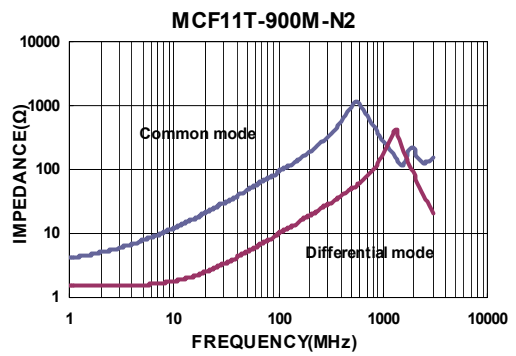
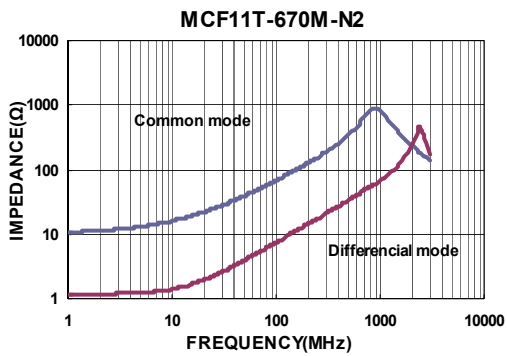
Electrical Characteristics

| Part Number | Impedance (Ω) | Test Frequency (MHz) | Tolerance (±%) | RDC (Ω)Max | Rated Current (mA)Max | Rated Voltage (Vdc)Max | Insulation Resistance (MΩ) Min |
|----------------|------------------|-------------------------|-------------------|---------------|--------------------------|---------------------------|-----------------------------------|
| MCF11T-670M-N2 | 67 | 100 | 20 | 1.35 | 200 | 10 | 200 |
| MCF11T-900M-N2 | 90 | 100 | 20 | 1.45 | 200 | 10 | 200 |

Note: When ordering, please specify tolerance code. Tolerance: M=±20%

- Operating temperature range - 40°C ~ 105°C(Including self - temperature rise)
- Rated current : ΔT=30°C
- Measure Equipment :
Z : Agilent E4991
RDC : HP4338B or CHEN HWA 502(Single Wire Test Value)
Insulation Resistance : Agilent HP4339B

Test Instruments : Agilent E4991A Material/Impedance Analyzer



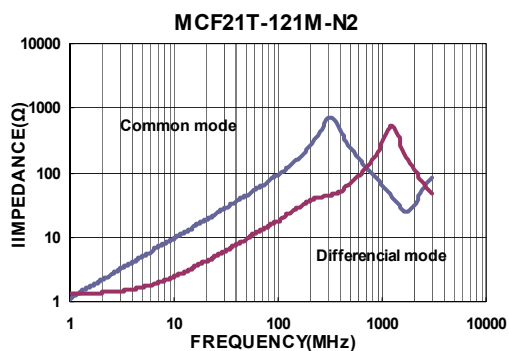
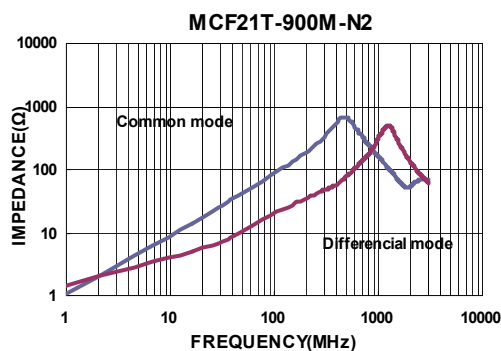
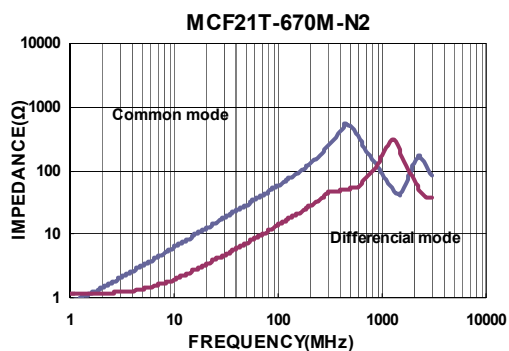
Electrical Characteristics

| Part Number | Impedance (Ω) | Tolerance (±%) | Test Frequency (MHz) | RDC (Ω)Max | Rated Current (mA)Max | Rated Voltage (Vdc)Max | Insulation Resistance (MΩ) Min |
|----------------|---------------|----------------|----------------------|------------|-----------------------|------------------------|--------------------------------|
| MCF21T-670M-N2 | 67 | 20 | 100 | 0.80 | 400 | 30 | 200 |
| MCF21T-900M-N2 | 90 | 20 | 100 | 0.85 | 400 | 30 | 200 |
| MCF21T-121M-N2 | 120 | 20 | 100 | 0.90 | 300 | 30 | 200 |

Note: When ordering, please specify tolerance code. Tolerance: M=±20%

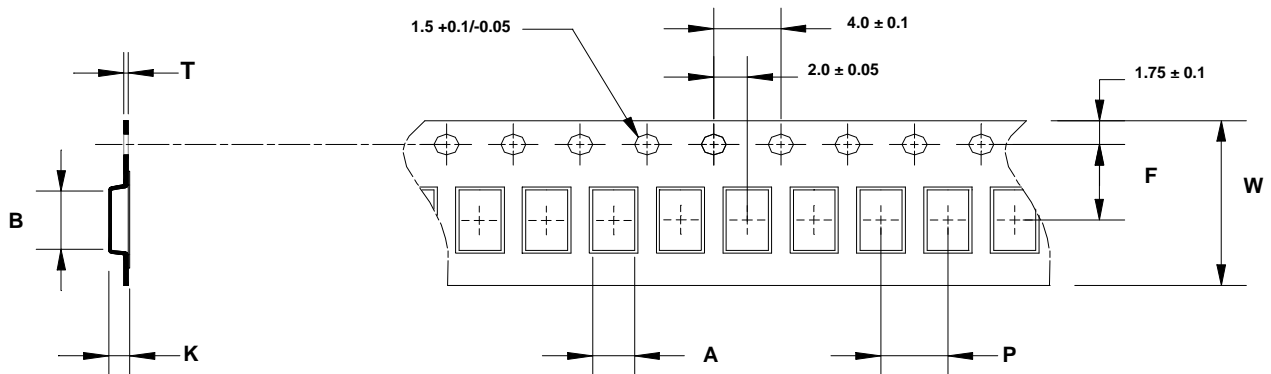
- Operating temperature range - 40°C ~ 105°C(Including self - temperature rise)
- Rated current : ΔT=30°C
- Measure Equipment :
 Z : Agilent E4991
 RDC : HP4338B or CHEN HWA 502(Single Wire Test Value)
 Insulation Resistance : Agilent HP4339B

Test Instruments : Agilent E4991A Material/Impedance Analyzer

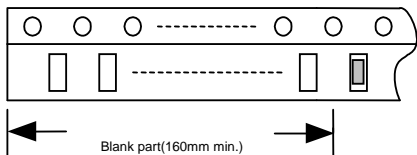


Packaging Specifications

Tape Dimensions

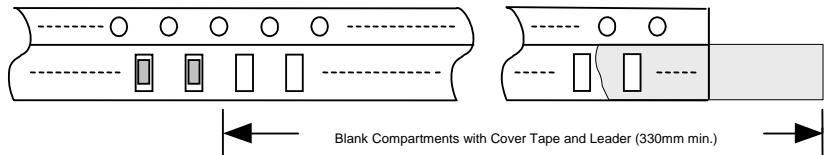


Trailer End



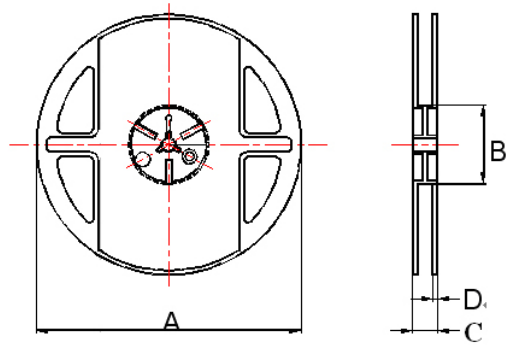
Blank part(160mm min.)

Leader End



Blank Compartments with Cover Tape and Leader (330mm min.)

Reel Dimensions



Dimensions in mm

| TYPE | Tape Dimensions | | | | | | | Reel Dimensions | | | | Quantity |
|-------|-----------------|------|------|---|---|-----|------|-----------------|----|----|-----|------------|
| | A | B | T | W | P | F | K | A | B | C | D | PCS / Reel |
| MCF11 | 1.15 | 1.50 | 0.25 | 8 | 4 | 3.5 | 0.72 | 178 | 60 | 12 | 1.5 | 4000 |
| MCF21 | 1.45 | 2.30 | 0.22 | 8 | 4 | 3.5 | 1.13 | 178 | 60 | 12 | 1.5 | 3000 |

MCUF Series



MCUF Series are design to suppress the common mode noise and reduce the skew of differential mode signal in high frequency application. Both standard series and custom designs are available.

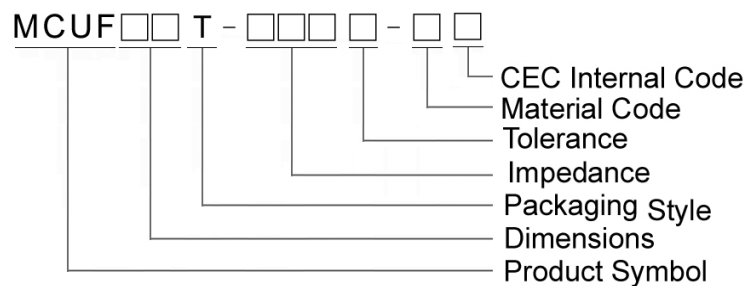
Features

- RoHS Compliant
- High frequency differential mode transmission application
- Miniaturization
- Excellent solderability

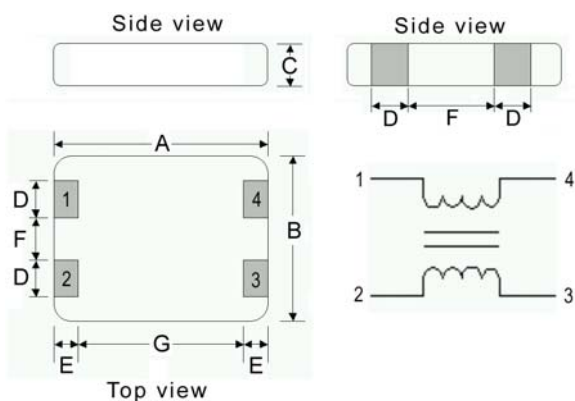
Applications

- USB3.0
- HDMI 2.0

Product Identification



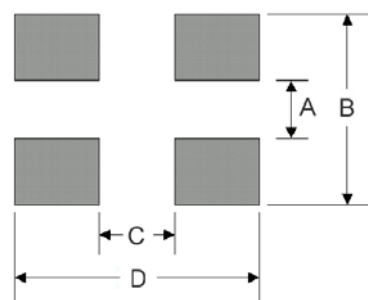
Shape and Dimensions



Dimensions in mm

| TYPE | A | B | C | D | E | F | G |
|--------|-----------|-----------|-----------|-----------|-----------|-----------|-----------|
| MCUF11 | 1.25±0.15 | 1.00±0.15 | 0.60±0.15 | 0.30±0.15 | 0.20±0.15 | 0.25±0.15 | 0.85±0.15 |

Recommended Pattern



Dimensions in mm

| TYPE | A | B | C | D |
|--------|---------|---------|---------|---------|
| MCUF11 | 0.2~0.3 | 0.7~1.0 | 0.7~0.8 | 1.6~1.9 |

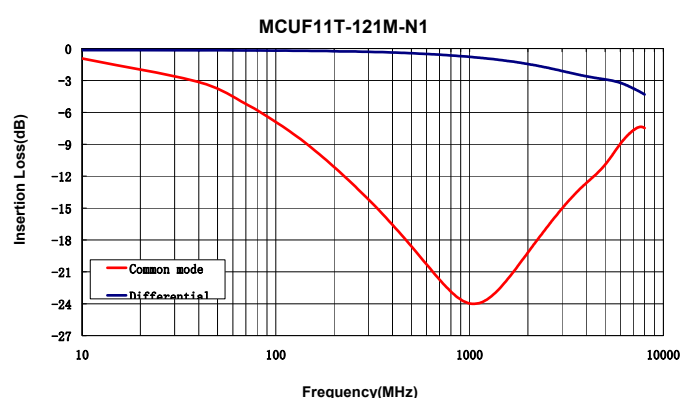
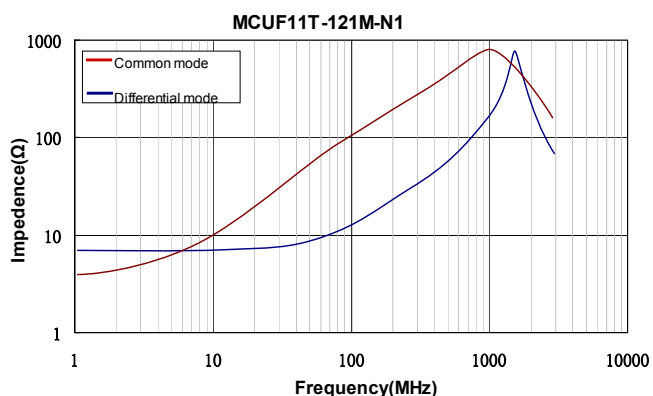
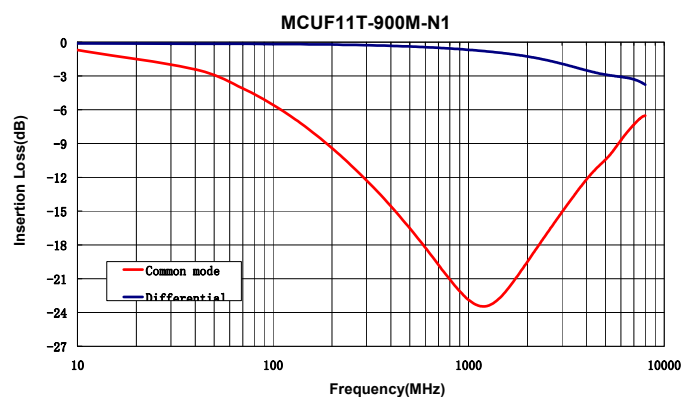
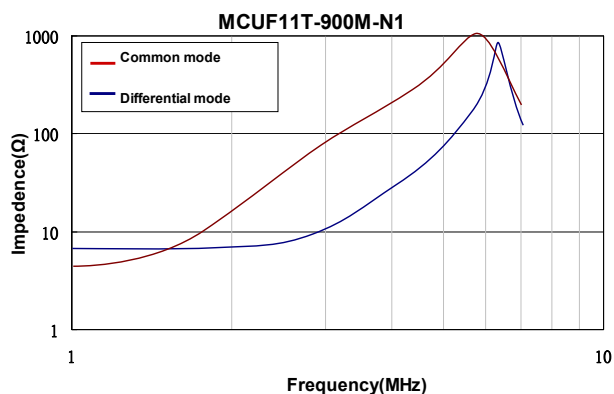
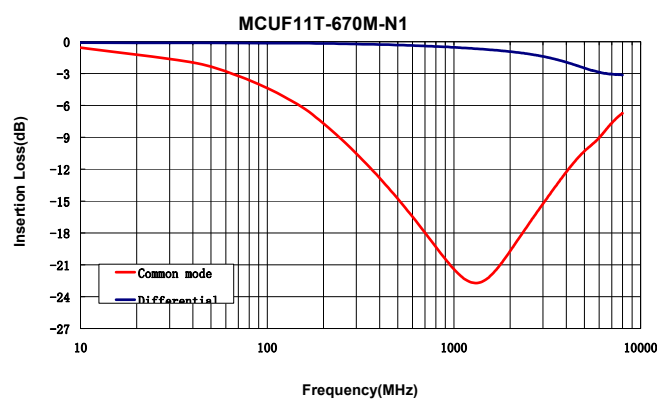
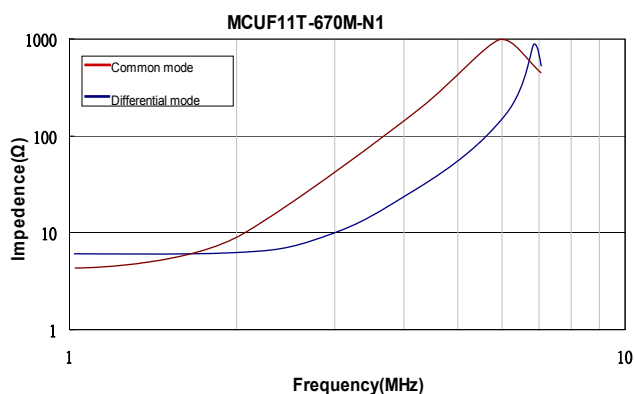
Electrical Characteristics

| Part Number | Impedance (Ω) | Test Frequency (MHz) | Tolerance ($\pm\%$) | RDC (Ω)Max | Rated Current (mA)Max | Rated Voltage (Vdc)Max | Insulation Resistance (M Ω) Min |
|-----------------|---------------------------|-------------------------|--------------------------|------------------------|--------------------------|---------------------------|--|
| MCUF11T-670M-N1 | 67 | 100 | 20 | 3.6 | 100 | 5 | 200 |
| MCUF11T-900M-N1 | 90 | 100 | 20 | 4.0 | 100 | 5 | 200 |
| MCUF11T-121M-N1 | 120 | 100 | 20 | 4.4 | 100 | 5 | 200 |

Note: When ordering, please specify tolerance code. Tolerance: M=±20%

- Operating temperature range - 40°C ~ 105°C(Including self - temperature rise)
- Rated current : $\Delta T=30^\circ\text{C}$
- Measure Equipment :
 Z : Agilent E4991
 RDC : HP4338B or CHEN HWA 502(Single Wire Test Value)
 Insulation Resistance : Agilent HP4339B

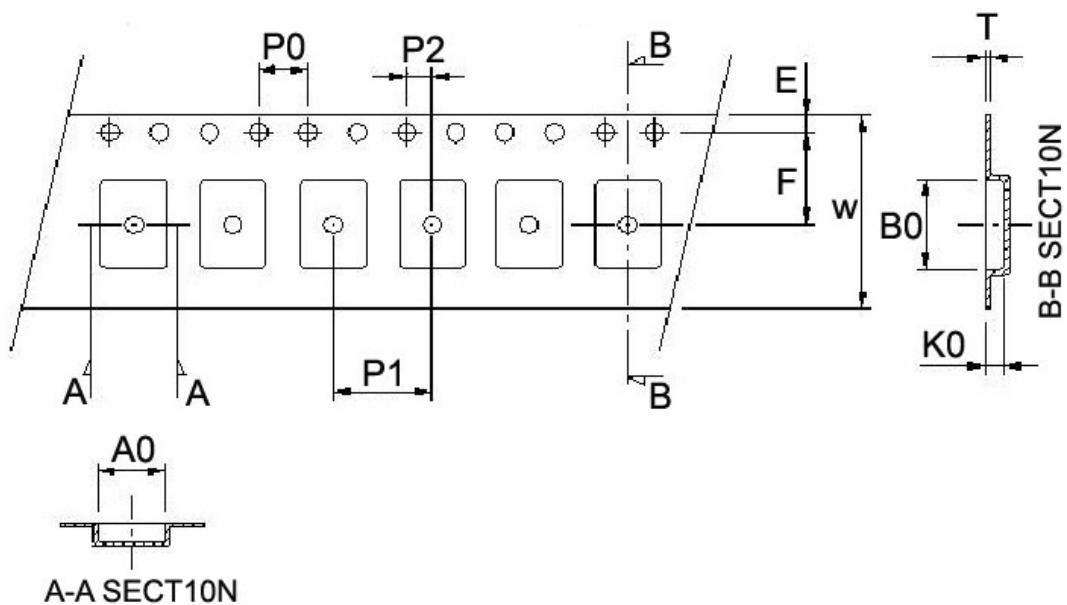
Test Instruments : Agilent E4991A Material/Impedance Analyzer



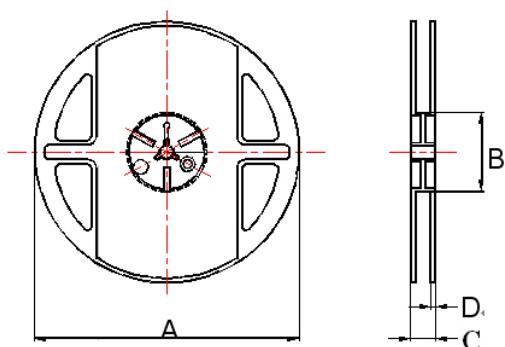
Please be sure to request approval specifications that provide further details of the products. Kindly note that the content of these specifications are subject to change or may be discontinued without advance notice. Please contact our sales department before ordering.

Packaging Specifications

Tape Dimensions



Reel Dimensions



Dimensions in mm

| TYPE | Tape Dimensions | | | | | | | | | Reel Dimensions | | | | Quantity | |
|--------|-----------------|-----|---|------|-----|----|----|----|------|-----------------|-----|----|----|----------|------------|
| | A0 | B0 | W | E | F | P0 | P1 | P2 | T | K0 | A | B | C | D | PCS / Reel |
| MCUF11 | 1.15 | 1.5 | 8 | 1.75 | 3.5 | 4 | 4 | 2 | 0.25 | 0.72 | 178 | 60 | 12 | 1.5 | 4000 |

CUW Series For USB 2.0, IEEE1394b, LVDS Applications



A full series of common mode choke is designed for excellent noise attenuation with compact sizing for use in wide range of applications. Both standard series and custom designs are available.

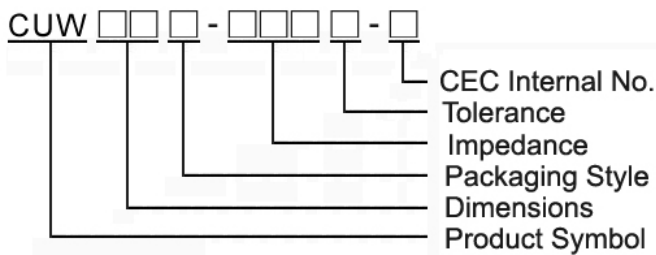
Features

- RoHS Compliant
- Miniature SMD type common mode filter for fully automated assembly
- Wide impedance range (30Ω ~ 2200Ω) for noise suppression
- Excellent solderability

Applications

- USB line for personal computers and peripheral
- IEEE 1394 line for personal computers, DVC, STB
- LVDS, panel line for liquid display panels, graph card, etc.

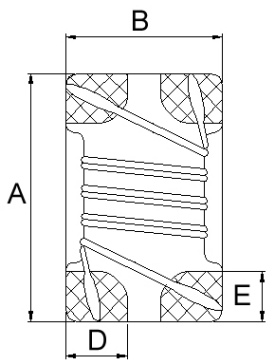
Product Identification



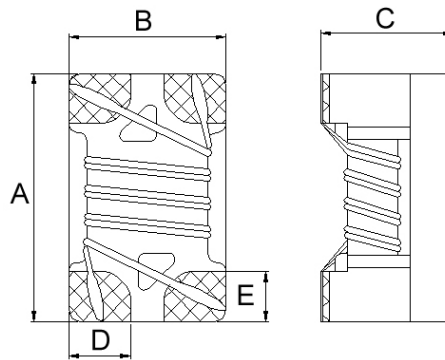
- Packaging: T : Tape and Reel

Shape and Dimensions

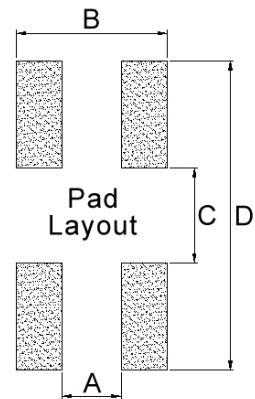
CUW10/11/31



CUW21



Recommended Pattern



Dimensions in mm

| TYPE | A | B | C | D | E |
|-------|----------|----------|----------|------|------|
| CUW10 | 1.60±0.2 | 0.80±0.2 | 1.10±0.2 | 0.25 | 0.33 |
| CUW11 | 1.25±0.2 | 1.00±0.2 | 0.8±0.1 | 0.32 | 0.33 |
| CUW21 | 2.05±0.2 | 1.25±0.2 | 1.20±0.2 | 0.50 | 0.40 |
| CUW31 | 3.20±0.2 | 1.60±0.2 | 1.90±0.2 | 0.50 | 0.60 |

Dimensions in mm

| TYPE | A | B | C | D |
|-------|------|------|------|------|
| CUW10 | 0.25 | 0.75 | 0.61 | 2.29 |
| CUW11 | 0.36 | 1.00 | 0.59 | 1.75 |
| CUW21 | 0.50 | 1.27 | 0.80 | 2.60 |
| CUW31 | 0.40 | 1.60 | 1.60 | 3.70 |

Electrical Characteristics

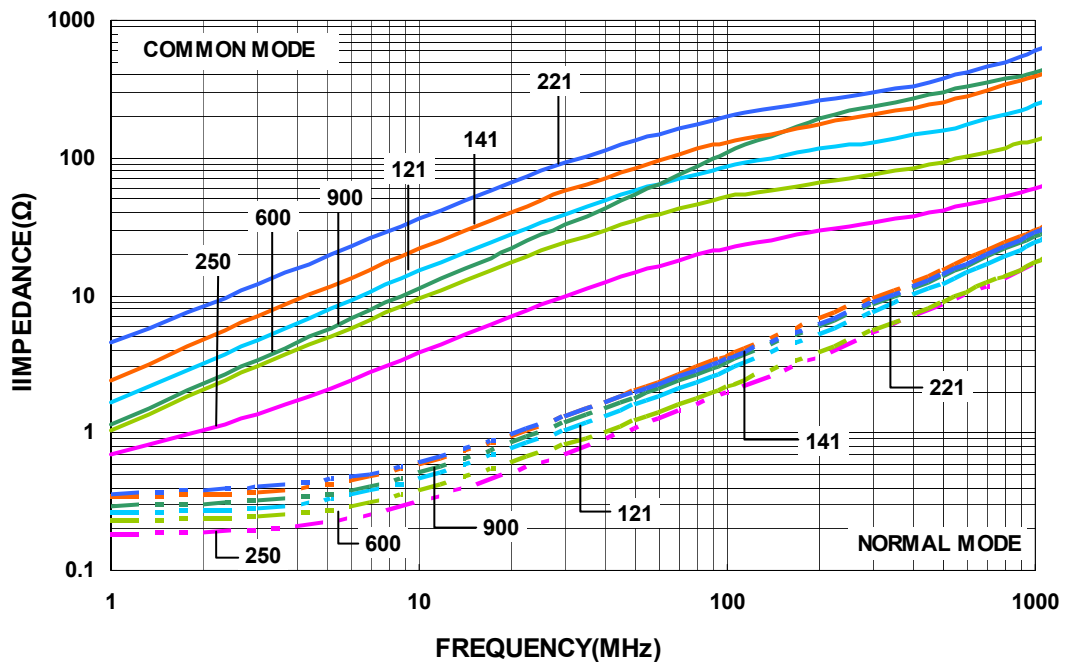
| Part Number | Impedance (Ω) | Tolerance (±%) | Test Frequency (MHz) | RDC (Ω) Max | I _{rms} (mA) Max | Rated Voltage (Vdc) | Insulation Resistance (MΩ) Min |
|---------------|---------------|----------------|----------------------|-------------|---------------------------|---------------------|--------------------------------|
| CUW10T-250M-N | 25 | 20,25 | 100 | 0.077 | 500 | 50 | 10 |
| CUW10T-600M-N | 60 | 20,25 | 100 | 0.109 | 500 | 50 | 10 |
| CUW10T-900M-N | 90 | 20,25 | 100 | 0.142 | 500 | 50 | 10 |
| CUW10T-121M-N | 120 | 20,25 | 100 | 0.160 | 500 | 50 | 10 |
| CUW10T-141M-N | 140 | 20,25 | 100 | 0.174 | 500 | 50 | 10 |
| CUW10T-221M-N | 220 | 20,25 | 100 | 0.209 | 500 | 50 | 10 |

Note: When ordering, please specify tolerance code. Tolerance: M=±20% , Y=±25%

- Operating temperature range - 40°C ~ 105°C(Including self - temperature rise)
- rms for 20°C rise from 25°C ambient
- Measure Equipment :
 Z : Agilent HP4287A+Agilent 16197A
 RDC : HP4338B or Chroma 16502 (Single Wire Test Value)
 I_{rms} : HP4284A+HP42841A/HP4285A+HP42841A
 Insulation Resistance : Agilent HP4339B

Test Instruments : HP4287A Material/Impedance Analyzer

Typical Impedance vs. Frequency



Please be sure to request approval specifications that provide further details of the products. Kindly note that the content of these specifications are subject to change or may be discontinued without advance notice. Please contact our sales department before ordering.

Electrical Characteristics

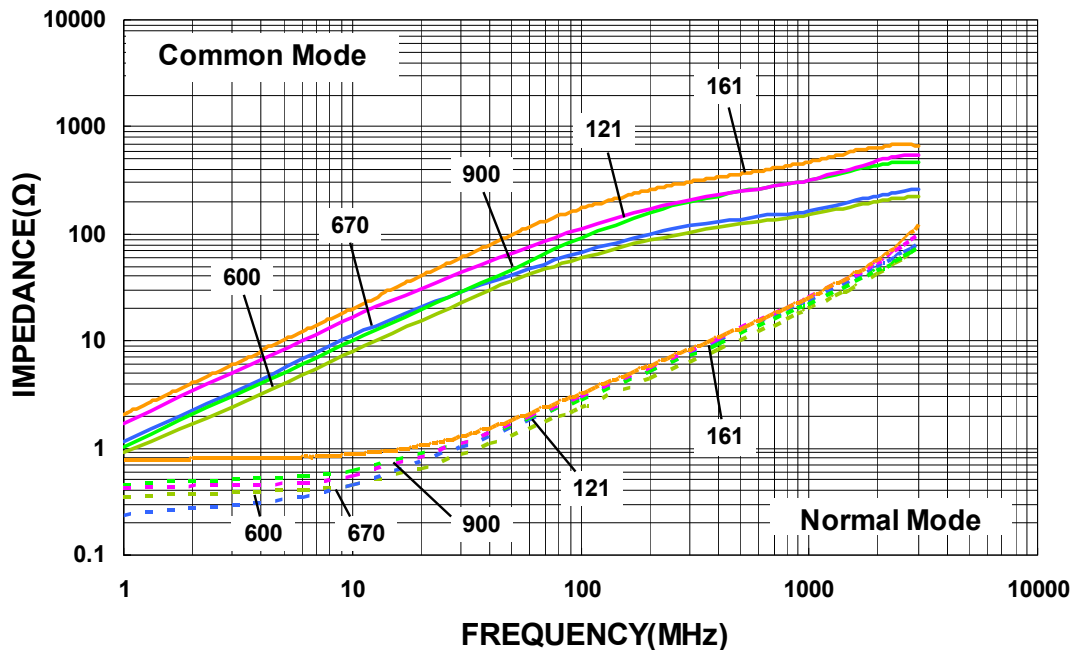
| Part Number | Impedance (Ω) | Tolerance (±%) | Test Frequency (MHz) | RDC (Ω) Max | IDC (mA) Max | Rated Voltage (Vdc) | Insulation Resistance (MΩ) Min |
|---------------|---------------|----------------|----------------------|-------------|--------------|---------------------|--------------------------------|
| CUW11T-250T-N | 25 | 30 | 100 | 0.30 | 400 | 20 | 10 |
| CUW11T-600M-N | 60 | 20 | 100 | 0.40 | 300 | 20 | 10 |
| CUW11T-670M-N | 67 | 20 | 100 | 0.25 | 300 | 50 | 10 |
| CUW11T-900M-N | 90 | 20 | 100 | 0.30 | 250 | 50 | 10 |
| CUW11T-121M-N | 120 | 20 | 100 | 0.40 | 200 | 50 | 10 |
| CUW11T-161M-N | 160 | 20 | 100 | 0.43 | 160 | 50 | 10 |
| CUW11T-201M-N | 200 | 20 | 100 | 0.80 | 120 | 50 | 10 |
| CUW11T-331Y-N | 330 | 25 | 100 | 1.30 | 100 | 50 | 10 |

Note: When ordering, please specify tolerance code. Tolerance: M=±20%, Y=±25%, T=±30%

- Operating temperature range - 40°C ~ 105°C(Including self - temperature rise)
- IDC for Inductance drop 10% from its value without current
- Measure Equipment :
 Z : Agilent HP4287A+Agilent 16197A
 RDC : Chroma 16502 (Single Wire Test Value)
 IDC : HP4284A+HP42841A/HP4285A+HP42841A
 Insulation Resistance : Agilent HP4339B

Test Instruments : HP4287A Material/Impedance Analyzer

Typical Impedance vs. Frequency



Please be sure to request approval specifications that provide further details of the products. Kindly note that the content of these specifications are subject to change or may be discontinued without advance notice. Please contact our sales department before ordering.

Electrical Characteristics

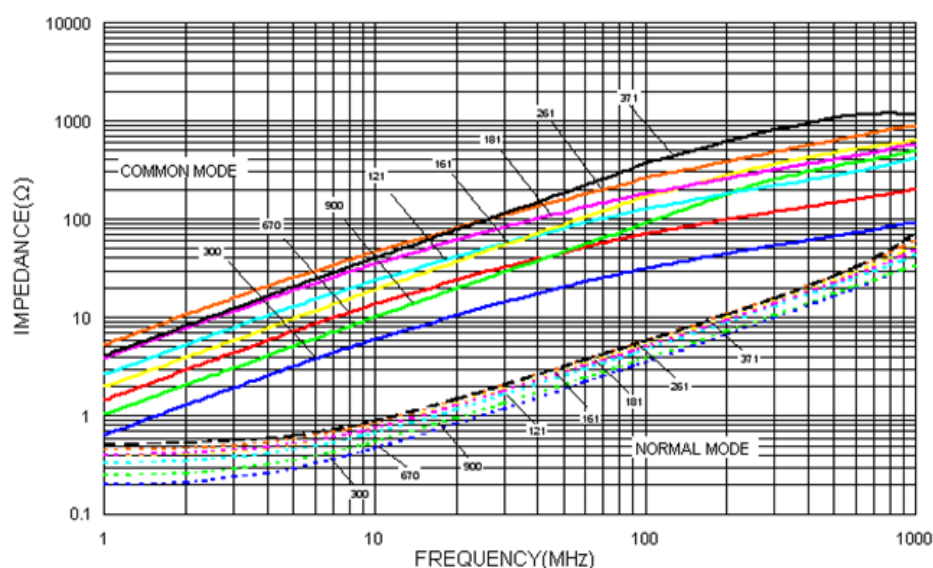
| Part Number | Impedance (Ω) | Tolerance (±%) | Test Frequency (MHz) | RDC (Ω) Max | IDC (mA) Max | Rated Voltage (Vdc) | Insulation Resistance (MΩ) Min |
|---------------|---------------|----------------|----------------------|-------------|--------------|---------------------|--------------------------------|
| CUW21T-300M-N | 30 | 20 | 100 | 0.20 | 450 | 50 | 10 |
| CUW21T-670M-N | 67 | 20 | 100 | 0.25 | 400 | 50 | 10 |
| CUW21T-750M-N | 75 | 20 | 100 | 0.30 | 360 | 50 | 10 |
| CUW21T-900M-N | 90 | 20 | 100 | 0.35 | 330 | 50 | 10 |
| CUW21T-121M-N | 120 | 20 | 100 | 0.30 | 400 | 50 | 10 |
| CUW21T-161M-N | 160 | 20 | 100 | 0.35 | 350 | 50 | 10 |
| CUW21T-181M-N | 180 | 20 | 100 | 0.35 | 330 | 50 | 10 |
| CUW21T-201M-N | 200 | 20 | 100 | 0.35 | 330 | 50 | 10 |
| CUW21T-221M-N | 220 | 20 | 100 | 0.35 | 310 | 50 | 10 |
| CUW21T-261M-N | 260 | 20 | 100 | 0.40 | 300 | 50 | 10 |
| CUW21T-301M-N | 300 | 20 | 100 | 0.40 | 290 | 50 | 10 |
| CUW21T-361M-N | 360 | 20 | 100 | 0.45 | 280 | 50 | 10 |
| CUW21T-371M-N | 370 | 20 | 100 | 0.45 | 280 | 50 | 10 |
| CUW21T-501M-N | 500 | 20 | 100 | 0.55 | 170 | 50 | 10 |
| CUW21T-671M-N | 670 | 20 | 100 | 0.60 | 140 | 50 | 10 |
| CUW21T-901M-N | 900 | 20 | 100 | 0.60 | 80 | 50 | 10 |

Note: When ordering, please specify tolerance code. Tolerance: M=±20%

- Operating temperature range - 40°C ~ 105°C(Including self - temperature rise)
- IDC for Inductance drop 10% from its value without current
- Measure Equipment :
 Z : Agilent HP4287A+Agilent 16197A
 RDC : Chroma 16502 (Single Wire Test Value)
 IDC : HP4284A+HP42841A/HP4285A+HP42841A
 Insulation Resistance : Agilent HP4339B

Test Instruments : HP4291A Material/Impedance Analyzer

Typical Impedance vs. Frequency



Please be sure to request approval specifications that provide further details of the products. Kindly note that the content of these specifications are subject to change or may be discontinued without advance notice. Please contact our sales department before ordering.

Electrical Characteristics

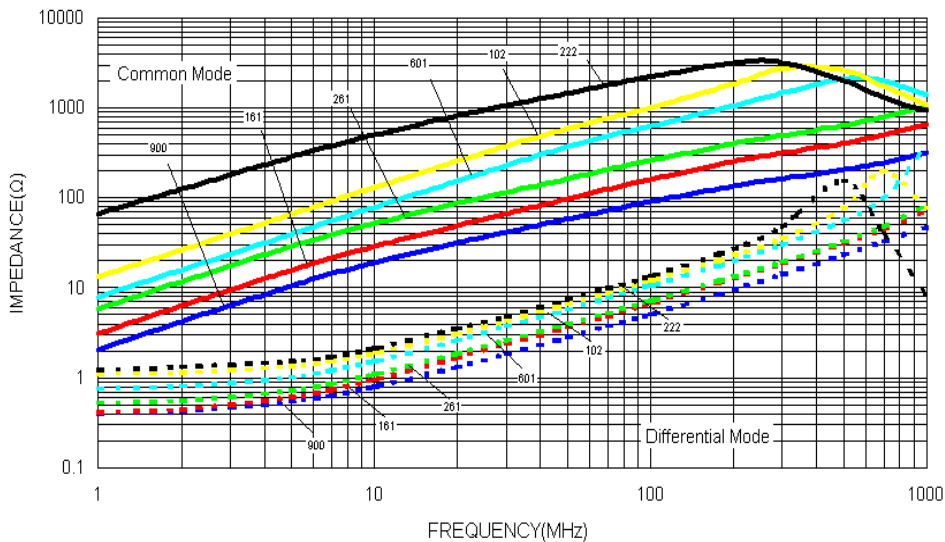
| Part Number | Impedance (Ω) | Tolerance (±%) | Test Frequency (MHz) | RDC (Ω) Max | IDC (mA) Max | Rated Voltage (Vdc) | Insulation Resistance (MΩ) Min |
|---------------|---------------|----------------|----------------------|-------------|--------------|---------------------|--------------------------------|
| CUW31T-900M-N | 90 | 20 | 100 | 0.3 | 370 | 50 | 10 |
| CUW31T-121M-N | 120 | 20 | 100 | 0.3 | 370 | 50 | 10 |
| CUW31T-161M-N | 160 | 20 | 100 | 0.4 | 340 | 50 | 10 |
| CUW31T-221M-N | 220 | 20 | 100 | 0.4 | 320 | 50 | 10 |
| CUW31T-261M-N | 260 | 20 | 100 | 0.5 | 310 | 50 | 10 |
| CUW31T-601M-N | 600 | 20 | 100 | 0.8 | 260 | 50 | 10 |
| CUW31T-102M-N | 1000 | 20 | 100 | 1.0 | 230 | 50 | 10 |
| CUW31T-222M-N | 2200 | 20 | 100 | 1.2 | 200 | 50 | 10 |

Note: When ordering, please specify tolerance code. Tolerance: M=±20%

- Operating temperature range - 40°C ~ 105°C(Including self - temperature rise)
- IDC for Inductance drop 10% from its value without current
- Measure Equipment :
 Z : Agilent HP4287A+Agilent 16197A
 RDC : Chroma 16502 (Single Wire Test Value)
 IDC : HP4284A+HP42841A/HP4285A+HP42841A
 Insulation Resistance : Agilent HP4339B

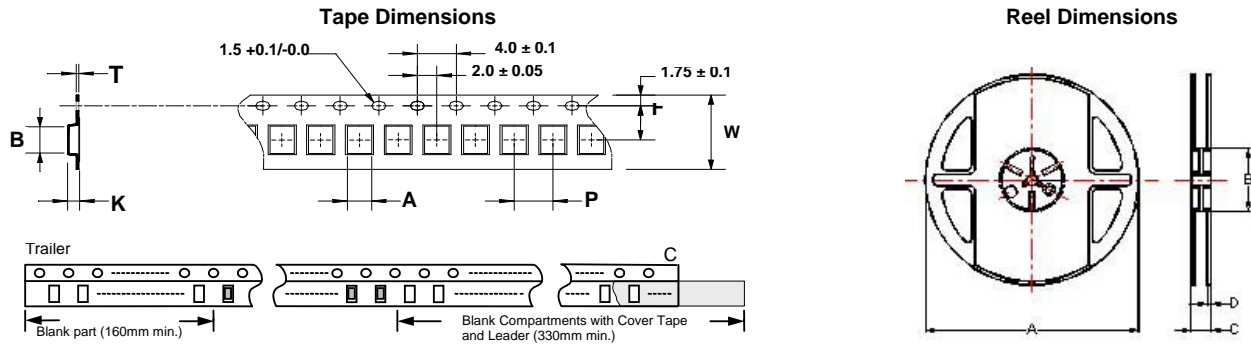
Test Instruments : HP4291A Material/Impedance Analyzer

Typical Impedance vs. Frequency



Please be sure to request approval specifications that provide further details of the products. Kindly note that the content of these specifications are subject to change or may be discontinued without advance notice. Please contact our sales department before ordering.

Packaging Specifications



Dimensions in mm

| TYPE | Tape Dimensions | | | | | | | Reel Dimensions | | | | Quantity PCS / Reel |
|-------|-----------------|------|------|---|---|-----|------|-----------------|----|----|-----|------------------------|
| | A | B | T | W | P | F | K | A | B | C | D | |
| CUW10 | 0.95 | 1.70 | 0.24 | 8 | 4 | 3.5 | 1.15 | 178 | 60 | 12 | 1.5 | 2000 |
| CUW11 | 1.15 | 1.45 | 0.24 | 8 | 4 | 3.5 | 1.00 | 178 | 60 | 12 | 1.5 | 2000 |
| CUW21 | 1.50 | 2.25 | 0.24 | 8 | 4 | 3.5 | 1.35 | 178 | 60 | 12 | 1.5 | 2000 |
| CUW31 | 1.76 | 3.47 | 0.22 | 8 | 4 | 3.5 | 2.05 | 178 | 60 | 12 | 1.5 | 2000 |

CUW Series For **USB 2.0, IEEE1394b, LVDS**



A full series of common mode choke is designed for excellent noise attenuation with compact sizing for use in wide range of applications. Both standard series and custom designs are available.

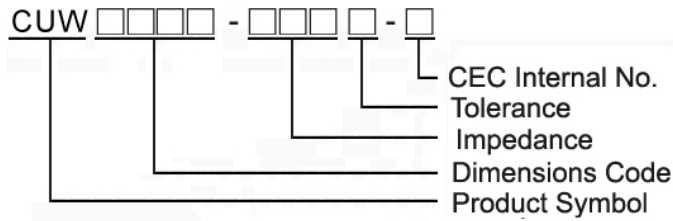
Features

- RoHS Compliant
- Miniature SMD type common mode filter for fully automated assembly
- Wide impedance range (30Ω ~ 2200Ω) for noise suppression
- Excellent solderability

Applications

- USB line for personal computers and peripheral
- IEEE 1394 line for personal computers, DVC, STB
- LVDS, panel line for liquid display panels, graph card etc

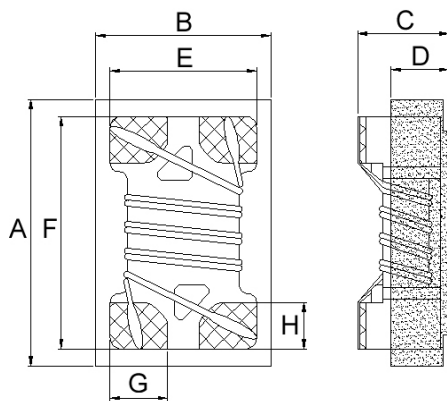
Product Identification



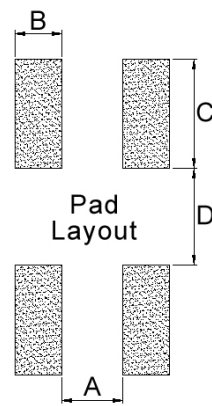
- Packaging: T : Tape and Reel

Shape and Dimensions

CUW0805



Recommended Pattern



Dimensions in mm

| TYPE | A | B | C | D | E | F | G | H |
|---------|--------------------|--------------------|--------------------|-----|------|------|-----|------|
| CUW0805 | 2.29 ⁺⁰ | 1.52 ⁺⁰ | 1.20 ⁺⁰ | 0.5 | 1.27 | 2.03 | 0.5 | 0.40 |

Dimensions in mm

| TYPE | A | B | C | D |
|---------|-----|------|-----|-----|
| CUW0805 | 0.5 | 0.38 | 0.9 | 0.8 |

Electrical Characteristics

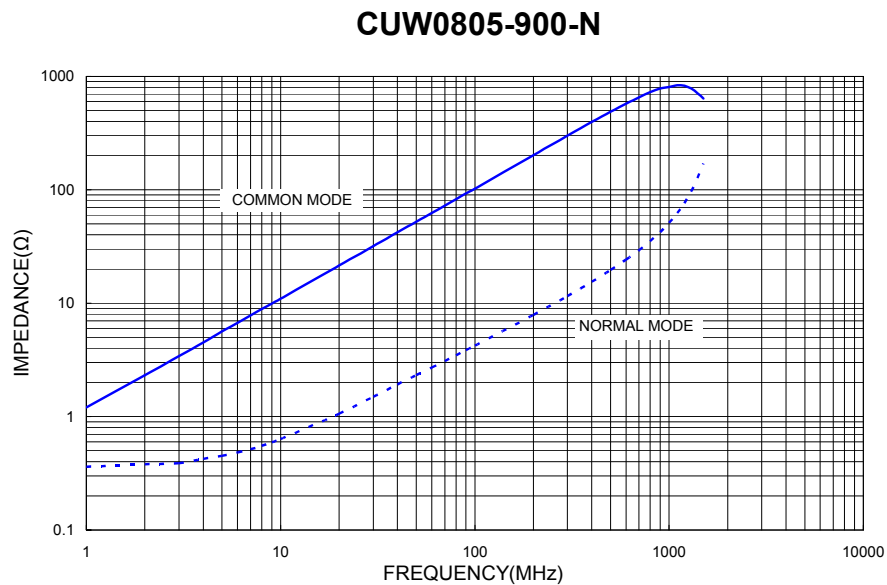
| Part Number | Impedance (Ω) | Tolerance (±%) | Test Frequency (MHz) | RDC (Ω) Max | IDC (mA) Max | Rated Voltage (Vdc) | Insulation Resistance (MΩ) Min |
|----------------|---------------|----------------|----------------------|-------------|--------------|---------------------|--------------------------------|
| CUW0805-300M-N | 30 | 20 | 100 | 0.20 | 1300 | 50 | 10 |
| CUW0805-420M-N | 42 | 20 | 100 | 0.20 | 1300 | 50 | 10 |
| CUW0805-670M-N | 67 | 20 | 100 | 0.25 | 1200 | 50 | 10 |
| CUW0805-900M-N | 90 | 20 | 100 | 0.27 | 1000 | 50 | 10 |
| CUW0805-121M-N | 120 | 20 | 100 | 0.30 | 900 | 50 | 10 |
| CUW0805-181M-N | 180 | 20 | 100 | 0.40 | 700 | 50 | 10 |
| CUW0805-261M-N | 260 | 20 | 100 | 0.60 | 700 | 50 | 10 |

Note: When ordering, please specify tolerance code. Tolerance: M=±20%

- Operating temperature range - 40°C ~ 105°C(Including self - temperature rise)
- IDC for Inductance drop 10% from its value without current.
- Measure Equipment :
 Z : Agilent HP4291A
 RDC : HP4338B or Chroma 16502 (Single Wire Test Value)
 IDC : HP4284A+HP42841A/HP4285A+HP42841A
 Insulation Resistance : Agilent HP4339B

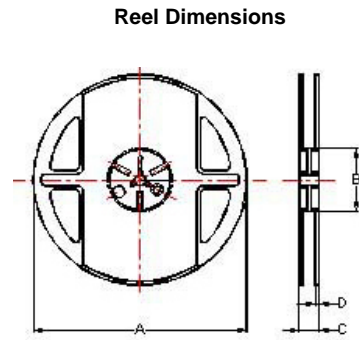
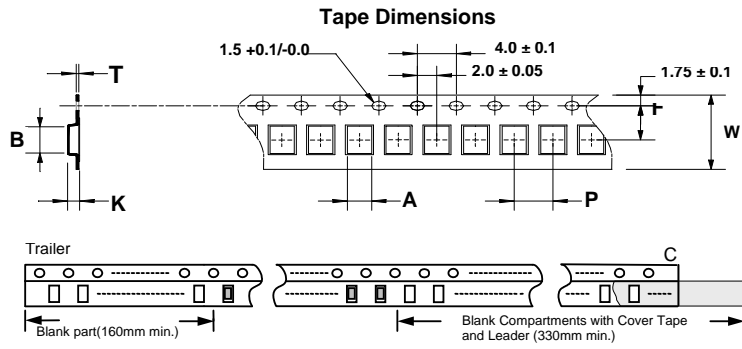
Test Instruments : HP4291A Material/Impedance Analyzer

Typical Impedance vs. Frequency



Please be sure to request approval specifications that provide further details of the products. Kindly note that the content of these specifications are subject to change or may be discontinued without advance notice. Please contact our sales department before ordering.

Packaging Specifications



Dimensions in mm

| TYPE | Tape Dimensions | | | | | | | Reel Dimensions | | | | Quantity PCS / Reel |
|---------|-----------------|------|------|---|---|-----|------|-----------------|----|----|-----|------------------------|
| | A | B | T | W | P | F | K | A | B | C | D | |
| CUW0805 | 1.60 | 2.42 | 0.26 | 8 | 4 | 3.5 | 1.14 | 178 | 60 | 12 | 1.5 | 2000 |

CUWI Series For HDMI, USB 3.0



A full series of common mode choke is designed for excellent noise attenuation and compact sizing for use in wide range of applications. Both standard series and custom designs are available.

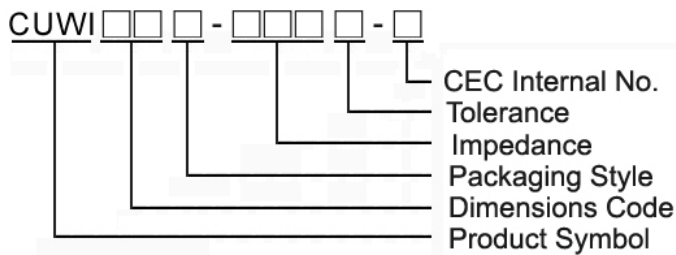
Features

- RoHS Compliant
- Miniature SMD type common mode filter for fully automated assembly
- Excellent solderability

Applications

- HDMI
- USB lines (for personal computers and peripheral), DVC, STB, LVDS, panel line for liquid display panels, etc.

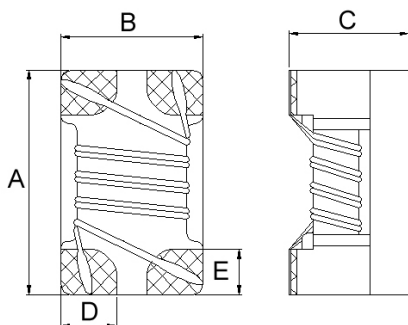
Product Identification



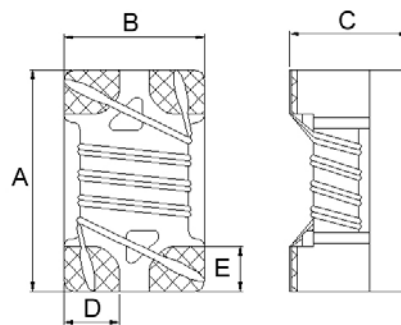
- Packaging: T : Tape and Reel

Shape and Dimensions

CUWI11



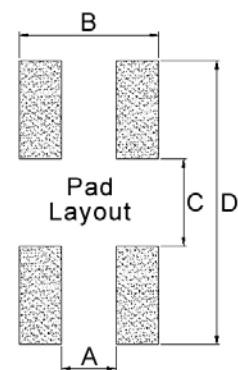
CUWI21



Dimensions in mm

| TYPE | A | B | C | D | E |
|--------|----------|----------|----------|------|------|
| CUWI11 | 1.25±0.2 | 1.00±0.2 | 0.80±0.1 | 0.32 | 0.33 |
| CUWI21 | 2.05±0.2 | 1.25±0.2 | 1.20±0.2 | 0.50 | 0.40 |

Recommended Pattern



Dimensions in mm

| TYPE | A | B | C | D |
|--------|------|------|------|------|
| CUWI11 | 0.36 | 1.00 | 0.59 | 1.75 |
| CUWI21 | 0.50 | 1.27 | 0.80 | 2.60 |

Electrical Characteristics

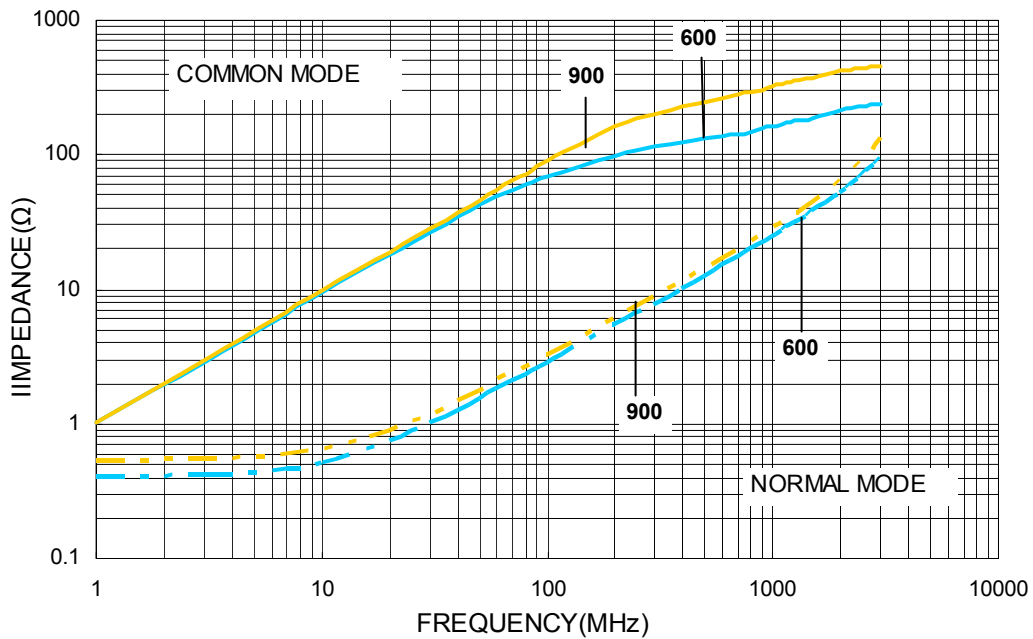
| Part Number | Impedance (Ω) | Tolerance (±%) | Test Frequency (MHz) | RDC (Ω) Max | IDC (mA) Max | Rated Voltage (Vdc) | Insulation Resistance (MΩ) Min |
|----------------|---------------|----------------|----------------------|-------------|--------------|---------------------|--------------------------------|
| CUWI11T-600Y-N | 60 | 25 | 100 | 0.40 | 250 | 20 | 10 |
| CUWI11T-900Y-N | 90 | 25 | 100 | 0.30 | 250 | 20 | 10 |

Note: When ordering, please specify tolerance code. Tolerance: Y=±25%

- Operating temperature range - 40°C ~ 105°C(Including self - temperature rise)
- IDC for Inductance drop 10% from its value without current.
- Measure Equipment :
 Z : HP4286A/HP4287A/Agilent E4991A+Agilent16197A
 RDC : Chroma 16502 (Single Wire Test Value)
 IDC : HP4284A+HP42841A/HP4285A+HP42841A
 Insulation Resistance : Agilent HP4339B

Test Instruments : HP4291A Material/Impedance Analyzer

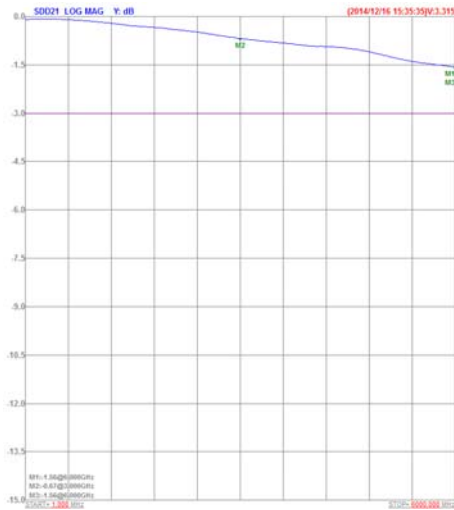
Typical Impedance vs. Frequency



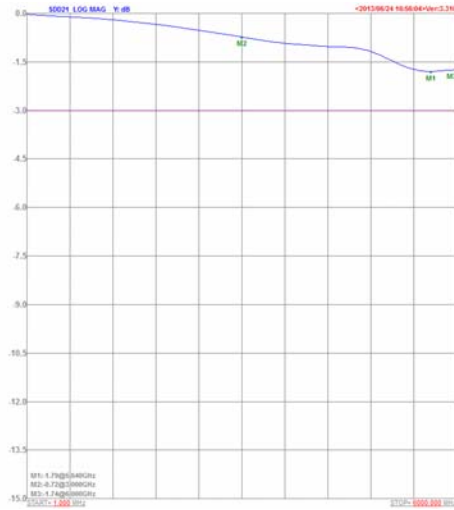
Please be sure to request approval specifications that provide further details of the products. Kindly note that the content of these specifications are subject to change or may be discontinued without advance notice. Please contact our sales department before ordering.

CUWI11T-600Y-N

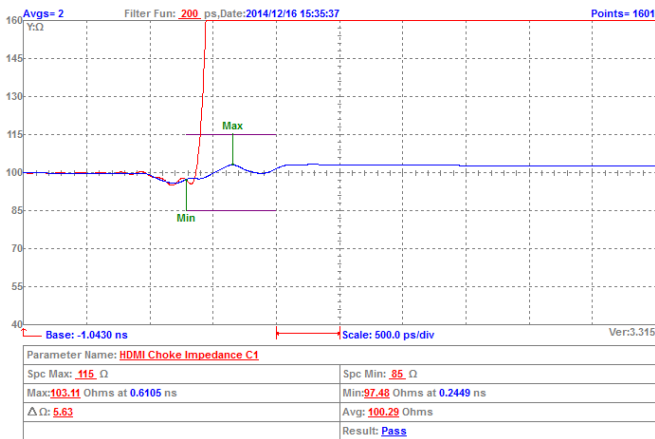
Insertion Loss For HDMI2.0 Testing:



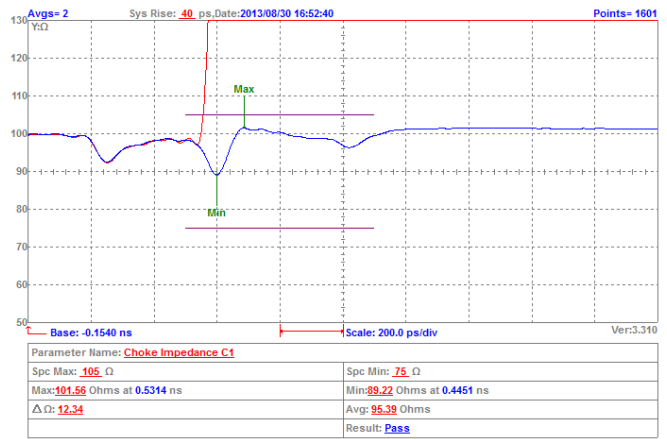
Insertion Loss For USB3.0 Testing:



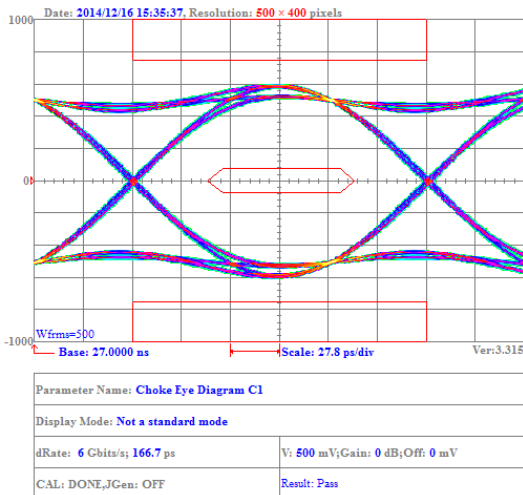
TDR For HDMI2.0 Testing:



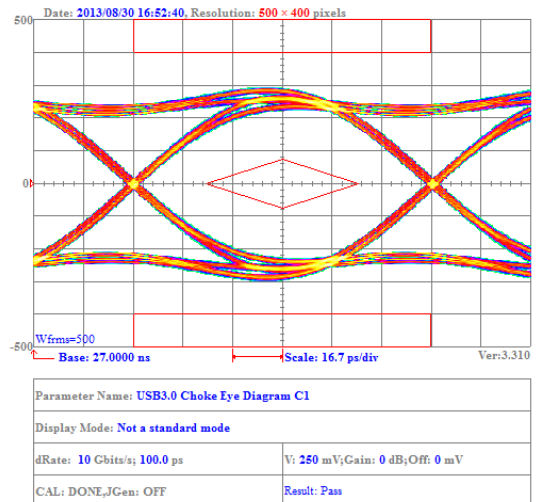
TDR For USB3.0 Testing:



Eye Diagram For HDMI2.0 Testing:



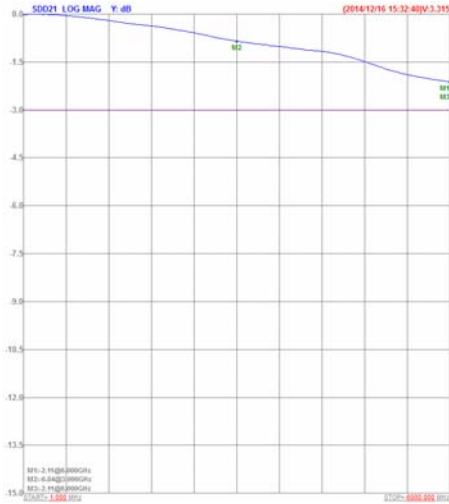
Eye Diagram For USB3.0 Testing:



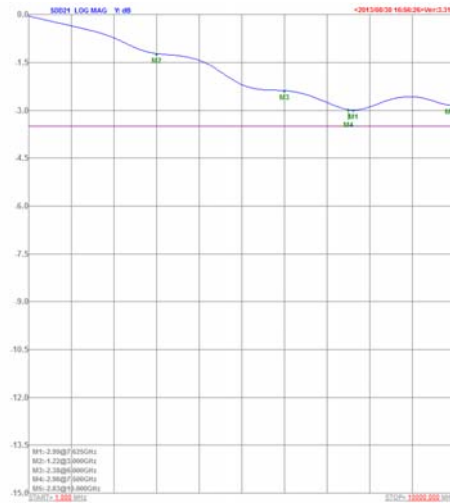
Please be sure to request approval specifications that provide further details of the products. Kindly note that the content of these specifications are subject to change or may be discontinued without advance notice. Please contact our sales department before ordering.

CUWI11T-900Y-N

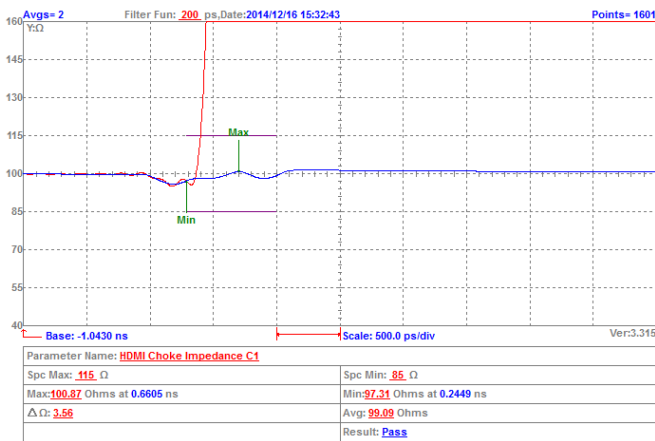
Insertion Loss For HDMI2.0 Testing:



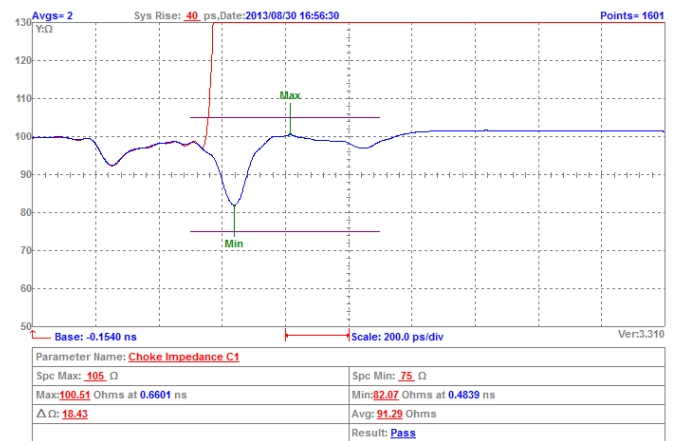
Insertion Loss For USB3.0 Testing:



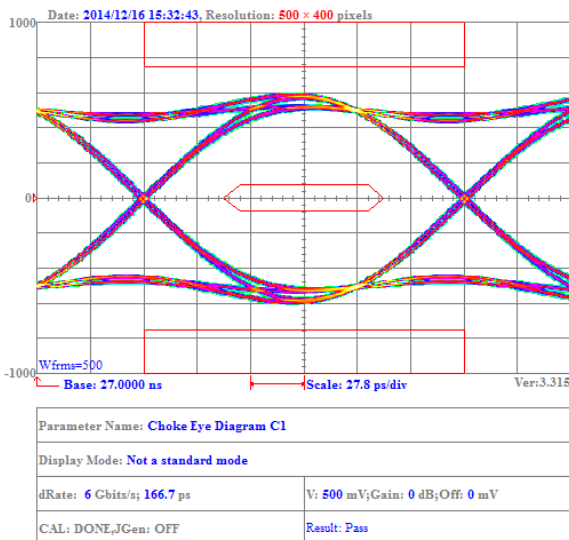
TDR For HDMI2.0 Testing:



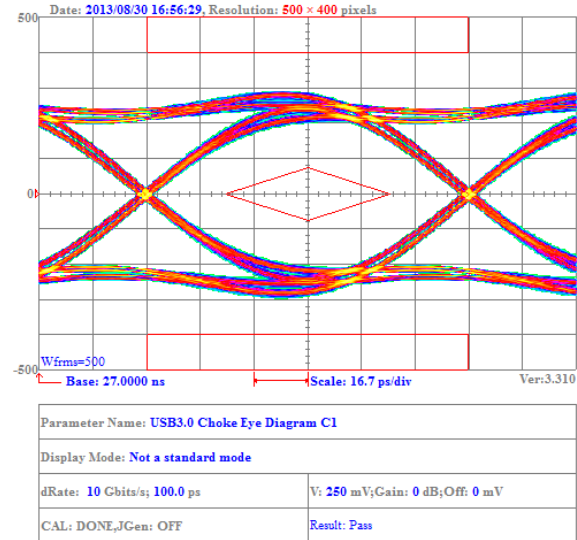
TDR For USB3.0 Testing:



Eye Diagram For HDMI2.0 Testing:



Eye Diagram For USB3.0 Testing:



Please be sure to request approval specifications that provide further details of the products. Kindly note that the content of these specifications are subject to change or may be discontinued without advance notice. Please contact our sales department before ordering.

Electrical Characteristics

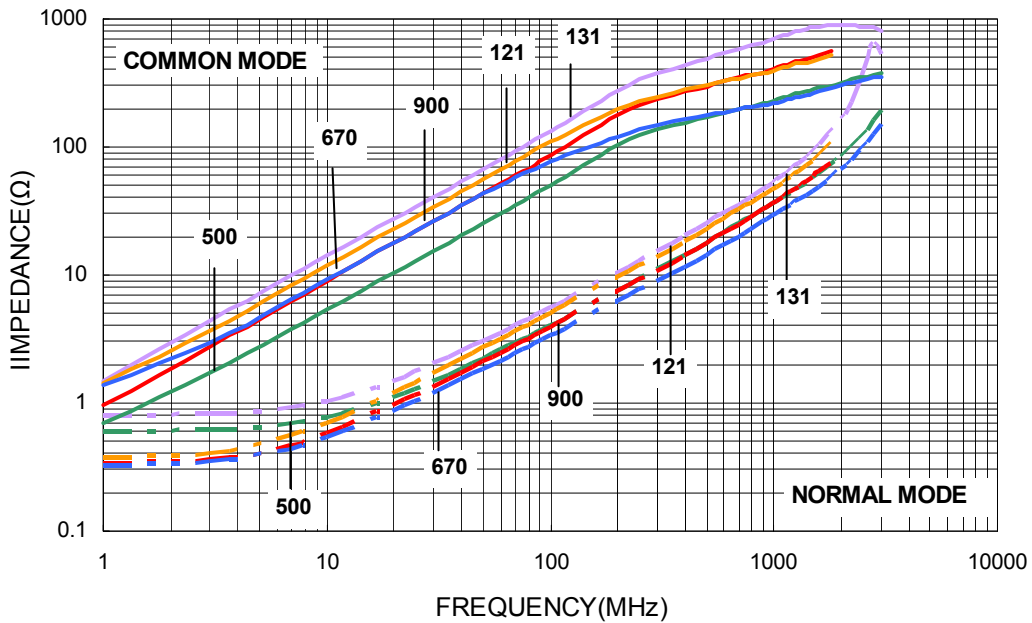
| Part Number | Impedance (Ω) | Tolerance (±%) | Test Frequency (MHz) | RDC (Ω) Max | IDC (mA) Max | Rated Voltage (Vdc) | Insulation Resistance (MΩ) Min |
|----------------|---------------|----------------|----------------------|-------------|--------------|---------------------|--------------------------------|
| CUWI21T-500Y-N | 50 | 25 | 100 | 0.20 | 500 | 50 | 10 |
| CUWI21T-670Y-N | 67 | 25 | 100 | 0.30 | 500 | 50 | 10 |
| CUWI21T-900Y-N | 90 | 25 | 100 | 0.30 | 500 | 50 | 10 |
| CUWI21T-121Y-N | 120 | 25 | 100 | 0.35 | 330 | 50 | 10 |
| CUWI21T-131Y-N | 130 | 25 | 100 | 0.40 | 300 | 50 | 10 |

Note: When ordering, please specify tolerance code. Tolerance: Y=±25%

- Operating temperature range - 40°C ~ 105°C(Including self - temperature rise)
- IDC for Inductance drop 10% from its value without current.
- Measure Equipment :
 Z : HP4286A/HP4287A/Agilent E4991A+Agilent16197A
 RDC : Chroma 16502 (Single Wire Test Value)
 IDC : HP4284A+HP42841A/HP4285A+HP42841A
 Insulation Resistance : Agilent HP4339B

Test Instruments : HP4291A Material/Impedance Analyzer

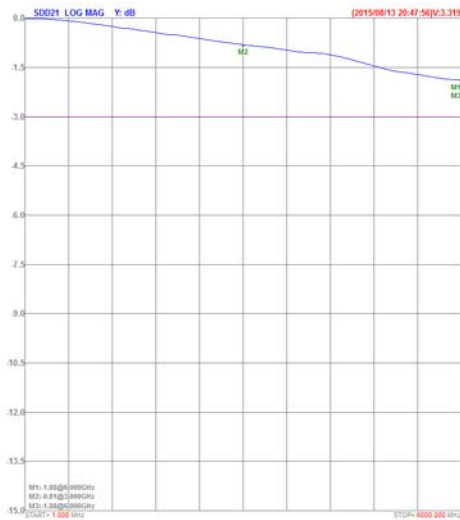
Typical Impedance vs. Frequency



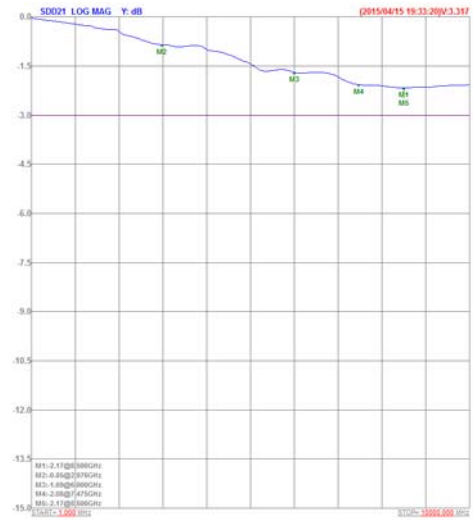
Please be sure to request approval specifications that provide further details of the products. Kindly note that the content of these specifications are subject to change or may be discontinued without advance notice. Please contact our sales department before ordering.

CUWI21T-500Y-N

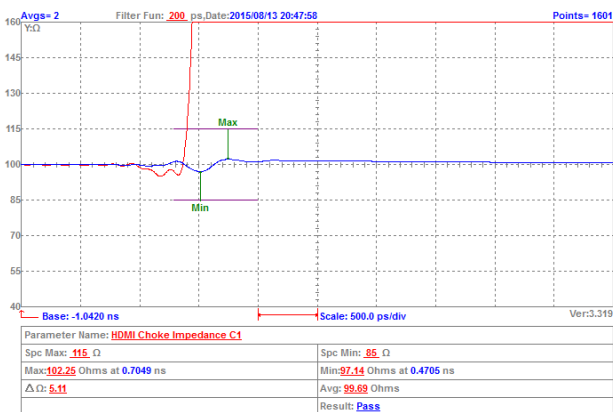
Insertion Loss For HDMI2.0 Testing:



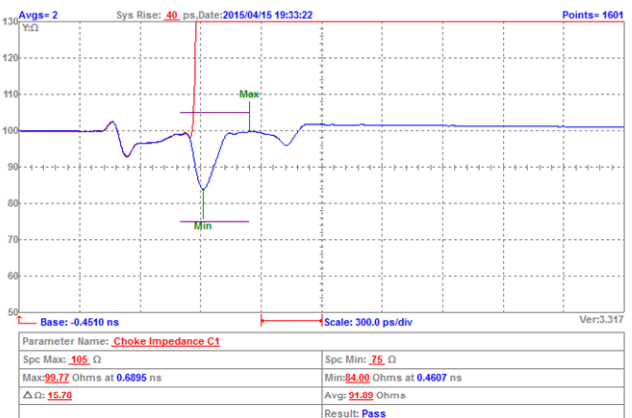
Insertion Loss For USB3.0 Testing:



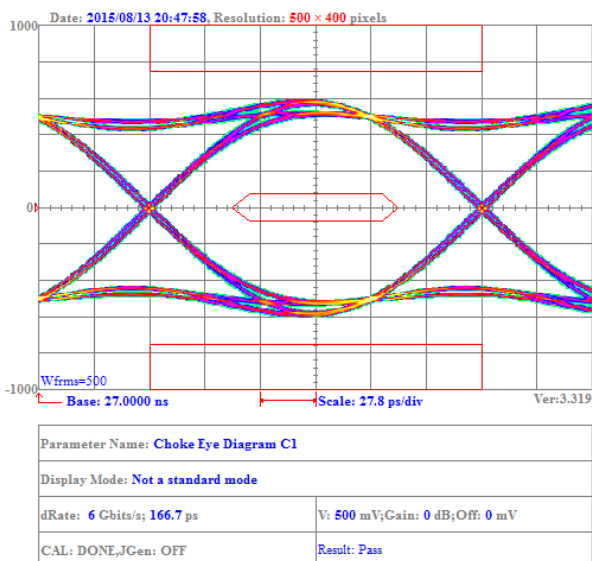
TDR For HDMI2.0 Testing:



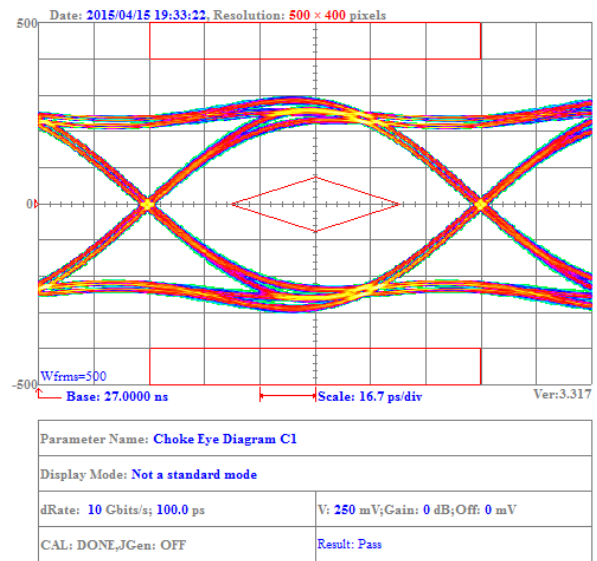
TDR For USB3.0 Testing:



Eye Diagram For HDMI2.0 Testing:



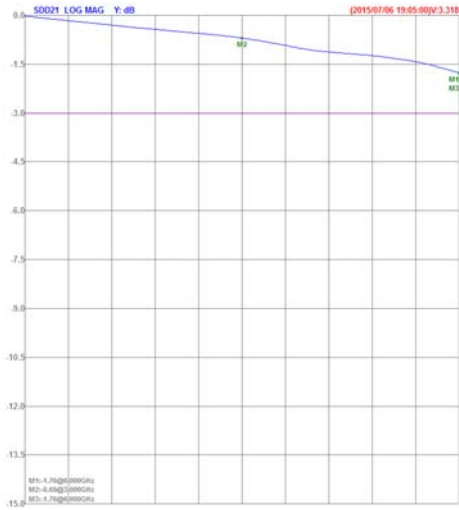
Eye Diagram For USB3.0 Testing:



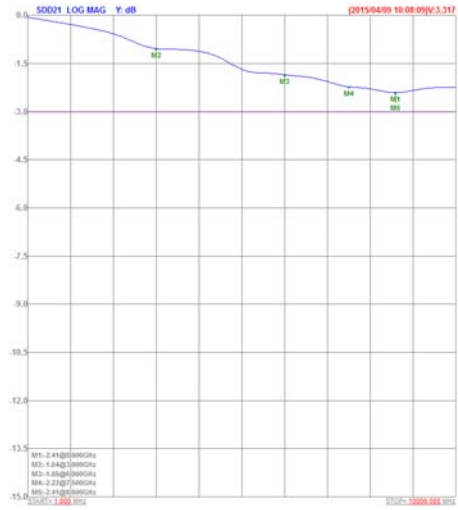
Please be sure to request approval specifications that provide further details of the products. Kindly note that the content of these specifications are subject to change or may be discontinued without advance notice. Please contact our sales department before ordering.

CUWI21T-670Y-N

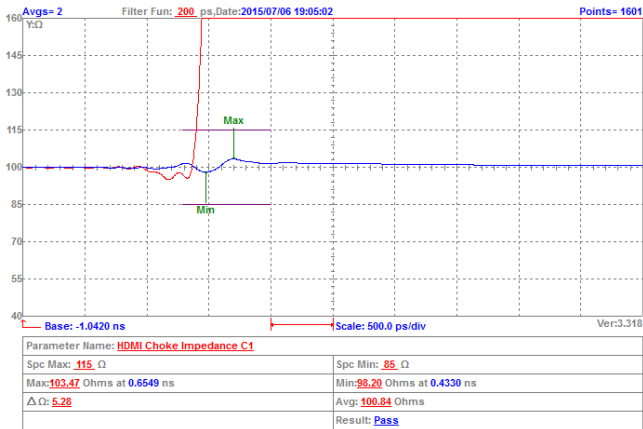
Insertion Loss For HDMI2.0 Testing:



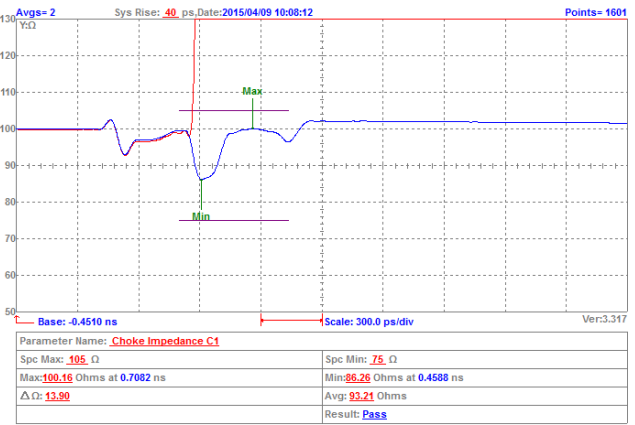
Insertion Loss For USB3.0 Testing:



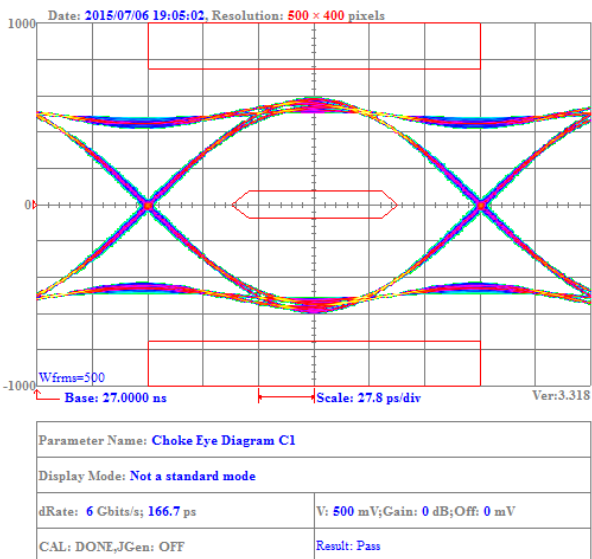
TDR For HDMI2.0 Testing:



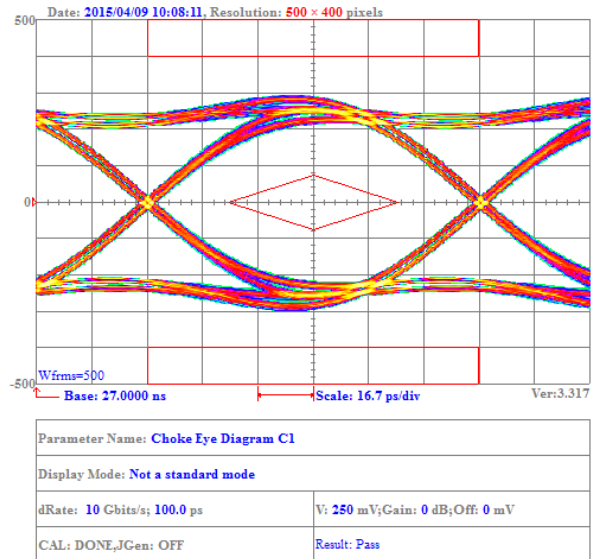
TDR For USB3.0 Testing:



Eye Diagram For HDMI2.0 Testing:



Eye Diagram For USB3.0 Testing:



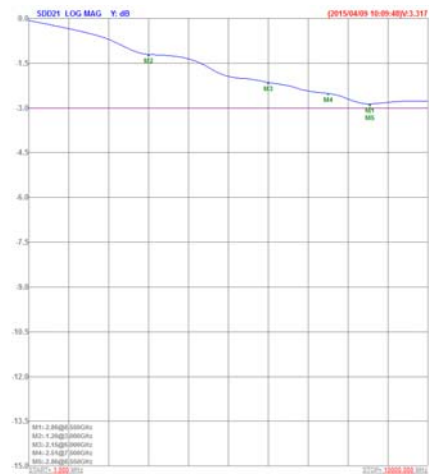
Please be sure to request approval specifications that provide further details of the products. Kindly note that the content of these specifications are subject to change or may be discontinued without advance notice. Please contact our sales department before ordering.

CUWI21T-900Y-N

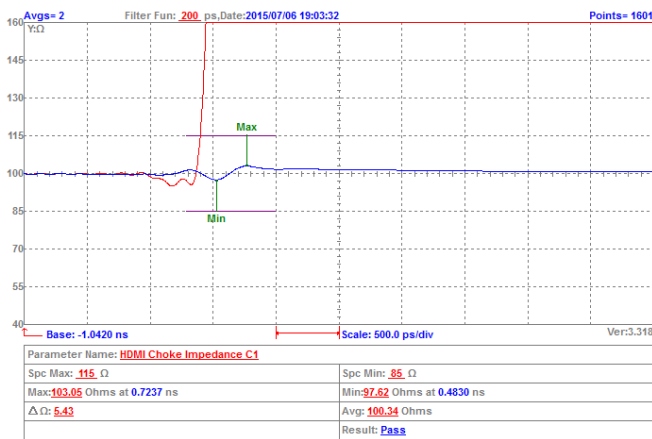
Insertion Loss For HDMI2.0 Testing:



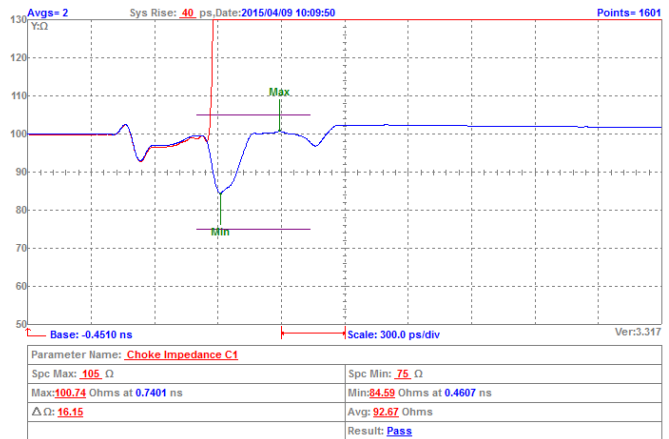
Insertion Loss For USB3.0 Testing:



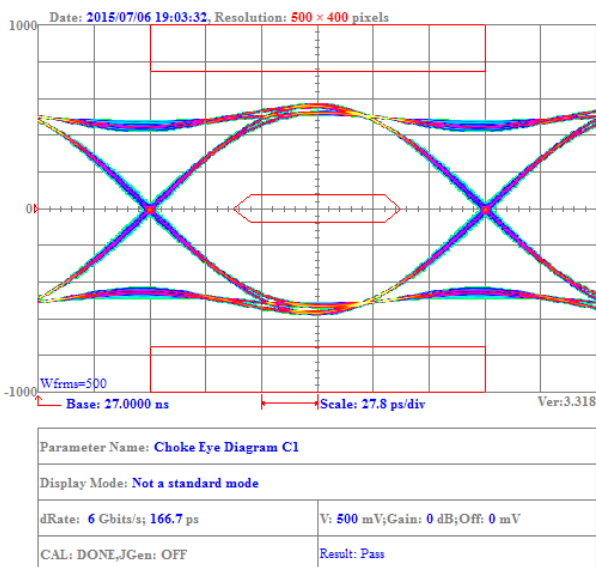
TDR For HDMI2.0 Testing:



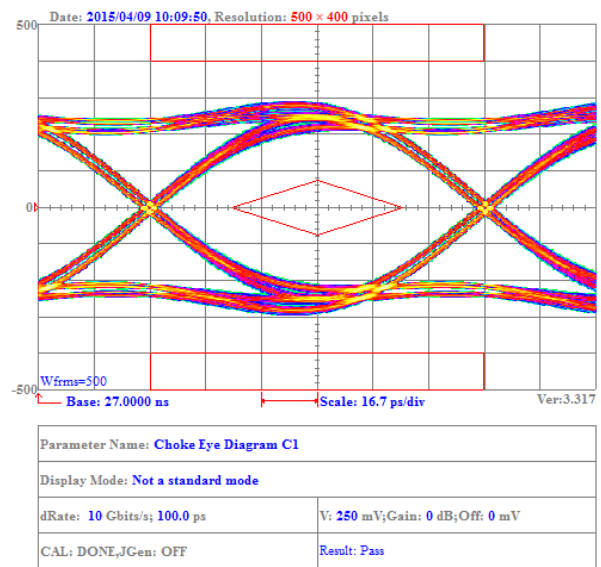
TDR For USB3.0 Testing:



Eye Diagram For HDMI2.0 Testing:



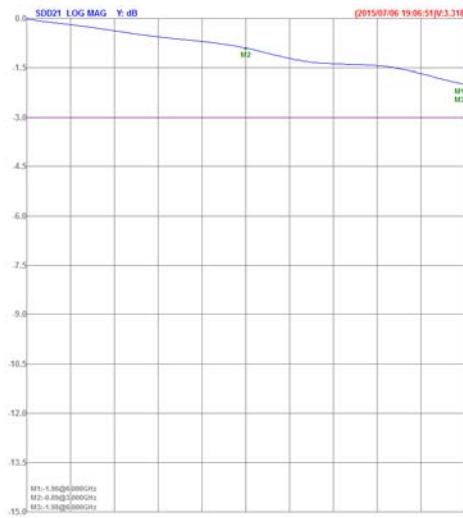
Eye Diagram For USB3.0 Testing:



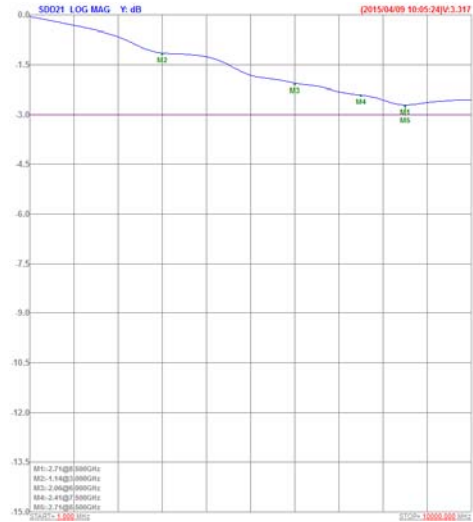
Please be sure to request approval specifications that provide further details of the products. Kindly note that the content of these specifications are subject to change or may be discontinued without advance notice. Please contact our sales department before ordering.

CUWI21T-121Y-N

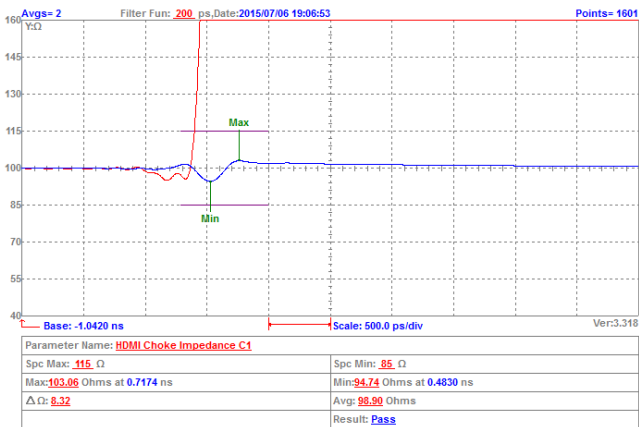
Insertion Loss For HDMI2.0 Testing:



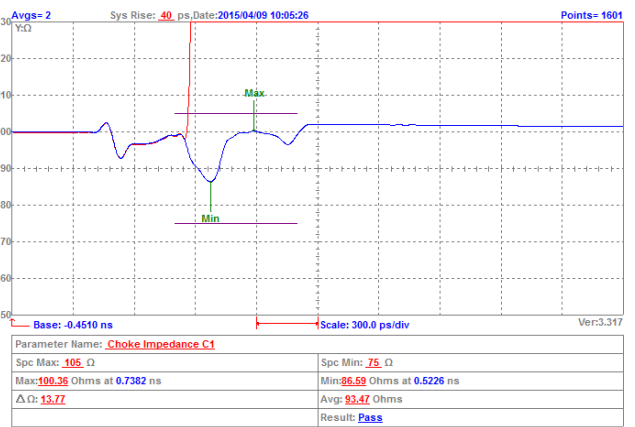
Insertion Loss For USB3.0 Testing:



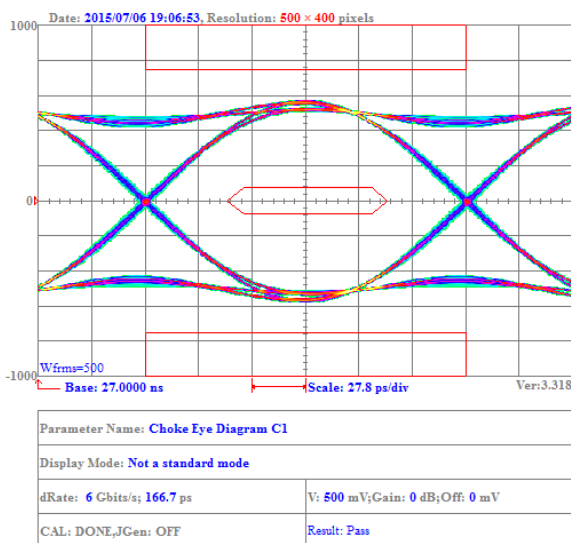
TDR For HDMI2.0 Testing:



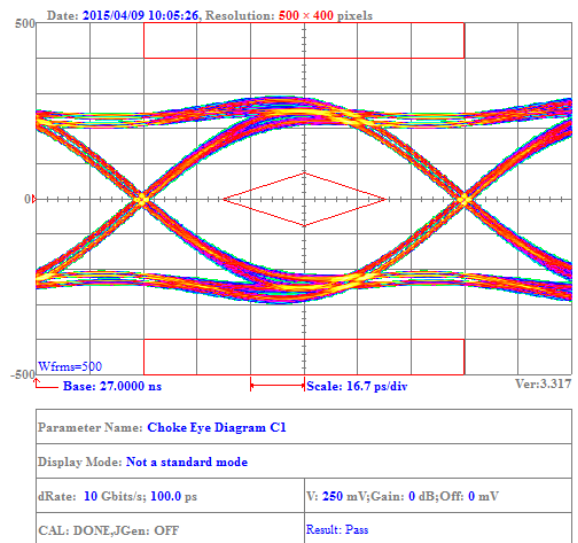
TDR For USB3.0 Testing:



Eye Diagram For HDMI2.0 Testing:



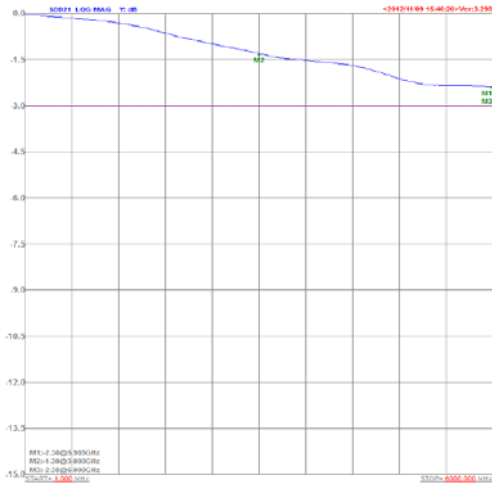
Eye Diagram For USB3.0 Testing:



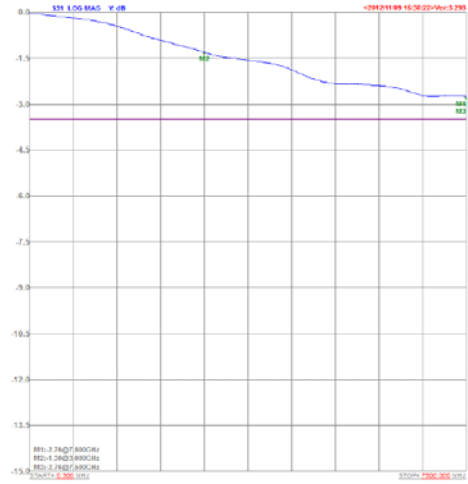
Please be sure to request approval specifications that provide further details of the products. Kindly note that the content of these specifications are subject to change or may be discontinued without advance notice. Please contact our sales department before ordering.

CUWI21T-131Y-N

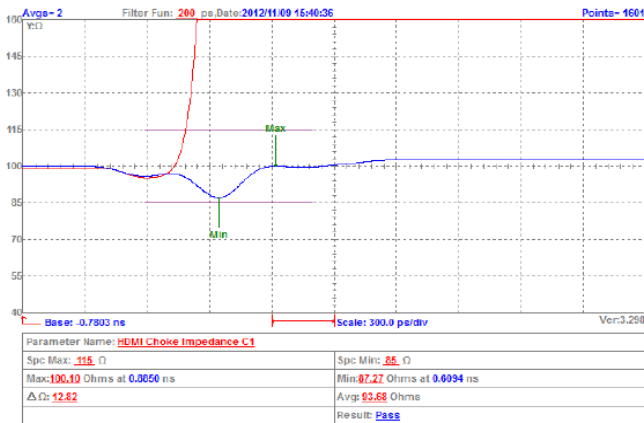
Insertion Loss For HDMI Testing:



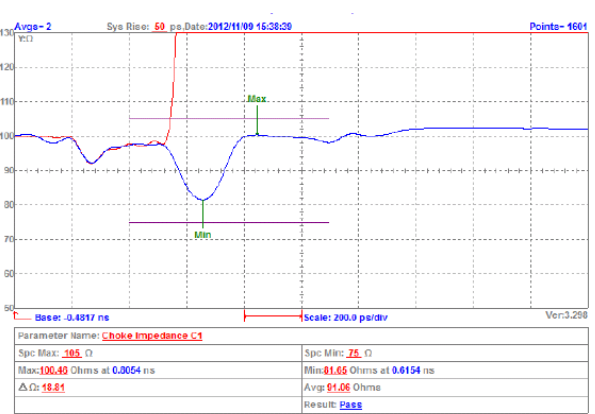
Insertion Loss For USB3.0 Testing:



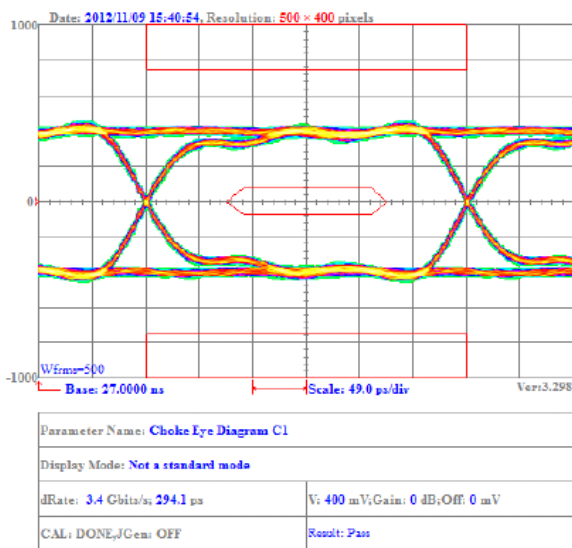
TDR For HDMI Testing:



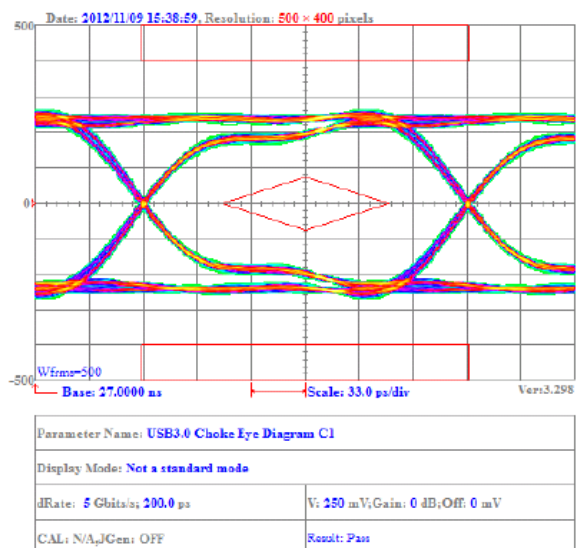
TDR For USB3.0 Testing:



Eye Diagram For HDMI Testing:

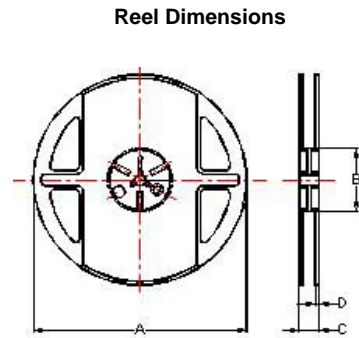
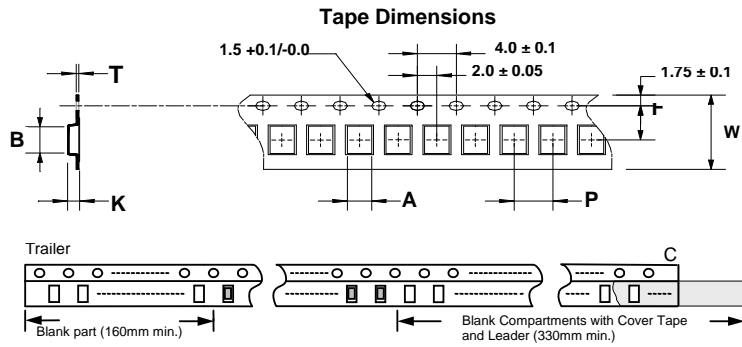


Eye Diagram For USB3.0 Testing:



Please be sure to request approval specifications that provide further details of the products. Kindly note that the content of these specifications are subject to change or may be discontinued without advance notice. Please contact our sales department before ordering.

Packaging Specifications



Dimensions in mm

| TYPE | Tape Dimensions | | | | | | | Reel Dimensions | | | | Quantity PCS / Reel |
|--------|-----------------|------|------|---|---|-----|------|-----------------|----|----|-----|------------------------|
| | A | B | T | W | P | F | K | A | B | C | D | |
| CUWI11 | 1.15 | 1.45 | 0.25 | 8 | 4 | 3.5 | 1.00 | 178 | 60 | 12 | 1.5 | 2000 |
| CUWI21 | 1.50 | 2.25 | 0.24 | 8 | 4 | 3.5 | 1.35 | 178 | 60 | 12 | 1.5 | 2000 |



Total Solution Provider for EMI, Power and RF.

Inductors Leaded Components



DMI Series



DMI series is designed with low RDC and ultra large current. Its molded magnetic shielded type is suitable for high-density mounting and ultra low buzz noise. Soldering conditions can be easily confirmed when mounting onto the board. This series also provides customers with embossed carrier type packaging for automatic mounting machine.

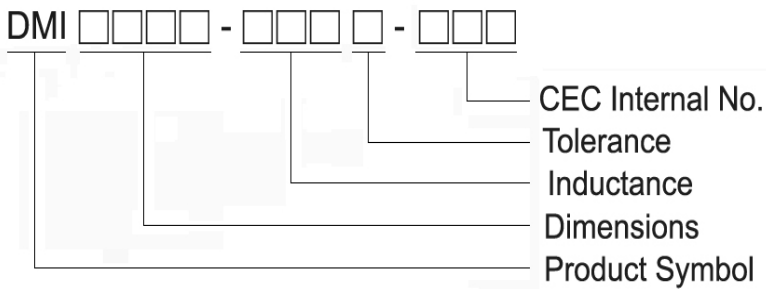
Features

- Shield construction
- Ultra low buzz noise, due to un-assembly structure
- 100% Lead free

Applications

- High density DC/DC converters
- POL convertes
- High current VRM/VRD for notebook / Server / desktop CPUs
- High speed charger

Product Identification



Shapes and Dimensions

FIG 1

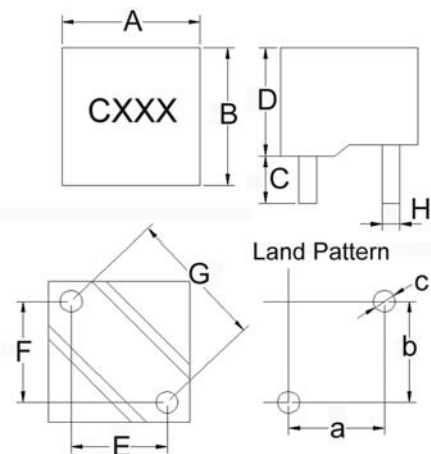


FIG 2

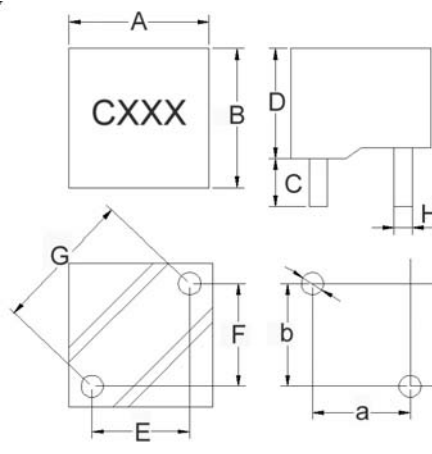
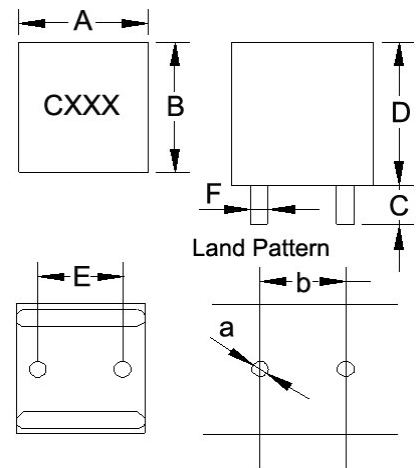


FIG 3



Leaded Power Chokes DMI Series

Dimensions in mm

| TYPE | FIG | A | B | C | D | E | F | G | H | a | b | c |
|------------------|-----|----------------|----------------|----------------|---------------|----------------|----------------|-------------------------------------|-----------------|------------|------------|------------|
| DMI0707-R40M-N | 2 | 7.2±0.5 | 7.2±0.5 | 3.4±0.5 | 7.5Max | 3.8±0.5 | 3.8±0.5 | 5.4±0.5 | 0.9Φ±0.1 | 4.3 | 4.3 | 1.4 |
| DMI0805-R40M-N | 2 | 8.0±0.5 | 8.0±0.5 | 3.4±0.5 | 5.5±0.5 | 4.7±0.5 | 4.7±0.5 | 6.6±0.5 | 1.0Φ±0.1 | 5.2 | 5.2 | 1.5 |
| DMI0806-R47M-N | 2 | 8.0±0.5 | 8.0±0.5 | 3.4±0.5 | 6.0Max | 4.7±0.5 | 4.7±0.5 | 6.6±0.5 | 1.0Φ±0.1 | 5.2 | 5.2 | 1.5 |
| DMI0807-1R0M-N | 3 | 8.5±0.5 | 8.5±0.5 | 3.4±0.5 | 7.5Max | 5.0±0.5 | 0.8ø±0.1 | - | - | 1.3 | 5.5 | - |
| DMI0808-R30M-N | 1 | 8.5Max | 8.5Max | 3.4±0.5 | 9.0Max | 4.7±0.5 | 4.7±0.5 | 6.6±0.5 | 1.1ø±0.1 | 5.2 | 5.2 | 1.6 |
| DMI0808-1R0M-N | 3 | 9.0Max | 9.0Max | 3.4±0.5 | 9.0Max | 5.0±0.5 | 0.8ø±0.1 | - | - | 1.3 | 5.5 | - |
| DMI0809-1R0M-N | 1 | 8.0Max | 8.0Max | 3.4±0.5 | 9.5Max | 4.2±0.5 | 4.2±0.5 | 5.9±0.5 | 1.1ø±0.1 | 4.7 | 4.7 | 1.6 |
| DMI0809-2R2M-N | 1 | 8.0Max | 8.0Max | 3.4±0.5 | 9.5Max | 4.2±0.5 | 4.2±0.5 | 5.9±0.5 | 0.9ø±0.1 | 4.7 | 4.7 | 1.4 |
| DMI0809-2R2M-N1 | 2 | 8.5±0.5 | 8.5±0.5 | 3.4±0.5 | 9.8Max | 4.0±0.5 | 5.5±0.5 | 6.8±0.5 | 0.9Φ±0.1 | 4.5 | 6 | 1.4 |
| DMI0809-R20M-N64 | 2 | 8.5Max | 8.5Max | 3.4±0.5 | 9.5Max | 4.7±0.5 | 4.7±0.5 | 6.6±0.5 | 1.2Φ±0.1 | 5.2 | 5.2 | 1.7 |
| DMI0809-R50M-NA | 1 | 8.5±0.5 | 8.5±0.5 | 3.4±0.5 | 8.5Max | 3.5±0.5 | 5.5±0.5 | 6.52±0.5 | 1.1Φ±0.1 | 4.0 | 6.0 | 1.6 |
| DMI0809-R56M-N | 2 | 8.5Max | 8.5Max | 3.4±0.5 | 9.5Max | 4.7±0.5 | 4.7±0.5 | 6.6 ^{+0.3} _{-0.5} | 1.2ø±0.1 | 5.2 | 5.2 | 1.7 |
| DMI0809-R56M-N18 | 2 | 8.5Max | 8.5Max | 3.4±0.5 | 9.5Max | 4.7±0.5 | 4.7±0.5 | 6.6±0.5 | 1.2Φ±0.1 | 5.2 | 5.2 | 1.7 |
| DMI0909-1R2M-N | 1 | 9.0Max | 9.0Max | 3.4±0.5 | 9.0Max | 4.6±0.5 | 4.6±0.5 | 6.5±0.5 | 0.9Φ±0.1 | 5.1 | 5.1 | 1.4 |
| DMI0909-R25M-N | 2 | 9.0Max | 8.2Max | 3.4±0.5 | 9.5Max | 6.5±0.5 | 2.7±0.5 | 6.85±0.5 | 1.2ø±0.1 | 7 | 3.2 | 1.7 |
| DMI0810-1R0M-NA | 1 | 8.5±0.5 | 8.5±0.5 | 3.4±0.5 | 10.0Max | 3.5±0.5 | 5.5±0.5 | 6.5±0.5 | 1.0Φ±0.1 | 4.0 | 6.0 | 1.5 |
| DMI1007-R18M-NA | 2 | 10.7Max | 7.2Max | 3.4±0.5 | 7.5±0.5 | 5.4±0.3 | 3.6±0.3 | 6.5±0.3 | 1.0Φ±0.1 | 5.9 | 4.1 | 1.5 |
| DMI1007A-R18M-NA | 2 | 10.7Max | 7.2Max | 3.4±0.5 | 7.0±0.5 | 5.4±0.3 | 3.6±0.3 | 6.5±0.3 | 1.1Φ±0.1 | 5.9 | 4.1 | 1.6 |
| DMI1007-R36M-NA | 2 | 10.7Max | 7.2Max | 3.4±0.5 | 6.6±0.5 | 5.4±0.3 | 3.6±0.3 | 6.5±0.3 | 1.1Φ±0.1 | 5.9 | 4.1 | 1.6 |
| DMI1007-R60M-NA | 2 | 10.7Max | 7.2Max | 3.4±0.5 | 7.5±0.5 | 5.4±0.3 | 3.6±0.3 | 6.5±0.3 | 1.0Φ±0.1 | 5.9 | 4.1 | 1.5 |
| DMI1007A-R60M-NA | 2 | 10.7Max | 7.2Max | 3.4±0.5 | 7.5±0.5 | 5.4±0.3 | 3.6±0.3 | 6.5±0.3 | 1.1Φ±0.1 | 5.9 | 4.1 | 1.6 |
| DMI1008-R47M-N | 2 | 10±0.5 | 10±0.5 | 3.4±0.5 | 8.0Max | 5.6±0.5 | 5.6±0.5 | 7.9±0.5 | 1.2Φ±0.1 | 6.1 | 6.1 | 1.7 |
| DMI1008-R56M-N | 2 | 10±0.5 | 10±0.5 | 3.4±0.5 | 8.0Max | 5.6±0.5 | 5.6±0.5 | 7.9±0.5 | 1.2Φ±0.1 | 6.1 | 6.1 | 1.7 |
| DMI1008-R68M-N | 2 | 10±0.5 | 10±0.5 | 3.4±0.5 | 8.0Max | 5.6±0.5 | 5.6±0.5 | 7.9±0.5 | 1.2Φ±0.1 | 6.1 | 6.1 | 1.7 |
| DMI1008-R82M-N | 2 | 10±0.5 | 10±0.5 | 3.4±0.5 | 8.0Max | 5.6±0.5 | 5.6±0.5 | 7.9±0.5 | 1.2Φ±0.1 | 6.1 | 6.1 | 1.7 |
| DMI1008-1R0M-N | 2 | 10±0.5 | 10±0.5 | 3.4±0.5 | 8.0Max | 5.6±0.5 | 5.6±0.5 | 7.9±0.5 | 1.2Φ±0.1 | 6.1 | 6.1 | 1.7 |
| DMI1008-1R2M-N | 2 | 10±0.5 | 10±0.5 | 3.4±0.5 | 8.0Max | 5.6±0.5 | 5.6±0.5 | 7.9±0.5 | 1.2Φ±0.1 | 6.1 | 6.1 | 1.7 |
| DMI1009-R22M-N | 2 | 10±0.5 | 10±0.5 | 3.4±0.5 | 9.8Max | 5.6±0.5 | 5.6±0.5 | 7.9±0.5 | 1.2Φ±0.1 | 6.1 | 6.1 | 1.7 |
| DMI1009-R68M-N | 2 | 10.5Max | 10.5Max | 3.4±0.5 | 9.8Max | 5.6±0.5 | 5.6±0.5 | 7.9±0.5 | 1.4ø±0.1 | 6.1 | 6.1 | 1.9 |
| DMI1009-R80M-N | 2 | 10.5Max | 10.5Max | 3.4±0.5 | 9.8Max | 4.5±0.5 | 6.0±0.5 | 7.5±0.5 | 1.2Φ±0.1 | 5.0 | 6.5 | 1.7 |
| DMI1009-R80M-NA | 1 | 10.5±0.5 | 10.5±0.5 | 3.4±0.5 | 9.0±0.5 | 4.5±0.5 | 6.0±0.5 | 7.5±0.5 | 1.3Φ±0.1 | 5.0 | 6.5 | 1.8 |
| DMI1009-1R0M-N | 2 | 10±0.5 | 10±0.5 | 3.4±0.5 | 9.8Max | 5.6±0.5 | 5.6±0.5 | 7.9±0.5 | 1.2Φ±0.1 | 6.1 | 6.1 | 1.7 |
| DMI1009-1R0M-N1 | 2 | 10±0.5 | 10±0.5 | 3.4±0.5 | 9.8Max | 6.5±0.5 | 4.5±0.5 | 7.9±0.5 | 1.2Φ±0.1 | 7.0 | 5.0 | 1.7 |
| DMI1009-1R2M-N | 2 | 10.5Max | 10.5Max | 3.4±0.5 | 9.8Max | 5.6±0.5 | 5.6±0.5 | 7.9±0.5 | 1.3ø±0.1 | 6.1 | 6.1 | 1.8 |
| DMI10507-R15M-NA | 3 | 10.3±0.3 | 5.3±0.3 | 3.3±0.5 | 7.5±0.45 | - | - | 6.1±0.3 | 1.1Φ±0.1 | - | - | 1.6 |
| DMI10507-R30M-NA | 3 | 10.3±0.3 | 5.3±0.3 | 3.3±0.5 | 7.5±0.45 | - | - | 6.1±0.3 | 1.1Φ±0.1 | - | - | 1.6 |
| DMI10507-R60M-NA | 3 | 10.3±0.3 | 5.3±0.3 | 3.3±0.5 | 7.5±0.45 | - | - | 6.1±0.3 | 0.8Φ±0.1 | - | - | 1.3 |
| DMI10709-1R0M-N | 2 | 10±0.5 | 7.0±0.5 | 3.4±0.5 | 9.8Max | 3.6±0.5 | 6.2±0.5 | 7.2±0.5 | 0.9Φ±0.1 | 4.1 | 6.7 | 1.4 |

Leaded Power Chokes DMI Series

Dimensions in mm

| TYPE | FIG | A | B | C | D | E | F | G | H | a | b | c |
|------------------|-----|----------|----------|---------|---------|---------|---------|-----------------------------------|----------|-----|-----|-----|
| DMI10709-R47M-N | 2 | 10±0.5 | 7.0±0.5 | 3.4±0.5 | 9.8Max | 3.6±0.5 | 6.2±0.5 | 7.2±0.5 | 1.0Φ±0.1 | 4.1 | 6.7 | 1.5 |
| DMI10709-R56M-N | 2 | 10±0.5 | 7.0±0.5 | 3.4±0.5 | 9.8Max | 3.6±0.5 | 6.2±0.5 | 7.2±0.5 | 1.0Φ±0.1 | 4.1 | 6.7 | 1.5 |
| DMI10709-R68M-N | 2 | 10±0.5 | 7.0±0.5 | 3.4±0.5 | 9.8Max | 3.6±0.5 | 6.2±0.5 | 7.2±0.5 | 1.0Φ±0.1 | 4.1 | 6.7 | 1.5 |
| DMI10709-R82M-N | 2 | 10±0.5 | 7.0±0.5 | 3.4±0.5 | 9.8Max | 3.6±0.5 | 6.2±0.5 | 7.2±0.5 | 1.0Φ±0.1 | 4.1 | 6.7 | 1.5 |
| DMI1107-R36M-N | 1 | 11.5±0.5 | 11.5±0.5 | 3.5±0.5 | 7.4±0.2 | 5.7±0.5 | 6.3±0.5 | 8.5±0.5 | 1.5Φ±0.1 | 6.2 | 6.8 | 2 |
| DMI1107-R47M-N | 1 | 11.5±0.5 | 11.5±0.5 | 3.4±0.5 | 7.5±0.5 | 6.7±0.5 | 5.6±0.5 | 8.73±0.5 | 1.5Φ±0.1 | 7.2 | 6.1 | 2 |
| DMI1108-R30M-N | 1 | 11.5Max | 9.5Max | 3.4±0.5 | 8.5Max | 6.6±0.5 | 4.2±0.5 | 7.8±0.5 | 1.5ø±0.1 | 7.1 | 4.7 | 2 |
| DMI1108-R36M-N | 1 | 11.7Max | 9.7Max | 3.5±0.5 | 8.8Max | 6.6±0.5 | 4.2±0.5 | 7.8±0.5 | 1.4ø±0.1 | 7.1 | 4.7 | 1.9 |
| DMI1108-R60M-N | 1 | 11.7Max | 11.7Max | 3.5±0.5 | 8.5Max | 6.3±0.5 | 5.7±0.5 | 8.5±0.5 | 1.5ø±0.1 | 6.8 | 6.2 | 2 |
| DMI1108-1R8M-N | 1 | 11.7Max | 11.7Max | 3.5±0.5 | 8.5Max | 6.6±0.5 | 6.6±0.5 | 9.3±0.5 | 1.2ø±0.1 | 7.1 | 7.1 | 1.7 |
| DMI1109-1R0M-N | 2 | 11.8Max | 11.8Max | 3.4±0.5 | 9.8Max | 6.0±0.5 | 6.7±0.5 | 9.0±0.5 | 1.5Φ±0.1 | 6.5 | 7.2 | 2 |
| DMI1109-1R2M-N | 2 | 11.5Max | 11.5Max | 3.4±0.5 | 9.8Max | 6.7±0.5 | 6.0±0.5 | 9 ^{+0.3} _{-0.5} | 1.5ø±0.1 | 7.2 | 6.5 | 2 |
| DMI1109-1R5M-N | 1 | 11.5±0.5 | 11.5±0.5 | 3.4±0.5 | 9.5±0.5 | 7.3±0.5 | 7.3±0.5 | 10.3±0.5 | 1.4ø±0.1 | 7.8 | 7.8 | 1.9 |
| DMI1109-R30M-N | 1 | 11.5±0.5 | 11.5±0.5 | 3.4±0.5 | 9.5±0.5 | 7.3±0.5 | 6.0±0.5 | 9.4±0.5 | 1.4ø±0.1 | 7.8 | 6.5 | 1.9 |
| DMI1109-R56M-N | 1 | 11.7Max | 9.7Max | 3.5±0.5 | 9.5Max | 6.6±0.5 | 4.2±0.5 | 7.8±0.5 | 1.3ø±0.1 | 7.1 | 4.7 | 1.8 |
| DMI1109-R60M-N | 2 | 11.8Max | 11.8Max | 3.4±0.5 | 9.8Max | 6.0±0.5 | 6.7±0.5 | 9.0±0.5 | 1.5Φ±0.1 | 6.5 | 7.2 | 2 |
| DMI1109-R68M-N | 2 | 11.8Max | 11.8Max | 3.4±0.5 | 9.8Max | 6.7±0.5 | 6.0±0.5 | 9 ^{+0.3} _{-0.5} | 1.5ø±0.1 | 7.2 | 6.5 | 2 |
| DMI1110-R60M-N | 1 | 11.6Max | 11.6Max | 3.4±0.5 | 10Max | 7.3±0.5 | 6.0±0.5 | 9.4±0.3 | 1.4ø±0.1 | 7.8 | 6.5 | 1.9 |
| DMI1110-1R1M-N | 1 | 11.6Max | 11.6Max | 3.2±0.5 | 10Max | 6.7±0.5 | 6.0±0.5 | 9.0±0.5 | 1.4ø±0.1 | 7.2 | 6.5 | 1.9 |
| DMI1208-R22M-N | 2 | 12Max | 12Max | 3.4±0.5 | 8.0Max | 7.3±0.5 | 6.0±0.5 | 9.4±0.5 | 1.4ø±0.1 | 7.8 | 6.5 | 1.9 |
| DMI1208-R36M-N | 1 | 11.5±0.5 | 11.5±0.5 | 3.5±0.5 | 7.4±0.2 | 5.7±0.5 | 6.3±0.5 | 8.5±0.5 | 1.5ø±0.1 | 6.2 | 6.8 | 2 |
| DMI1208-R47M-N | 2 | 12Max | 12Max | 3.4±0.5 | 8.0Max | 7.3±0.5 | 6.0±0.5 | 9.4±0.5 | 1.4ø±0.1 | 7.8 | 6.5 | 1.9 |
| DMI1208-R56M-N | 2 | 12Max | 12Max | 3.4±0.5 | 8.0Max | 7.3±0.5 | 6.0±0.5 | 9.4±0.5 | 1.4ø±0.1 | 7.8 | 6.5 | 1.9 |
| DMI1209-R33M-N | 2 | 12Max | 12Max | 3.4±0.5 | 9.0Max | 7.3±0.5 | 6.0±0.5 | 9.4±0.5 | 1.4ø±0.1 | 7.8 | 6.5 | 1.9 |
| DMI1209-R47M-N | 2 | 12Max | 12Max | 3.4±0.5 | 9.0Max | 7.3±0.5 | 6.0±0.5 | 9.4±0.5 | 1.4ø±0.1 | 7.8 | 6.5 | 1.9 |
| DMI1209-R68M-N | 2 | 12Max | 12Max | 3.4±0.5 | 9.0Max | 7.3±0.5 | 6.0±0.5 | 9.4±0.5 | 1.4ø±0.1 | 7.8 | 6.5 | 1.9 |
| DMI1209-1R0M-N | 2 | 12Max | 12Max | 3.4±0.5 | 9.0Max | 7.3±0.5 | 6.0±0.5 | 9.4±0.5 | 1.5ø±0.1 | 7.8 | 6.5 | 2 |
| DMI1209-2R5M-N | 1 | 12Max | 12Max | 3.4±0.5 | 9.0Max | 6.6±0.5 | 6.6±0.5 | 9.3±0.5 | 1.2ø±0.1 | 7.1 | 7.1 | 1.7 |
| DMI1210-100M-N | 2 | 12.0±0.5 | 12.0±0.5 | 3.4±0.5 | 10.0Max | 7.0±0.5 | 7.0±0.5 | 10.0±0.3 | 1.0Φ±0.1 | 7.5 | 7.5 | 2 |
| DMI1210-1R2M-N58 | 2 | 11.8Max | 11.8Max | 3.4±0.5 | 9.8Max | 6.0±0.5 | 6.7±0.5 | 9.0±0.5 | 1.5Φ±0.1 | 6.5 | 7.2 | 2 |
| DMI1210-1R8M-N | 2 | 12Max | 12Max | 3.4±0.5 | 10.5Max | 6.0±0.5 | 6.0±0.5 | 8.5±0.5 | 1.1ø±0.1 | 6.5 | 6.5 | 1.6 |
| DMI1210-4R7M-N | 1 | 12Max | 12Max | 3.4±0.5 | 12Max | 7.0±0.5 | 7.0±0.5 | 10±0.5 | 1.1ø±0.1 | 7.5 | 7.5 | 1.6 |
| DMI1210-R30M-N | 1 | 12Max | 12Max | 3.4±0.5 | 10Max | 7.3±0.5 | 6.0±0.5 | 9.4±0.5 | 1.4ø±0.1 | 7.8 | 6.5 | 1.9 |
| DMI1210-R36M-N63 | 2 | 11.8Max | 11.8Max | 3.4±0.5 | 9.8Max | 6.0±0.5 | 6.7±0.5 | 9.0±0.5 | 1.5Φ±0.1 | 6.5 | 7.2 | 2 |
| DMI1210-R47M-N | 1 | 12Max | 12Max | 3.4±0.5 | 10Max | 7.3±0.5 | 6.0±0.5 | 9.4±0.5 | 1.4ø±0.1 | 7.8 | 6.5 | 1.9 |
| DMI1210-R68M-N61 | 2 | 11.8Max | 11.8Max | 3.4±0.5 | 9.8Max | 6.0±0.5 | 6.7±0.5 | 9.0±0.5 | 1.5Φ±0.1 | 6.5 | 7.2 | 2 |
| DMI1213-1R0M-N1 | 2 | 13.0±0.5 | 12.0±0.5 | 3.4±0.5 | 10.0Max | 7.6±0.5 | 6.6±0.5 | 10.0±0.5 | 1.5Φ±0.2 | 8.1 | 7.1 | 2 |

Electrical Characteristics

| Part Number | Inductance (μ H) | Tolerance (\pm %) | Test Frequency (KHz) | RDC (m Ω) Max | Isat (A) Typ. | Irms (A) Typ. |
|------------------|--------------------------|-------------------------|-------------------------|--------------------------|------------------|------------------|
| DMI0808-R30M-N | 0.30 | 20 | 100/ 1V | 1.0 | 35 | 32 |
| DMI0808-1R0M-N | 1.00 | 20 | 100/ 1V | 4.0 | 12 | 16 |
| DMI0809-R56M-N | 0.56 | 20 | 100/ 1V | 1.3 | 25 | 25 |
| DMI0809-1R0M-N | 1.00 | 20 | 100/ 1V | 1.8 | 23 | 35 |
| DMI0809-2R2M-N | 2.20 | 20 | 100/ 1V | 3.5 | 13 | 17 |
| DMI0909-R25M-N | 0.25 | 20 | 100/ 1V | 0.8 | 28 | 35 |
| DMI1007-R18M-NA | 0.18 | 20 | 100/ 1V | 0.59 | 45 | 40 |
| DMI1007A-R18M-NA | 0.18 | 20 | 100/ 1V | 0.65 | 45 | 45 |
| DMI1009-R80M-NA | 0.80 | 20 | 100/ 1V | 1.1 | 30 | 30 |
| DMI10507-R15M-NA | 0.15 | 20 | 100/ 1V | 0.52 | 40 | 42 |
| DMI10507-R30M-NA | 0.30 | 20 | 100/ 1V | 0.82 | 30 | 43 |
| DMI10507-R60M-NA | 0.60 | 20 | 100/ 1V | 2.05 | 22 | 30 |
| DMI1108-R30M-N | 0.30 | 20 | 100/ 1V | 1.0 | 50 | 38 |
| DMI1108-R36M-N | 0.36 | 20 | 100/ 1V | 0.7 | 50 | 43 |
| DMI1108-1R8M-N | 1.80 | 20 | 100/ 1V | 3.0 | 24 | 24 |
| DMI1109-R56M-N | 0.56 | 20 | 100/ 1V | 1.08 | 50 | 37 |
| DMI1109-R68M-N | 0.68 | 20 | 100/ 1V | 1.2 | 40 | 35 |
| DMI1110-R60M-N | 0.60 | 20 | 100/ 1V | 1.2 | 40 | 42 |
| DMI1110-1R1M-N | 1.10 | 20 | 100/ 1V | 1.5 | 35 | 28 |
| DMI1208-R22M-N | 0.22 | 20 | 100/ 1V | 0.6 | 75 | 38 |
| DMI1208-R47M-N | 0.47 | 20 | 100/ 1V | 0.9 | 55 | 38 |
| DMI1208-R56M-N | 0.56 | 20 | 100/ 1V | 0.9 | 45 | 38 |
| DMI1209-R33M-N | 0.33 | 20 | 100/ 1V | 0.9 | 70 | 35 |
| DMI1209-R47M-N | 0.47 | 20 | 100/ 1V | 0.9 | 50 | 38 |
| DMI1209-R68M-N | 0.68 | 20 | 100/ 1V | 1.2 | 45 | 35 |
| DMI1209-1R0M-N | 1.00 | 20 | 100/ 1V | 1.5 | 35 | 35 |
| DMI1209-2R5M-N | 2.50 | 20 | 100/ 1V | 2.6 | 25 | 27 |
| DMI1210-R47M-N | 0.47 | 20 | 100/ 1V | 1.0 | 50 | 30 |
| DMI1210-1R8M-N | 1.80 | 20 | 100/ 1V | 3.3 | 29 | 22 |
| DMI1210-4R7M-N | 4.70 | 20 | 100/ 1V | 6.0 | 12 | 17 |

Note: When ordering, please specify tolerance code. Tolerance: M=±20%

- Customized Specifications are welcome
- Isat for Inductance drop 20% from its value with current
- Irms for a 40°C temperature rise from 25°C ambient with current
- Measure Equipment :
L : WK4237
RDC : CHEN HWA502
Isat & Irms : WK3260B/ 3265

Electrical Characteristics

| Part Number | Inductance (μ H) | Tolerance (\pm %) | Test Frequency (KHz) | RDC (m Ω) Max | Isat (A) Typ. | Irms (A) Typ. |
|------------------|--------------------------|-------------------------|-------------------------|--------------------------|------------------|------------------|
| DMI0809-R50M-NA | 0.50 | 20 | 100/ 1V | 1.32 | 30 | 30 |
| DMI0810-1R0M-NA | 1.00 | 20 | 100/ 1V | 2.25 | 25 | 25 |
| DMI1007-R36M-NA | 0.36 | 20 | 100/ 1V | 0.89 | 30 | 30 |
| DMI1007-R60M-NA | 0.60 | 20 | 100/ 1V | 1.39 | 25 | 25 |
| DMI1007A-R60M-NA | 0.60 | 20 | 100/ 1V | 1.51 | 25 | 25 |

Note: When ordering, please specify tolerance code. Tolerance: M=±20%

- Customized Specifications are welcome
- Isat for Inductance drop 25% from its value with current
- Irms for a 40°C temperature rise from 25°C ambient with current
- Measure Equipment :
L : WK4237
RDC : CHEN HWA502
Isat & Irms : WK3260B/ 3265

Electrical Characteristics

| Part Number | Inductance (μ H) | Tolerance (\pm %) | Test Frequency (KHz) | RDC (m Ω) Max | Isat (A) Typ. | Irms (A) Typ. |
|------------------|--------------------------|-------------------------|-------------------------|--------------------------|------------------|------------------|
| DMI0707-R40M-N | 0.4 | 20 | 100/ 1V | 1.60 | 27 | 16 |
| DMI0805-R40M-N | 0.4 | 20 | 100/ 1V | 1.45 | 31 | 25 |
| DMI0806-R47M-N | 0.47 | 20 | 100/ 1V | 1.50 | 22 Max | 22 Max |
| DMI0807-1R0M-N | 1.0 | 20 | 100/ 1V | 4.00 | 28 | 15 |
| DMI0809-R20M-N64 | 0.2 | 20 | 100/ 1V | 0.80 | 30 Max | 25 Max |
| DMI0809-R20M-NA | 0.2 | 20 | 100/ 1V | 0.80 | 40 | 30 Max |
| DMI0809-R56M-N18 | 0.56 | 20 | 100/ 1V | 1.30 | 23 Max | 20 Max |
| DMI0809-2R2M-N1 | 2.2 | 20 | 100/ 1V | 4.50 | 17 | 16 Max |
| DMI0909-1R2M-N | 1.2 | 20 | 100/ 1V | 3.00 | 20 Max | 20 Max |
| DMI1008-R47M-N | 0.47 | 20 | 100/ 1V | 1.05 | 48 | 20 |
| DMI1008-R56M-N | 0.56 | 20 | 100/ 1V | 1.25 | 43 | 35 |
| DMI1008-R68M-N | 0.68 | 20 | 100/ 1V | 1.35 | 35 | 28 |
| DMI1008-R82M-N | 0.82 | 20 | 100/ 1V | 1.50 | 38 | 28 |
| DMI1008-1R0M-N | 1.0 | 20 | 100/ 1V | 1.6 | 33 | 25 |
| DMI1008-1R2M-N | 1.2 | 20 | 100/ 1V | 1.65 | 36 | 28 |
| DMI1009-R22M-N | 0.22 | 20 | 100/ 1V | 0.7 | 41 Max | 25 Max |
| DMI1009-R68M-N | 0.68 | 20 | 100/ 1V | 1.2 | 49 | 30 |
| DMI1009-R80M-N | 0.8 | 20 | 100/ 1V | 1.2 | 25 Max | 30 Max |
| DMI1009-1R0M-N | 1.0 | 20 | 100/ 1V | 1.65 | 22 Max | 24 Max |
| DMI1009-1R0M-N1 | 1.0 | 20 | 100/ 1V | 1.65 | 22 Max | 24 Max |
| DMI1009-1R2M-N | 1.2 | 20 | 100/ 1V | 1.7 | 33 | 28 |
| DMI1107-R36M-N | 0.36 | 20 | 100/ 1V | 0.8 | 60 Max | 45 Max |
| DMI1107-R47M-N | 0.47 | 20 | 100/ 1V | 1.0 | 40 | 32 |
| DMI1108-R60M-N | 0.6 | 20 | 100/ 1V | 1.0 | 40 | 35 |

Note: When ordering, please specify tolerance code. Tolerance: M=±20%

- Customized Specifications are welcome
- Isat for Inductance drop 25% from its value with current
- Irms for a 40°C temperature rise from 25°C ambient with current
- Measure Equipment :
L : WK4237
RDC : CHEN HWA502
Isat & Irms : WK3260B/ 3265

Electrical Characteristics

| Part Number | Inductance (μ H) | Tolerance (\pm %) | Test Frequency (KHz) | RDC (m Ω) Max | Isat (A) Typ. | Irms (A) Typ. |
|------------------|--------------------------|-------------------------|-------------------------|--------------------------|------------------|------------------|
| DMI1109-R30M-N | 0.3 | 20 | 100/ 1V | 0.7 | 46 | 40 |
| DMI1109-R60M-N | 0.6 | 20 | 100/ 1V | 0.93 | 31 Max | 40 Max |
| DMI1109-1R0M-N | 1.0 | 20 | 100/ 1V | 1.37 | 31 Max | 25 Max |
| DMI1109-1R2M-N | 1.2 | 20 | 100/ 1V | 1.2 | 40 | 30 |
| DMI1109-1R5M-N | 1.5 | 20 | 100/ 1V | 1.85 | 42 | 28 |
| DMI1208-R36M-N | 0.36 | 20 | 100/ 1V | 0.8 | 60 | 40 |
| DMI1209-R68M-N | 0.68 | 20 | 100/ 1V | 1.2 | 45 | 35 |
| DMI1210-R30M-N | 0.3 | 20 | 100/ 1V | 0.65 | 45 | 40 |
| DMI1210-R36M-N63 | 0.36 | 20 | 100/ 1V | 0.8 | 38 Max | 30 Max |
| DMI1210-R68M-N61 | 0.68 | 20 | 100/ 1V | 1.2 | 40 Max | 35 Max |
| DMI1210-1R2M-N58 | 1.2 | 20 | 100/ 1V | 1.2 | 38 Max | 30 Max |
| DMI1210-4R7M-N | 4.7 | 20 | 200/ 0.1V | 6 | 16 | 15 |
| DMI1210-100M-N | 10 | 20 | 200/ 0.1V | 9.3 | 8 | 8 |
| DMI1213-1R0M-N1 | 1.0 | 20 | 200/ 0.1V | 1.3 | 40 | 30 |
| DMI10709-R47M-N | 0.47 | 20 | 100/ 1V | 1.3 | 37 | 25 |
| DMI10709-R56M-N | 0.56 | 20 | 100/ 1V | 1.6 | 33 | 15 |
| DMI10709-R68M-N | 0.68 | 20 | 100/ 1V | 1.9 | 28 | 30 |
| DMI10709-R82M-N | 0.82 | 20 | 100/ 1V | 2.2 | 26 | 15 |
| DMI10709-1R0M-N | 1.0 | 20 | 100/ 1V | 2.9 | 22 | 18 |
| DMI10709-1R2M-N | 1.2 | 20 | 100/ 1V | 3.3 | 20 | 16 |

Note: When ordering, please specify tolerance code. Tolerance: M= \pm 20%

- Customized Specifications are welcome
- Isat for Inductance drop 30% from its value with current
- I rms for a 40 $^{\circ}$ C temperature rise from 25 $^{\circ}$ C ambient with current
- Measure Equipment :
L : WK4237
RDC : CHEN HWA502
Isat & I rms : WK3260B/ 3265

DMI Series



DMI series is designed with low RDC and ultra large current. Its molded magnetic shielded type is suitable for high-density mounting and ultra low buzz noise. Soldering conditions can be easily confirmed when mounting onto the board. This series also provides customers with embossed carrier type packaging for automatic mounting machine.

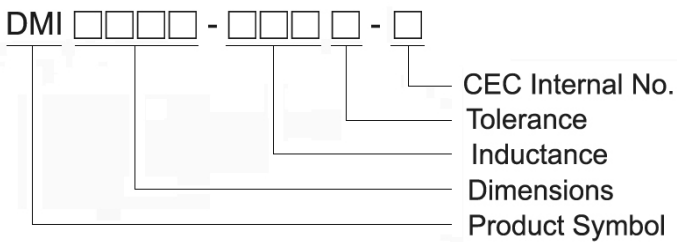
Features

- Shielded type
- Low RDC
- High saturation current
- High rated current
- AEC-Q200 qualified

Applications

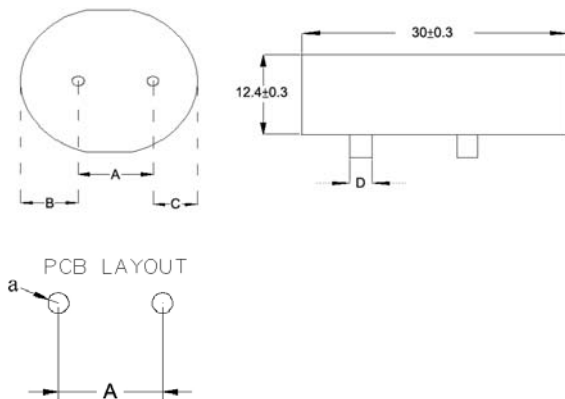
- DC/DC converters
- Engine and transmission control units
- Noise suppression for motors
 - Windshield wipers
 - Power seats
 - Heating and ventilation blowers
 - HID lighting
- LED drivers

Product Identification



Shapes and Dimensions

FIG 4



Dimensions in mm

| TYPE | FIG | A | B | C | D | a |
|----------------|-----|--------|----------|----------|---------|-----|
| DMI3012-1R0M-N | 4 | 15±0.5 | 8.8±0.5 | 6.2±0.5 | 2.5±0.1 | 2.9 |
| DMI3012-2R2M-N | 4 | 15±0.5 | 8.8±0.5 | 6.2±0.5 | 2.5±0.1 | 2.9 |
| DMI3012-3R3M-N | 4 | 15±0.5 | 7.5±0.5 | 7.5±0.5 | 2.0±0.1 | 2.4 |
| DMI3012-4R7M-N | 4 | 15±0.5 | 8.8±0.5 | 6.2±0.5 | 2.3±0.1 | 2.7 |
| DMI3012-6R8M-N | 4 | 15±0.5 | 8.8±0.5 | 6.2±0.5 | 2.3±0.1 | 2.7 |
| DMI3012-8R2M-N | 4 | 15±0.5 | 9.5±0.5 | 5.5±0.5 | 2.0±0.1 | 2.4 |
| DMI3012-100M-N | 4 | 15±0.5 | 9.5±0.5 | 5.5±0.5 | 1.8±0.1 | 2.2 |
| DMI3012-150M-N | 4 | 15±0.5 | 9.5±0.5 | 5.5±0.5 | 1.8±0.1 | 2.2 |
| DMI3012-220M-N | 4 | 15±0.5 | 9.25±0.5 | 5.75±0.5 | 1.6±0.1 | 2.0 |
| DMI3012-330M-N | 4 | 15±0.5 | 9.6±0.5 | 5.4±0.5 | 1.3±0.1 | 1.7 |
| DMI3012-470M-N | 4 | 15±0.5 | 9.6±0.5 | 5.4±0.5 | 1.3±0.1 | 1.7 |
| DMI3012-680M-N | 4 | 15±0.5 | 9.3±0.5 | 5.7±0.5 | 1.1±0.1 | 1.5 |
| DMI3012-101M-N | 4 | 15±0.5 | 9.3±0.5 | 5.7±0.5 | 1.1±0.1 | 1.5 |
| DMI3012-121M-N | 4 | 15±0.5 | 9.3±0.5 | 5.7±0.5 | 1.1±0.1 | 1.5 |

Electrical Characteristics

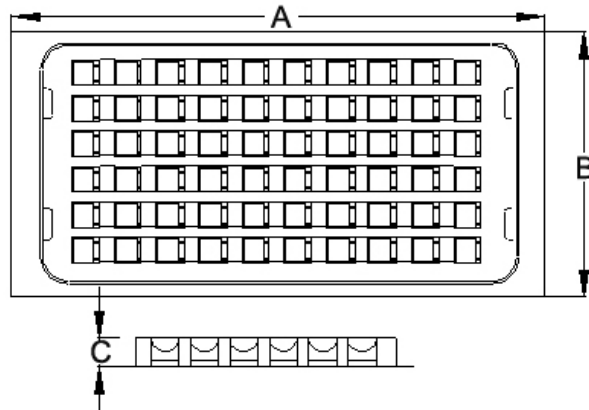
| Part Number | Inductance (μ H) | Tolerance (\pm %) | Test Frequency (KHz) | RDC(m Ω) Typ. (Max) | Isat (A) Typ. | Irms (A) Typ. |
|----------------|--------------------------|-------------------------|-------------------------|--------------------------------|------------------|------------------|
| DMI3012-1R0M-N | 1.00 | 20 | 100/ 1V | 0.39(0.50) | 65 | 90 |
| DMI3012-2R2M-N | 2.20 | 20 | 100/ 1V | 0.71(0.77) | 65 | 72 |
| DMI3012-3R3M-N | 3.30 | 20 | 100/ 1V | 1.31(1.50) | 62 | 60 |
| DMI3012-4R7M-N | 4.70 | 20 | 100/ 1V | 1.30(1.43) | 53 | 54 |
| DMI3012-6R8M-N | 6.80 | 20 | 100/ 1V | 1.81(1.97) | 44 | 46 |
| DMI3012-8R2M-N | 8.20 | 20 | 100/ 1V | 2.56(3.00) | 34 | 36 |
| DMI3012-100M-N | 10 | 20 | 100/ 1V | 3.20(3.64) | 32 | 34 |
| DMI3012-150M-N | 15 | 20 | 100/ 1V | 4.25(4.76) | 28 | 28 |
| DMI3012-220M-N | 22 | 20 | 100/ 1V | 6.40(6.83) | 23 | 23 |
| DMI3012-330M-N | 33 | 20 | 100/ 1V | 10.6(11.3) | 18 | 18 |
| DMI3012-470M-N | 47 | 20 | 100/ 1V | 13.5(14.6) | 16.2 | 16 |
| DMI3012-680M-N | 68 | 20 | 100/ 1V | 25.5(27.4) | 11 | 12 |
| DMI3012-101M-N | 100 | 20 | 100/ 1V | 29.5(32.2) | 9 | 11 |
| DMI3012-121M-N | 120 | 20 | 100/ 1V | 34.2(36.5) | 8 | 9 |

Note: When ordering, please specify tolerance code. Tolerance: M= \pm 20%

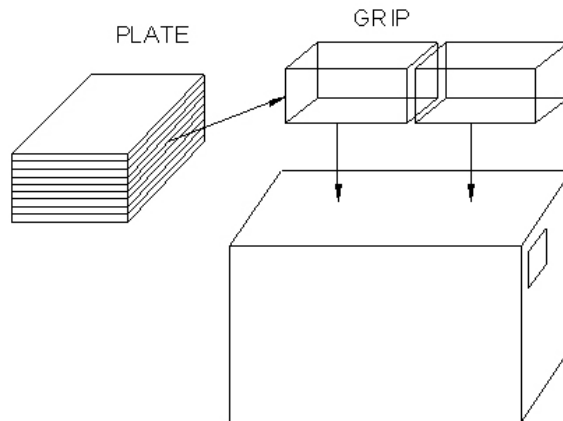
- Customized Specifications are welcome
- Isat for Inductance drop 20% from its value with current
- I rms for a 40 $^{\circ}$ C temperature rise from 25 $^{\circ}$ C ambient with current
- Measure Equipment :
L : WK4237
RDC : CHEN HWA502
Isat & I rms : WK3260B/ 3265

Packaging

PLATE DIMENSIONS



PACKAGING QUANTITY



Dimensions in mm

| TYPE | PLATE DIMENSIONS | | | QUANTITY | | | | |
|----------|------------------|-----|------|----------|-------|------------|------|------|
| | A | B | C | BULK | PLATE | PLATE/GRIP | GRIP | BOX |
| DMI0707 | 250 | 220 | 10 | ✓ | 100 | 10 | 2 | 2000 |
| DMI0805 | 252 | 140 | 11 | ✓ | 140 | 9 | 2 | 2520 |
| DMI0806 | 252 | 14 | 11 | ✓ | 140 | 9 | 2 | 2520 |
| DMI0807 | 250 | 220 | 10 | ✓ | 100 | 10 | 2 | 2000 |
| DMI0808 | 250 | 220 | 10 | ✓ | 100 | 10 | 2 | 2000 |
| DMI0809 | 250 | 220 | 10 | ✓ | 100 | 10 | 2 | 2000 |
| DMI0909 | 250 | 220 | 13.5 | ✓ | 100 | 8 | 2 | 1600 |
| DMI1007 | 230 | 125 | 14.5 | ✓ | 60 | 12 | 2 | 1440 |
| DMI1008 | 250 | 220 | 13.5 | ✓ | 100 | 8 | 8 | 1600 |
| DMI1009 | 251 | 138 | 13.0 | ✓ | 60 | 8 | 2 | 960 |
| DMI10507 | 240 | 135 | 11.5 | ✓ | 60 | 15 | 2 | 1800 |
| DMI10709 | 250 | 220 | 13.5 | ✓ | 100 | 8 | 2 | 1600 |
| DMI1107 | 250 | 220 | 13.5 | ✓ | 100 | 8 | 2 | 1600 |
| DMI1108 | 250 | 220 | 13.5 | ✓ | 100 | 8 | 2 | 1600 |
| DMI1109 | 250 | 220 | 13.5 | ✓ | 100 | 8 | 2 | 1600 |
| DMI1110 | 250 | 220 | 13.5 | ✓ | 100 | 8 | 2 | 1600 |
| DMI1208 | 250 | 220 | 13.5 | ✓ | 100 | 8 | 2 | 1600 |
| DMI1209 | 250 | 220 | 13.5 | ✓ | 100 | 8 | 2 | 1600 |
| DMI1210 | 250 | 220 | 13.5 | ✓ | 100 | 8 | 2 | 1600 |
| DMI1213 | 250 | 220 | 12 | ✓ | 50 | 8 | 2 | 800 |
| DMI3012 | 250 | 220 | 24 | ✓ | 25 | 5 | 2 | 250 |

CPUD Series



CPUD series is designed for low RDC and ultra large current application. Its assembly model magnetic shielded type is suitable for high-density mounting and ultra low buzz noise. Soldering conditions can be easily confirmed when mounting onto the board.

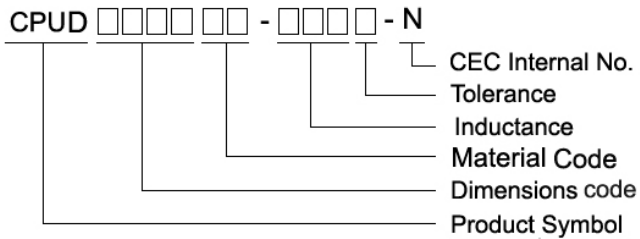
Features

- Excellent for power line DC-DC conversion applications
- Shielded construction
- Low DCR/ μH , in this package series
- Handle high transient current spikes without saturation
- Ultra low buzz noise, due to composite construction

Applications

- Excellent for power line DC-DC conversion applications used in power switching, personal computers and other handheld electronic equipment

Product Identification



Shapes and Dimensions

FIG 1

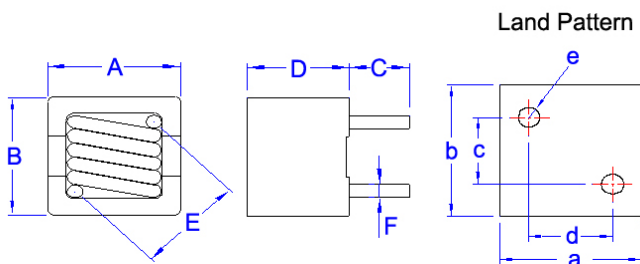
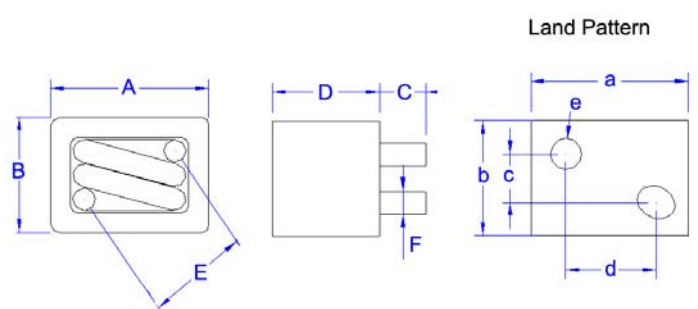


FIG 2



Dimensions in mm

| TYPE | FIG | A | B | C | D | E | F | a | b | c | d | e |
|------------|-----|--------------------|--------------------|---------|-------------------|----------|---------|------|------|---------|---------|---|
| CPUD0806MN | 1 | 8.2 ⁺⁰ | 8.2 ⁺⁰ | 3.5±0.5 | 7.5 ⁺⁰ | 6.5±0.5 | 0.8±0.1 | 9.0 | 9.0 | 4.3±0.5 | 4.9±0.5 | 2 |
| CPUD1108IR | 2 | 11.7 ⁺⁰ | 9.7 ⁺⁰ | 3.5±0.5 | 8.5 ⁺⁰ | 7.8±0.5 | 1.4±0.1 | 12.0 | 10.0 | 4.2±0.5 | 6.6±0.5 | 2 |
| CPUD1310IR | 2 | 13.5 ⁺⁰ | 12.5 ⁺⁰ | 3.5±0.5 | 10 ⁺⁰ | 10.5±0.5 | 1.0±0.1 | 14.2 | 13.2 | 7.0±0.5 | 7.8±0.5 | 2 |

Electrical Characteristics

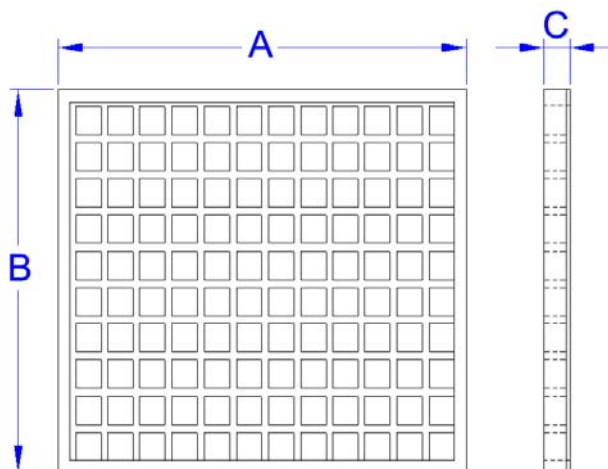
| Part Number | Inductance (μ H) | Tolerance (\pm %) | Test Frequency (kHz) | RDC (m Ω) \pm 8% | Isat (A) Max | Irms (A) Max | Marking |
|-------------------|--------------------------|-------------------------|----------------------------|-------------------------------|-----------------|-----------------|---------|
| CPUD0806MN-R60M-N | 0.6 | 20 | 100 | 2.1 | 24 | 20 | R60 |
| CPUD0806MN-1R0M-N | 1.0 | 20 | 100 | 3.0 | 15 | 18 | 1R0 |
| CPUD0806MN-1R5M-N | 1.5 | 20 | 100 | 4.5 | 11 | 13 | 1R5 |
| CPUD0806MN-2R2M-N | 2.2 | 20 | 100 | 4.5 | 8 | 13 | 2R2 |
| CPUD0806MN-3R3M-N | 3.3 | 20 | 100 | 6.8 | 7 | 11 | 3R3 |
| CPUD0806MN-4R7M-N | 4.7 | 20 | 100 | 12.0 | 5 | 7 | 4R7 |
| CPUD1108IR-R30M-N | 0.30 | 20 | 100 | 0.65 | 50 | 43 | R30 |
| CPUD1108IR-R56M-N | 0.56 | 20 | 100 | 1.00 | 42 | 35 | R56 |
| CPUD1108IR-1R0M-N | 1.0 | 20 | 100 | 2.00 | 50 | 28 | 1R0 |
| CPUD1108IR-1R5M-N | 1.5 | 20 | 100 | 3.65 | 30 | 20 | 1R5 |
| CPUD1108IR-2R0M-N | 2.0 | 20 | 100 | 5.20 | 27 | 15 | 2R0 |
| CPUD1310IR-1R0M-N | 1.0 | 20 | 100 | 1.15 | 42 | 32 | 1R0 |
| CPUD1310IR-1R5M-N | 1.5 | 20 | 100 | 1.85 | 42 | 26 | 1R5 |
| CPUD1310IR-2R0M-N | 2.0 | 20 | 100 | 3.50 | 35 | 21 | 2R0 |
| CPUD1310IR-3R3M-N | 3.3 | 20 | 100 | 5.00 | 22 | 17 | 3R3 |
| CPUD1310IR-4R7M-N | 4.7 | 20 | 100 | 8.60 | 17 | 12 | 4R7 |

Note: When ordering, please specify tolerance code. Tolerance: M= \pm 20%

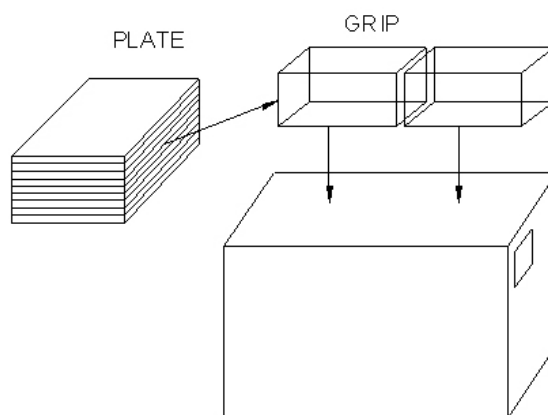
- Customized Specifications are welcome
- Isat for Inductance drop 20% from its value with current
- Irms for a 40 $^{\circ}$ C temperature rise from 25 $^{\circ}$ C ambient with current
- Measure Equipment :
L : WK4237
RDC : CHEN HWA502
Isat & Irms : WK3260B/ 3265

Packaging

PLATE DIMENSIONS



PACKAGING QUANTITY



Dimensions in mm

| TYPE | PLATE DIMENSIONS | | | QUANTITY | | | | |
|------------|------------------|-----|----|----------|-------|------------|------|------|
| | A | B | C | BULK | PLATE | PLATE/GRIP | GRIP | BOX |
| CPUD0806MN | 255 | 210 | 14 | ✓ | 200 | 10 | 2 | 4000 |
| CPUD1108IR | 230 | 150 | 12 | ✓ | 120 | 10 | 2 | 2400 |
| CPUD1310IR | 230 | 150 | 15 | ✓ | 100 | 10 | 2 | 2000 |

Certificate

CERTIFICATE
 Number: 203406-2
 The management system of
Chilisin Electronics Corp.
 No. 29, Lane 301, Tehshing Rd.
 Hosing Village, Hukou Hsing
 ROC-Hsinchu Hsien
 Taiwan

Including the implementation meets the requirements of the standard
ISO 9001:2008

Scope:
 Design, manufacture, sales and distribution of inductors, RF components, sensors, protection devices and magnetic components

Certificate expiry date: 11 August 2014
 Certified for the first time: 7 April 2004
 Certificate effective date: 8 August 2011

DEKRA Certification B.V.

 Mr. J. J. Zuijdam
 Managing Director

Mr. H. J. Beltman
 Certification Manager

© Integral publication of this certificate and adjoining reports is allowed

All testing, inspection, auditing and certification activities of the former KEMA Quality are an integral part of the DEKRA Certification Group.

DEKRA Certification B.V. | Uithoornweg 215, 6827 AR Arnhem P.O. Box 158, 6802 ED Arnhem, The Netherlands
 T +31 26 380 2000 F +31 26 382 9800 www.dekra-certification.com Company registration 0302026

BUREAU VERITAS
 Certification

Certification
 Awarded to
CHILISIN ELECTRONICS CORP.
 奇力新電子股份有限公司

NO. 29, LANE 301, TEH-SHIN ROAD, HOSIN, HUKOU HSHINCHU
 TAIWAN, R.O.C.
 奇力新電子股份有限公司 301 巷 29 號
 奇力新 奇力新

Bureau Veritas Certification certifies that the Management System of the above organization has been audited and found to be in accordance with the requirements of the management system standards detailed below

Standards
ISO 14001:2004

Scope of supply
 DESIGN, MANUFACTURE, SALES AND DISTRIBUTION OF INDUCTORS, FILTERS, RF COMPONENTS, SENSORS, PROTECTION DEVICES, AND MAGNETIC COMPONENTS
 電感、濾波器、磁感元件、保護裝置、RF 元件、磁感元件

Original Approval Date: 14 December 2004

Subject to the standard and conformity requirements of the respective Management System, this certificate is valid until: 13 Dec. 2013
 To check the certificate validity please call +862 2 2670 7655
 Further clarifications regarding the scope of this certificate and the applicability of the management system requirements may be obtained by consulting the organization

Date: 25 May 2010
 Certificate Number: TW15042E

DEKRA Certification B.V. | Uithoornweg 215, 6827 AR Arnhem P.O. Box 158, 6802 ED Arnhem, The Netherlands
 T +31 26 380 2000 F +31 26 382 9800 www.dekra-certification.com Company registration 0302026

CERTIFICATE
ISO/TS 16949:2009

DEKRA
 Certification

hereby certifies that the company
Chilisin Electronics Corp.

Location
 No. 29, Lane 301, Tehshing Rd. Hosing Village, Hukou Hsing * ROC-303 Hsinchu Hsien
Business field:
 Design, manufacture of inductors / filters, RF components, sensors
 protection devices and magnetic components
 for automotive applications

has implemented a quality management system and applies it effectively. Audit report placed in agreement with the requirements of ISO/TS 16949:2009 (2009-09-15). Evidence of conformity was found during the cert. cat on audit Report No. 2084101-2 With 7.3 Product Development

Date of the first certification: 12 08 2008
 This certificate is valid from: 08 08 2011
 This certificate is valid to: 07 08 2014
 Certificate registration no.: 102611082
 IATF number: 0126385

DEKRA Certification GmbH | Heubornstraße 10 | D-70336 Stuttgart | www.dekra-certification.com

SONY

2011 / 08 / 15

Notification of Green Partner Certification

Attn : Chilisin Electronics Corp.

Thank you for your cooperating Sony Green Partner Audit.
 We will inform you of new certified factories and Green Partner validity expiry date.

経銷工場 / Green Partner Certified Factories

| FC | MC Name(ENH) | FC Name(ENG) | Expiry Date |
|----------|---|--------------|-------------|
| FC004116 | Chilisin Electronics Corp. | | 2013/08/31 |
| FC011007 | Dongguan Chilisin Electronics Co., Ltd. | | 2013/08/31 |

Green Partner Secretariat
 Procurement Group
 Sony Corporation

SAMSUNG **Eco-Partner Certificate**

Certificate Number : **68C-6816**
 Certificate Period : **Apr.'11 ~ Apr.'13**

Samsung Electronics hereby certifies that
CHILISIN ELECTRONICS CORP.
 as Eco-Partner Affiliate Company. This company has fulfilled the Samsung Electronics Standards for control of substances with environmental impacts within products, and has established stable environmental quality control system.

Apr.08th, 2011
 Yoon-Woo Lee
 Vice Chairman S.C.E.O

Yoon Woo Lee

Samsung Electronics Co., Ltd.

X-ON Electronics

Largest Supplier of Electrical and Electronic Components

Click to view similar products for [Ferrite Beads](#) category:

Click to view products by [Chilisin](#) manufacturer:

Other Similar products are found below :

[CZB1JGTTD152P](#) [CZB2AFTTD800P](#) [CZB2AGTTD121P](#) [PE-0402FB121ST](#) [AB 3X2X3SM](#) [DER0705-2.2](#) [NCB0603R301TR050F](#)
[NCB0805A320TR050F](#) [NCB-H1206B680TR300F](#) [CZB1JGTTD221P](#) [CZB1JGTTD600P](#) [CZB2AGTTD301P](#) [CZB2BFTTE301P](#)
[CZB2BFTTE601P](#) [4221R-1](#) [EMI0805R-600](#) [SBY100505T-100Y-N](#) [NCB-GH0402D121TR060F](#) [NCB0402P301TR005F](#)
[NCB0603R152TR030F](#) [NCB0805A121TR050F](#) [NCB0805A301TR070F](#) [NCB3312K900TR500F](#) [NCB-H0805A221TR300F](#)
[NCB0402P221TR030F](#) [NCB0805A102TR040F](#) [NCB1806E151TR020F](#) [NCB-H0402P100TR200F](#) [NCB-H0603R121TR300F](#) [NCB-](#)
[H0805A220TR600F](#) [NCB-H1206B601TR200F](#) [CZB1JGTTD202P](#) [CBH160808W221T](#) [WLBD1005HCU330TL](#) [WLBD2012HCU121TH](#)
[WLBD2012HCU221TH](#) [WQBD1608HCU121TH](#) [WLBD1608K2U252TB](#) [VLU0810-102KBC12](#) [WLBD1608K2U800TP](#) [BMB2A0080AN4](#)
[SZ1608F470TF](#) [FBSHC0805-331-302R](#) [HFJ100505T-601Y-N](#) [HFY100505T-221Y-N](#) [PBY201209T-110Y-N](#) [SBY060303T-121Y-N](#)
[BBPY00160808301Y00](#) [SBY100505T-750Y-N](#) [BBPY00100505102Y00](#)