

## Cautions and Warnings

Please be noted that this spec is only for reference if you have projects designed with the product number listed in. If you are looking for new project design-in, please find BPSC Series specification/datasheet on Chilisin website. Or you may find our sales contact for more information on old part number at your convenience. Appreciated your attention and understanding.

**Note:** Please be sure to request approval specifications that provide further details of the products. Kindly note that the content of these specifications are subject to change or may be discontinued without prior notice. This product may not be designed/used in medical or high risk applications without Chilisin approval. Please contact our sales department before ordering.

## SCDS Series

### Features

- RoHS, Halogen Free and REACH Compliance
- Magnetic shielded
- Various package size and wide inductance range

### Applications

- AP Routers
- STBs
- LCD TVs and monitors
- Game consoles
- LED lightings
- DC/DC converters

### Product Identification

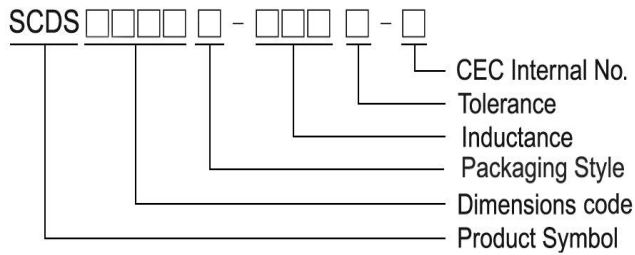

- T : Packaging: Tape and Reel

### SCDS 73/ 74

#### Shape and Dimensions

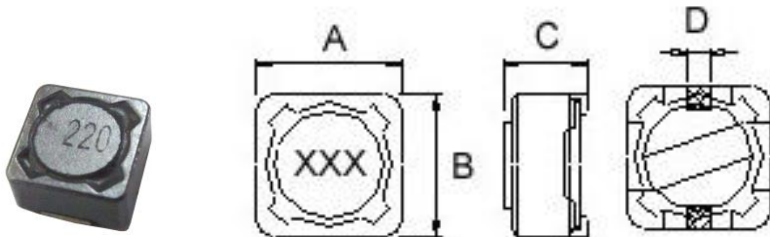

Dimension in mm

TYPE	A	B	C	D
SCDS73	7.3±0.2	7.3±0.2	3.4 <sup>+0</sup>	1.8
SCDS74	7.3±0.2	7.3±0.2	4.5 <sup>+0</sup>	1.8

#### Recommended Pattern

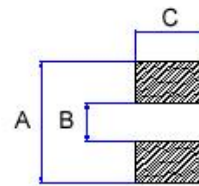

Dimension in mm

TYPE	A	B	C
SCDS73	8.4	4.4	2.2
SCDS74	8.4	4.4	2.2

### SCDS 103R/ 104R/ 105R

#### Shape and Dimensions

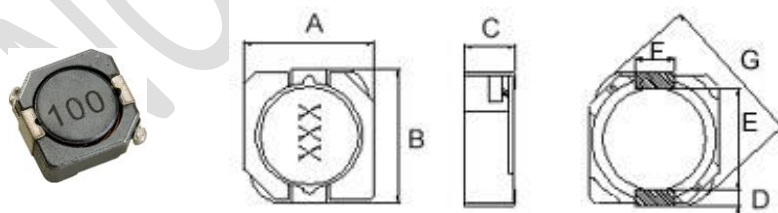

Dimensions in mm

TYPE	A	B	C	D	E	F	G
SCDS103R	10.3 <sup>+0</sup>	10.5 <sup>+0</sup>	3.1 <sup>+0</sup>	1.2	7.7	3.0	13.5 <sup>+0</sup>
SCDS104R	10.3 <sup>+0</sup>	10.5 <sup>+0</sup>	4 <sup>+0</sup>	1.2	7.7	3.0	13.5 <sup>+0</sup>
SCDS105R	10.3 <sup>+0</sup>	10.5 <sup>+0</sup>	5.1 <sup>+0</sup>	1.2	7.7	3.0	13.5 <sup>+0</sup>

#### Recommended Pattern

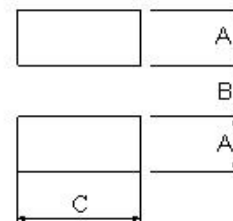

Dimension in mm

TYPE	A	B	C
SCDS103R	1.6	7.3	3.2
SCDS104R	1.6	7.3	3.2
SCDS105R	1.6	7.3	3.2

# SMD Shielded Power Inductors - SCDS Series

SCDS 124/125/127

## Shape and Dimensions

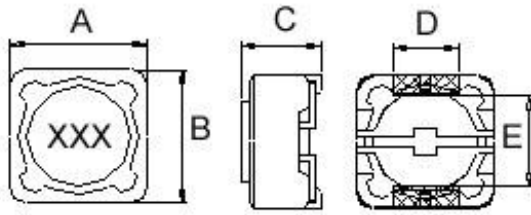

## Recommended Pattern

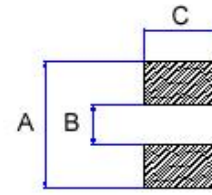

Dimensions in mm

TYPE	A	B	C	D	E
SCDS124	12.5 <sup>+0</sup>	12.5 <sup>+0</sup>	4.5 <sup>+0</sup>	5	7.6
SCDS125	12.5 <sup>+0</sup>	12.5 <sup>+0</sup>	6 <sup>+0</sup>	5	7.6
SCDS127	12.5 <sup>+0</sup>	12.5 <sup>+0</sup>	8 <sup>+0</sup>	5	7.6

Dimensions in mm

TYPE	A	B	C
SCDS124	13	7	5.4
SCDS125	13	7	5.4
SCDS127	13	7	5.4

NOT FOR NEW DESIGN

# SMD Shielded Power Inductors - SCDS Series

## Standard Specifications

Stamp	Inductance (μH)	RDC (mΩ) Max							
		SCDS 73	SCDS 74	SCDS 103R	SCDS 104R	SCDS 105R	SCDS 124	SCDS 125	SCDS 127
R80	0.8					4.3			
1R0	1.0				7.5				
1R2	1.2								7.0
1R5	1.5	30	20		8.1	5.8			8.0
1R8	1.8		25		9.5				
2R2	2.2	30	25		10.5	11			11.5
2R4	2.4								11.5
2R5	2.5				10.5				
2R7	2.7		30						
3R3	3.3	40	35		13	10.4	15	15	13.5
3R5	3.5								13.5
3R8	3.8				13				
3R9	3.9						15		
4R7	4.7		35	30	18	12.3	18	18	15.8
5R2	5.2				22				
5R6	5.6				27				
6R1	6.1								17.6
6R4	6.4							18	
6R8	6.8	60	45	35	27	18	23		20.0
7R0	7.0				27				
7R6	7.6								20.0
8R2	8.2				33	20		25	
100	10	72	49	59	35	26	28	25	21.6
120	12	98	58			33	38	27	24.3
150	15	130	81	91	50	41	50	30	27.0
180	18	140	91		70	46	57	34	39.2
220	22	190	110		73	61	66	36	43.2
270	27	210	150		90	69	80	51	45.9
330	33	240	170	202	93	84	97	57	64.8
390	39	320	230		128	106	132	68	72.9
470	47	360	260	299	128	130	150	75	100
560	56	470	350		213	149	190	110	110
680	68	520	380		213	201	220	120	140
820	82	690	430		280	227	260	140	160
101	100	790	610		304	253	308	160	220
121	120	890	660			303	380	170	250
151	150	1270	880		506	370	530	230	280
181	180	1450	980			419	620	290	350
201	200				756				
221	220	1650	1170		756	500	700	400	390
271	270	2310	1640			672	876	460	560
331	330	2620	1860		1090	812	990	510	640
391	390	2940	2850			953		690	700
471	470	4180	3010		1600	1289		770	980
561	560	4670	3620		2100	1430		860	1070
681	680	5730	4630			1599		1200	1460
821	820	6540	5200			1768		1340	1640
102	1000	9440	6000			1989		1530	1820

**Note:** When ordering, please specify tolerance code. Tolerance: M=±20%, T=±30%, N = <sup>+40</sup>/<sub>-20</sub>%

- Operating temperature range - 40°C ~ 105°C(Including self - temperature rise)
- Isat for Inductance drop 35% from its value without current
- Measure Equipment :  
 L : Agilent/ E4980 or HP4284A (under 1MHz), HP4285A (over 1MHz)  
 RDC : Chroma 16502  
 Rated Current : HP4284+42841A or WK3260B+WK3265B

Please be sure to request approval specifications that provide further details of the products. Kindly note that the content of these specifications are subject to change or may be discontinued without prior notice. This product may not be designed/used in medical or high risk applications without Chilisin approval. Please contact our sales department before ordering.



**CHILISIN ELECTRONICS CORP.**

# SMD Shielded Power Inductors - SCDS Series

## Standard Specifications

Stamp	Inductance (μH)	Isat (A)							
		SCDS 73	SCDS 74	SCDS 103R	SCDS 104R	SCDS 105R	SCDS 124	SCDS 125	SCDS 127
R80	0.8					13.5			
1R0	1.0				11				
1R2	1.2								9.80
1R5	1.5	4.00	5.00		10.	10.5			9.50
1R8	1.8		4.00		8.5				
2R2	2.2	4.00	3.50		7.5	9.25			8.00
2R4	2.4								8.00
2R5	2.5				7.5				
2R7	2.7		3.50						
3R3	3.3	3.70	3.50		6.0	7.8	6.50	8.00	7.50
3R5	3.5								7.50
3R8	3.8				6.0				
3R9	3.9						6.50		
4R7	4.7		3.00	4.65	5.7	6.40	5.70	7.60	6.80
5R2	5.2				5.5				
5R6	5.6				5.0				
6R1	6.1								6.60
6R4	6.4							5.8	
6R8	6.8	2.00	2.50	3.84	5.0	5.40	4.90		6.20
7R0	7.0				4.8				
7R6	7.6								5.90
8R2	8.2				4.5	4.85		5.00	
100	10	1.68	1.84	3.18	4.4	4.45	4.50	4.00	5.40
120	12	1.52	1.71			4.00	4.00	3.50	4.90
150	15	1.33	1.47	2.60	3.6	3.60	3.20	3.30	4.50
180	18	1.20	1.31		3.5	3.20	3.10	3.00	3.90
220	22	1.07	1.23		2.9	2.95	2.90	2.80	3.60
270	27	0.96	1.12		2.5	2.70	2.80	2.30	3.40
330	33	0.91	0.96	1.74	2.3	2.50	2.70	2.10	3.00
390	39	0.77	0.91		2.1	2.30	2.10	2.00	2.75
470	47	0.76	0.88	1.43	2.1	2.00	1.90	1.80	2.50
560	56	0.68	0.75		1.6	1.90	1.80	1.70	2.35
680	68	0.61	0.69		1.5	1.65	1.50	1.50	2.10
820	82	0.57	0.61		1.35	1.50	1.30	1.40	1.95
101	100	0.50	0.60		1.35	1.35	1.20	1.30	1.70
121	120	0.49	0.52			1.28	1.10	1.10	1.60
151	150	0.43	0.46		1.15	1.12	0.95	1.00	1.42
181	180	0.39	0.42			1.04	0.85	0.90	1.30
201	200				0.92				
221	220	0.35	0.36		0.92	0.94	0.80	0.80	1.16
271	270	0.32	0.34			0.84	0.60	0.75	1.06
331	330	0.28	0.32		0.70	0.75	0.50	0.68	0.95
391	390	0.26	0.29			0.70		0.65	0.88
471	470	0.24	0.26		0.50	0.60		0.58	0.79
561	560	0.22	0.23		0.40	0.54		0.54	0.73
681	680	0.19	0.22			0.52		0.48	0.67
821	820	0.18	0.20			0.50		0.43	0.60
102	1000	0.16	0.18			0.48		0.40	0.55

### Tolerance Of Inductors

- SCDS 73            1.5 ~ 1000uH ± 20%
- SCDS 74            1.5 ~ 1000uH ± 20%
- SCDS 103R        4.7~47uH ± 30%
- SCDS 104R        1.0 ~ 470uH ± 30%
- SCDS 105R        0.8 ~ 1000uH ± 30%
- Tolerance : M = ±20% , T = ±30% , N = <sup>+40</sup>/<sub>-20</sub>%
- SCDS 124            3.3 ~ 330uH ±20%
- SCDS 125            3.3 ~ 1000uH ± 20%
- SCDS 127            1.2 ~ 7.6uH <sup>+40</sup>/<sub>-20</sub>%
- SCDS 127            10 ~ 1000uH ± 20%

Please be sure to request approval specifications that provide further details of the products. Kindly note that the content of these specifications are subject to change or may be discontinued without prior notice. This product may not be designed/used in medical or high risk applications without Chilisin approval. Please contact our sales department before ordering.



**CHILISIN ELECTRONICS CORP.**

# SMD Shielded Power Inductors - SCDS Series

## Curves of SCDS Series

Test Instruments : HP4294 Impedance / Material Analyzer

SCDS73

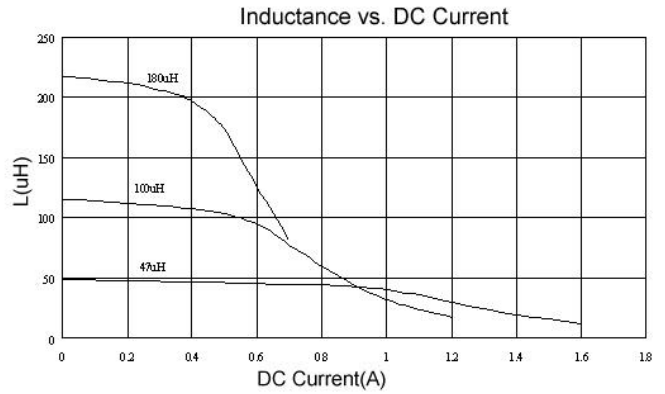
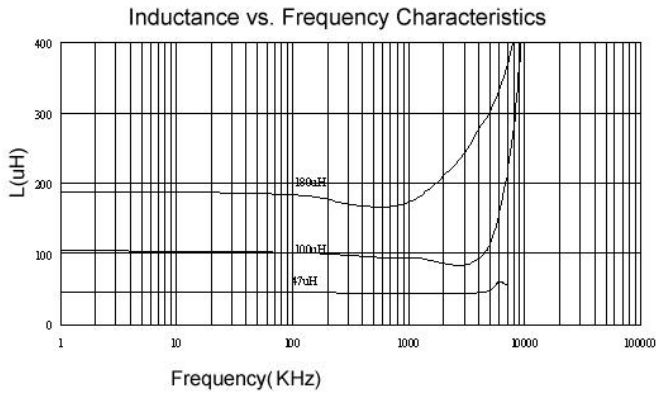

SCDS74

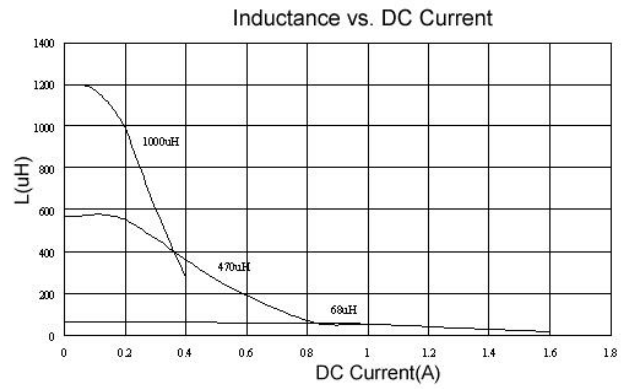
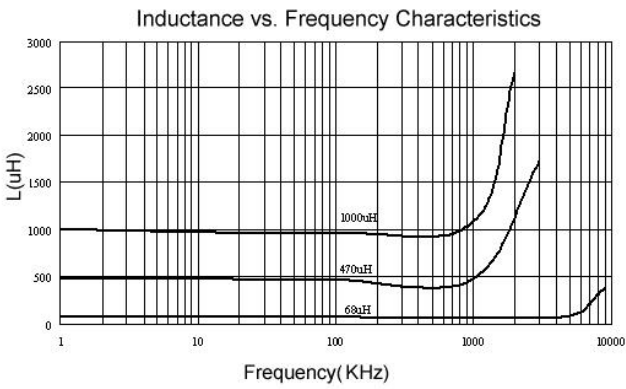

Test Instruments : HP4294 Impedance / Material Analyzer

SCDS104R

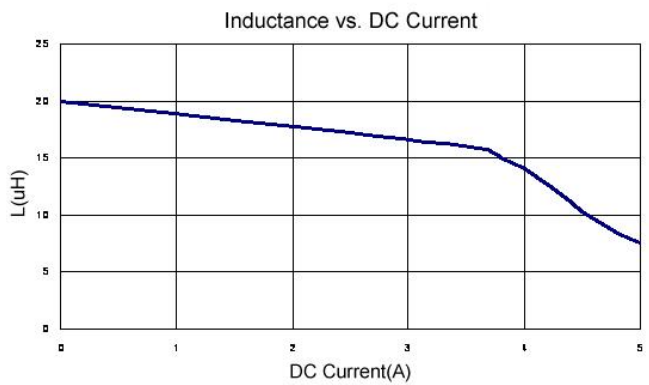
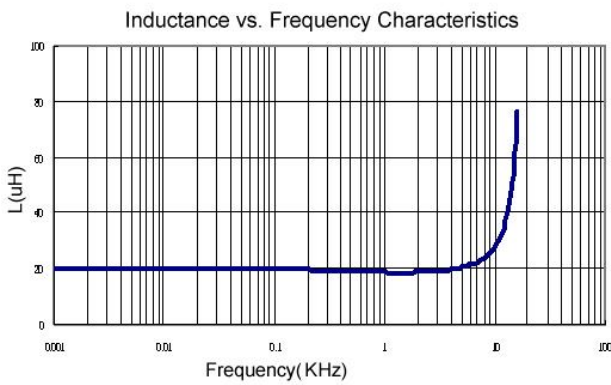

SCDS124

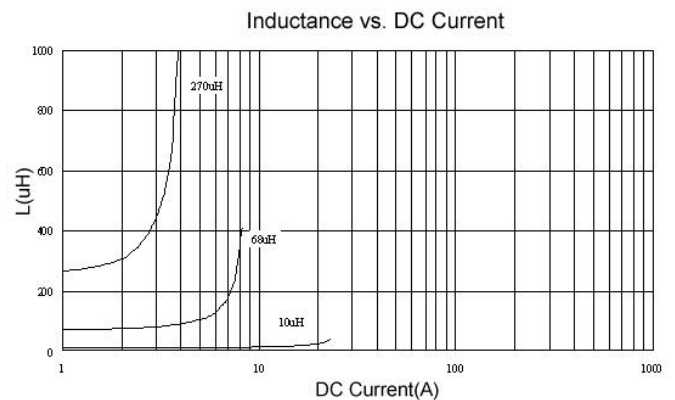
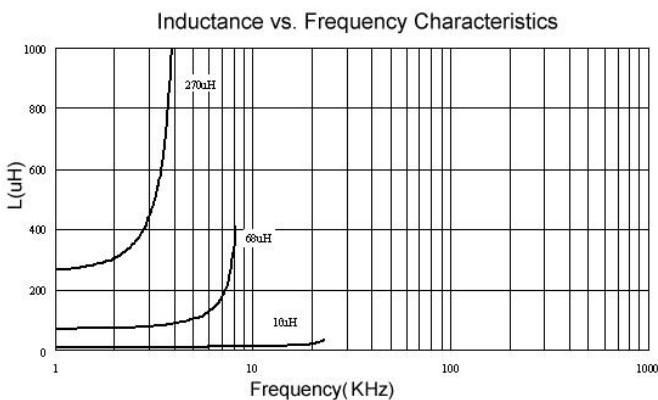

Please be sure to request approval specifications that provide further details of the products. Kindly note that the content of these specifications are subject to change or may be discontinued without prior notice. This product may not be designed/used in medical or high risk applications without Chilisin approval. Please contact our sales department before ordering.

# SMD Shielded Power Inductors - SCDS Series

## SCDS125

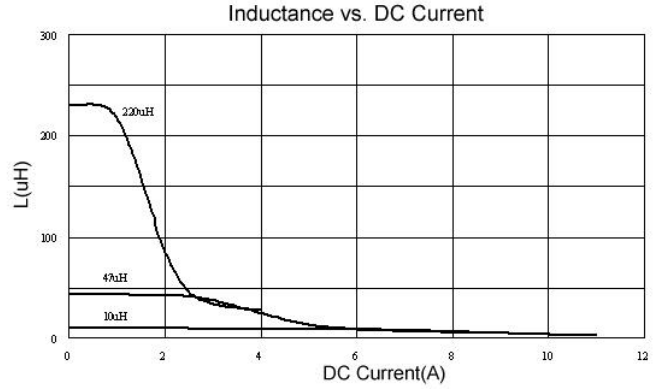
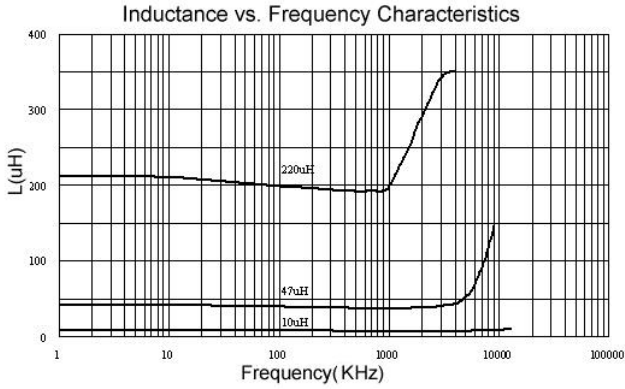

## SCDS127

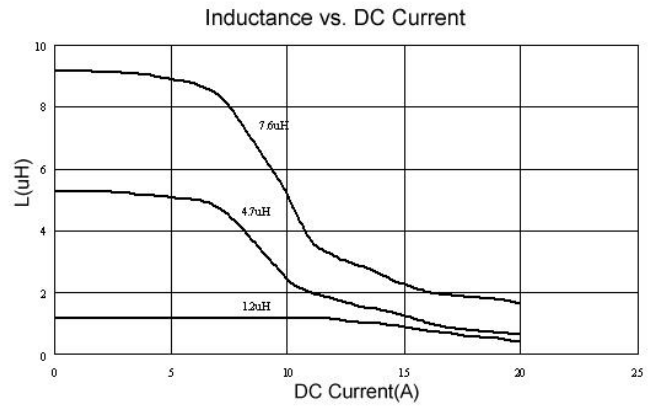
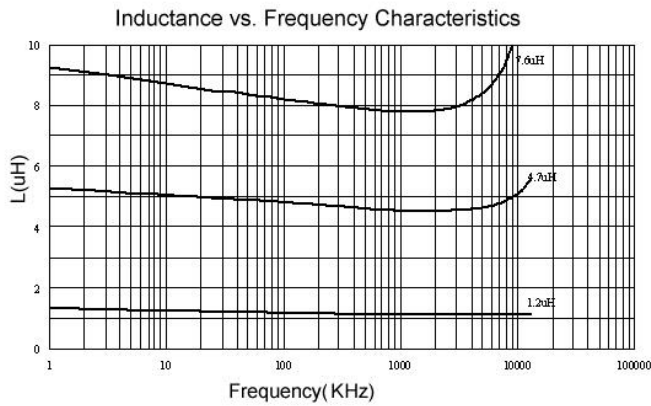

# SMD Shielded Power Inductors - SCDS Series

## Packaging Specifications

Tape Dimensions

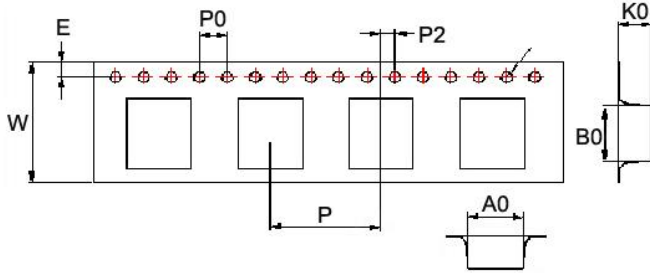

Tape Material

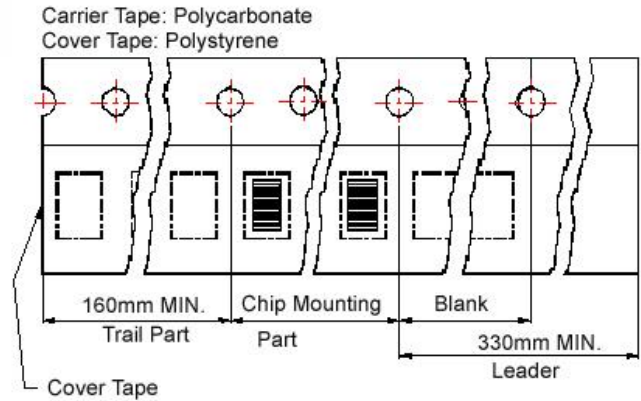

Reel Dimensions

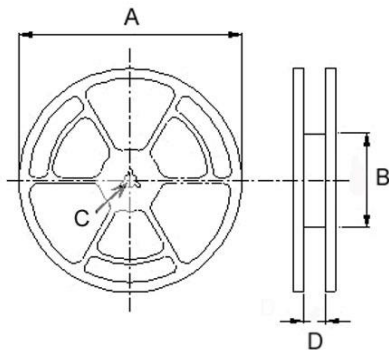

Dimensions in mm

TYPE	Tape Dimensions									Reel Dimensions				Quantity PCS / REEL
	A0	B0	K0	D	E	W	P	P0	P2	A	B	C	D	
SCDS 73	7.6	7.6	3.6	1.55	1.75	16	12	4	2	330	100	13	16.0	1600
SCDS 74	7.6	7.6	5.0	1.55	1.75	16	12	4	2	330	100	13	16.0	1000
SCDS 103R	10.6	10.75	4.2	1.55	1.75	24	16	4	2	300	100	13	24.4	1000
SCDS 104R	10.6	10.75	4.2	1.5	1.75	24	16	4	2	330	100	13	24.4	1000
SCDS 105R	10.6	10.6	5.0	1.5	1.75	24	16	4	2	330	100	13	24.4	500
SCDS 124	13.0	12.8	5.1	1.55	1.75	24	16	4	2	330	100	13	24.4	500
SCDS 125	12.6	12.6	6.7	1.55	1.75	24	16	4	2	330	100	13	24.4	600
SCDS 127	12.6	12.6	8.7	1.55	1.75	24	16	4	2	330	100	13	24.4	500



## X-ON Electronics

Largest Supplier of Electrical and Electronic Components

*Click to view similar products for [Fixed Inductors](#) category:*

*Click to view products by [Chilisin](#) manufacturer:*

Other Similar products are found below :

[CR32NP-100KC](#) [CR32NP-151KC](#) [CR32NP-180KC](#) [CR32NP-181KC](#) [CR32NP-1R5MC](#) [CR32NP-390KC](#) [CR32NP-3R9MC](#) [CR32NP-680KC](#) [CR32NP-820KC](#) [CR32NP-8R2MC](#) [CR43NP-390KC](#) [CR43NP-560KC](#) [CR43NP-680KC](#) [CR54NP-181KC](#) [CR54NP-470LC](#) [CR54NP-820KC](#) [CR54NP-8R5MC](#) [70F224AI](#) [MGDQ4-00004-P](#) [MHL1ECTTP18NJ](#) [MHQ1005P10NJ](#) [MHQ1005P1N0S](#) [MHQ1005P2N4S](#) [MHQ1005P3N6S](#) [MHQ1005P5N1S](#) [MHQ1005P8N2J](#) [PE-51506NL](#) [PE-53601NL](#) [PE-53602NL](#) [PE-53630NL](#) [PE-53824SNLT](#) [PE-92100NL](#) [PG0434.801NLT](#) [PG0936.113NLT](#) [9220-20](#) [9310-16](#) [PM06-2N7](#) [PM06-39NJ](#) [A01TK](#) [1206CS-471XJ](#) [HC2LP-R47-R](#) [HC2-R47-R](#) [HC3-2R2-R](#) [HCF1305-3R3-R](#) [1206CS-151XG](#) [RCH664NP-140L](#) [RCH664NP-4R7M](#) [RCH8011NP-221L](#) [RCP1317NP-332L](#) [RCP1317NP-391L](#)